

STUDY OF THE EFFECT OF ALIGNMENT VARIATIONS
ON THE KINEMATICS OF AMPUTEE'S GAIT

by

Minoo Dabestani

A thesis submitted to the
UNIVERSITY OF STRATHCLYDE
Bioengineering Unit, Wolfson Centre,
Glasgow

for the degree of M.Sc.

MAY 1984

CONTENTS

	<u>Page</u>
Acknowledgements	-IV-
Abstract	- V -
<u>Chapter 1</u> <u>Introduction</u>	-1-
<u>Chapter 2</u> <u>Lower Limb Prosthetics</u>	-6-
2.1 Introduction	
2.2 Amputation and Prosthetic Fittings	
2.2.1 Below-knee Amputation	
2.2.2 Above-knee Amputation	
2.3 Modular Assembly Protheses	
<u>Chapter 3</u> <u>Review of Kinematic Studies</u> <u>Related to Amputee Gait</u>	-19-
3.1 Introduction	
3.2 Kinematic Measurements	
3.3 Goniometry	
3.4 Optoelectric Techniques	
3.4.1 The TV/Computer System	
3.4.2 The Selspot System	
3.4.3 The CODA System	
3.5 Cinematography	
3.6 Characteristics of Normal Gait	
3.6.1 The Gait Cycle	
3.6.2 Biomechanics of Normal Gait	
3.7 Kinematics of Pathological Gait	
3.8 Energy Cost of Walking	

	<u>Page</u>
<u>Chapter 4</u> <u>Alignment of Lower Limb Prostheses</u>	-39-
4.1 Introduction	
4.2 Definition of Alignment	
4.3 Bench Alignment	
4.4 Dynamic Alignment	
4.4.1 Gait Deviations	
4.5 Measurement of Alignment	
<u>Chapter 5</u> <u>Methodology</u>	-52-
5.1 Introduction	
5.2 Patient Profiles	
5.3 Prosthetist Profile	
5.4 Prostheses	
5.5 Experimental Set-up	
5.6 Marker Positioning	
5.7 Test Procedure	
5.8 Digitization	
5.9 Data Reduction and Preparation	
5.9.1 The Program Flow Chart	
5.9.2 Calculation of the Coordinates of the Markers, Program: "COORDINATE"	
5.9.3 Calibration program: "CALIBRATION"	
5.9.4 Parallax Correction, Program: "PARALLAX"	
5.9.5 Digital Filtering of Data, Program: "FILTER"	
5.9.6 Calculation of Coordinates of Joint Centres, Program: "JOINTS"	

5.9.7 Program: "ANGLES"

5.10 Correction for Phase Difference

Chapter 6 Results and Discussion -72-

6.1 Introduction

6.2 Repeatability of the Kinematic and
Temporal Parameters

6.3 Experimental Accuracy

6.4 Effect of Various Acceptable
Alignments on Amputee Gait Pattern

6.5 Effect of Various Controlled mal-
alignments on Amputee Gait Pattern

6.6 Effect of Various Speeds of Walking
on Amputee Gait Pattern

6.7 Assessment of Various Optimum
Alignments

6.7.1 Below-knee Amputee

6.7.2 Above-knee Amputee

Chapter 7 Conclusion -112-

7.1 Conclusion

7.2 Future Work

Bibliography -116-

Acknowledgements

I wish to express my sincere thanks and gratitude to Professor J.P. Paul, for his assistance, understanding and patience throughout the course of this project without which this work would have been impossible.

I would also like to extend many thanks to my supervisor Mr S.E. Solomonidis for his collaboration and constructive criticisms.

I feel greatly indebted to Mr W.D. Spence for many hours of discussion which pointed out errors, either of fact or presentation, during the preparation of this thesis.

My gratitude is also due to Mr M.S. Zahedi for his instruction, assistance and useful detailed feed-back.

My appreciation is further extended to Dr J. Goh, staff of the Bioengineering Unit and Mrs Nita Hearn .(for typing the thesis).

Finally I would like to sincerely thank my parents who have supported me in every possible way throughout my life.

Abstract

Alignment of a prosthesis is defined as the position of the socket relative to the foot and any other intermediate components. During dynamic alignment the prosthetist, using subjective judgment and feed-back from the patient, aims to achieve the most suitable limb configuration for the best function and comfort.

Until recently it was generally believed that a given patient could only be satisfied with a unique "optimum" alignment. Previous work carried out at the Bioengineering Unit, University of Strathclyde showed that several alignment configurations can be made to be equally acceptable to both the amputee and the prosthetist. The purpose of this study reported in this thesis was to investigate the effect of alignment variation on amputee gait.

Ten active below-knee and above-knee amputees were dynamically aligned by three prosthetists several times. Markers were positioned on the defined locations on the prosthetic and sound side, and the body. Kinematic data were acquired using three cine cameras orthogonally arranged.

Using a computer program from the acquired data stick diagrams, angle-time diagrams, angle-angle diagrams and temporal parameters were derived. Analysis of the results showed that various alignment configurations that were acceptable to the patient and the prosthetist resulted in appreciable variations in the gait patterns.

CHAPTER 1

INTRODUCTION

Rehabilitation of the amputee requires the prosthesis to be acceptable to the patient. There are several factors that determine the acceptability of the prosthesis, such as: cosmesis, mass properties of the prosthesis, comfort and function.

Research during the 1950s on gait analysis and rehabilitation of the disabled underwent major advancements. Introduction of new measurement techniques and further developments in the understanding of the biomechanics of walking initiated a new era of studies in human locomotion. Attempts to quantify several parameters of amputee locomotion in order to study gait patterns were reported by several groups, notably UCB (1947) and Murray et al. (1964).

Radcliffe (1955) and Radcliffe and Foort (1961) reported on the quadrilateral total contact socket for above-knee (AK) prostheses and the patellar tendon bearing (PTB) for below-knee (BK) prostheses respectively. These developments are considered as major advancements in the rehabilitation of the lower limb amputee.

The introduction of the modular assembly prostheses (MAP) in the 1970s allowed quicker delivery of limbs to patients, adjustability in alignment and interchangeability of components which made the rehabilitation process easier. An extensive evaluation programme of various modular assembly prostheses was undertaken at the University of Strathclyde (Solomonidis, 1975 and 1980). The evaluation

included several below and above-knee systems and reported on their clinical and constructional suitability. The work incorporated a study of the requirements for alignment in the lower limb prostheses and described original methods of alignment measurement. It was found that a patient was able to walk on a prosthesis aligned in various configurations. These findings prompted the initiation of a more detailed "Study of Alignment at the University of Strathclyde". The study which commenced in 1979 attempts to establish trends or interrelationships between the alignment configuration and various kinematic and kinetic parameters of gait.

The objectives of the work described in this thesis are to investigate the variations in the gait patterns and the temporal parameters as a function of varying alignment.

Chapter 2 of this thesis reviews the lower limb prostheses, and describes prosthetic fitting and modular assembly prostheses.

Chapter 3 presents a review of kinematic studies on the amputee's gait and the methods of measurement of the kinematic parameters.

Chapter 4 deals with the definition of alignment.

and the procedures for bench and dynamic alignment of below and above-knee prostheses. The gait deviations of below and above-knee amputees and their relation to alignment are reviewed.

Chapter 5 describes the methodology used for the collection of the data and the work carried out for further analysis. The description includes the cine photographic system, the marker positions and the digitization of the films which involved the creation of an input file for the running of the program. It further describes the method for data reduction using the provided software (Goh, 1982), and the steps used for the calculation of coordinates and calibration; correction for phase difference and filtering of data; calculations at joint centres; measurements of angles; plotting the stick diagrams and angle diagrams. Other facilities are briefly described.

The results section (Chapter 6) describes the experimental errors of the measurement technique. The repeatability of the results for comparison purposes are outlined. The effect of various optimum alignments on selected kinematic parameters and temporal parameters is shown. Similarly the effect of controlled mal-alignments are discussed. Finally, an attempt has been made to assess and optimise some parameters and select an optimum alignment from the range of acceptable alignments using the kinematic data available.

Finally, Chapter 7 states the conclusions arrived at from this work.

CHAPTER 2

LOWER LIMB PROSTHETICS

- 2.1 Introduction.
- 2.2 Amputation and Prosthetic Fittings.
 - 2.2.1 Below-Knee Amputation.
 - 2.2.2 Above-Knee Amputation.
- 2.3 Modular Assembly Prostheses.

2.1 INTRODUCTION

Physical disabilities from many sources have provided the impetus to search for the ideal body component replacement. The recognition of the problem of the amputee together with successful rehabilitation and reconstruction should result in an acceptable prosthesis to the patient in which comfort and function are of prime significance.

The major function of the lower limb is to support and transport the body. To substitute for a missing limb, the prosthesis is required to provide support and stability by voluntary control. The latter refers to the maintenance of erect posture without discomfort and/or without the patient having to compensate by means of the sound limb. The design of a lower limb prosthesis involves many basic functional specifications, such as the geometric and inertial properties of the prosthesis, type of joint mechanism and components used. A review of lower limb prostheses and prosthetic fittings is presented in this chapter.

2.2 AMPUTATION AND PROSTHETIC FITTINGS

Biomechanics of lower limb prostheses refers to the study of the dynamic forces which affect the comfort, stability and gait characteristics of an amputee, walking with an artificial leg. A knowledge of the nature and relative magnitudes of these forces is a necessary prerequisite to the fitting and alignment of the lower

extremity amputee at all levels of amputation. The procedure of prosthetic fitting for an amputee is firstly, to fit the socket accurately and comfortably around the stump, so as to form an effective connection between the patient and the prosthesis. Secondly, the components of the prosthesis must be assembled so as to ensure a functional and stable device. Finally, the alignment and adjustment of the prosthesis must be carried out in order to provide a maximum restoration of function with maximum gait deviation, in both the stance and swing phases of the walking cycle.

2.2.1 BELOW-KNEE (B-K) AMPUTATION

The aim in providing a prosthesis for the B-K amputee is to make the fullest use of the knee joint which is most often functionally unaffected by the surgical procedure. This in turn means that the most effective use must be made of the stump as a weight bearing and dynamic load transmitting mechanism.

In prosthetic practice, the patellar tendon bearing (PTB), is the accepted fitting for B-K amputation. A satisfactory PTB prosthesis can be fitted to stumps containing no more than about 12cm of tibia.

The basic concept of the design of PTB socket is the compression of soft tissues to obtain good socket fit with minimal movement of the prosthesis relative to the skeletal

system and comfortable transmission of force actions during the gait. The former is particularly essential to obtain a degree of feedback of the foot position in the absence of the proprioceptive feedback. This infers a socket shape which will initially compress the soft tissues in the areas required to bear the highest loads. It is, however, not possible to compress all parts of the stump, since some parts are sensitive to pain or intolerant of pressure (Murdoch 1969). Figure (2.2.1.1) shows the general pattern of the stump identifying these areas.

The shape of the socket is such that a substantial amount of weight is borne on the patellar tendon and medial flare of the tibial condyle. The medial and lateral walls are in total contact throughout, except for the peroneal nerve relief at the fibular head and the terminal fibular relief on the lateral wall, Figure (2.2.1.2). These walls form the major stabilising areas; the medial wall more so than the lateral by virtue of its close contour beneath the medial tibial flare, and as such it also forms a weight bearing area, which serves to relieve some pressure from the patellar tendon.

The posterior wall contains the popliteal gastrocnemius bulge and forces the stump anteriorly to maintain the patellar tendon on the patellar shelf, Figure (2.2.1.3). The posterior brim is flared out to allow for maximum motion of the knee joint without impinging on the hamstring tendons, Figure (2.2.1.4), (Mital and Pierce 1971).

PRESSURE TOLERANT AREAS

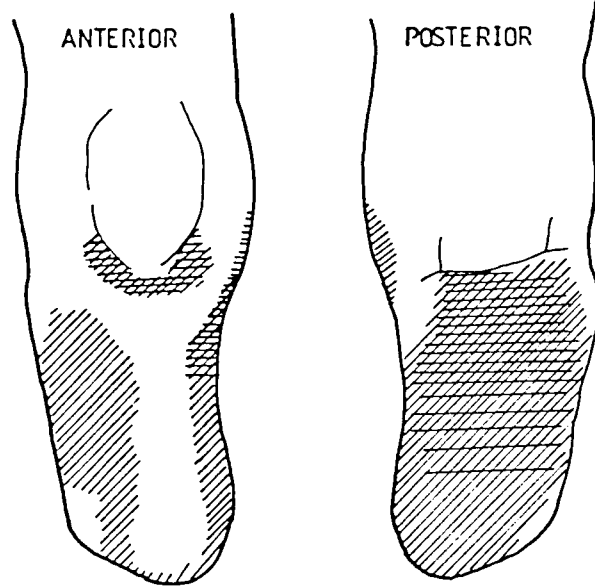

SENSITIVE AREAS

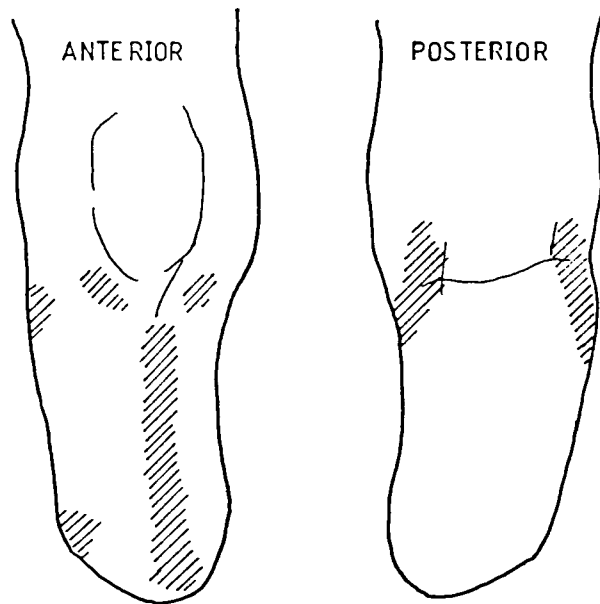

Figure 2.2.1.1 Below-knee Stump

(Redrawn from Murdoch 1969)

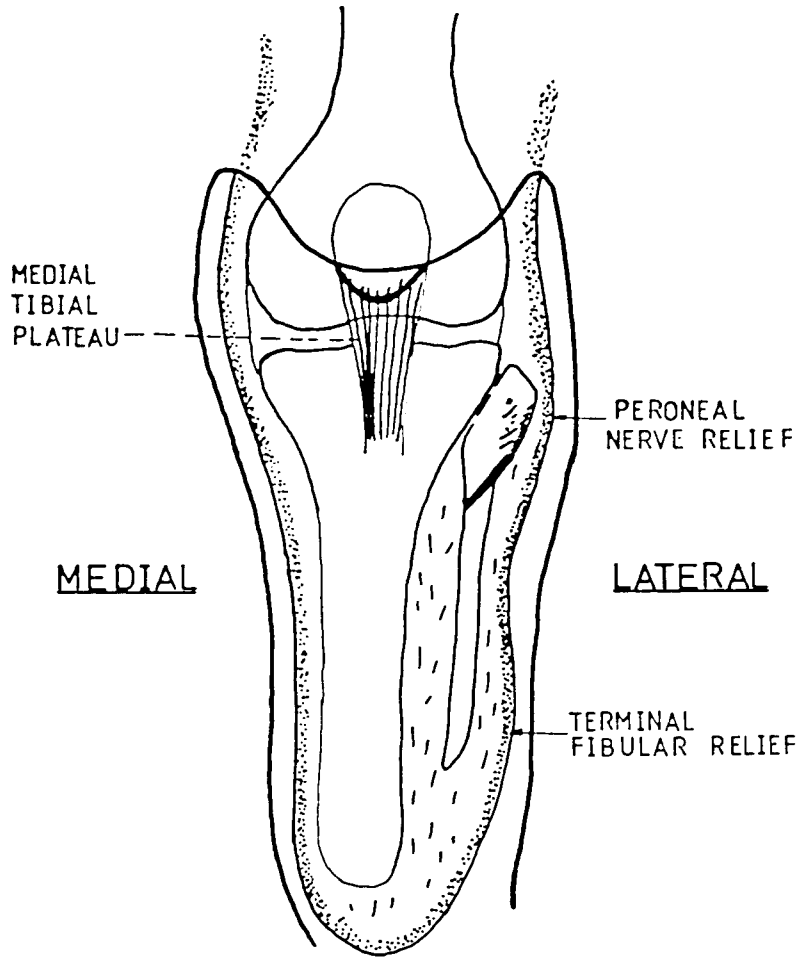

Figure 2.2.1.2 Patellar tendon-bearing Socket

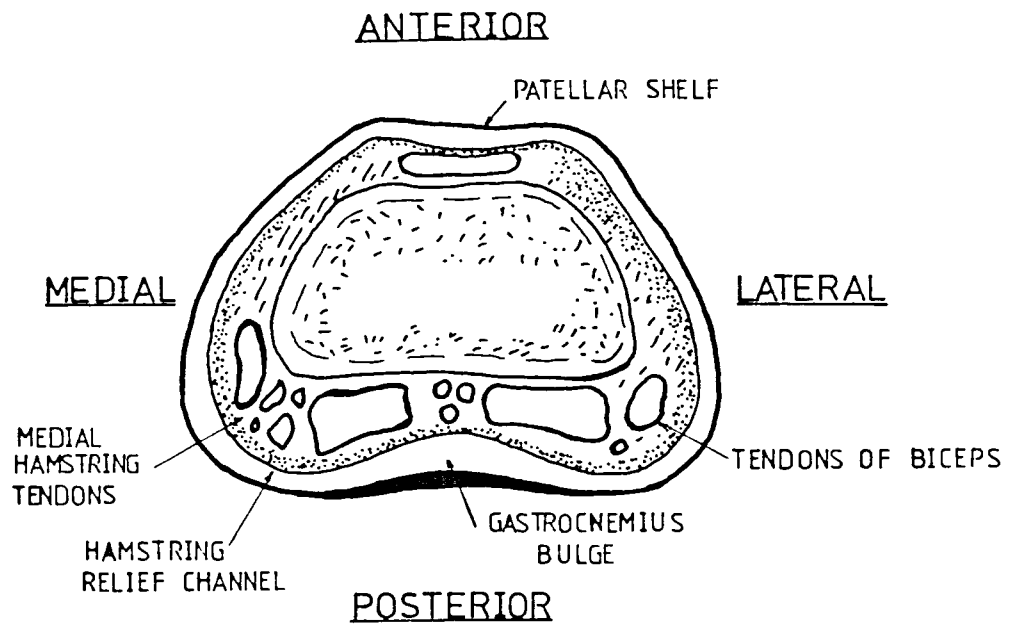

Figure 2.2.1.3 Cross Section Through Stump in Patellar Tendon-Bearing Socket at the Level of Patellar Shelf.

(Redrawn from Mital and Pierce 1971)

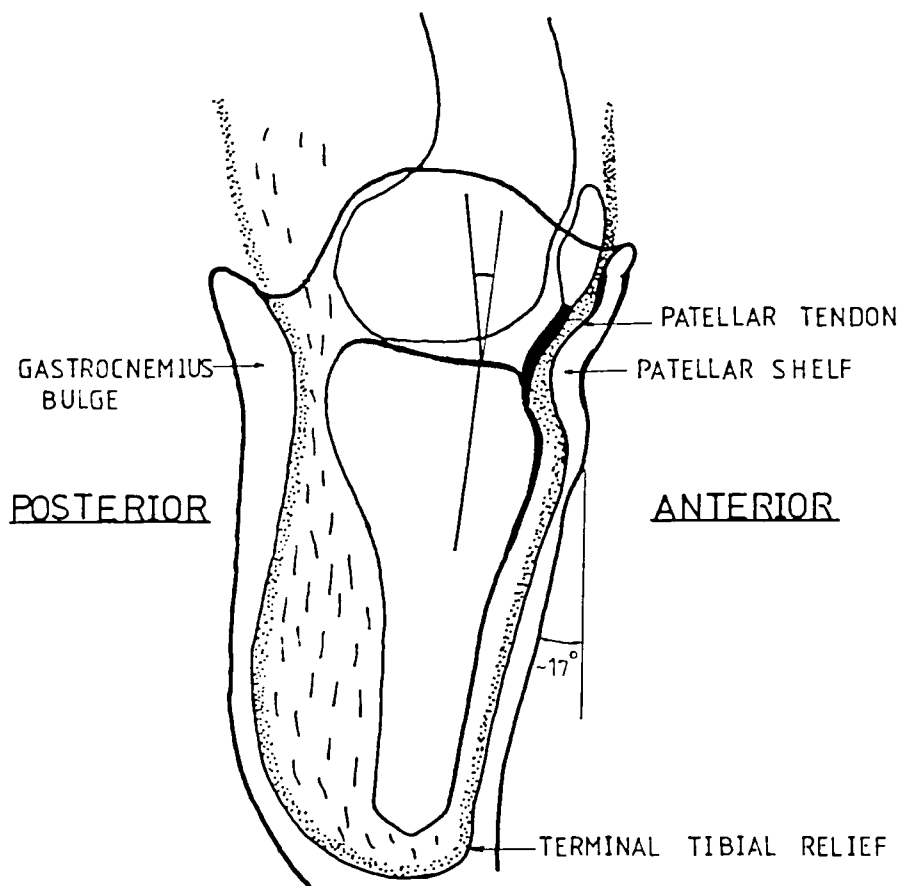

Figure 2.2.1.4 Patellar Tendon-bearing Socket

(Redrawn from Mital and Pierce 1971)

However, the soft tissues between these tendons can tolerate a "fair" amount of distortion. Figure (2.2.1.5(a)) shows the forces exerted by the socket on a below-knee amputee, and Figure (2.2.1.5(b)) the corresponding forces on the prosthesis during the stance phase of walking in the mediolateral plane. Figure (2.2.1.6) shows the antero-posterior force diagram of the below-knee amputee during three stages of the stance phase: a) Heel strike, b) Shock absorption and c) Push off (Murdoch 1969).

Most sockets have a soft insert usually made from polythene "PE lite", which is contoured exactly to the shape of the socket. The "PE lite" liner is used to protect the stump against the hard surface of the socket, although it is believed that an "accurately" made hard socket, i.e. without a liner, provides the best result.

The prosthesis may be harnessed to the stump in different ways, the most common technique is to use a supracondylar cuff suspension, although certain types of supracondylar wedge suspensions are becoming popular.

The socket is usually attached on a wooden block and joined to the artificial foot using a metal or wooden shank. The prosthetic foot may be either of the Uniaxial or SACH type.

2.2.2 ABOVE-KNEE (AK) AMPUTATION

The AK stump should be as long as possible in order

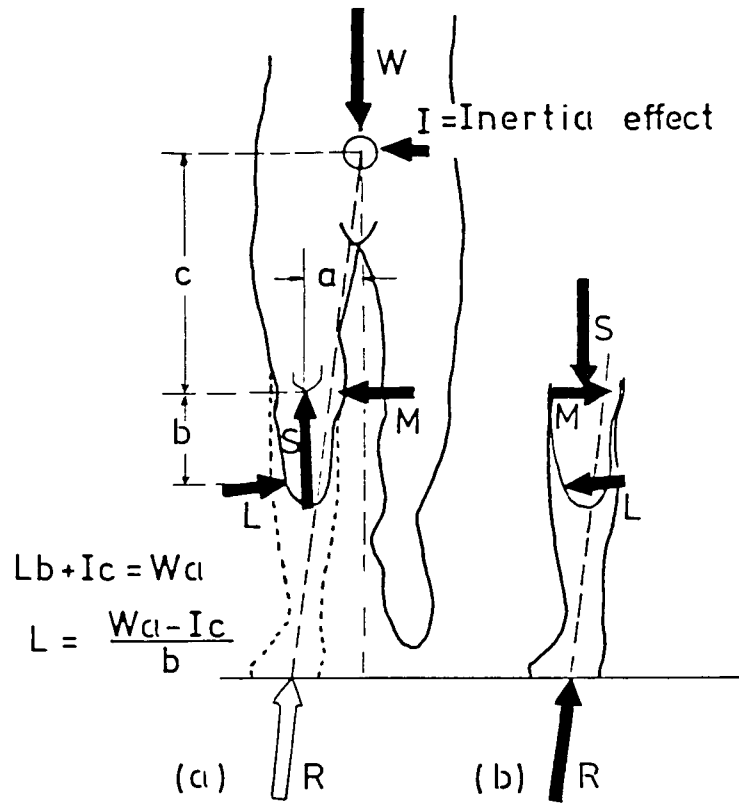

Figure 2.2.1.5 Mediolateral Force Diagram, PTB prosthesis.

(a) Forces on the amputee.

(b) Forces on the prosthesis.

(Redrawn from Murdoch 1969)

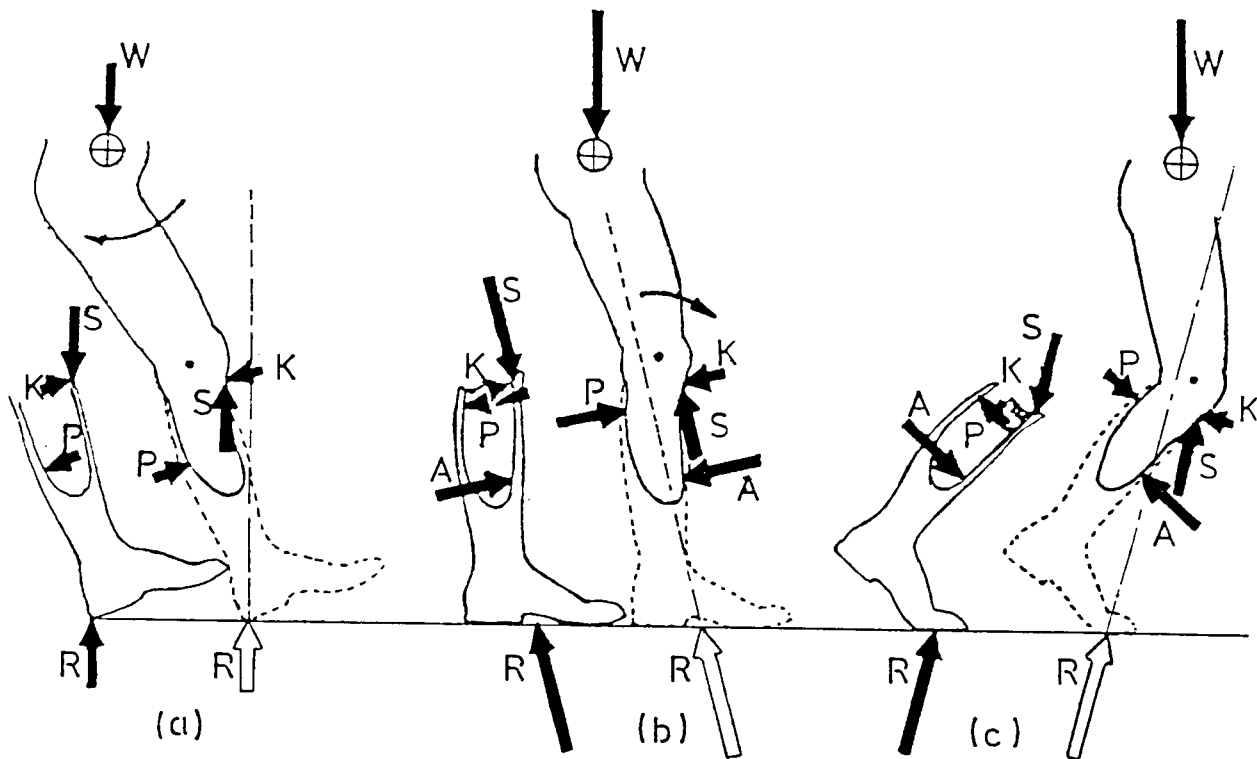

Figure 2.2.1.6 Anteroposterior Force Diagram, PTB Prosthesis.

- (a) Heel Contact.
- (b) Shock absorption.
- (c) Push Off.

(Redrawn from Murdoch 1969)

to provide a long lever for controlling the knee joint. However, adequate distance for a knee mechanism must be provided; about 12 cm from the knee axis to the end of the stump.

The socket must transmit in a comfortable manner, static and dynamic body weight to the remaining part of the prosthesis; and it must be shaped to provide stabilization at the stump within the socket so as to enable the amputee to transfer his own movements into functional prosthetic movements.

There are basically three types of AK sockets currently being used: the open-ended suction socket, the total contact suction socket and the socket with auxiliary suspension. Because the cut end at the femur end at the distal end of the stump is unsuitable for load bearing, other areas such as the ischial tuberosity and the origins of the hamstrings have to be used. The amputee sits on the posterior brim of the socket which is kept flat and horizontal from the posterior-medial to the posterior-lateral corner. As the contact between the ischial tuberosity and the posterior socket brim is obtained by forcing the brim onto and under the tuberosity, the socket must be designed to provide posteriorly directed counter pressure. This, however, could cause a region of high pressure around the proximal part of the stump which may encourage the formation of oedema or ulceration. This difficulty has been overcome by the use of the total-contact

suction socket which supports all the soft tissues. Although many socket designs are available for the AK amputee, the only one that has proved to be most effective is the quadrilateral total-contact suction socket, see Figure (2.2.2.1). However, the suction socket can only be used by active, healthy amputees as considerable effort is required when donning the prosthesis.

The inner contour of the quadrilateral socket has reliefs and bulges. The former are hollowed out areas to reduce pressure on firm tissues, such as tendon and contracting muscles. Bulges are inwardly directed contours of the socket wall to press on pressure-tolerant areas of the stump, so that these areas will take higher pressure and thereby their appropriate share of the load. Extending from this posterior wall of the socket is a widely flared area to provide support through the ischial tuberosity and gluteal muscles. The anterior wall is concavely contoured and is higher than the posterior wall in order to provide the counter force that will hold the ischium back onto the ischial seat, Figure (2.2.2.2). The lateral wall is abducted and relatively flat to evenly distribute the high forces resulting from hip abduction during mid-stance to provide lateral stabilization and prevent migration of the femur, Figure (2.2.2.3).

The distal part of the socket is in close contact with the surface of the distal end of the stump and provides some support. The distal support is, however, sufficient

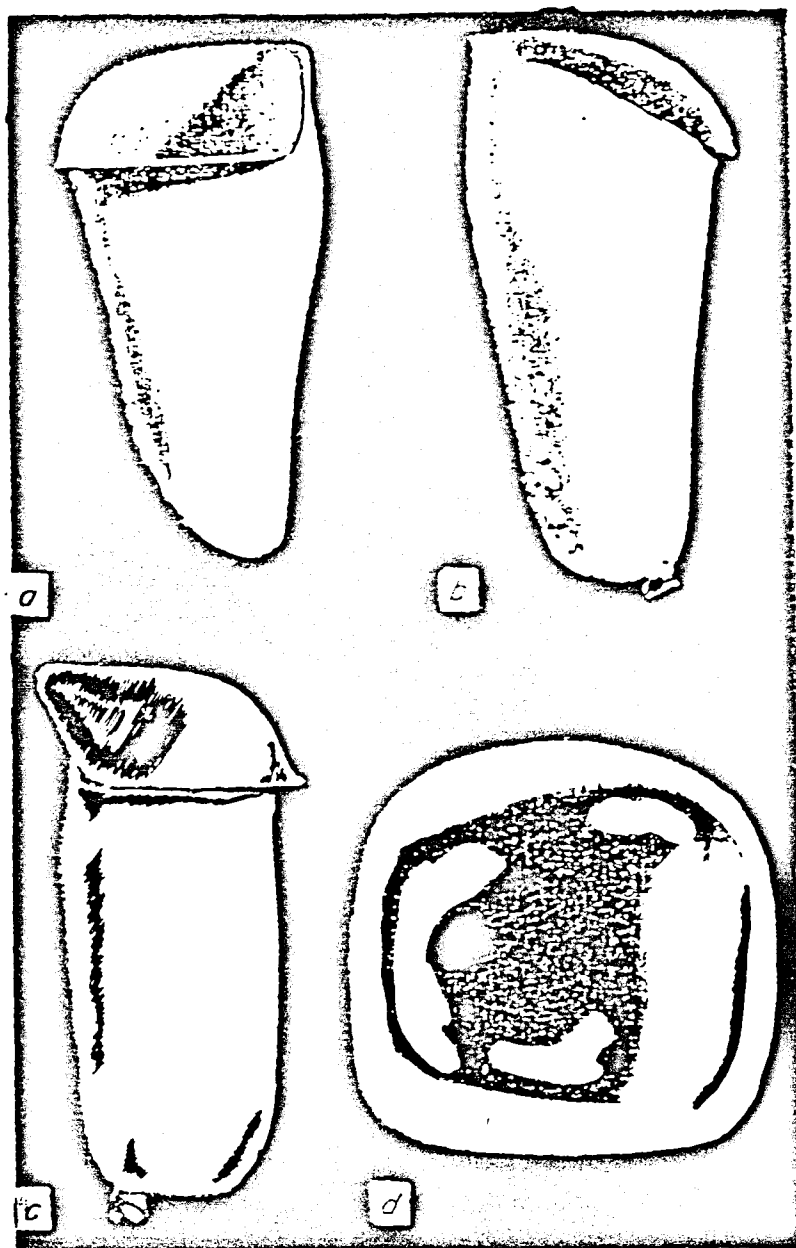

Figure (2.2.2.1) The Above-Knee Socket.
(a) Posterior view;
(b) Anterior view;
(c) Medial view;
(d) Viewed from above.

(Reproduced from Murdoch 1969)

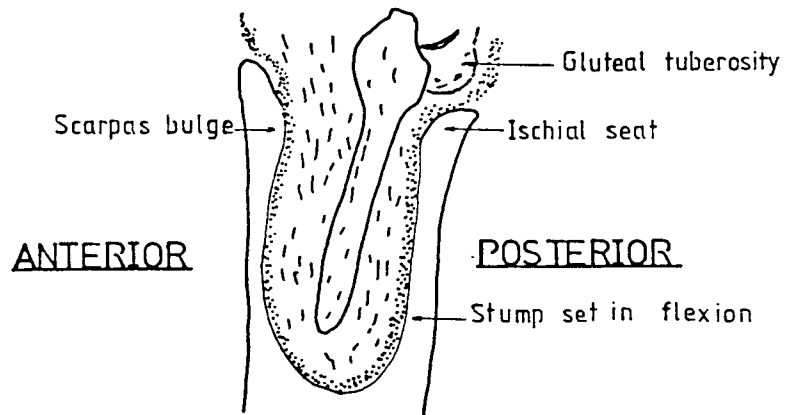
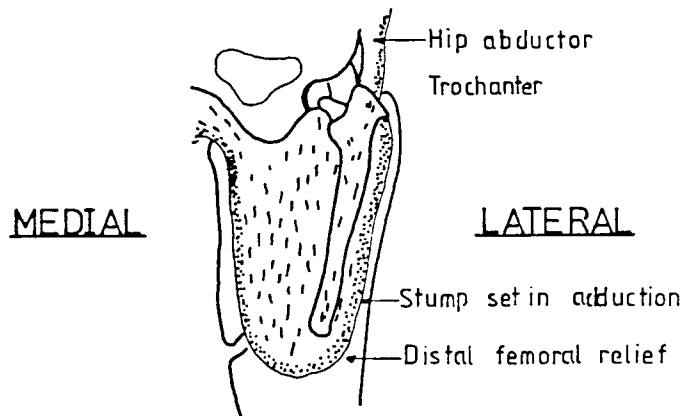
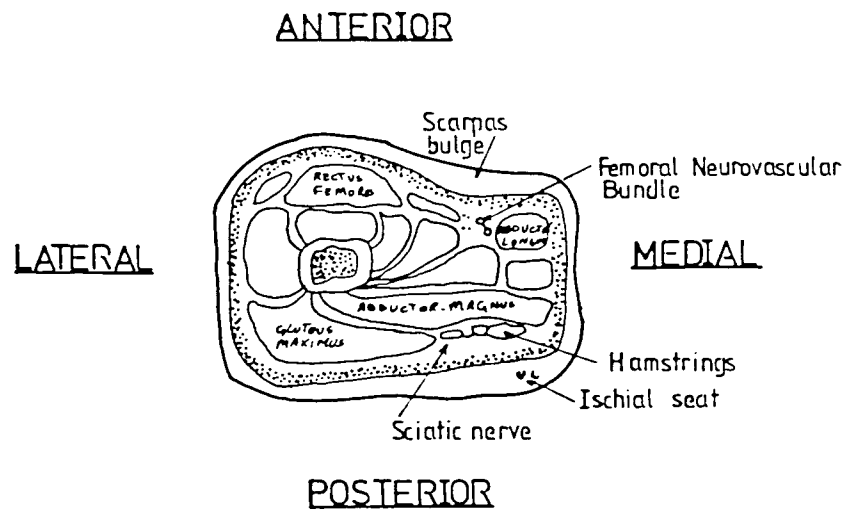

Figure 2.2.2.2 A-K Stump in Quadrilateral Socket
(Redrawn from Mital & Pierce, 1971)

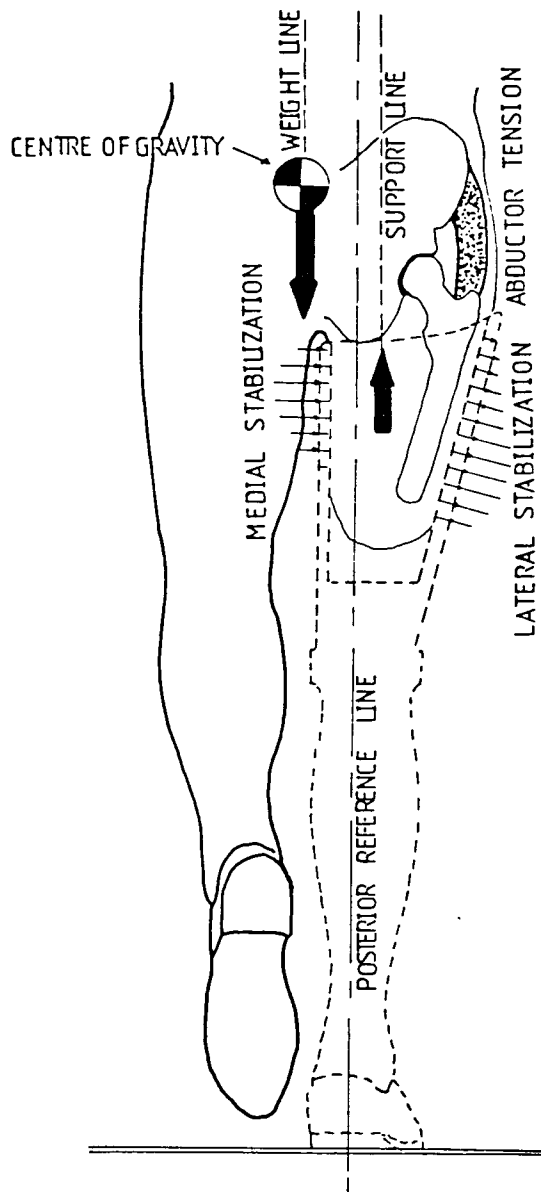

Figure 2.2.2.3 Use of the hip abductors for lateral stabilization of the pelvis.

(Redrawn from Radcliffe, 1954)

to reduce the proximal pressure significantly. During the stance phase, as the pressure between the stump and the socket increases, the distal support promotes venous return. During swing phase when pressure is reduced, blood-flow on the stump is unaffected by the socket. The harnessing of this type of limb is provided by means of suction between the stump and socket. A special valve is positioned at the bottom of the socket to facilitate donning and doffing of the prosthesis. The amputee's muscular contraction of stump provides increased sensory feed-back, which could help the amputee to gain better control of his prosthesis. Another advantage of this socket is that it aids venous return, which could prevent oedema.

Depending on the amputee and his activities the prosthetic knee mechanism can vary in design. There are two types of knee mechanism commonly used in the prosthetic practice. The uniaxial type and the four bar linkage mechanism.

The uniaxial or single axis knee mechanism is basically a simple hinge joint without any special feature which could create a friction torque or brake moment about the knee joint during the stance phase. Stability is generally achieved by locating the knee axis posteriorly with respect to the hip/heel line. If the patient has powerful hip extensors, it may be possible to position the knee joint on or anteriorly with respect to hip/heel line. The uniaxial knee joint can also be provided with a weight-

bearing friction brake which is actuated during the stance phase and can insure complete freedom from buckling.

Figure (2.2.2.4) shows a four bar linkage knee mechanism. The position of the joint centre is displaced by the four bar linkage in such a way that the prosthetic limb would remain stable, and the hip movement may be used to completely control the prosthesis and eliminate the need for a brake action at the knee. In the seated position the knee may achieve a reasonably normal position but there will always be cosmetic difficulties as compared with single axis designs. The use of other types of knee mechanism such as hydraulic control knee mechanism and knee locking devices depends on the amputee's activity and muscular strength.

The prosthetic feet used for AK prostheses are similar to those of BK prostheses

2.3 MODULAR ASSEMBLY PROSTHESES (MAP)

In Britain, the customary material for the construction of artificial limbs has been metal. The fitting procedures used in conjunction with the all-metal construction have involved a factory-made prosthesis, the alignment of which could only be altered during fitting with considerable difficulty. The "adjustable leg" designed at the University of California, Berkeley in the late 1950's (Wilson 1968)

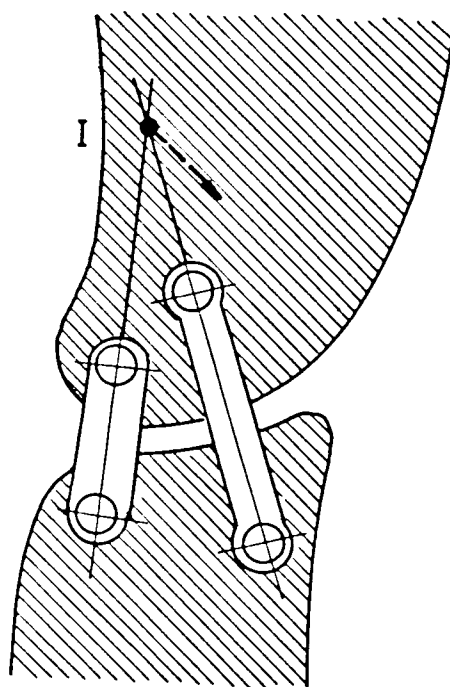

Figure 2.2.2.4 The four-bar linkage knee mechanism.

(Redrawn from Radcliffe in Murdoch 1969, "Prosthetic and Orthotic Practice")

constituted a significant improvement on the conventional fitting procedure, in that the alignment of the prosthesis could be altered while observing the patient's gait. After fitting, the adjustable portion of the limb was "transferred out" in a special apparatus and replaced by a crustacean type of construction.

In Germany, Otto Bock developed special apparatus in 1948, to assist the prosthetist in obtaining alignment.

The "Berkeley Leg" was followed by other adjustable temporary prostheses, and in the early 1960's techniques for fabricating plastic laminated sockets and for immediate post-operative fittings were introduced. These temporary prostheses were the forerunners for a more permanent type, the modular assembly prosthesis, Solomonidis (1980).

In 1971, a Conference sponsored by the Committee on the Prosthetic Research and Development (CPRD), developed the definition of modular assembly prostheses as:

Having access to a number of premanufactured, interchangeable components allowing quick and easy assembly with minimal facilities and to provide easier long term maintenance of the prostheses, the socket and the cosmesis being the only custom-made items.

The advantages of modular systems were considered to be:

- (1) Reduction of time in providing patients with functional prostheses.

- (2) Adjustability of the alignment configuration.
- (3) Light weight.
- (4) Replaceability of components.
- (5) Low cost.

The basic elements of a modular system are:

- (1) Socket and socket attachment device.
- (2) Knee mechanism.
- (3) Shin tube assembly.
- (4) Ankle/foot mechanism.
- (5) Alignment couplings.
- (6) Cosmetic cover.
- (7) Suspension cuffs, belts etc.

There are two different approaches to the alignment system adopted by different manufacturers. Some designs require the alignment device to be removed out of the assembly after completion of dynamic alignment. In the second system, the alignment device remains as part of the prosthesis. This type has the advantage of providing adjustability of alignment throughout the life of the prosthesis.

By the early 1970's a number of systems for below-knee (BK) and above-knee (AK) levels of amputation became commercially available. An evaluation programme was conducted at the University of Strathclyde, Bioengineering Unit (Solomonidis 1975 & 1980), which dealt with the comparative study of available modular systems for the BK and AK prostheses.

The evaluation had two principal aims:

- (1) To provide design information relating to the clinical and constructional requirements of MAPs;
- (2) To permit comparative study to be made about different systems with regard to their clinical suitability and physical features.

The work reported in 1975, was directed towards below-knee systems. It included six systems; Biomechanical Research and Development Unit (BRADU), Blatchford, Otto Bock, Hanger, Veterans Administration (VA) and Winning. Altogether 23 patients participated in the evaluation. Each patient was supplied with each of the 6 MAPs to wear continually with a conventional PTB for 6 weeks and this was done in order to give the patient a "standard" against which to judge each modular limb.

Parameters studied in the evaluation included:

- (a) Objective measurements of the alignment of the prostheses.
- (b) Time taken to find and construct the prostheses.
- (c) Mass of the prostheses.
- (d) Subjective impressions of the patient, surgeon, prosthetist and the prosthetist technician.

The BK evaluation concluded that the Hanger, VA and Winning systems were clinically unsuitable. Of the remaining systems the BRADU was rather complex; the Blatchford and Otto Bock were the best available.

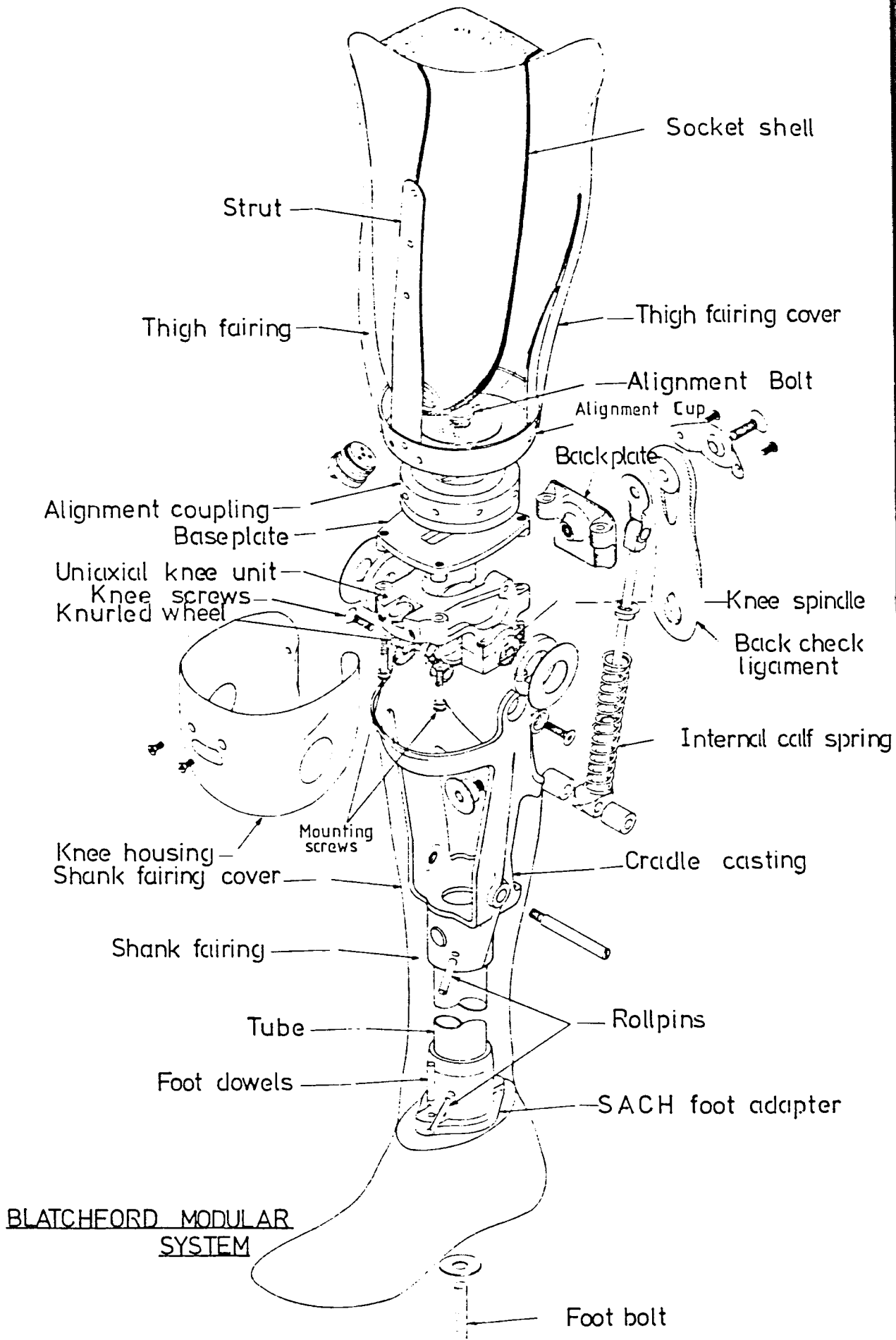

Figure 2.3.1 (from Solomonidis, 1980)

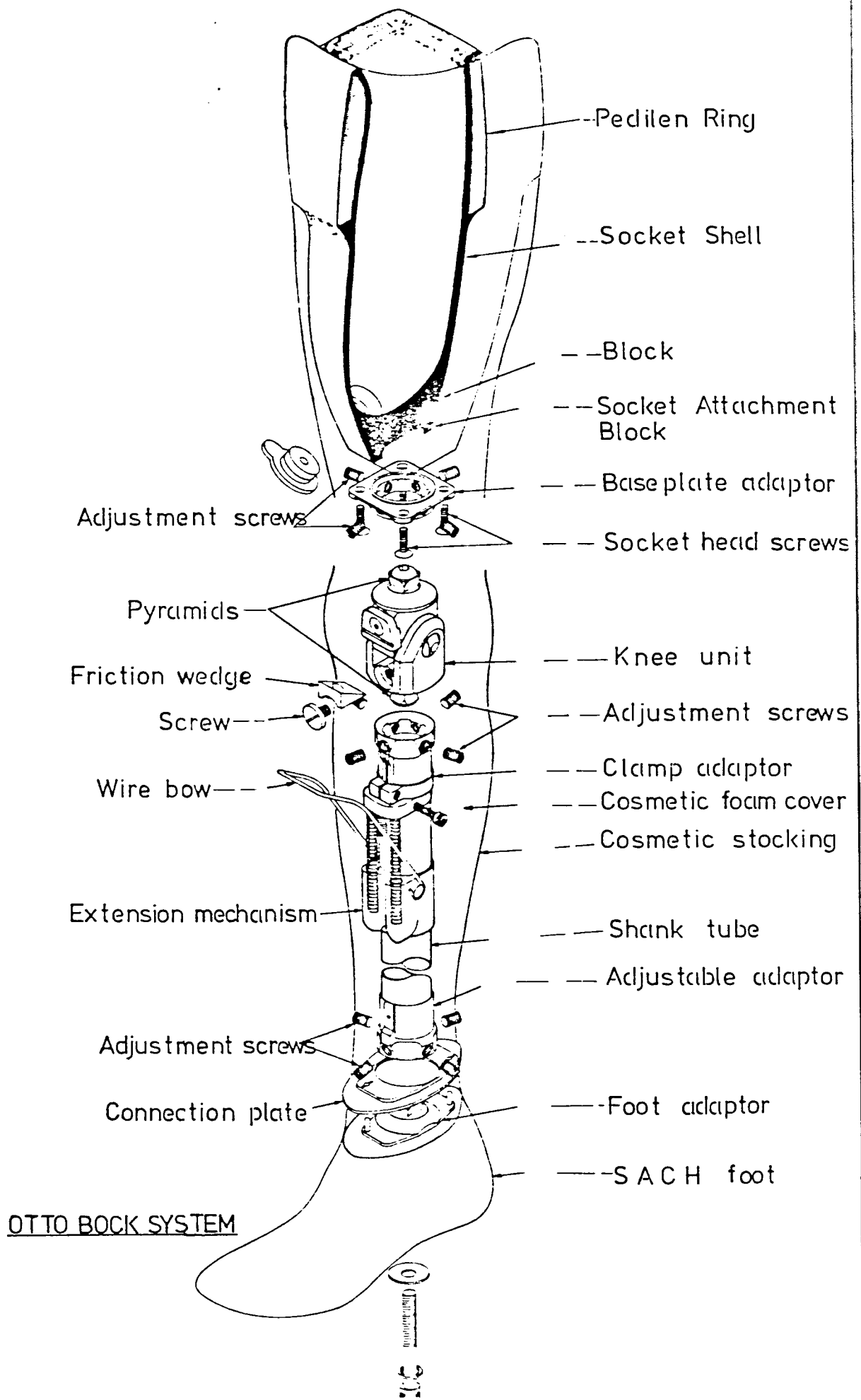

Figure 2.3.2 (from Solomonidis, 1980)

The above-knee (AK) systems evaluation, reported in 1980, investigated the products of four manufacturers: Blatchford, Otto Bock, Hosmer and United States Manufacturing Company (USMC). Twelve patients participated in the evaluation programme. Each patient was fitted with each of the four modular systems. In order to reduce the variables as much as possible, the socket and the prosthetic foot space were "standardized". The methodology of the evaluation was similar to that used for the below-knee systems except that more parameters were involved.

The USMC and Hosmer systems were found to be heavier than the patient's own conventional limb, and their use of a "transferred out" alignment device gave no advantage over conventional wood set-ups. The Blatchford, Figure (2.3.1) and Otto Bock, Figure (2.3.2) were found to be the preferred systems for the limb fitting service in Britain. It was, however, pointed out that both these systems still bear disadvantages and require further development.

CHAPTER 3

REVIEW OF KINEMATIC STUDIES
RELATED TO AMPUTEE GAIT

- 3.1 Introduction.
- 3.2 Kinematic Measurements.
- 3.3 Goniometry.
- 3.4 Optoelectric Techniques.
 - 3.4.1 The Television/Computer System.
 - 3.4.2 The Selspot System.
 - 3.4.3 The CODA System
- 3.5 Cinematography.
- 3.6 Characteristics of Normal Gait.
 - 3.6.1 The Gait Cycle.
 - 3.6.2 Biomechanics of Normal Gait.
- 3.7 Kinematics of Pathological Gait.
- 3.8 Energy Cost of Walking.

3.1 INTRODUCTION

The primary objective of locomotion is simply the translation of the human body from one point to another by means of bipedal gait.

A complete analysis of locomotion requires a detailed study of both the kinematic and kinetics of the extremity under consideration, and the collection of an enormous amount of data in order to follow the entire cycle of events.

The kinematic analysis of movement can be accomplished by studying the linear and angular displacements of the entire body and of the individual segments. The basic kinematic parameters are: linear and angular displacements as a function of time, linear and angular velocities and accelerations, the paths of motion of various anatomical landmarks and angle of each segment relative to another.

The purpose of kinematic analysis of locomotion is to gain a better understanding of the problems involved in the design of prostheses, and to find more reliable methods for their adjustments.

3.2 KINEMATIC MEASUREMENTS

The number and variety of kinematic measurements of walking are endless. The choice of a particular method of measurement is dictated by the purpose of the

investigation, and more specifically by the motions to be measured, accuracy of the measurements and ease of use of the instrumentation and data reduction. Measurements of absolute gait variables are best accomplished by photography in its various forms. Photographic techniques of motion measurement include the interrupted light method, cinematography and optoelectric recording.

Motion pictures, when taken of a moving body and, simultaneously of a timing device, served as a satisfactory record of absolute motions. This method has been widely used because of simplicity of the data gathering equipment and ease of data collection.

During data gathering, mirrors were placed above the subject by Murray et al. 1967, or below a glass walkway (Ryker, 1952) at a 45° angle, to obtain multiple views on the same photographs. Three dimensional displacements can also be recorded with stereophotography (Ayoub, et al. 1970). Optoelectric recording of motion, includes television recording and photodetector plate methods.

The first method is closely related to cinematography, except that the motions are recorded on videotape instead of film (Winter et al., 1972 & 1974; Cheng, 1974). The method could become effective when sophisticated, translating equipment was used to reduce the data directly into coordinates (Winter et al., 1972).

Goniometry has essentially been employed for measuring body segment angles in walking. This technique uses a device which measures relative angular movement between two body segments. Direct measurements of velocity and acceleration are useful for comparison with derivatives computed from measured displacements. Numerical differentiation, without smoothing or filtering, preferentially magnifies high frequency noise, but correct filtering overcomes the problem (Winter et al., 1974; Pezzact et al., 1977).

The following sections review some of the kinematics recording instruments, which provide quantitative analysis of human locomotion.

3.3 GONIOMETRY

The body accomplishes its essentially forward displacement by means of a highly coordinated series of rotations of the lower limb segments. One of the methods of measuring angles between segments in walking is "goniometry". A goniometer is a device to measure relative angular motion between two body segments. To obtain accurate measurement of rotation about a joint, it is necessary to align the measurement axis with the anatomical axis and to ensure that the goniometer does not restrict the range of joint rotation.

Lamoreaux (1974), developed a self-aligning goniometer

in which a parallelogram linkage spans a joint allowing rotations to be measured without the need for axis alignment.

Other studies by Townsend et al. (1977), described a goniometer having six degrees of freedom to measure the total motion of the knee. Since goniometric studies can only measure angular displacements between two adjacent segments, it cannot be used for kinetic analysis of human amputee locomotion, unless a pylon force transducer is mounted on the prosthetic shank.

3.4 OPTOELECTRIC TECHNIQUES

In order to reduce the time consuming procedure of manual data reduction, normally associated with cine filming techniques, the following optoelectric systems have been designed and developed:

- a) The T.V./Computer system
- b) The "Selspot" system
- c) The "Coda" system.

A brief review of the application of each system is presented in the following sections.

3.4.1 THE TELEVISION/COMPUTER SYSTEM

Television based systems have been under development for a number of years. All the systems use the same principle in obtaining two dimensional cartesian

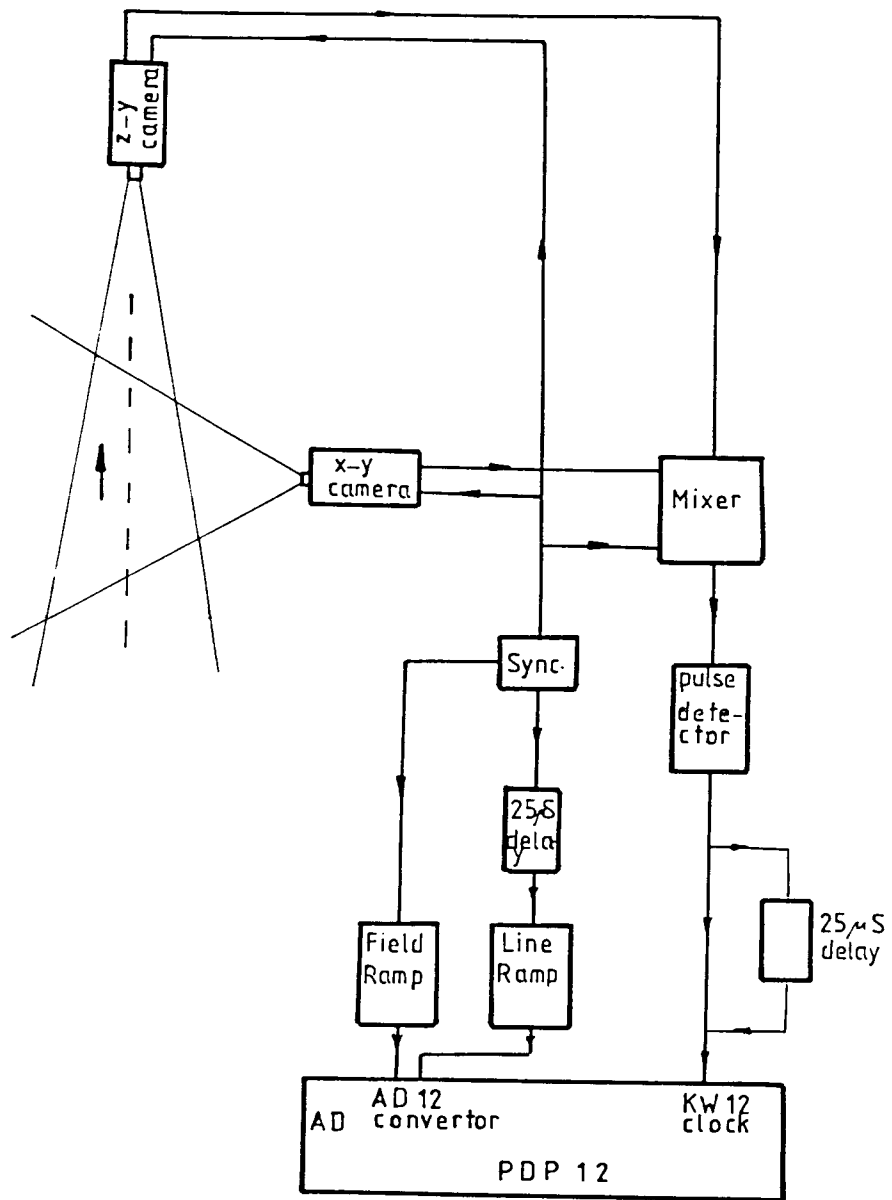

Figure 3.4.1.1 Block Diagram of 3-D TV Computer System.

(Redrawn from Jarrett, 1976)

coordinates of marker images. The marker image is detected by the T.V. camera and is referenced to the scan line and the position on this line. Many efforts have been made to update and develop T.V. systems as measuring devices for human movements. Over the years the type of markers, the digitization process, and the data acquisition sampling rate have been the subject of further improvement in T.V. systems.

Furnee (1967) used small electric light bulb markers to define anatomical landmarks. Digitizing of the video signals were carried out by digital counters. Buffer memories were incorporated into the system, which allowed data to be transferred to the computer during field blanking periods. A synchronous rotary shutter operating at 50 cycles per second was introduced into the system to optically freeze the instantaneous position of the markers. The acquired coordinates therefore relate to that instant of time. The exposure was 1/508 of a second and only five markers could be used. Since only one camera was used, the system was restricted to the study of two dimensional movements.

A T.V. based system was developed at the University of Strathclyde by Jarret (1976) and Jarret et al. (1976). This system could incorporate up to six T.V. cameras to acquire three dimensional kinematic information. However, only a two camera system was installed, Figure (3.4.1.1). Digital counters were used to obtain the coordinates

which were stored in buffer memories and transferred to the computer during the line and field blanking period. Up to six horizontal coordinates could be digitized and stored in a single scan line.

The sampling rate was 50Hz. Passive retro-reflective markers, made from 7mm diameter beads, were used. A tungsten halogen lamp positioned close to and beneath the camera, provides a light source which reflects on the marker surface. This imposes a limitation on the system, as other cameras have to avoid receiving direct light in their field of view. Thus, simultaneous recording of the contralateral side of the body is not possible with the described camera layout and modifications to overcome this limitation are being introduced.

The original system as described by Jarret (1976), has been under development at the University of Strathclyde (Andrews, 1982). These include using infra-red lights instead of tungsten halogen, which could remove a major restriction during patient testing. Also, the introduction of shutters and synchronising strobe lighting has allowed the use of cameras which are facing each other. This arrangement allows the collection of kinematic data from both sides of the subject. Hence, full body kinematic measurements are possible. The recent interface and sorting software allows a quicker means of sorting and displaying the data. Also, by using averaging and filtering techniques, cometailing effects may be eliminated.

3.4.2 THE SELSPOT SYSTEM

The selspot system (Selective Light Spot Recognition) is based on a continuous light spot position sensitive, silicon photodiode sensor. A light spot impinging on the surface of the sensor, varies the current in the load resistances, giving its position. A dual axis sensor provides the two dimensional coordinates of the incident light spot, Figure (3.4.2.1). Infra-red emitting diodes are being used as markers. By a time-multiplexing technique up to 30 markers can be tracked at a sampling frequency of 312.5Hz.

For three dimensional recordings, two of the specially designed cameras are used. Each "LED" (Light Emitting Diode) marker is sampled sequentially, hence there is no problem in coordinate-marker identification. The disadvantages in using infra-red light emitting diode markers is that they have to be mounted on the body together with the circuitry and power supply.

3.4.3 THE CODA SYSTEM

The "CODA" system (Cartesian Optoelectric Dynamic Anthropometer) was first developed by Mitchelson (1975) and further improved by himself in 1981, which is now commercially available as 'CODA-3'. This system consists of three specially designed cameras, see Figure (3.4.3.1), arranged so that the two outer cameras are sensitive to horizontal movement ('X' direction) and the middle one is

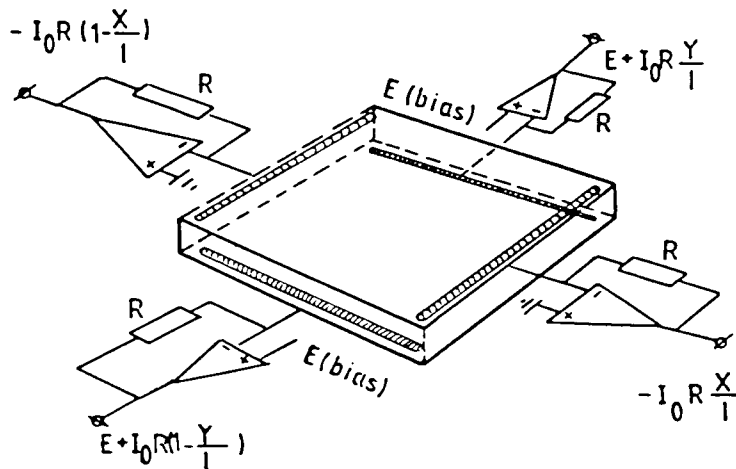

Figure 3.4.2.1 Dual-axis, duo-lateral, position sensitive photodiode.

(Redrawn from Woltring 1975)

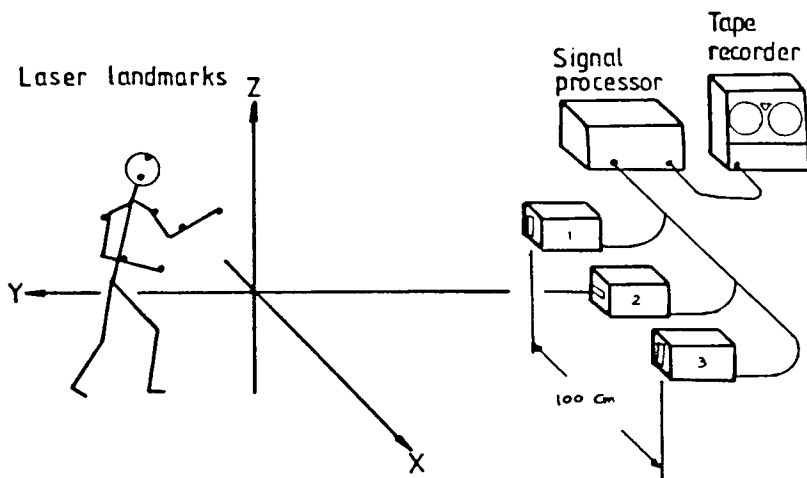

Figure 3.4.3.1 Schematic representation of the CODA system arrangement.

(Redrawn from Mitchelson, 1975).

sensitive to vertical movement ('Z' direction). The arrangement of the two outer cameras allows the depth of the target to be computed ('Y' direction). The analogue or digital output produced is free from parallax errors. Each camera consists of a cylindrical lens doublet, which is used to focus a point light source into a line image in the focal plane. The improved version uses passive prism markers made from glass and mirror in the shape of a pyramid, each having an effective angular range of 220 degrees. Each marker is uniquely identified by a colour filter, which is recognised by an optoelectric colour decoding system.

3.5 CINEMATOGRAPHY

Eberhart and Inman (1947), studied several aspects of human gait and described two methods using 35mm cine cameras operating at 48 frames per second. The first method involved using three cine cameras positioned on three mutually perpendicular coordinate reference planes, 25 feet from the subject. In this manner top, front and side views of the subjects were obtained simultaneously, see Figure (3.5.1). Wooden markers were attached to stainless steel screws driven into bony prominences. The markers were placed normal to the axis of rotation and were long to minimise the inherent errors in data reduction. For the reduction of data, the method employed the use of computed space coordinates of the markers, since it was necessary to correct for errors due to parallax and perspective.

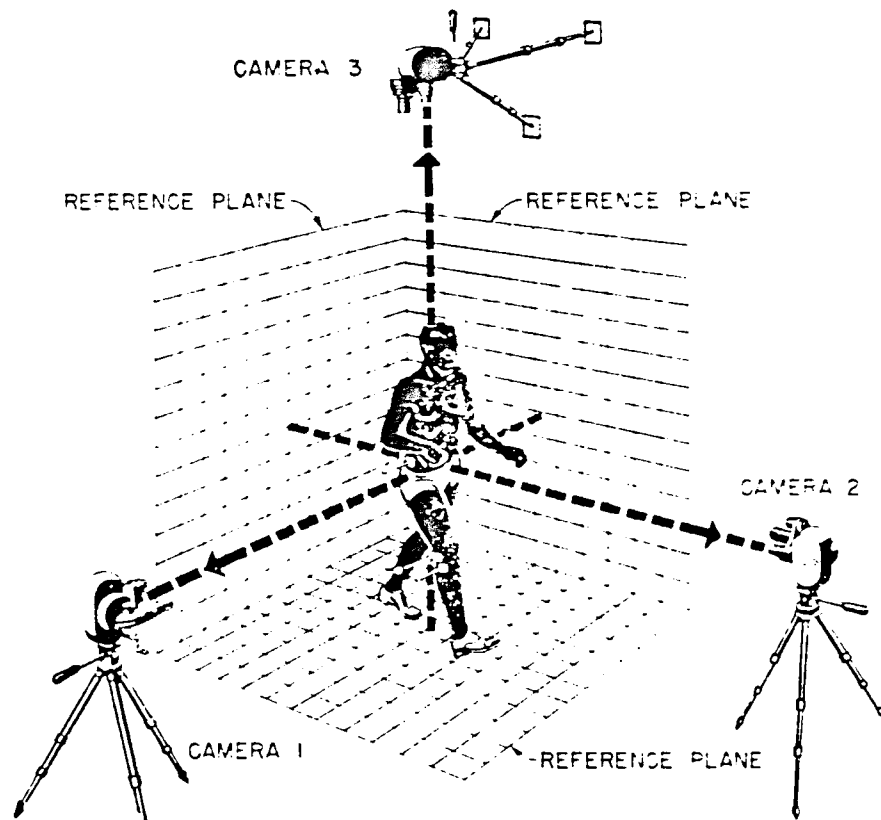

Figure 3.5.1 Arrangement for recording pin-study data.

(from: Klopsteg & Wilson, "Human Limbs and their Substitutes", 1954).

The second method used a glass walkway with an inclined mirror underneath. One cine camera was positioned normal to the sagittal plane, taking the lateral view as well as the view from the mirror. Another cine camera was used to film the frontal view. Beside adhesive tape markers, a special pelvic girdle with an anterior extension and a 'U' shaped ankle bracket with three locating pins were used on the subject. Although the arrangement of the cameras allowed three dimensional analysis, the uncomfortable marking system was very undesirable in that it may have affected the natural gait.

Paul (1967) working at the University of Strathclyde, used two 16mm cine cameras front and side, operating at 50 frames per second. Skin markers were used in the form of white targets on a black background to indicate the joint centres. The films were re-exposed at the end of the test to superimpose a grid board of 5 in. sq. as a reference. This method improved the accuracy of data reduction. Paul showed clearly the corrections required for parallax effects.

Ishai (1975), extended this method in order to study whole body movements in three dimensions. This was done by including an additional side camera.

Many efforts have been made to improve on the data reduction technique for cinematographic measurements. The main aim has been to reduce the time required for data

reduction, and to reduce operator based errors.

Pepoe (1970) introduced an automated system which was comprised of three sheets of "fibre optics" interfaced to a mini-computer. The accuracy of this system was, however, limited when the markers were too close together.

Although one major setback in cinematography is the time consuming effort required in data reduction, it provides a permanent three dimensional record of the event, which is very advantageous.

3.6 CHARACTERISTICS OF NORMAL GAIT

(Reference: Peizer and Wright in Murdoch 1969, "Prosthetic and Orthotic Practice").

3.6.1 THE GAIT CYCLE

A single step consists of two separate parts; the stance phase and the swing phase. The stance phase is characterised by the need for stability. The foot spends about 60% of the walking cycle in contact with the ground (stance phase), and the remaining 40% swinging through to take up its new position ahead of the supporting contralateral foot (swing phase).

Stance phase begins at heel-strike on one leg and ends at toe-off on the same leg. Swing phase begins where

the stance phase ends and represents the period between toe-off on one foot and heel contact on the same foot. Stance phase is characterised by six gait events. It begins at the instant the heel of the foot touches the floor - HEEL CONTACT. Following heel-contact, the sole of the foot comes in contact with the ground - FOOT FLAT. Just after foot flat, the body is swung directly over the supporting limb and continues to rotate over the foot - MID STANCE. As the body above the ankle continues to rotate about the ankle forwards the heel lifts off the ground - HEEL OFF. Following heel-off, the body is propelled forward by the forceful action of the calf muscles - PUSH OFF. The push off terminates when the entire foot rises from the ground - TOE OFF, see Figure (3.6.1.1).

Swing phase is defined by three main periods. A period of ACCELERATION begins at the instant the toe leaves the ground. At this point the leg must be accelerated in order to catch up with and get in front of the body in preparation for the next heel-contact, see Figure (3.6.1.2). When the swinging leg has caught up to and passes directly beneath the body it is in MIDSWING. A period of DECELERATION begins after midswing when the forward motion of the leg is restrained by the stretching of the hamstring muscles to control the position of the foot immediately before heel contact.

As the leg alternates from the swing to stance on

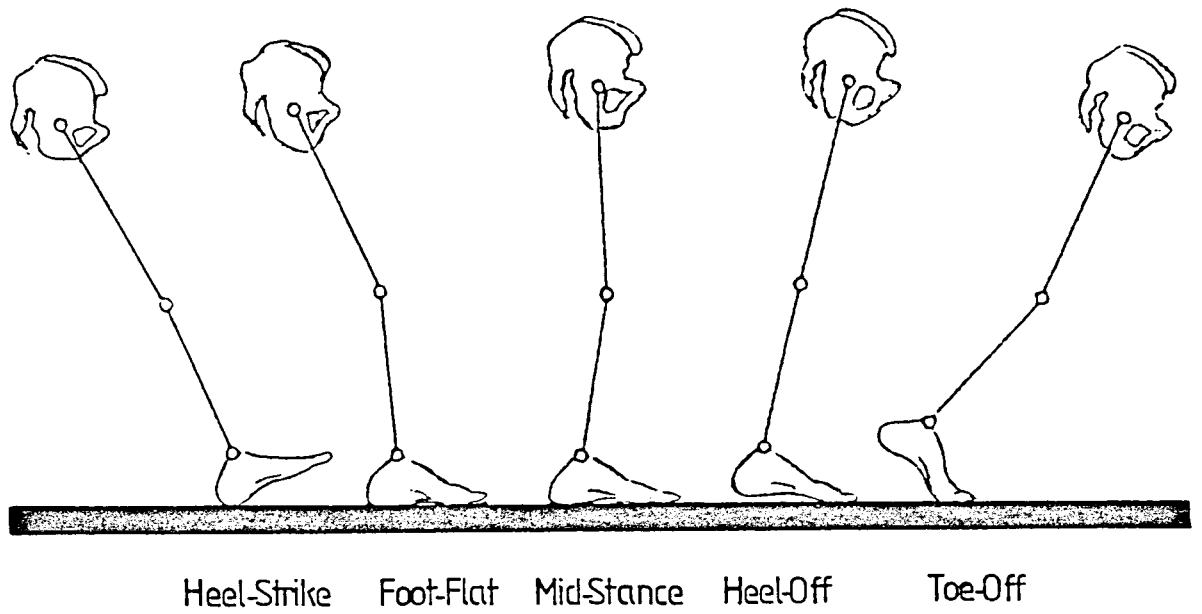

Figure (3.6.1.1) STANCE PHASE

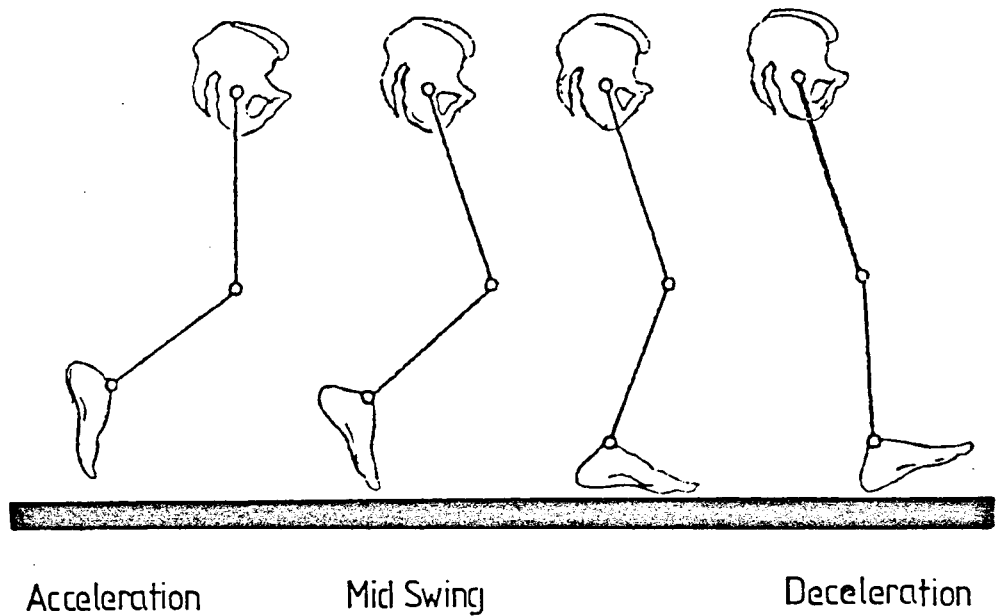

Figure (3.6.1.2) SWING PHASE

(Redrawn from Peizer & Wright in Murdoch 1969, "Prosthetic and Orthotic Practice")

each leg there is a period when both feet are in contact with the ground simultaneously - DOUBLE SUPPORT. Double support occurs between push-off and toe-off on one foot and heel-contact and foot-flat on the other. The period of double support occupies 25% of the gait cycle time, and represents a portion of the stance phase time for each leg.

3.6.2 BIOMECHANICS OF NORMAL GAIT

Motion at the joints of each segment of the body results from the interaction of two sets of forces: internal forces which are produced inside the body by the muscles and external forces represented by the influence of gravity and inertia forces on the body. Muscles inside the body are generating forces which resist external forces and modulate it in a way that walking and other activities are possible. Gravity aids in initiating gait. In standing erect a vertical projection of the centre of gravity falls anterior to the hip joint tending to flex it, anterior to the knee joint tending to extend it, and anterior to the ankle joint tending to dorsiflex it. To initiate walking the plantarflexors of one leg is relaxed, allowing the body to fall forward on that side, and swing the other leg forward at the hip.

Following heel contact, as an increasing amount of body weight is transmitted to the ground, reaction forces pushing back up against the heel create a moment tending to plantarflex the ankle. The sudden impact of heel-

contact is partially absorbed by lowering the body through plantarflexion of the ankle, see Figure (3.6.2.1), which helps to flex the knee, see Figure (3.6.2.2), Saunders et al. (1953). Just before the sole of the foot touches the ground (FOOT FLAT) the peak plantarflexion moment is reached at approximately 10% of the cycle. This is followed very rapidly by the peak plantarflexion angle of the ankle of approximately 15-20 degrees which occurs under the influence of the peak ankle moment. The ground reaction force causes motion about the lower ankle at a rate governed by the dorsiflexors of the ankle which absorb the force and allow the ankle to move into plantarflexion.

With the foot flat, the mass of the body above the ankle joint rotates about it changing the direction of ankle motion from plantarflexion to dorsiflexion. As both the swinging leg and a vertical projection of body centre of gravity move anteriorly, a large moment is generated about the ankle joint tending to move it in the direction of dorsiflexion. The peak dorsiflexion moment is reached very shortly after heel-off, when the vertical projection of the centre of gravity is in front of ankle joint and the full body weight is being carried on the stance foot, Figure (3.6.2.1).

Just before heel-off, the ankle moves from a position of maximum plantarflexion to a position of maximum dorsiflexion at approximately 15 degrees. At the instant of toe-off the ankle is in approximately 15 degrees

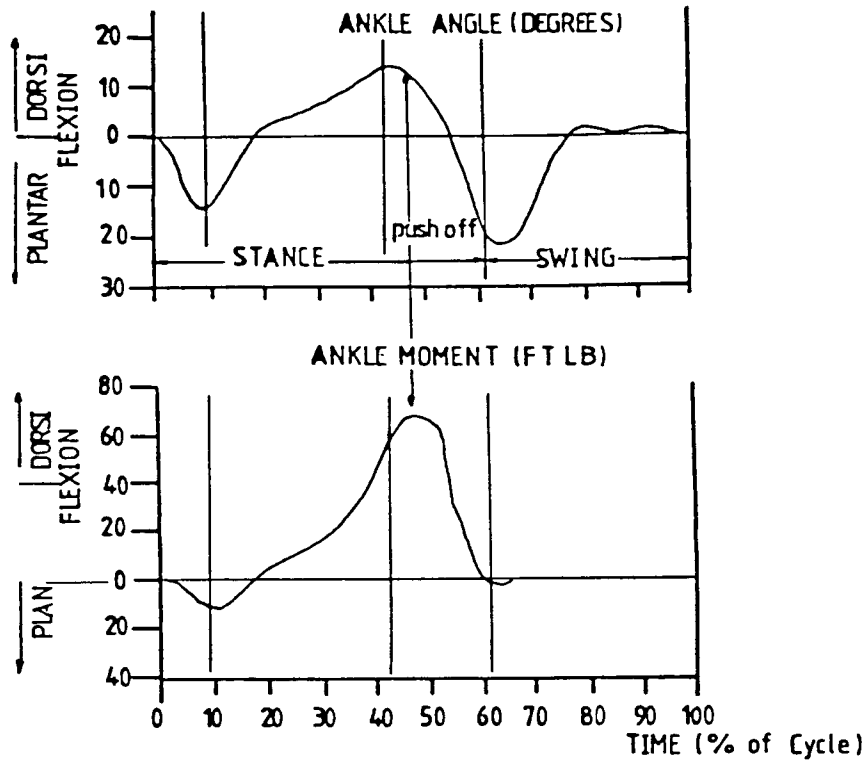
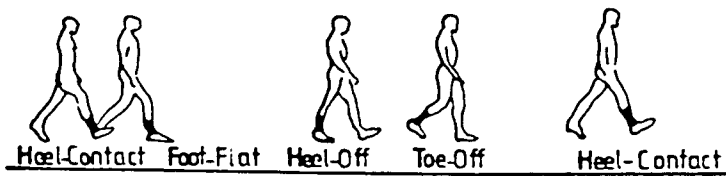

Figure 3.6.2.1 Ankle Kinetics.

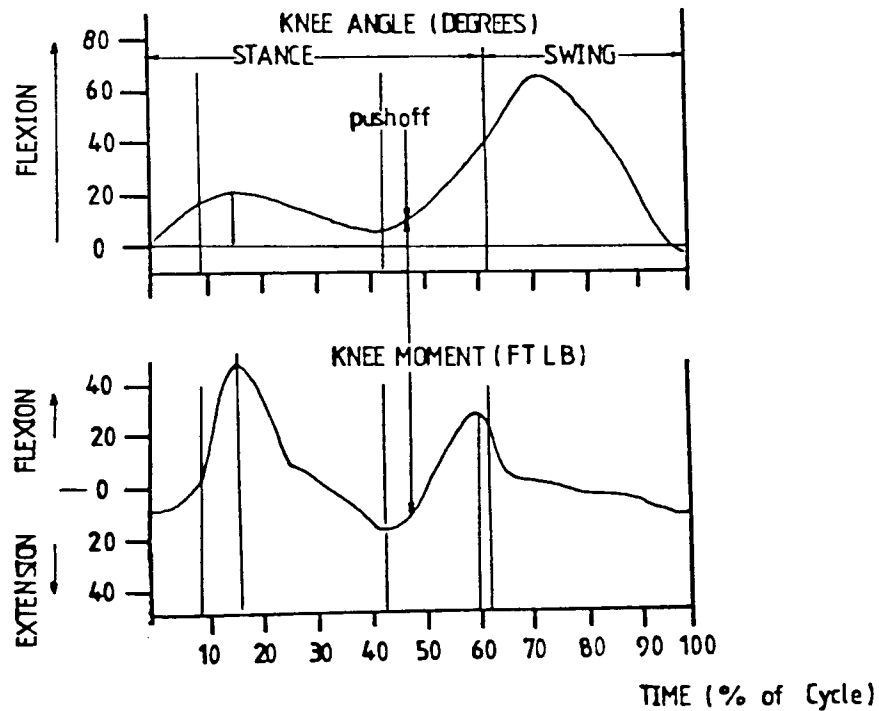

Figure 3.6.2.2 Knee Kinetics.

(Redrawn from Peizer & Wright in Murdoch 1969, "Prosthetic & Orthotic Practice")

plantarflexion. During the swing phase of gait it returns to approximately 20 degrees where it remains up to the instant of the next heel-contact, see Figure (3.6.2.1).

The angular motions and moments about the knee are shown in Figure (3.6.2.2). With the heel in contact with the ground and increasing amounts of body weight being applied through the leg, the ground reaction line passes behind the knee centre, creating a substantial moment at the time of foot-flat. The flexion moment diminishes rapidly after foot-flat as the mass of the body above the ankle rotates forward, reducing the distance between the centre of the knee rotation and the line of the ground reaction force. The instance of mid-stance is indicated by the zero moment about the knee occurring at approximately 32% of the stance phase after which an extension moment is generated to a peak, as the knee becomes fully extended again just prior to heel-off. At the time of heel-off the knee begins to flex again and as its centre of rotation moves further anterior to the ground reaction line, the flexion moment about the knee reaches a secondary peak and returns to zero at the instant of toe-off.

During the swing phase of gait, forcible hip flexion accelerates the knee centre forward. Due to their inertia, the leg and foot tend to lag behind the accelerating knee centre, producing flexion about the knee which reaches approximately 65 degrees and then begins to extend, reaching full extension at the time of the next heel

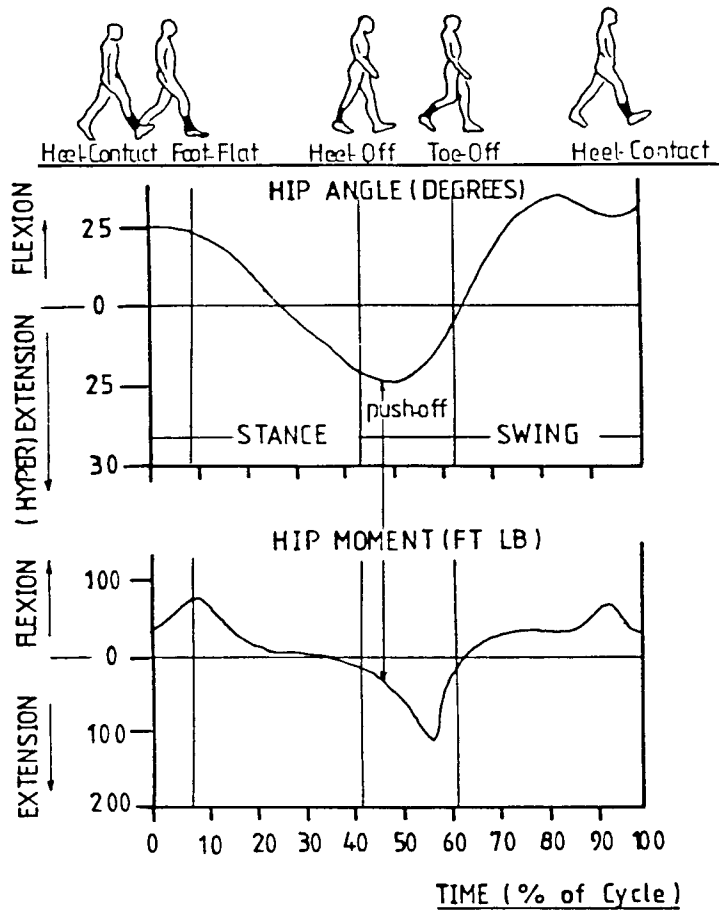

Figure 3.6.2.3 Hip Kinetics.

(Redrawn from Peizer & Wright in Murdoch 1969, "Prosthetic and Orthotic Practice")

contact. The characteristic pattern of normal hip motion is shown in Figure (3.6.2.3). With the leg advanced at the instant of heel-contact, the pelvis remains approximately vertical causing the hip to flex approximately 25 degrees. As the body weight is applied, the ground reaction force creates a flexion moment about the hip since its line of action passes behind the knee and ankle joints but just anterior to the hip joint. As the major mass of the body rotates over the ankle and knee joints between foot-flat and mid-stance, the ground reaction force passes through and then behind the hip joint. An extension moment about the hip is generated shortly after foot-flat and gradually increases to its peak value while the position of the hip has changed from approximately 25 degrees flexion, at the beginning of the stance phase, to approximately 25 degrees of extension at push-off.

3.7 KINEMATICS OF PATHOLOGICAL GAIT

The amputee gait studies conducted at the University of California, Berkeley in 1947 concluded that the above-knee amputee demonstrated a much greater vertical displacement of the greater trochanter than the normal subject. During the swing phase the amputee threw his prosthesis forward in order to have full extension to prepare for heel-strike. The knee joint of the above-knee prosthesis had slightly higher horizontal velocity than that of the normal subject, whereas the ankle velocities were lower, and maximum acceleration of the

knee for the above-knee prosthesis was usually higher. The total M/L pelvis tilt in the above-knee amputee was 10 degrees, while the normal subject's was only 6 degrees. This higher magnitude was to help swing the prosthesis through. The prosthetic knee remained locked for the greater part of stance phase, and absence of knee flexion during stance phase was noticed.

James and Oberg (1973), studied the gait of 34 unilateral above-knee male amputees, all except one being fitted with quadrilateral total-contact suction socket. They found the subjects took longer steps with the prosthesis than with the sound leg and the stance duration of the prosthesis was smaller than that of the sound leg.

Godfrey et al's (1975) conclusion on the gait characteristics of seven above-knee amputees was that each subject walks with a characteristic gait pattern of his own on any stable prosthesis.

Murray et al. (1980) found that the above-knee amputees had an abrupt reversal of the hip from flexion to extension just after heel-strike of the sound leg. The prosthetic knee did not yield into flexion in the early stance phase and the maximum knee flexion during swing was similar for the sound and the prosthetic limb, Figure (3.7.1).

The studies at U.C.B. in 1947, used the interrupted

10 AK AMPUTEES

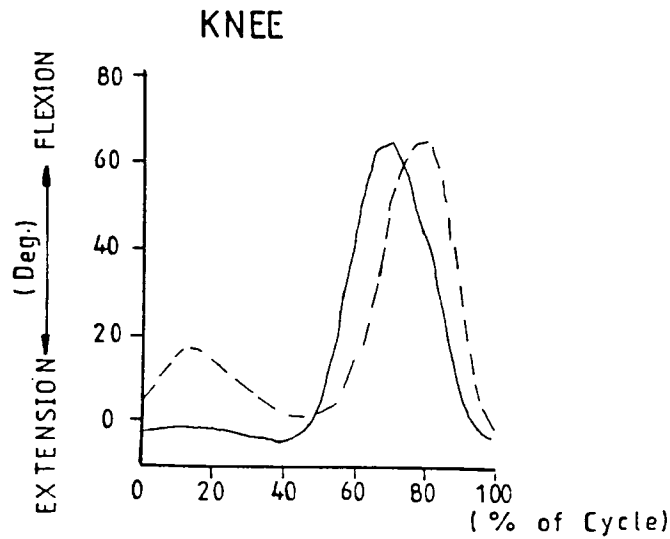
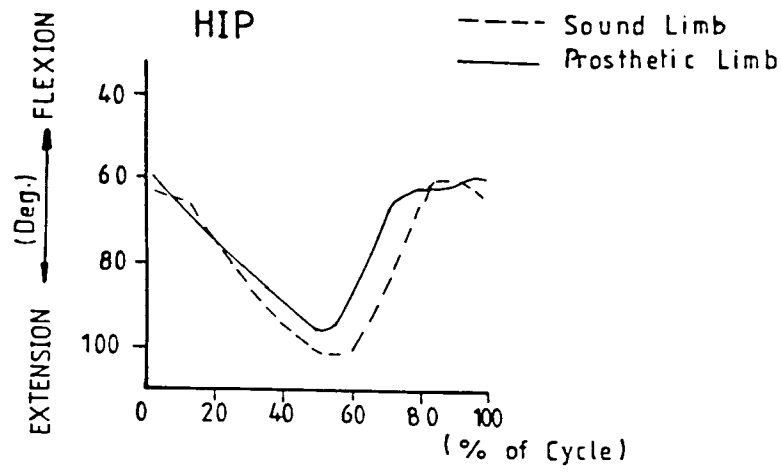

VERTICAL DISPLACEMENT

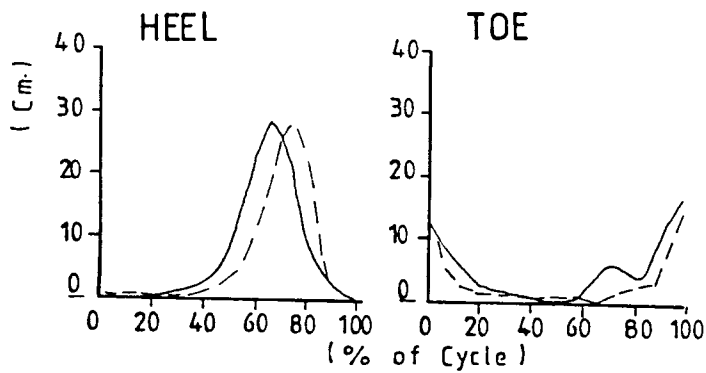

Figure 3.7.1 Kinematic Data of Above-Knee Amputees.

(Redrawn from Murray et al, 1980)

light photographic technique and a glass walkway with cine camera recordings to analyse and compare gait patterns of normal subjects and amputees. It was found that the below-knee amputee takes a longer step with his normal leg than with his prosthesis, and that normal subjects have a longer stride than below-knee amputees.

Breakey (1976), conducted studies for evaluation of the gait of unilateral below-knee amputees. He reported that the loss of a normal foot and ankle in the below-knee amputee resulted in a longer stance phase duration in the normal limb and a shorter stance phase in the amputated side. These findings corresponded to those of U.C.B. (1947). The report also concluded that the period of foot-flat on the affected side was longer than on the normal side and heel-off on the affected side occurred much earlier than on the normal side, Figure (3.7.2). Knee motion in the amputated limb was found to have the same general pattern as that seen in normal knee motion. However, the magnitude of knee flexion in the amputated side was reduced in stance phase, at toe-off and at peak knee flexion during swing phase, Figure (3.7.3).

U.C.B. (1947) reported that the degree of disability and difficulties of satisfactory replacement vary with the level of amputation. Since in any unilateral leg amputee the locomotor mechanism is no longer symmetrical, the natural leg can no longer be expected to parallel the performance of normal walking. It is therefore not only

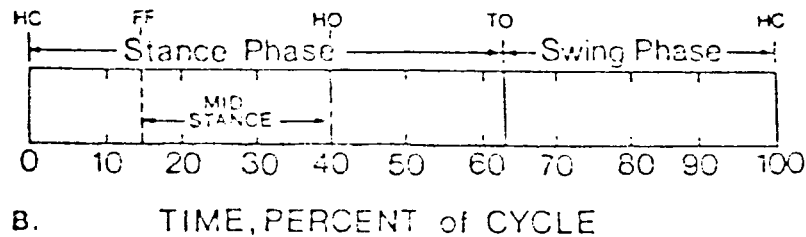
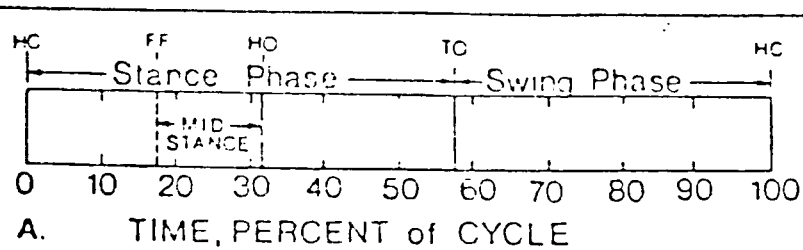

Fig. Foot-timing for the BK amputated subjects
 A. Prosthetic limb B. Normal limb

Figure 3.7.2 Temporal Parameters for
 Below Knee Amputees
 (from Breakey, 1976)

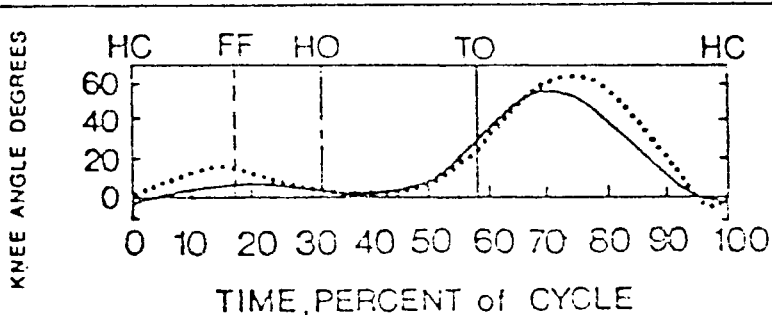

Fig. Knee motion for the prosthetic side. Solid line (—). Knee motion curve for amputee. Dotted line (···). Knee motion curve for normals.

Figure 3.7.3 Knee flexion angles for
 Below Knee Amputees
 (from Breakey, 1976)

the performance of the prosthetic side but also the natural leg which requires investigation (U.C.B., 1947).

3.8 ENERGY COST OF WALKING

The energy expenditure during walking is an important parameter for the evaluation of human gait. One of the most remarkable aspects of normal locomotion is the extreme economy with which it is performed.

It was shown by Fishman et al. (1962) that AK amputees require approximately 100% more energy to walk than normal people. A significant portion of this excess is due to the inability to flex the knee in early stance. The same study showed that in a normal individual the restriction of normal knee movement in early stance increased the energy consumption by approximately 25%.

Ralston and Luken (1969) found a "fairly" constant ratio between the metabolic expenditure and the energy requirement for subjects during normal walking. They concluded that mechanical energy changes can be used to obtain an indication of the energy requirements during walking.

Quingly et al. (1977) reported on the oxygen consumption during walking with light weight, conventional BK prostheses. The resulting trend was a higher consumption per meter walked per kilogramme body weight, with the heavier type of prostheses.

Lanshammar (1982) reported on the mechanical energy levels for normal and prosthetic gait. The measurements and analysis were made with a Kistler force plate, Selspot system and a mini-computer (HP21MX). It was noticed that when an 0.5kg. extra weight was added to the prosthesis, the energy changes for the prosthetic shank increased significantly. It was found that with varying prosthetic weight, there was no indication on the total body energy changes. This finding does not, however, correspond to that reported by Quingly in 1977.

It is noticeable that in walking at speeds significantly below or above the "preferred" speed, energy costs are significantly higher. This phenomenon supports the theory that walking is achieved with minimum energy expenditure. Normal gait is extremely efficient and any inefficiency, ie. alteration of the normal pattern of gait, decreases the efficiency and increases the energy consumption (Murdoch, 1969, "Prosthetic and Orthotic Practice").

CHAPTER 4

ALIGNMENT OF LOWER LIMB
PROSTHESES

- 4.1 Introduction.
- 4.2 Definition of Alignment.
- 4.3 Bench Alignment.
- 4.4 Dynamic Alignment.
 - 4.4.1 Gait Deviations.
- 4.5 Measurement of Alignment.

4.1 INTRODUCTION

The basic requirements of lower limb prostheses are: comfort, function, cosmesis and safety. A good fitting socket will provide the first step towards comfort and function. For maximum comfort and proper functioning, the components of the prosthesis must be accurately positioned relative to each other. Basically, the prosthesis undergoes two "alignment" stages:-

- 1) Bench alignment, which is the initial setting up of the limb to a prescribed configuration.
- 2) Dynamic alignment, which is the subsequent modifications made to the geometrical configuration of the components during walking trials.

During dynamic alignment of the prosthesis, the prosthetist receives information feedback from the patient and together with his own judgment and knowledge aims to achieve the most suitable limb configuration. This limb configuration is known as the "Optimum alignment", and it was until recently believed that for a given patient and prosthesis this was unique.

A study of alignment conducted at the University of Strathclyde indicated that there is a wide range of alignments acceptable to a patient, thus disputing the concept of "unique optimum alignment", (Solomonidis, 1975 and 1980).

4.2 DEFINITION OF ALIGNMENT

Alignment is defined as the geometrical orientation of the various components of a lower limb prosthesis relative to each other. These components are arranged in a way that the amputee may have optimum physical security, the best possible gait, a minimum requirement for expenditure of energy in walking and generally a comfortable leg giving good posture without injury to the stump even when used for comparatively long periods of time. In a poorly aligned prosthesis, the patients have been observed to compensate for the inefficiencies of the prosthetic leg by the contralateral side (Zahedi, 1982). This compensation can be carried out unintentionally and thus full satisfaction can be claimed by the wearer, though being only temporary. Hence, proper alignment of prostheses has a vital part in preserving the sound leg (Zahedi, 1982).

4.3 BENCH ALIGNMENT

The bench alignment of a lower limb prosthesis is described as the alignment setting of the limb during the manufacturing process. The aim of the "bench alignment" procedure is to obtain a limb that would allow the patient to undertake walking trials and to keep the final adjustments to the alignment to a minimum.

Bench alignment of the below knee prosthesis (P.T.B.) is carried out by visually detecting a socket mid line

in the posterior and lateral views. This mid line is then set to the 5 degrees angulation described by Radcliffe and Foort (1961). The mid line at the level of the patellar tendon bar is the reference point from which the shifts are measured relative to the shank tube. The prosthetic technician secures the socket in the position relative to the other limb components during initial assembly.

Radcliffe and Foort (1961), recommended the following bench alignment settings for patellar tendon bearing prosthesis: See Figure (4.3.1).

Socket	A/P tilt	5 degrees
"	M/L tilt	5 degrees
Socket	A/P shift	37mm.
"	M/L shift	18mm.

These settings have been accepted and used in prosthetic practice. The variability of the length and power of the above knee stump has made it impossible to specify recommended bench alignment for AK prostheses. Radcliffe (1955) made certain recommendations which are shown in Figure (4.3.2).

4.4 DYNAMIC ALIGNMENT

The first alignment procedure in which the patient is involved is the "Static alignment". Static alignment is undertaken with the patient standing on the prosthesis. During this stage of the fitting process the prosthetist

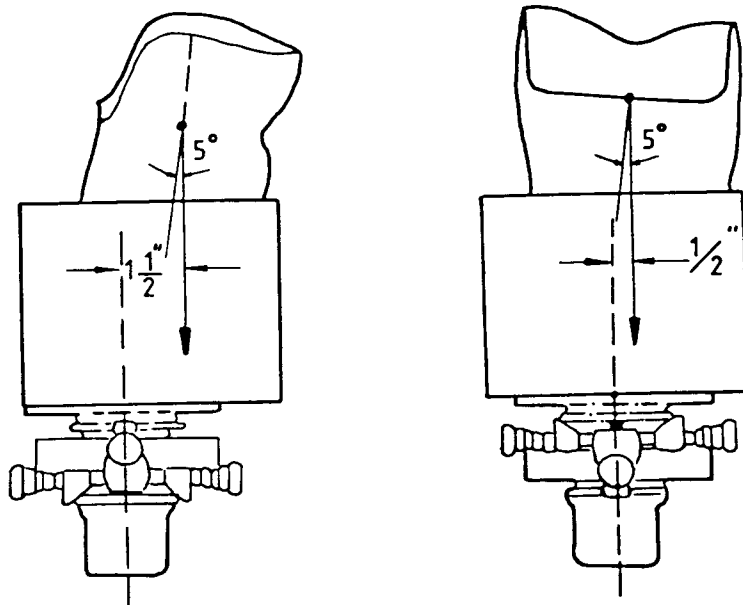

Figure 4.3.1 PTB Bench Alignment Setting

(Redrawn from Murdoch, 1969,
"Prosthetic and Orthotic Practice")

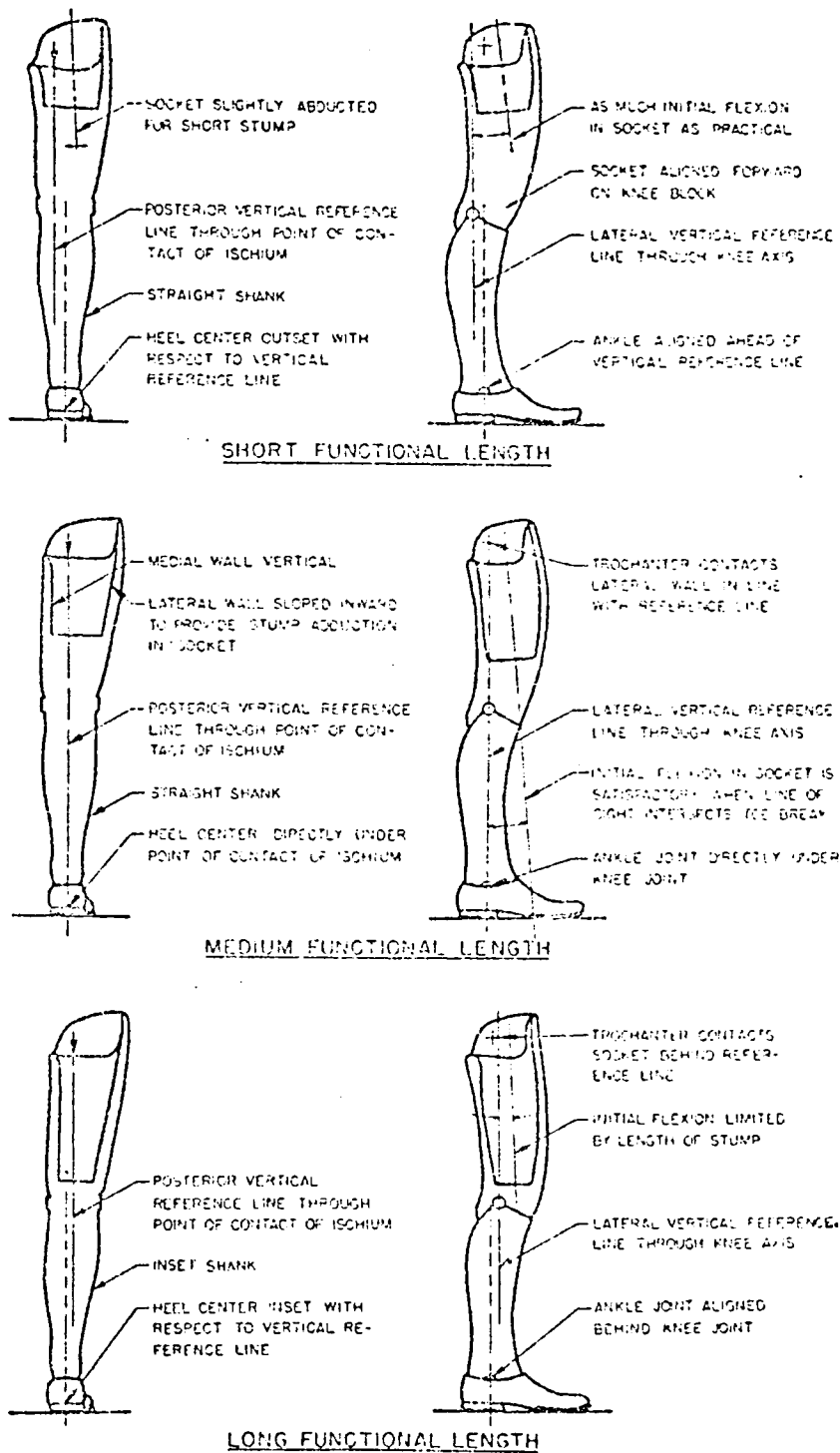

Fig. 9. Variations in alignment to accommodate stumps of different functional lengths. With the short stump, the slow or hesitant walker, having limited use of the hip abductors and extensors, needs considerable alignment stability. The moderate walker, with stump of medium functional length, has average use of the hip abductors and extensors. Alignment for the long stump is for an active walker having good use of the hip abductors and extensors.

Figure 4.3.2

(From Radcliffe, 1955)

checks the following:

- a) Fit of the socket
- b) Height of the prosthesis
- c) Toe out
- d) Inclination and geometric layout of the leg
- e) That no undue pressure is applied to the stump due to the alignment of the prosthesis
- f) Knee stability.

Following static alignment, the prosthesis is dynamically aligned by the prosthetist. During dynamic alignment the prosthetist adjusts the configuration of the prosthesis to achieve minimum gait deviations, comfort, conservation of energy and gait symmetry.

4.4.1 GAIT DEVIATION

Considerable valuable information about the amputee and his prosthesis can be derived from careful observation of the gait pattern and from informed interpretation of what is seen. Gait deviations in the lower limb amputee can occur at various phases of walking cycle as follows:

- 1) Between Heel-Strike and Mid-Stance
- 2) At Mid-Stance
- 3) Between Mid-Stance and Toe-Off
- 4) During Swing phase.

Deviations of the Below-Knee Amputee

(Reference; Radcliffe and Foort, 1961)

1) Between Heel-Strike and Mid-Stance:

- a) Excessive knee flexion: this could be caused by excessive dorsiflexion of the foot (or excessive socket flexion), excessively stiff plantarflexion bumper (or heel cushion in SACH foot), excessive amount of socket forward set (ie. anterior displacement of socket over foot), flexion contracture or posterior misplacement of the suspension pivot.
- b) Insufficient or absent knee flexion: This could be caused by excessive plantarflexion of the foot, soft plantarflexion bumper of the foot, excessive posterior placement of the socket over the foot, weakness of the quadriceps muscles or it may be through habit.

2) Mid-Stance:

Excessive lateral thrust on the prosthesis may be due to:

- a) Excessive medial placement of the prosthetic foot (ie. foot set-in).
- b) Insufficient medio-lateral tilt of the socket.

3) Between Mid-Stance and Toe-Off:

- a) Early knee flexion (drop-off); causes are as follows:
 1. Excessive socket forward set.
 2. Toe brake on foot located too far posteriorly.

3. Excessive dorsiflexion of the foot (or excessive angle of flexion of the socket).
4. Soft dorsiflexion bumper.

b) Delayed knee flexion.

The reverse of the above situation would cause delay in knee flexion, in that the knee joint would remain in extension during the latter part of the stance phase.

4) Swing phase:

The main faults are:

- a) Piston action: Due to improper suspension or lack of socket fit.
- b) Circumduction: Due to either too long a prosthesis or the stump not fitting properly in the socket.
- c) Lateral or medial whip: Due to axis of the suspension pivot not being parallel to knee axis.
- d) Toe stubbing: Due to prosthesis being too long, foot dorsiflexed, suspension, or slippage.

Gait Deviations of the Above-Knee Amputee

(Reference; Radcliffe, 1968)

1) Between Heel-Strike and Mid-Stance:

- a) Lateral trunk bending: Caused by either too short a prosthesis, insufficient support by the lateral wall of the socket, abducted socket, weak abductors or pain.
- b) Abducted gait: caused by:

1. Long prosthesis.
 2. Shank aligned in valgus position with respect to the thigh section.
 3. Contracted abductors of the stump.
 4. Amputee feeling insecure, which is compensated by a widening of the walking base.
 5. Abduction of the socket due to a restraint by a mechanical hip joint.
- c) Rotation of the foot: caused by:
1. Too hard a plantarflexion bumper on heel cushion.
 2. Poor control of stump by socket.
 3. Correction after lateral whip.
- d) Foot slap: due to too soft plantarflexion bumper or heel cushion.
- 2) Mid-Stance to Toe-Off:
- a) Instability of the prosthetic knee caused by:
1. Positioning of the knee joint ahead of the trochanter-knee and ankle line.
 2. Insufficient flexion angle of the socket.
 3. Failure to limit dorsiflexion which could lead to incomplete knee control.
 4. Weakness in amputee's hip extension.
 5. Severe hip flexion contracture.
- b) Early knee flexion (Drop-off) may occur due to:
1. Inadequate limitation of dorsiflexion of the prosthetic foot.

2. The socket may have been placed too far anteriorly in relation to the foot.
3. The heel of the foot may be too low.

3) Swing Phase faults:

a) Circumduction may be due to:

1. Excessive knee friction.
2. Inadequate suspension.
3. Too small a socket, preventing the patient from getting into the socket properly.
4. Excessive plantarflexion of the foot.

b) Vaulting: ie. excessive plantarflexion of the sound foot during its stance phase in an attempt to provide greater lift of the body to obtain adequate ground clearance of the prosthesis during its swing; may be due to:

1. Excessive length of prosthesis.
2. Inadequate suspension.
3. Excessive knee friction.
4. Too small a socket.
5. Foot set in plantarflexion.
6. May be through habit.

c) Uneven heel rise; causes for excessive heel rise:

1. Insufficient friction on the prosthetic knee.
2. Absence of extension aid.
3. Forceful stump flexion.

Causes for insufficient heel rise:

1. Excessive friction on the prosthetic knee.
 2. Too tight an extension aid.
 3. Manual knee lock.
- d) Terminal swing impact; caused by:
1. Insufficient friction on the prosthetic knee.
 2. Too much tension on extension aid.
 3. Amputee's fear of knee buckling.
- e) Medial or lateral whip:
1. Internal rotation of knee bolt (causing lateral whip).
 2. Socket too tight or insufficiently contoured to accommodate muscles.
 3. Stump with weak musculature.

The following deviations can occur throughout the gait cycle of an above-knee amputee:

1. Uneven arm swing.
2. Uneven timing of steps.
3. Uneven length of steps.

4.5 MEASUREMENT OF ALIGNMENT

The orientation and position of the socket relative to the rest of the limb is one of the most essential parts of prosthetic alignment.

Minor alteration to the alignment can make all the difference between a prosthesis being totally acceptable or rejected by the amputee (Zahedi, 1982).

The non-geometrical shape of the socket has created problems in accurate alignment measurement. The first reported efforts in making repeatable measurements of socket alignment were carried out in the University of Strathclyde (Solomonidis, 1975). Repeatability was achieved by defining a unique axis system for the PTB socket, and this definition was later extended to the AK level (Lawes et al., 1975).

Basically, the technique involved the determination of the socket axes and then the measurement of the three dimensional geometrical relationship of these axes relative to the foot and knee.

To start with, a frame of reference was introduced to which all the measurements were referred. The reference system consists of a set of three orthogonal axes, shown in Figure (4.5.1), with its origin at the ankle joint centre. The ankle centre is arbitrarily defined as the centre of the bolt hole of the SACH foot. The top surface of the SACH foot is taken to form the X-Z plane, the Y axis being normal to it. For an AK prosthesis the ankle X reference is defined as a line which when viewed along the Y axis (in a downward direction, ie. from the knee to the foot) is perpendicular to the knee axis. The ankle Z reference axis forms the third axis of the right handed orthogonal system. In the case of the PTB prosthesis, the ankle X axis is taken to be parallel to the projection of the X socket axis onto the X-Z plane on the top surface of the SACH foot.

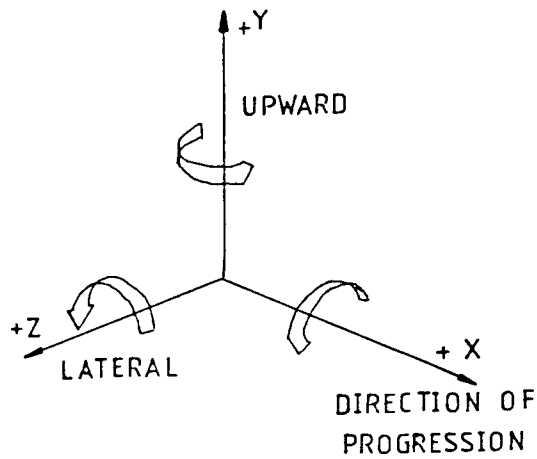

Cartesian Co-ordinate System
Ground Frame of Reference

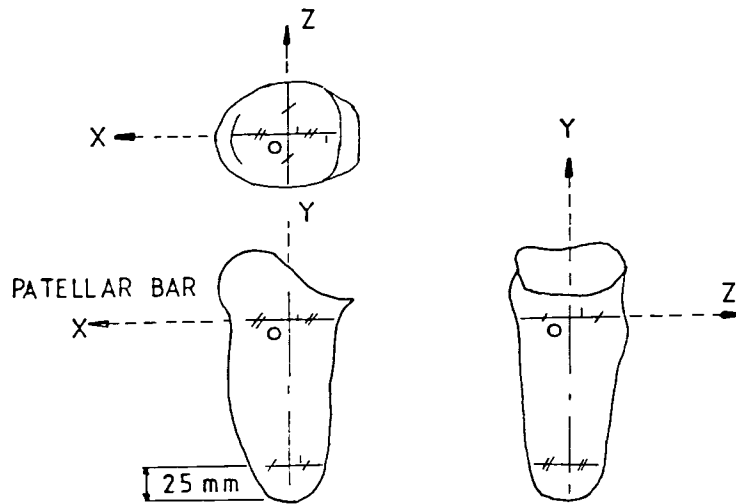

Socket Reference Frame below knee P.T.B

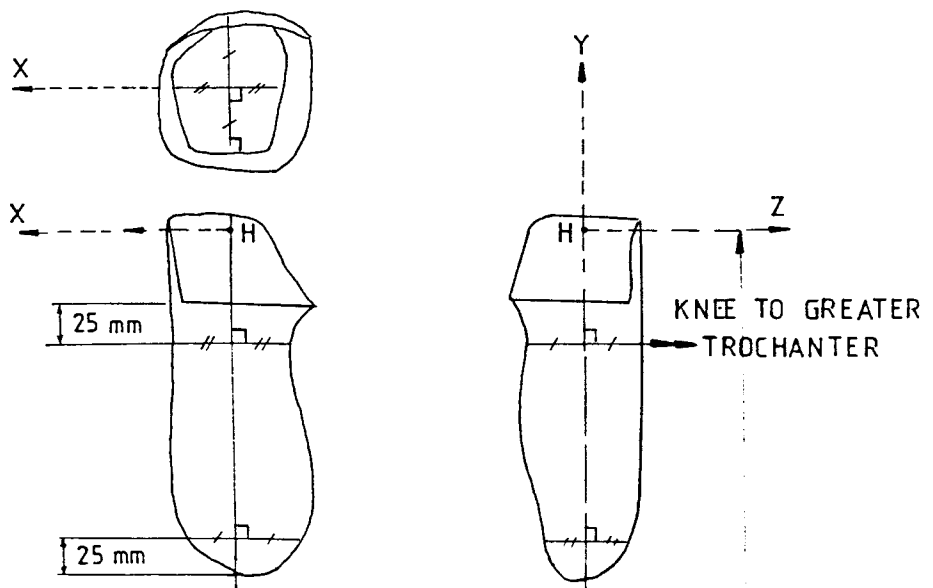

Socket Reference Frame above-knee quadrilateral

This ankle system XYZ, thus defined, is used as the main reference system for limb alignments and all salient points on the prosthesis are measured relative to this system.

The socket frames of references for the PTB and quadrilateral are defined as shown in Figure (4.5.2); ie. the Y axis being along the long axis of the socket, the X axis being directed forwards at right angles to the posterior brim of the PTB socket or parallel to the medial brim for the quadrilateral socket. The Z axis is chosen to form a right handed orthogonal system. Detailed descriptions of socket axes definitions for the PTB and quadrilateral are given in Solomonidis (1975 and 1980) and Berme et al. (1978).

In order to facilitate in the measurement procedures, special equipment was constructed. The original methods, however, utilised an iterative approach for determining the socket axes. This although accurate was time consuming. When the "study of alignment" project was undertaken in the Bioengineering Unit it became necessary to measure a large number of prosthetic alignments. In order to speed up the process a special device for determining the socket axes "The socket axes locator", (SAL) was devised (Purdie, 1977 and Berme et al. 1978). This was further developed by Szulc (1983).

The limb is held securely in a jig shown in the

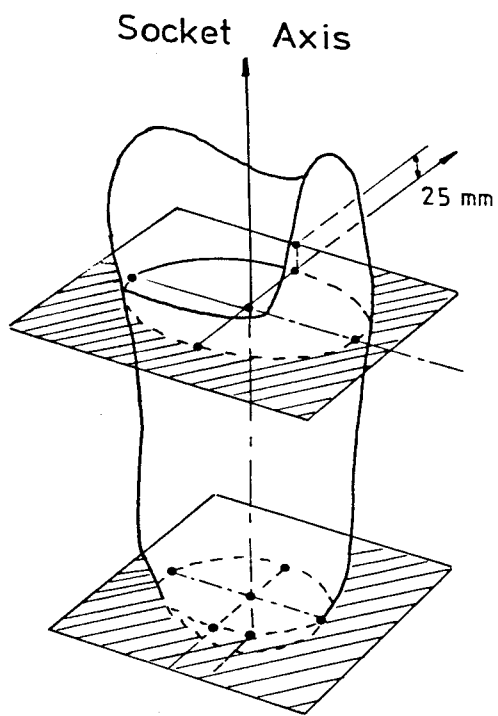

Figure (4.5.2) Three Dimensional Isometric View of PTB Socket

photograph, Figure (4.5.2) by means of the foot bolt (once the socket axes reference points have been marked on the inner surface of the socket). The SAL is positioned into the socket and the reference points are marked on its inner surface. The SAL is then removed and the coordinates of the various points are measured using a grid, height guage and ruler arrangements. Figure (4.5.3) shows the jig, SAL and other measuring devices. From these measurements the following alignment parameters may be computed:

BK Alignment Parameters

1. Angle of socket flexion
2. Lateral tilt
3. Socket forward set
4. Foot set in
5. Length of shank
6. Toe-out angle.

AK Alignment Parameters

1. Prosthetic foot toe-out
2. Prosthetic knee:
 - set back
 - height
 - set out
 - M/L tilt
3. Socket:
 - forward set
 - height
 - set out
 - flexion
 - lateral tilt
 - rotation.

(Reproduced from Solomonidis 1975 and 1980).

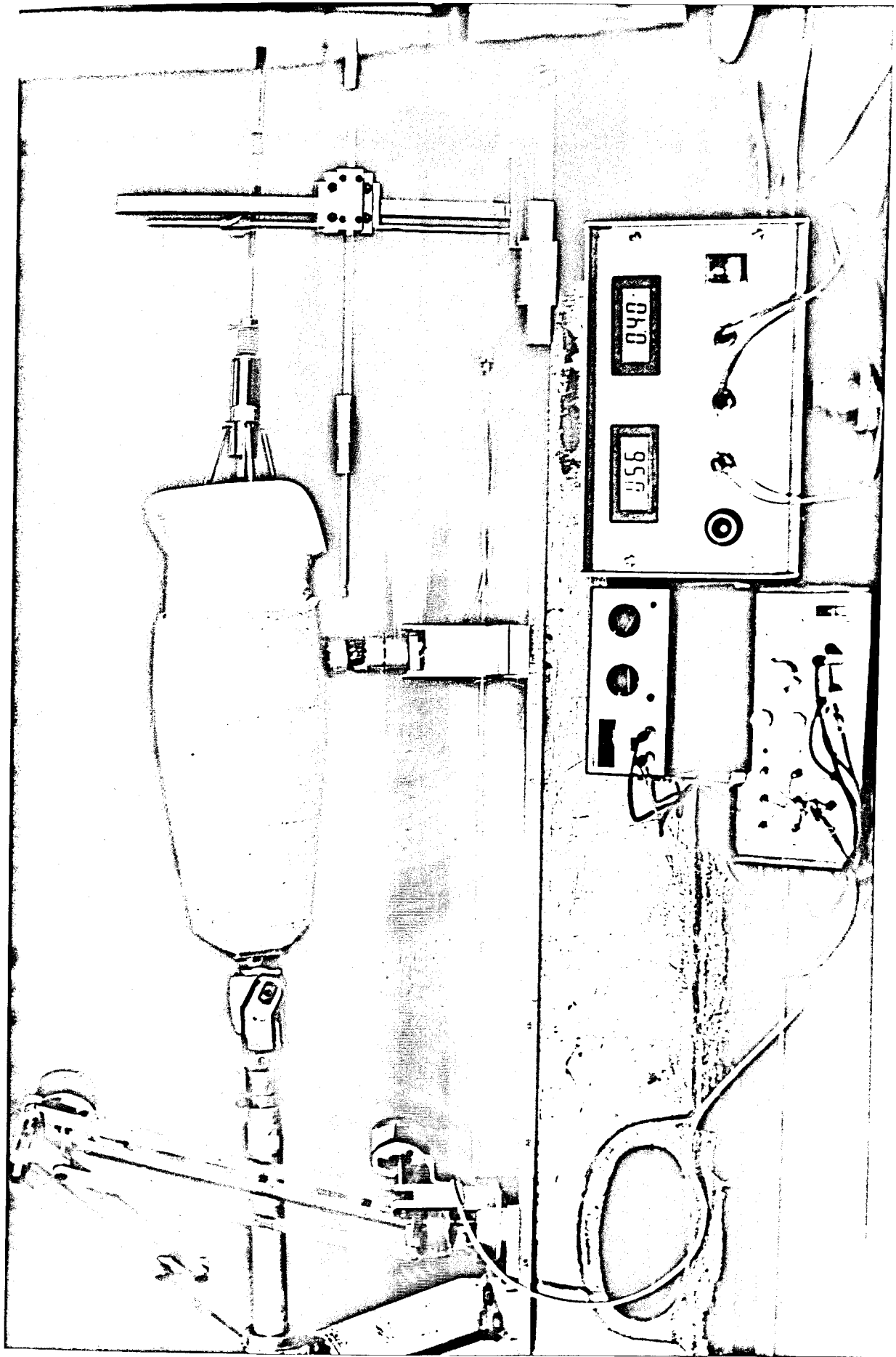

Figure 4.5.3 Alignment Measuring Equipment Developed in the Bioengineering Unit

CHAPTER 5

METHODOLOGY

- 5.1 Introduction.
- 5.2 Patient Profiles.
- 5.3 Prosthetist Profile.
- 5.4 Protheses.
- 5.5 Experimental Set-up.
- 5.6 Marker Positioning.
- 5.7 Test Procedure.
- 5.8 Digitization.
- 5.9 Data Reduction and Preparation.
 - 5.9.1 The Program Flow Chart.
 - 5.9.2 Calculation of the Coordinates of the Markers, Program: "COORDINATE".
 - 5.9.3 Calibration, program: "CALIBRATION".
 - 5.9.4 Parallax Correction, Program: "PARALLAX".
 - 5.9.5 Digital Filtering of Data, Program: "FILTER".

- 5.9.6 Calculation of Coordinates
of Joint Centres, Program:
"JOINTS".
- 5.9.7 Program: "ANGLES".
- 5.10 Correction for Phase
Difference.

5.1 INTRODUCTION

In an attempt to measure kinematic parameters of amputee gait, and to detect gait deviations due to various alignment configurations, three dimensional cine photography was used.

Markers were placed at reference points to identify joints and segments and their movements were recorded by three 16mm Bolex cameras running at 50 frames per second. The films were developed, the markers digitized and the data stored in an ICL 1904S computer.

After data processing, ie., calibration, parallax correction and filtering, the calculated X,Y,Z coordinates of the joint centres were used to produce Ankle/Knee and Knee/Hip angle - angle diagrams in the anterior-posterior plane, stick diagrams in the sagittal plane and ankle, knee and hip angle-time diagrams. Although velocity and acceleration data were also derived, the inherent measurement errors made differentiation procedure inaccurate and this information is therefore not presented.

As already stated in the introduction of this thesis, in Chapter 1, this project was part of a larger study on "Alignment of lower limb prostheses". Prior to commencement, the patients had already been selected and were participating in other aspects of the study. The experimental prostheses had already been constructed, fitted and used by the patients.

5.2 PATIENT PROFILES

Five below-knee and five above-knee male amputees participated in this study. In this section a short summary of their particulars is given. For the profile of the patients the reader is referred to Zahedi (1984).

TABLE 5.2.1 BELOW-KNEE AMPUTEE

Patient	Year of birth	Year of amputation	Cause of amputation	Side of amputation	Condition of stump
BRØØ1	1926	1952	Trauma	Right	Good
BRØØ2	1914	1964	R.T.A.	Right	Good
BLØØ3	1935	1967	Trauma	Left	Good
BRØØ4	1921	1944	Trauma	Right	Good
BLØØ5	1936	1971	Trauma	Left	Good

TABLE 5,2,2 ABOVE-KNEE AMPUTEE

Patient	Year of birth	Year of amputation	Cause of amputation	Side of amputation	Condition of stump
ALØØ1	1933	1957	Trauma	Left	Good
ARØØ2	1925	1944	Trauma	Right	V.Good
ARØØ3	1936	1962	R.T.A.	Right	V.Good
ARØØ4	1920	1953	R.T.A.	Right	Good
ARØØ5	1929	1966	Trauma	Right	Good

5.3 PROSTHETIST PROFILE

Three experienced prosthetists were involved in fitting the patients. Table (5.3.1) lists the profile of the three prosthetists. It must be mentioned that Prosthetist 1 was involved in approximately 80% of the fittings for establishing a range of acceptable alignments.

TABLE 5.3.1 PROSTHETISTS INVOLVED IN FITTING THE PATIENTS

Prosthetist No.	Experience (years)	Professional qualification	Alignment unit preferred
1	8	H Dipl.(P/O) M.Sc.	Berkeley/ Bock
2	20+	L BIST	HOSMER
3	20+	F BIST	-

5.4 PROSTHESES

Due to the complexity of the Alignment Study, it was of great importance to impose maximum possible control over all the variables involved during the patient test trials (Zahedi, 1984).

All the limbs were of the Otto Bock Modular assembly prosthesis type. This system was particularly suitable, because it provides a wide range of alignment adjustment, and is fairly simple to construct and use.

For the purpose of patient testing all the below-knee patients were fitted with patellar tendon bearing type sockets with supracondylar strap suspension. Figure (5.4.1) shows a below-knee experimental prosthesis.

After setting the prosthesis to the recommended bench alignment as suggested by Radcliffe and Foort (1961), see section 4.3, it was dynamically aligned by the prosthetist. Dynamic alignment of the prosthesis can be carried out by "tilting" the socket and foot relative to the shin tube in the anterior-posterior (A/P) and medio-lateral (M/L) planes.

External or internal rotation of the foot was made by rotating the shin tube to the required angle (see Figure(5.4.1)).

The above-knee amputees were fitted with quadrilateral total contact suction sockets and uniaxial knee mechanisms. Figure (5.4.2) shows a typical above-knee experimental prosthesis.

After the bench alignment, the prosthesis was dynamically aligned by the prosthetist. Dynamic alignment could be made by rotating all the components of the prosthesis relative to each other in both the A/P and M/L planes.

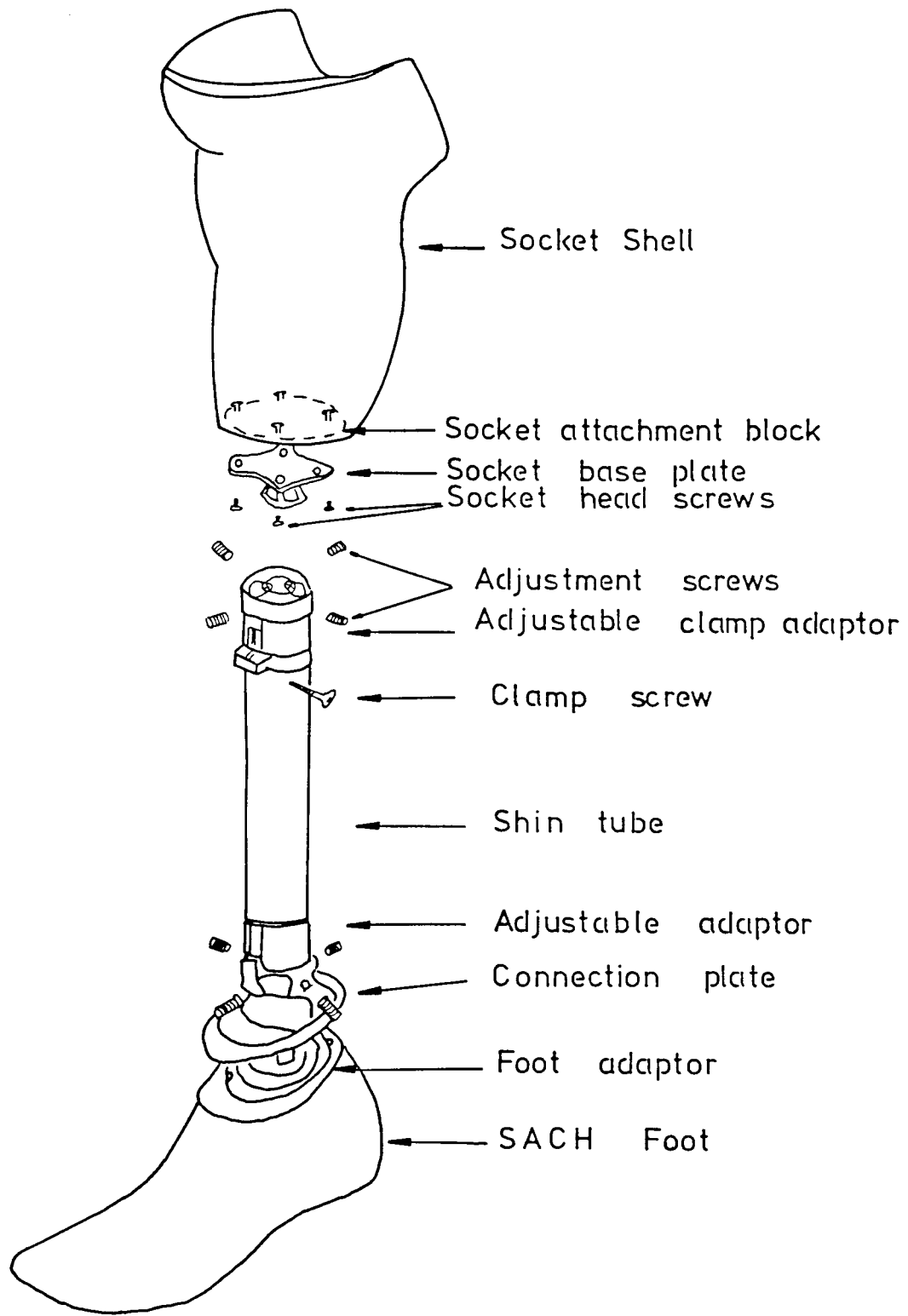

Figure 5.4.1 B-K Experimental Prosthesis.
 (Redrawn from Solomonidis, 1975)

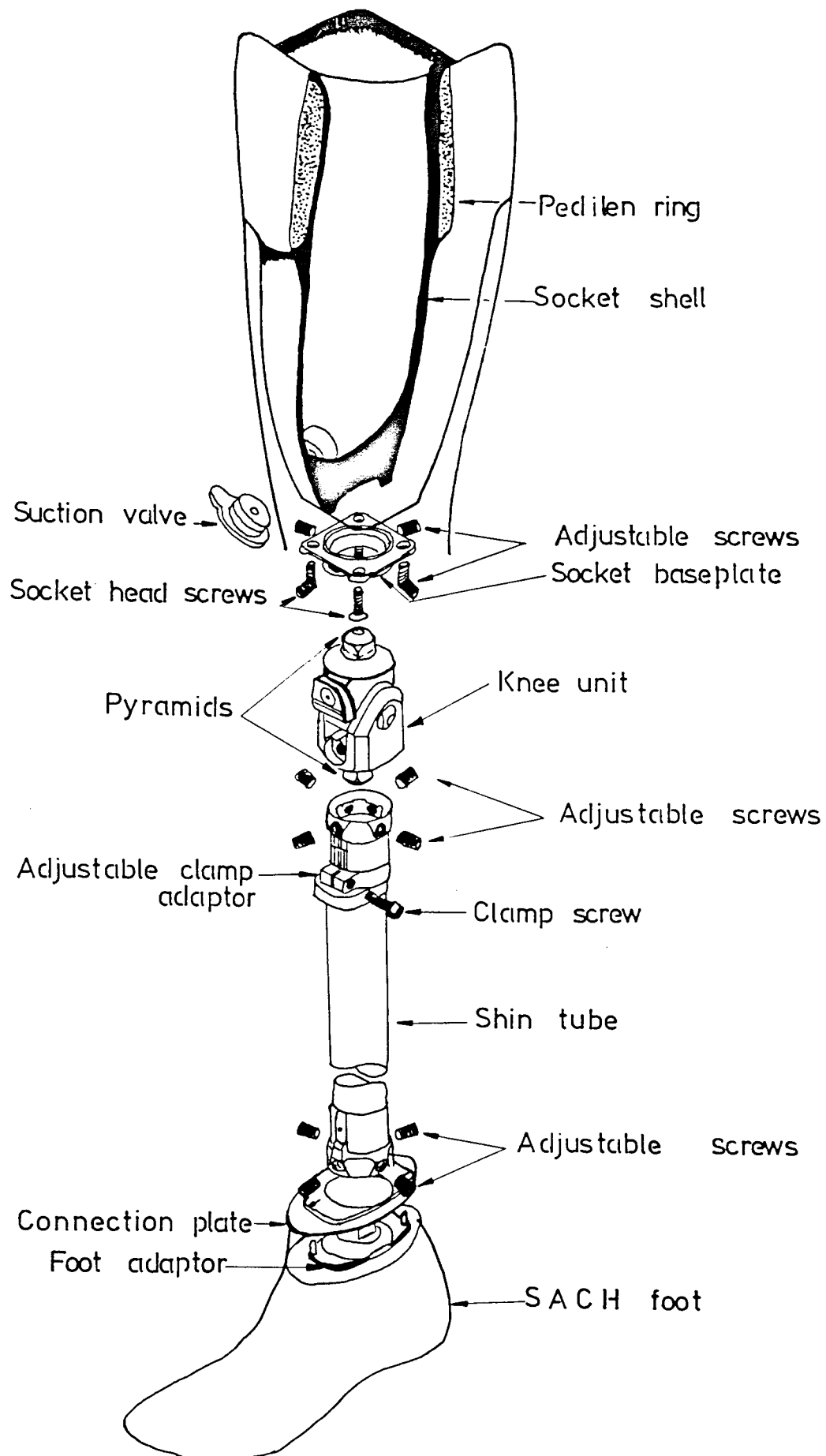

Figure 5.4.2 A-K Experimental Prosthesis
 (Redrawn from Solomonidis, 1980)

5.5 EXPERIMENTAL SET-UP

In order to quantify any gait deviations and to detect changes in the kinematic parameters of the amputees' gait with varying alignments, three dimensional cine-photography was employed. The desirable characteristics of this system, the provision of a complete visual image and interpolation of possible obscured markings, compensated for a very tedious and time-consuming data recovery procedure.

Figure (5.5.1) illustrates the overall laboratory arrangement for the above recording system. This arrangement consisted of a walkpath, 20 meters long, three cine cameras and a set of overhead flood lights. The height and position of the lights were adjusted to give a uniform distribution of light over the test area. The three cameras used were of Bolex H16 type and the films were 16mm "Kodachrome 40" colour films. Each camera was driven by a synchronous motor at 50HZ through a gear ratio of 8:1, thus providing a shutter frequency of 20ms per frame. The shutter was set at a speed of $\frac{1}{125}$ of a second, that is the shutter stays open for 8ms of the 20ms duration.

The height of the camera and the distance of each to the origin of the ground frame system of reference is shown in Figure (5.5.2).

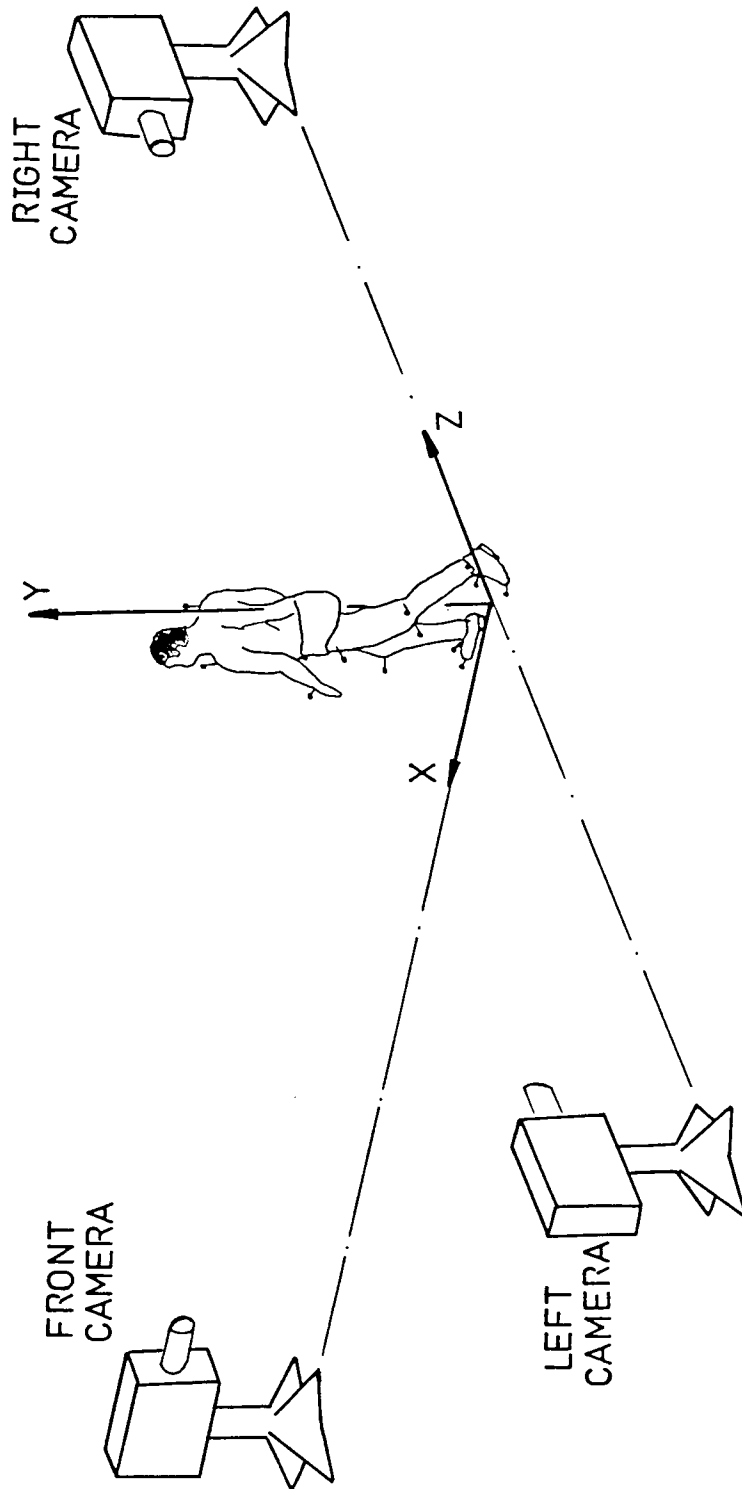
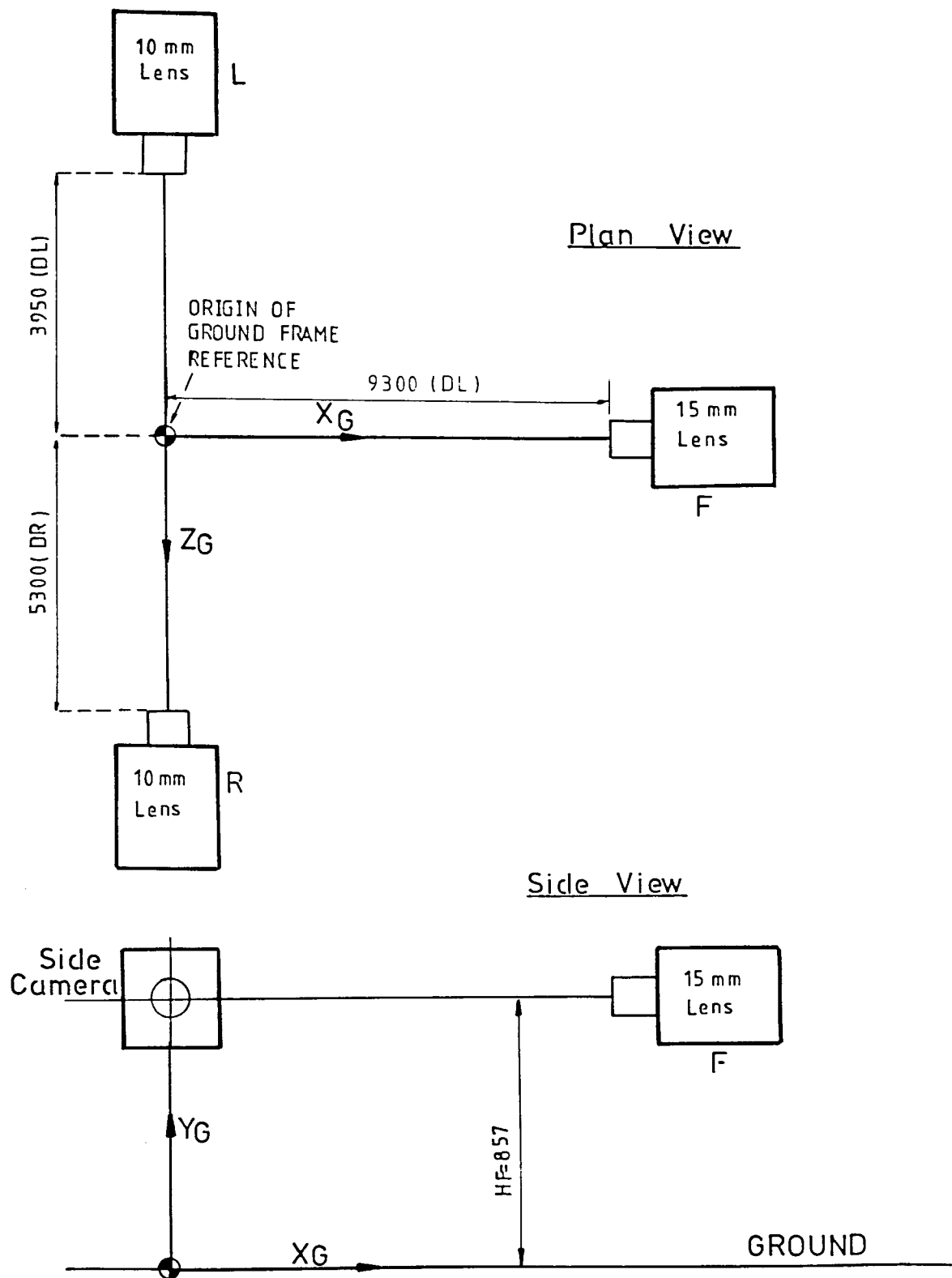

Figure 5.5.1 Diagrammatic Illustration of Cinecameras



$$HF = HL = HR = 857$$

Dimensions in mm.

Figure 5.5.2 Arrangement of Cinecameras.

(Redrawn from Goh, 1982)

A single filament flash bulb was used for synchronising the three cameras. The flash unit carried a test number display card, and was positioned in such a way that it was visible to all the three cameras. The films were then re-exposed to a grid board which acts not only as a system of reference but also provides means of calibrating the data and ensuring its accuracy. This will be discussed in more detail in section 5.9.3.

5.6 MARKER POSITIONING

The markers placed on the anatomical landmarks were very light bright yellow spherical plastic beads each attached to a black hemispherical wooden base. In order to locate the coordinates of joint centres, it is very important to position the body markers with extreme care on an appropriate place. Two points should be borne in mind when choosing the marker site:

- (1) Minimal skin movement
- (2) Easily recognisable area by palpation.

As shown in Figure (5.6.1) bony prominences were considered to be appropriate sites to allow joint centres to be determined.

For the prosthetic foot, the markers were placed so as to correspond to those of the natural foot. For the below-knee prosthesis, the position of the knee joint was directly transferred onto the socket outer surface, and

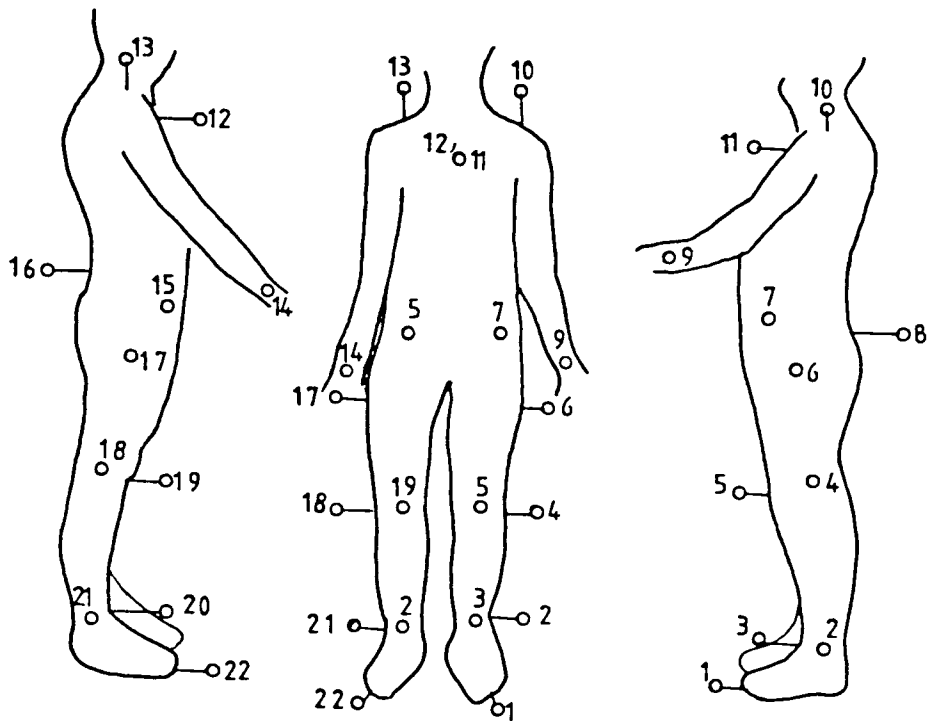

Figure 5.6.1 Marker Positions.

Right		Left
1	Toe	22
2	Lateral malleolus	21
3	Anterior centre of the ankle joint	20
4	Fibula head	18
5	Tibial tuberosity	19
6	Greater trochanter	17
7	Anterior-superior iliac spine	15
8	Pelvic tail	16
9	Ulnar styloid	14
10	Acromion process	13
11	Sternum	12

for the above-knee prosthesis the frontal and lateral sides of the prosthetic knee joint centre was defined as the positions for the prosthetic knee joint markers. Figure (5.6.1) shows a diagrammatic representation of a subject with a full set of markers, as well as a list of descriptions of the markers' locations and the numbering system.

The numbering system of the markers is necessary for the analysis. The same marker positioning and numbering system was used throughout the entire analysis.

5.7 TEST PROCEDURE

With all the overhead flood lights adjusted and switched on, the three cameras were focussed, using a marker placed at the centre of the ground frame of reference. The aperture on the front camera was set at "f 1.5" and the side cameras were set at "f 2.0". All the cameras were then switched onto "Remote", ready for operation. The flash bulb and test number display card unit was placed approximately so that it could be viewed by the three cameras without obscuring the subjects' walking.

The patient was then fitted with the experimental prosthesis and body markers were placed onto the anatomical landmarks using double-sided adhesive tape (refer to section 5.6). The prosthesis was then

dynamically aligned by the prosthetist until optimum alignment was achieved and the patient was allowed to walk freely inside the laboratory before the test walk was recorded by the cameras. When the patient was ready, the test number was displayed and the flash unit was prepared. The patient was then asked to walk straight forward towards the front camera. Shortly afterwards the cine cameras were switched on and just as the patient cleared one full cycle the flash bulb was fired.

This procedure was repeated for several test runs. The test runs included walking with optimum alignment at different walking speeds, with several controlled mal-alignments, and walking with the amputee's own prosthesis.

When all the test walks had been filmed, the three cameras were rewound to their starting point. A grid board was positioned in front of each camera in turn, with its origin coinciding with the origin of the ground frame of reference. Each camera was operated manually and the films were re-exposed to incorporate the grid board.

Finally, the following body measurements and marker distances were recorded:

- a) Body weight
- b) Height
- c) SS-Distance between the anterior-superior iliac spines

- d) RST - the distance between right anterior-superior iliac spine to pelvic tail
- e) LST - the distance between left anterior-superior iliac spine to pelvic tail
- f) Knee width
- g) Shoulder to shoulder - distance between the acromion processes
- h) Width of shoulder
- i) Foot length
- j) Width of ankle
- k) Distance between knee joint centre and the greater trochanter.

5.8 DIGITIZATION

Digitization of the cine films was carried out using a Calcomp 9000 electromagnetic digitizer. The digitizer was connected to a PDP 11/34 digital computer. Digitization was done by placing a cursor over the centre of the marker bead on an activated digitizer surface. The coordinates of the marker were then registered into a digital output by pressing a button on the cursor panel.

The sequence with which body markers were digitized was from the lowest marker number to the highest marker number on a particular frame (see section 5.6). The first two points digitized on every frame were calibration markers on the calibration board. The total number of markers digitized per frame from the front camera was 11.

Digitization was performed at three frames intervals, since it was thought that this would be sufficient for the purpose of this study. Four "dummy" frames were added to the beginning and end of each digitized file to allow for the phase difference between the three frames and for the purpose of the digital filtering process.

5.9 DATA REDUCTION AND PREPARATION

The kinematic data obtained by digitizing the cine films had to undergo several steps of calculation and correction before useful detailed analysis could be carried out. A systematic method of numbering the body markers for the digitization and a procedure for collecting the data in a PDP 11/34 digital mini computer was established.

The raw displacement data were then entered into an ICL 1904S main frame computer for performing the various calculations and final presentation of the results. Modified versions of existing programs that were available in the Bioengineering Unit were used for the analysis. The original programs were developed by Goh (1982) in order to obtain the kinematic and kinetic parameters of the body and lower limbs for the purpose of studying the performance of various types of prosthetic feet. When the project of "Study of Alignment" was undertaken, several adaptations of these basic programs were carried out. These modifications are described in Zahedi (1984).

Once the raw displacement data is input into the ICL 1904S computer, they are processed and rationalized using the programs named "COORDINATES", "CALIBRATION", "PARALLAX", and "FILTER". Next the three dimensional coordinates of the joint centres and direction cosine matrices of the joint axes are calculated using program "JOINTS". The intersegmental angles are calculated using program "ANGLES". Finally the results are presented in tabular and graphical form using the programs "WALK", "ANGLE PLOT" and "AN ANGLE PLT".

"Header file" containing statements are also input with the raw data into the ICL 1904S computer. These files contain additional parameters required for the calculation, eg. number of frames to be analysed, body segment parameters, amplifier gain, correction factor for camera phase differences (see section 5.10).

The available computer programs (Goh, 1982) sequentially provided the following outputs:

1. Coordinates of markers
2. Calibration
3. Parallax correction
4. Filtering of the data
5. Calculation at joint centres
6. Calculation of the intersegmental angles
7. Plots of the joint trajectories in the
Sagittal plane

8. Plots of the angle-time diagram for hip, knee and ankle
9. Plots of the ankle/knee and knee/hip angle-angle diagrams.
10. Calculation of linear and angular velocities and accelerations.

The following sections give an explanation of the data processing techniques together with a brief description of the relevant programs.

5.9.1 THE PROGRAM FLOW CHART

The following shows the sequence of the program in flow chart which was provided and used throughout this investigation:

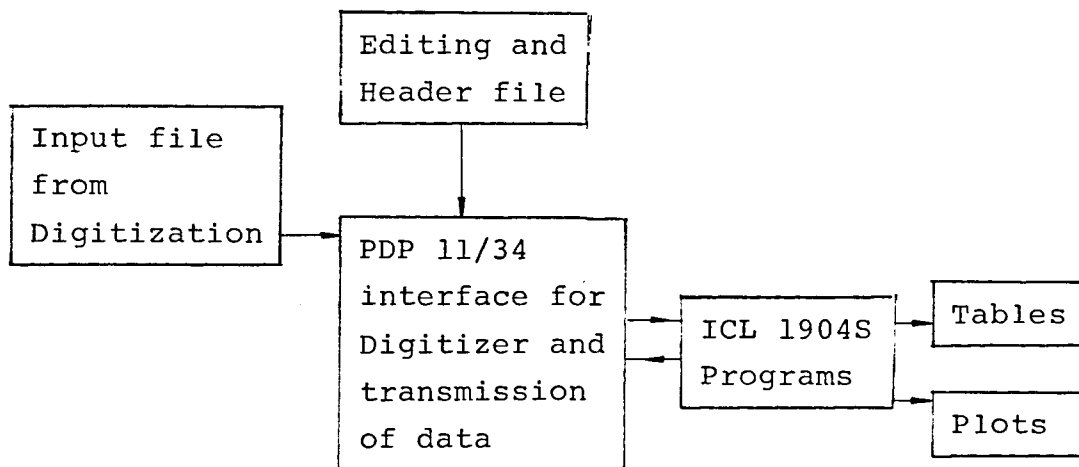

The programs and their names, the first four characters were used for the name of macro for running the jobs i.e., RUNCOOR and also the macro for chain processing was used.

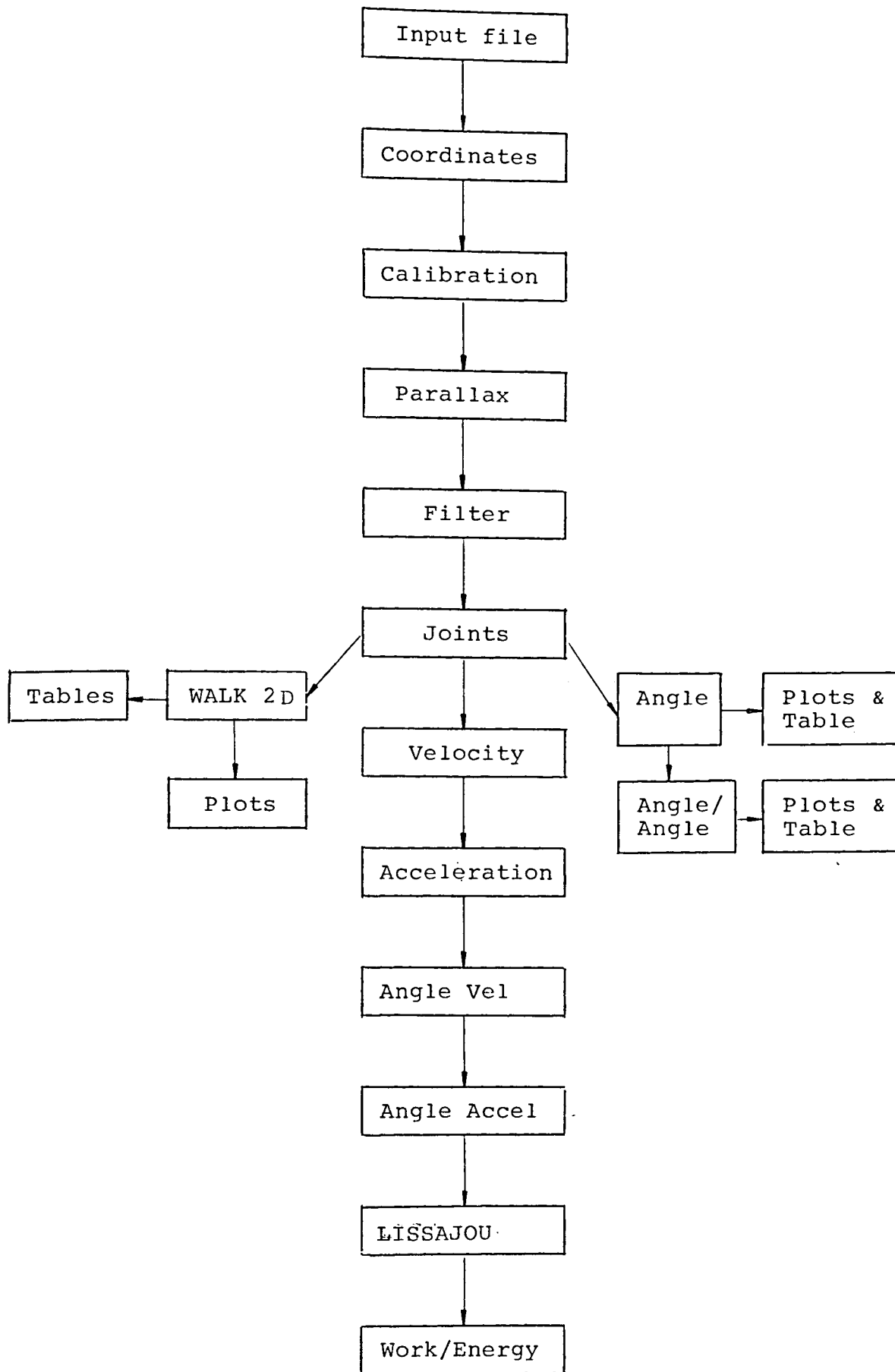

5.9.2 CALCULATION OF THE COORDINATES OF THE MARKERS, PROGRAM "COORDINATE".

"Coordinates" Program is the first stage of the program which reads and calculates the raw displacement data from the digitizer output. This program performs the following functions:

- (1) Scaling the marker coordinates to real units and transforming them to relate to the ground frame of reference.
- (2) Correcting the phase difference between film frames of the camera.

The output file contains the X,Y,Z coordinates of the markers, sequentially numbered as digitized.

5.9.3 CALIBRATION, PROGRAM "CALIBRATION"

As referred to in section 5.7 a grid board was used after the completion of each test to aid the following functions:

- a) Transformation of digitized coordinates to the reference axis system.
- b) Scaling them to real dimensions.
- c) Minimising distortion caused by projection of the film onto the digitizing table.

The formulation of the scaling factor was obtained by marking two points (A & B) on the grid board with known coordinates with respect to the board's frame of

reference system (see Figure (5.9.3.1)). These two points were then digitized in each film frame, so that a relationship between the digitized coordinates and the actual dimensions could be obtained. This can be expressed as:

$$F = \frac{L_{AB}}{\sqrt{(X_t(A) - X_t(B))^2 + (Y_t(A) - Y_t(B))^2}}$$

where

L_{AB} = Actual distance between A and B.

X,Y = Horizontal and vertical axes.

A,B = Calibration points on the grid board.

t = Suffix denoting digitized coordinates.

The marking of these two calibration points on the grid board also accounts for the linear displacement of the projected image of each frame on the digitizing table. However, for eliminating the effect of the rotational displacement of the projected image, its angular orientation with respect to the digitizing table axes must be accounted for in the calculations.

The procedure and mathematical manipulations needed to transform the digitized coordinates to the reference system, scaling them to the actual dimension and eliminating the rotational effect are detailed in Goh (1982).

Outline of Digitizing Table

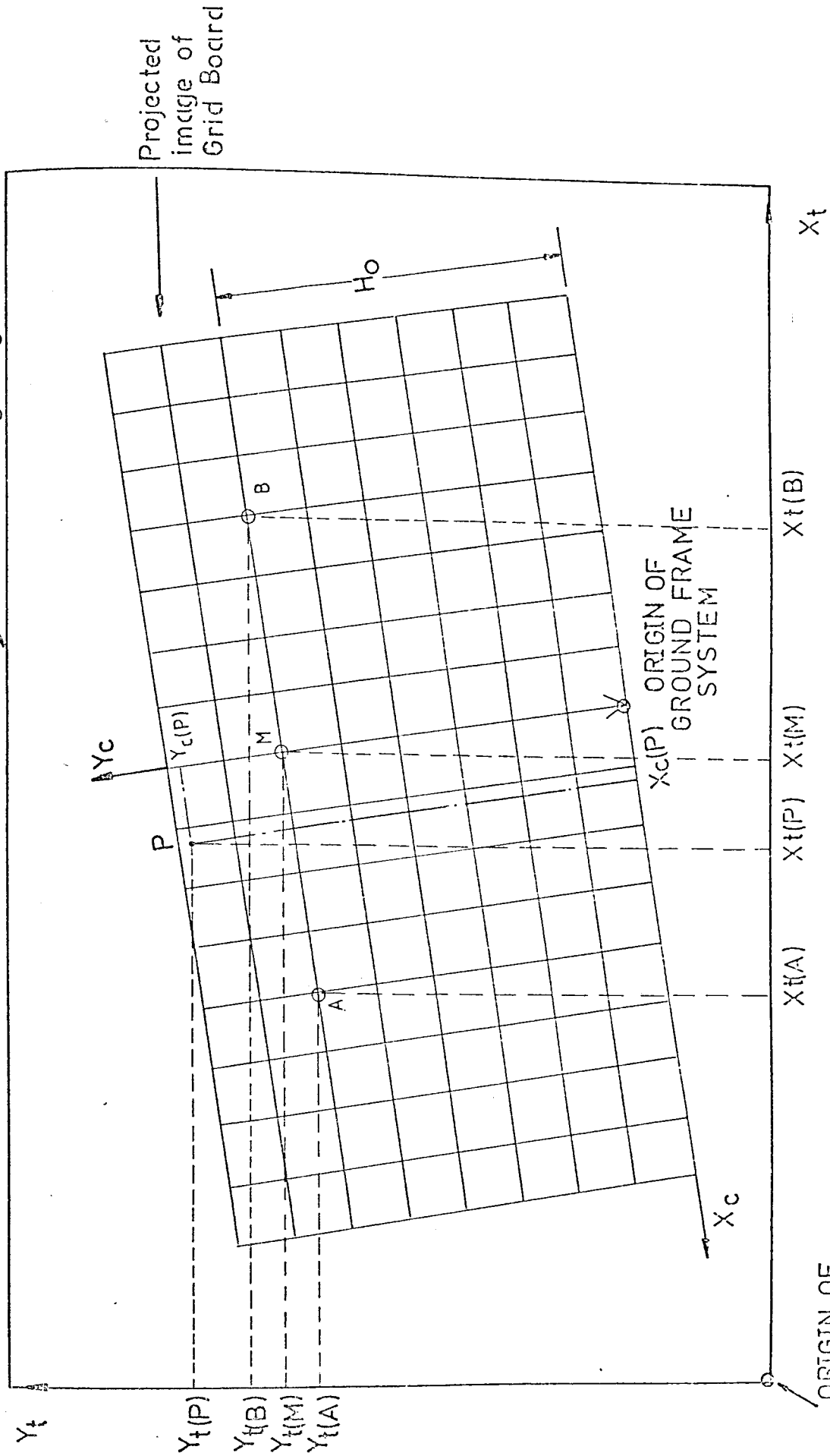

Figure 5.9.3.1 CALIBRATION SYSTEM (Redrawn from Goh, 1982)

ORIGIN OF DIGITIZING TABLE

5.9.4 PARALLAX CORRECTION, PROGRAM: "PARALLAX"

The parallax errors contained in the digitized coordinates of the markers are due to perspective effects of the cine photography technique.

Goh, (1982), described a mathematical procedure which allows for this type of error. Hence the true coordinates of a marker can be obtained from a set of equations. These so called "parallax" equations are derived using similar triangles as shown in Figure (5.9.4.1).

Equations have also been derived to allow the determination of the true coordinates at the markers in cases where the marker could not be seen by one or more of the cameras. For details of the mathematical procedures the reader is referred to Goh (1982).

5.9.5 DIGITAL FILTERING OF DATA, PROGRAM "FILTER"

The random errors, "noise" contained in the displacement data are mainly introduced by either the operator or the equipment. Examples of these could be the vibrations of the camera during operation or the non-linearity in the operation of the digitizer and so on. It has been shown by Goh (1982) that this generated noise is of high frequency.

A suitable technique was therefore required to remove this from the kinematic data if accuracy of

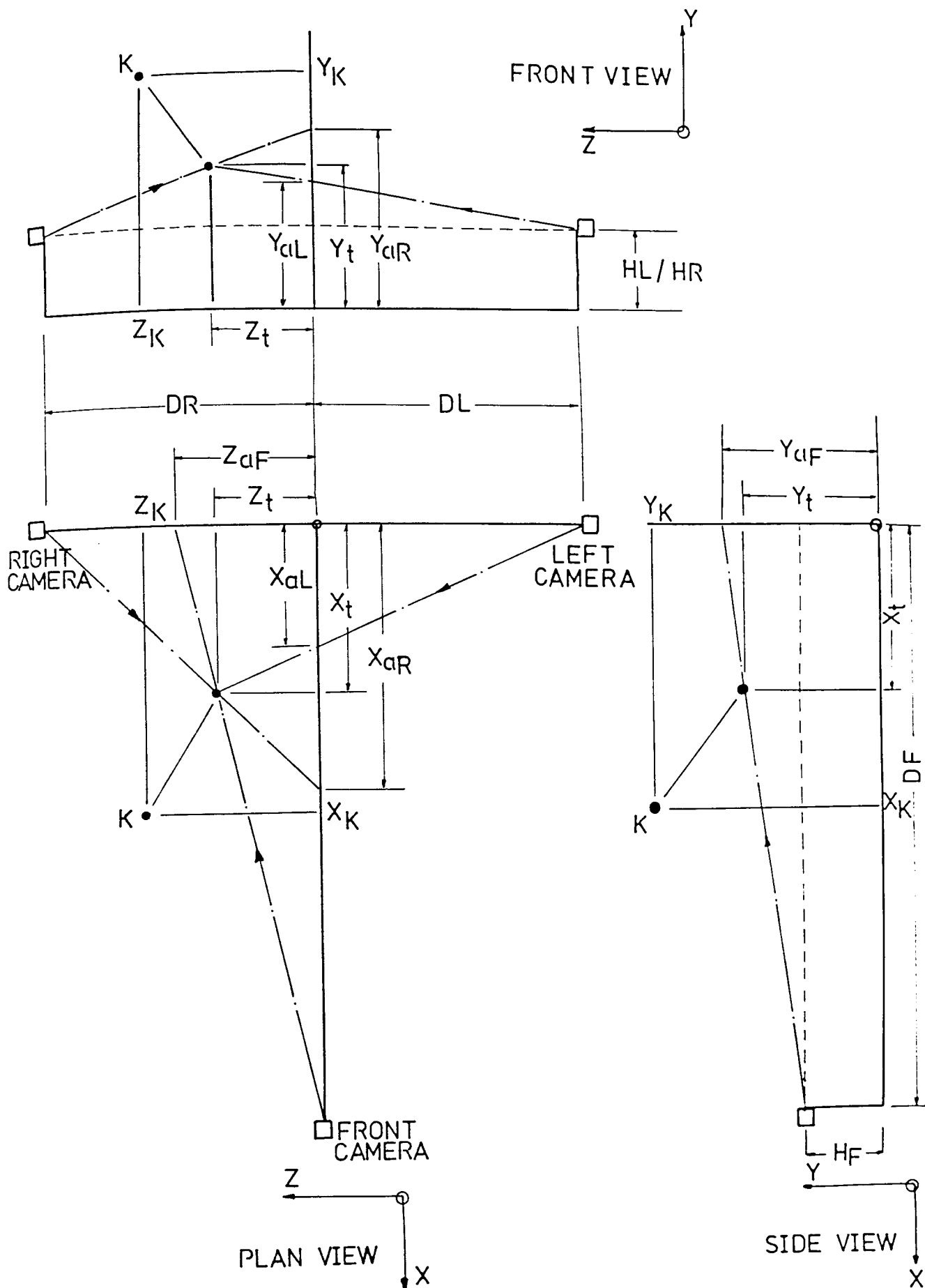

Figure 5.9.4.1 PARALLAX CORRECTION

(Redrawn from Goh, 1982)

dynamic calculations is desired. Andrews et al (1981) has described several methods to achieve this accuracy. The method used in this project was the "Keiser window digital filter".

5.9.6 CALCULATION OF COORDINATES OF JOINT CENTRES PROGRAM "JOINTS"

At this stage, the data consist of calibrated, corrected for parallax and filtered X,Y,Z coordinates of the markers together with all measurements for the body parameters.

For reference positions where no joint centre was required, such as the wrist, toe and the shoulder, that are defined by a single marker, correction can be made by subtracting the distance of the bead to the base of the marker, d , see Figure (5.9.6.1).

For joints such as the ankle and knee, the reference position was defined by two markers. In this case the tilt of the joint was first calculated to obtain distances d_1 and d_2 . The joint centre was calculated using the markers coordinates A and B and distances d_1 and d_2 , see Figure (5.9.6.2).

The hip, pelvic tilt and anterior-superior iliac spine markers, were used to define the three dimensional position of the pelvis. This involved a "fairly" complex

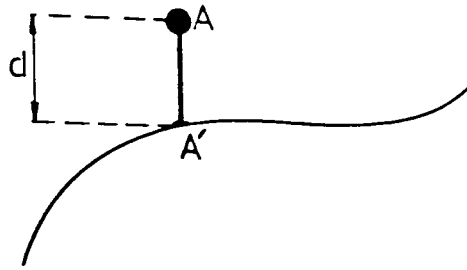

- A - Marker Bead
- A' - Base of the Marker
- d - Distance from A to A

Figure 5.9.6.1 Representation of a joint centre defined by a single marker.

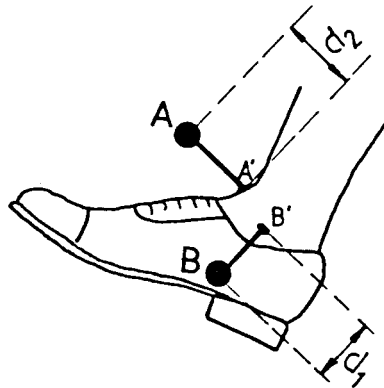

- A - Marker Bead (front)
- B - Marker Bead (side)
- A' & B' - Base of Markers A and B respectively
- d1 & d2 - Distance from B to B' and A to A' respectively

Figure 5.9.6.2 Representation of a joint centre defined by two markers.

computer program. For further details of this calculation refer to Zahedi (1984).

At this stage the program outputs the X, Y, Z coordinates of all joint centres for the entire gait cycle.

5.9.7 PROGRAM "ANGLES"

This stage of the program calculates the angle of the knee, hip and ankle throughout the full body gait cycle. Figure (5.9.7.1) shows the angles α , β and γ in the A/P and M/L planes, which are calculated using the X, Y, Z coordinates of the three joint centres. Furthermore, the stride of each side is calculated and the distance covered in the direction of progression is normalized in the percentage of gait cycle.

5.9.8 PLOTTING AND OUTPUT FILE. PROGRAMS "WALK", "ANGLE PLOT", "AN ANGLE PLT"

At this stage, the two dimensional view of the body is plotted in the A/P plane. The stick diagrams are produced by joining the joint centres and plotted against the normalized distance to the percentage of the cycle.

The angle versus time of each joint, ankle angle versus knee angle and knee angle versus hip angle diagrams are plotted and relevant tables for these results are output.

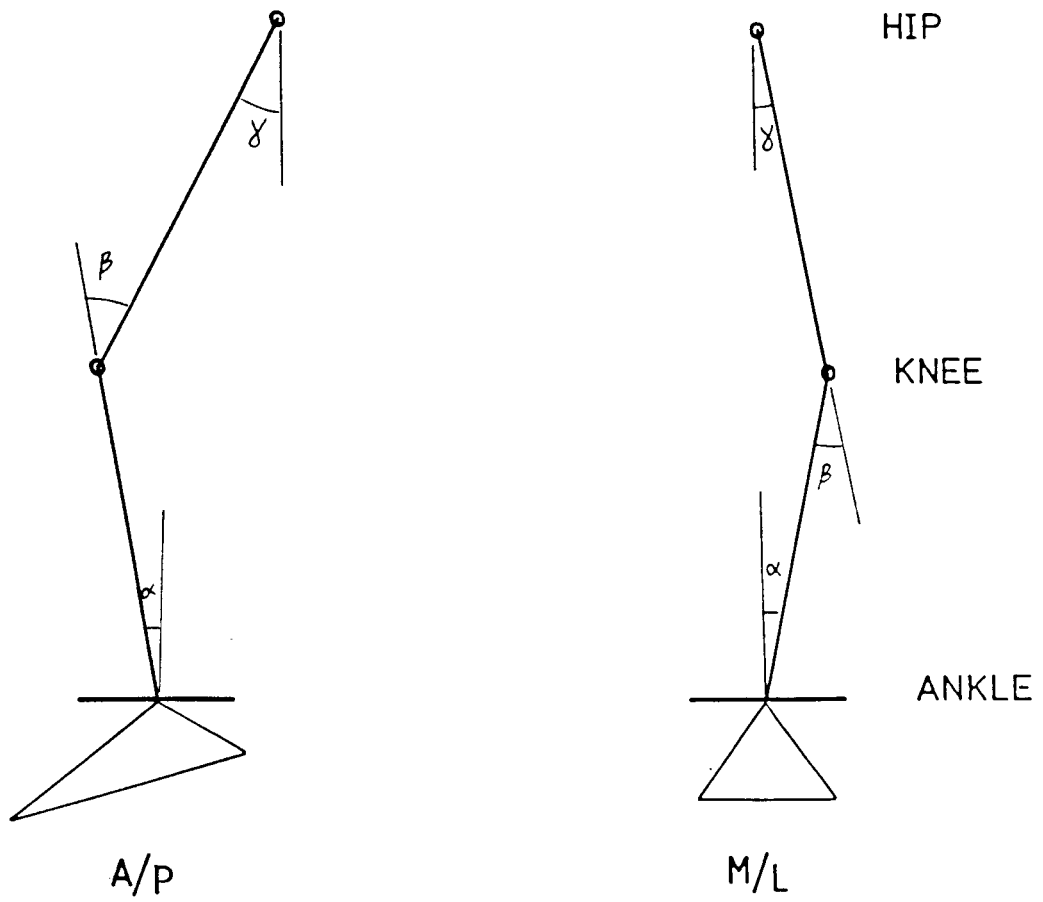

Figure 5.9.7.1 Definition of intersegmental angles.

5.10 CORRECTION FOR PHASE DIFFERENCE

As mentioned in section 5.5 the flash bulb was used to synchronise the three cameras. However, it was clear from the films that the intensity of the flash varied in the three cameras at a certain instant of time. This indicated that the three cameras did not operate synchronously.

By comparing the intensities of the flash in three sequential film frames from the three cameras, the leading camera could be identified and the phase correction factor of the other two cameras could be estimated, relative to the leading camera, see Figure (5.10.1). To allow for the phase error, one additional frame was added to the beginning of the required cine film's length.

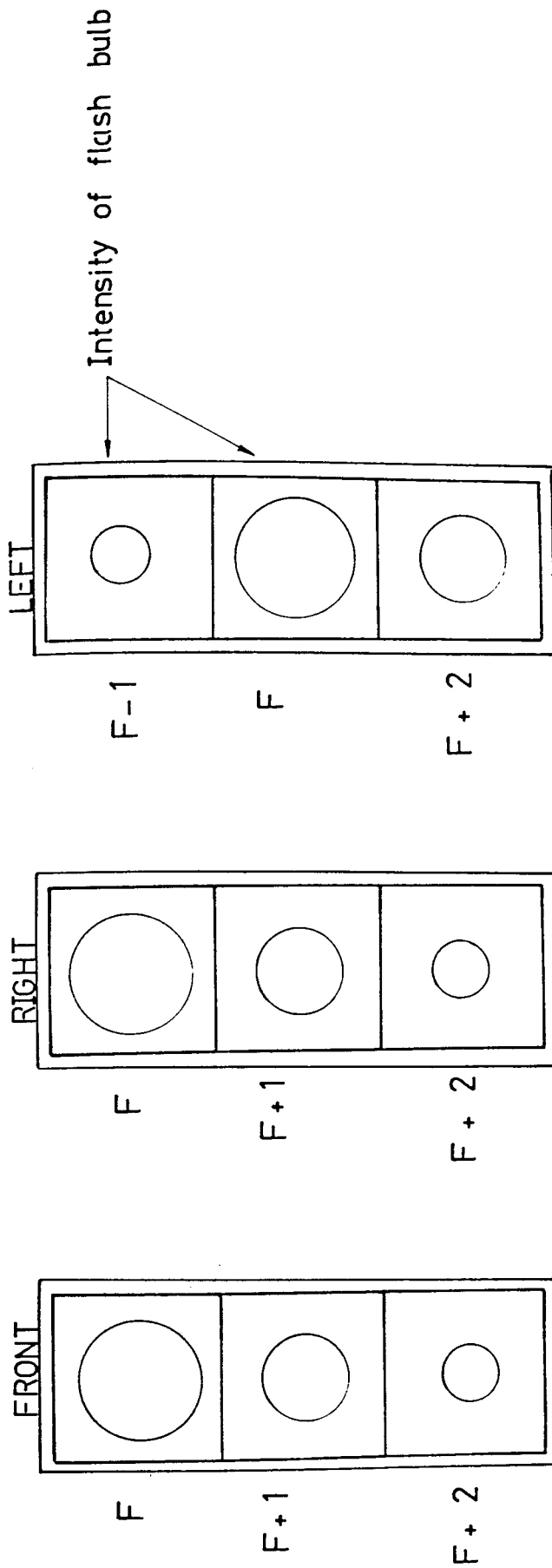

Figure 5.10.1 PHASE CORRECTION

Assuming that the front and right cameras are leading, the phase lag at left camera to right and front camera is 20 ms.

CHAPTER 6

RESULTS AND DISCUSSION

- 6.1 Introduction.
- 6.2 Repeatability of the Kinematic and Temporal Parameters.
- 6.3 Experimental Accuracy
- 6.4 Effect of Various Acceptable Alignments on Amputee Gait Pattern.
- 6.5 Effect of Various Controlled Mal-alignments on Amputee Gait Pattern.
- 6.6 Effect of Various Speeds of Walking on the Amputee's Gait Pattern and the Temporal Parameters.
- 6.7 Assessment of Various Optimum Alignments.
 - 6.7.1 Below-knee Amputee.
 - 6.7.2 Above-knee Amputee.

6.1 INTRODUCTION

As mentioned earlier altogether ten patients (5 BK and 5 AK), were involved in this study. Fitting and alignment was done by three prosthetists. Each patient was fitted with one socket throughout the entire study.

The following parameters under optimum alignment and controlled mal-alignment conditions were considered:

- (1) Ankle, knee, hip and shoulder joint trajectories in the sagittal plane (stick diagram).
- (2) Angle-time diagrams for the hip, knee and ankle joints.
- (3) Knee angle versus hip angle diagrams in the anteroposterior plane.
- (4) Temporal parameters.

Although the importance of velocity and acceleration in the study of amputee's gait are well recognised, the inherent errors in acquiring the velocity and acceleration data, using displacement-time measurements were so high that there was no point in investigating these quantities. Maximum errors of up to 50% were apparent.

Although every attempt was made to maintain the conditions under which each test was carried out constant, many factors that affected the amputee's gait pattern were to a great extent uncontrollable, e.g. psychological effects, physiological effects and variations in the amputees' preferred speed of walking. The latter meaning that the amputee may vary his walking speed with various

alignments. Psychologically, it is felt that some patients, because of their awareness of being under "test conditions", may not have displayed their "normal" gait. Another factor relates to the characteristics of the walking surface. The tests were performed on a "linoleum" surface. It is probable that surfaces like soft carpets, grass or sand could influence the walking pattern.

In this chapter the effect of various optimum alignments and controlled mal-alignments are compared and discussed considering one BK and one AK patient for each case. Certain aspects of the results obtained from the other patients are also discussed.

6.2. REPEATABILITY OF THE KINEMATIC AND TEMPORAL PARAMETERS

Figure (6.2.1) (Goh, 1982), shows the trajectories of the ankle, knee, hip and shoulder joint centres of a normal subject. Altogether seven test walks are superimposed on the same graph. The envelope which covers the variation is referred to as the repeatability band. On a normal subject the range of scatter in the trajectories is, on average, approximately $\pm 1.5\text{cm}$. This is due to inherent errors in the recording and the data reduction system and also covers the uncontrollable step to step variation. However, the overall differences in the trajectories are insignificant and follow the same pattern reported by other investigators, (Murray et al., 1964). Figure (6.2.2.) (Goh, 1982) shows the repeatability band for the hip, knee and ankle joint angle-time diagrams for the normal subject. As can be seen, there are no significant differences between

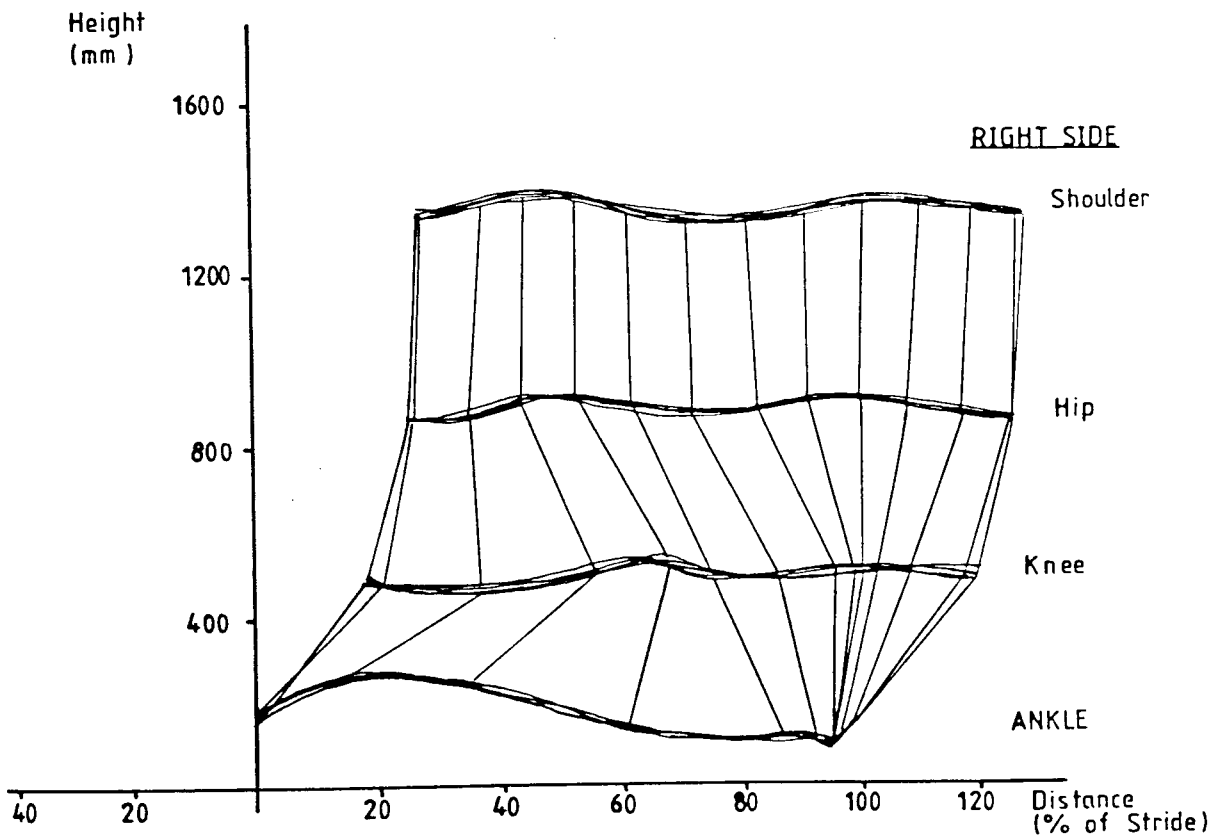
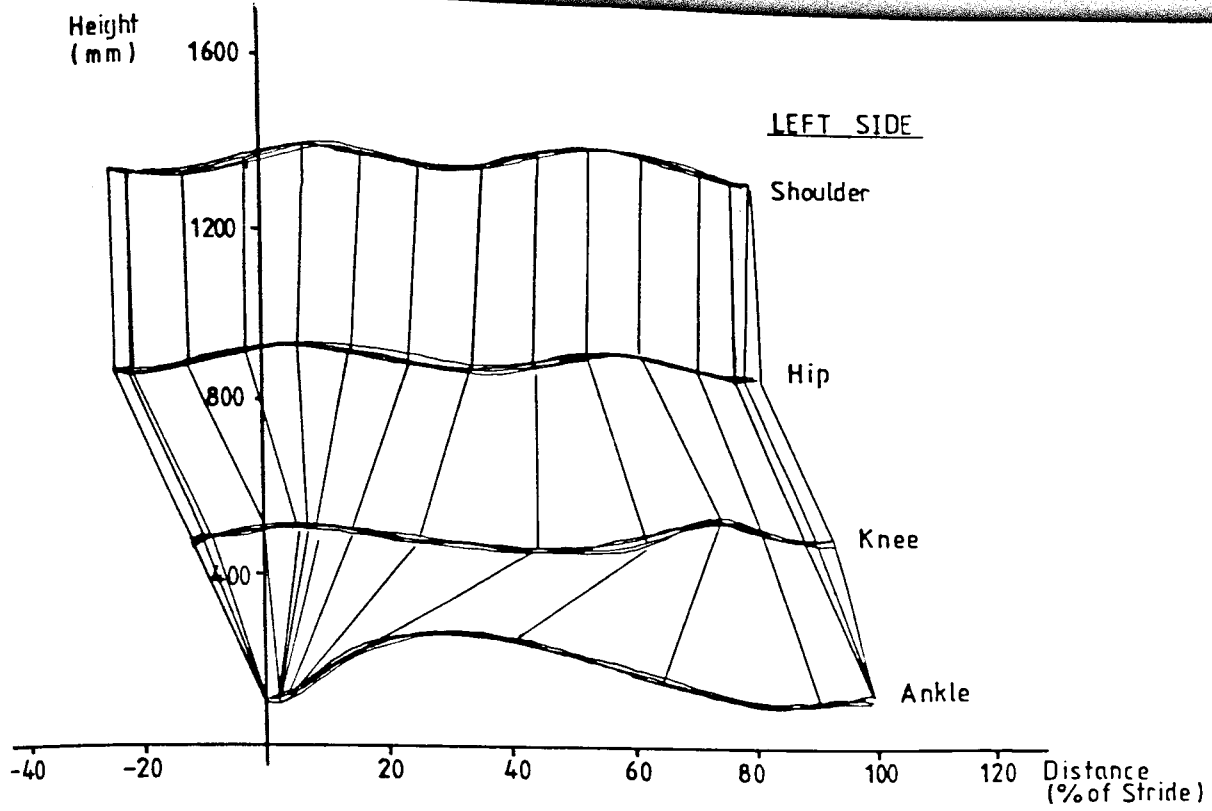

Fig.(G.2.1) Stick Diagram of Normal Subject

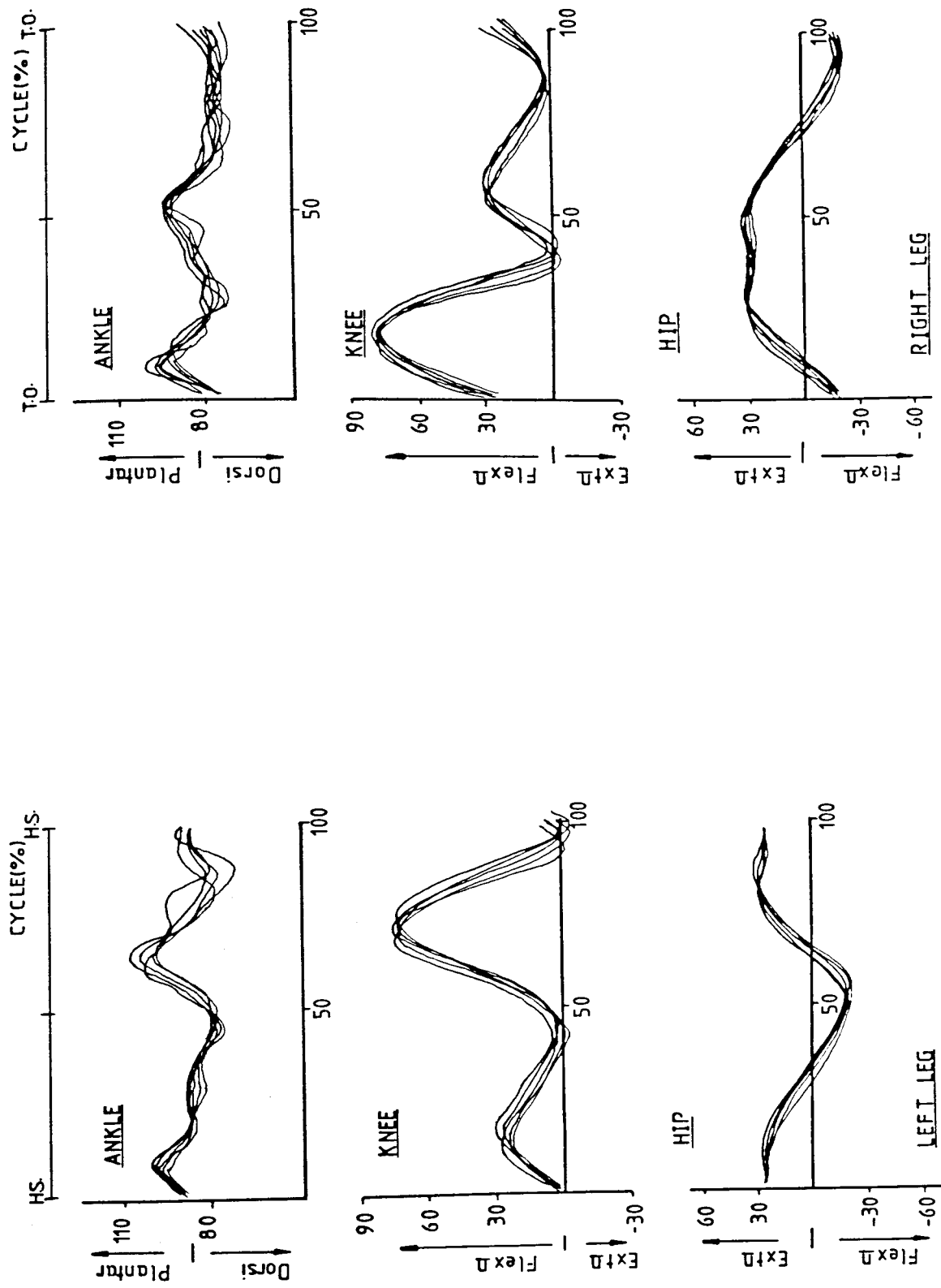

Fig.(6.2.2) Angle-Time Diagrams of Normal Subject
(Redrawn from Goh, 1982)

the magnitudes and patterns of the curves. The repeatability band of the data presented is approximately ± 7 degrees on average. When the temporal parameters of the normal subject were considered, the repeatability band for speed of walking covered a range of ± 0.08 m/s. Similarly on average the Swing to Stance duration ratio was within ± 0.025 (Goh, 1982).

Consideration of the performance of BK amputees showed that the repeatability range in the trajectories of the joints was about ± 1.6 cm. and the angle-time range of scatter was ± 8 degrees. The speed of walking varied within ± 0.09 m/s, with an average Swing to Stance ratio in the range of ± 0.04 .

For the above-knee amputee the range of scatter for the prosthetic side was slightly higher than that of the sound side and that of the below-knee amputee. It was found that for the above-knee amputee, the repeatability range was patient dependent. Thus, it is not possible to make general statements as in the case of the BK amputee given above. The reader is referred to Zahedi (1984). On the repeatability of the kinematic parameters of the amputee, Zahedi (1982) found that the step to step variation of the amputee is higher than that of the normal subject. He also found that the uncontrollable step to step variation varied between individuals. To overcome this problem, it was suggested that several runs of each "test situation" should be recorded, so that the degree of repeatability could be quantified for any one patient in any one situation.

6.3 EXPERIMENTAL ACCURACY

One of the main disadvantages of the cine-photographic technique is that it requires human intervention throughout the data collection and data recovery procedures. This inevitably introduces errors.

Errors also arise from the measuring instruments and the analytical procedure. These errors remain constant within certain limits throughout the entire study. Positioning and repositioning of the markers is a major source of human error. Positioning can be difficult, especially if there are no reference points or surfaces on the normal or artificial limb. Another source of error lies in the rotational oscillations of the shutter disc when the camera is running, the shifting of the film, frame speed and shutter frequency. Distortion of the projected image, which can result either from the camera or the projector lenses, distorted mirror and film distortion can also greatly affect the accuracy of data. This could in turn be intensified by misplacement of digitizer cursor over the marker beads.

The errors due to inadequate synchronization of the three cameras and lack of accurate knowledge of the phase lag of one camera to another can also affect the results. Errors in positioning of the calibration board, and relative positions of the body to the cameras were another source of experimental error.

Although the above sources of error were minimised by using parallax correction, phase lag correction and appropriate calibration technique, the analytical part of the study introduced additional errors: in the joint axis calculation, hardware error from plotting equipment and other errors.

A detailed error analysis to quantify the individual errors outlined above was not carried out. Several previous workers attempted this exercise (Paul, 1967; Philipens, 1981; Goh, 1982).

Philipens (1981) carried out experiments in order to establish the overall accuracy of the system (ie. from data collection to the final analysis) using a calibrated space frame. He reported that the coordinates of a marker may be determined to an accuracy of ± 1.5 cm.

6.4 EFFECT OF VARIOUS ACCEPTABLE ALIGNMENTS ON AMPUTEE GAIT PATTERN

6.4.1 STICK DIAGRAM

Figures (6.4.1.1a & b), show the stick diagram of a below-knee amputee, walking with two different optimum alignments.

Comparison between shoulder trajectories of the sound side on alignment 1 and 2, indicates that the trunk is

Patient: BL005-Prosthetic

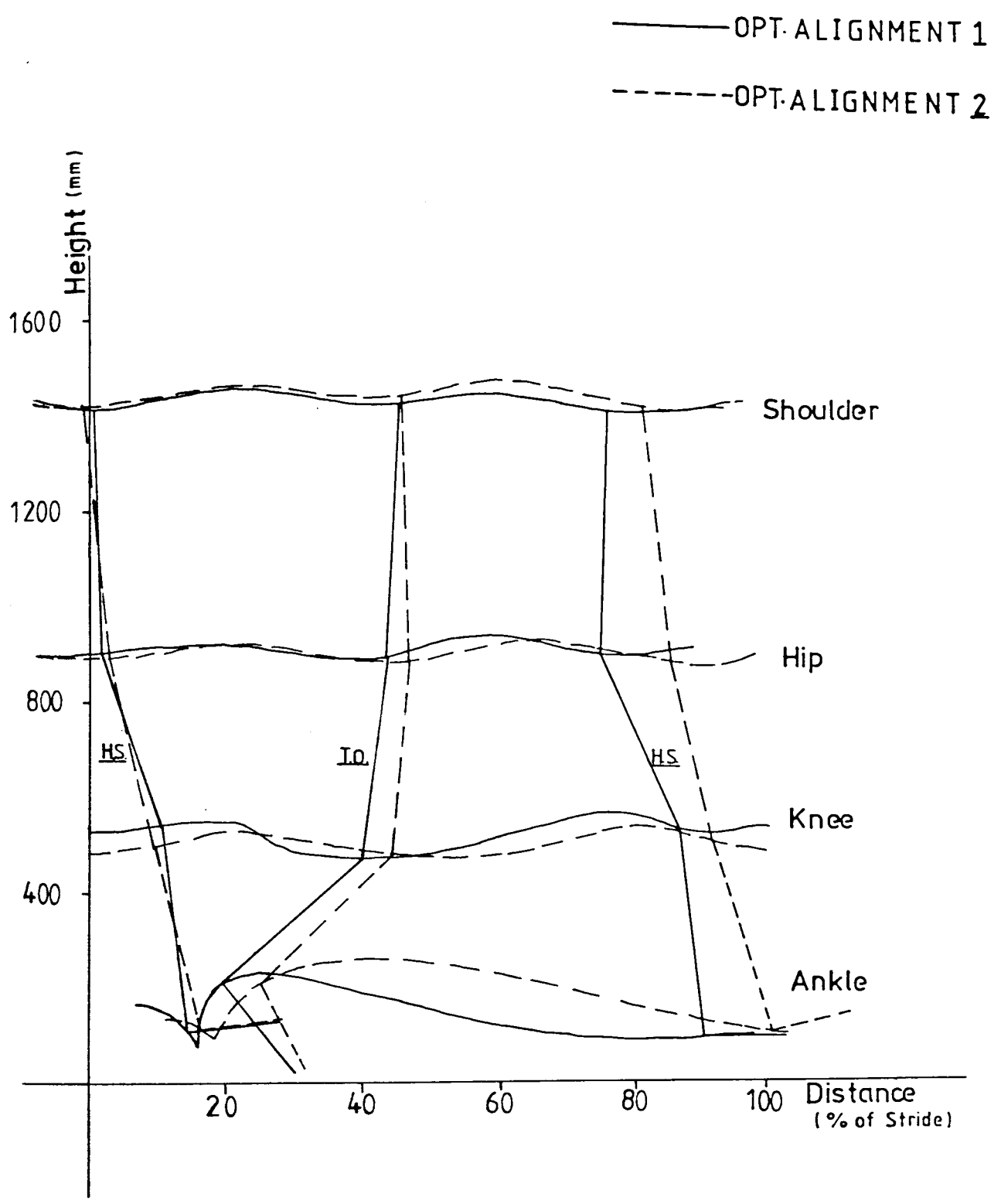

Fig. (6.4.1.1 a) STICK-DIAGRAM

Patient: BL005-Sound

— OPT.ALIGNMENT 1

- - - OPT.ALIGNMENT 2

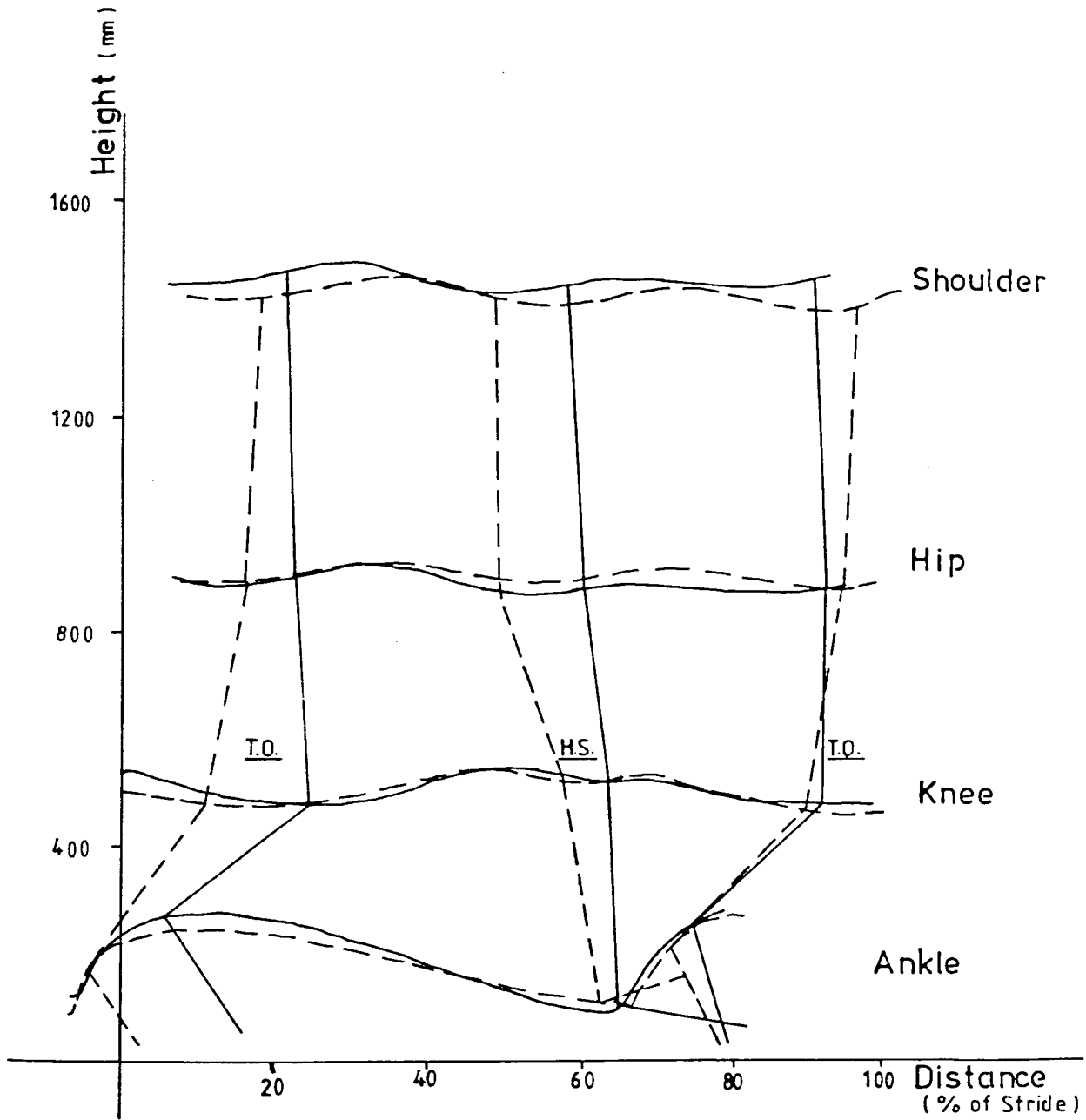

Fig.(6.4.1.1b)STICK-DIAGRAM

tilted backwards more than for alignment 2. This is taking place basically during the swing phase of the sound limb and may be due to the amputee compensating for stability (caused by the difference in alignment) by shifting the trunk (and the centre of gravity). The tilt of the trunk could also be due to the body preparing the sound side for its forward swing during the prosthetic stance phase, and ensuring that the trajectory of the body is such that it can be continued by the prosthetic side to initiate swing.

However, the ankle, knee and hip trajectories of the sound side, for either of the optimum alignments compare well with each other. On the prosthetic side, a significant decrease in the height of the trajectory is seen with alignment 1, and a sharp variation in the knee trajectory during the prosthetic stance phase. However, the shoulder and hip trajectories of alignment 1 correspond to those of alignment 2.

Figures (6.4.1.2a & b) show the stick diagram for an above-knee amputee, walking under two different optimum alignments. The trajectories of the hip and shoulder on the sound side show the two peak patterns. The peak associated with stance phase has higher (about twice) amplitude than that of the BK amputee. The first peak is due to "vaulting" on the sound foot to provide clearance for the prosthesis; the second peak is due to "pole vaulting", on a locked knee prosthesis.

Patient: A R 005-Prosthetic

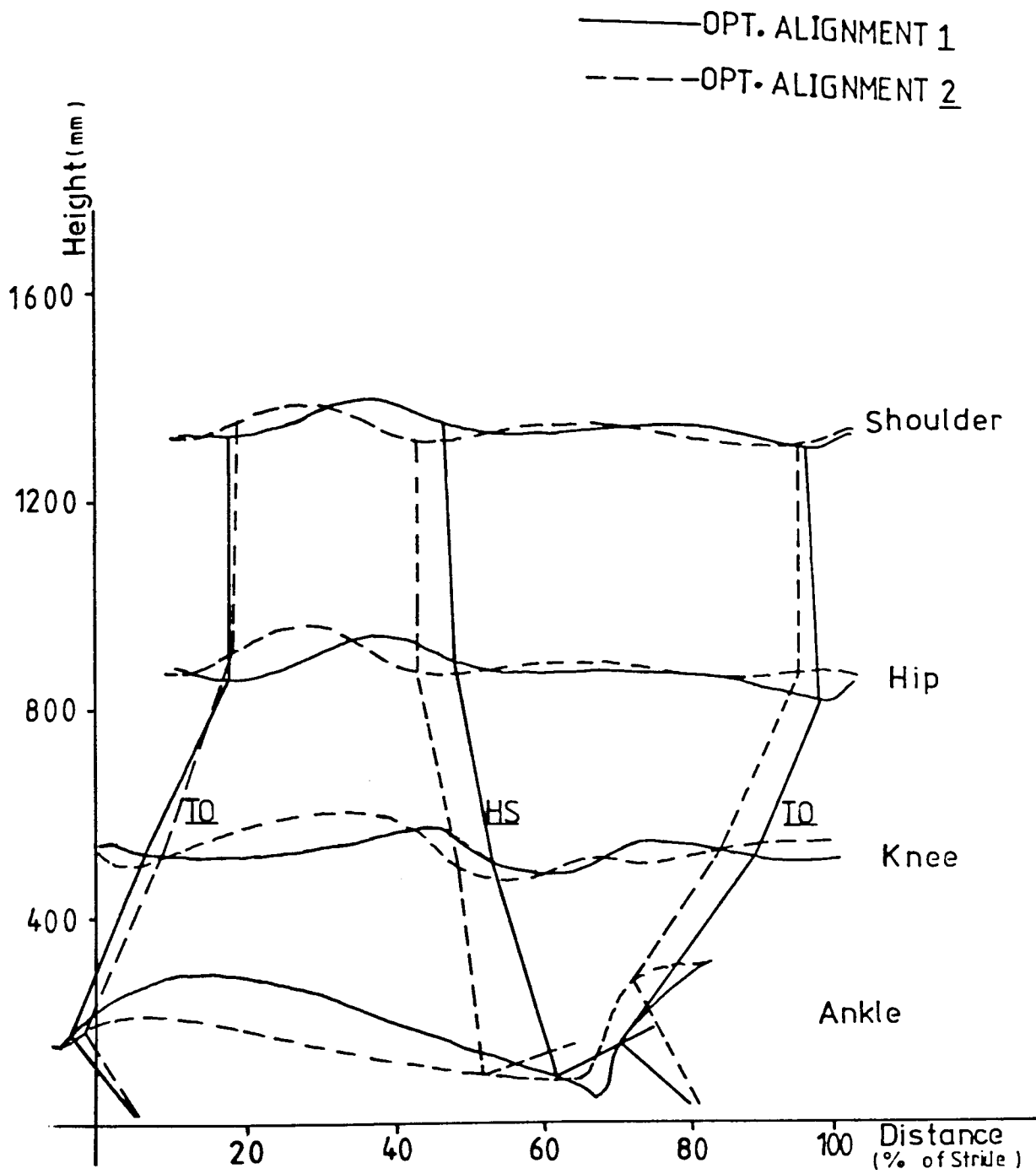

Fig (6.4.1.2 a) STICK-DIAGRAM

Patient: AR005-Sound

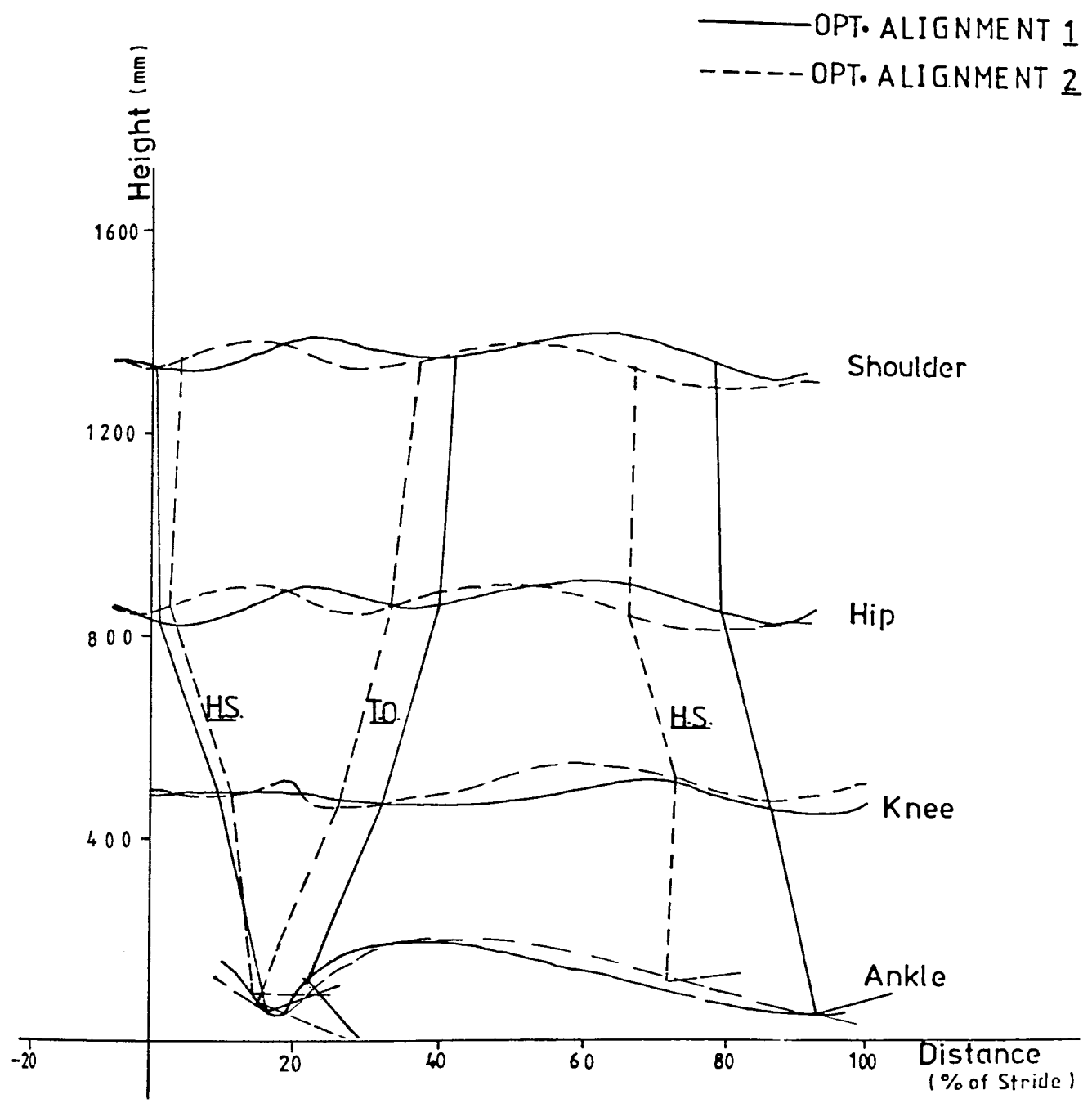

Fig (6.4.1.2 b) STICK-DIAGRAM

On the prosthetic side, there is only one peak in the hip and shoulder trajectories associated with prosthetic swing phase, of which the amplitude of shoulder is similar to the amplitude of sound side during the stance phase. Again, this is due to vaulting on the sound foot. Comparison between the shoulder and hip trajectories of alignment 1 and 2 on the prosthetic side shows no significant differences.

Comparison of the ankle, knee, hip and shoulder trajectories of the sound side between alignment 1 and 2 shows that the ankle trajectory of alignment 2 has registered a decrease in the amplitude during the swing phase.

The stick diagrams for all the patients were analysed. It was found that the differences in the trajectories corresponding to various optimum alignments were rather small. The stick diagrams for the patients selected and discussed in this section, ie., BL005 and AR005 displayed the largest differences.

6.4.2 ANGLE-TIME DIAGRAMS

Figures (6.4.2.1a & b) show the angle-time diagram of the below-knee amputee. During swing and early stance phase, the ankle remains in a position of constant plantarflexion. During stance it takes a position of 10 degree peak plantarflexion. However, the knee angle during swing phase was fairly normal at peak of 76 degrees. At heel strike the sound knee was not fully extended and registered a flexion of 12 degrees, and this flexion decreased as the knee was

Patient : BL 005-Prosthetic

— OPT. ALIGNMENT 1
- - - OPT. ALIGNMENT 2

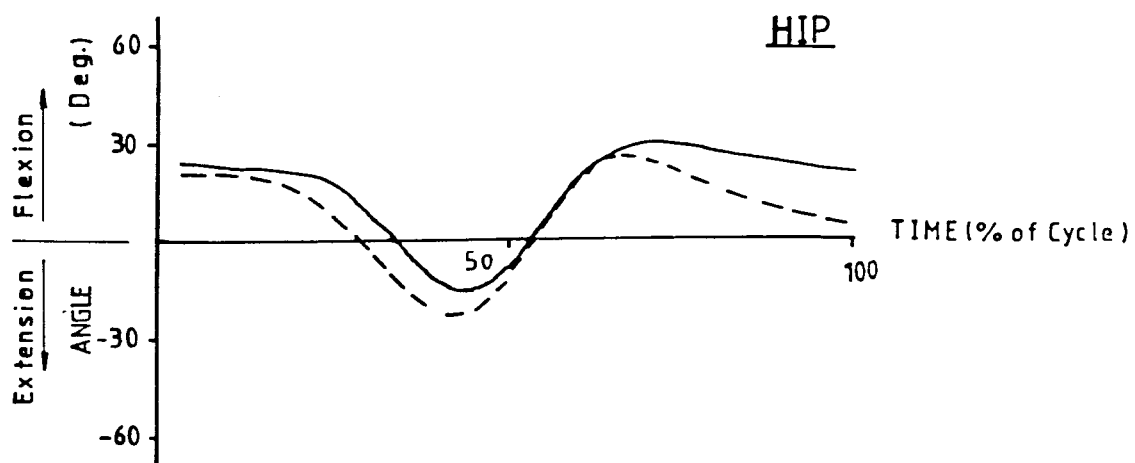
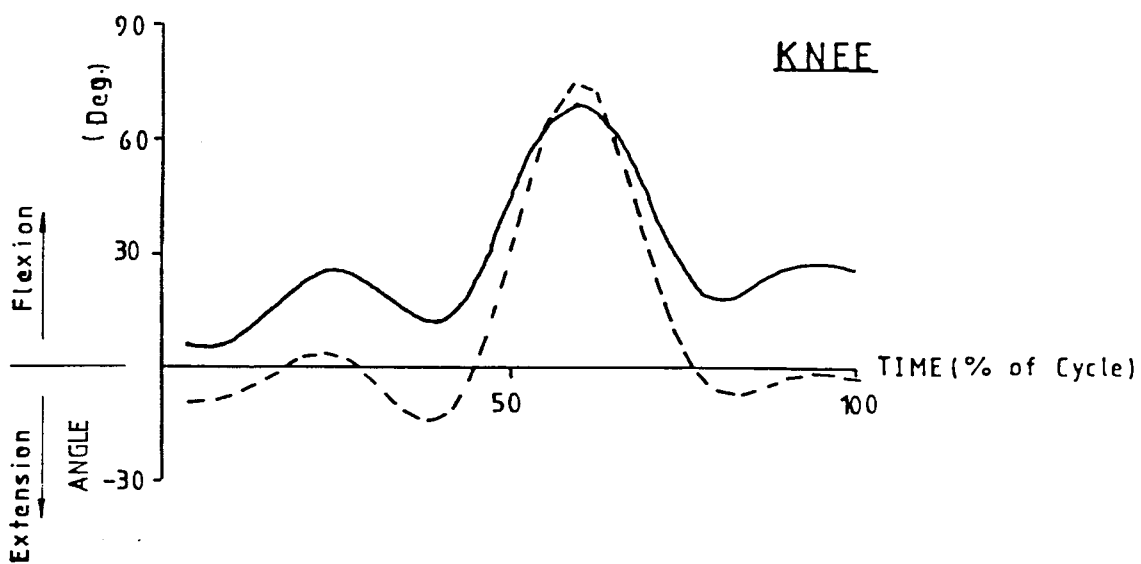
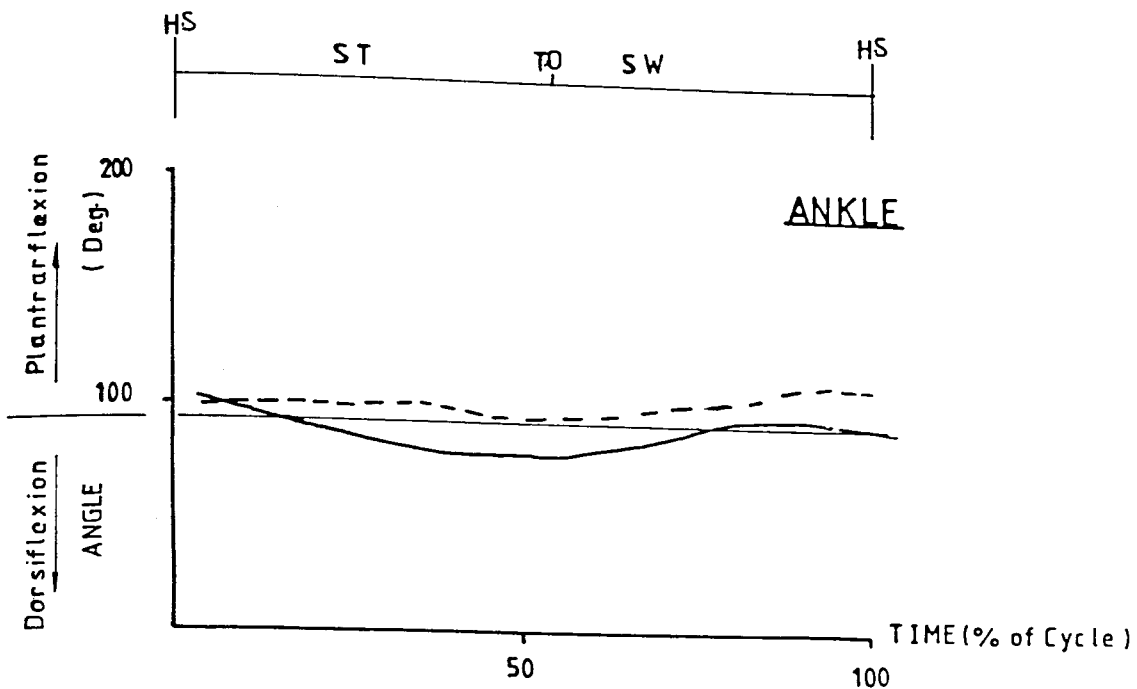

Fig.(6.4.2.1 a) ANGLE-TIME DIAGRAM

Patient: BL 005-Sound

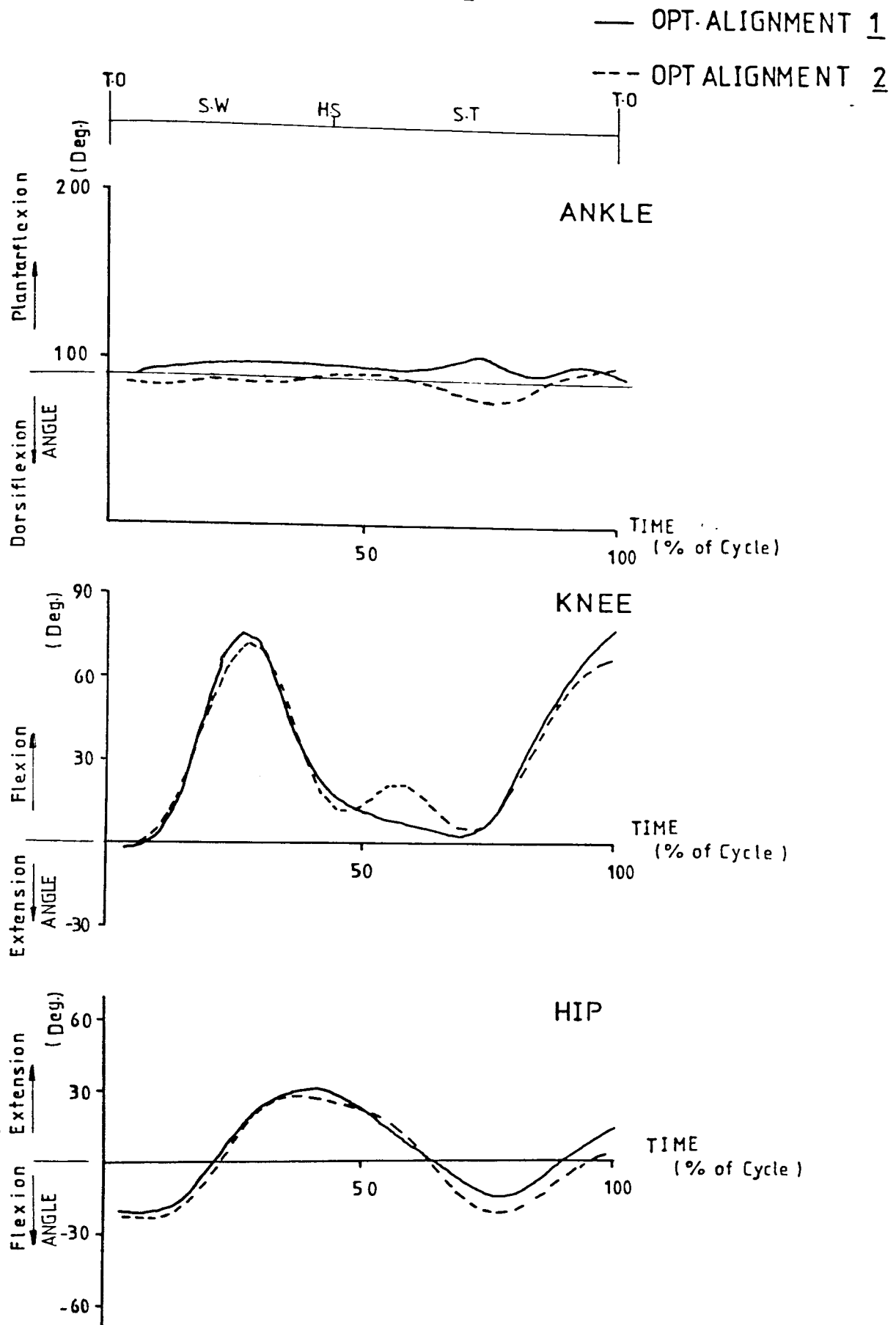

Fig (6.4.2.1 b) ANGLE-TIME DIAGRAM

going through stance phase. The angle of the hip joint during swing phase for alignment 1 was 26° extension and 14° flexion during stance phase.

The ankle angle-time diagram for alignment 2 on the sound side shows the effect of a dorsiflexed ankle. During early swing there is a slight dorsiflexion of the ankle, which increased to 17° at late stance. The knee flexion during swing corresponds to that of alignment 1. During stance phase the knee was 24° in flexion, which corresponds to that of a normal subject. The patterns for the ankle angle-time diagrams for alignments 1 and 2 are totally different. The hip angle-time diagrams of alignments 1 and 2, correspond with each other, and compare well with the normal subject.

The affect of alignment 1 on the prosthetic ankle during late stance was to increase dorsiflexion during both swing and stance phase. The knee angle-time for alignment 1 follows a fairly normal pattern. The sound knee of the prosthetic side was flexed 26° during stance and 71° during swing. The hip angle-time diagram followed a fairly normal pattern (Peizer, 1969) for either of the alignments.

The effect of optimum alignment 2 on the prosthetic ankle differed from that of alignment 1. During stance phase (alignment 2) the ankle plantarflexion was very minimal and gradually increased as the ankle approached swing phase. During the entire cycle dorsiflexion of the

prosthetic ankle has not occurred. On alignment 2, the knee flexion during early stance phase of prosthetic side was 4° , which was approximately one sixth of the knee flexion registered on alignment 1. During late stance the knee was hyperextended to 14° after which a fairly normal swing was evident. As can be seen, different alignments result in significant differences in the prosthetic knee angle. The patterns and angles at hip joint were affected minimally.

Figures (6.4.2.2a & b) show the angle-time diagrams of the above-knee amputee, walking with two different optimum alignments. The swing phase of the prosthetic side on alignment 1 shows that the prosthetic knee was flexed to 60° . Heel strike occurred with the prosthetic knee hyperextended to 10 degrees and the ankle joint at neutral position (90°). Hyperextension of the prosthetic knee continued throughout the stance phase.

Overall patterns of ankle, knee and hip angle-time diagrams of alignments 1 and 2 correspond with each other. On the sound side, the ankle angle-time diagram of both optimum alignment 1 and 2 does not correspond to that of normal or below-knee amputees. In fact, during the stance phase the patterns of ankle angle-time diagrams of alignments 1 and 2 do not correlate with each other. However, in both of the alignments dorsiflexion of ankle was absent. The knee and hip angle-time diagrams of the two alignments correspond with each other.

Patient: AR005 - Prosthetic

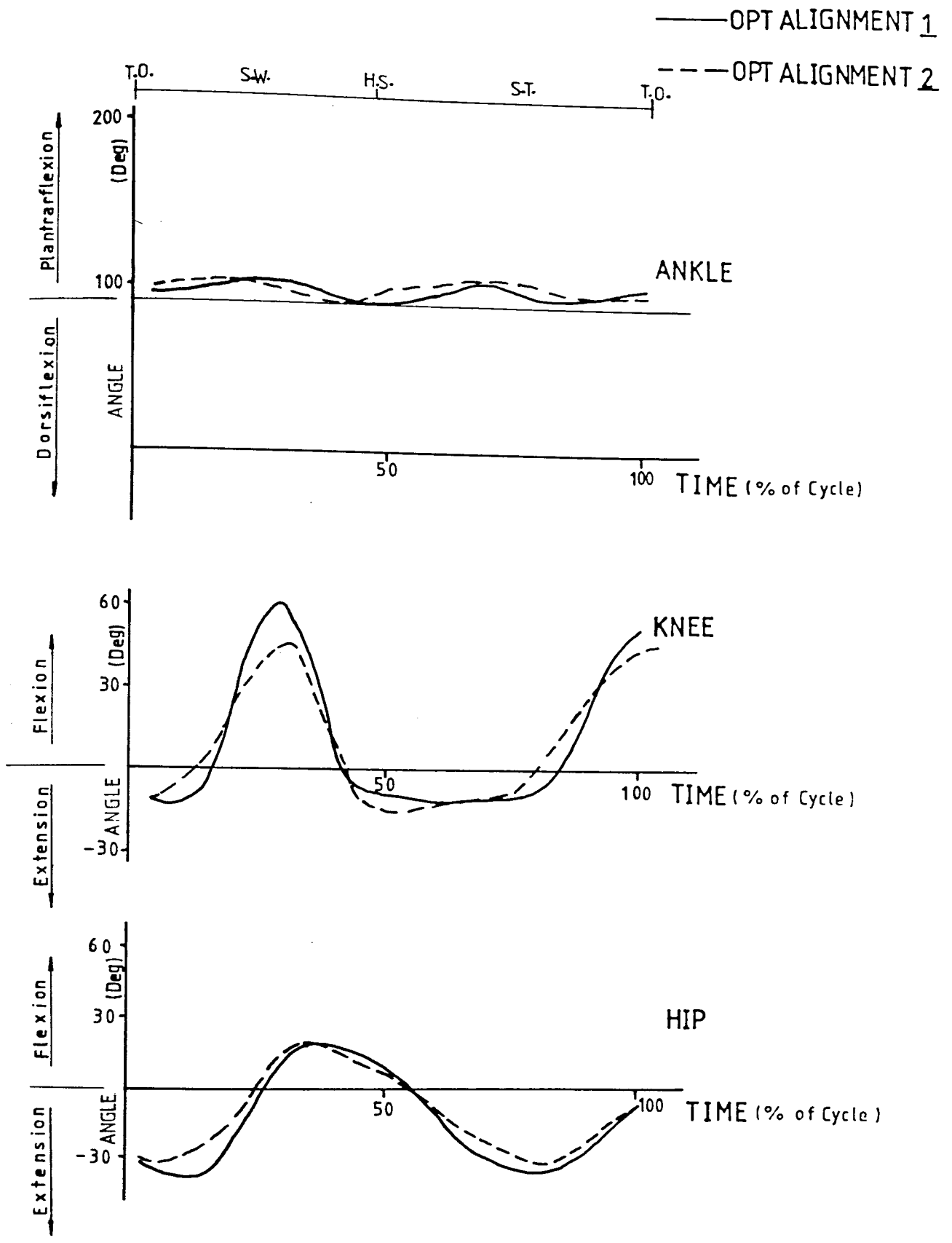
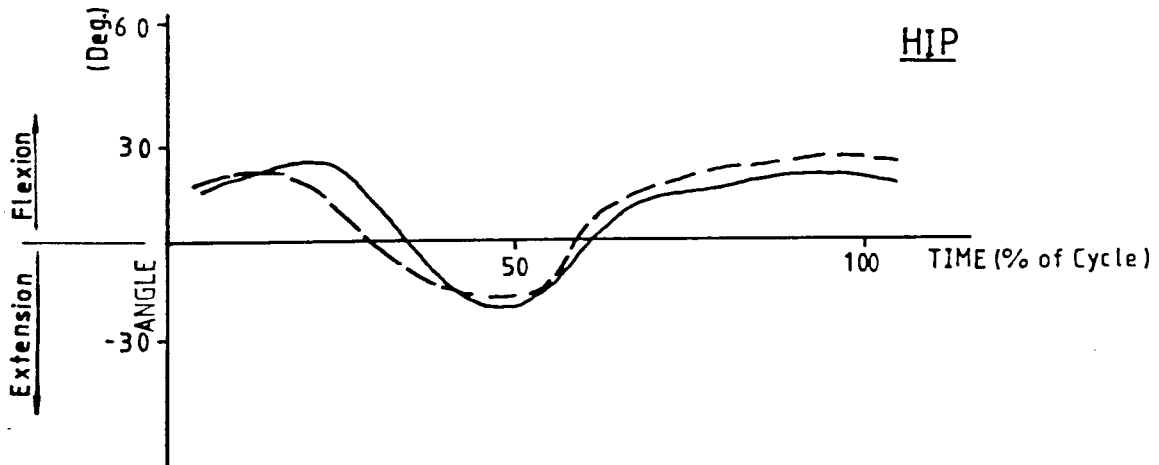
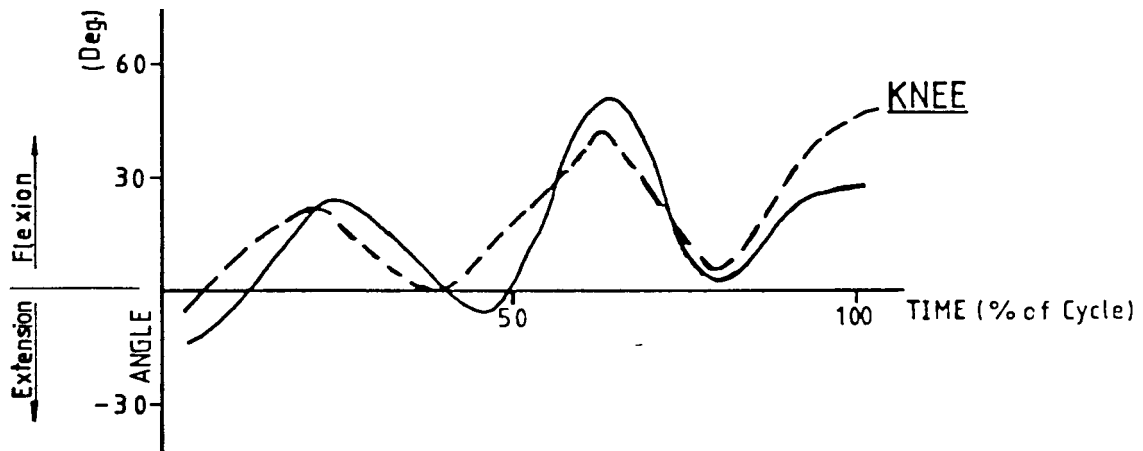
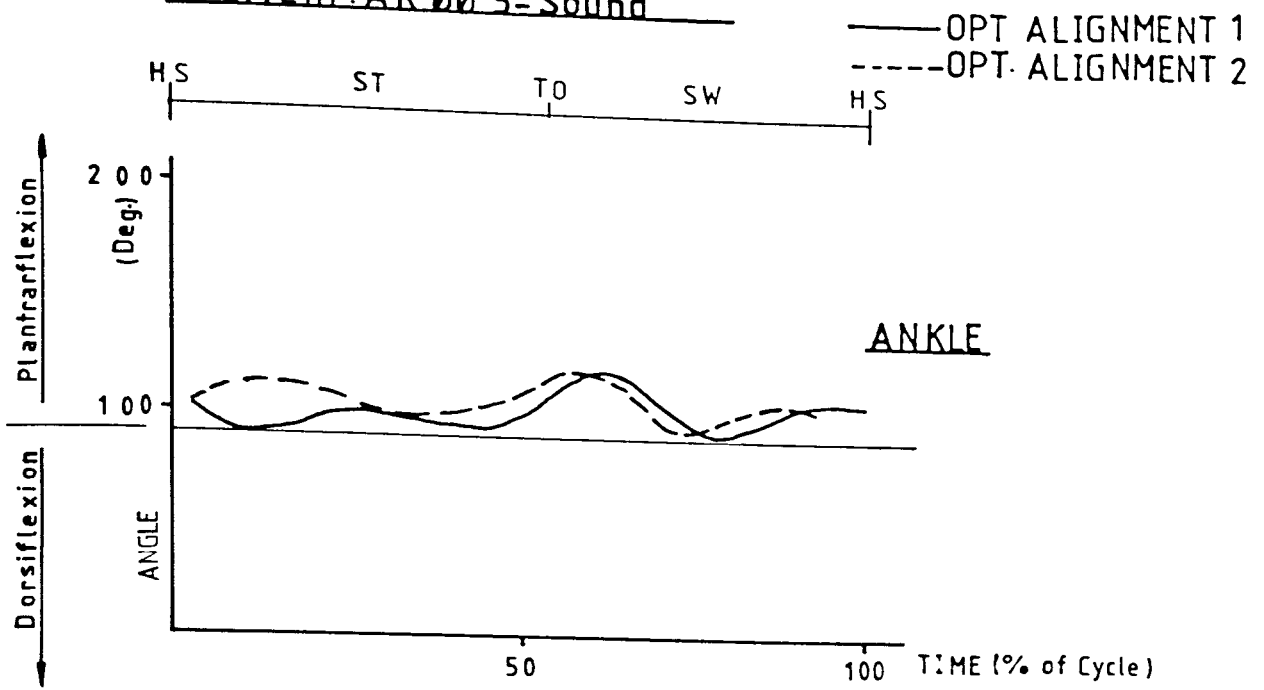

Fig (6.4.2.2 a) ANGLE-TIME DIAGRAM

Patient: AR 005-Sound



FIG(6.4.2.2 b) ANGLE-TIME DIAGRAM

6.4.3 ANGLE-ANGLE DIAGRAMS

Figures (6.4.3.1a & b) show the knee versus hip angle-angle diagram for the below-knee amputee.

Under optimum alignment 1, prosthetic heel strike occurred when the knee was 18° flexed. Just after heel strike the knee was rapidly flexed, followed by extension of knee and hip until prior to toe-off, where both knee and hip reached maximum extension. The knee and hip began to flex to prepare for prosthetic swing. On optimum alignment 2, heel-strike occurred with knee hyperextended to 2° . During late stance hyperextension of the knee reached its maximum at 15° . Comparison between optimum alignments 1 and 2 for the prosthetic side shows different angulations and areas, although patterns of the loops are similar, alignment 2 shows an elongated pattern.

Figure (6.4.3.2) shows the knee/hip angle-angle diagram of a normal subject.

Reading the loops in a clockwise direction, "ST" represents the onset of stance phase, that occurs at heel-strike. Following heel-strike there is a small amount of hyperextension followed by a rapid knee flexion and extension which shows up as a "kink" on the loop and which is attributed to a mechanism of "shock absorption" aimed at protecting the knee joint during the initial weight-bearing phase of stance. The hip extends throughout this manoeuver. In the latter part of stance the knee begins

Patient: BL005

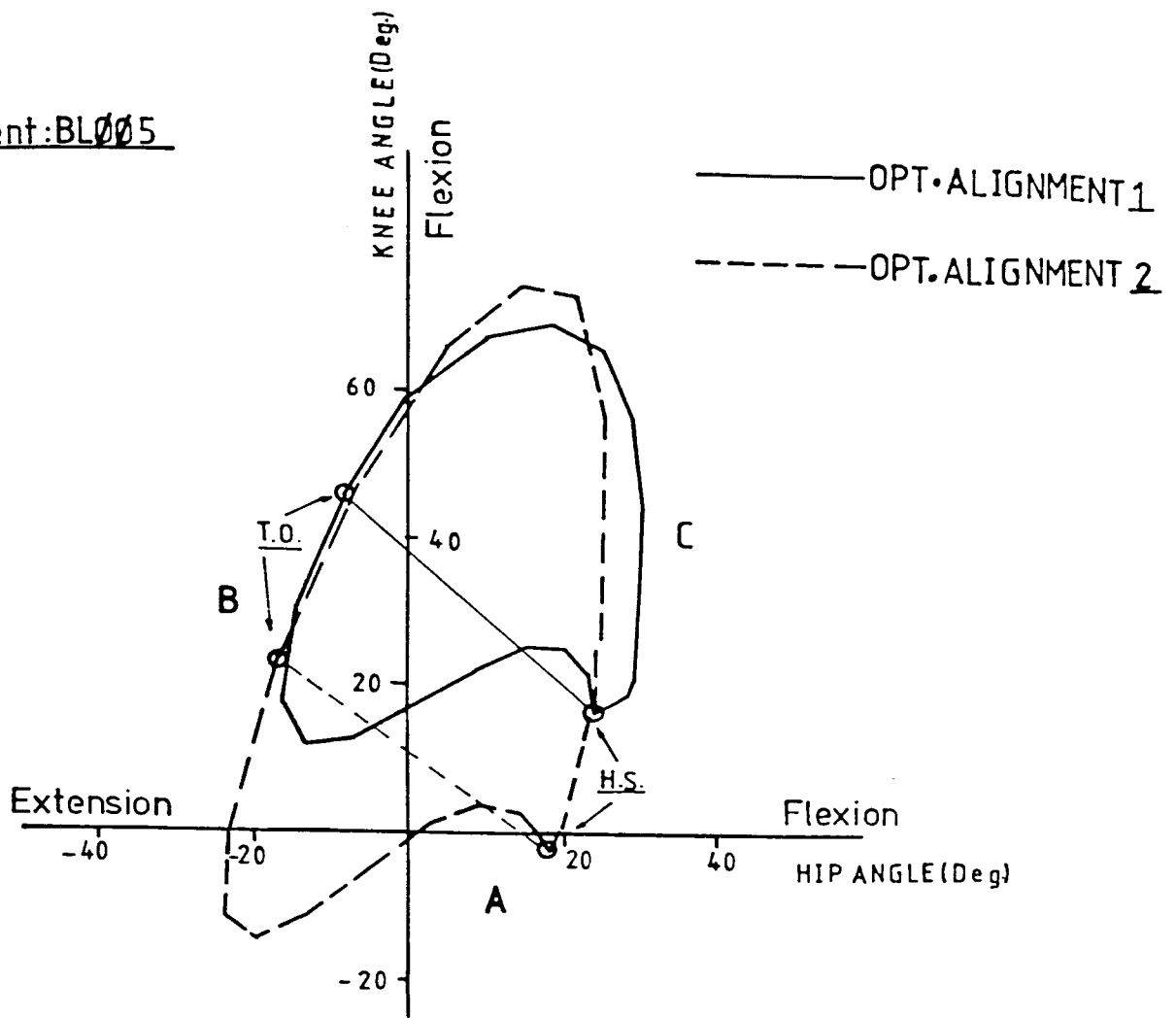

Fig(6.4.3.1a)-Prosthetic

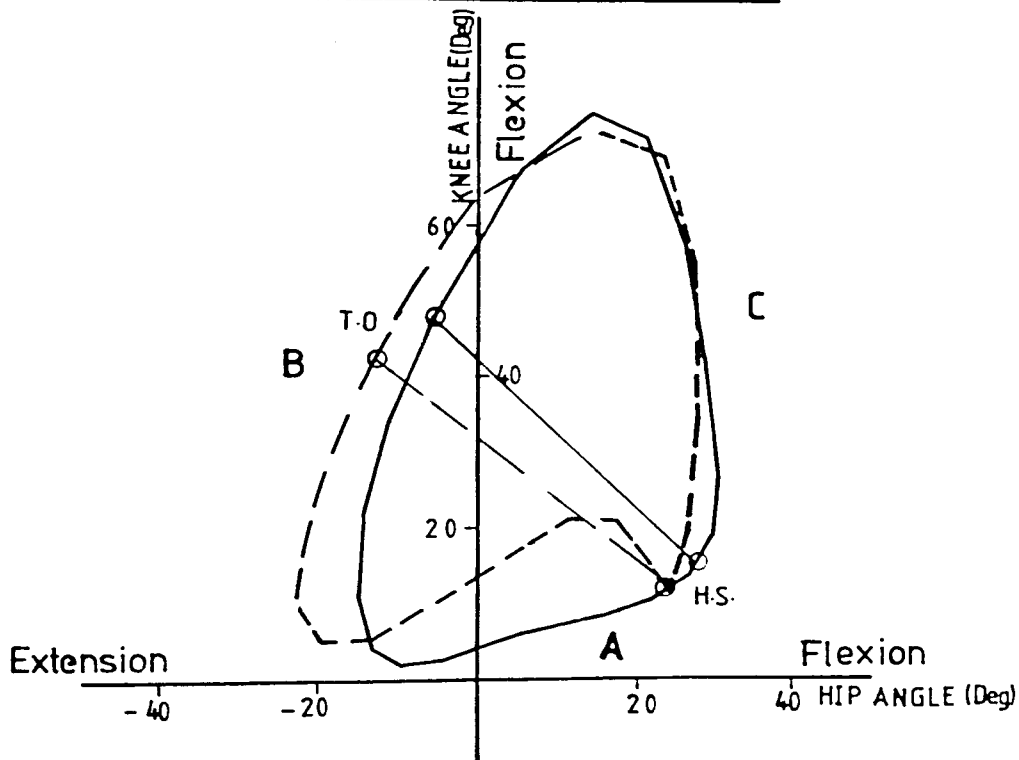

Fig(6.4.3.1b)-Sound

KNEE-HIP ANGLE/ANGLE DIAGRAM

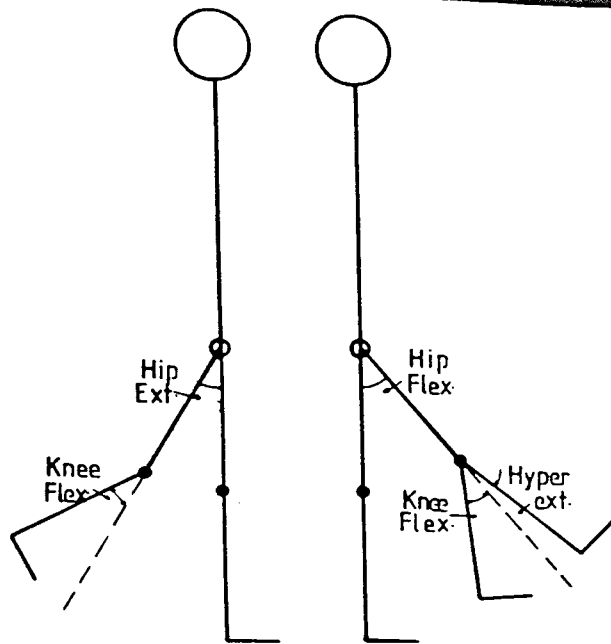

Direction of Flexion and Extension

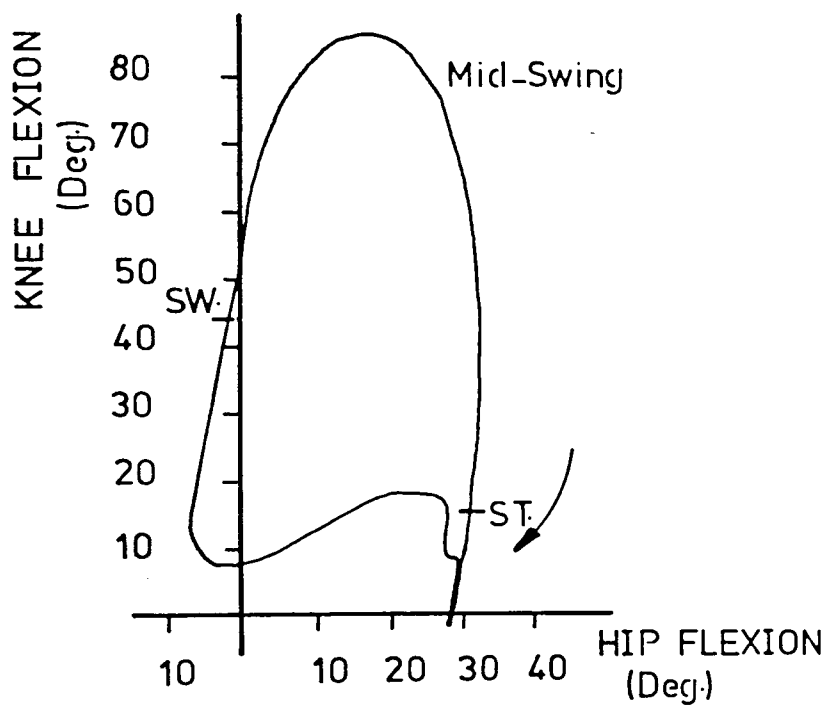

Figure(6.4.3.2)- A typical normal knee-angle/hip-angle diagram

(Redrawn from Hershler and Milner .1980)

a smooth, rapid flexion that will reach a peak in mid-swing. "SW" represents the onset of swing phase which occurs at toe-off. After mid-swing the knee extension begins in preparation for the next heel strike. The hip flexes continuously but relatively slowly during this change from knee flexion to extension during swing phase giving the top of the diagram a peaked appearance (Hershler, C., Milner, M., 1980).

Figure (6.4.3.1b) shows the effect of optimum alignments 1 and 2 on the sound side of the below-knee amputee. Alignment 2 shows a fairly similar pattern to that of the normal subject. With alignment 1, however, the "shock absorption" effect is lost at heel-strike (that is flexion of the knee joint after heel-strike is absent) and it is replaced by extension of the knee after heel-strike until just prior to toe-off, where both knee and hip started to flex again.

Table (6.4.3.1) shows the areas of knee/hip angle-angle diagrams covered by the sound and the prosthetic side with optimum alignments 1 and 2.

TABLE (6.4.3.1) AREA OF KNEE/HIP ANGLE-ANGLE DIAGRAMS, BK PATIENT BL005

Alignment	Area (cm ²)	
	Sound	Prosthetic
01	19.00	18.36
02	21.50	28.30

On the sound side the difference between the areas occupied by alignment 1 and 2 is fairly insignificant. However, the prosthetic side on optimum alignment 2, has covered a significantly larger area than the sound side, and also than the prosthetic side on optimum alignment 1.

TABLE (6.5.3.2) GRADIENT OF ANGLE-ANGLE DIAGRAM, BK PATIENT BLØØ5

Alignment	GRADIENT					
	Sound			Prosthetic		
	A	B	C	A	B	C
01	0.26	2.5	6.75	0.56	2.14	15.00
02	0.6	2.0	12.5	0.46	3.75	12.34

Table (6.4.3.2) shows the gradients of the curves at stance phase "A", early swing phase "B" and mid-swing "C" on the angle-angle diagram. On the prosthetic side of optimum alignment 1, the gradient at C indicates a linear relationship between flexion of hip and knee extension. However, this relationship does not hold with the relevant regions on the sound side and of the optimum alignment 2.

Comparison between optimum alignments 1 and 2 on the prosthetic side shows consistency between regions A and B. This consistency is also apparent between regions A, B and C of sound and prosthetic sides on alignment 2. The sound limb on alignment 1 exhibits a very different diagram when compared with alignment 2. Overall, however, no correlation could be established.

Figures (6.4.3.3a & b) show the knee/hip angle-angle diagram for the above-knee amputee.

The knee/hip diagram of the sound side indicates a convoluted pattern during heel-strike with alignment 1 and it seems that heel-strike occurred once the knee had begun to flex with simultaneous hip flexion. Stance phase was carried out by rapid extension of the knee and hip. During late stance, the knee registered an extension of 5° , after which both knee and hip began flexion to prepare for forward swing. During the stance phase of the prosthetic side, the knee was hyperextended, and substantial hip extension occurred during late stance. At heel-strike, knee flexion was absent which could be due to fear or instability. This is typical for an AK amputee fitted with a simple uniaxial knee mechanism. During stance phase the knee remained locked in hyperextension.

During swing phase of alignment 2, the knee flexion on the prosthetic side is higher than on the sound side, which could be due to a longer swing phase by the prosthetic side. With alignment 2 the stance phase on the sound limb shows a fairly smooth contact at heel-strike, and continued throughout the stance phase. Overall, the loop covered a fairly normal pattern.

Table (6.4.3.3) shows the areas occupied by knee/hip angle-angle diagrams corresponding to the two optimum alignments.

Patient: AR005

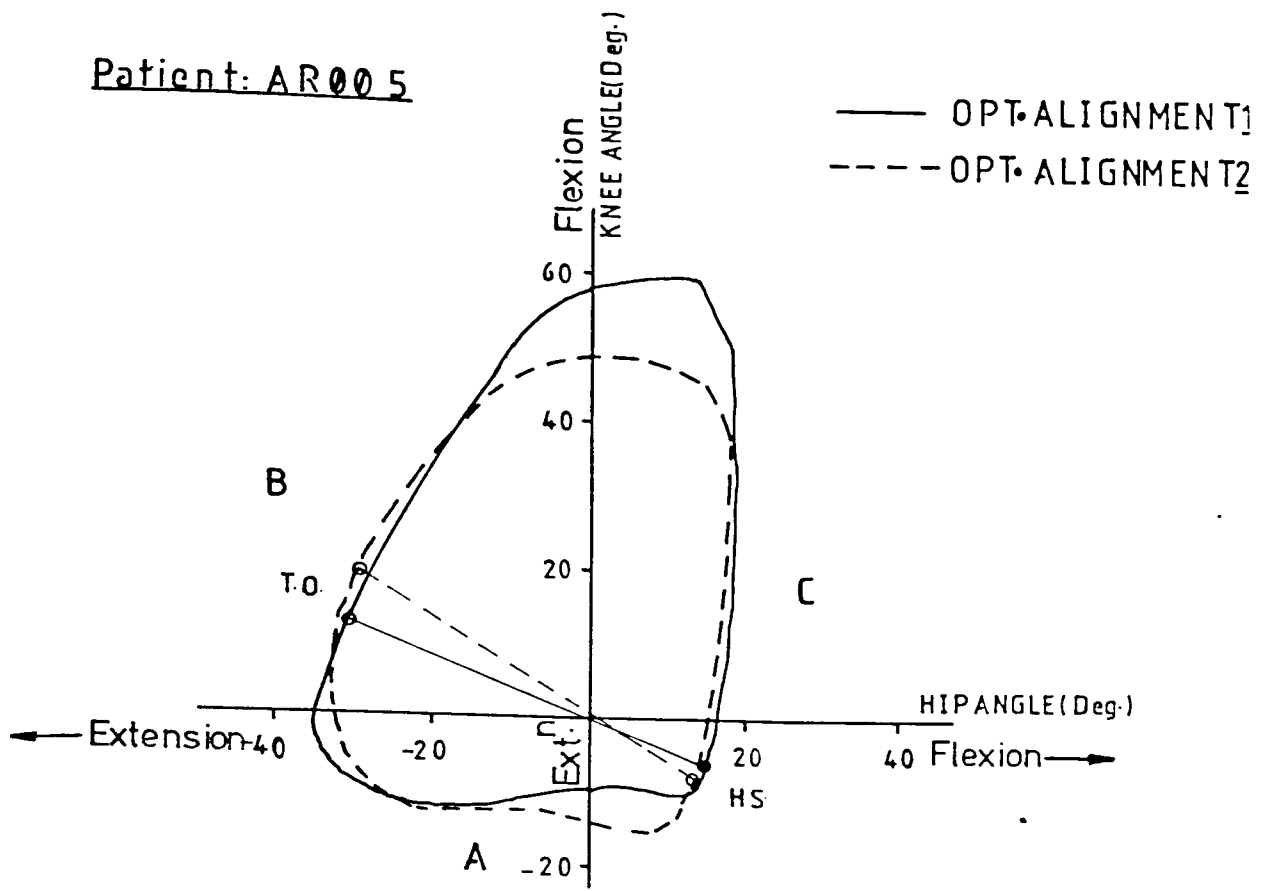

Fig. (6.4.3.3.a) - Prosthetic

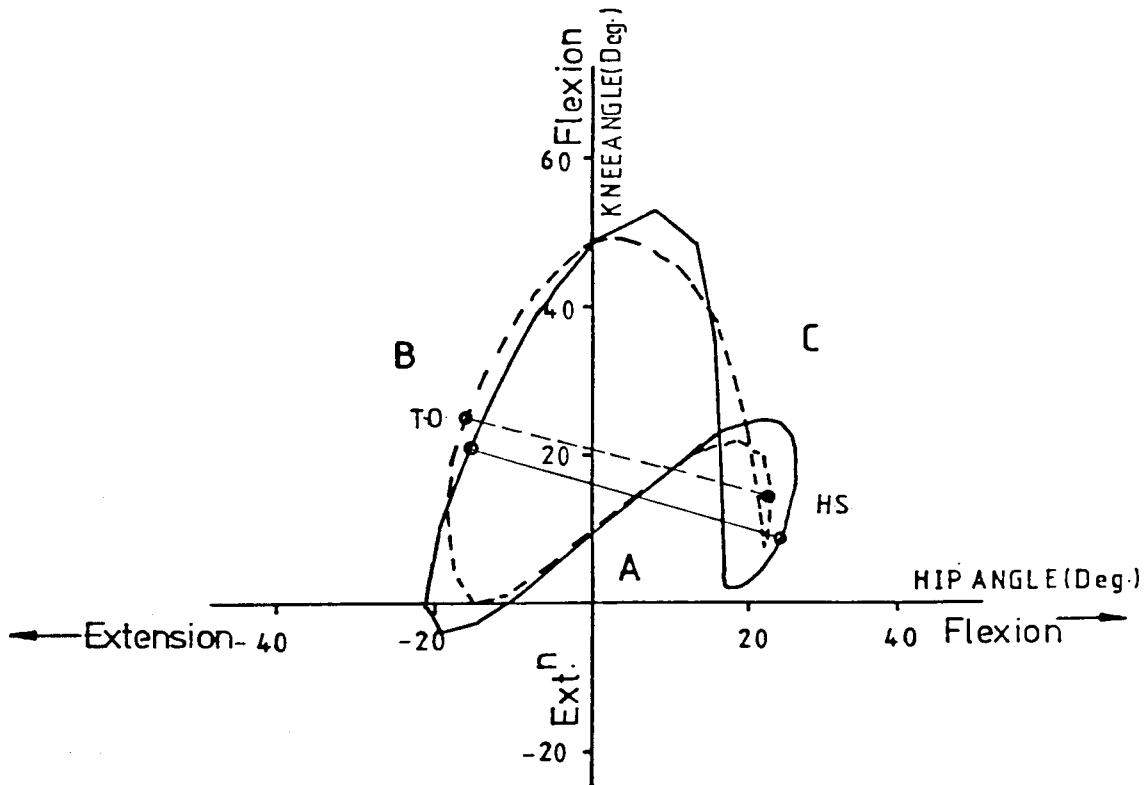

Fig. (6.4.3.3.b) - Sound

KNEE-HIP ANGLE/ANGLE DIAGRAM

TABLE (6.4.3.3) AREA OF KNEE/HIP ANGLE-ANGLE DIAGRAM, AK PATIENT ARØØ5

Alignment	Area (cm ²)	
	Sound	Prosthetic
01	13.14	30.15
02	10.50	26.46

From the above table, the areas covered by the sound and prosthetic limbs on alignment 1 are larger than on alignment 2. The prosthetic side has occupied a larger area of the angle-angle diagram with either of the alignments, compared with the sound side.

Table (6.4.3.4) shows the gradients at A, B and C; stance phase, early swing phase and swing phase respectively.

TABLE (6.4.3.4) GRADIENTS OF ANGLE-ANGLE DIAGRAM, AK PATIENT ARØØ5

Alignment	GRADIENT					
	Sound			Prosthetic		
	A	B	C	A	B	C
01	0.85	2.63	14.00	0.75	2.0	7.50
02	0.75	2.14	2.14	0.05	1.45	6.34

The gradients at early stance of the sound side of optimum alignments 1 and 2 correspond with each other. This also applies to gradients at stance phase (A) of alignments 1 and 2 on the sound side. The gradient of mid-swing of the sound side on alignment 1 shows a more linear descent than

that of alignment 2, which could be associated with greater hip flexion during swing through. On the prosthetic side, a greater degree of variability is shown by gradients A and B between alignments 1 and 2, when compared with the sound side. During stance phase (A), alignment 2 shows a lower gradient than that of alignment 1 and the sound side, which could possibly be associated with a lesser knee flexion during stance phase.

Overall, at this stage, it is not possible to associate the information provided by the gradients at the relevant slopes to the performance of the amputee under different alignments.

TABLE (6.4.3.5) AREAS OF ANGLE-ANGLE DIAGRAM FOR OPTIMUM ALIGNMENTS

Patient	Optimum Alignment	Area (cm ²)	
		Prosthetic	Sound
BR004	01	14.94	14.67
	02	18.99	15.66
	03	20.34	14.85
BL005	01	18.36	19.00
	02	28.30	21.50
AR005	01	30.15	13.14
	02	26.46	9.36
AR001	01	18.36	12.33
	02	23.49	12.51

The above table shows that on average the prosthetic side has occupied a "larger" area of the knee/hip angle-angle diagram.

6.4.4 TEMPORAL PARAMETERS

Table (6.4.4.1) shows the temporal parameters of the below-knee amputee walking with two different optimum alignments.

TABLE (6.4.4.1) TEMPORAL PARAMETERS OF BK PATIENT BL005

Alignment	Prosthetic Side					Sound Side				
	Stance Duration (s)	Swing Duration (s)	Total Duration (s)	Stride (cm)	$\frac{SW}{St}$	Stance Duration (s)	Swing Duration (s)	Total Duration (s)	Stride (cm)	$\frac{SW}{St}$
01	0.60	0.48	1.08	141.6	0.8	0.72	0.36	1.04	119.0	0.5
02	0.66	0.42	1.08	150.3	0.64	0.66	0.42	1.08	151.0	0.64

The amputee begins the stance phase by compression of the heel cushion of the SACH foot and then by forward motion of the knee and stump. Toe-off begins with initial flexion of the knee and hip, and the amputee clears the ground by rolling over the SACH foot toe break. Hence, depending on the position of the SACH foot relative to the shank and the overall limb configuration, the stance and swing phase timings could be affected.

With alignment 1, the amputee has taken a shorter stance and a longer swing phase timing with the prosthetic limb, compared to the sound side. Moreover, although the

total gait cycle time remained fairly constant for both the prosthetic and the sound limbs, the stride length and the ratio of swing to stance phase differed for each limb. The symmetry of gait (ratio of swing to stance phase timings), is not preserved with this alignment (1). With optimum alignment 2, all of the temporal parameters are similar to each other, and clearly show a symmetrical pattern.

Table (6.4.4.2) shows the temporal parameters of the above-knee amputee, walking with two different optimum alignments.

TABLE (6.4.4.2) TEMPORAL PARAMETERS OF AK PATIENT AR005

Alignment	PROSTHETIC SIDE					SOUND SIDE				
	Stance Duration (s)	Swing Duration (s)	Total Duration (s)	Stride (cm)	$\frac{SW}{St}$	Stance Duration (s)	Swing Duration (s)	Total Duration (s)	Stride (cm)	$\frac{SW}{St}$
01	0.84	0.54	1.38	153.1	0.64	0.74	0.54	1.28	142.4	0.73
02	0.84	0.48	1.32	146.9	0.51	0.78	0.66	1.44	122.7	0.85

In optimum alignment 1, although the swing phase duration is the same for both limbs, the stance phase duration of the prosthetic side is longer than that of the sound side. However, the total gait cycle duration and the stride lengths are identical. Comparison between alignments 1 and 2 shows that in alignment 1, a longer stride length was covered by both the sound and the prosthetic limbs, and a greater degree of step symmetry is observed with alignment 1.

6.5 EFFECT OF VARIOUS CONTROLLED MAL-ALIGNMENTS ON AMPUTEE GAIT PATTERN

In this section the amputee gait patterns for controlled mal-alignments are compared with those obtained with optimum alignments.

The performance of a below-knee amputee was studied under the following controlled mal-alignments relative to optimum alignments:

- 1) M1 - Increased plantarflexion of the prosthetic foot ($1\frac{1}{2}$ degrees from optimum alignment)
- 2) M2 - Increased dorsiflexion of the prosthetic foot ($1\frac{1}{2}$ degrees from optimum alignment)
- 3) M3 - Abduction of the prosthetic foot ($1\frac{1}{2}$ degrees from optimum alignment)

In the case of the above-knee amputee the following controlled mal-alignments were carried out relative to optimum alignment:

- 1) M1 - Increased plantarflexion of the prosthetic foot ($1\frac{1}{2}$ degrees from optimum alignment)
- 2) N5 - Increased extension of the socket (3 degrees from optimum alignment)

6.5.1 STICK DIAGRAMS

Figures (6.5.1.1a & b) show the effect of increased plantarflexion of the prosthetic foot on the below-knee amputees' joint trajectories. Comparison of the trajectories for the optimum alignment and the above mal-alignment shows that there were no significant differences in the shoulder,

Patient: BR004 - Prosthetic

—— OPT. ALIGNMENT
----- 1. PLANTAR FLEXION-M

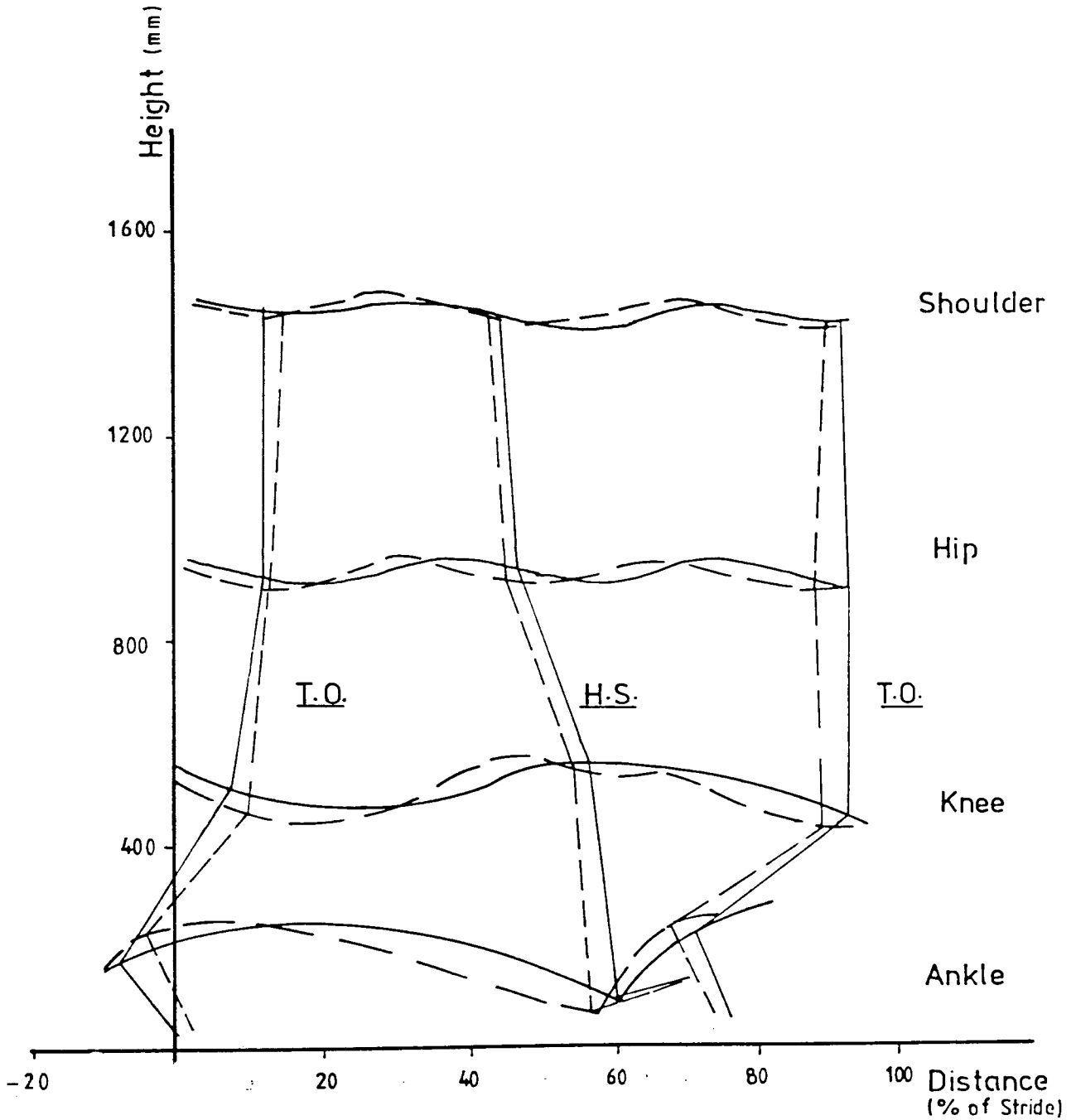

Fig. (6-5-11 a) - STICK DIAGRAM

Patient: BR004 - Sound

— OPT. ALIGNMENT
- - - 1-PLANTAR FLEXION - M1

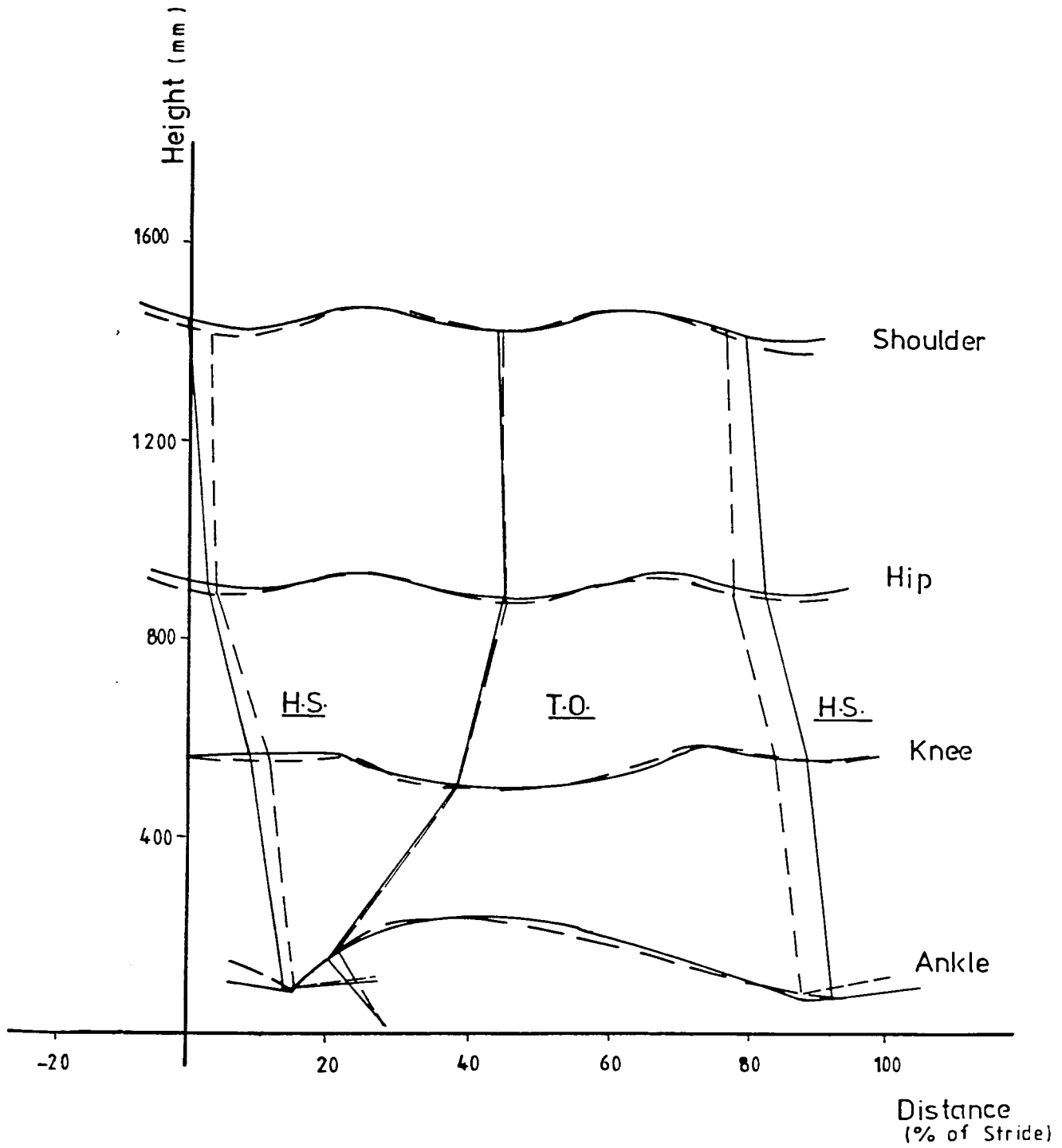

Fig. (6.5.11 b) - STICK DIAGRAM

Patient: BR004 - Prosthetic

—— OPT. ALIGNMENT

- - - - 2 DORSIFLEXION-M2

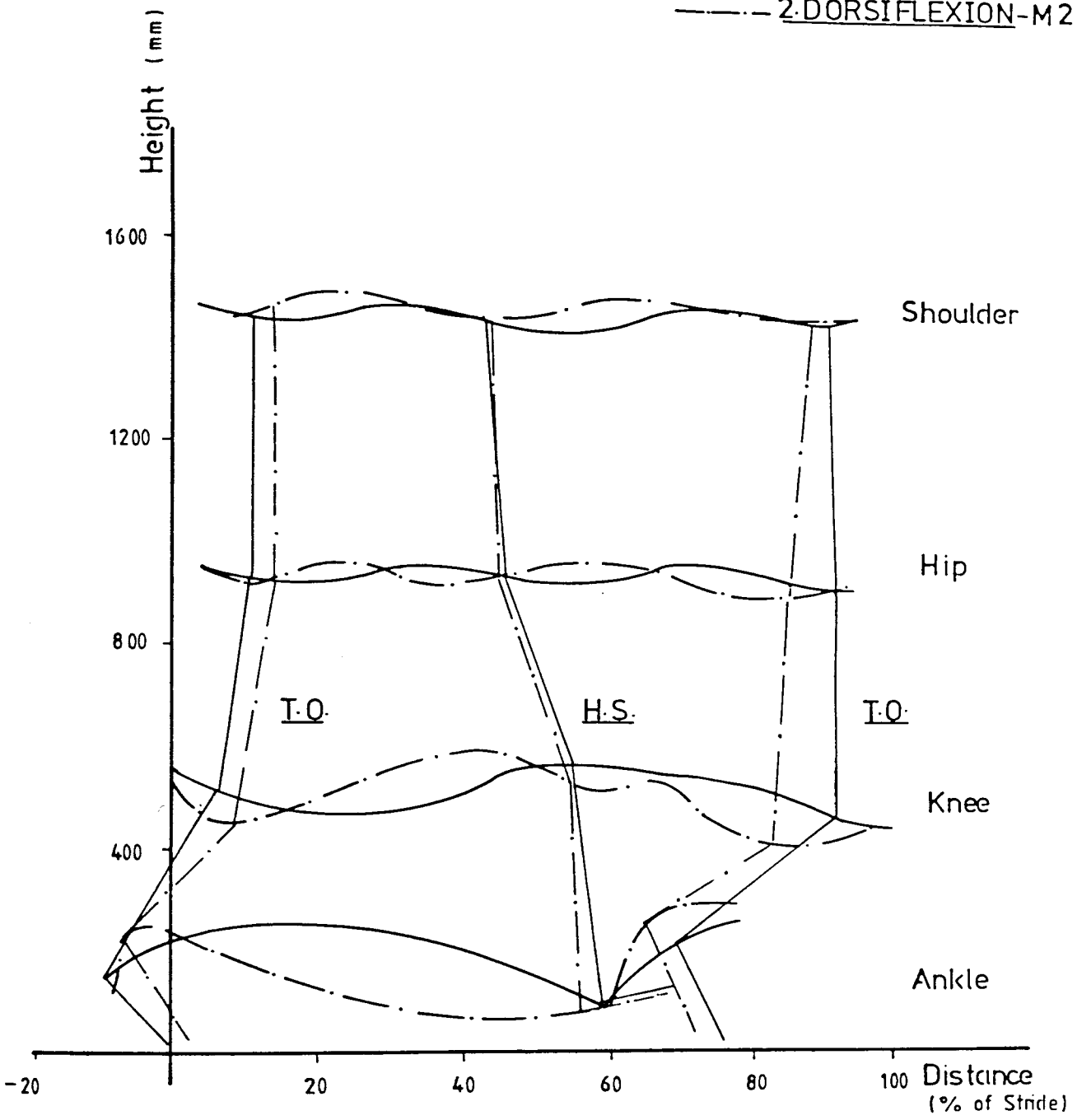

Fig. (6.5.1.2 a) - STICK DIAGRAM

Patient: BR004-Sound

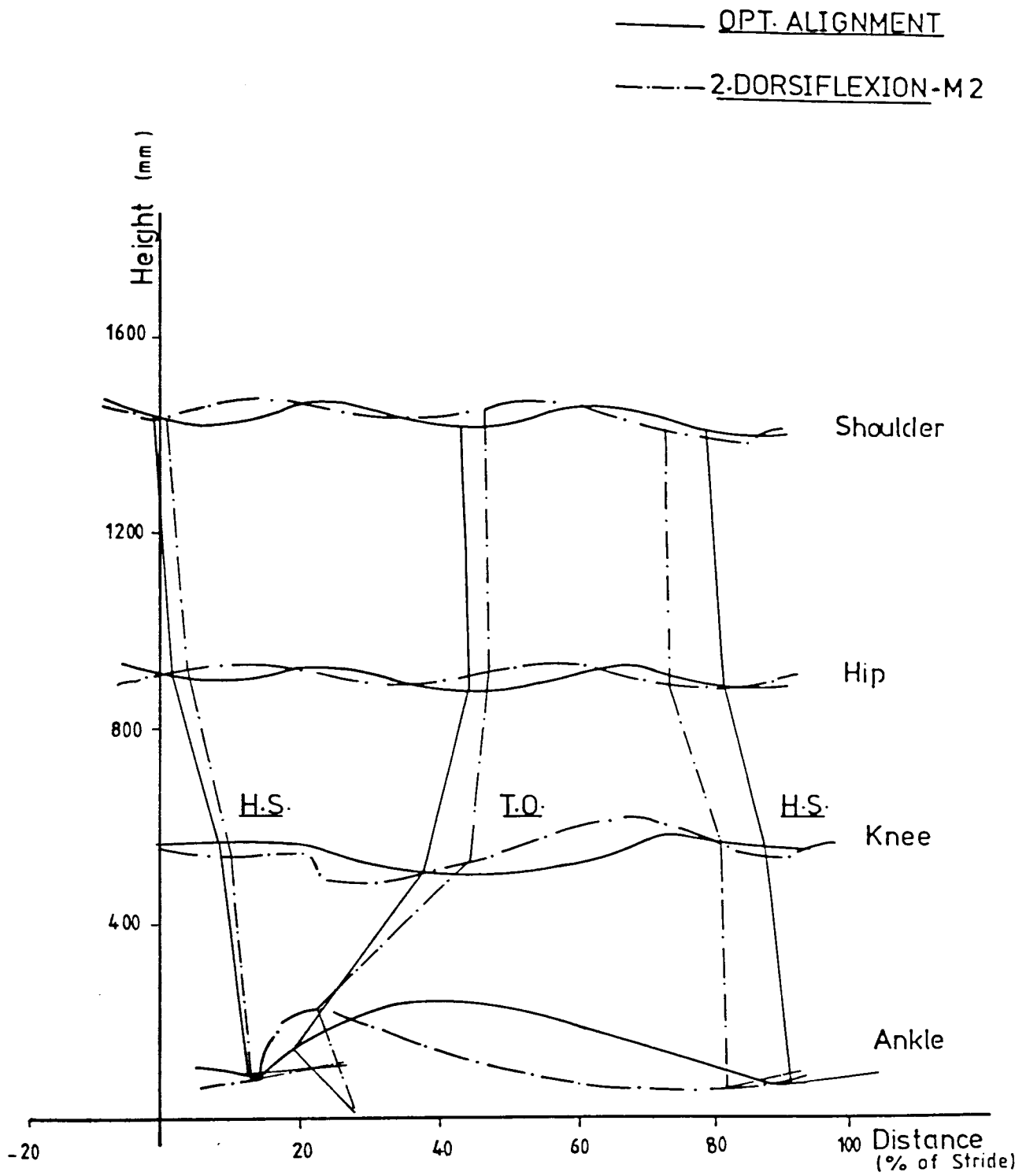

Fig (6.5.1.2 b)-STICK DIAGRAM

hip, knee and ankle trajectories of the sound side (Figure (6.5.1.1b)). During the swing phase the prosthetic ankle trajectory (Figure (6.5.1.1a)), had a lower amplitude with the mal-alignment (M1) than that with the optimum alignment. The height of the knee, hip and shoulder trajectories of the prosthetic side differ from those obtained with the optimum alignment.

Figures (6.5.1.2a & b) show the effect of increased dorsiflexion of the prosthetic foot on the gait pattern of the same amputee as above. On the sound side, the ankle has registered a significant decrease in the height of the trajectory, and the height of the knee trajectory has increased during the swing phase (when compared with those of optimum alignment). The trajectories of the hip and shoulder on the sound side show a two peak pattern, with approximately the same amplitude as that of the optimum alignment. The effect of dorsiflexion of the prosthetic foot is most apparent on the ankle and knee trajectories of the prosthetic foot. During swing phase of the prosthetic side, the peak of knee trajectory has increased significantly, whilst replaced by substantial decrease during stance phase.

Figures (6.5.1.3a & b) show the effect of abduction of the prosthetic foot on the joint trajectories of the same below-knee amputee. There are no significant differences between the shoulder and hip trajectories of the sound side and those of the optimum alignment. However, the knee trajectory registered a fairly significant decrease in

Patient: BR004 — Prosthetic

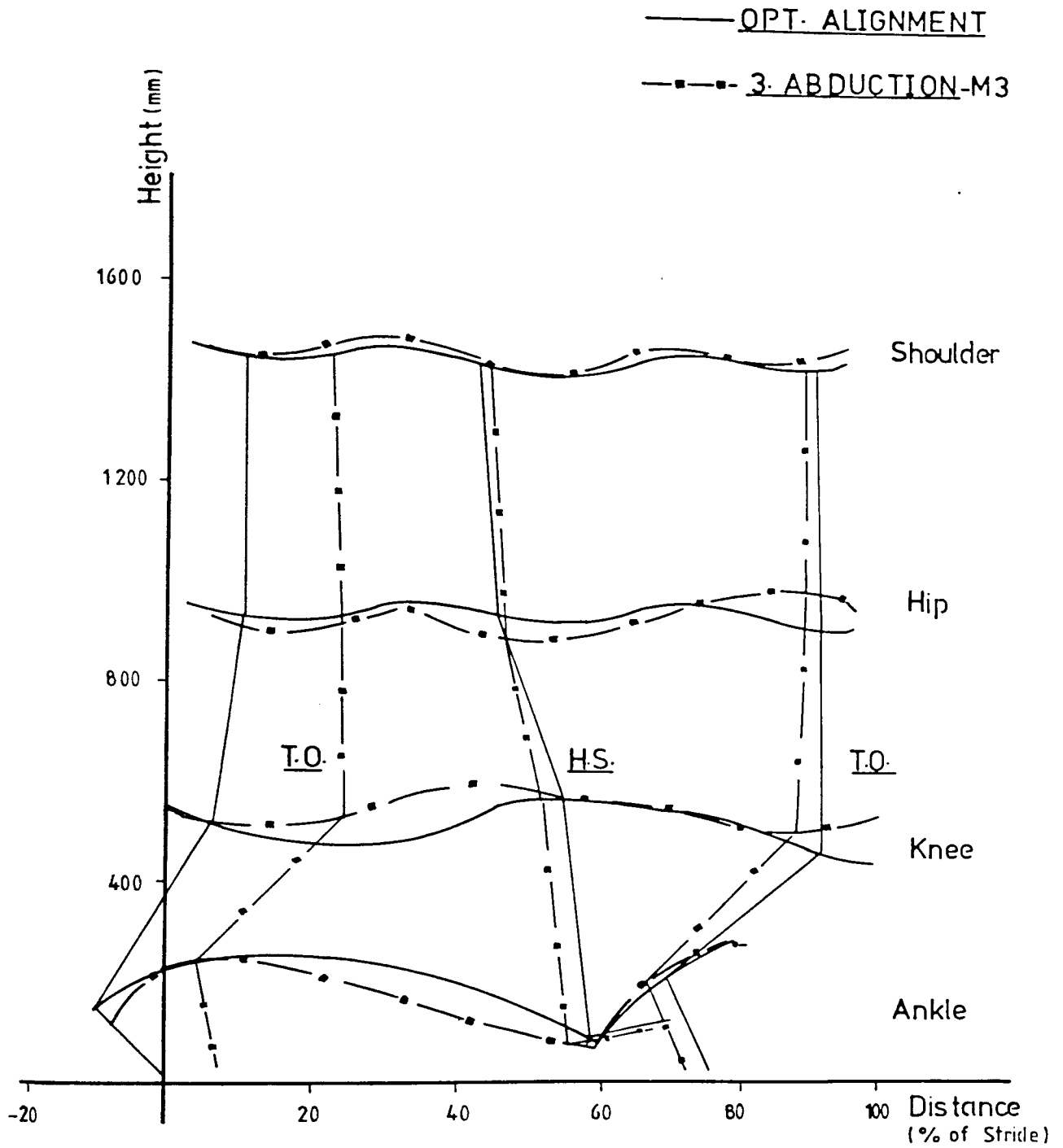

Fig.(G5.1.3 a) — STICK DIAGRAM

Patient: BR004 - Sound

— OPT. ALIGNMENT

- - - 3-ABDUCTION - M 3

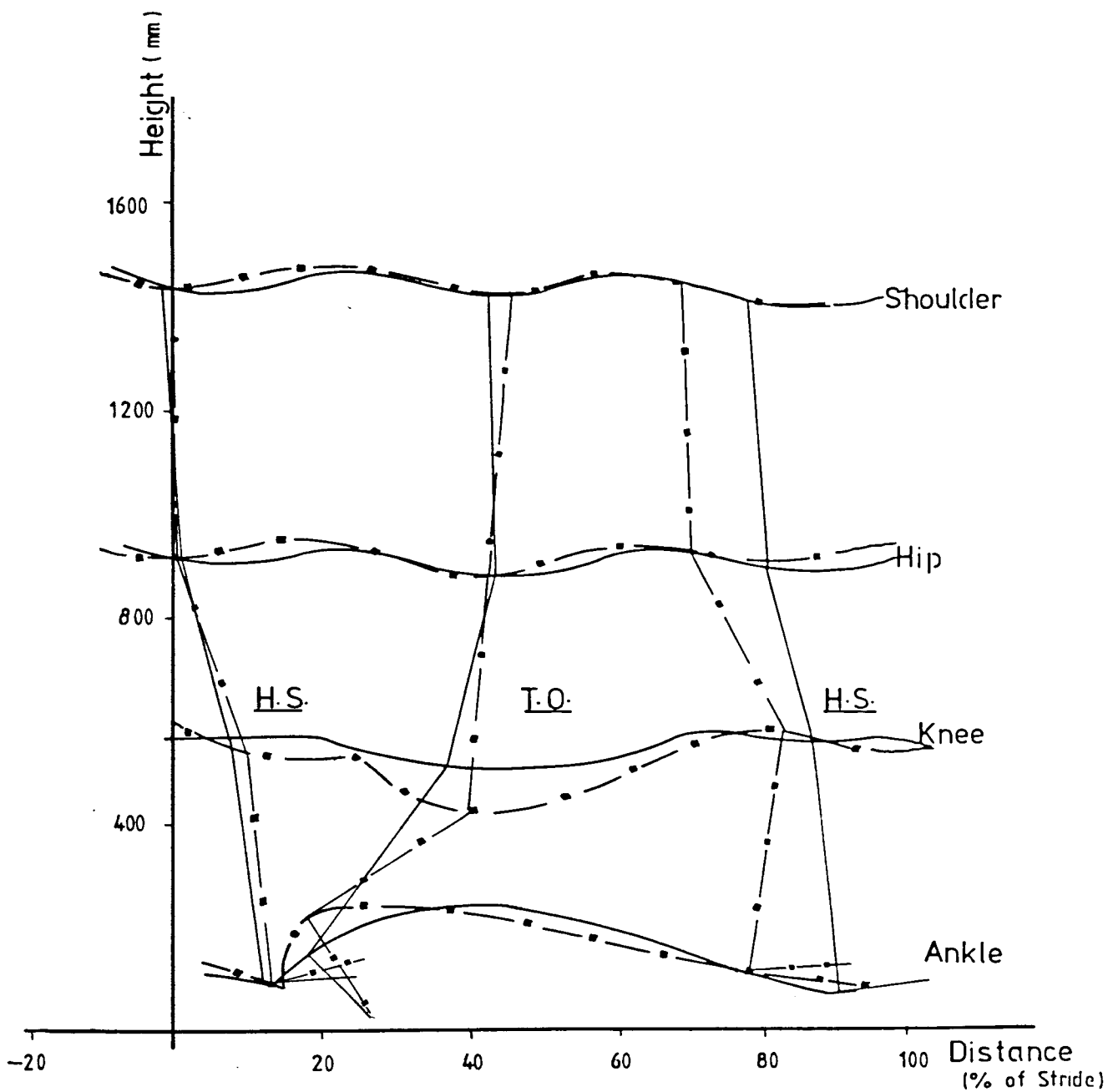

Fig (6-5-1-3 b) — STICK DIAGRAM

Patient: AR005 - Prosthetic

— OPT. ALIGNMENT
- - - 1 - M1; PLANTAR FLEXION
- · - · - 2 - N5; SOCKET EXT.

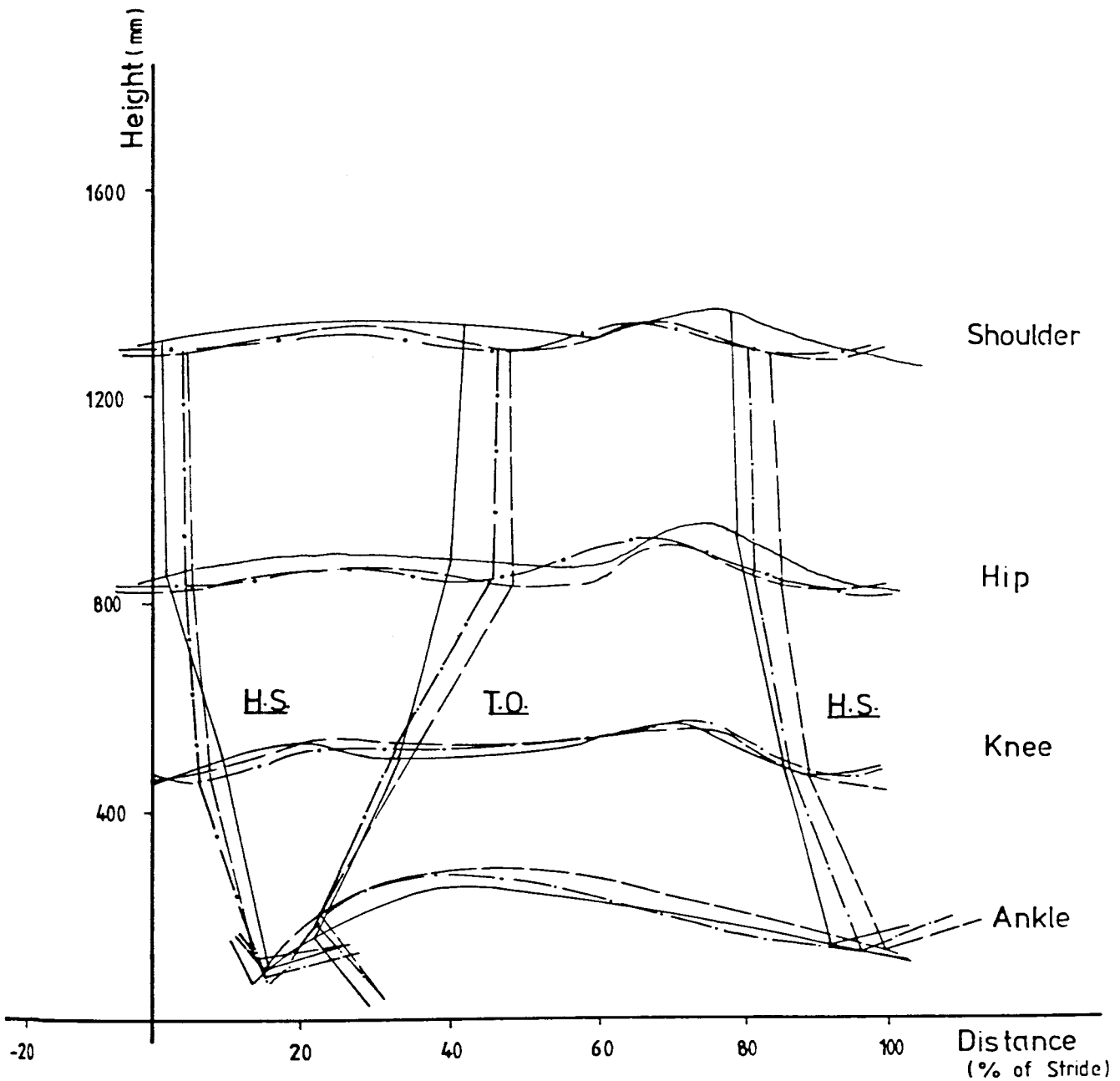

Fig. (6.5.1.4 a) - STICK DIAGRAM

Patient: AR005 - Sound

— OPT. ALIGNMENT
--- 1- M1; PLANTARFLEXION
-.- 2- N5; SOCKET EXTENDED

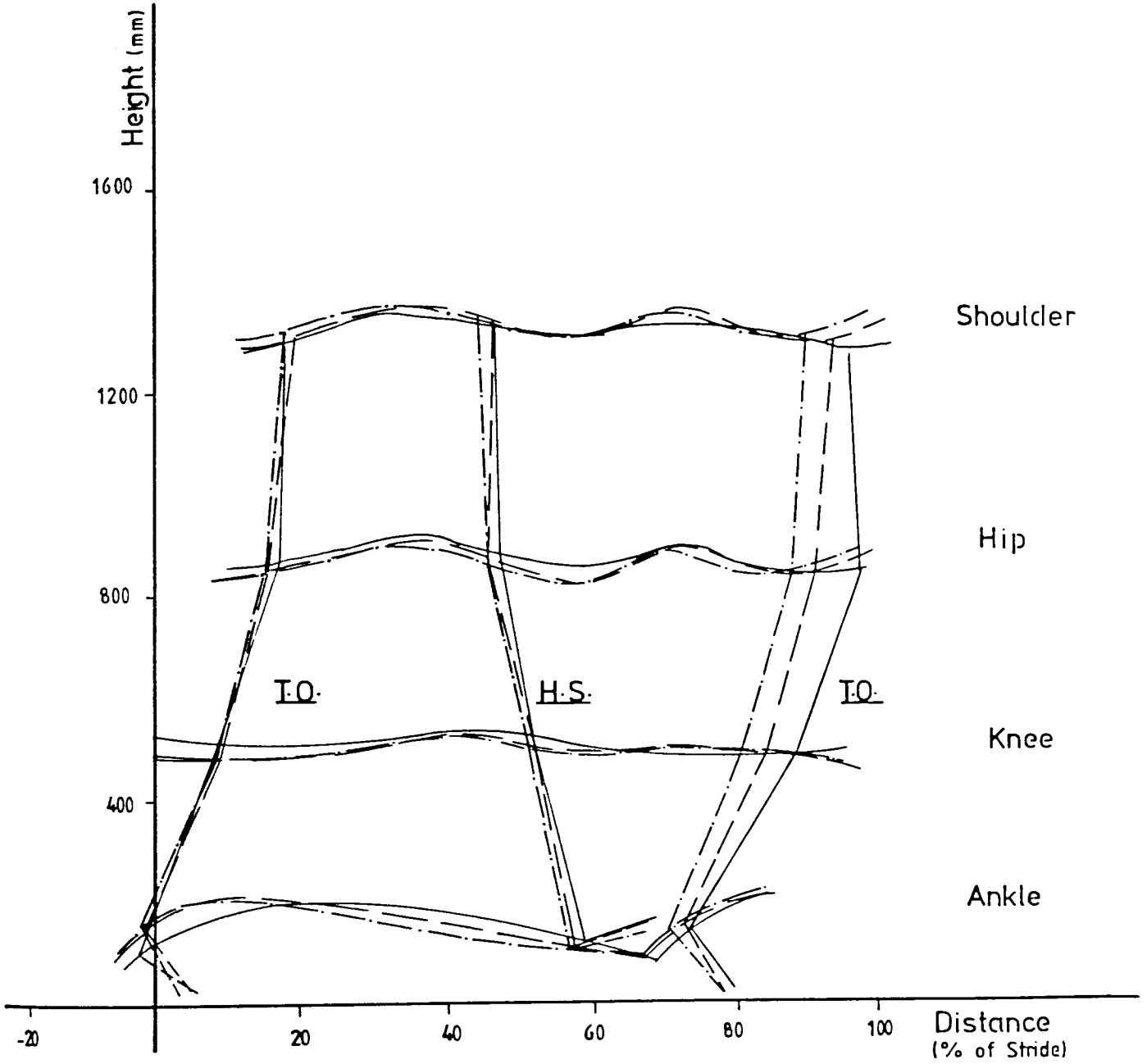

Fig. (6.5.1.4 b) - STICK DIAGRAM

height for the entire cycle. On the prosthetic side, the peak of the knee trajectory has increased during swing phase, but corresponded to that of optimum alignment during stance phase.

Overall, it seems that the effect of dorsiflexion (M2) of the prosthetic foot was more (than M1 and M3) apparent in that the trajectories of the sound limb were also affected by this mal-alignment.

Figures (6.5.1.4a & b) show the effect of two controlled mal-alignments on the above-knee amputee. Comparison between the two controlled mal-alignments (M1, plantarflexion of prosthetic foot and N5, extension of the socket) and the optimum alignment showed no significant differences in the shapes and peaks of the curves. Any differences in the magnitude of the trajectories lie within the repeatability range, and do not constitute any significant change.

6.5.2 ANGLE-TIME DIAGRAM

Figures (6.5.2.1a & b) show the angle-time diagram of the below-knee amputee under the three controlled mal-alignments (refer to 6.5).

On the sound side, the ankle, knee and hip angle-time diagram of mal-alignment M1 corresponds to that of the optimum alignment. The knee and hip angle-time diagrams of sound limb on mal-alignment M2 correspond to those of

Patient: BR004-Prosthetic

OPT. ALIGNMENT 1

- 1 - - - M1: PLANTAR FLEXION
- 2 - . - . M2: DORSIFLEXION
- 3 - ■ - ■ M3: ABDUCTION

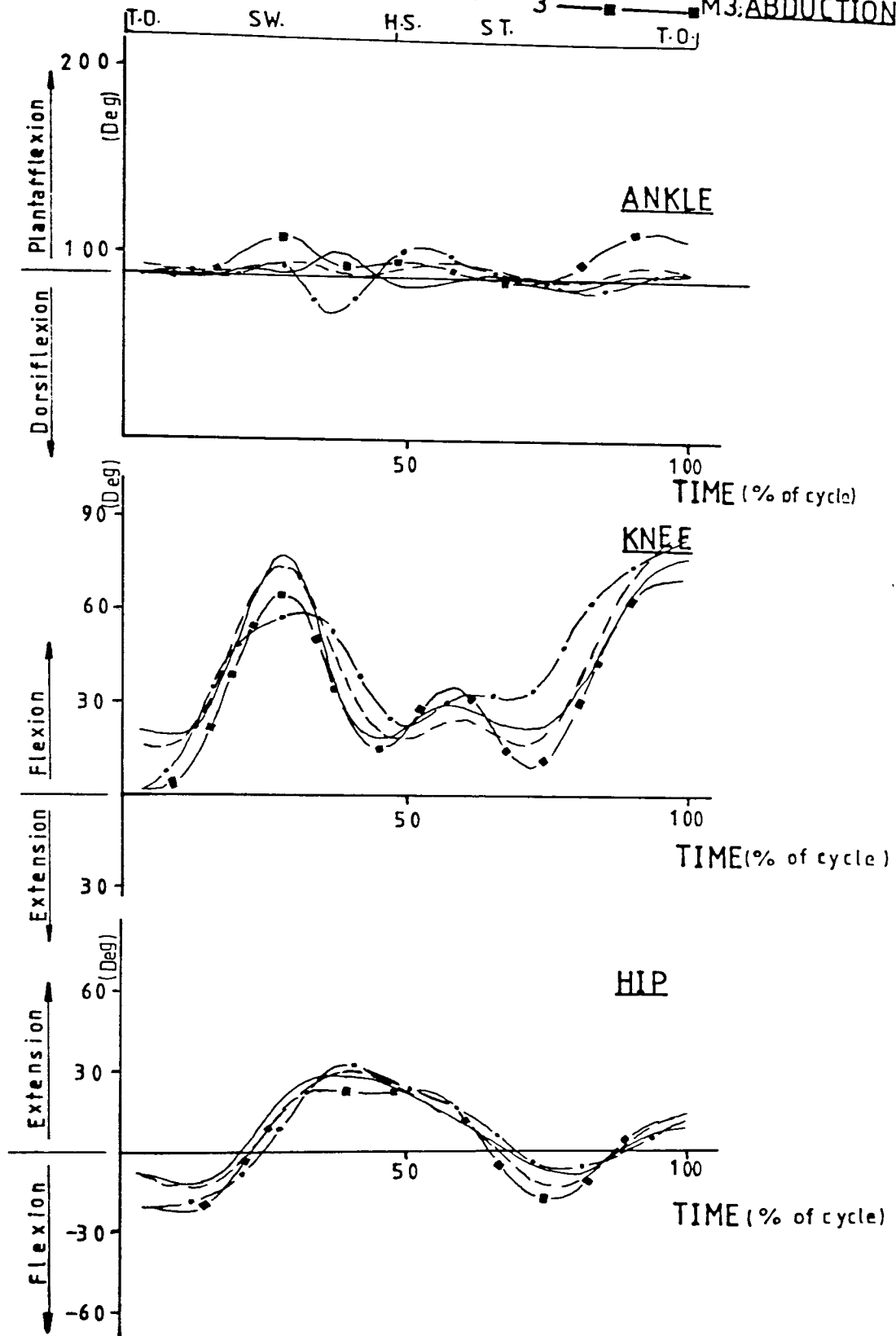

Fig(6.5.2.1a) ANGLE-TIME DIAGRAM

Patient: BR 00 4-Sound

- OPT-ALIGNMENT 1
- 1 - - - M1: PLANTAR FLEXION
- 2 - · - · M2: DORSIFLEXION
- 3 - ■ - ■ M3: ABDUCTION

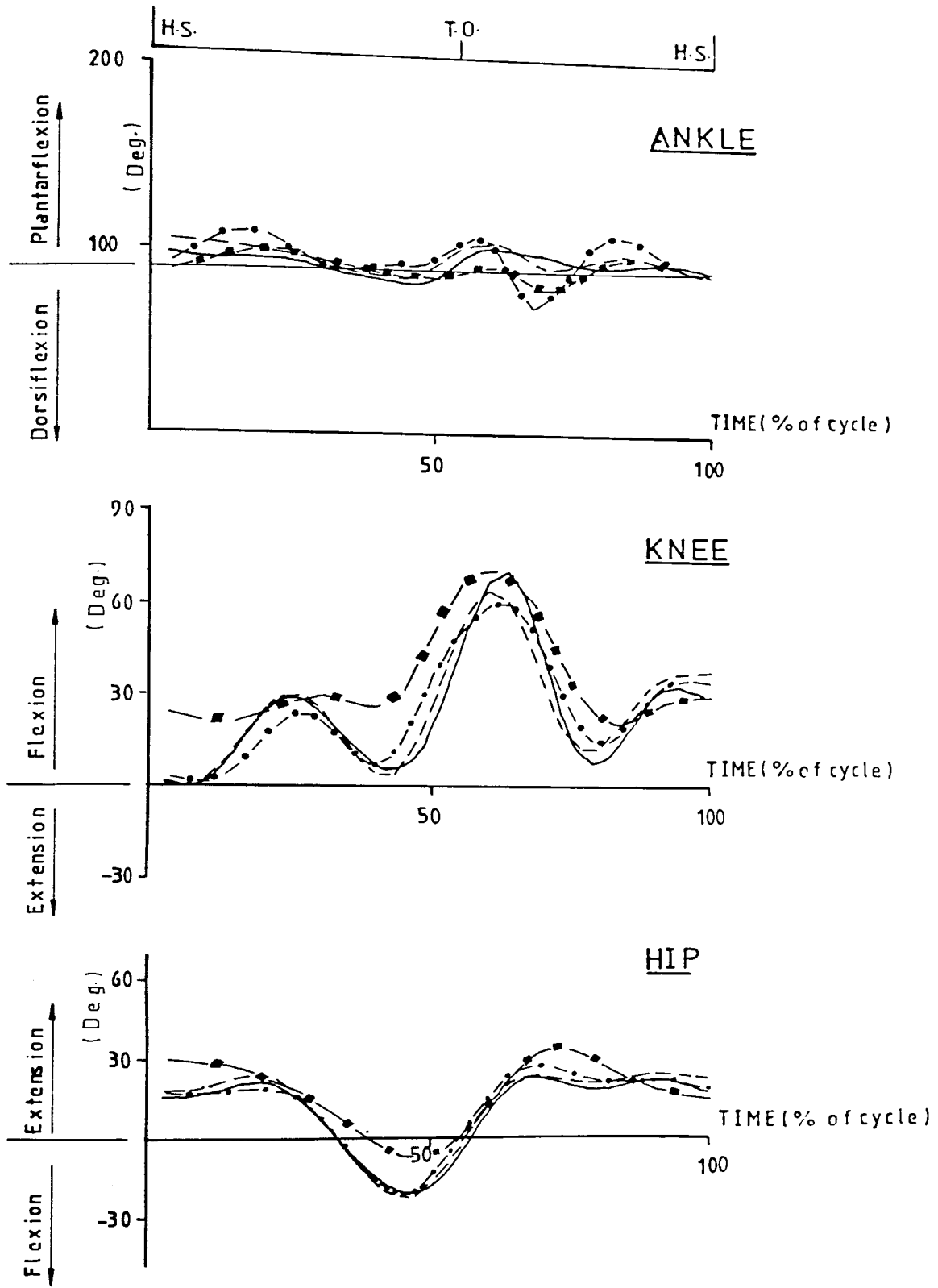

Fig. (6.5.21. b) ANGLE-TIME DIAGRAM

optimum alignment. During the swing phase the sound ankle joint registered 16 degrees dorsiflexion. The sound limb on mal-alignment M3 performed differently to the optimum alignment in that the knee was in 30 degrees flexion throughout the stance phase, and flexion of hip did not exceed 6°. On the prosthetic side, the hip angle-time diagrams of mal-alignments M1, M2 and M3 were similar to those of optimum alignment. The differences between ankle angle-time and knee angle-time of mal-alignments M1 and M3 and the optimum alignment were insignificant and lie within the repeatability range. However, the effect of dorsiflexion of the prosthetic foot (M2) on ankle angle-time resulted in dorsiflexion during early swing phase, and decrease in knee flexion.

Figures (6.5.2.2a & b) show the angle-time diagrams for the above-knee amputee under the two controlled mal-alignments (refer to 6.5).

There are no significant differences between the ankle, knee and hip angle-time diagram of the sound limb on either of the mal-alignments and the optimum alignment. On the prosthetic side, the differences between the hip, knee and ankle joint angles of the mal-alignments and the optimum alignments are not significantly large, in that they lie within the repeatability range and hence do not constitute a substantial variation in amputees' gait pattern.

6.5.3 ANGLE-ANGLE DIAGRAM

Figures (6.5.3.1a & b) show the knee/hip angle-angle

Patient: AR005 - Prosthetic

————— OPT ALIGNMENT
 1 - - - - M1; PLANTAR FLEXION
 2 - · · · · N5; SOCKET EXTENSION

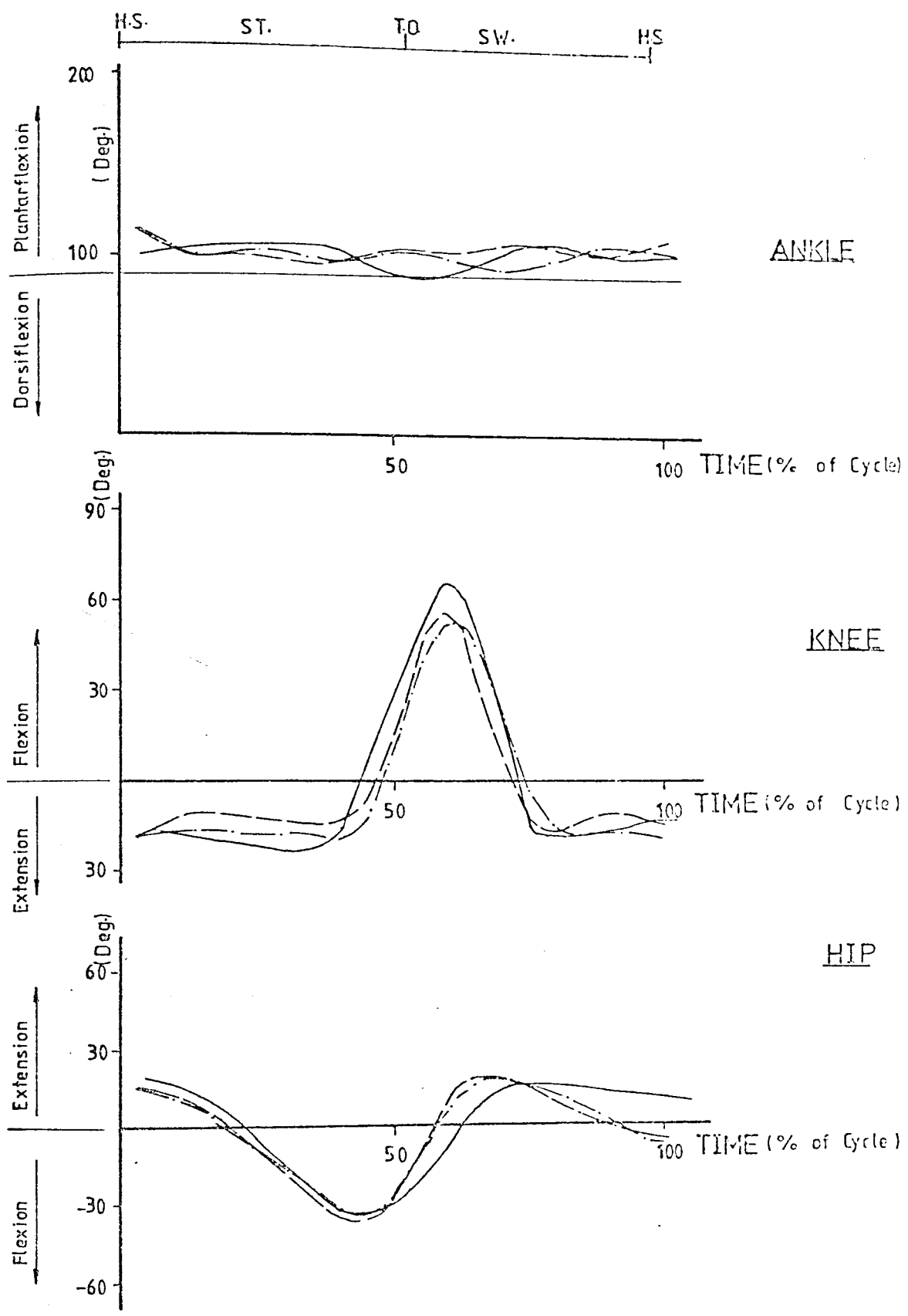

Fig. (G.5.2.2 a) ANGLE-TIME DIAGRAM

Patient: AR005-Sound

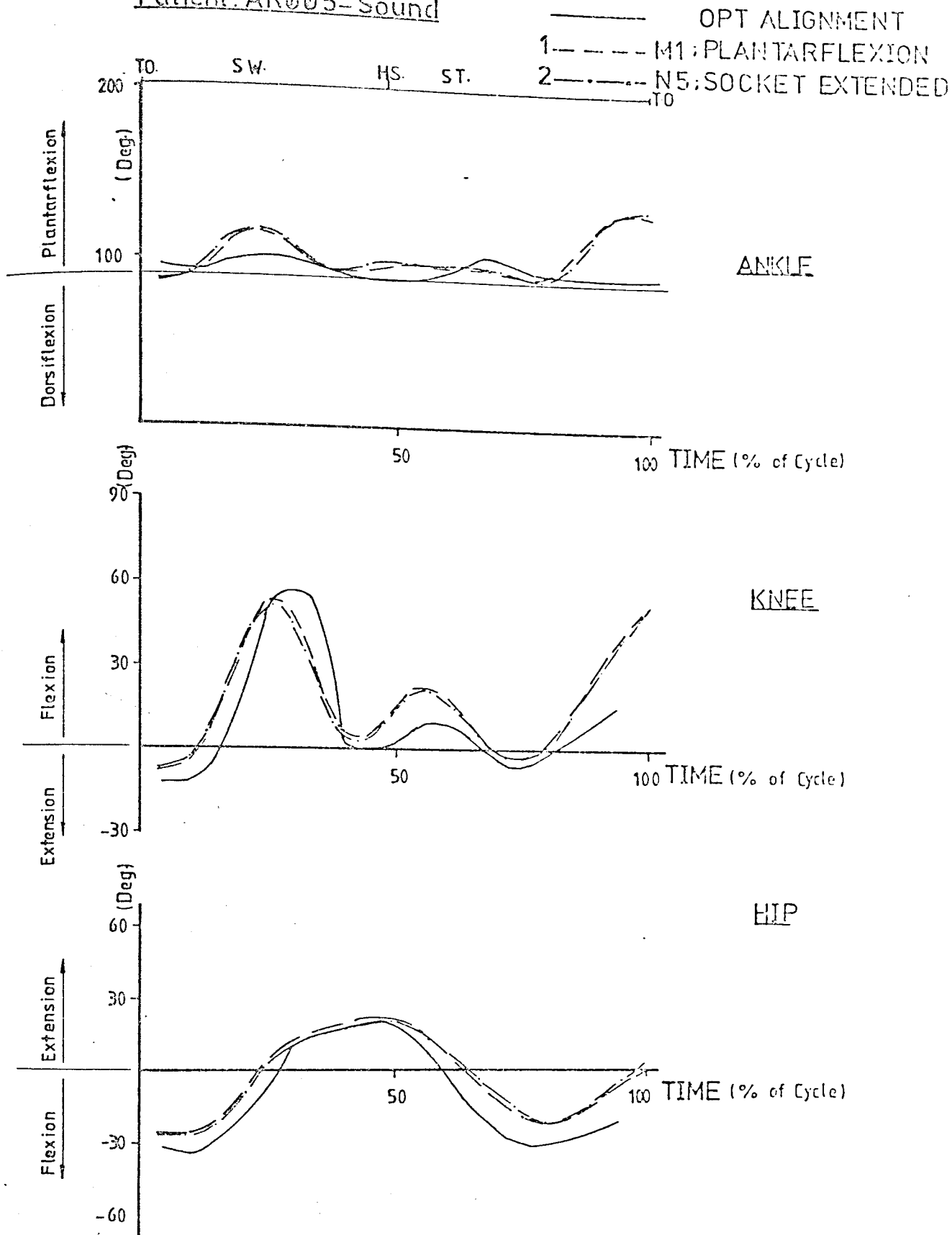

Fig. (6.5.2.2 b) ANGLE-TIME DIAGRAM

diagram for the below-knee amputee for the three controlled mal-alignments.

With the prosthetic foot plantarflexed, the sound side showed a small difference in the knee flexion during stance phase, in that it was higher than that recorded with the optimum alignment, being approximately 6° higher. Also, during mid-swing knee flexion was 6° lower than that recorded with the optimum alignment. On the prosthetic side, knee flexion was greater than that with the optimum alignment during stance phase, and greater hip extension occurred during late stance to early swing. Overall, the patterns and angulations of the knee and hip did not significantly differ from those of optimum alignment. Comparison between the effect of dorsiflexion of the prosthetic foot and the optimum alignment on the sound side shows that during heel-strike the knee flexion was lower than the optimum alignment and mal-alignment M1, being approximately 5° , also during swing phase knee flexion was approximately 10° lower than that recorded on the optimum alignment. The prosthetic side showed a significant difference in the knee flexion during mid-stance and swing phase. Although heel-strike occurred at approximately the same angle of the knee and hip as that of optimum alignment, the flexion of the sound knee on the prosthetic side increased by 12° during late stance. The prosthetic swing of this mal-alignment was significantly different to that of optimum alignment in that knee flexion was decreased by 17° during mid-swing and consequently a rounded pattern of angle-angle diagram was recorded.

Patient: BR004

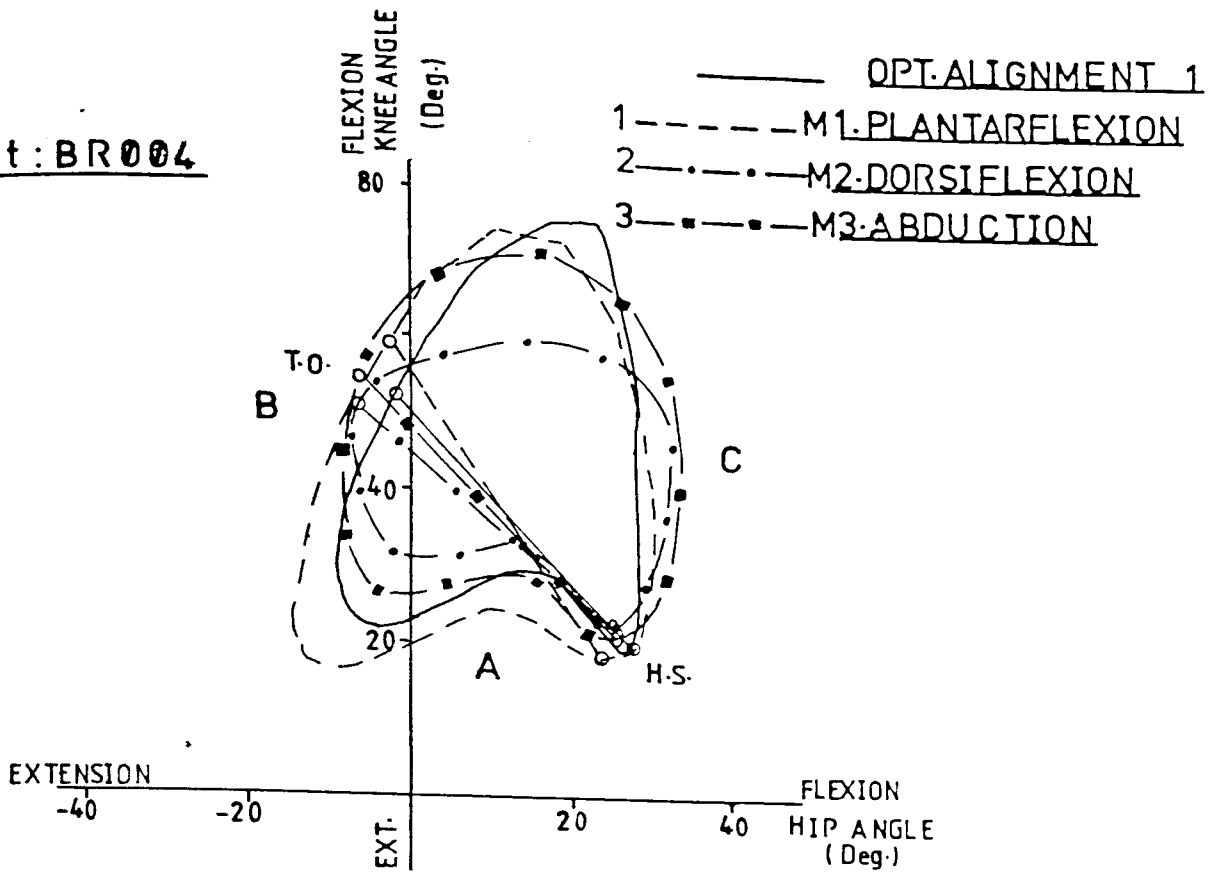

Fig.(6.5.3.1a)-Prosthetic

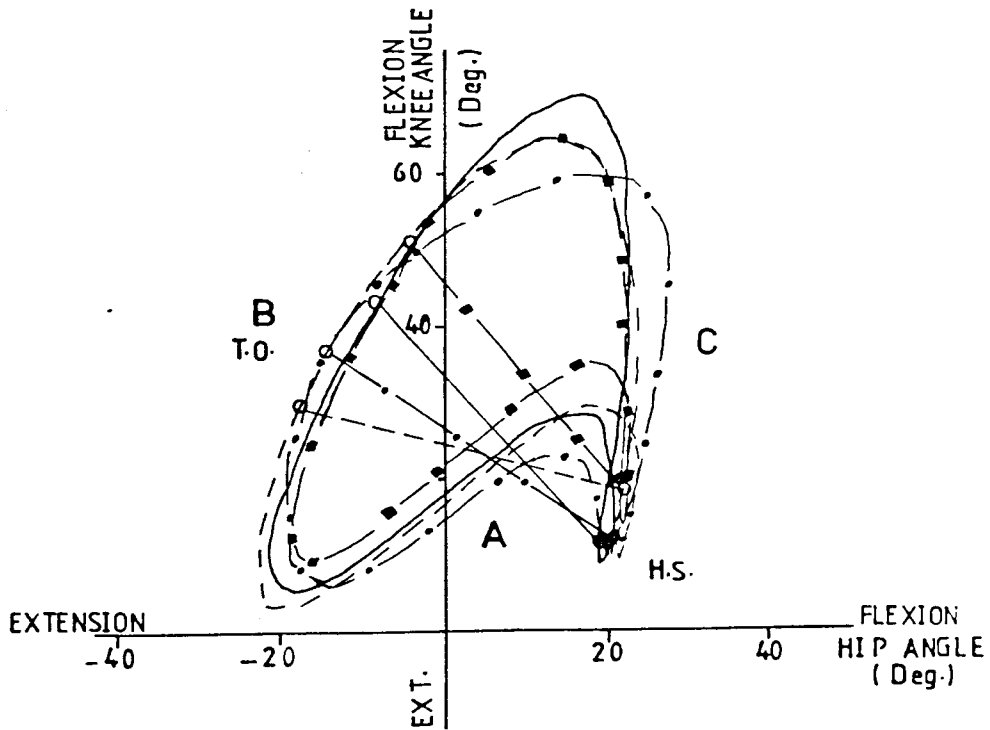

Fig.(6.5.3.1b)-Sound

KNEE-HIP ANGLE / ANGLE DIAGRAM

Abduction of the prosthetic foot only affected the sound stance phase, in that the knee flexion had increased more than that recorded on optimum alignment and mal-alignment M1, by approximately 5°.

The pattern of the prosthetic knee/hip angle-angle diagram of M3 differed from that of the optimum alignment. Major differences occurred during early swing where hip extension was decreased; mid-swing, where knee flexion was decreased and during late swing where hip flexion had increased.

Table (6.5.3.1) shows the areas covered by the knee/hip angle-angle diagram by the different alignments.

TABLE (6.5.3.1) AREAS OF ANGLE-ANGLE DIAGRAM, BK PATIENT BR ØØ4

Alignment	Area (cm ²)	
	Sound	Prosthetic
Optimum Alignment	14.70	15.00
M1 Plantarflexion of the prosthetic foot	15.75	18.90
M2 Dorsiflexion of prosthetic foot	16.47	10.90
M3 Abduction of Prosthetic foot	13.32	16.38

Comparison between the areas of the sound side and the prosthetic side shows that the prosthetic side occupied a significantly smaller area than the sound side on mal-

alignment M2. Effects of mal-alignments M1 and M3 on the prosthetic side have manifested themselves by occupying somewhat larger areas than the optimum alignment. The areas covered by the sound side are similar to each other and to the optimum alignment. Table (6.5.3.2) shows the gradients of slopes A, B and C where A represents stance, B early swing and C, swing phase.

TABLE (6.5.3.2) GRADIENTS OF ANGLE-ANGLE DIAGRAM, BK PATIENT BRØØ4

	Sound			Prosthetic		
	A	B	C	A	B	C
Optimum Alignment	0.8	2.15	16.7	0.4	2.0	16.67
M1 Plantarflexed foot	0.76	2.12	13.3	0.47	3.36	4.0
M2 Dorsiflexed foot	0.68	3.75	6.14	0.25	9.2	4.0
M3 Abducted foot	0.9	2.24	13.6	0.3	5.6	6.6

Comparison between optimum alignment and mal-alignment M1 shows no significant differences on the gradients of the sound limb. However, the gradient in the swing phase (C) for mal-alignment M1 differs to that of optimum alignment, indicating a change in hip flexion angle with mal-alignment M1. During the sound swing phase for mal-alignment M2, the slope is indicative of the reduction in hip flexion angle as the sound leg approaches heel-strike. Hip extension of the prosthetic side is larger with mal-alignment M2 than that with optimum alignment. The gradients at the slopes of the sound side under mal-alignment M3 do not significantly

differ from those for optimum alignment. However, on the prosthetic side, large differences exist between the slopes "B" and "C" of mal-alignment M3 and those recorded with optimum alignment.

Figures (6.5.3.2a & b) show a typical knee/hip angle-angle diagram for the above-knee amputee (refer to 6.5). Comparison between the mal-alignments and the optimum alignment on the sound side shows that during early stance hip flexion was reduced with either of the mal-alignments. There is no knee flexion during prosthetic stance phase on mal-alignment N5 (socket extension). It is seen that throughout most of the stance phase the prosthetic knee did not flex.

As shown in table (6.5.3.3), there are no significant differences between the areas of the angle-angle diagrams covered by either of the limbs.

TABLE (6.5.3.3) AREAS OF ANGLE-ANGLE DIAGRAM, AK PATIENT ARØØ5

Alignment	Area (cm ²)	
	Sound	Prosthetic
Optimum alignment	13.14	30.15
M1 Plantarflexion of Prosthetic foot	14.22	27.45
N5 Extension of socket	13.77	28.26

Patient: AR005

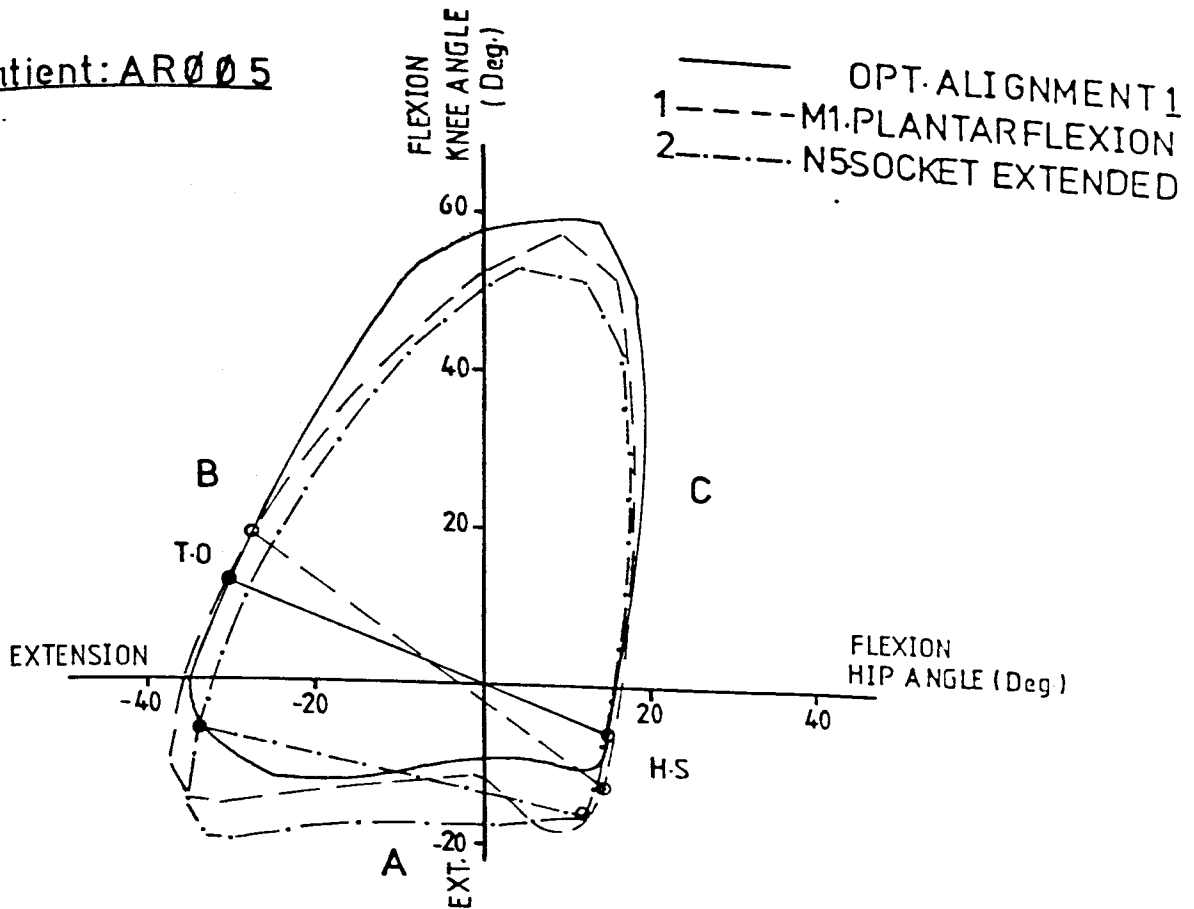

Fig. (G.5.3.2 a)-Prosthetic

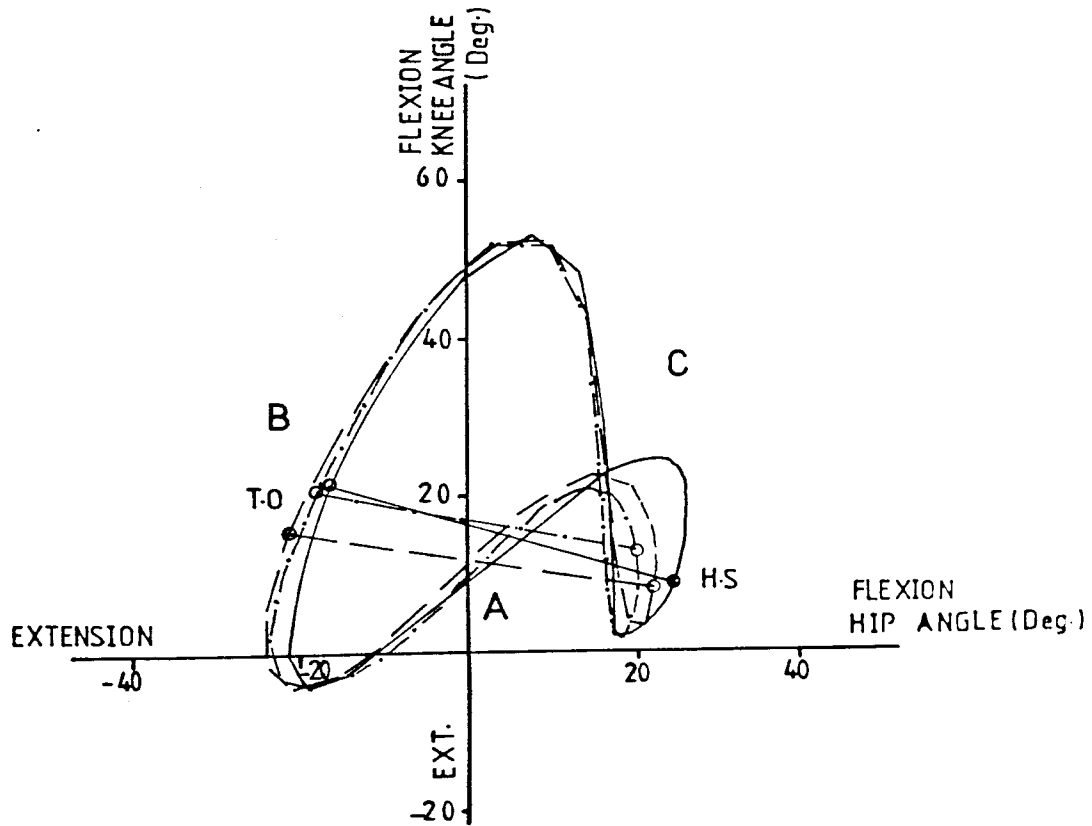

Fig. (G.5.3.2 b)-Sound

KNEE-HIP ANGLE/ANGLE DIAGRAM

The prosthetic limb manifested itself by occupying a significantly larger area than the sound knee in any of the alignments including the optimum alignment.

Table (6.5.3.4) shows the gradients of slopes A, B and C, where A represents the gradient at the slope of stance, B early swing and C, swing phase.

TABLE (6.5.3.4) GRADIENTS OF ANGLE-ANGLE DIAGRAM, AK PATIENT ARØØ5

Alignment	Sound			Prosthetic		
	A	B	C	A	B	C
Optimum alignment	0.85	2.63	14.00	0.75	2.00	7.5
M1 Plantarflexed foot	0.89	2.30	12.00	0.18	1.5	10.0
N5 Socket extended	1.00	2.18	12.75	0.09	1.8	9.5

On the prosthetic side the gradient of slope A of mal-alignment N5 shows that the slope was roughly parallel to X-axis (hip flexion/extension axis), indicating very little moment in the prosthetic knee.

The gradients of A, B and C of both mal-alignments M1 and N5, differ significantly to those of optimum alignment.

TABLE (6.5.3.5) AREAS OF ANGLE-ANGLE DIAGRAMS FOR CONTROLLED MAL-ALIGNMENTS

Patient	Alignment	Prosthetic	Sound
BRØØ4	01 Optimum alignment	20.34	14.85
	M1 Plantarflexion	18.90	15.75
	M2 Dorsiflexion	10.89	16.47
	M3 Abduction	16.38	13.22
BLØØ1	01 Optimum alignment	12.33	11.79
	M3 Abduction	13.59	20.88
BRØØ2	01 Optimum alignment	21.15	12.33
	M6 Foot forward	20.07	16.56
	M7 Toe out	19.26	13.95
ARØØ5	01 Optimum alignment	30.15	13.14
	M1 Plantarflexion	27.45	14.22
	M5 Extension of socket 1½ degrees	23.76	7.29
	N5 Extension of socket 3 degrees	28.26	13.77
ARØØ3	01 Optimum alignment	10.89	10.08
	M4 Knee tightened	15.84	12.42
	M1 Plantarflexion	10.98	11.97

The above table shows that the area of the angle-angle diagram on the prosthetic side was on average "smaller" than that on the sound side and that corresponding to the optimum alignment.

6.5.4 TEMPORAL PARAMETERS

Table (6.5.4.1) shows the temporal parameters of the below-knee amputee (refer to 6.5).

TABLE (6.5.4.1) TEMPORAL PARAMETERS, BK PATIENT BR004

Alignment	Sound					Prosthetic				
	Stance Duration (s)	Swing Duration (s)	Total Duration (s)	Stride (cm)	$\frac{SW}{st}$	Stance Duration (s)	Swing Duration (s)	Total Duration (s)	Stride (cm)	$\frac{SW}{st}$
Optimum alignment	0.66	0.36	1.02	151.8	0.54	0.66	0.42	1.08	150.2	0.63
M1 Plantarflexion	0.66	0.48	1.14	150.04	0.72	0.66	0.42	1.08	129.0	0.63
M2 Dorsiflexion	0.60	0.36	0.96	130.1	0.6	0.66	0.42	1.08	135.0	0.63
M3 Abduction	0.66	0.36	1.02	124.3	0.54	0.66	0.54	1.20	151.2	0.80

The recorded stance phase timings were for each mal-alignment consistent to those of the optimum alignment. The variation of the swing phase timings between the optimum alignment and the three mal-alignments were fairly small. The effect of mal-alignments M1 and M3 on the amputees' temporal parameters were variation in the stride length between the sound and the prosthetic sides. However, on mal-alignment M2, the amputees' stride length did not differ on each limb and the ratio of swing to stance phase remained approximately the same.

Table (6.5.4.2) shows the temporal parameters of the above-knee amputee (refer to 6.5). Although the stance and swing phase timings of the sound and the prosthetic limb on the mal-alignments correspond to those recorded on optimum alignment, the stride length was varied in each case. On mal-alignment N5, the stride length of the sound side has increased, whilst the stride length of the prosthetic side was reduced from those recorded on optimum alignment. The symmetry of gait was preserved with each mal-alignment in that the ratio of swing to stance phase remained the same for both limbs under each mal-alignment, but in turn the stride lengths were changed in each case.

TABLE (6.5.4.2) TEMPORAL PARAMETERS OF AK PATIENT ARØØ5

Alignment	Sound						Prosthetic					
	Stance Duration (s)	Swing Duration (s)	Total Duration (s)	Stride (cm)	$\frac{SW}{st}$	Stance Duration (s)	Swing Duration (s)	Total Duration (s)	Stride (cm)	$\frac{SW}{st}$		
Optimum alignment	0.74	0.54	1.28	142.9	0.72	0.84	0.54	1.38	153.0	0.64		
M1 Plantarflexion	0.78	0.54	1.32	151.8	0.69	0.78	0.54	1.32	155.9	0.69		
N5 Extension of socket	0.78	0.6	1.38	151.7	0.77	0.78	0.6	1.38	149.7	0.77		

TABLE (6.5.4.3) TEMPORAL PARAMETERS FOR OPTIMUM ALIGNMENTS

		Prosthetic						Sound			
Patient	Alignment	Duration			Stride (cm)	SW/st	Duration			Stride (cm)	SW/st
		Stance (s)	Swing (s)	Total (s)			Stance (s)	Swing (s)	Total (s)		
BRØØ4	01	0.78	0.60	1.38	141.6	0.77	0.84	0.54	1.38	142.1	0.64
	02	0.66	0.42	1.08	150.2	0.64	0.66	0.36	1.02	151.8	0.55
	03	0.72	0.36	1.08	144.0	0.50	0.66	0.42	1.08	136.6	0.64
BLØØ5	01	0.72	0.36	1.04	119.1	0.50	0.60	0.48	1.08	141.6	0.80
	02	0.66	0.42	1.08	151.0	0.64	0.66	0.42	1.08	150.3	0.64
ARØØ5	01	0.84	0.54	1.38	153.1	0.64	0.74	0.54	1.28	142.4	0.73
	02	0.84	0.48	1.32	146.9	0.57	0.78	0.66	1.44	122.7	0.85
ARØØ1	01	0.78	0.54	1.32	132.9	0.69	0.84	0.60	1.44	155.0	0.71
	02	0.75	0.50	1.28	122.5	0.67	0.84	0.54	1.38	148.7	0.64

TABLE (6.5.4.4) TEMPORAL PARAMETERS FOR CONTROLLED MAL-ALIGNMENTS

Patient	Alignment	Prosthetic						Sound			
		Duration (s)			Stride (cm)	SW/st	Duration (s)			Stride (cm)	SW/st
		Stance	Swing	Total			Stance	Swing	Total		
BR004	01 Optimum Alignment	0.72	0.36	1.08	144.0	0.50	0.66	0.42	1.08	136.6	0.64
	M1 Plantarflexion	0.66	0.42	1.08	129.0	0.64	0.66	0.48	1.14	150.4	0.73
	M2 Dorsiflexion	0.66	0.42	1.08	135.0	0.64	0.60	0.36	0.96	130.1	0.60
	M3 Abduction	0.66	0.54	1.20	151.2	0.82	0.66	0.36	1.02	124.3	0.55
BL001	01 Optimum Alignment	0.78	0.48	1.26	141.6	0.62	0.66	0.54	1.20	149.9	0.82
	M3 Abduction	0.78	0.54	1.32	122.6	0.69	0.72	0.54	1.26	121.7	0.75
BR002	01 Optimum Alignment	0.60	0.36	0.96	154.4	0.60	0.66	0.36	1.02	121.8	0.55
	M6 Foot Forward	0.66	0.54	1.20	156.9	0.82	0.72	0.42	1.14	129.4	0.51
	M7 Toe Out	0.66	0.48	1.14	162.7	0.73	0.60	0.48	1.08	144.7	0.80
AR005	01 Optimum Alignment	0.84	0.54	1.38	153.1	0.64	0.74	0.54	1.28	142.7	0.73
	M1 Plantarflexion	0.78	0.54	1.32	155.9	0.69	0.78	0.54	1.32	151.8	0.69
	M5 Extension of socket 1 $\frac{1}{2}$ ₀	0.70	0.48	1.18	145.0	0.69	0.72	0.60	1.32	145.7	0.83
	N5 Extension of socket 3 $\frac{0}{0}$	0.78	0.60	1.38	149.0	0.77	0.78	0.60	1.38	151.7	0.77
AR003	01 Optimum Alignment	0.78	0.48	1.26	120.6	0.62	0.9	0.42	1.32	117.4	0.47
	M4 Knee Tightened	0.72	0.60	1.32	116.4	0.83	0.78	0.48	1.26	133.9	0.62
	M1 Plantarflexion	0.78	0.60	1.38	136.4	0.77	0.78	0.48	1.26	119.2	0.62

The above table shows that generally, the temporal parameters demonstrated that there was gait symmetry associated with "optimum" alignment. The symmetry was lost when the prosthesis was mal-aligned.

6.6 EFFECT OF VARIOUS SPEEDS OF WALKING ON THE AMPUTEES' GAIT PATTERN AND THE TEMPORAL PARAMETERS

This section of the work involves only one below-knee patient walking at three different speeds under optimum alignment conditions. The speeds of walking were as follows:

- 1) Slow: 1.03 m/s (Patient's preferred speed)
- 2) Normal: 1.29 m/s
- 3) Fast: 1.44 m/s.

However, since only one BK patient is considered, the discussion does not refer to a general understanding and at this stage is insufficient for any conclusive results to be drawn.

6.6.1 STICK DIAGRAM

In this section the trajectories of the joint centres of the lower limb and shoulder of the below-knee amputee walking at three different speeds are considered. The amputee's preferred speed of walking was 1.03 m/s, and the effect of two other speeds, ie. 1.29 m/s and 1.44 m/s was recorded.

Figures (6.6.11 a and b) show the superimposed shoulder, hip, knee and ankle trajectories at three speeds.

Patient : B R 004-Prosthetic

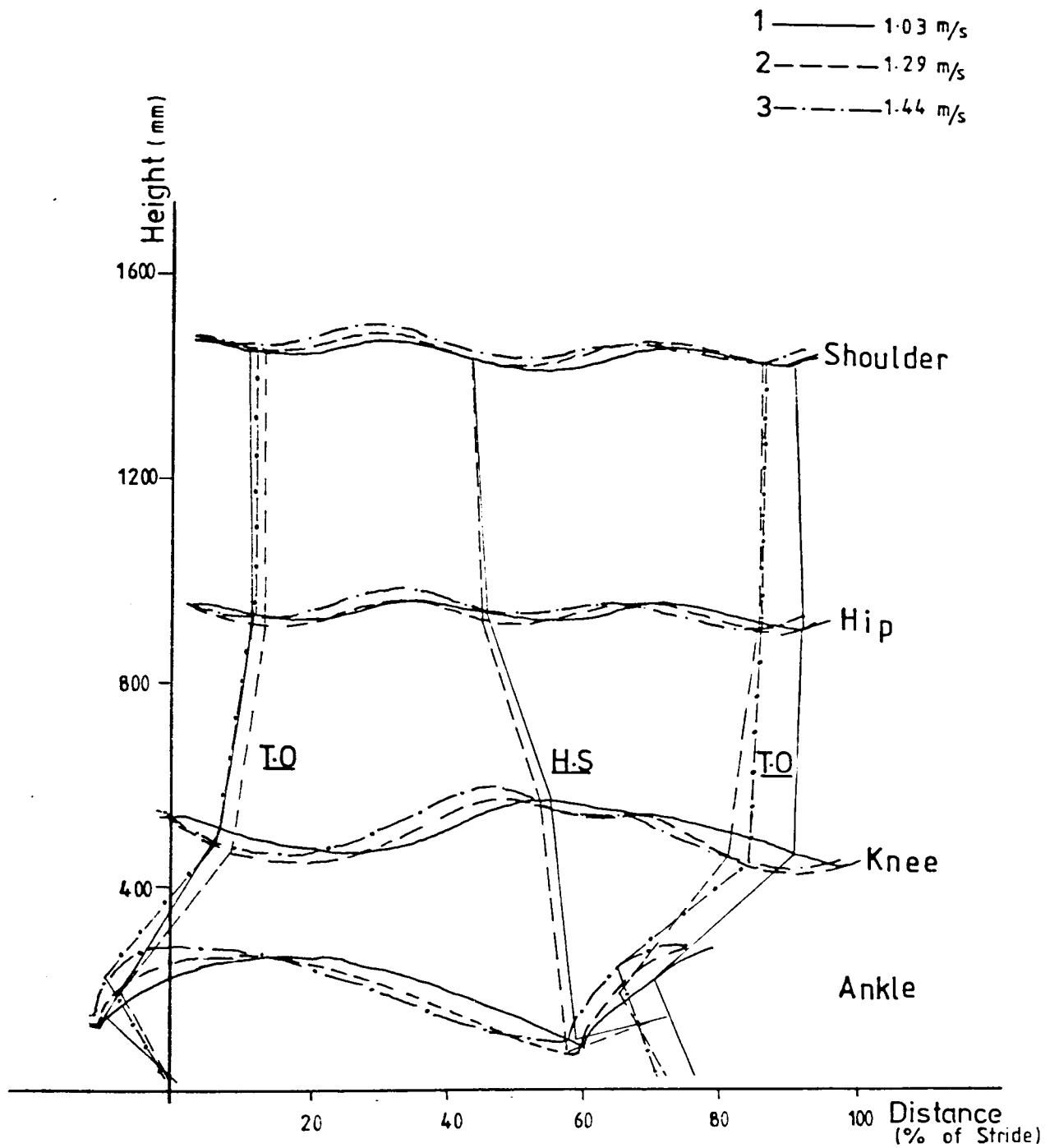

Fig.(6.6.1.1.a)-STICK DIAGRAM

Patient: BR004-Sound

- 1 ——— 1.03 m/s
- 2 - - - 1.29 m/s
- 3 ····· 1.44 m/s

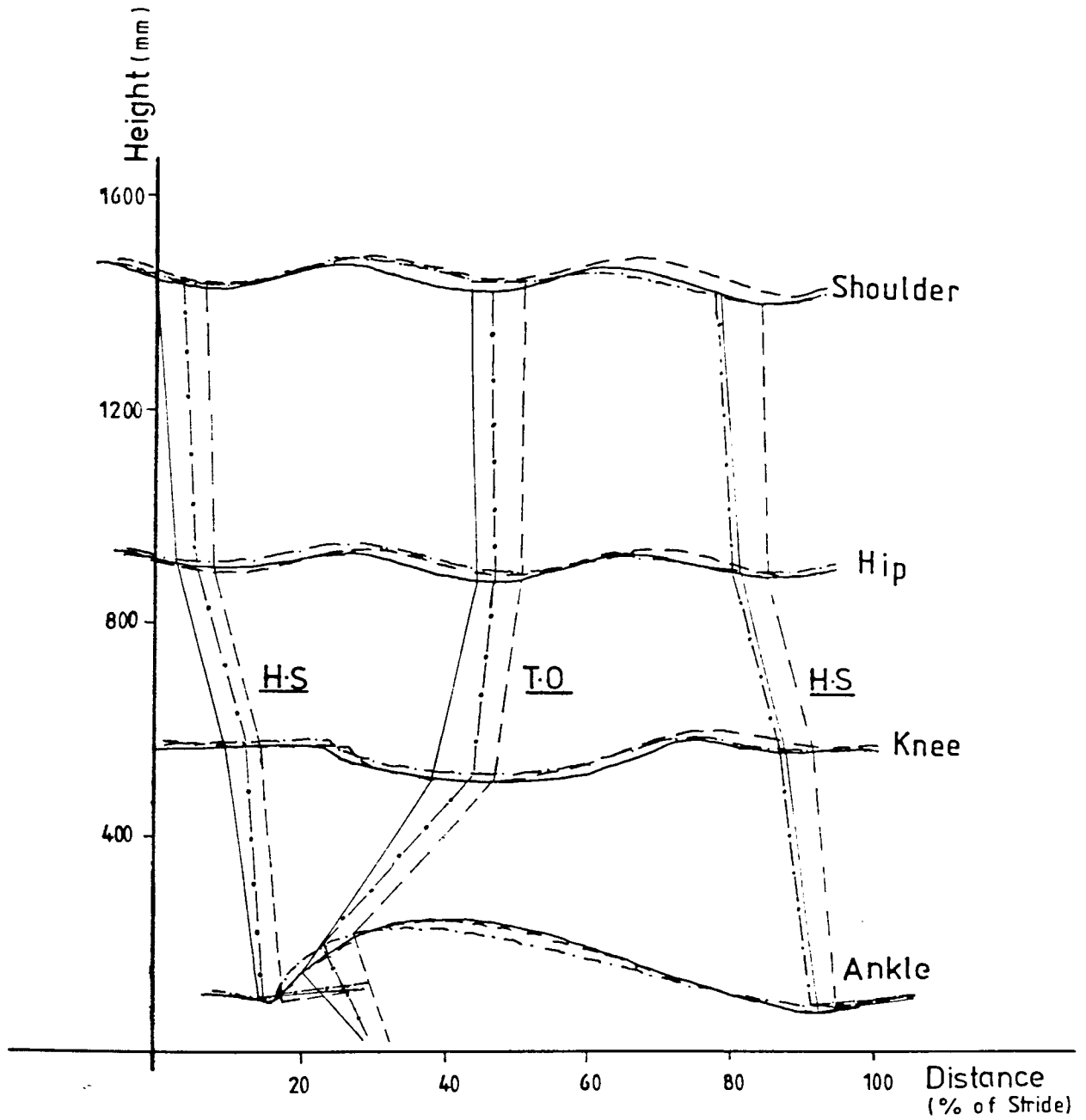
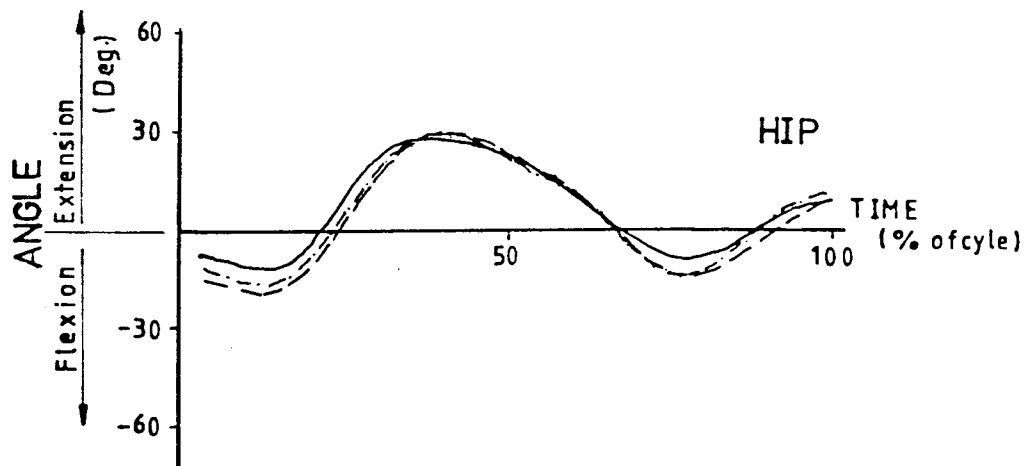
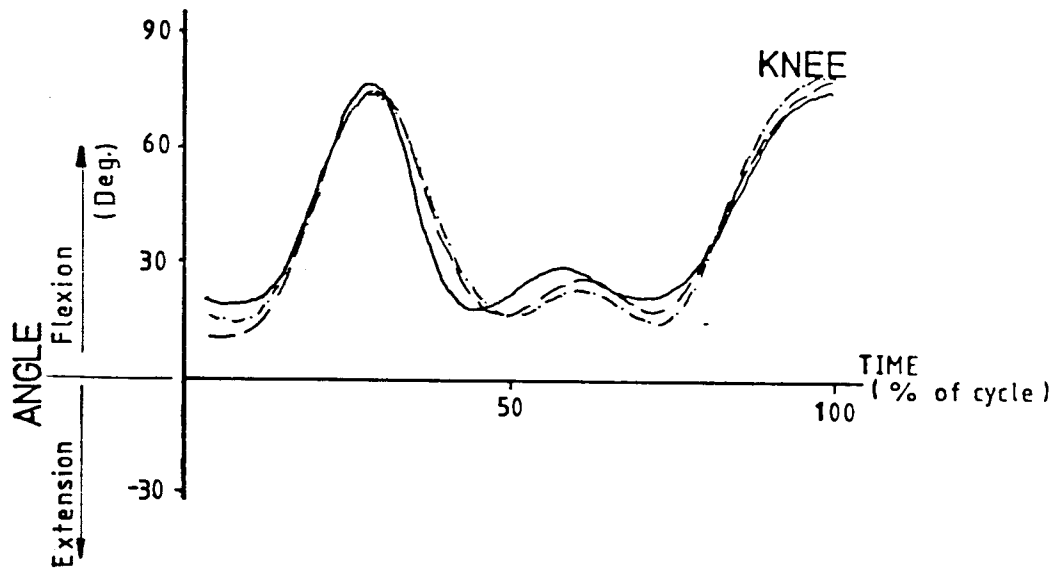
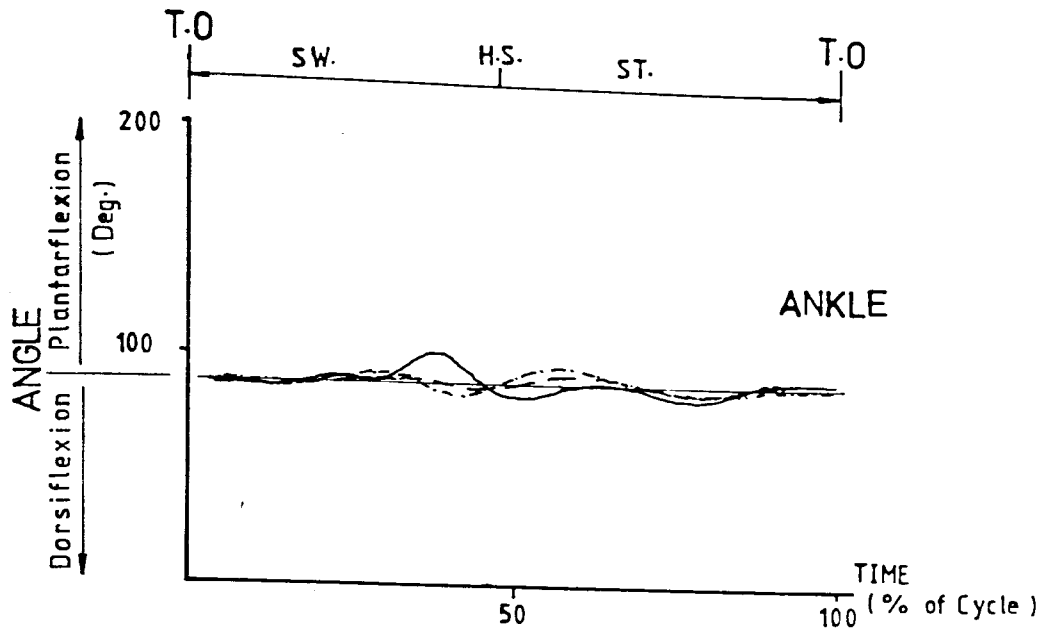

Fig.(6.6.1.1.b) STICK DIAGRAM

PATIENT: BR004 - PROSTHETIC

- 1. ——— 1.03 m/s
- 2. - - - 1.29 m/s
- 3. ····· 1.44 m/s



Fig(G-G-21c) ANGLE-TIME DIAGRAM

Patient: BR 004 - Sound

- 1. ——— 1.03 m/s
- 2. - - - - 1.29 m/s
- 3. ····· 1.44 m/s

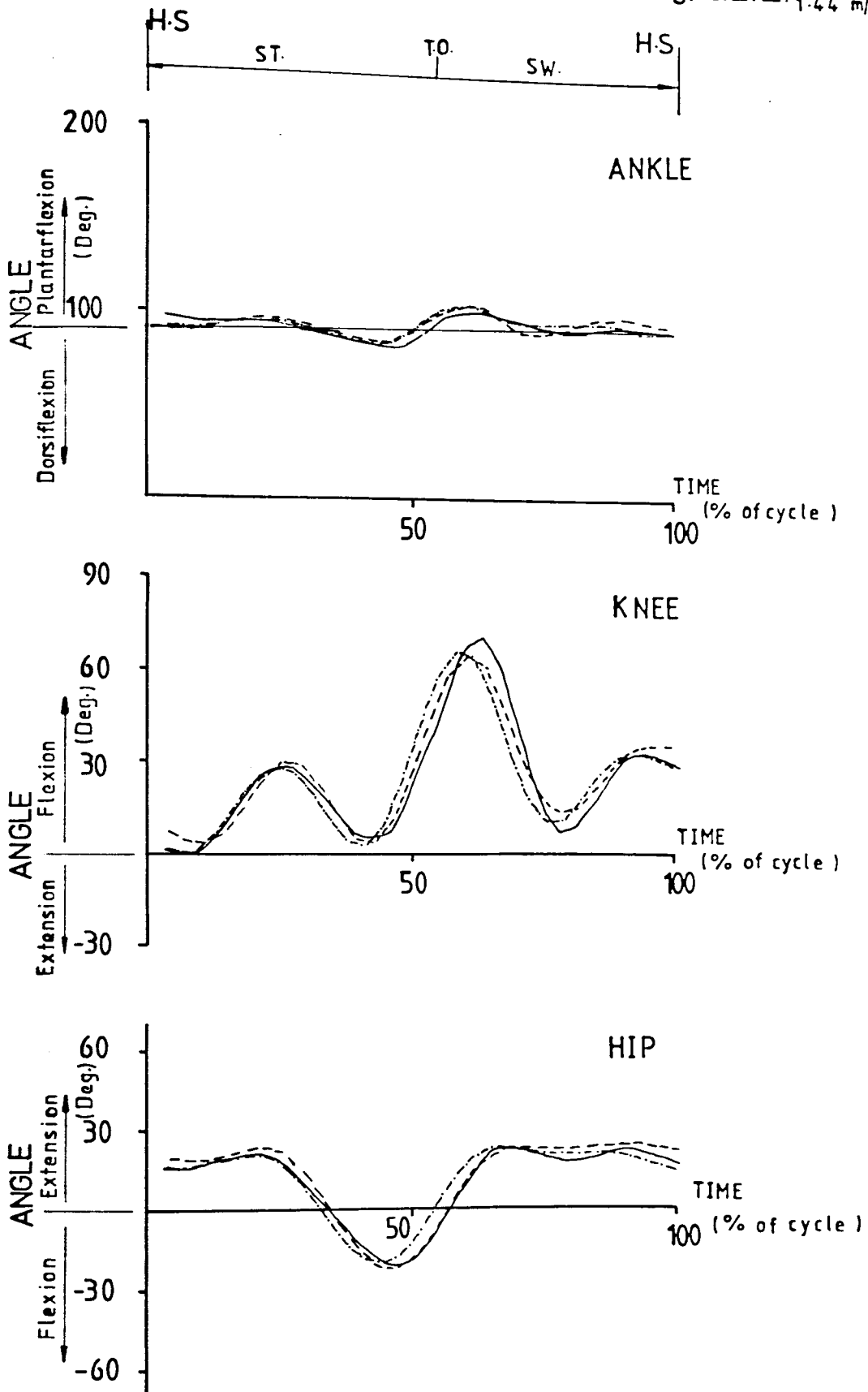

Fig. (G-6-2-1 b) ANGLE-TIME DIAGRAM

The joint trajectories of the sound limb at different speeds significantly correspond with each other and any differences in the magnitudes of the curves are within the repeatability range, ie., within ± 1.5 cm., which does not constitute a significant change.

When the amputee was not walking at his normal speed, ie., 1.29 m/s and 1.44 m/s, the magnitude at knee trajectories of the prosthetic side sharply increased during mid-swing.

Comparison between the ankle trajectories of speeds 1.03 m/s and 1.29 m/s shows differences in magnitude of ankle trajectory at 1.29 m/s during stance and swing phase.

Although differences are seen in the trajectories of the prosthetic side, the overall patterns correspond with each other, and any differences in the magnitudes are within the repeatability range.

6.6.2 ANGLE-TIME DIAGRAMS

Figures (6.6.2.1a & b) show the angle-time diagrams of the below-knee patient described in section 6.6.1.

The general pattern of all the curves, and the angles at the ankle, knee and hip joints, have not been much affected by different speeds of walking.

On the sound side the curves do not change with speed.

The small variations observed on the prosthetic side are very insignificant and fall within the repeatability range of $\pm 7^\circ$.

Overall, there are no detectable differences in the variation of ankle, knee and hip angles with respect to time as a function of varying speeds.

6.6.3 ANGLE-ANGLE DIAGRAM

Figures (6.6.3.1a & b) show the knee versus hip angle-angle diagram for the below-knee amputee walking at three different speeds, 1.03 ms^{-1} (amputee's normal speed), 1.29 ms^{-1} and 1.44 ms^{-1} .

The sound side shows insignificant differences between the knee/hip angle-angle diagrams at the three speeds. On the prosthetic side, the knee flexion during stance phase varied with speed. When the amputee was walking at 1.03 ms^{-1} , knee flexion during stance phase was 6° more than that of the fastest speed, 1.44 ms^{-1} . However, 6° is within the acceptable range. This difference in knee flexion was maintained during early stance. During late stance and early swing, extension of the hip at speeds of 1.29 ms^{-1} and 1.44 ms^{-1} , was 7° more than that of the normal speed, 1.03 ms^{-1} . The swing phase of the three speeds corresponded with each other. Nevertheless, the loops follow a consistent pattern and any differences in the angles of the knee and hip are within the $\pm 7^\circ$ scatter.

Patient: BR 004

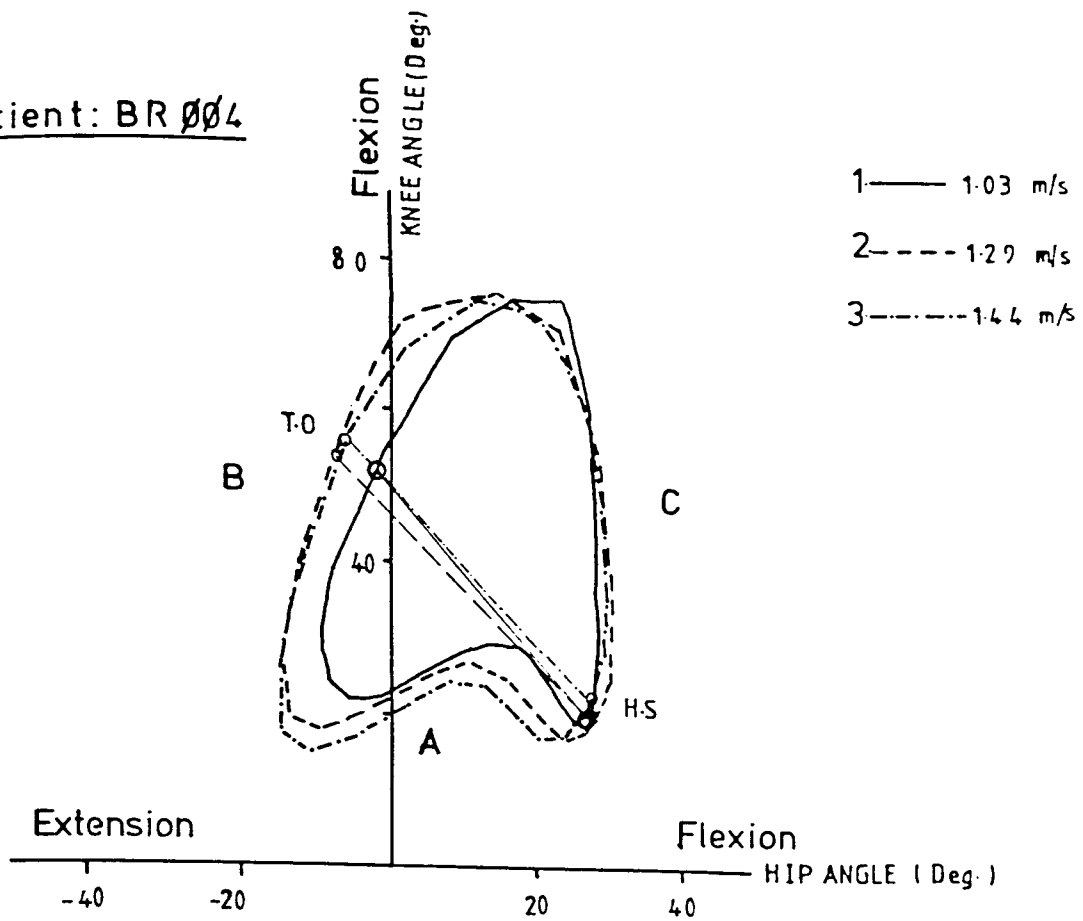

Fig. (6-G-31 a) - Prosthetic

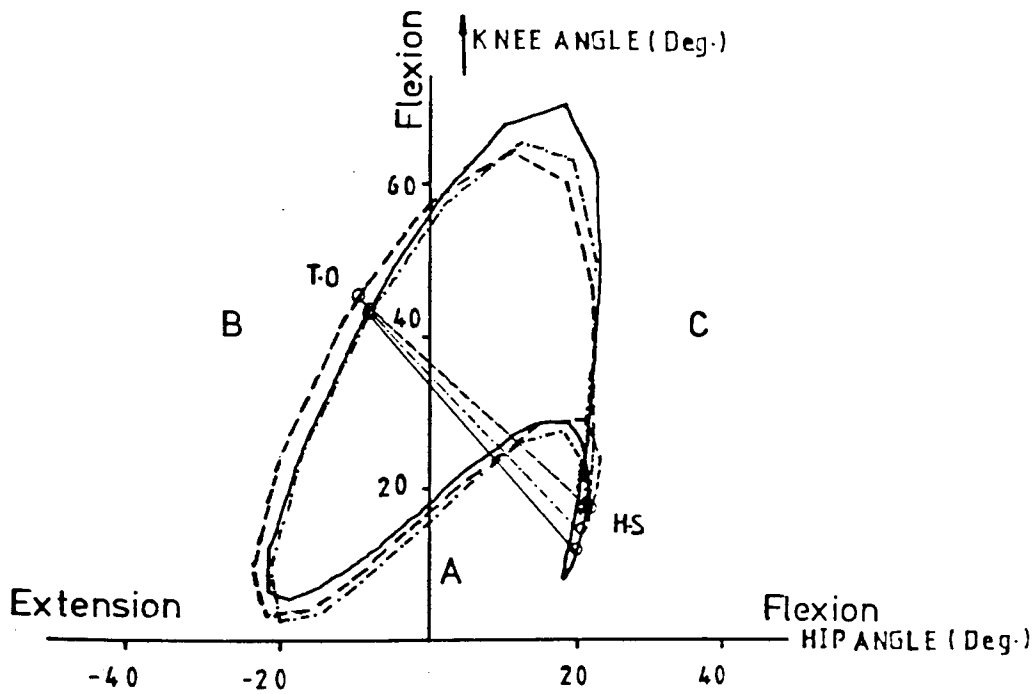

Fig. (6-G-31 b) - Sound

KNEE-HIP ANGLE/ANGLE DIAGRAM

Table (6.6.3.1) shows the areas of the knee/hip angle-angle diagram for the sound side and the prosthetic limbs walking at three different speeds.

TABLE (6.6.3.1) AREAS OF ANGLE-ANGLE DIAGRAM FOR BK PATIENT BRØØ4

Alignment	Speed	Area (cm ²)	
		Sound	Prosthetic
1	1.03	14.67	15.6
2	1.29	14.85	20.5
3	1.44	15.66	19.9

On the sound side, the smallest area is covered by the lowest speed, ie. 1.03 m/s and for the largest area of 15.66 cm², the highest speed is recorded. On the prosthetic side, the largest area was covered at a speed of 1.29 m/s. The difference in area on the prosthetic side between the speeds of 1.29 m/s and 1.44 m/s is insignificant. However, there is a significant difference between the area corresponding to the lowest speed and the higher speeds. Overall, the prosthetic side manifests itself by occupying a larger area of knee/hip angle-angle diagram.

6.6.4 TEMPORAL PARAMETERS

Table (6.6.4.1) shows the temporal parameters for a below-knee amputee walking at three different speeds for an optimum alignment.

TABLE (6.6.4.1) TEMPORAL PARAMETERS OF A BELOW-KNEE PATIENT, BR004, AT THREE DIFFERENT SPEEDS

Test	Speed (m/s)	Stance duration (s)	Swing duration (s)	Total duration (s)	Stride (cm)	Ratio of SW/st
1	1.03	0.84	0.54	1.38	142.1	0.64
2	1.29	0.66	0.42	1.08	136.6	0.63
3	1.44	0.66	0.36	1.02	151.8	0.54

SOUND SIDE

1	1.03	0.78	0.60	1.38	141.6	0.76
2	1.29	0.72	0.36	1.08	144.0	0.50
3	1.44	0.66	0.42	1.08	150.7	0.63

PROSTHETIC SIDE

From the table above both the sound and the prosthetic limbs have the longest stance and swing phase duration at a speed of 1.03 ms^{-1} which was the amputee's normal speed. However, the stance phase duration of the sound side was longer than that of the prosthetic side and consequently the swing phase of the prosthetic side was longer than that of the sound side. This corresponds to UCB (1947) and Breakey (1976) findings (see section 3.7). Although the total time (swing and stance) was consistent between the two limbs, the stride length of the prosthetic side was longer than on the sound side.

The ratio of swing to stance phase duration of the sound side corresponded to that of the normal subject reported by Murray et al (1964), at speeds 1.03 m/s and

and 1.29 m/s. For the prosthetic side, the symmetry between the swing and stance was maintained only for a speed of 1.44 m/s.

Overall, gait symmetry as defined from the temporal parameters observed between the sound and the prosthetic limb of the below-knee amputee is not maintained, and this is more apparent at the amputee's normal speed, 1.03 m/s.

6.7 ASSESSMENT OF VARIOUS "OPTIMUM" ALIGNMENTS

This section considers the effect on the gait pattern of a below-knee and an above-knee amputee, under different, yet "optimum" alignment configurations. One patient from each category will be considered.

6.7.1 BELOW-KNEE AMPUTEE

The geometrical positions of the prostheses for two acceptable alignments are shown in Figure (6.7.1.1). Whilst the patient and prosthesis were held constant the different alignments relate to different prosthetists. However, both alignments were considered to be satisfactory by both patient and the prosthetist. The prosthesis displays less forward shift of the foot and a 3° greater tilt of the socket in the anterior-posterior plane for "alignment 1" compared with "alignment 2". There is little difference in the mediolateral plane with the exception of "alignment 1" displaying a slight amount of foot set-in.

Patient: BL 005

— OPT-ALIGNMENT 1
 — OPT-ALIGNMENT 2

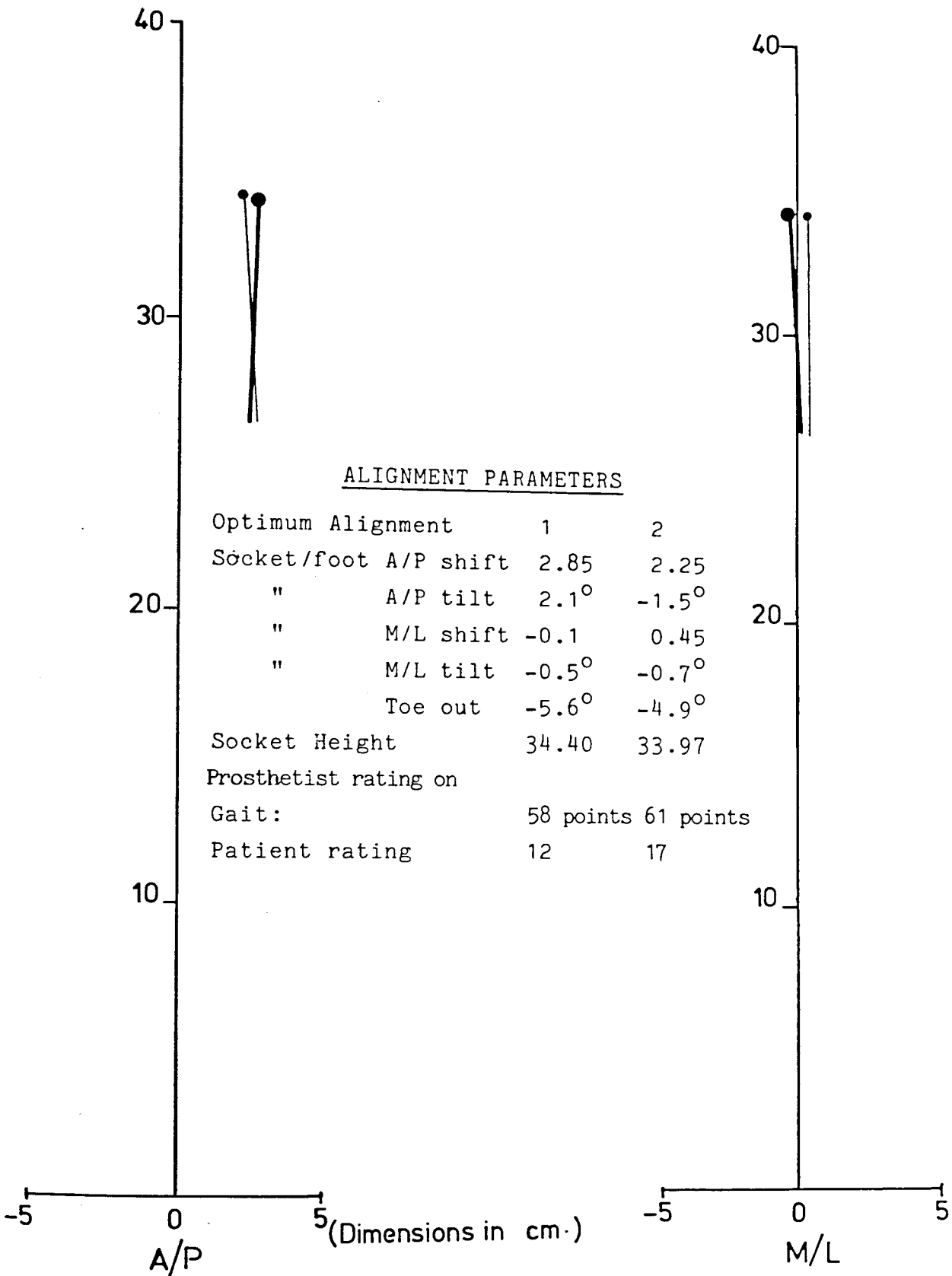

Fig.(6.7.1.1) BK Alignment Parameters

Figure (6.7.1.2a) shows the ankle angle during the gait cycle for both alignments. The relatively dorsiflexed foot of "alignment 1" is clearly seen throughout the cycle with the dorsiflexion angle increasing during late stance as expected. The knee angle (Figure (6.7.1.3a & b)) is seen to be in flexion throughout the cycle for "alignment 1". This is due to the dorsiflexed foot conditioning the knee to flex during stance phase. In contrast "alignment 2", with a relatively plantarflexed foot maintains the knee in extension for most of stance phase due to the ground reaction vector passing ahead of the knee joint, thus creating stability (perhaps over stability). The stick diagram (Figure 6.7.1.4 a&b) clearly shows the difference in knee angles during stance phase, and at the approach to stance phase, between the two alignments. Additionally, the speed with which the knee moves forward during early stance is seen to be greater in "alignment 1" and the effect of the plantarflexed foot "holding back" the knee in "alignment 2". This diagram also shows that late stance through early swing is much more rapid for "alignment 2" as the patient quickly overcomes the resistance to knee flexion. The inclination of the trunk to the vertical is seen to be angulated anteriorly throughout the cycle for "alignment 1". Additionally, the rise of the ankle joint prior to swing phase in "alignment 1" occurs earlier, but is slower than "alignment 2". This is due to the foot of "alignment 1" being positioned further posteriorly and dorsiflexed with reference to that of "alignment 2".

Patient: BL 005

— OPT. ALIGNMENT 1
- - - OPT. ALIGNMENT 2

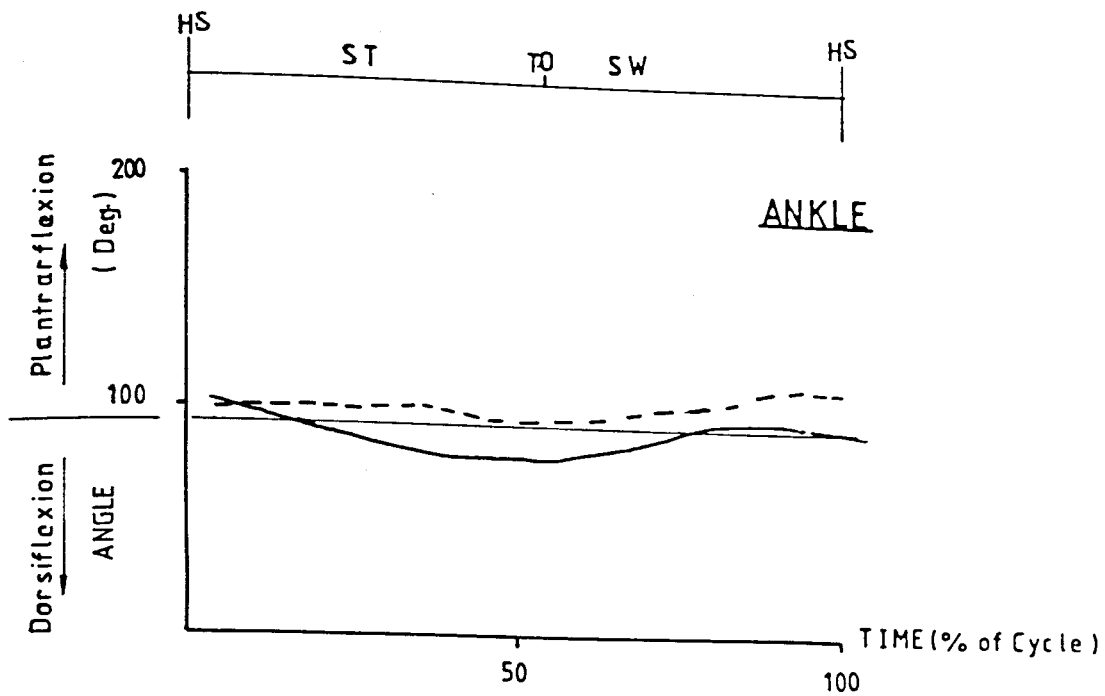

Fig.(6.7.1.2 a)-Prosthetic

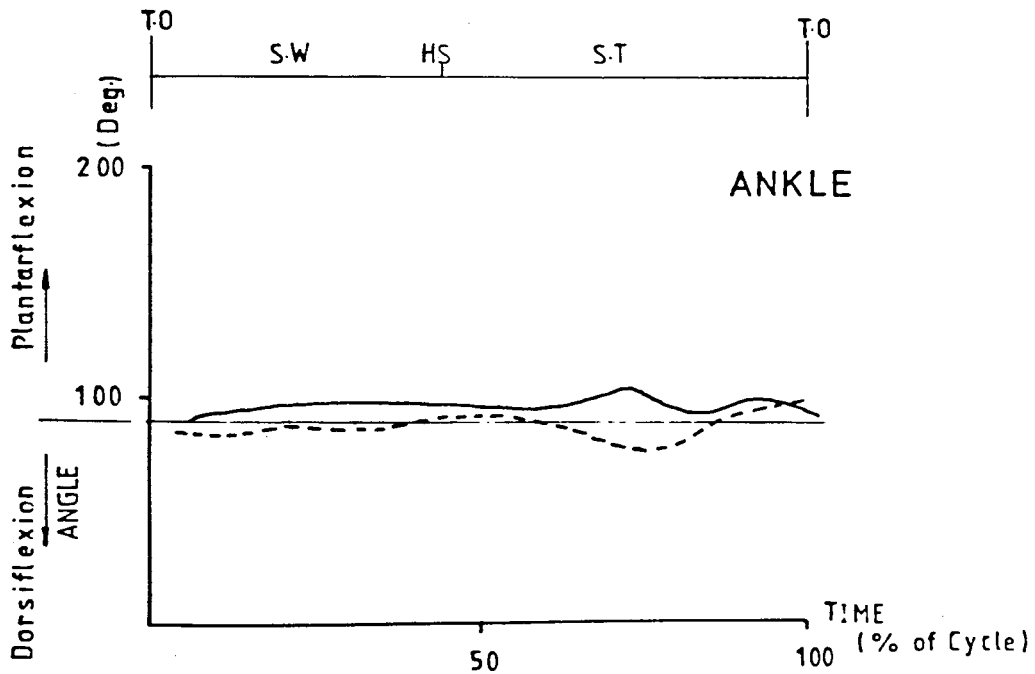

Fig.(6.7.1.2 b)-Sound

ANKLE ANGLE-TIME DIAGRAM

Patient: BL005

— OPT-ALIGNMENT 1
- - - OPT-ALIGNMENT 2

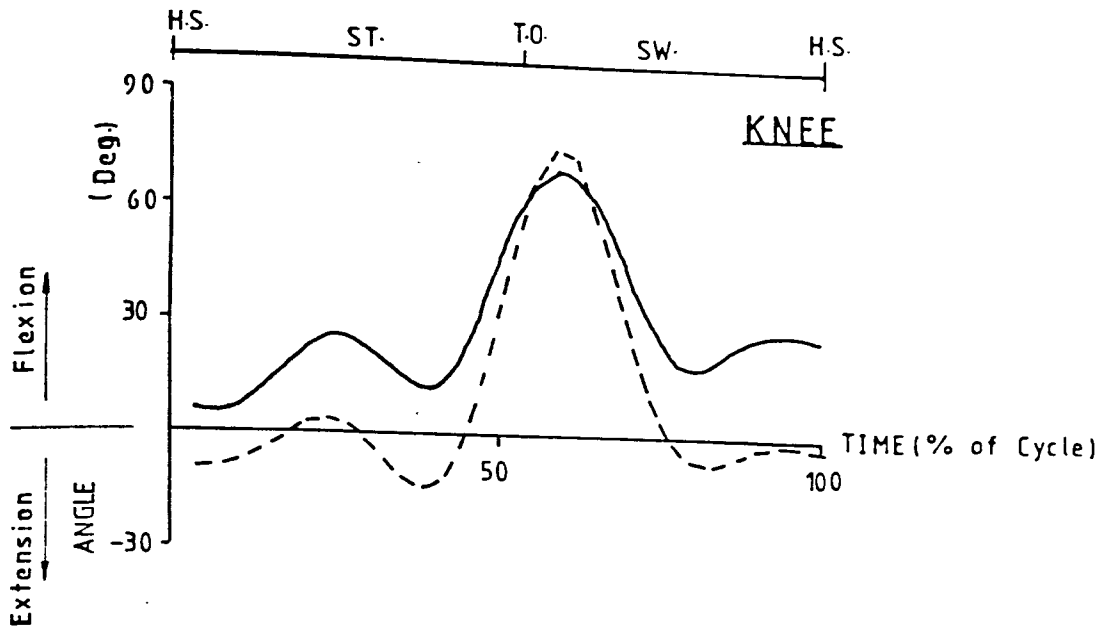

Fig.(6.7.1.3 a)-Prosthetic

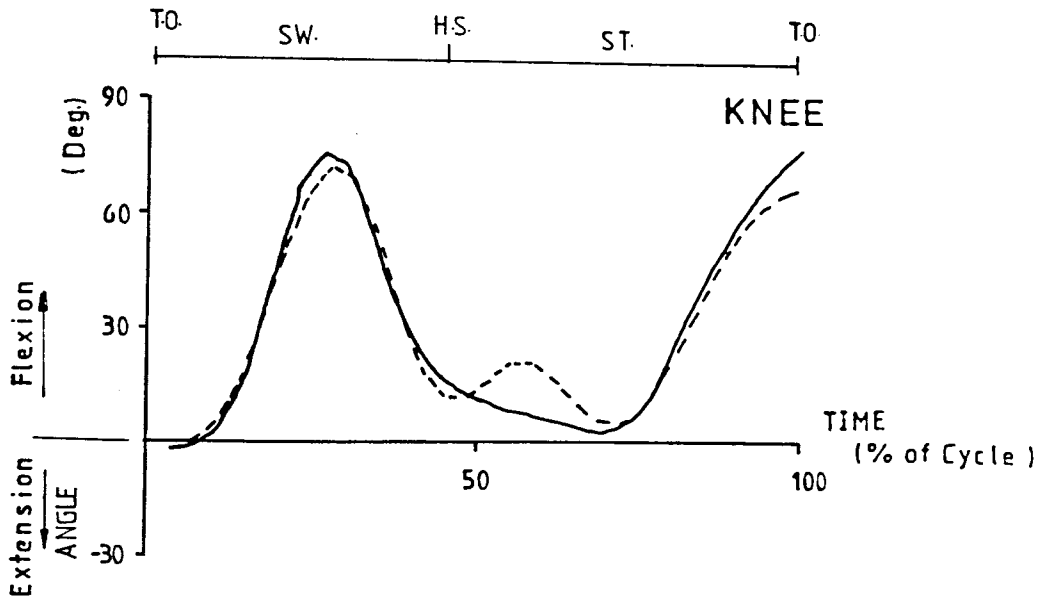

Fig.(6.7.1.3 b)-Sound

KNEE ANGLE-TIME DIAGRAM

Patient: BL005-Prosthetic

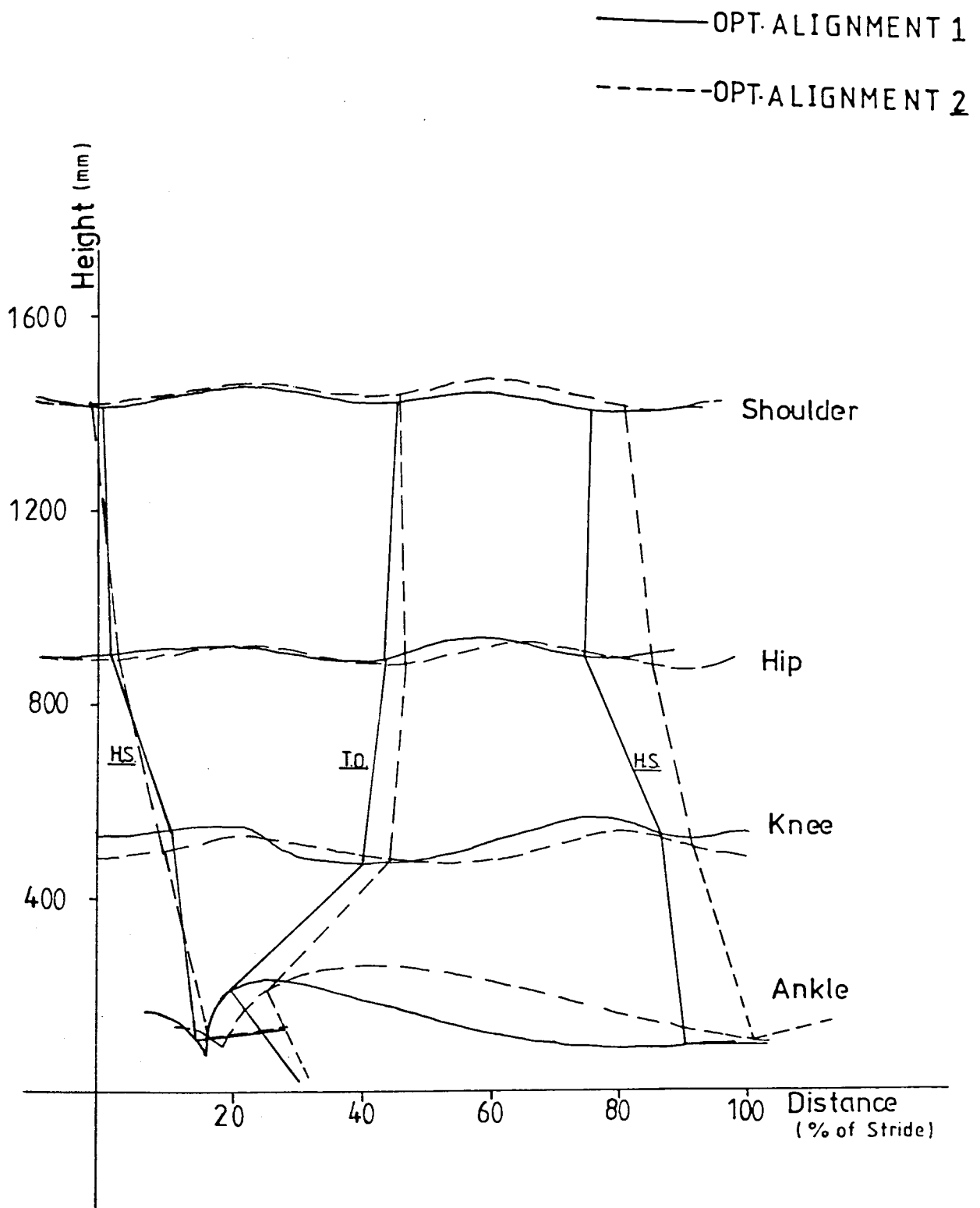

Fig. (6.7.1.4 a) STICK DIAGRAM

Patient: BL005-Sound

— OPT. ALIGNMENT 1

- - - OPT. ALIGNMENT 2

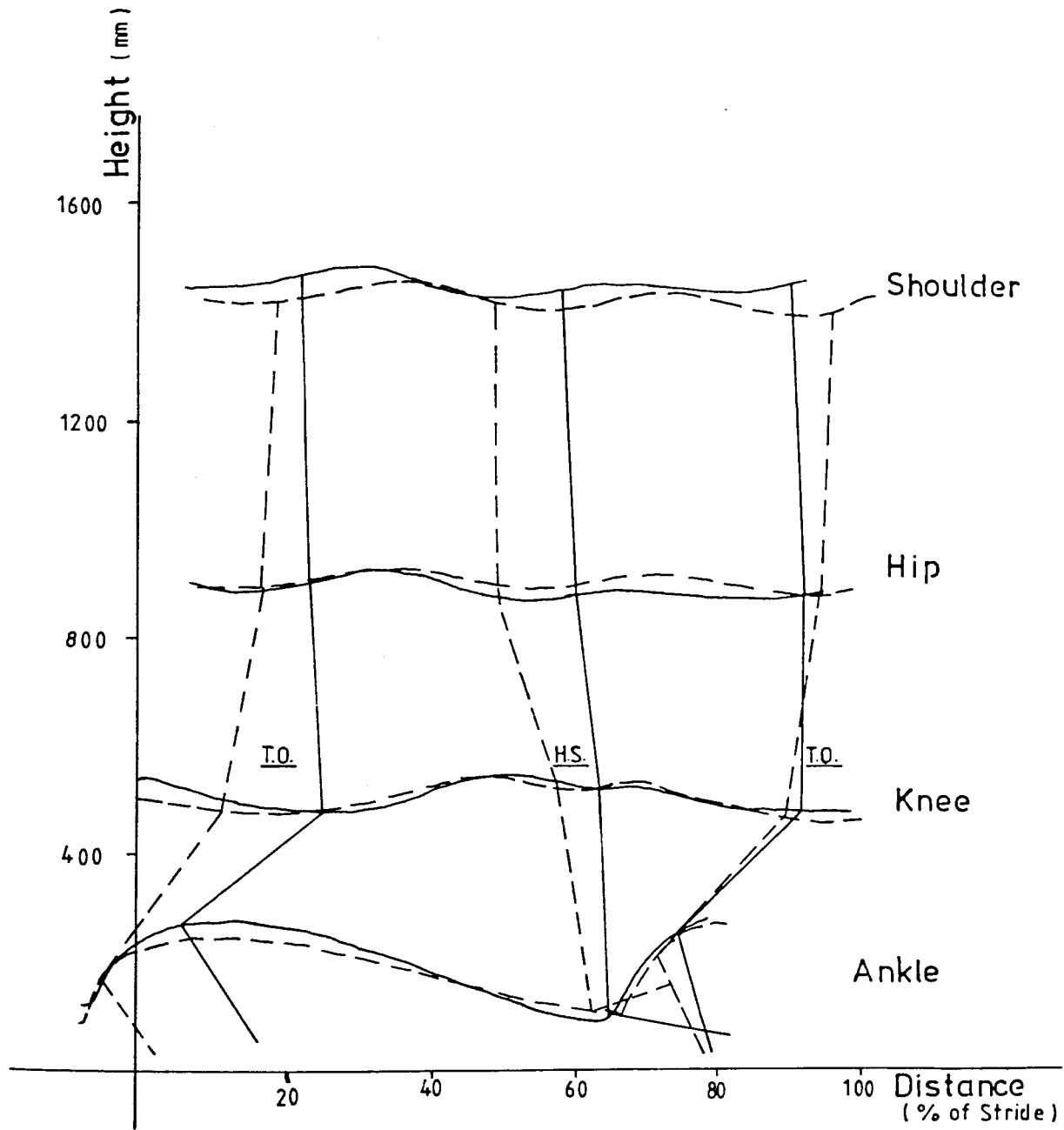

Fig. (6.7.1.4 b) STICK DIAGRAM

From the kinematic parameters discussed "alignment 2" would appear to be the most desirable since it produces the smoothest joint trajectories, in both the displacement and time diagrams. Interestingly, a subjective assessment of the alignments performed by several prosthetists and the patient, all indicated that "alignment 2" was rated better.

Figures (6.7.1.5a & b) show a decrease on the total hip flexion/extension angle with a corresponding substantial increase in the total knee flexion/extension angle for "alignment 2", thus "alignment 2" yields on knee/hip angle-angle diagram which has a larger area under the curve than the corresponding diagram for "alignment 1".

The effect of these alignments on the contralateral side is in fact comparatively small compared to the prosthetic side. This is so in almost all the parameters considered (Figure 6.7.1.2b and 6.7.1.5b). The absence of a rise in flexion angle of the knee after heel-strike in "alignment 1" is also substantiated in knee angle-time diagram, (Figure (6.7.1.3b)).

However, it is probable that neither of the alignments are the "real" optimum alignment. It would seem, however, that from the two given acceptable alignments, "alignment 2" stands to be more desirable.

Patient: BL005

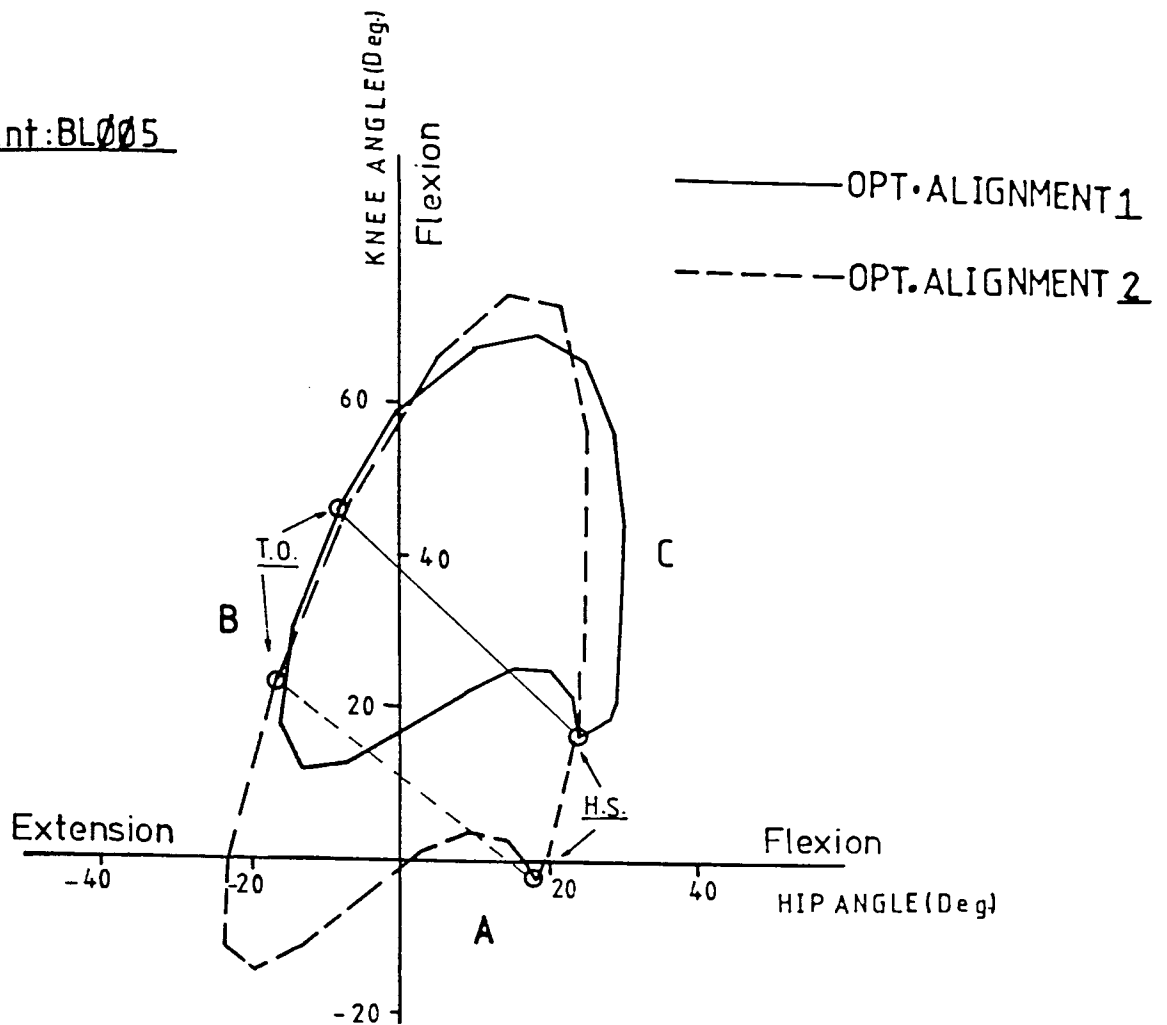

Fig.(G.7.1.5 a) — Prosthetic

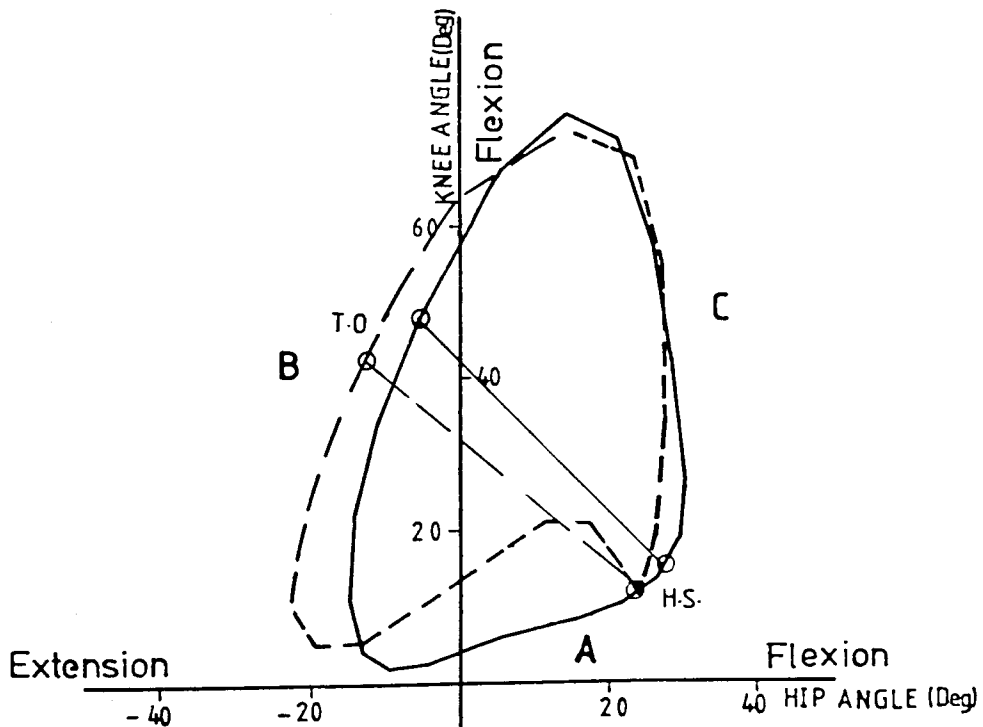

Fig.(G.7.1.5 b) — Sound

KNEE-HIP ANGLE/ANGLE DIAGRAM

TABLE (6.7.1.1) BK PATIENT BL005 TEMPORAL PARAMETERS

Alignment	Speed m/s	Sound						Prosthetic			
		Duration			Stride (cm)	$\frac{SW}{st}$	Duration			Stride (cm)	$\frac{SW}{st}$
		Stance (s)	Swing (s)	Total (s)			Stance (s)	Swing (s)	Total (s)		
01	1.23	0.72	0.36	1.04	119.1	0.5	0.60	0.48	1.08	141.6	0.8
02	1.39	0.66	0.42	1.08	151.0	0.63	0.66	0.42	1.08	150.3	0.64

To further verify this argument, temporal parameters are considered (Table (6.7.1.1)). Although the amputee was asked to walk at his normal speed during both alignments, the speed of walking with "alignment 2" was higher by 0.16 ms^{-1} than "alignment 1". Comparing the stride length of the contralateral and prosthetic sides for "alignment 1" with "alignment 2" shows that the amputee takes a longer stride length with "alignment 2" (Table (6.7.1.1)). Considering that the total gait cycle time of both limbs on both alignments was fairly constant, it can be concluded that the amputee covered more distance with "alignment 2" with the same time and effort. It is thus evident that amputees' "normal" speed at walking could depend upon the alignment configuration of his prosthesis.

Finally, the temporal parameters of "alignment 2" show a greater degree of steps than those of "alignment 1", which could be indicative of a better alignment.

6.7.2 ABOVE-KNEE AMPUTEE

Figure (6.7.2.1) shows two alignments obtained on an above-knee amputee.

The prosthesis displays a medial shift in the position of the prosthetic knee in the medio/lateral plane for "alignment 1", compared with "alignment 2". On the anterior-posterior plane, alignments 1 and 2 are almost identical in that if "alignment 1" was pivoted through the ankle joint,

Patient: AR005

— OPT. ALIGNMENT 1
 — OPT. ALIGNMENT 2

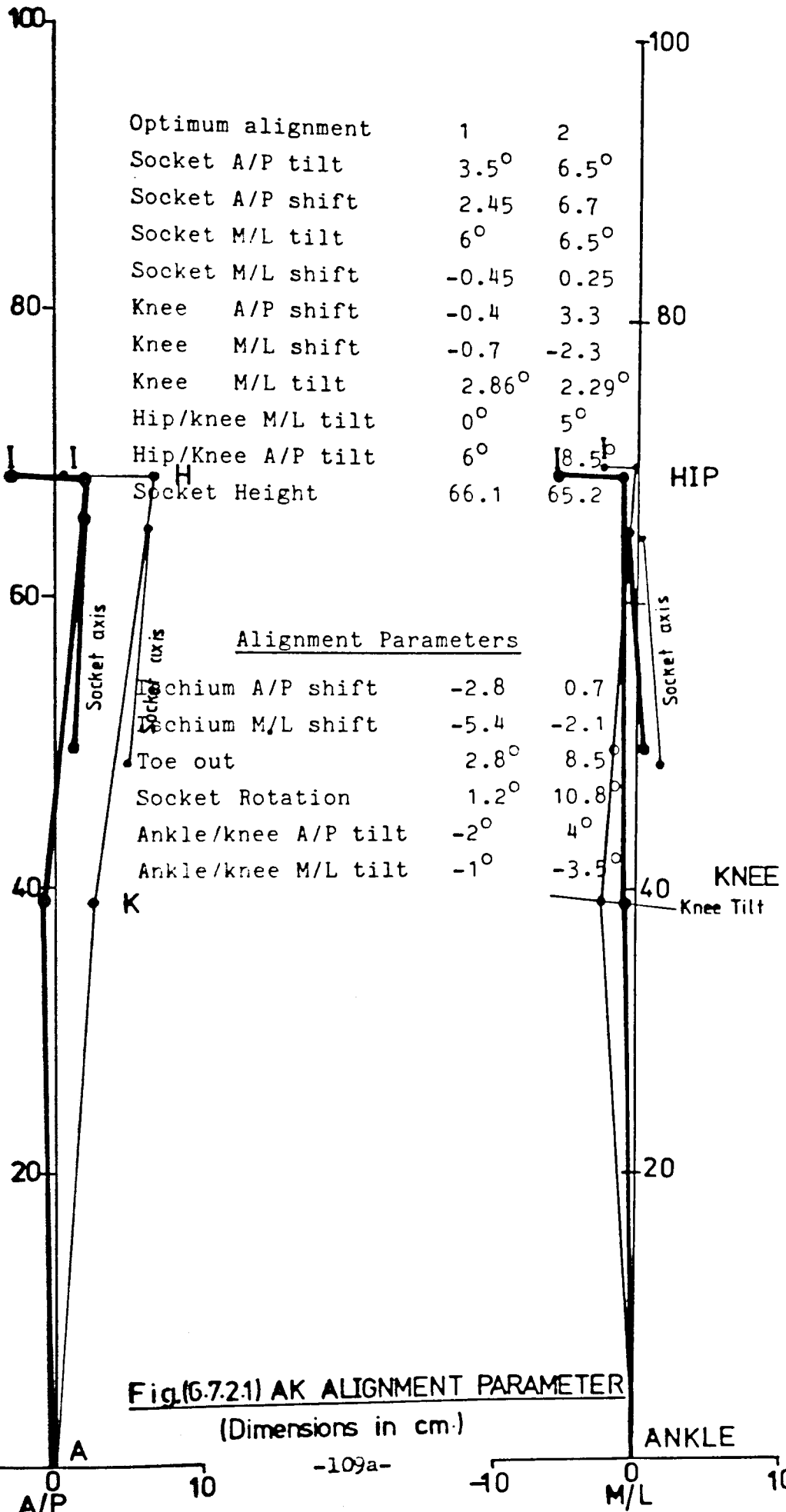

Fig.(6.7.2.1) AK ALIGNMENT PARAMETER

(Dimensions in cm.)

it would almost completely superimpose on "alignment 2". This suggests that the only difference between alignments 1 and 2 in the anteroposterior plane, is due to significant dorsiflexion of the prosthetic foot in "alignment 2". Hence the differences in the parameters measured are basically due to this dorsiflexion. The effect of dorsiflexion of the prosthetic foot on different acceptable alignments has been discussed for the below-knee amputee. However, in the above-knee amputee case this variation manifests itself in a slightly different pattern. Figure (6.4.1.2b) shows that the limbs are fairly stable and that the knee centre lies well behind the load line.

Figure (6.4.1.2a) shows a delay in the heel-strike to foot-flat period and a lower ankle trajectory in "alignment 2". The substantial rise in ankle trajectory in "alignment 1" is achieved by increasing the hip flexion which is followed by an increase in knee flexion. Therefore the ankle rises further above the ground. The knee trajectory has not registered any significant rise although the angulation has altered swing phase. This increased knee flexion during the swing phase of "alignment 1" is substantiated by figures (6.4.2.2a & b). Due to significant similarities between the patterns of alignments 1 and 2 on all the displacement data it is difficult to assess the more desirable alignment. However, "alignment 1" shows a better heel-strike, foot-flat, roll-over and toe-off whilst "alignment 2" shows a delay between heel-strike and foot-flat. The trunk posture, hip posture and other parameters

submit very little information for the sound side except a reduction of speed between heel-strike and foot-flat of the sound side on "alignment 1". This is, however, compensated by a faster swing phase to maintain the same forward velocity of the trunk.

The temporal parameters show a faster speed of walking on "alignment 1", and a longer stride length for both the sound and prosthetic limbs. A greater degree of step symmetry is observed in "alignment 1" which could indicate that overall the amputees' performance using the prosthesis with "alignment 1" was more acceptable.

CHAPTER 7

- 7.1 Conclusion.
- 7.2 Future Work.

7.1 CONCLUSION

As was reported by previous investigators in the Bioengineering Unit, University of Strathclyde, it was also found in this study that a patient and prosthetist could be satisfied not only with a unique "optimum" alignment configuration but with several alignments.

It was observed that various alignment configurations that were acceptable to the patient (and prosthetist) resulted in appreciable variations in the gait patterns and the temporal parameters. Controlled mal-alignments that were deliberately introduced into the prosthesis caused even greater variations in these patterns and parameters. These variations were more pronounced in the case of the above-knee amputees.

It was apparent that both below-knee and above-knee amputees were attempting to compensate for any changes made to the alignment of the prostheses. This compensation was more apparent in the case of above-knee amputees.

From the parameters studied in this project the temporal parameters and the knee/hip angle-angle diagrams were found to be the most useful for gait analysis purposes. The temporal parameters were useful because symmetry of gait could be detected. The knee/hip angle-angle diagrams presented the knee and hip angles simultaneously and eliminated the time variable and made the interpretation somewhat easier.

On average, with "optimum" alignments, the area enclosed by the angle-angle diagram was larger on the prosthetic side than on the sound side. When the prosthesis was deliberately mal-aligned the area of the angle-angle diagram on the prosthetic side was smaller than that on the sound side and that corresponding to the optimum alignment.

Generally, the temporal parameters demonstrated that there was gait symmetry associated with "optimum" alignment. The symmetry was lost when the prosthesis was mal-aligned.

It would appear that variations in the speed of walking do not appreciably affect the gait patterns of temporal parameters. However, only one below-knee patient was tested for various speeds of walking and therefore no definite conclusion can be drawn.

It was possible, by considering the various parameters studies (symmetry in gait, shape and area of angle-angle diagram, etc.), to select the "best" alignment from a set of acceptable alignments, biomechanically. However, this remains to be verified by other means !

7.2. FUTURE WORK - It is suggested that the following should be investigated

- 1) Relationship of alignment and speed.
 - a) Effect of speed on gait
 - b) Effect of various alignments on speed

- c) Effect of various speeds of walking on optimum alignment and mal-alignments.
- 2) Quantifying the "real" optimum alignment.
 - 3) More variations in the mal-alignments, ie. $\pm 1.5^\circ$, $\pm 3^\circ$, $\pm 4.5^\circ$ etc., in order to quantify the relationship between gait pattern and the mal-alignments.
 - 4) To fit the patients with foot switch, to measure heel and toe contact times. This would be extremely helpful for interpretation of data.
 - 5) Collection of further data in order to statistically correlate the alignment parameters.

BIBLIOGRAPHY

- Andrews, B.J., Nicol, S.M., Thyne, C.G., Beale, A.Q. (1982): "The Strathclyde TV/Computer System for 3-D Human Motion Analysis" in : Computing in Medicine, Paul et al., (eds)
- Barclay, W. Below-knee Amputation/Prosthesis" in: Murdoch, G. (1969) "Prosthetic and Orthotic Practice".
- Berme, N., Purdie, C.R., Solomonidis, S.E. (1978). "Measurement of Prosthetic Alignment", Prosthetics and Orthotics International, 2, pp. 73-75.
- Chao, E.Y.S. (1978). "Experimental Methods of Joint Kinematics" in: CRC Handbook of Engineering in Medicine and Biology, Vol. 1(b), pp. 385-411.
- Committee on Prosthetics Research and Development. "Cosmesis and Modular Limb Prostheses"; Report of a Conference held in San Francisco, California (1971). Issued by Committee on Prosthetics Research and Development, National Academy of Sciences, Washington D.C., U.S.A., 1971.
- Eberhart, H.D. & Imman, V.T. (eds), (1974). "Fundamental Studies of Human Locomotion and Other Information Relating to Design of Artificial Limbs", University of California, Berkeley. Report to National Research Council, Committee on Artificial Limbs - 2 Vols.
- Eberhart, H.D. & Imman, V.T., (1954). "The Locomotor Mechanism of the Amputee", in : Human Limbs and their substitutes, Klopsteg, P.E. & Wilson, P.D. et al.
- Fishman, S. et al. (1962). "Metabolic Measures in the Evaluation of Prosthetic and Orthotic Devices", in: Prosthetic and Orthotic Practice, Murdoch, G. (1969).
- Godfrey, C.M., Jousse, A.T., Brett, R. & Butler, J.F. (1975). "A Comparison of Some Gait Characteristics with Six Knee Joints", Orthotics and Prosthetics, 29(3), pp. 33-38.
- Goh, J. (1982). "Biomechanical Evaluation of Prosthetic Feet", Ph.D. Thesis, University of Strathclyde, Glasgow.
- Hershler, C., & Milner, M., (1980): "Angle-Angle Diagrams in the Assessment of Locomotion", American Journal of Physical Medicine, Vol. 59, No.3, pp. 109-125.
- Ishai, G.A. (1975). "Whole Body Gait Kinetics", Ph.D. Thesis, University of Strathclyde, Glasgow.
- James, U., & Oberg, K., (1973). "Prosthetic Gait Pattern in Unilateral Above-Knee Amputees", Scand. Journal of Rehab. Med., 5.

- Jarrett, M.D., Andrews, B.J., Paul, J.P. (1976). "A TV/Computer System for the Analysis of Human Locomotion". Proc. I.E.R.E., Golden Jubilee Conference & Exhibition., Southampton University, p. 357.
- Klopste~~g~~, P.E. & Wilson, P.E. (1954). "Human Limbs and their Substitutes, Hapner Publishing Company, Reprinted 1968.
- Lamoreu, L.W. "Kinematic Measurement in the Study of Human Walking", British Prosthetics Research (BPR), 10-15; 3-84, Spring 1971.
- Lanshammar, H. (1982). "Variation of Mechanical Energy Levels for Normal and Prosthetic Gait". J. International Society for Prosthetics and Orthotics (I.S.P.O.), Vol.6, No.2, pp.97.
- Mital, M.A., & Pierce, D.S., (1971). "Amputees and Their Prosthesis", Little, Brown and Company, Boston.
- Mitchelson, D.A. (1975). "Recording of Movement Without Photography", in : Techniques for the Analysis of Human Movement, The Human Movement Series, f Lepus Books.
- Murdoch, G (1969). "Prosthetic & Orthotic Practice", Based on a Conference held in Dundee, June 1969, London: E. Arnold.
- Murray, M.P., Drought, A.B., & Kory, R.C. "Walking Patterns of Normal Men" J. Bone Jt. Surg., 464 (1), 1964.
- Radcliffe, C.W. (1969). "Biomechanics of Above-Knee Prostheses" In: Prosthetic & Orthotic Practice; Edited by Murdoch, G. (1970).
- Radcliffe, C.W. (1969)., "Prosthetic Knee Mechanisms for Above-Knee Amputees". In Prosthetic & Orthotic Practice, Edited by G. Murdoch (1970).
- Radcliffe, C.W. & Foort, J. (1961). "The Patellar-Tendon-Bearing Below-Knee Prosthesis". Biomechanics Laboratory, California.
- Ralston, H.J. & Lukin, L. (1969). "Energy Levels of Human Body Segments During Level Walking". Ergonomics, 12(1), pp. 39-46.
- Ryker, N.J. and Bartholomew, S.H. (1952). Determination of Acceleration by use of Accelerometers". Report Series 11, Issue 17, University of California, Berkeley, Pros. Devices Res. Project.
- Paul, J.P. (1967). "Forces at the Human Hip Joint". Ph.D. Thesis, University of Glasgow, Glasgow.

- peizer, E and Wright D.W.(1969). "Human Locomotion". In Prosthetic & Orthotic Practice". Edited by Murdoch G. (1970).
- Pepae, R. (1970), Manual for Automatic Film Scanner Developed at Children's Hospital in Iowa City, Iowa, U.S.A.
- pezzack, J.C. Norman R.W. and Winter,D.A. (1977). Technical Note : An Assessment of Derivative Determining Techniques used for Motion Analysis". J. Biomechanics, 10, pp. 377-382.
- purdie, C.R. (1977). "Socket Axis Determination in Lower Limb Prosthetic Alignment". M.Sc. Thesis, University of Strathclyde, Glasgow.
- Quigley, M.J., Irons, G.P., Donaldson, N.R. (1977). "The Rancho Ultralight Below-Knee Prosthesis".
Rehab Eng. Centre at Rancho Los Amigos Hospital, Downey, California.
- Solomonidis, S.E. (Editor) (1975). "Modular Artificial Limb, First Report on a Continuing Programme of Clinical and Laboratory Evaluation. Below-Knee Systems". Scottish Home and Health Department.
- Solomonidis, S.E. (Editor) (1980). "Modular Artificial Limbs. Second Report on a Programme of Clinical and Laboratory Evaluation. Above-Knee Systems". Scottish Home and Health Department.
- Townsend, M.A., Izak, M. and Jackson, R.W. (1977). "Total Motion Knee Goniometry". J. Biomechanics, 10, pp. 183-193.
- Winter, D.A., Greenlaw, R.K., Hobson, D.A. (1972). "Television - Computer Analysis of Kinematics of Human Gait". Comp Biomed Res., 5, pp. 498-504.
- Winter, D.A., Sidwall, H.G. and Hobson, D.A. (1974). "Measurement and Reduction of Noise in Kinematics of Locomotion". J. Biomechanics, 7, pp. 157-9.
- Winter, D.A. (1979). "Biomechanics of Human Movement", Biomedical Engineering and Health Systems; A Wiley Interscience Publication.
- Woltring, H.J. (1975). "Single-and Dual-axis Lateral Photodetectors of Rectangular Shape". IEEE Trans Electronic Devices, 22, pp. 581-590 and 1101.
- Woltring, H.J. and Marsolais, E.B. (1980). "Optoelectric (Selspot) Gait Measurement in Two and Three Dimensional Space - a preliminary Report". BPR; 10-34 pp. 46-52.

Zahedi, M.S. (1982). Personal Communication.

Zahedi, M.S. (1984). Ph.D. Thesis in Preparation, University of Strathclyde, Glasgow.