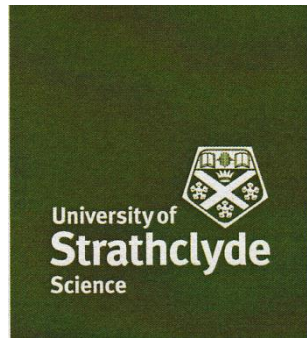


# **Applications of Hydrophilic Interaction Chromatography in the Analysis of Drugs and Metabolites**



A Thesis  
Presented to  
Strathclyde Institute of Pharmacy and Biomedical Sciences  
University of Strathclyde

In Partial Fulfillment  
Of the Requirements for the Degree  
Doctor of Philosophy

By  
Saud Bawazeer  
April 2013

## **COPYRIGHT DECLARATION**

This thesis is the result of the author's original research. It has been composed by the author and has not been previously submitted for examination which has led to the award of a degree.

The copyright of this thesis belongs to the author under the terms of the United Kingdom Copyright Acts as qualified by the University of Strathclyde Regulation 3.49. Due acknowledgement must always be made of the use of any material contained in, or derived from, this thesis.

Signed: .....

Date:.....

## **Acknowledgements**

I would particularly like to thank Dr. David Watson, my research supervisor, for giving me the opportunity to work on my favourite subject, for pointing me in the right direction, and in helping me with ideas and suggestions.

I would also like to thank Professor Mel Euerby and Dr. Oliver Sutcliffe for all the suggestions and guidelines. Dr. Tong Zhang for his continuing encouragement, support and discussions then I would like to thank my committee members Ms Lorraine Allan safety technician for providing feedback on my work. I also would like to thank Dr Wilma Wilson who helped me with my research. I would like to thank all my co-workers for the helpful discussions and arguments which led me to think with varying perspectives and to come up with good solutions.

I greatly appreciate the support of my father sheikh Salem Bawazeer, my mother, my family including my brother Sami Bawazeer and my entire friends for their advice, support, and constant encouragement.

I would like to thank Umm Al-Qura University for providing financial assistance during the early years of this work towards completing my PhD degree.

# Abstract:

---

Hydrophilic interaction liquid chromatography (HILIC) has grown in popularity during the last ten years. It is somewhere between normal phase and reverse phase liquid chromatography in terms of its mode of action. HILIC involves the separation of polar analytes through their partitioning into a water rich layer that is formed on the surface of the stationary phase. However, there are also additional mechanisms involved in HILIC including ion exchange interactions. There are an increasing number of HILIC columns on the market. A number of different factors can be set to control the separation of compounds in HILIC mode including column temperature, mobile phase composition, pH and buffer type and concentration.

In the current study a cyanopropyl (CN) HPLC column was used for the separation of some basic compounds in HILIC mode. Good separation of a test mix of basic compounds was obtained with a mobile phase consisting of acetonitrile/water (95:5) containing 3.25mM ammonium acetate. The retention times of the basic compounds decreased with increased ionic strength or with increased water content in the mobile phase. The effect of the size of the basic centre, pH, and buffer concentration was also studied using a series of model bases. The utility of the column for impurity profiling of two basic drugs was tested. The CN column showed reasonable stability although there appeared to be loss of stationary phase with time. The retention properties of a silica gel column and a type C silica (silicon hydride) column for bases, sugars and polar acids were compared in HILIC mode with formic acid or ammonium acetate as aqueous phase modifiers. Seven different HILIC stationary phases were characterised with regard to their retention properties for 100 metabolite

standards. In addition three of these phases were evaluated with regard to their ability to profile metabolites in urine.

Finally a HILIC method was developed in order to determine the level of nicotine exposure in companion animals resulting from passive smoking.

# Table of Contents

---

<b>Chapter 1</b> Introduction .....	19
1.1 Chromatography .....	20
1.2 Chromatographic Performance .....	21
1.3 Separation Techniques .....	24
1.3.1 Normal phases Liquid chromatography (NPLC): .....	24
1.3.2 Reversed phase liquid chromatography (RPLC): .....	25
1.3.3 Hydrophilic interaction liquid chromatography (HILIC): .....	27
1.3.3.1. The Mechanism of separation in HILIC .....	28
1.4 Types of HILIC columns: .....	34
1.4.1 Bare Silica.....	34
1.4.2 Silicon Hydride Columns (Type C Silica).....	37
1.4.3 HILIC columns based on silica gel with neutral surface ligands .....	40
1.4.3.1 Diol silica .....	40
1.4.3.2 Aminopropyl silica: .....	43
1.4.3.3 Amide silica: .....	45
1.4.3.4 Poly (succinimide)-bonded silica:.....	46
1.4.3.5 Cyclodextrin based columns: .....	48
1.4.3.6 Cyanopropyl silica: .....	49
1.4.3.7 Sulfoalkylbetaine silica: .....	50
1.5 Factors affecting the separation in HILIC .....	52
1.5.1 Column Temperature .....	52
1.5.2. The Effect of the Mobile phase .....	56
1.5.3. The effect of pH.....	58
1.5.4. Effect of the Buffer type and concentration on retention in HILIC .....	62
1.6 Applications of HILIC in Pharmaceutical and Food Analysis.....	66
1.6.1 Analysis of Formulations.....	66
1.6.2. Analysis of Drug Impurities .....	66
1.6.3 Bioanalysis and Drug Metabolism .....	67
1.6.4 Miscellaneous Applications of HILIC.....	69
1.7 Instruments. ....	71

1.7.1 High Performance Liquid Chromatography Instruments (HPLC): .....	71
1.7.2. Liquid chromatography- Mass spectrometry (LC-MS):.....	72
1.8 Aims and Objectives .....	76
<b>Chapter 2</b> The hydrophilic interaction like properties of some reversed phase high performance liquid chromatography columns in the analysis of basic compounds .....	77
2.1. Introduction: .....	78
2.2. Materials and methods .....	80
2.2.1. Chemicals .....	80
2.2.2. Mobile phase preparation .....	81
2.2.3. HPLC columns .....	81
2.2.4. HPLC instrumentation.....	81
2.2.6 Sample preparation .....	82
2.3. Results: .....	82
2.3.1 Factors governing the retention properties of a test mix of basic compounds under HILIC-like conditions.....	82
2.3.2 The effect of the counter ion in the mobile phase on retention time. ....	86
2.3.3 Impurities in salbutamol .....	94
2.3.4 Impurity Profiling of Promethazine by LC-MS Using an ACE CN Column.....	99
2.3.5 Investigation of the influence of structure on the retention mechanism of an ACE CN column using some simple bases .....	101
2.3.5.1 The Effect of the molecular weight of the Basic Centre on Retention Time..	103
2.3.5.2 The Effect of pH on the Retention of the Simple Test Probes.....	106
2.3.5.3 The effect of the different buffer concentrations on the retention of simple amines .....	108
2.3.5.4 The Effect of Water Content of the Mobile Phase on Retention Times .....	111
2.3.5.5 Determination of the stability of the ACE CN Column.....	114
2.4 Conclusion.....	117
<b>Chapter 3</b> A Comparison of the Chromatographic Properties of Silica Gel and Silicon Hydride Modified Silica Gels. ....	119
3.1 Introduction .....	120
3.2. Materials and Methods .....	121
3.2.1 Chemicals and Reagents .....	121
3.2.2 Chromatography Columns and LC-MS.....	122
3.3 Results .....	122

3.3.1 Chromatography of basic test probes on silica gel and type C silica. ....	122
3.3.2 Chromatography of sugars on silica gel and type C silica .....	127
3.3.3 Chromatography of acids on silica gel and type C silica .....	131
3.4 Conclusion.....	133
<b>Chapter 4</b> Comparison of Seven Different Columns For the Screening of Metabolites in Metabolomic Screening .....	135
4.1 Introduction .....	136
4.2 Materials and Methods .....	138
4.2.1 Chemicals and Reagents .....	138
4.2.2 Chromatography Columns and LC-MS.....	138
4.2.3 Synthesis of $\beta$ -pinene modified type C silica .....	138
4.3 Results .....	139
4.3.1. Confirmation of the $\beta$ -pinene linkage to the stationary phase.....	139
4.3.2 Analysis of Metabolite Standards on Seven HILIC Columns.....	141
4.3.3 Analysis of urine using three type C silica based columns with FT-MS detection .....	151
4.4 Conclusions .....	156
<b>Chapter 5</b> An Application of Hydrophilic Interaction Chromatography in Bioanalysis .....	158
5.1 Introduction .....	159
5.2 Materials and methods .....	161
5.2.1. Chemicals .....	161
5.2.2. Dog hair sample collection .....	161
5.2.3. Extraction of dog hair .....	162
5.2.4. Calibration .....	162
5.2.5. Mass spectrometric analysis .....	162
5.2.6. Synthesis of nicotine N-oxides .....	163
5.3. Results .....	163
5.3.1. Consideration of the extraction method.....	163
5.3.2. NaOH digestion procedure for extracting nicotine from hair.....	164
5.3.3. Extraction of nicotine and its metabolites using a methanol wash.....	168
5.3.4 Application of the NaOH extraction method for determine the Nicotine. ....	172
5.4. Conclusion.....	177
<b>Chapter 6</b> Conclusions and further work .....	179
6.1 Conclusions .....	180



6.2 Further work.....	183
References .....	185
Appendix I.....	193
Appendix II .....	197
Appendix III.....	204
Appendix IV.....	205

# List of Figures

---

Figure 1-1 Some important chromatographic parameters .....	23
Figure 1-2 Octadecyl phases with and without polar embedded groups. ....	26
Figure 1-3 The partition mechanism in HILIC chromatography [4] .....	28
Figure 1-4 Retention time of the benzene with different percentage of water content in a water/acetonitrile mobile phase using an Atlantis silica column [7]. ....	29
Figure 1-5 Plots of log k against log mole fraction of water in the mobile phase. Solute identities: $\blacklozenge$ = nortriptyline, $\blacksquare$ = procainamide, $\blacktriangle$ = diphenhydramine, $\times$ = benzylamine, $*$ = caffeine, $\bullet$ = p-xylenesulfonic acid [8]. ....	30
Figure 1-6 Chromatographs for 5. nortriptyline, 6.diphenhydramine, 7. benzylamine, 8 procainamide. with different stationary phases and the mobile phases are a) acetonitrile:water (95:5, v/v) and b) Acetonitrile:water (85:15, v/v) both containing 5 mM ammonium formate pH 3.0 [8]. ....	33
Figure 1-7 The chemistry of the surface of bare silica gel. ....	34
Figure 1-8 Types of silanol groups [9]. ....	35
Figure 1-9 The hydrosilanisation process. ....	35
Figure 1-10 The types of interaction which can occur between an analyte and the silica gel surface in HILIC mode. ....	36
Figure 1-11 The hydrosilation reaction of the Silica gel and triethoxysilane (TES) resulting in a silicon hydride surface [10]. ....	37
Figure 1-12 Chemical structure of the A) Silicon hydride, B) UDC Cholesterol hydride and C) Bidentate C18 hydride phases .....	39
Figure 1-13 Chemical structures of the mixed mode diol, cross-linked diol and polyethylene glycol phases. None of these stationary phases are endcapped.....	42
Figure 1-14 The surface of aminopropyl silica without endcapping .....	43
Figure 1-15 Chemical reaction of a primary amine and aldehyde group to produce a Schiff's base. ....	44
Figure 1-16 The surface chemistry of amide silica (TSK-Gel Amide-80) without endcapping. ....	45
Figure 1-17 Surface chemistry of 2) poly(succinimide) silica, a) Poly(aspartic acid) silica, b) Poly(2-hydroxyethyl) aspartamide silica, and c) Poly(2-sulfoethyl) aspartamide silica. ....	47
Figure 1-18 A) chemistry surface of a cyclodextrin phase and B) a toroid structure showing the interaction of a polar analyte with the column surface. ....	48
Figure 1-19 Surface chemistry of cyanopropyl silica without endcapping.....	49
Figure 1-20 the chemical structure of A) ZIC-HILIC and B) ZIC-cHILIC .....	51
Figure 1-21 Plot of ln k against the column temperature for ( $\diamond$ ) urea, ( $\blacksquare$ ) sucrose and ( $\blacktriangle$ ) glycine. Mobile phase water/ACN (20:80, v/v), diol stationary phase, flow rate 1.0 ml/min, refractive index detector [40]. ....	54

Figure 1-22 The van't Hoff plots for A) aspirin and B) cytosine on (■) an amine stationary phase (YMC-Pack NH <sub>2</sub> ), (◆) an amide stationary phase (TSKgel Amide-80), (▲) a silica stationary phase (HILIC Silica), and (×) a zwitterionic stationary phase (ZIC-HILIC). Mobile phase: 10 mM ammonium acetate in water/acetonitrile (10/90, v/v) [35].	55
Figure 1-23 The effect of the different types of the mobile phase organic modifiers on the separation of (1) epidaunorubicin, (2) daunorubicin, (3) epirubicin, (4) doxorubicin.	57
Figure 1-24 Chemical structures for A) daunorubicin and B) Epirubicin [44].	58
Figure 1-25 The effect of the different mobile phase pH for the aspirin on (◆) amide, (■) silica and (▲) sulfobetaine phases. The mobile phase was 10mM ammonium formate in water/ACN (10:90 v/v) [45].	60
Figure 1-26 The effects of mobile phase pH for the aspirin (◆)and cytosine(■). Stationary phase: amino propyl, mobile phase 10 mM ammonium formate water/ACN (10:90, v/v) [35].	61
Figure 1-27 The effect of different buffer types with 10mM 1) ammonium acetate or 2) 10 mM ammonium formate with ACN (15:85, v/v) on the retention times of salicylic acid and cytosine. The stationary phases were (◆) amide, (■)amine, (▲)silica and (×)Zic-HILIC. The pH of the acetate is 6.9 and the pH of the Bicarbonate is 7.9 and the pKa for the aspirin is 3.5 and for the cytosine is 4.6 [35].	64
Figure 1-28 The effect of different concentrations of the ammonium acetate buffer pH 6.9 mixed with ACN (15:85, v/v) on the retention of salicylic acid. The stationary phases are (■) bare silica and (◆) amine.	65
Figure 1-29 Schematic diagram of a HPLC system.	71
Figure 1-30 A Thermo Scientific Exactive mass spectrometer [67].	73
Figure 1-31 Electrospray ionization process [69].	74
Figure 1-32 Orbitrap instrument [70].	75
Figure 2-1 (A) Separation of test mixture of basic compounds (propranolol, chlorpromazine, salbutamol, nortriptyline, benzalkonium chloride) on an ACE CN column (150mm×3mm) in acetonitrile/water (95:5) containing 3.25mM ammonium acetate, flow rate 0.8 ml/min. (B) Separation of test mixture of basic compounds on an ACE CN column (150mm×3mm) in acetonitrile/water (95:5) containing 6.5mM ammonium acetate, flow rate 0.8 ml/min. (C) Separation of test mixture of basic compounds on an ACE CN column (150mm×3mm) in acetonitrile/water (97:3) containing 3.25mM ammonium acetate, flow rate 0.8 ml/min.	84
Figure 2-2 Structures of the basic compounds included in the test mixture.	85
Figure 2-3 Chromatogram obtained for the test mixture of bases with 3.25 mM sodium acetate in acetonitrile/water (95:5), flow rate 0.8 m/min. Retention times of basic compounds at pH 6 on an ACE CN column (150 x 3 mm, 3 μm particle size).	87
Figure 2-4 Chromatogram for the basic test compounds at pH 6 on the ACE CN column (150 x 3 mm x 3 μm particle size) in 3.25 mM tetraethylamine acetate in acetonitrile/water (95:5), flow rate 0.8 ml/min.	88
Figure 2-5 Retention times of basic compounds at pH 6 on the ACE CN column (150 x 3 mm, 3 μm particle size) in 3.25 mM tris pH 6.0 in acetonitrile/water (95:5), flow rate 0.8 ml/min.	90

Figure 2-6 Chromatogram for chlorpromazine at pH 6 on an ACE CN column (150 x 3 mm, 3 $\mu$ m particle size) with 3.25 mM bis tris pH 6.0 in acetonitrile/water (95:5), flow rate 0.8 ml/min.....	91
Figure 2-7 Retention times of basic compounds at pH 6 on the ACE CN column (150 x 3 mm, 3 $\mu$ m particle size) in 3.25 mM tris acetate in acetonitrile/water (95:5), flow rate 0.8 ml/min. ....	93
Figure 2-8 Retention times of basic compounds at pH 6 on the ACE CN column (150 x 3 mm, 3 $\mu$ m particle size) in 3.25 mM bis-tris acetate in acetonitrile/water (95:5), flow rate 0.8 ml/min.....	93
Figure 2-9 Separation of salbutamol and its manufacturing impurities on an ACE CN column (150mmx3mm, 3 $\mu$ m) in acetonitrile/water (95:5) containing 3.25mMammonium acetate pH 5.0, flow rate 0.8 ml/min with UV detection at 220 nm. ....	95
Figure 2-10 Manufacturing impurities in salbutamol. ....	96
Figure 2-11 Plot of the salbutamol impurities (salbutamol ketone, salbutamol aldehyde and desoxysalbutamol) between 1 $\mu$ g/ml and 1000 $\mu$ g/ml. MP: 3.25 mM ammonium acetate in water:acetonitrile (5:95 v/v) on an ACE CN column. Flow rate 0.8ml/min.....	96
Figure 2-12 TIC for salbutamol and its impurities on an ACE CN column (150mmx3mm) in acetonitrile/water (95:5) containing 3.25 mMammonium acetate pH 5.0, flow rate 0.5 ml/min.....	97
Figure 2-13 Extracted ion trace for the aldehyde and ketone impurities in salbutamol. ....	98
Figure 2-14 Mass spectrum of an unknown impurity in salbutamol.....	98
Figure 2-15 Structure of known impurity in salbutamol closely related to the unknown impurity identified with the mass spectrum shown in Figure 2.14. ....	99
Figure 2-16 Analysis of impurities in promethazine by LC-MS. Conditions as in Figure 2.5. ....	100
Figure 2-17 Promethazine and its impurities. ....	100
Figure 2-18 Analysis of model bases: 2-methylbenzylamine (2MBA), N-tertiarybutyl, benzylamine (NTBA) , N-isopropylbenzylamine (NPBA), N-ethyl benzylamine (NEBA), N-methylbenzylamine (NMBA), trimethylbenzylamine (TMBA), triethylbenzylamine (TEBA) on an ACE CN column (150mmx3mm) in acetonitrile/water (95:5 v/v) containing 3.25mM ammonium acetate pH 6, flow rate 0.8 ml/min. ....	106
Figure 2-19 Analysis of benzyldimethylamine (BDMA), benzylamine (BA), N-isopropylbenzylamine (NPBA), N-methylbenzylamine (NMBA), benzyltriethylamine (BTEA) and benzyltrimethylamine (BTMA) on an ACE CN column (150 x 3 mm, 3 $\mu$ m particle size) with A 1.125 mM ammonium acetate in acetonitrile/water (95:5), B 6.5 mM ammonium acetate in acetonitrile/water (95:5). Flow rate 0.8 ml/min.....	110
Figure 2-20 Analysis of benzyldimethylamine (BDMA), benzylamine (BA), N-isopropylbenzylamine (NPBA), N-methylbenzylamine (NMBA), benzyltriethylamine (BTEA) and benzyltrimethylamine (BTMA) on an ACE CN column (150 x 3 mm, 3 $\mu$ m particle size) with A 3.25 mM ammonium acetate in acetonitrile/water (95:5) B 3.25 mM ammonium acetate in acetonitrile/water (90:10). Flow rate 0.8 ml/min. ....	113

Figure 2-21 Retention times of basic compounds (chlorpromazine, propranolol, salbutamol, nortriptoline and benzoalkonium) with different time on the ACE CN column (150 x 3 mm, 3 $\mu$ m particle size) in 3.25 mM w/v ammonium acetate in acetonitrile/water (95:5), flow rate 0.8 ml/min.....	115
Figure 2-22. Retention times and the peak shape of 5 basic compounds at pH 6 on the ACE CN column (150 x 3 mm, 3 $\mu$ m particle size) in 3.25 mM ammonium acetate pH 6.0 in acetonitrile/water (95:5), flow rate 0.8 ml/min. A chromatograph at the first day of using the column and B chromatograph after 14 days of using the column.....	116
Figure 3-1 Basic compounds used to test silica gel and the type C silica column. ....	123
Figure 3-2 HPLC-UV chromatograms for some basic test compounds on type C silica and silica gel columns using mobile phase A 10 mM ammonium acetate in water, mobile phase B acetonitrile, flow rate of 1 ml/ min, gradient 20% A 80% B 0 min and 80% A 20% B 30 min. UV detection at 254 nm.....	127
Figure 3-3 Sugar compounds used to test silica gel and type C silica columns. ....	128
Figure 3-4 Extracted ion chromatograms for some sugars on a type C silica column with A 10mM ammonium acetate in water, mobile phase B acetonitrile, flow rate of 0.3 ml/ min. Gradient: 20% A 80% B ( 0 min) to 50% A 50% B (12 min) to 50% A 50% B (26 min). Detection FT-MS in negative ion mode. ....	130
Figure 3-5 Acidic compounds used to test silica gel and type C silica columns. ....	131
Figure 3-6 Extracted ion chromatograms for acidic compounds on type C silica. A 10mM ammonium acetate in water, mobile phase B acetonitrile, flow rate of 0.3 ml/ min. Gradient: 20% A 80% B ( 0 min) to 50% A 50% B (12 min) to 50% A 50% B (26 min). Detection FT-MS in negative ion mode. ....	133
Figure 4-1 Reaction scheme showing the synthesis of type C silica and then formation of a $\beta$ -pinene phase via hydrosilation. ....	139
Figure 4-2 A) pure silica, B) silicon hydride and C) $\beta$ -pinene bonded to the Si-H phase scanned by Fourier transform infrared spectroscopy (Exoscan 4100) instrument.....	140
Figure 4-3 Extracted ion traces for proline on 7 HILIC columns with 0.1% v/v formic acid as the mobile phase modifier. Conditions as in section 3.2.2. ....	142
Figure 4-4 Extracted ion traces for proline on 7 HILIC columns with 10 mM ammonium acetate as the mobile phase modifier. Conditions as in section 3.2.2.....	143
Figure 4-5 Extracted ion traces for lysine on 7 HILIC columns with 0.1% v/v formic acid as the mobile phase modifier. Conditions as in section 3.2.2.....	144
Figure 4-6 Extracted ion traces for lysine on 7 HILIC columns with 10 mM ammonium acetate as the mobile phase modifier. Conditions as in section 3.2.2.....	145
Figure 4-7 Extracted ion traces for fumaric acid on 7 HILIC columns with 0.1% v/v formic acid as the mobile phase modifier. Conditions as in section 3.2.2. ....	146
Figure 4-8 Extracted ion traces for fumaric acid on 7 HILIC columns with 10 mM ammonium acetate as the mobile phase modifier. Conditions as in section 3.2.2.....	147
Figure 4-9 Extracted ion traces for glucose on 7 HILIC columns with 0.1% v/v formic acid as the mobile phase modifier. Conditions as in section 3.2.2. ....	148

Figure 4-10 Extracted ion traces for glucose on 7 HILIC columns with 10 mM ammonium acetate as the mobile phase modifier. Conditions as in section 3.2.2. ....	148
Figure 4-11 Extracted ion profiles for glucose on the three hydride columns using ammonium bicarbonate as the mobile phase modifier. Conditions as in section 3.2.2. ....	149
Figure 4-12 Extracted ion chromatograms for sugar isomers A: fructose, mannose, glucose, galactose. B: fructose 6-phosphate, glucose 1-phosphate, glucose 6-phosphate, galactose 6-phosphate. C: ribose, ribulose, xylose and arabinose. Conditions: Cogent Silica C column (250 x 4.6 mm, 4 $\mu$ m). A 10 mM aqueous ammonium bicarbonate B Acetonitrile. Time 0 83% B, time 22 70% B, time 35 70% B, 0.3 ml/min. ....	150
Figure 4-13 Extracted ion traces for decanoyl carnitine (m/z 316.24-m/z 316.25) extracted from urine run on a Silica C, Diamond Hydride and Pinene columns. Conditions as in section 3.2.2. ....	152
Figure 4-14 Extracted ion chromatograms for tetrahydrocortisol glucuronides run on three hydride columns. Mobile phase A 10 mM ammonium acetate in water, mobile phase B acetonitrile, flow rate of 0.3 ml/ min. Gradient: at 0 min 20% A 80% B, at 12 min 50% A 50% B and remain the same till 26 min 50% A 50% B. Detection FT-MS in negative ion mode..	154
Figure 4-15 Extracted ion trace of metabolites in urine with masses between m/z 132.0-132.12 run on a Silica C column. Conditions as in section 3.2.2. ....	155
Figure 5-1 Scheme for the metabolism of nicotine [132]. ....	160
Figure 5-2 Extracted ion traces showing <sup>2</sup> H <sub>4</sub> -nicotine, nicotine, cotinine, nicotine N-oxides and nornicotine oxide extracted from the hair of dog 7 following 2 h digestion in 1 M NaOH followed by SPE. ....	165
Figure 5-3 Extracted ion traces of an extract from the hair of a dog not exposed to cigarette smoke spiked with 1 $\mu$ g of <sup>2</sup> H <sub>4</sub> -nicotine. ....	165
Figure 5-4 Calibration curve for the nicotine fitting regression equation and the R <sup>2</sup> value..	167
Figure 5-5 Dissolution of nicotine and its metabolites from dog hair (dog 7) over 2 h of sonication in methanol. ....	169
Figure 5-6 Extracted ion traces showing <sup>2</sup> H <sub>4</sub> -nicotine, nicotine, cotinine and nicotine N-oxides extracted from the hair of dog 7 following 2 h sonication in methanol. ....	170

## List of Tables

---

Table 1.1 Common mobile phase buffer additives: type, pKa and the active pH range.....	62
Table 2.1 The effect of two different counter ions on the retention time of 5 bases with an ACE CN column and mobile phase (5% buffer water: 95% acetonitrile) pH 6, flow rate 0.8 ml/min.....	86
Table 2.2 Retention times of basic compounds at pH 6 on an ACE CN column (150 x 3 mm, 3 µm particle size) containing 3.25 mM tetraethylamine acetate in acetonitrile/water (95:5), flow rate 0.8 ml/min. ....	88
Table 2.3 The effect of using 3.25 mM pH 6.0 tris acetate (pK <sub>a</sub> 8.1) as the counter ion in comparison with 3.25 mM ammonium acetate pH 6.0 on the retention times of the 5 base mixture ACE CN column (150 x 3 mm, 3 µm particle size) (5% buffer: 95% acetonitrile) pH 6, flow rate 0.8 ml/min and UV detection at 220 nm. ....	89
Table 2.4 Retention times of weakly basic compounds at pH 6 on an ACE CN column (150 x 3 mm, 3 µm particle size) with 3.25 mM tris and 3.25 mM bis tris in acetonitrile/water (95:5), flow rate 0.8 ml/min. ....	92
Table 2.5 Structures of the organic bases used to test the mechanism of retention on an ACE CN column. P= primary amine, S= Secondary amine, T=tertiary amine, Q=quaternary amine. ....	101
Table 2.6 Retention times of basic compounds at pH 6 on the ACE CN column (150 x 3 mm, 3 µm particle size) 3.25 mM ammonium acetate in acetonitrile/water (95:5), flow rate 0.8 ml/min.....	105
Table 2.7 Retention times of basic compounds at different pH values on an ACE CN column (150 x 3 mm, 3 µm particle size) in 3.25 mM ammonium acetate in acetonitrile/water (95:5), flow rate 0.8 ml/min. ....	108
Table 2.8 Retention times of basic compounds with different concentrations of the buffer on the ACE CN column (150 x 3 mm, 3 µm particle size) varying strengths of ammonium acetate in acetonitrile/water (95:5), flow rate 0.8 ml/min. ....	109
Table 2.9 Retention times of basic compounds with different aqueous percentage of the mobile phase on the ACE CN column (150 x 3 mm, 3 µm particle size) with 3.25 mM ammonium acetate in acetonitrile/water, flow rate 0.8 ml/min. ....	112
Table 3.1 Retention times of bases on silica gel and type C silica with 0.1% v/v formic acid modifier.....	124
Table 3.2 Retention times of bases on silica gel and type C silica with 10 mM ammonium acetate buffer/acetonitrile. ....	126
Table 3.3 Retention times of sugars on silica gel and type C silica columns with 10mM ammonium acetate buffer and 0.1 % formic acid buffer. ....	129
Table 3.4 Retention times of acids on silica gel and type C silica columns with 10 mM ammonium acetate buffer and formic acid buffer. ....	132

Table 4.1 Some acid conjugates representative compounds present in urine giving an indication of the different properties of the three hydride columns. Compounds were identified on mass matching of < 3 ppm . *=poor peak shape. ....	152
Table 4.2 Some steroid conjugates of compounds present in urine giving an indication of the different properties of the three hydride columns. Compounds were identified on mass matching of < 3 ppm. ....	153
Table 4.3 Isobaric compounds ( $[M+H]^+$ between 132.0-132.2 (taken from the Metlin database).....	155
Table 5.1 Concentration of nicotine determined in dog hair in a 15 min methanol wash and in the NaOH digest following the methanol wash.....	166
Table 5.2 Metabolites of nicotine observed in smoke exposed dog hair samples with mass deviations from their exact elemental composition by using NaOH method.....	167
Table 5.3 Concentration of nicotine in dog hair determined in NaOH digests with no pre-washing of the hair and in methanol extracts prepared by 2 h of sonication. ....	172
Table 5.4 The amount of the nicotine in the Methanol wash and in the NaOH extraction for all the dogs' hair samples. (S) = smoker and (NS) = non-smoker, group exposure to nicotine (0) = Never, (1) = Occasional and (2) = regularly. ....	174
Table 5.5 Percentage of dogs exposed to ETS in different locations (n= 23). ....	176



# List of Abbreviations

---

2MBA	2-Methylbenzylamine
AA	Ammonium acetate
ACN	Acetonitrile
AGC	Automatic Gain Control
Arab	Arabinose
API	Active Pharmaceutical Ingredient
BA	Benzylamine
BDMA	Benzyldimethylamine
BTEA	Benzytriethylamine
BTMA	Benzyltrimethylamine
C18	Octadecyl
C4	Butyl
C8	Octyl
CD	Cyclodextrin
CN	Cyanopropyl silica
ELSD	Evaporative light scattering detection
EP	European Pharmacopeia
ESI	Electrospray Ionization
ESI-MS	Electrospray Ionization-Mass Spectrometry
ETS	Environmental Tobacco Smoke
FA	Formic acid
FMO3	Dimethylaniline monooxygenase
Fruc	Fructose
Fruc 6-phos	Fructose 6-phosphate
FT-IR	Fourier Transform infrared spectrometry
FT-MS	Fourier Transform Mass spectrometry
Gal	Galactose
Gal 6-phos	Galactose 6-phosphate
GC-MS	Gas Chromatography Mass Spectrometry
Gluc	Glucose
Gluc 1-phos	Glucose 1-phosphate
Gluc 6-phosp	Glucose 6-phosphate
h	Hours
HCl	Hydrochloric Acid
HILIC	Hydrophilic Interaction Liquid Chromatography
HNC	Hair nicotine concentration
HPLC	High Pressure Liquid Chromatography
LC-MS	Liquid Chromatography-Mass Spectrometry
LLE	Liquid-Liquid Extraction

LLOD	Low limit of Detection
LLOQ	Lower Limit of Quantification
m/z	Mass-to-Charge Ratio
Man	Mannose
MP	Mobile phase
MS	Mass Spectrometry
MS–MS	Tandem mass spectrometry
NaOH	Sodium Hydroxide
ND	Not Detected
NEBA	N-ethyl benzylamine
NMBA	N-methylbenzylamine
NMR	Nuclear Magnetic Resonance
NPBA	N-isopropylbenzylamine
NPLC	Normal Phase Liquid Chromatography
NS	Non-smoker
NTBA	N-tertiarybutylamine
P	Primary amine
P450	Cytochrome P450
PP	Protein Precipitation
ppm	part per million
Q	Quaternary amine
R <sup>2</sup>	Correlation Coefficient
Rib	Ribose
Ribul	Ribulose
RPLC	Reverse Phase Liquid Chromatography
RSD	Relative Standard deviation
S	Secondary amine
S	Smoker
SP	Stationary Phase
SPE	Solid Phase Extraction
T	Tertiary amine
TEA	Tetraethylamine
TEBA	Triethylbenzylamine
TES	Triethoxysilane
TFA	Trifluoroacetic acid
TIC	Total Ion Current
TMBA	trimethylbenzylamine
TMS	Trimethylsilylalanization
tr	Retention Time
UPLC	Ultra pressure liquid chromatography
UV	Ultraviolet Detector
Xyl	Xylose
ZIC-HILIC	Zwitterion Stationary Phase

# **Chapter 1**

## **|Introduction**

## 1.1 Chromatography

The term chromatography was coined in the early 1900s to describe a separation technique based on the relative interaction of a solute with two phases. The two phases were described as the stationary phase (SP) and the mobile phase (MP). Usually the stationary phase is held on a rigid support while the mobile phase is an organic solvent or a mixture of two or more solvents that is capable of dissolving the solute or mixture and carrying it through or over the stationary phase. The retention factor ( $k$ , defined in equation 1) is characteristic of a given compound at a given mobile phase composition, temperature and column type, in other words it describes the affinity of a component towards the column. Chromatographic techniques are classified by the sort of the mobile phase and stationary phase which are used in the separation system and also by the type of interactions involved in the transfer of the analytes between the two phases in the chromatographic process. The classification of the separation can be different based upon the type of the SP and the MP. Most common separation techniques are partition chromatography, adsorption chromatography, ion-exchange chromatography and size exclusion chromatography. These selected methods of separation depend on the analytes, example for the analysis of volatile compounds, the gas chromatography is applied; for the separation of the compounds in their ionic form, the ion exchange chromatography is employed; for the separation of a range of non-volatile compounds, high performance liquid chromatography is used; for the separation of compounds according to their molecular weight, size exclusion chromatography is used [1].

## 1.2 Chromatographic Performance

Firstly the robustness and performance of the chromatography system has to be considered. The ideal chromatography system offers stable retention times, high efficiency, good peak shape and good resolution. . The ability of a column to retain an analyte is expressed as the capacity factor  $k'$  shown in equation 1. If the chromatogram shown in Figure 1.1 is considered it can be seen that there is a peak with retention time  $t_r$  and in addition there is an important marker peak at  $t_o$  which is an un-retained peak and this marks the void volume of the column. This is essentially the empty space in the column which an un-retained analyte has to pass through in order to reach the detector. Silica gel based packings are highly porous and for the average packing is at least 60%-70% of the volume of silica gel is empty space. Thus it is possible to estimate the void volume  $V_o$  in ml from equation 2. Thus for a 15 cm x 0.46 cm column  $V_o$  would be ca 1.5 ml and at 1 ml/min flow  $t_o$  would be 1.5 min. The efficiency of the column, essentially how narrow the peaks are, is given by equation 3. Finally a measure of peak quality is given by the ratio of  $a/b$  (Figure 1.1) which measured at 5% peak height, the closer this value is to 1 the better the peak shape.

$$k' = \frac{t_r - t_o}{t_o} \quad Eq \quad (1)$$

$$V_o = 0.6 \pi r^2 l \quad \text{Where } r = \text{column radius in cm and } l = \text{column length in cm} \quad Eq \quad (2)$$

$$N = 5.54 \left( \frac{t_r}{w_{1/2}} \right)^2 \quad Eq \quad (3)$$

Since the aim of chromatography is resolve the peaks of compounds in a mixture the most important equation to consider is the resolution equation (equation 4) for two peaks A and B.

$$R_s = \left(\frac{1}{4}\right) N^{0.5} \left(\frac{\alpha - 1}{\alpha}\right) \left(\frac{\bar{k}'}{1 + \bar{k}'}\right)$$

$N$  = efficiency for one of the analytes

$k'_A$  = capacity factor of peak A

$k'_B$  = capacity factor of peak B

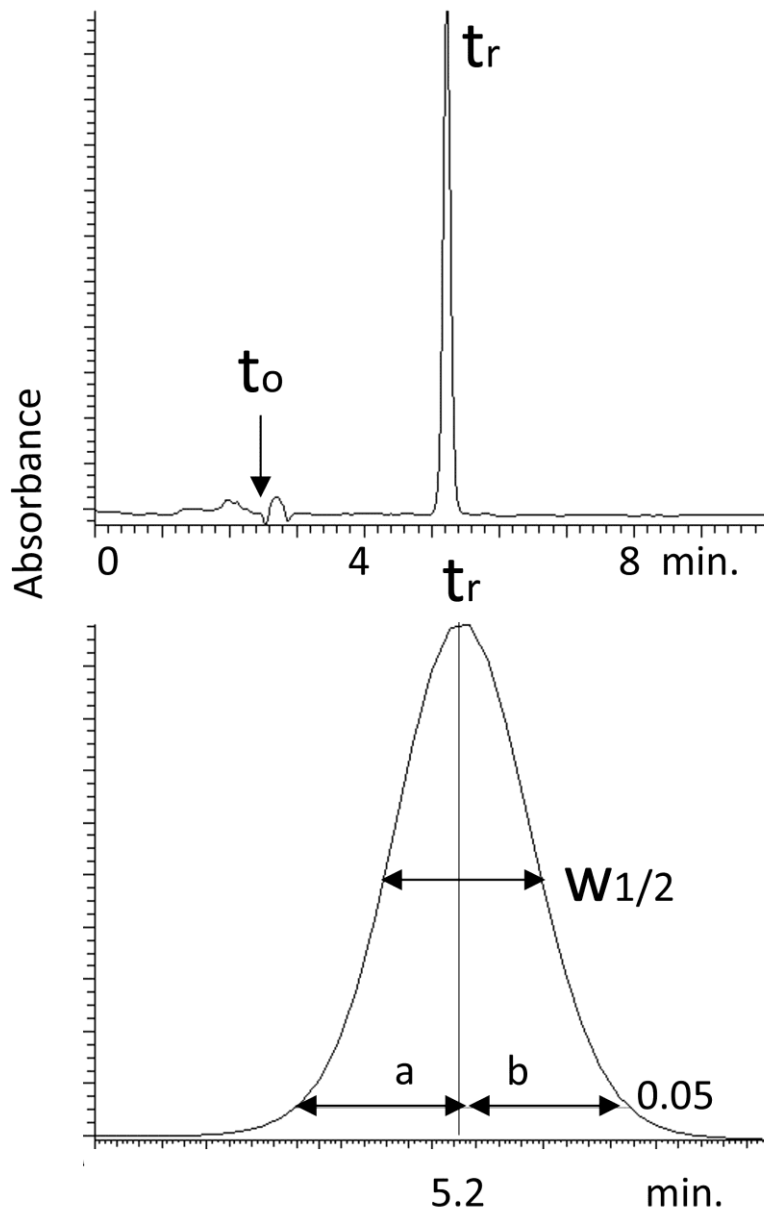
*Eq 4*

$$\alpha = \frac{k'_B}{k'_A} = \text{selectivity}$$

$$\bar{k}' = \frac{k'_A + k'_B}{2}$$

The factor that has the biggest direct effect on resolution is the column selectivity which is governed by the column and mobile phase chemistry. Thus one could have a highly efficient column but without good selectivity then the efficiency will have little impact on the ability of the column to separate analytes. In the following sections the selectivity of some different stationary phases is considered.

Figure 1-1 Some important chromatographic parameters



$t_o$  = Void Time (min)

$t_r$  = Retention Time (min)

$W_{1/2}$  = width of the peak at half peak height (cm).

$a$  = distance from the leading edge of peak to the midpoint (measured at 10% of peak height).

$b$  = distance from the point at peak midpoint to the trailing edge (measured at 10% of peak height).

## 1.3 Separation Techniques

### *1.3.1 Normal phases Liquid chromatography (NPLC):*

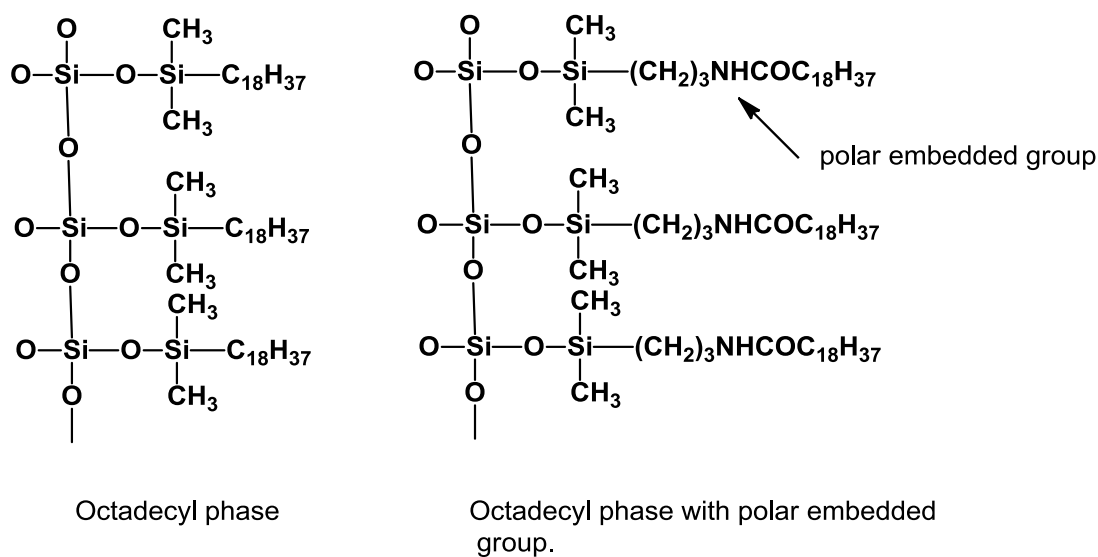
In normal phase (NPLC) chromatography, the technique is applied by using a non-polar mobile phase and polar stationary phase to retain the polar analytes. Some examples of the stationary phases used in NPLC are unmodified silica gel or silica gel with diol, cyano-alkyl, amide-alkyl or amino-alkyl groups bound to it. In general, as a result of the NPLC mechanism polar compounds are retained more than non-polar compounds. The retention of the polar compounds on a polar stationary phase occurs by an adsorption mechanism which is largely due to hydrogen bonding interactions. The composition of the mobile phase in NPLC is usually an organic solvent mixture composed of a very non-polar solvent mixed with a more polar solvent such as hexane/isopropanol or hexane/ethyl acetate. The advantage of NPLC is that it has different selectivity to reversed phase liquid chromatography (RPLC). However, NPLC has a number of disadvantages that limit its application, firstly, low solubility of polar analytes in the non-polar mobile phase; second, it is difficult to ionize compounds in the non-polar mobile phase when interfacing with an electrospray mass spectrometer; thirdly, tailing, fronting and shifting of retention time with concentration of analyte can occur resulting from the slow equilibration with the stationary phase that gives a non-linear isotherm; fourthly, some of the polar stationary phases are not very stable. The major problem is that NPLC cannot be used with an aqueous mobile phase as the adsorption mechanism will not occur under these conditions. In 1970, bonded phases appeared which had the opposite polarity to NPLC known as reversed phases and which offered some different separation mechanism [1].



### ***1.3.2 Reversed phase liquid chromatography (RPLC):***

The reversed-phase (RPLC) model is opposite to that of NPLC, as RPLC has a mobile phase which is polar containing a high amount of water and the stationary phase runs through a non-polar stationary phase such as octadecyl (C18), octyl (C8) or butyl (C4) where alkyl chains are bound to silica. The mechanism of the separation is by partitioning where non-polar analytes are retained more than the polar analytes. RPLC provides an excellent method to retain non-polar compounds however, the retention of the polar compounds with RPLC was challenging. Many attempts have been made to the RPLC so that the polar analytes can be separated with this technique. For the stationary phase, the retention of the low and intermediate polar compounds might be achieved by using very high amount of water with very little or no organic solvent in the mobile phase. The retention of a polar analyte which has intermediate and high amount of non-polar groups in its chemical structure is by a partitioning mechanism. However, this approach was not useful for highly polar compounds and some of the problems appear such as poor wetting and shrinking of the ligand on the stationary phases in the presence of a high amount of water. This results in non-reproducible retention times and low separation efficiencies. To overcome the wettability problems of the reversed phases, polar endcapping groups or polar embedded groups were used to prevent the non-polar stationary phase from collapsing in the presence of 100% amount of aqueous mobile phase (Figure 1.2). However, the retention efficiency of the polar compounds and the retention of highly polar compounds were not much improved by using this method [2, 3].

Figure 1-2 Octadecyl phases with and without polar embedded groups.



The difficulty in retaining highly polar compounds on non-polar stationary phases was not possible as the polar analytes have a high affinity to the aqueous mobile phase and will elute in the void volume. Some modifications of stationary phase were made in order to find a way to increase the interaction between the non-polar stationary phase and a polar analyte. Polar analytes can be divided into two types, neutral or chargeable polar compounds. Stationary phase modified to retain the charged analyte by using ion-pair reagents such as alkyl sulfonates for cations or tetrabutylammonium for anions that can offer an ion-exchange mechanism with reversed phase chromatography. This technique is not expensive and gave a good separation efficiency. However, the technique is not compatible with mass spectrometry, different ion pair resulting in a complex mechanism and the equilibration time with ion pair reagent is very slow which may lead to a gradual drift in retention times.

Analytes derivatization can offer a solution to retain the neutral highly polar compounds. By converting one or more polar functional group to a non-polar group by

chemical reaction. However, derivatization shows some problems such as side products appearing if more than one polar group was derivatized, some polar groups not active with the derivatisation reagent, derivatisation is also time consuming and not always quantitative [1, 4].

### ***1.3.3 Hydrophilic interaction liquid chromatography (HILIC):***

In 1990 Alpert suggested HILIC as a technique for the separation of polar analytes using a hydrophilic stationary phase where the mobile phase was less polar than the stationary phase for example water/acetonitrile in which water is the stronger solvent [5]. HILIC has been steadily gaining interest as a technique for dealing with polar and hydrophilic analytes instead of using RPLC. The retention order of HILIC is roughly the opposite of reversed phase. Alpert clarified the difference between HILIC and normal phase, which is that the expression HILIC has to be used when the water becomes the stronger eluting solvent and the partitioning into water provides the retention mechanism [5]. HILIC can be summarised in the following points: first HILIC can offer a method to separate polar analytes and highly hydrophilic compounds using a system which consists of a polar stationary phase similar to a normal phase and mobile phase similar to that used in reversed phase liquid chromatography, as the stationary phase is polar and the mobile phase has miscible organic solvent; second HILIC can increase the sensitivity of the electrospray ionization (ESI) due to an increase in the ionization efficiency as the HILIC mobile phase contains a high amount of organic solvent such as acetonitrile, thus HILIC can be very compatible with mass spectrometry; thirdly biological samples do not need to be evaporated and re-constituted after protein precipitation with acetonitrile, so the sample can be injected into the HPLC system directly and this simplifies sample preparation in bioanalysis; fourthly counter ions such as chloride, sodium and potassium which are usually used to form pharmaceutical salts

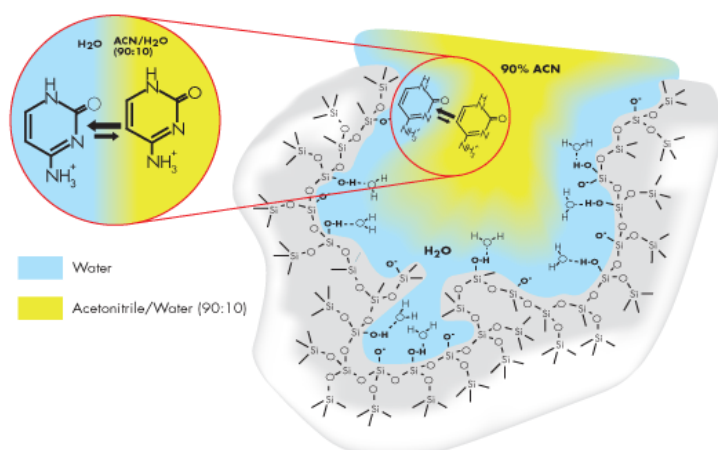
can be separated by using HILIC columns; fifthly the low viscosity of the organic mobile phase allows the use of higher flow rates since the high organic content produces lower backpressure; sixthly a wide range of stationary phases is available.

The HILIC mechanism has some disadvantages as well such as the mechanism of retention not entirely understood (mixed mechanisms), column overloading can be a problem which can produce fronting and also equilibration times can be long for certain column types [10].

### 1.3.3.1. The Mechanism of separation in HILIC

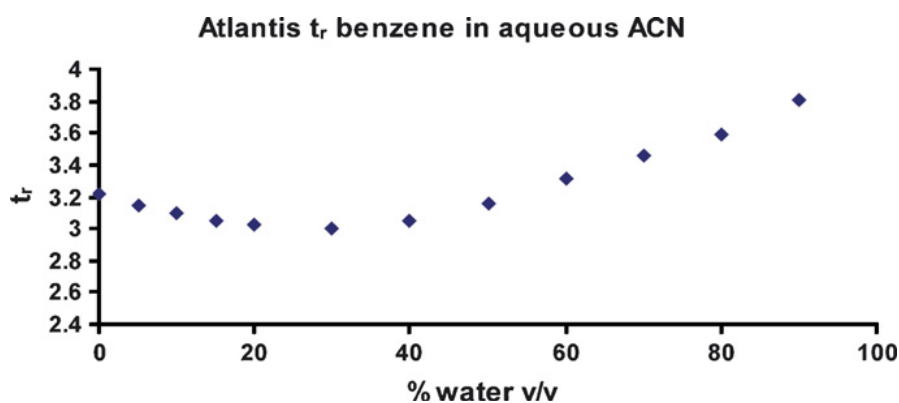
In practice, increase retention of the analytes in HILIC occurs with increased polarity of the analyte, increased polarity of the stationary phase and increased percentage of organic modifier in the mobile phase. Alpert suggests that the chromatographic separation depends on partitioning effect between the mobile phase and a water-rich layer that is adsorbed onto the surface of the stationary phase (Figure 1.3).

Figure 1-3 The partition mechanism in HILIC chromatography [4]



The theory of partitioning when a low amount of water is used in the mobile phase was first proposed in 1941, when Martin and Synge [6] discussed the use of bare silica in the separation of acetylproline and acetylphenylalanine, the mobile phase composition was water/chloroform (3.5:10) and the stationary phase was bare silica. The separation mechanism was confirmed to be partitioning by measuring the partition coefficient for amino acid compounds under these conditions [6]. In 2008, McCally and Neue measured the retention time of benzene using a bare silica stationary phase and a mobile phase containing a low amount of water, in order to confirm the presence and variation of the water rich layer on the surface of the stationary phase. They found that the thickness of the layer increased as the amount of water in the mobile phase was increased [7] (Figure 1.4).

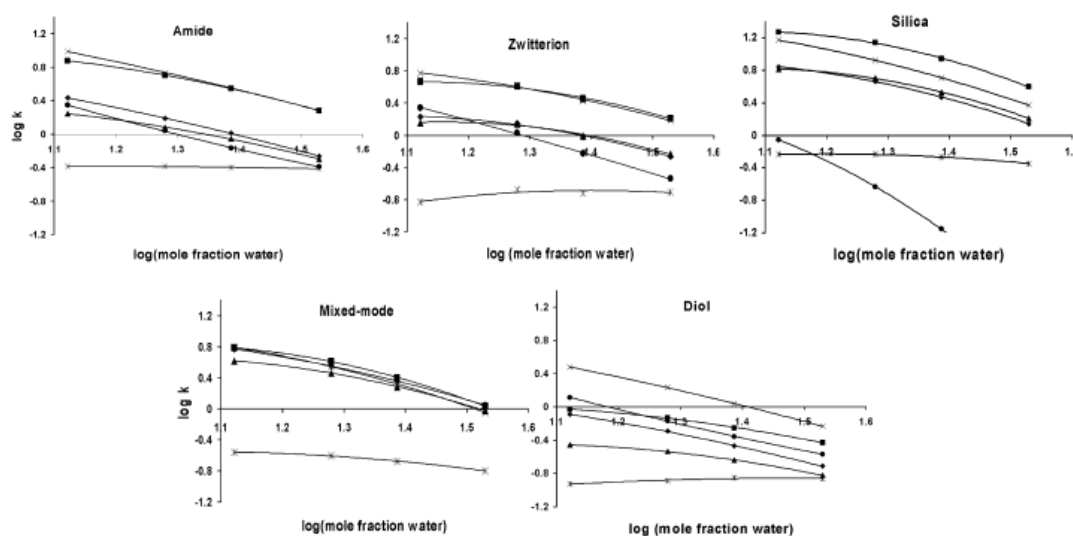
**Figure 1-4 Retention time of the benzene with different percentage of water content in a water/acetonitrile mobile phase using an Atlantis silica column [7].**



It has been concluded that the main mechanism of action in HILIC is due to partitioning for the retention of the polar compounds when a low amount of water is used with a polar stationary phase. However, there are some other interactions which can affect the retention of analytes in HILIC mode such as adsorption, ion-exchange and even hydrophobic

interaction. The existence of the adsorption mechanism in hydrophilic interaction was confirmed by McCalley [8] when he studied the retention mechanism of different chemical compounds such as basic, neutral and acidic analytes on different stationary phases such as silica, amide, mixed mode diol, cross-linked diol, and zwitterionic phases. The composition of the mobile phase was fixed at pH 3 using 5mM ammonium formate to prevent the ionization of the silanol groups and prevent ion exchange interactions between the charged stationary phase and the charged analytes. Retention in adsorption chromatography can be described by  $(\log k = \log k_B - n \log X_B)$ , where  $X_B$  is the mole fraction of water in the mobile phase,  $k_B$  is the retention factor in water,  $n$  is the number of water solvent molecules. Thus a plot of  $\log k$  against mole fraction water should give a straight line when the adsorption mechanism occurs. This result was found with the cross-link diol and amide phases (Figure 1.5), indicating that an adsorption mechanism was obtained for these HILIC phases [8]. While the other stationary phases did not produce linear  $\log k$  plots because the retention was due to a mixed mechanism.

**Figure 1-5 Plots of  $\log k$  against log mole fraction of water in the mobile phase. Solute identities:  $\blacklozenge$  = nortriptyline,  $\blacksquare$  = procainamide,  $\blacktriangle$  = diphenhydramine,  $\times$  = benzylamine,  $*$  = caffeine,  $\bullet$  = p-xylenesulfonic acid [8].**



McCalley [8] also confirmed that ion exchange was one of the separation mechanisms that apply to the HILIC retention mechanism by different ways. The first method he used was to compare the behaviour of acids, bases and neutrals compounds with one type of stationary phase (bare silica) with different buffers and the second method was by comparing the behaviour neutral and basic compounds with different stationary phases. In the first method McCalley showed that the un-modified silica stationary phase retained bases either because it has Si-OH groups which can be ionized or it might be because it can make a larger hydration layer with the mobile phase and retain the bases more. In fact, his study for the latter explanation did not support an increased hydration layer as it should retain both the acidic and the basic compounds. However, the silica stationary phase showed only weak retention of the acidic compounds, possibly as a result of the repulsion of the charged acid compounds (negatively charged) by the negatively charged Si-OH groups. In order to prove this hypothesis, trifluoroacetic acid (TFA) was used to lower the pH and the retention of the acidic compounds was increased on the bare silica in comparison with using ammonium formate. The TFA prevented the ionization of the silanol and thus prevented the repulsion of the charged acidic compounds.

In the second method the retention factor ( $k$ ) was plotted against counter ion concentration in mobile phase (ammonium formate concentration of 2–10mM pH 3.0, 10% water) for different types of columns under HILIC conditions using neutral compounds such as caffeine and four ionisable basic compounds, benzylamine, diphenhydramine, procainamide and nortriptyline. The log  $k$  plots produced curved lines for the four ionisable basic compounds with different stationary phases and a straight line for the neutral

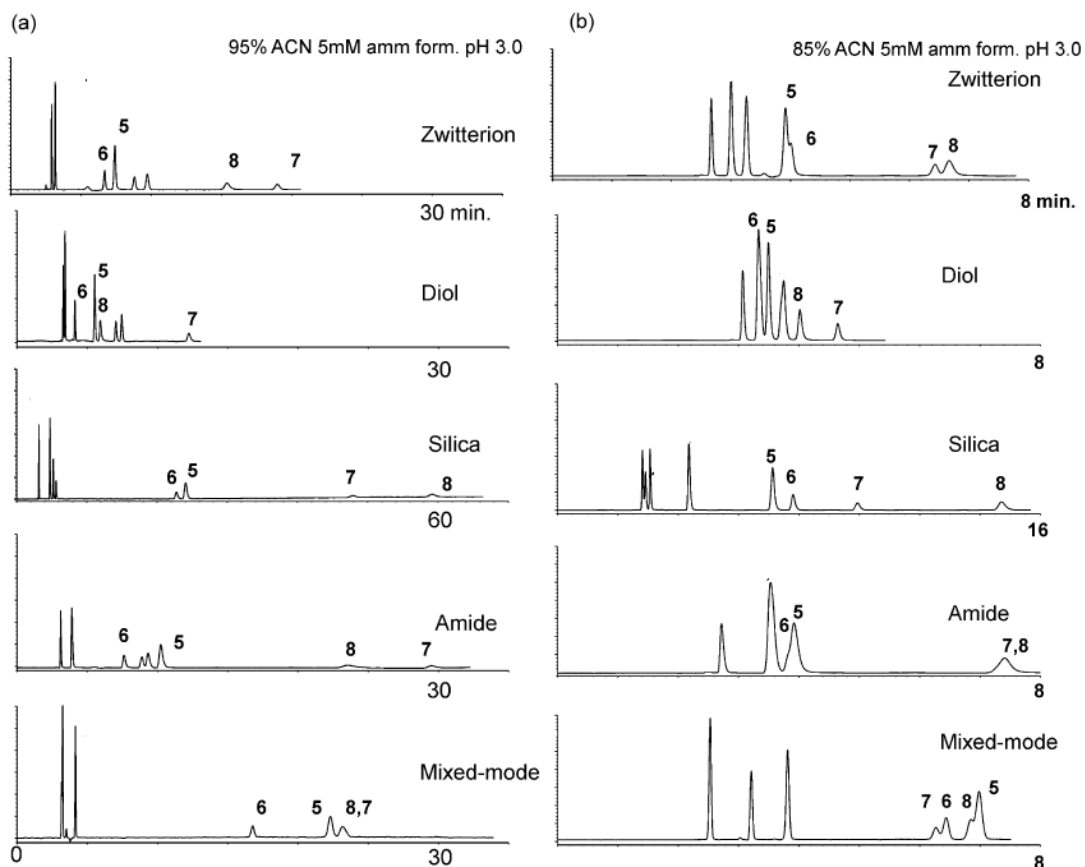
compounds. This confirmed that the separation mechanism in HILIC also contained ion exchange interactions for basic compounds [8].

It is worth to mention that unmodified silica stationary phase is the highest ionized stationary phase because it consist only of silanol group. in the case of the zwitterionic stationary phases, the cation exchange was due to a sulphonic acid groups at the end of the phase. With the neutral stationary phase such as amide and diol, the cationic exchange mechanism should be due to the ionization of the Si-OH group which remains after bonding the stationary phase ligand [8].

The HILIC also showed hydrophobic interaction mechanism, McCalley showed the behaviour of the hydrophilic and the hydrophobic bases with different HILIC stationary phases such as silica, amide, cross linking diol, mixed mode diol and zwitterionic. The two mobile phase conditions used were water:acetonitrile (15:85 and 5:95) containing 5mM ammonium formate pH 3.0. It was found that the hydrophilic bases (benzylamine and procainamide) eluted under both conditions after the hydrophobic bases (nortriptyline and diphenhydramine) on all mentioned stationary phases, which is the expected HILIC mechanism. However, the mixed mode diol stationary phases showed different separation orders for hydrophobic basic compounds. The nortriptyline was retained longer than the hydrophilic basic compounds (Figure 1.6), this effect could be explained because the mixed mode phases might also produce hydrophobic interaction interactions with more the hydrophobic compounds [8].



**Figure 1-6 Chromatographs for 5. nortriptyline, 6.diphenhydramine, 7. benzylamine, 8 procainamide. with different stationary phases and the mobile phases are a) acetonitrile:water (95:5, v/v) and b) Acetonitrile:water (85:15, v/v) both containing 5 mM ammonium formate pH 3.0 [8].**



The mechanism of retention on HILIC columns is complex, consisting of partitioning of the solutes between the bulk mobile phase and the surface water layer on the stationary phase, adsorption via hydrogen bonding or/and dipole/dipole interactions, ionic interaction between charged stationary phase (or charged Si-OH on silica support) and charged analytes and sometimes even hydrophobic interaction between non-polar analyte and non-polar stationary phase. This indicates that the HILIC separation mechanism depends on the solute properties, the nature of the stationary phase and the mobile phase composition producing a complex multifactorial mechanism of retention

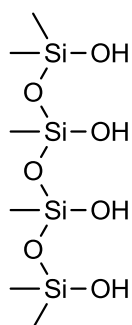
## 1.4 Types of HILIC columns:

The HILIC stationary phases have been classified below according to their chemical properties and not by their brand names with the aim of trying to understand the different mechanisms that each phase can offer for the separation of the polar compounds. The surface chemistry of the different types of HILIC columns are shown below.

### 1.4.1 Bare Silica

So far, the silica based phases (figure 1.7) have been divided into three different types and the difference between these types is according to the particle shape, the amount of the metal contamination within the silica gel and the types of silanol group (figure 1.8). The silica types are Silica type A (high metal content), Silica type B (based deactivated) and Silica type C (silicon hydride). Silica type A was the first type of silica to be introduced and it has been used for almost every purpose as a chromatography material.

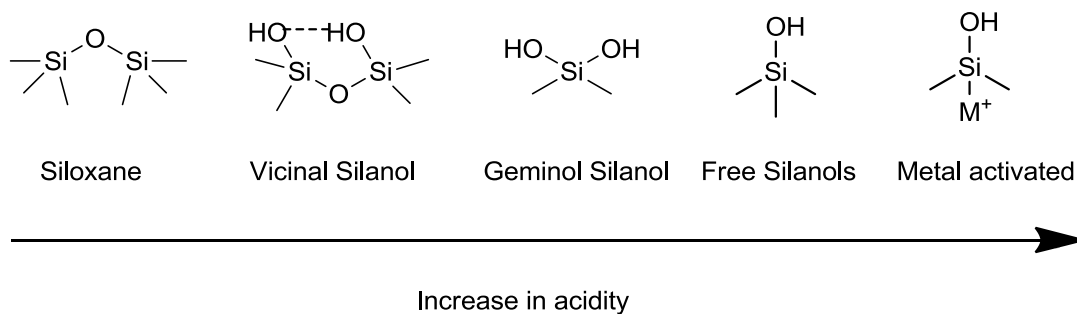
**Figure 1-7 The chemistry of the surface of bare silica gel.**



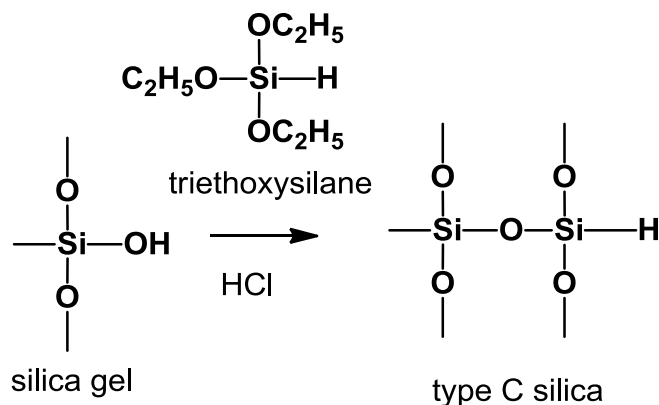
The problem of this type of silica gel is that it is acidic, the high acidity is because it is contaminated with different metals and this sometimes affects chromatography adversely and also it has irregular particle size. Silica type B was the next generation of silica gel after silica type A and it is almost free from the metal impurities because the silica has been treated with acid to reduce the metals which are responsible for the increase in the acidity

of the silica gel surface and it has a spherical particle size. The last type of the silica is known as silica type C (Silicon hydride), this group prepared by a hydrosilylation process where the Si-OH groups are covered with Si-H (Figure 1.9).

**Figure 1-8 Types of silanol groups [9].**



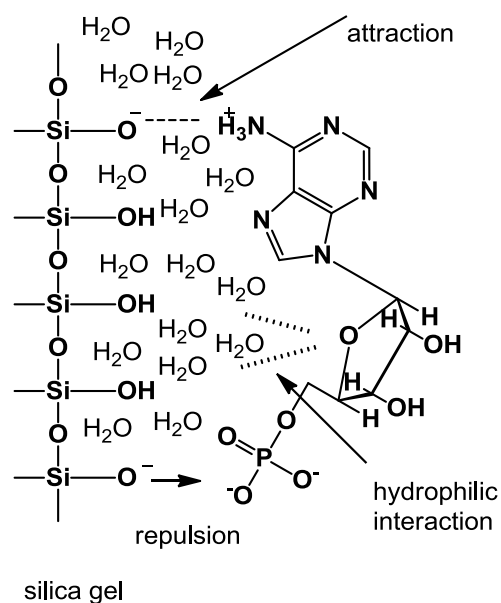
**Figure 1-9 The hydrosilylation process.**



There are many types of bare silica column which have been produced by different companies such as Hypersil and Kromasil. It has been noted that the properties between different HILIC silica columns from different manufactures for the same type of HILIC silica column are different [2]. This is probably because of the difference in the purity of the silica or different manufacturing processes used during the column preparation. The partition and

ion exchange mechanism are performed the elution mechanism on the bare silica columns under HILIC conditions. These mechanisms can affect the separation mechanism on the bare silica which can occur via single or mixed modes when the HILIC technique is applied. The type of the separation mechanism on the bare silica column depends on the properties of the analyte and the mobile phase. Analytes will be strongly retained if the Si-OH groups are ionized and the analyte is basic having a positive charge and this will lead to a longer retention times as the ion-exchange between the basic ionic compound and the negatively charged silanol groups will provide a second interaction besides the partitioning mechanism. For acidic compounds the retention mechanism for the un-ionised acidic compound can only be due to partitioning, however, when it is ionized the partitioning of acids into the water layer associated with the silica gel surface may increase but there may also be charge repulsion effects with the negative charges on silica gel surface. This summarised in Figure 1.10 for a compound with acid basic and neutral groups.

**Figure 1-10 The types of interaction which can occur between an analyte and the silica gel surface in HILIC mode.**



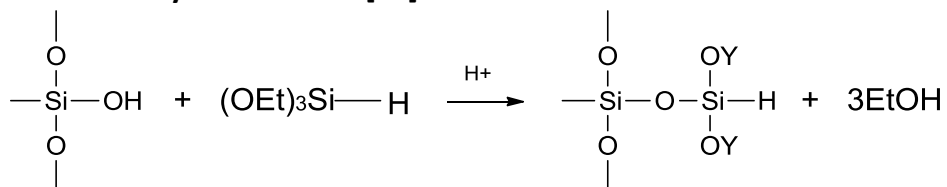
The main advantage of unmodified silica is the absence of the ligands and this simplifies the interactions with the stationary phase. In addition, comparing bare silica under HILIC mode and under normal phase mode, it has been shown that bare silica in HILIC is more compatible with biological extracts where the interesting compounds are polar and exist in a complex matrix. Many polar compounds in biological matrices are not soluble in organic solvents.

#### 1.4.2 Silicon Hydride Columns (Type C Silica)

The silica type C column was introduced to overcome the effects of silanol groups and to offer a different degree of selectivity. It is prepared by the hydrosilation process which gives the silica surface unique characteristics. The recent approach for preparing the silicon hydride stationary phase from the normal silica is by reaction of the triethoxysilane with the normal silica and using hydrochloric acid as a catalyst (Figure 1.11). This procedure is known as hydrosilation and it produces a surface which is stable for a long time in water or air.

Type C silica is easy to prepare and it can yield 95% surface coverage with silicon hydride (Si-H) in place of Si-OH [10].

**Figure 1-11 The hydrosilation reaction of the Silica gel and triethoxysilane (TES) resulting in a silicon hydride surface [10].**

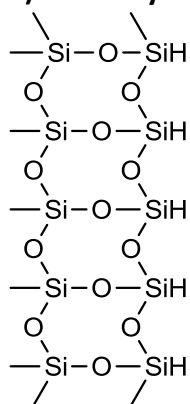


The resulting Si-H stationary phase is less polar than silica gel, and less attractive to water therefore it can provide some new selectivity for HILIC of non-polar compounds and improve the reproducibility of elution [11]. The Si-H groups produce a mixed mode of

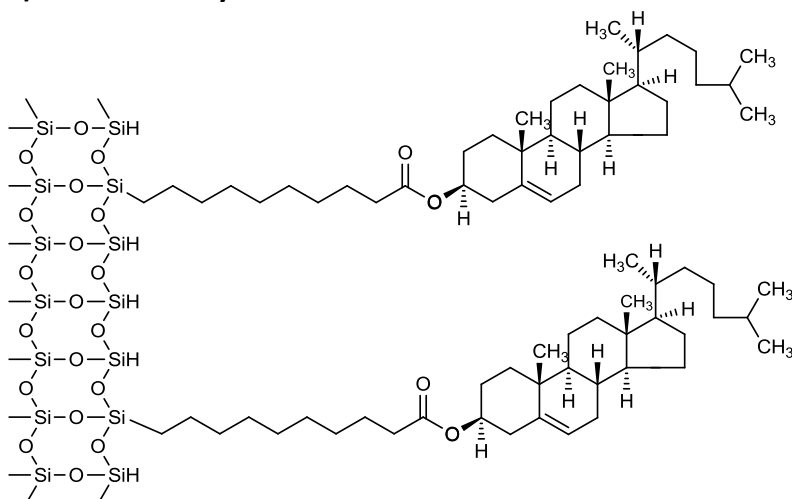
separation which includes both reversed phase and HILIC. The reversed phase interaction occurs when there is a high amount of water in the mobile phase and there is an increase in the affinity of the non-polar compounds to the Si-H stationary phase. However, the opposite elution occurs when a lower percentage of water in the mobile phases used, usually from 5-30%, the HILIC interaction predominates [12]. This observation cannot be seen on the bare silica stationary phase, which has very high hydrophilic properties and cannot retain non-polar compounds under RPLC conditions [11]. Different silicon hydride bonded stationary phases have been developed such as the UDC Cholesterol phase which is chemically linked to cholesterol and bidentate C18 silicon hydride (figure 1.12). When these phases were compared by Soukup and Jandera for the separation of flavonoid compounds in HILIC mode with identical conditions, they found that the elution order was the same for all these phases. However, the retention time increased with increasing the polarity of the phases [13].

**Figure 1-12 Chemical structure of the A) Silicon hydride, B) UDC Cholesterol hydride and C) Bidentate C18 hydride phases**

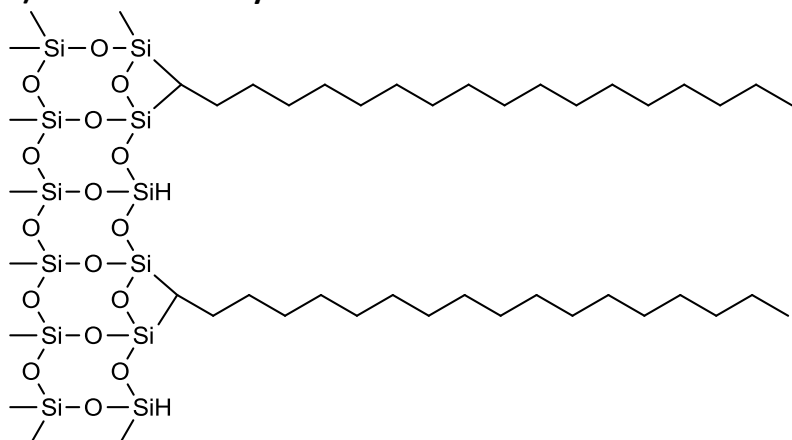
**A) Silica hydride**



**B) Cholesterol hydride**



**C) Bidentate C18 hydride**



### ***1.4.3 HILIC columns based on silica gel with neutral surface ligands***

#### ***1.4.3.1 Diol silica***

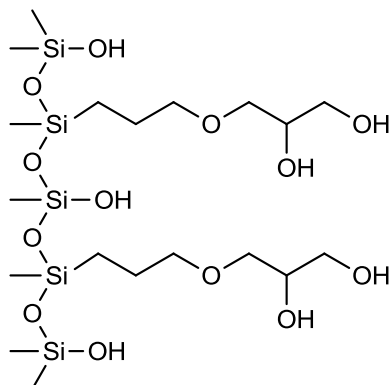
Diol silica gel stationary phases have a bonded stationary phase that is very close to bare silica (figure 1.13) in terms of the degree of their polarity. However, they are different as they are unionized except for any non-reacted Si-OH groups which can be removed to some extent by end-capping by using trimethylsilylation (TMS) reagents. The diol phase can be classified as a neutral stationary phase [14] although is likely even with endcapping that there are still many silanol groups remaining on its surface. However, one of the main reasons for developing the diol silica stationary phase was to overcome the irreversible absorption mechanism properties of the bare silica stationary phase and offer different separation selectivity. The diol stationary phase is suitable to use in HILIC mode because it has high polarity and can accept and donate hydrogen bonds which are essential for formation of the hydration layer around the surface of the phase. The separation technique in diol silica is similar to the bare silica and a high percentage of organic mobile phase containing a low percentage of water is used to perform HILIC mechanism. However, with a higher aqueous content in the mobile phase, non-polar compounds can be retained by a reversed mechanism because the diol silica has a hydrophobic alkyl chain functionality that can interact with the non-polar analytes, unlike the bare silica column. Liu [15] tested the diol-silica column for separation a different ethoxylated alcohol surfactants containing OH and different alkyl chain groups. At higher amount of water the separation was based on the alkyl lengths as in the reversed phase technique and at lower amount of water, HILIC mode occurs and the retention is depend on the number of OH groups in the analytes chemical structures. Another advantage of the diol stationary phase under HILIC mode is its ability to determine the mutarotation of the sugars. For example monitoring of the mutarotation of



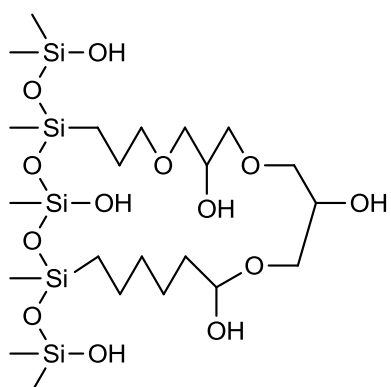
monosaccharides was carried out by using isocratic runs with a retention time of less than 10 min. [16]. The disadvantage of diol columns is that, unlike bare silica the diol silica columns can lose the bonded phase under acidic conditions. Therefore a cross-linked diol column was developed to overcome these stability issues (figure 1.13). Moreover it was observed that the cross-linked diol column offered stronger hydrophobic interaction, better peak shape and resolution compared with the normal diol silica [17]. The cross-linked diol column is available on the market and is known as Luna HILIC and it has in some ways the properties of both the polyethylene glycol stationary phase and the diol stationary phase as it has both oxyethylene and hydroxyl groups within the stationary phase [18].

**Figure 1-13 Chemical structures of the mixed mode diol, cross-linked diol and polyethelene glycol phases. None of these stationary phases are endcapped.**

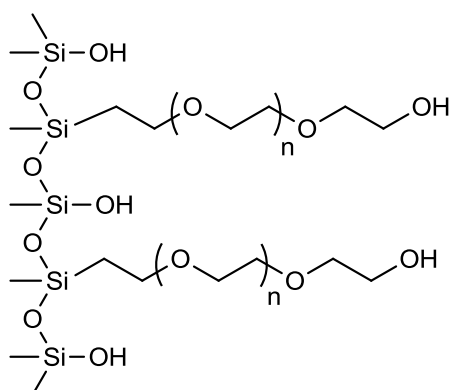
**A) Diol**



**B) Cross-linked diol.**



**C) Polyethelene glycol**

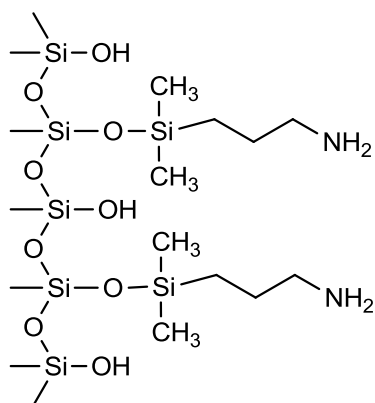


### 1.4.3.2 Aminopropyl silica:

In amino columns the silica is bound to aminopropyl chains so that the surface of the stationary phase carries a primary amine group which at low pH carries a positive charge

(Figure 1.14).

**Figure 1-14 The surface of aminopropyl silica without endcapping**



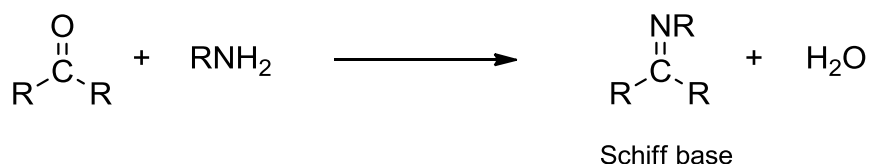
The aminopropyl stationary phase is considered as a polar stationary phase which makes it very suitable to use under HILIC conditions. Unlike bare silica, acidic compounds that have a negative charge are strongly attracted to the ionized aminopropyl groups via an anion exchange mechanism. However, the retention of the charged basic compounds by the ionised aminopropyl column may be reduced because of the effect of the charge repulsion. In addition, an increase in the ionic strength of the mobile phase also produces a reduction in the retention time of acidic samples [19].

One of the problems associated with the aminopropyl column is that it needs long equilibration times with some buffers. For example, Valette *et al.* [20] noted that if the buffer of the mobile phase was changed from citrate to acetate at 100mM, it needed several hundred column volumes in order to obtain a stable baseline. Another problem of the amino phase is the column stability especially when the aqueous eluents are used as

they can produce hydrolysis between the silica and the aminopropyl silane ligand [21]. This can lead to release of the aminopropyl from the silica surface and cause peak shape deterioration under HILIC conditions. In order to overcome stability issues an amino packing based on a polymer instead of silica showed much better stability, for example the development and validation method for detection and separation of taurine and methionine by polymer amino stationary phase [22].

Primary aminopropyl groups can form Schiff's bases with aldehydes, which show the reason for avoiding separation of carbohydrates with the amino stationary phase. The stationary phase can chemically change when the primary amine reacts with carbonyl compounds [23] (Figure 1.15).

**Figure 1-15 Chemical reaction of a primary amine and aldehyde group to produce a Schiff's base.**



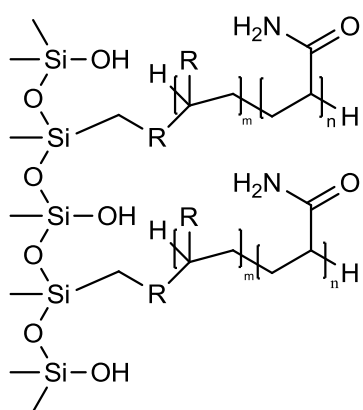
Compared with the primary amines, stationary phases with secondary or tertiary amine groups may result in improved column life time as they cannot form Schiff's bases with carbonyl compounds. Aromatic amines bonded on silica stationary phases have also been used as well under HILIC conditions for separation the polar compounds and showed short elution times and symmetrical peaks [24].

One of the interesting applications of the aminopropyl column is that can eliminate the formation of the two peaks for anomeric compounds and combined them into one peak, providing better peak shape, which is opposite of the diol column [24].

### 1.4.3.3 Amide silica:

Amide stationary phase is an amide containing ligand linked to the silica gel surface via a short alkyl spacer. The difference between the amide and amino stationary phases is that the amide does not have basic properties, therefore an ion exchange mechanism is not involved in the separation. Thus charge interaction between an analyte and the stationary phase does not contribute to the retention mechanism, if it is assumed that residual silanols do not play a part in the retention.

**Figure 1-16 The surface chemistry of amide silica (TSK-Gel Amide-80) without endcapping.**



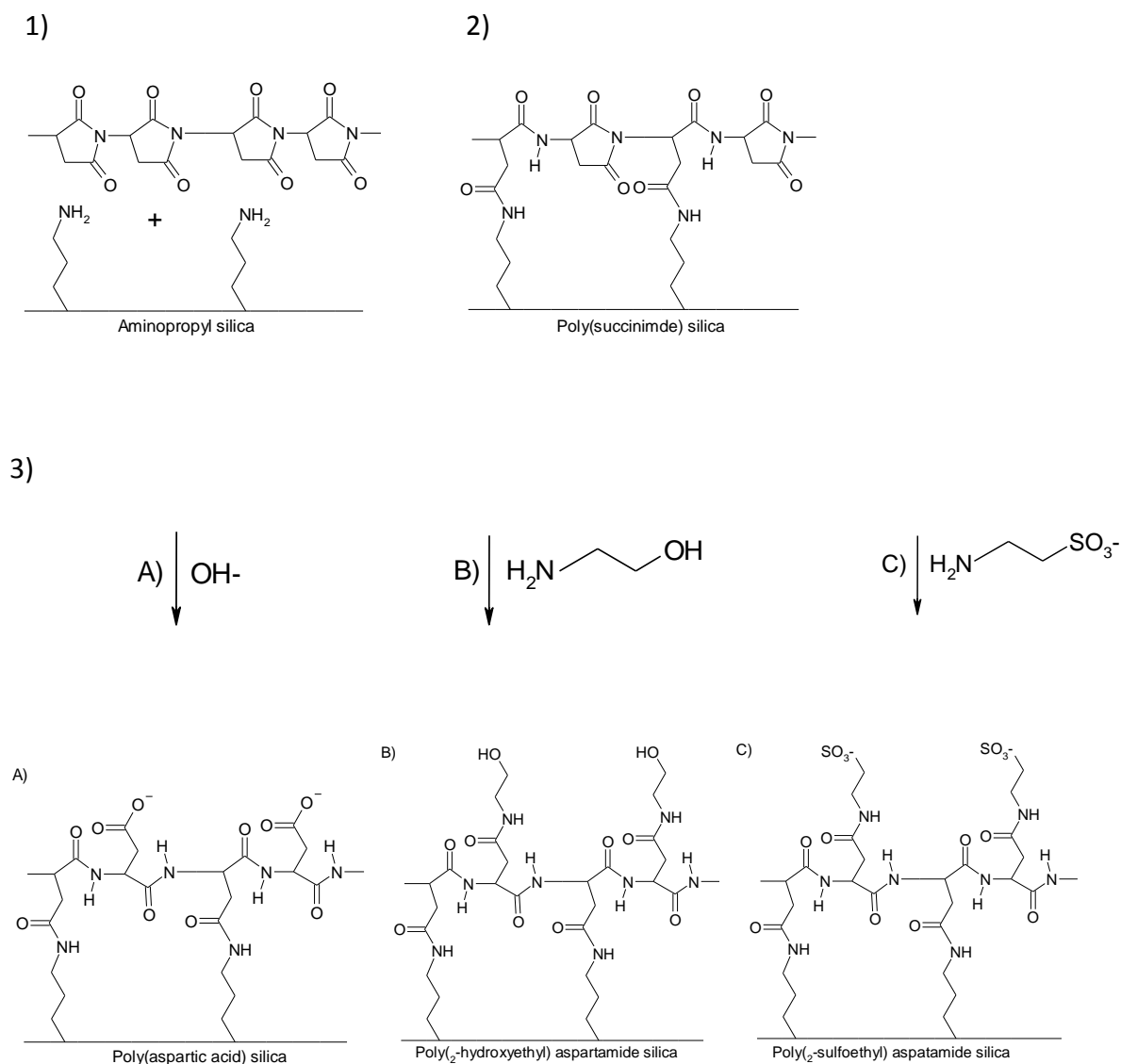
Amide stationary phase is an amide containing ligand linked to the silica gel surface via a short alkyl spacer. The difference between the amide and amino stationary phases is that the amide does not have basic properties, therefore an ion exchange mechanism is not involved in the separation. Thus charge interaction between an analyte and the stationary phase does not contribute to the retention mechanism, if it is assumed that residual silanols do not play a part in the retention. The amide column also has a better stability as there is no irreversible sample adsorption [4]. The advantage of the amide column is that the mobile phase often does not need to contain an ionic modifier as the stationary phase does not ionise. The amide stationary phase showed an interesting result when used in HILIC mode

with evaporative light scattering as a detector to separate mono- and oligosaccharides, sugar derivatives, amino acids and peptides [25]. The carbamoyl-silica HILIC TSK-gel Amide-80 has been developed especially for HILIC (Figure 1.16).

#### ***1.4.3.4 Poly (succinimide)-bonded silica:***

Different attempts have been made to develop aminopropyl columns with different functional groups. Alpert [26] suggested the reaction of the aminopropyl silica with polysuccinimide which provides a reactive surface to which further ligands can be bonded. The first reaction was to prepared polysuccinimide silica, after that further modification to provide many new types of the silica based stationary phases could be carried out (Figure 1.17). For example the weak cation exchanger known as polyaspartic acid was prepared by the alkali hydrolysis of the polysuccinimide surface, poly(2-hydroxyethyl aspartamide) silica gel was obtained with 2-aminoethanol and finally the strong cation exchangers could be prepared from the reaction with 2-aminoethylsulfonic acid which formed poly(2-sulfoethyl aspartamide) silica (Figure 1.17).

**Figure 1-17 Surface chemistry of 2) poly(succinimide) silica, a) Poly(aspartic acid) silica, b) Poly(2-hydroxyethyl) aspartamide silica, and c) Poly(2-sulfoethyl) aspartamide silica.**



These phases exhibited different mixed separation modes under HILIC conditions including varying degrees of ion exchange and partitioning mechanisms. Some of the disadvantages that were seen on the poly(2-hydroxyethyl aspartamide) HILIC phase were loss of some of its performance in the separation of the polar compounds, resulting in lower efficiency when it was compared with more recent HILIC columns such as ZIC-HILIC [27]. Problems

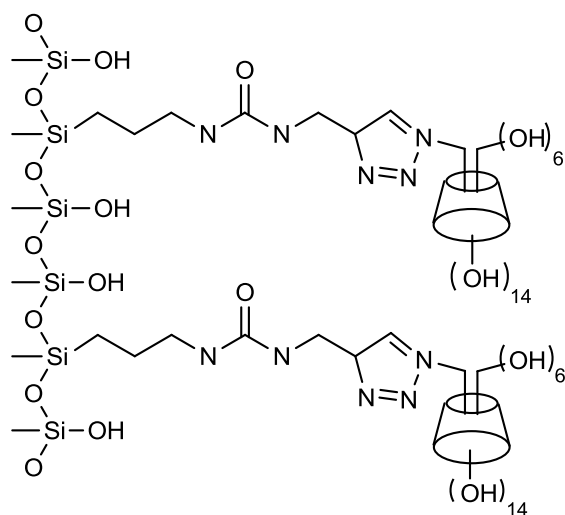
with long term stability [25] and column bleeding could be seen for the polysulfoethyl aspartamide phase [28].

#### 1.4.3.5 Cyclodextrin based columns:

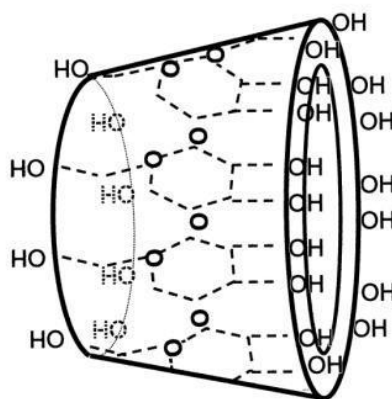
Cyclodextrin (CD) is based on glucose linked with a five or more glucose units which are 1-4 linked-D-glucopyranoside units to form toroid ring structures, with narrow end and wide entrances offering outside hydroxyl groups (OH) to the solvent and having relatively hydrophobic cavities (Figure 1.18). The hydrophilicity inside the toroid of the cyclodextrin is noticeably less than the outside of the toroid, so it can produce a hydration shield between the water and the external part of the toroid, this makes cyclodextrin phases suitable for use in HILIC mode.

**Figure 1-18 A) chemistry surface of a cyclodextrin phase and B) a toroid structure showing the interaction of a polar analyte with the column surface.**

A)



B)



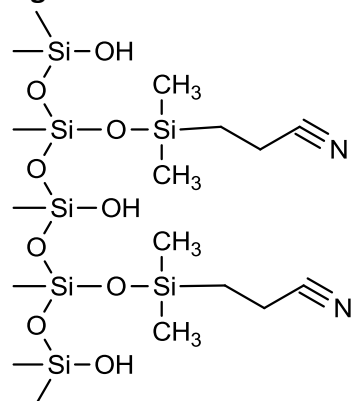


The cyclodextrin group also has chiral recognition properties because the cavities are produced from optically active sugars, and therefore it can be used as a chiral selector in many aspects of analytical separation science [29]. The analyte is retained in the water rich layer on the outside of the cyclodextrin compounds rather than the analyte passing inside the cavity of the cyclodextrin. The polarity of the CD is increased as the number of the monosaccharide groups used to form it increases which leads to the increased retention of polar compounds [30]. It is well known that cyclodextrin phases have been used with liquid chromatography for the separation and detection of chiral compounds. Risley *et al* [31] compared the separation of hydrophilic chiral compounds in normal phase and under HILIC conditions and concluded that the results of the HILIC mode elution was promising and improve enantiomer compound separation in comparison with normal phase mode.

#### 1.4.3.6 Cyanopropyl silica:

Cyanopropyl silica (CN) based columns contain cyano groups linked to a silica support via an alkyl propyl group (Figure 1.19); they are commonly known to be polar phases. The cyanopropyl phase has unique properties which is the lack of the hydrogen bonding donor capability.

**Figure 1-19 Surface chemistry of cyanopropyl silica without endcapping.**



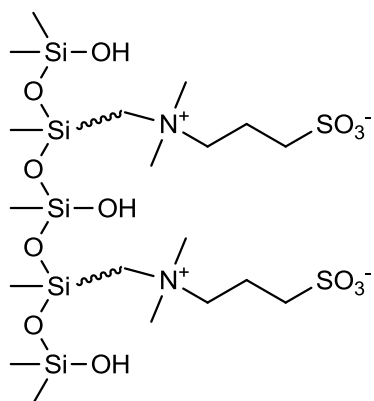
Normal and reversed liquid chromatography modes have been used with CN column. The application of the cyano column in the HILIC mode is limited to the analysis of some compounds such as denaturants in alcohol [32] and another study which found that the column did not show any retention for peptides [33] when a high amount of the organic solvent was used. Thus the cyano column often shows low retention of the hydrophilic compounds. The main problem with the CN column is its stability, the CN ligand is not stable in the HILIC mode because the CN columns suffer when it is run under intermediate polarity solvent, this instability may be due to the breakage of inter-particle linkages [34].

#### ***1.4.3.7 Sulfoalkylbetaine silica:***

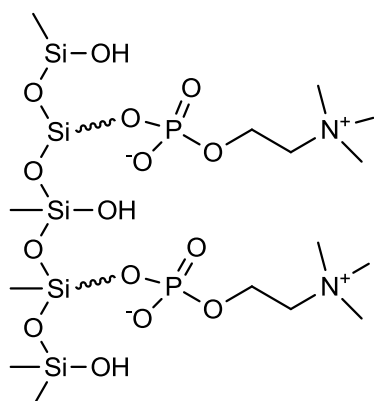
Reducing ionic exchange interactions in HILIC separations was the main reason for developing the zwitterionic functional group stationary phase where the phase is charge neutral. The surface of the zwitterionic phase has the ability to form a hydration layer, it was found that the strong ion exchange interactions do not occur on the surface of zwitterionic stationary phase since the positively and negatively charged groups within the phase cancel each other out. Guo and Gaiki [35] compared the separation of small polar compounds with zwitterionic, silica, amino and amide stationary phases. He found that the zwitterionic stationary phase was the least affected by changing the pH and the selectivity was totally different from that on the amino column [35]. The stationary phase contains both strongly basic quaternary ammonium groups linked to strongly acidic sulfonic acid groups via a short alkyl spacer, the positive and the negative charged groups exist in a ratio of 1:1.01, so there is a very low negative charge on the surface of the SP thus anionic and cationic compounds can be separated [36].

Figure 1-20 the chemical structure of A) ZIC-HILIC and B) ZIC-cHILIC

A)



B)



The water rich layer which is formed with the ZIC-HILIC phase is more or less known as a bulk water, and is quite difficult to disturb by the interferences [37]. The HILIC mechanism dominates on the zwitterionic column for the separation of the polar compounds, so that partitioning is the main elution mechanism. Therefore, when the hydrophilicity of the compound increases its retention in the water rich layer is increased. The ZIC-HILIC is mainly free from Si-OH groups which might affect the separation. The elution order for the

compounds from ZIC-HILIC is according to increase hydrophilicity, which confirms that the mechanism of separation is HILIC [38].

Different types of zwitterionic phases have developed including ZIC-HILIC which is silica based, ZIC-pHILIC (polymer based) and a silica based phosphorylcholine column (ZIC-cHILIC). The ZIC-cHILIC column (figure 1.20) differs from the other columns not only by the charge order, but also by the, type of the negatively charged group which might affect the separation selectivity and the retention order of peptides and other analytes, for example carboxylic acids and amino acids in plant tissues [39]. Cationic and anionic compounds can be eluted from the ZIC-cHILIC and from the ZIC-HILIC columns (figure 1.20), however, their elution order is different.

## 1.5 Factors affecting the separation in HILIC

The HILIC separation mechanism can be affected by different factors which can change the elution order, the retention time, separation efficiency and even the chemical properties of the analytes and the stationary phase. These factors are organic solvent type (mobile phase), pH of the mobile phase, salt type and salt concentration in the mobile phase and the temperature of the column.

### 1.5.1 Column Temperature

The van't Hoff equation is commonly used to calculate the retention factor ( $k$ ) of the analytes at different temperatures:

$$\ln k' = \ln \beta - \frac{\Delta H^\circ}{RT} + \frac{\Delta S^\circ}{R}$$

( $H$ ) = Standard Enthalpy Change related to the movement of the analyte from MP to SP

( $S$ ) = Standard Entropy Change

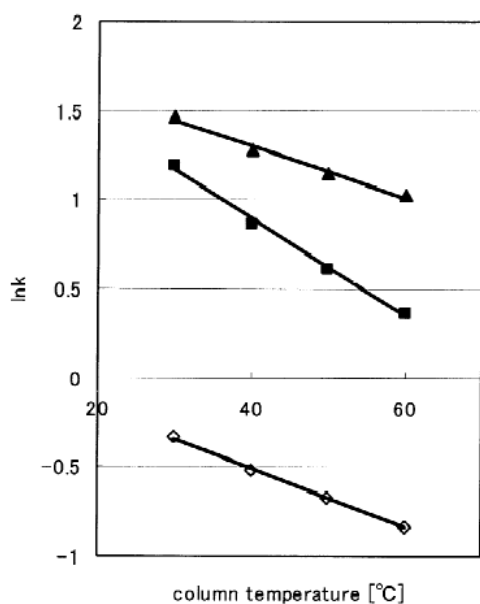
( $R$ ) = Molar Gas Constant

( $T$ ) = Temperature

( $\beta$ ) = Phase Ratio of the Stationary Phase.

The temperature can affect the HILIC mechanism to improve or control the sample separation. The column temperature is responsible for the diffusivity of the solute, the viscosity of the mobile phase and enthalpy required for the transfer of the solutes between the MP and SP, which are all important considerations in HPLC separation systems. It has been noted that a change in the column temperature improves HPLC performance since increasing the column temperature increases the diffusion coefficients for analytes producing narrower peaks with shorter run times. The effect of the temperature on different HILIC columns such as neutral, charged and zwitterionic columns was investigated. The first category of the HILIC stationary phase is for the neutral columns such as diol, and amide. This category does not have ion-exchange interactions with the analytes. Therefore, the different compounds properties were tested and it was found that all of the compounds gave a negative slope when the van't Hoff plot applied, for example urea, sucrose and glycine were run on a diol column and as the temperature increase their  $\ln k$  values decreased because of increasing the solubility of the analyte in the mobile phase [40] (figure 1.21).

Figure 1-21 Plot of  $\ln k$  against the column temperature for ( $\diamond$ ) urea, ( $\blacksquare$ ) sucrose and ( $\blacktriangle$ ) glycine. Mobile phase water/ACN (20:80, v/v), diol stationary phase, flow rate 1.0 ml/min, refractive index detector [40].



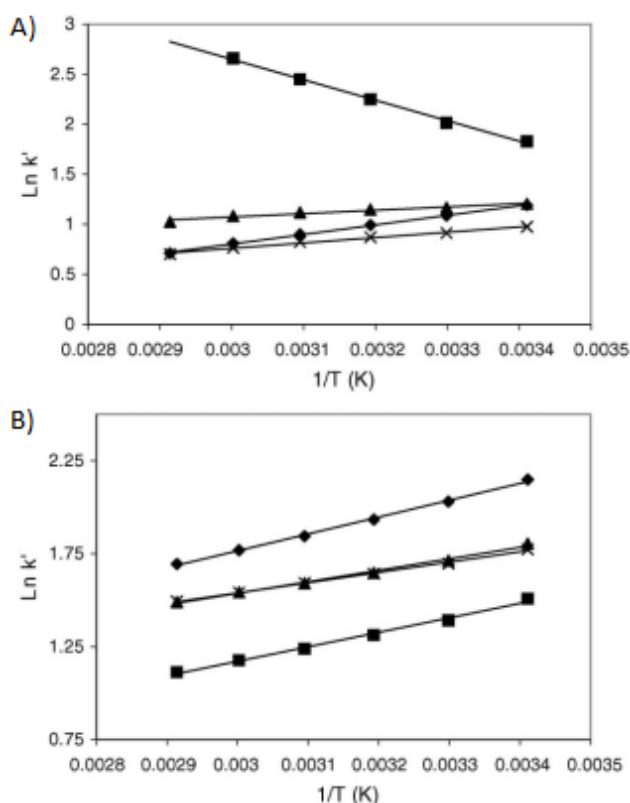
$k$  = Capacity Factor.

°C = Temperature by Celsius.

However, a different effect was observed when the second category of column was tested which had a charged surface such as bare silica and amine stationary phases, for the analysis of aspirin (acid) and cytosine (base). Bare silica showed a negative slope for both analytes with different temperatures. However, the slopes of the van't Hoff plot were found to be positive with the negatively charged compound (aspirin) with the positively charged amino column [35] (figure 1.22). The positive relation between increased temperature and retention on amino column is because the ionic interaction increases at higher temperature as the solvation strength reduces between the ionic analyte and the mobile phase. This leads to more loosely solvated ions and results in more activity of the ions towards ion exchange interactions [41].

The zwitterionic stationary phase represents the last category such as the ZIC-HILIC stationary phase. The ZIC-HILIC column has a unique selectivity as it has its own way to form a partitioning layer with the water and has only weak electrostatic interactions with charged compounds. A negative Van't Hoff slope was found for both aspirin and cytosine on the zwitterionic stationary phase [35] (Figure 1.22) indicating that the thickness of the solvating water layer is probably reduced at higher temperatures.

**Figure 1-22** The van't Hoff plots for A) aspirin and B) cytosine on (■) an amine stationary phase (YMC-Pack NH<sub>2</sub>), (◆) an amide stationary phase (TSKgel Amide-80), (▲) a silica stationary phase (HILIC Silica), and (×) a zwitterionic stationary phase (ZIC-HILIC). Mobile phase: 10 mM ammonium acetate in water/acetonitrile (10/90, v/v) [35].



$k'$  = Capacity Factor.

T = Temperature by Kelvin.

### ***1.5.2. The Effect of the Mobile phase***

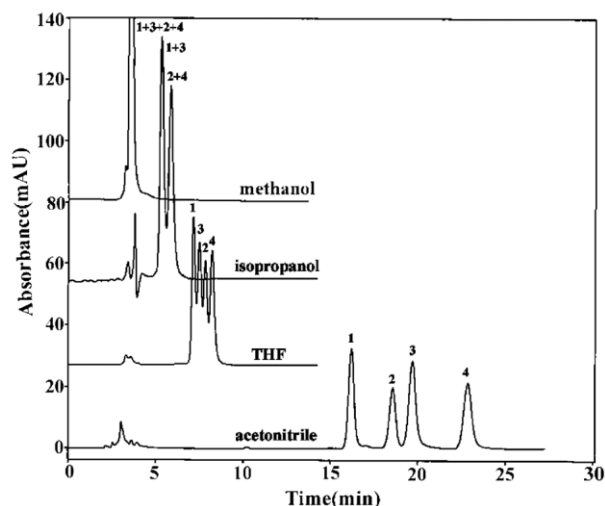
The mobile phase dissolves the samples that need to be analysed and is responsible for moving the sample through the HPLC system and also plays a very important role in the separation mechanism. In HILIC mode, the mobile phase composition is similar to that in reversed phase liquid chromatography however they are different in the amount of the organic solvent mixed with water. Some examples of organic solvents are acetonitrile, methanol and tetrahydrofuran. HILIC has mobile phase which is usually less polar compared with the stationary phase. The mechanism of separation on HILIC is mainly by partitioning between the analyte and the stationary phase composed of an absorbed water layer and the more polar an analyte the more it will be retained by the column. In this case, it is very critical to choose a suitable organic mobile phase in order to improve the selectivity in the HILIC separation system via forming a stable hydration layer. It is possible to divide organic mobile phases into protic and aprotic solvents. Protic solvents include methanol, ethanol and isopropanol and common aprotic solvents are tetrahydrofuran and acetonitrile. The difference between these types is that the protic solvents can accept and donate hydrogen bonds and the aprotic solvent is polar solvent but has no ability to be H-bond donor. This difference means that protic solvents compete for the polar sites on the stationary phase and displace the water rich layer on the surface of the HILIC. This will lead to replacement of the water by organic solvent and makes the stationary phase more hydrophobic [42], as a result reduces the retention of polar analytes on the stationary phase.

Li and Huang [43] compared retention of epirubicin analogues with different organic mobile phases using a bare silica as a stationary phase. As can be seen in Figure 1.23 all four analytes eluted at the same time when the methanol was used. Isopropanol showed a slightly better elution profile because it competes less with the hydration layer on the



stationary phase and the analytes can be retained longer because of the longer alkyl group which makes isopropanol more hydrophobic than the methanol. When the mobile phase was changed from protic to the aprotic solvent tetrahydrofuran greater separation was observed for the analytes and the selectivity was improved further when the acetonitrile was used. The tetrahydrofuran and acetonitrile are weak acceptors of hydrogen donation with the tetrahydrofuran being a stronger hydrogen bond acceptor than the acetonitrile. The mechanism of retention when the acetonitrile was used as the organic modifier was partitioning, however, when the other organic phases were used the retention mechanism was more controlled by an ion-exchange mechanism.

**Figure 1-23** The effect of the different types of the mobile phase organic modifiers on the separation of (1) epidaunorubicin, (2) daunorubicin, (3) epirubicin, (4) doxorubicin. The stationary phase was Kromasil KR100-5SIL and the mobile phase was isocratic water with different organic solvents (10:90, v/v) containing sodium formate (20 mM, pH 2.9) [43].

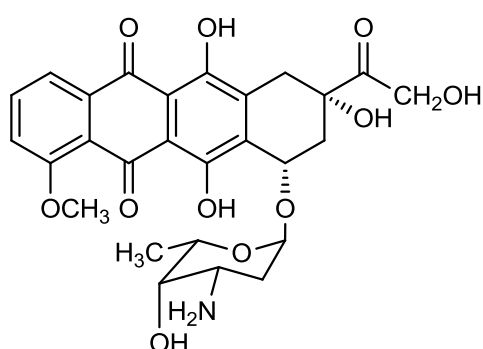


The peak numbers 2 and 3 which are for daunorubicin and epirubicin respectively, have identical chemical structures apart from the configuration of the OH group (figure 1.24) one

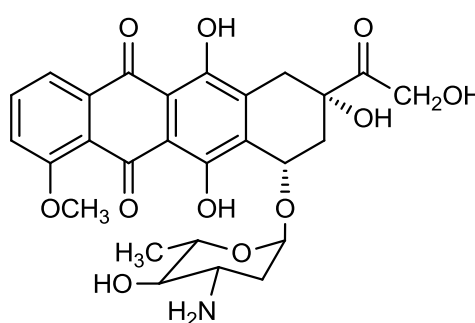
can make an internal hydrogen bond with an amine group whereas the other cannot, thus interacts more strongly with the stationary phase. In summary, the acetonitrile is the weakest solvent with regard to hydrogen donation and acceptance and thus provides better separation than methanol in HILIC mode, also acetonitrile gave a sharper peak shape.

**Figure 1-24 Chemical structures for A) daunorubicin and B) Epirubicin [44].**

A) Daunorubicin



B) Epirubicin



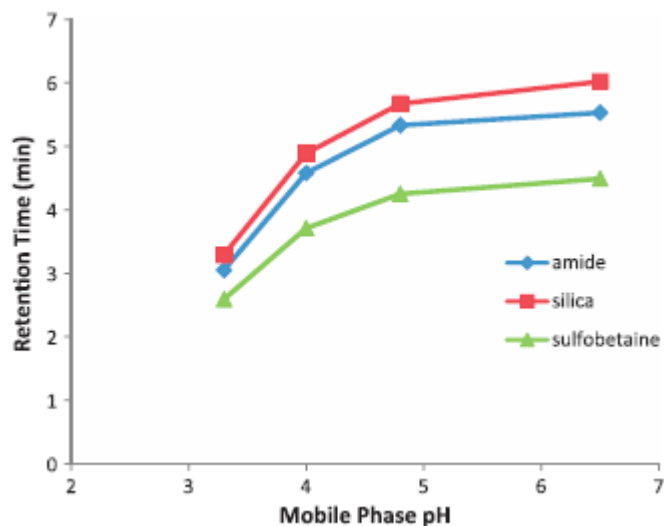
### 1.5.3. The effect of pH

The pH is a measure of the activity of the hydrogen ions and it can control the ionization state of an acidic or basic group. As a result of a variation in pH a significant electrostatic interaction can occur between a charged stationary phase and a charged solute and this can significantly affect the retention of analytes and thus the selectivity in HILIC. In general charged analytes are more polar than in their neutral forms therefore the ionized analytes are strongly retained in HILIC by partitioning mechanism. The second effect for the pH is ion exchange which is an interaction between a charged analyte and charged stationary phase which result in electrostatic attraction or electrostatic repulsion. Repulsion occurs when the negative charge of an acid interacts with negative charge of the stationary phase or the positive charge of a base interacts with the positive charge of a stationary phase. Repulsion

can result in loss of peak shape and early elution. The range for analytes to be in their ionised or unionised range is 2 pH units above or below of their pKa values. Basic compounds can be completely ionized at 2 pH units below their pKa values and in their completely unionised states at 2 pH units above their pKa values. The opposite is the case for acidic compounds. Therefore the separation can be controlled by pH, however, silica is not stable at pH values  $>8$  or  $< 2$  [1]. One solution to make the column able to withstand at higher pH is to use a polymer support for the stationary phase as is the case for the ZIC-pHILIC column.

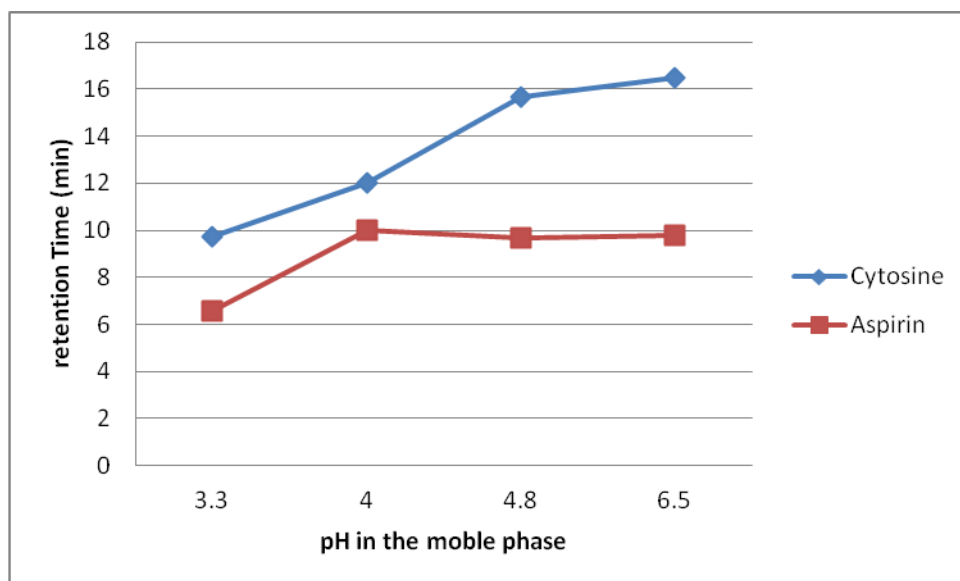
In case of negatively charged stationary phases, increased retention of acidic analytes occurs via increasing the pH because as the analytes become more ionised stronger hydrophilic interactions can occur. Increasing the pH of the bare silica, will promote the ionisation of the silanol groups which can produce on one side charge repulsion with negatively charged acids, however, on the other side this also can increase the hydration layer which form on the silica gel surface beside the acid is more polar in the ionization state. Thus it is difficult to predict the effect that increased pH would have on the retention of an acid on silica gel, however the general observation is that increasing the pH can increase the retention time of the acidic compounds (figure 1.25). For the basic compound cytidine retention is increased to 9.71 min on silica gel at pH 6.5 since the stationary phase and the analyte are oppositely charged and can have ionic interactions beside the partitioning mechanism. The retention time of cytidine reduces to 8.91 min at pH 3.3 when the Si-OH phase is no longer ionised [35].

**Figure 1-25** The effect of the different mobile phase pH for the aspirin on (◆) amide, (■) silica and (▲) sulfobetaine phases. The mobile phase was 10mM ammonium formate in water/ACN (10:90 v/v) [45].



In the case of a positively charged stationary phase, retention time increases significantly for acidic compounds, which can undergo both hydrophilic and ionic interactions with positively charged stationary phases such as the aminopropyl stationary phase. For example aspirin is retained more on an amine column at pH 6.5 where both the acidic analyte and the amino groups are ionised in comparison with pH 3.3 where the analyte is incompletely ionised [35]. Cytosine (a basic analyte) has a  $pK_a$  4.6 and when the pH is below its  $pK_a$  value it is largely ionized and repulsion from the similarly charged amino groups on the stationary phase and when the pH rises above its  $pK_a$  value it is able to undergo hydrophilic interaction with the stationary phase without charge repulsion [35] (figure1.26).

**Figure 1-26** The effects of mobile phase pH for the aspirin (◆) and cytosine (■). Stationary phase: amino propyl, mobile phase 10 mM ammonium formate water/ACN (10:90, v/v) [35].



The zwitterionic columns such as ZIC-HILIC have similar retention behaviour to silica gel since both have negative charge group, however the ZIC-HILIC has small effect of this charge comparing with the silica [46]. Neutral phases with a silica support such as amide and diol might carry a negative charge because of the remaining un-covered silanol groups on the surface of the silica. For example, there is a gradual increase in the retention time of the thiamine (a basic compound) with a diol phase as the pH of the mobile phase increases from 3 to 6. This is obviously because of the ionic interaction of thiamine with the remaining silanol groups [47].

#### 1.5.4. Effect of the Buffer type and concentration on retention in HILIC

A buffer can be defined as a solution that can prevent large changes in pH when acidic or basic material is added to it. A simple buffer consists of a solution of a weak acid or weak base and combined with strong base or acid. The absence of buffer salts from the mobile phase can lead to longer retention times and broader peaks [48]. Buffers are used in a number areas of analytical chemistry including the preparation of the mobile phase for chromatography and the extraction of drugs from aqueous solution. Sometimes a salt of a weak acid with weak base is used in a chromatographic mobile phase for example ammonium acetate or ammonium formate, to optimise the pH at a defined level, especially in HILIC as it has higher amount of organic solvent such as acetonitrile. A buffer is very effective when the molarity of the buffer is higher than the molarity of the acid or base it is buffering against. Table 1.1 shows some common weak electrolytes used as buffers.

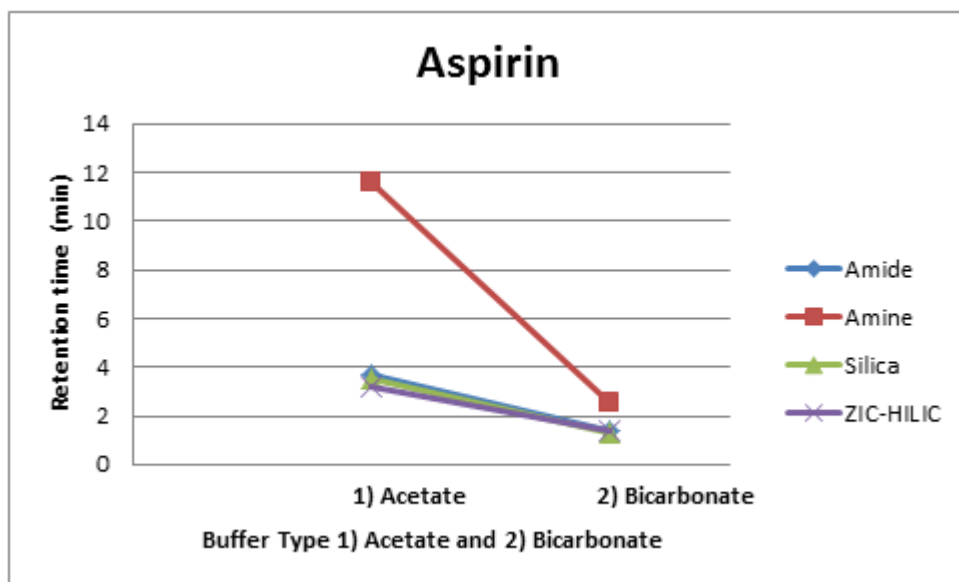
**Table 1.1 Common mobile phase buffer additives: type, pKa and the active pH range.**

Buffering agent	pKa value	pH range
Buffer of Phosphate	12.3	11.3 – 13.3
Buffer of Ammonia	9.2	8.2 – 10.2
Buffer of Phosphate	7.2	6.2 – 8.2
Buffer of Sulfonate	6.9	5.9 – 7.9
Buffer of Acetate	4.8	3.8 – 5.8
Buffer of Formate	3.8	2.8 – 4.8
Buffer of Chloracetate	2.9	1.9 - 3.9
Buffer of Phosphate	2.1	1.1 - 3.1
Buffer of Sulfonate	1.8	<1-2.8
Buffer of Trifluoroacetic acid	0.5	<1.5

The buffer used can have an effect on the separation of the analytes in different ways such as the buffer type and buffer concentration. Different buffers have different effects on the retention of the analytes as they have different pKa value and can effect on the pH of the mobile phase. For example in the case of the acidic compound (aspirin) and basic compound (cytosine) on amide, amino, silica and sulfobetaine HILIC stationary phases [35], cytidine did not show a significant differences in elution time on the four different stationary phases when the buffer was changed from ammonium acetate to ammonium bicarbonate as the cytosine did not ionize (pKa 4.5) at the pH of these buffer.

However when the aspirin was run on the amide, silica, and zwitterionic stationary phases there was an decrease in the retention time as the buffer in the mobile phase changed from ammonium acetate pH 6.9 to bicarbonate pH 7.9, this because both the aspirin and these stationary phases are negatively charged which causes repulsion of the aspirin. Moreover, the ammonium acetate shows stronger ionic interaction between aspirin and the positively charged amino column (figure 1.27). This was due to the fact that ammonium acetate has lower pH than bicarbonate where the stationary phase and the analyte are ionized, however when the bicarbonate is used the amine stationary phase is no longer charged and the retention mechanism is only by partition.

Figure 1-27 The effect of different buffer types with 10mM 1) ammonium acetate or 2) 10 mM ammonium formate with ACN (15:85, v/v) on the retention times of salicylic acid and cytosine. The stationary phases were (♦) amide, (■) amine, (▲) silica and (×) ZIC-HILIC. The pH of the acetate is 6.9 and the pH of the Bicarbonate is 7.9 and the pKa for the aspirin is 3.5 and for the cytosine is 4.6 [35].

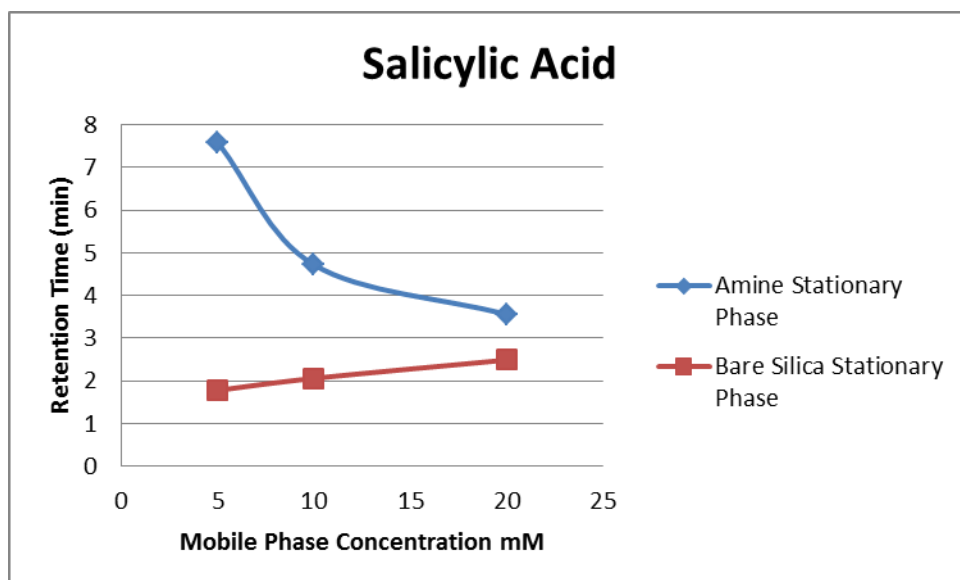


The buffer concentration in the mobile phase can affect the electrostatic interactions in different ways (repulsion and attraction). In the case of electrostatic repulsion of the same ionisable group, the increase of the buffer salt amount can lead to increase retention of the chargeable analyte with the stationary phase because it can block the charge site on the stationary phase which is causing repulsion of the analyte. In case of electrostatic attraction an increase in the concentration of buffer salt leads to reduce the retention of ionised analytes which hold a charge opposite to the stationary phase because the buffer concentration undergoes competitive ion-exchange with the analyte on the ionized side of the stationary phase and this reduces the interaction of the analyte with the stationary phase. For example Guo *et al* [35] investigated the retention time of salicylic acid on bare silica, aminopropyl, amide and sulfobetaine stationary phases with different concentrations



of ammonium acetate buffer. There was remarkable decrease in the retention time of salicylic acid by the aminopropyl column when the salt concentration was increased from 5-20mM (figure 1.28) and this can be attributed to the increase in negatively charged acetate in the mobile phase competing with salicylic acid to form ion pair with the positively charged amine groups on the surface of the silica gel. However, the small increase in the retention of salicylic acid on the bare silica, (figure 1.28) was because of a reduction of the ionic repulsion between the acid and negative ionic on the surface of the stationary phase which is blocked by an increase in the concentration of acetate ions in the mobile phase.

**Figure 1-28** The effect of different concentrations of the ammonium acetate buffer pH 6.9 mixed with ACN (15:85, v/v) on the retention of salicylic acid. The stationary phases are (■) bare silica and (◆) amine.



The increase of the salt concentration might also effect HILIC separation in another way where increasing the amount of the buffer can increase the volume of the water rich layer on the stationary phase [35]. Guo *et al* [35] studied the effect of different ammonium acetate concentrations on cytosine with the bare silica, aminopropyl, amide and zwitterion

phases. He found a small increase in retention time on all the stationary phases if the buffer amount was between 5 – 20mM for cytosine which was uncharged at the pH value used thus indicating that increasing the salt concentration was promoting hydrophilic interaction.

## **1.6 Applications of HILIC in Pharmaceutical and Food Analysis**

HILIC columns show excellent performance for the separation of hydrophilic and polar compounds even in complex mixtures and HILIC has been used for different types of applications such as pharmaceuticals, food and drink, biological and environmental. Some examples of applications are discussed below.

### ***1.6.1 Analysis of Formulations***

A HILIC method was developed on bare silica gel for the analysis of dextromethorphan, pseudoephedrine and diphenhydramine in a cough formulation. The mobile phase was a mixture of methanol and a buffer consisting of ammonium and triethylamine. All three components were separated and the method was validated for quantitative determination [49].

### ***1.6.2. Analysis of Drug Impurities***

Drug impurities can be defined as trace amounts of compounds that can be produced from a degradation of the main API or manufacturing impurities. The HILIC technique performs well for the detection and separation impurities. Al-Tannak separated oxprenolol and its impurities on a cyanopropyl column used in HILIC mode and the identities of the impurities which were confirmed by using mass spectrophotometry [34]. Six impurities in mildronate were separated using a variety of HILIC columns. Principally a ZIC-HILIC column and a bare silica gel column were compared. The effect of acetonitrile and buffer contents in the mobile phase on retention times phase were investigated. Overall the ZIC-HILIC column was

deemed most fit for purpose. The method was fully validated for quantitative determination of the impurities [50]. A stability indicating method was developed for the analysis of brimonidine tartrate and its degradants. A bare silica gel column was used with an isocratic mobile phase consisting of acetonitrile/0.5 ammonium acetate (92:8 v/v) adjusted to pH 7.0 with acetic acid. Increasing the % of acetonitrile caused an increase in retention of brimonidine and increasing the ionic strength of the mobile phase or its pH caused a decrease in its retention time [51]. Impurities in streptomycin and dihydrostreptomycin were investigated by using LC-MS in conjunction with a bare silica column in HILIC mode with acetonitrile/ammonium formate buffer (75:25). Using a fused core silica column with 2.7  $\mu\text{m}$  particle size sharp peaks were obtained and 18 impurities could be characterised in the samples [52]. A number of different HILIC columns were tested for their ability to separate 4-aminomethylpyridine and its related substances. Mobile phase pH, buffer salts and organic modifier were all investigated for their effect on retention times and silica gel columns from several manufacturers were compared [53]. Li *et al* [48] showed that HILIC could be used to develop a validated method by using a bare silica stationary phase for the analysis of atenolol.

### ***1.6.3 Bioanalysis and Drug Metabolism***

Grumbach *et al* [54] found that HILIC provided a very good method for separating many polar compounds including choline and acetylcholine by using bare silica as a HILIC phase. HILIC has also been applied to a pharmacokinetic studies. For example Hsieh and Chen [55] separated and detected nicotinic acid compounds from their metabolites. The method development was carried out by using a bare silica HILIC column interfaced with a mass spectrophotometer.

Many antibiotics are polar which makes them difficult to separate by using reversed phase chromatography. Oertel *et al* [56] developed a method for the separation and analysis of neomycin in human plasma using mass spectrometry as the detection method. Neomycin is a very polar compound with at least six amino groups in its structure and a HILIC method was developed for its analysis based on a ZIC-HILIC column.

A rapid LC-MS assay with a nine minute run time was developed for cocaine and its metabolites in hair [57]. The stationary phase was bare silica gel and the eluent was aqueous ammonium acetate buffer pH4.5 and acetonitrile which was varied between 82% and 40% in a gradient elution. The method was fully validated and LOQs of 0.001 ng/mg were obtained for cocaine and its metabolites. The method was able to produce strong retention of the metabolite ecogonine methyl ester which is only weakly retained on reverse phase columns.

Drugs of abuse can be analysed by using HILIC separation. For example a method for the detection and separation of cocaine and many of its metabolites in human tissue was achieved. The method was included a liquid-liquid extraction step and then separation was carried out with an un-modified silica gel column with a 2mM aqueous ammonium acetate (A) a 2mM ammonium acetate in acetonitrile (B) with a gradient run from 80% B to 56% B [58].

HILIC column interfaced with a mass spectrometer is very useful in this type of study because most metabolism produces polar compounds. Khreit *et. al.* [59] used a ZIC-HILIC column in order to investigate the phase I and phase 2 metabolism of methylmethcathinone hydrochloride in rat hepatocytes, the method was able to find 17 metabolites.

#### ***1.6.4 Miscellaneous Applications of HILIC***

HILIC is potentially useful for pharmaceutical development and drug discovery. For example Koh *et al* [60] developed a method for the separation of polar compounds such as dencichine, which is a hemostatic agent, from a traditional Chinese medicine. They also developed a HILIC method for determination of a neurotoxic agent from *Lathyrus sativus* seed, known as grass pea. The methods were carried out by using un-modified silica in HILIC mode with mass spectrophotometry detection, the methods were fully validated.

HILIC can be used for the separation the polar compounds in food and drink. For example in parmesan cheese, Schlichtherle-Cerny *et al* [61] showed unique substances including glutamic acid, arginine and many polar dipeptides by separation on an aminopropyl stationary phase under HILIC conditions and with detection by mass spectrometry. A carbohydrate rich drink was analysed by using HILIC for the separation and detection of methionine and taurine. The method was very simple without the need for an extraction method other than a dilution process. The method showed very good precision, accuracy, linearity and low limit of detection [22].

Many toxins are very polar and produced within living cells in environment. Dell'Aversano *et al* [62] used the HILIC conditions to separate and detect many of the cyanobacterial toxins including saxitoxin, cylindrospermopsin and anatoxin-a in algal samples with detection by mass spectrometry. The method showed a good degree of robustness and the analyses were quite simple where clean up or pre-concentration steps were not required.

The carbohydrates are also known as saccharides and are divided into four chemical groupings: mono-, di-, oligosaccharides, and polysaccharides existing in a range from low to high molecular weight. They are rich in hydroxyl groups and other polar functional groups

and these properties give an advantage to using HILIC as a separation technique. The analyses of carbohydrates were among the first applications on HILIC. For example the analysis of oligosaccharides derived from glycoproteins were carried on the amide silica column [63].

Amino acids are molecules consisting of an amine group, a carboxylic acid group, and an alkyl-chain that varies across the 20 common amino acids. Peptides are short poly amino acids linked by peptide bonds. The polarity of these compounds is high and the separation in HILIC mode is very effective. The separation of peptides was the second application of HILIC after the carbohydrate analysis. For example the a poly(2-hydroxyethyl aspartamide) based silica as stationary phase was used to separate the phosphorylated peptides from Y-32P-ATP and inorganic  $^{32}\text{P}$  which were initially isolated by using solid phase extraction (SPE) for the sample preparation and then HILIC as a separation mode [64].

Proteins contain one or more polypeptides and HILIC can be used to analyse both proteins and protein digests. Histones are polar basic proteins. Acetylated core and also phosphorylated H1 histones were analysed and separated by using a mixed mode stationary phase including weak cation-exchange and HILIC mode which was developed by Linder *et al* [65].

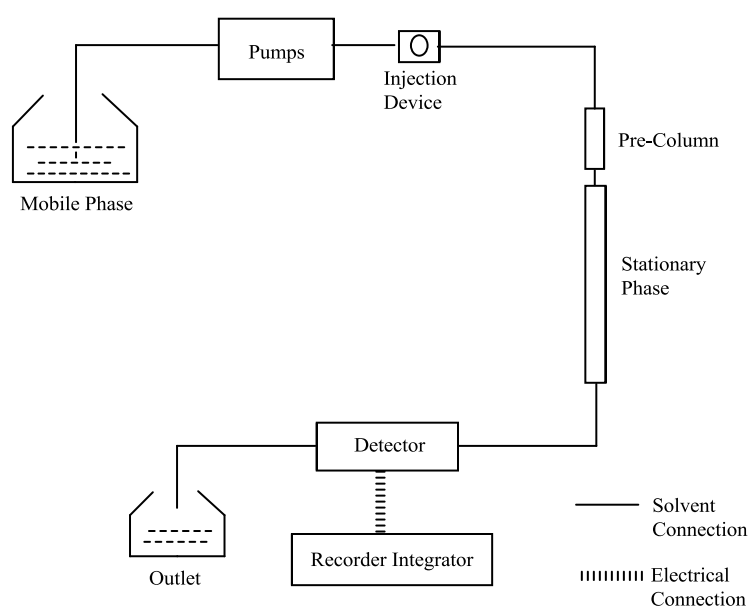
Metabolomics is used to describe the many sciences that come together for measurement and analysis of metabolites. HILIC coupled with mass spectrometry is usually a good option where a complex range of polar metabolites have to be separated. Albarraty *et al.* [66] showed an example of metabolomics with HILIC conditions using ZIC-HILIC column to test the effects of the xanthine oxidase inhibitor allopurinol on *Drosophila melanogaster*. Allopurinol treatment showed an increase in the levels of xanthine and hypoxanthine and a decrease in the levels of uric acid and allantoin.

## 1.7 Instruments.

### 1.7.1 High Performance Liquid Chromatography Instruments (HPLC):

A HPLC consists of five parts which are mobile phase, pump, injection device, stationary phase and detector (figure 1.29). The purpose of the HPLC is to pass the injected sample through the column which is carried by the mobile phase and which is moved by the pump. There are three types of elution technique, isocratic, gradient and stepwise. The interaction between the compounds and the stationary phase is different depending on the characteristic of the analytes and the properties of the stationary and the mobile phase. After eluting an analyte from the stationary phase, it can be detected by an appropriate measurement instrument. The Analytes chemical properties can determine the most suitable detector to be used which includes the ultraviolet (UV) detector, fluorescence detector, refractive index detector, evaporative light scattering detector and mass spectrometry (MS) detector.

**Figure 1-29 Schematic diagram of a HPLC system**



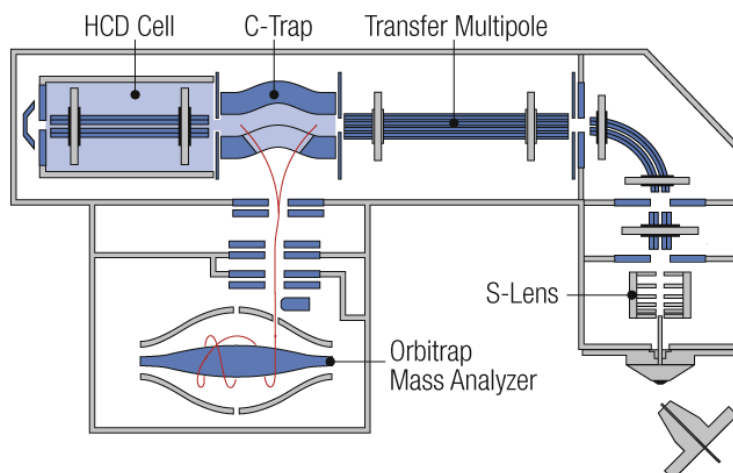
Generally for compounds that have a chromophore a UV detector is used because it is economical and easy to use. For the compounds that are not suitable for detection by the UV, refractive index or evaporative light detection can be applied. For compounds that have a fluorophore, a fluorescence detector can be employed. The most powerful detector is a mass spectrometer which offers the highest sensitivity and selectivity, it can be used almost for all the compounds and provide additional information such as molecular formula for analytes [1].

### ***1.7.2. Liquid chromatography- Mass spectrometry (LC-MS):***

The main components of the mass spectrometer are ionisation source, ion separation device and detection device. The purpose of the LC-MS is to ionize the compounds so that they can be controlled their movement in the LC-MS system and detected in their ionised form. First analytes pass into the ionisation source which is responsible to produce either positive or negative ions from the analytes. After ionization, the ionised analytes are transferred to the analyser which is held under high vacuum and which controls the movement of the ionized compounds. In the analyser, the separation process occurs based on the molecular weight to charge ratio of the ionized compounds and it is known as  $(m/z)$  which is the ratio of mass ( $m$ ) to charge ( $z$ ). Finally the identification of the separated ions is carried out and the signals transferred to an output (Figure 1.30).



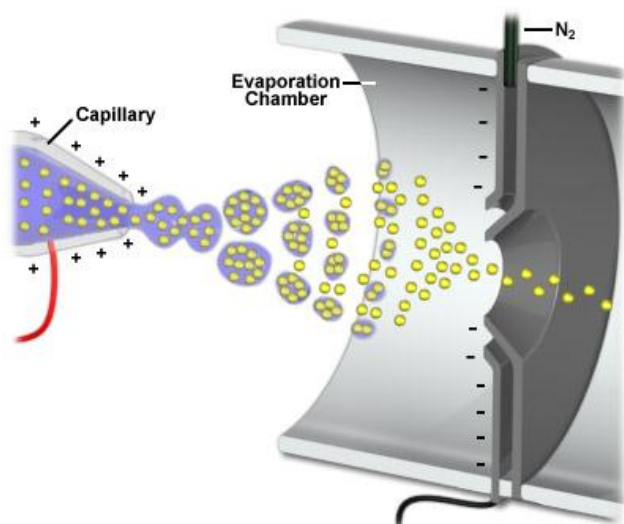
**Figure 1-30 A Thermo Scientific Exactive mass spectrometer [67].**



There are several different factors which can influence the ionization process in the MS, for example the analyte type, the buffer in the mobile phase and the type of the ion source mechanism. Some examples of the ion source are chemical ionisation, electron ionization and electrospray ionisation (ESI). The ionisation mode which is applied for the majority of biochemical compounds is ESI [68].

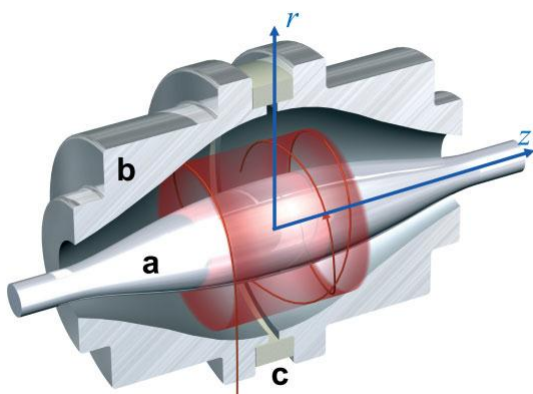
Electrospray ionization (ESI) is known as a soft ionization method. The sample is sprayed into the source via a fine capillary needle, which is held at a very high voltage to charge the compounds in the solvent. Firstly a Taylor cone is formed when the charged spray exits the tip of the needle and ions of the opposite charge are pulled toward the capillary leaving the ions of the same charge within the spray. Secondly, a Coulombic repulsion force occurs because of the high concentration of ions of the same charge within the droplets that make up by the spray can break up further. Nitrogen gas flow and the heat help this process to evaporate the solvent till a single charged molecule is obtained (Figure 1.31).

**Figure 1-31 Electrospray ionization process [69].**



There are different types of the mass analysers available, such as quadrupoles, time-of-flight analysers and Orbitraps. The last one has an advantage of high mass resolution [68]. The Orbitrap, is an ion trap, which can trap ions in an electrostatic region. The electrostatic attraction occurs to a central electrode because the centrifugal force that is produced from the velocity of ions balances the attraction to the central electrode. The electrostatic field that is applied to the ions in the Orbitrap obliges them to travel in complex spiral forms (Figure 1.32). The high resolution of the Orbitrap instrument uses the principle that an current image derived from the axial movement of the ion packets orbiting the electrode can be converted, using the Fourier transform, to mass information [70].

**Figure 1-32 Orbitrap instrument [70].**



HILIC coupling with a mass spectrophotometer has gained notice due to ability to separate polar molecules in biological mixtures [71]. In reversed phase separations polar compounds have very limited interactions with the stationary phase for separating the analytes from the matrix and from each other. Ion-pair chromatography improves this but leads to ion suppression which decreases the efficiency of the ESI droplet fragmentation through reducing charge separation in the ESI spray needle [72]. An advantage of the HILIC technique for coupling to mass spectrometry are that highly organic mobile phases are more volatile which increases ESI-MS sensitivity through improving the efficiency of the formation of gas phase ions [73]. Generally complex sample preparation for biological samples is carried out prior to LC-MS analysis by using liquid-liquid extraction (LLE), protein precipitation (PP) or solid phase extraction (SPE) to reduce the interfering compounds. In reversed phase the extraction solvent used in this process usually needs to be evaporated and the sample re-dissolved with a suitable solvent prior to injection into the LC-MS. HILIC can eliminate the need for the evaporation and reconstitution steps since samples

containing high amounts of organic solvent are directly compatible with HILIC and there is no loss of peak shape [74].

## 1.8 Aims and Objectives

The aims of the study described in this thesis were as follows:

- 1) To evaluate some of the factors that can affect the separation of the polar compounds on a cyano propyl (CN) column when the HILIC mechanism is used.
- 2) To apply HILIC separation on a CN column interfaced to a mass spectrometer to the characterisation of impurities in commercial samples of drugs.
- 3) To further characterise the interactions occurring on a CN column using model bases.
- 4) To compare the chromatographic properties of silica gel and silicon hydride modified silica gels using test compounds.
- 5) To compare the chromatographic properties of seven different HILIC columns for the chromatography of metabolites monitored in metabolomic screening
- 6) To prepare and test a new stationary phase where is  $\beta$ -pinene is linked to the silicon hydride modified silica gel.
- 7) To develop a method for the extraction of nicotine and its metabolites from dog hair and determine nicotine exposure in dogs subjected to passive smoking using hydrophilic interaction chromatography in combination with Fourier transform mass spectrometry

## **Chapter 2**

**|The hydrophilic interaction like properties of some reversed phase high performance liquid chromatography columns in the analysis of basic compounds**

## 2.1. Introduction:

The importance of analysis of basic compounds by HPLC is significantly high because 75% of pharmaceutical compounds are basic [75]. Pharmaceutical compounds include raw material and intermediates used for the synthesis the drug substance. In addition, polar reagents, raw materials, intermediates and reaction by-products may also be present as impurities in a drug substance or synthesis intermediate. HPLC with reversed phase chromatography is widely used for the separation of pharmaceutical compounds because it is sensitivity and selectivity. However, for the separation of the basic and the polar compounds with the reverse phase liquid chromatography, the mobile phase should be with no or little amount of organic. This make the reversed phase stationary phases suffer from the higher amount of the aqueous mobile phase since it causes the stationary phase to collapse and as a result give poor retention and poor reproducibility for the separation [9]. The addition of a polar embedded group was a solution which was effected by introducing polar group between the silica support and the C18 phase [76]. However, highly polar compounds are still not retained by polar embedded columns. Ion-pair chromatography is anther common way to retain the charged polar compounds [77], but not all polar compounds are charged and ion pair mobile phases are not compatible with mass spectrometry.

Recently an alternative method for the separation of the polar compounds within a polar stationary phase is by hydrophilic interaction liquid chromatography. This model is similar to the normal phase liquid chromatography in retaining the polar and the basic anaytes more than the non-polar compounds, moreover the mobile phase is similar to that in reversed phase chromatography however the strongest eluent is water. This technique was suggested by Alpert [78] and describe as hydrophilic interaction liquid chromatography (HILIC) where the mechanism of the separation is by partitioning.

One phase which has potential for use in HILIC mode is the cyanopropyl (CN) stationary phase. The CN stationary phase is a monomeric phase and is attached to the silica surface via an alkyl linker group. The CN stationary phase is known as neutral stationary phase and it is a less hydrophilic stationary phase than for instance a diol phase [45]. This is because the cyano ligand is a hydrogen bond acceptor rather than a hydrogen bond donor and any hydrogen bond donating produced on this stationary phase is due to the non-encapped residual silanol groups [14]. The bare silica stationary phases have stronger hydrogen-bond interactions than CN stationary phases. In contrast, dispersive interactions are slightly higher on the CN stationary phases than on unmodified silica gel stationary phases [14]. The CN stationary phase has greater dipole-dipole interactions in comparison with the amino stationary phase [79]. Marchanda *et al* [80] compared a CN stationary phase with a non-polar stationary phase, and found that the CN stationary phase was much less hydrophobic and had weaker hydrogen-bonding [81]. These properties mean that the CN stationary phase has a few applications in the normal phase mode for the separation of the polar analytes [82, 83], mainly through the dipole-dipole interaction and the hydrogen bond acceptor interactions, because it has low polarity. However, in the reversed phase mode very few applications for the CN stationary phase are available because the polarity of the CN phase cannot be used to achieve separations on the basis of lipophilic interactions between solutes and the stationary phase [21, 80, 84]. In general, the CN stationary phase is less commonly used because of concerns about its stability [85] and also its reproducibility [86]. The reason for using the CN stationary phase is that it offers different selectivity [87] and also different brands of CN stationary phases have varying selectivity [80, 84]. The properties of the CN stationary phase offer the chance to apply the HILIC model for the separation of the polar and basic compounds as it can form a water rich layer on the surface

of the cyano stationary phase. Various applications have used CN phases for the separation of polar and basic compounds.

Garbis *et al* [88] showed the inability for the CN column to separate the folates under normal phase conditions or the reversed phase mode, however when the HILIC mode was applied, separation of the folates was achieved in less than 30 min. Daunoravicius *et al* [89] tested the separation of denaturants in alcohol by using bare silica, aminopropyl and cyanoethyl stationary phases. The study showed the best separation was achieved with the cyano stationary phases under HILIC conditions. The separation of the denaturants was achieved by using mobile phase containing 60% (v/v) acetonitrile and 10 mM perchloric acid. The separation was improved by using tetraethylamine (TEA) to mask the residual silanol groups. One of the most interesting applications of the CN stationary phase under HILIC conditions is the separation of piperazine in pharmaceutical drug substances which was developed by using HPLC with evaporative light scattering detection (ELSD). The mobile phase composition used was 0.1% trifluoroacetic acid:acetonitrile (5:95 v/v). The method was within acceptable limits of linearity, precision, LOD, and selectivity [90].

In the current study a CN phase was evaluated with regard to its ability to retain basic drugs.

## **2.2. Materials and methods**

### **2.2.1. Chemicals**

Ammonium acetate, sodium acetate, tetraethylammonium acid, Bis-tris and Tris free base, HPLC grade acetic acid, HPLC grade methanol and HPLC grade acetonitrile are obtained from Fisher Scientific, Loughborough, UK. HPLC water was prepared in house using a Milli Q purification system. The basic compounds used in the running tests were from Sigma



Aldrich, Dorset, UK, were European Pharmacopoeial standards or were part of an in house stock donated by companies over the years.

### ***2.2.2. Mobile phase preparation***

Ammonium acetate, sodium acetate, tetraethylammonium acetate, Tris-Tris and Bis-Tris mobile phases were prepared by dissolving the required amount of base in water at ten times the final molarity required and then mixing with acetonitrile. pH adjustment was carried out with acetic acid prior to mixing and then 25 ml of buffer and was mixed with 475 ml of acetonitrile. If a higher proportion of aqueous phase was required water was added as well as the buffer solution e.g. 10:90 water:ACN would require 5:5:90 of buffer:water:ACN.

### ***2.2.3. HPLC columns***

ACE CN columns (150 mm × 3 mm i.d. × 3 µM particle size) were obtained from HiChrom Ltd., Reading, UK. The CN column was endcapped.

### ***2.2.4. HPLC instrumentation***

HPLC analysis was carried out on a ThermoFinnigan HPLC system consisting of a P4000 pump, UV 6000 PDA detector and an AS3000 autosampler. The mobile phase compositions were mixed off-line in the proportions required and the HPLC system was used in isocratic mode, 10 µl of sample was injected. The flow rate was 0.8 ml/min and the column was run at room temperature. The UV detector was set to monitor at 220 and 280 nm. The void volume of the columns was determined according to the minor disturbance peak produced by injecting 10 µl of pure methanol.

### **2.2.5 LC-MS**

The ESI interface was operated in a positive/negative polarity switching mode. The spray voltage was 4.5 kV for positive mode and 4.0 kV for negative mode. The temperature of the ion transfer capillary was 275°C and sheath and auxiliary gas was 50 and 17 arbitrary units respectively. The full scan range was 75 to 1200 m/z for both positive and negative modes with settings of Automatic Gain Control (AGC) target and resolution as Balanced and High ( $1e^6$  and 50,000) respectively. The data were recorded using Xcalibur 2.1.0 software package (Thermo Fisher Scientific). Mass calibration was performed for both ESI polarities before the analysis using the standard Thermo Calmix solution with addition of some additional compounds to cover the low mass range and the signals of 83.0604 m/z (2 x ACN+H) and 91.0037 m/z (2 x formate-H) were selected as lock masses for positive and negative mode respectively during each analytical run.

### **2.2.6 Sample preparation**

Samples were prepared as stock solutions of 1 mg/ml in methanol and diluted to a concentration of 0.1 mg/ml in mobile phase.

## **2.3. Results:**

### **2.3.1 Factors governing the retention properties of a test mix of basic compounds under HILIC-like conditions**

Figure 2.1A shows a chromatogram of a test mixture containing five basic compounds: propranolol, chlorpromazine, salbutamol, nortriptyline and benzalkonium chloride (figure 2.2) run on an ACE CN column using 3.25mM ammonium acetate in the mobile phase without pH adjustment. The peak shapes obtained for the basic compounds were excellent with theoretical plates being > 60,000 plates/m. There is immediately no clear mechanism for the retention of the compounds except that the completely ionised quaternary

ammonium compound is most strongly retained. The three secondary amines propranolol, salbutamol and nortriptyline, which have similar  $pK_a$  values, are retained to a differing extent. Figure 2.1B shows the effect when the concentration of the ammonium acetate in the mobile phase is increased to 6.5mM, which results in the retention of the basic compounds being reduced by nearly 50%. This supports a proposal that much of the retention mechanism for the bases is due to ion exchange with increased ionic strength reducing the interaction of the basic compounds with the stationary phase. Although the phase is endcapped, as is the case with all endcapped phases, many free silanol groups remain within the phase. Figure 2.1C shows the effect of decreasing the water content of the mobile phase from 5% to 3% which produces a marked increase in retention times. The effect of changing the aqueous content of the mobile phase is complex since there are several interacting effects. Log  $k$  plots for the basic compounds in the test mixture, were non-linear. This reflects the observations of previous workers where the ion-exchange properties of four different HILIC columns were investigated using neutral, acidic and basic test probes [35]. It was found that log  $k$  plots against % organic were non-linear thus pointing to complex retention mechanisms in contrast to the linear log  $k$  plots which would be obtained for straightforward reversed partition chromatography where the single retention mechanism of hydrophobic interaction predominates [91]. In the current example there are three sets of  $pK_a$  values to consider: the  $pK_a$  values of the basic compounds in the test mixture, the  $pK_a$  value of the ammonium ion and the  $pK_a$  value of the silanol groups in the stationary phase. All of these values change with the % of organic modifier used in the mobile phase and thus affect retention and contribute to a complex retention mechanism.

**Figure 2-1 (A) Separation of test mixture of basic compounds (propranolol, chlorpromazine, salbutamol, nortriptyline, benzalkonium chloride) on an ACE CN column (150mm×3mm) in acetonitrile/water (95:5) containing 3.25mM ammonium acetate, flow rate 0.8 ml/min. (B) Separation of test mixture of basic compounds on an ACE CN column (150mm×3mm) in acetonitrile/water (95:5) containing 6.5mM ammonium acetate, flow rate 0.8 ml/min. (C) Separation of test mixture of basic compounds on an ACE CN column (150mm×3mm) in acetonitrile/water (97:3) containing 3.25mM ammonium acetate, flow rate 0.8 ml/min.**

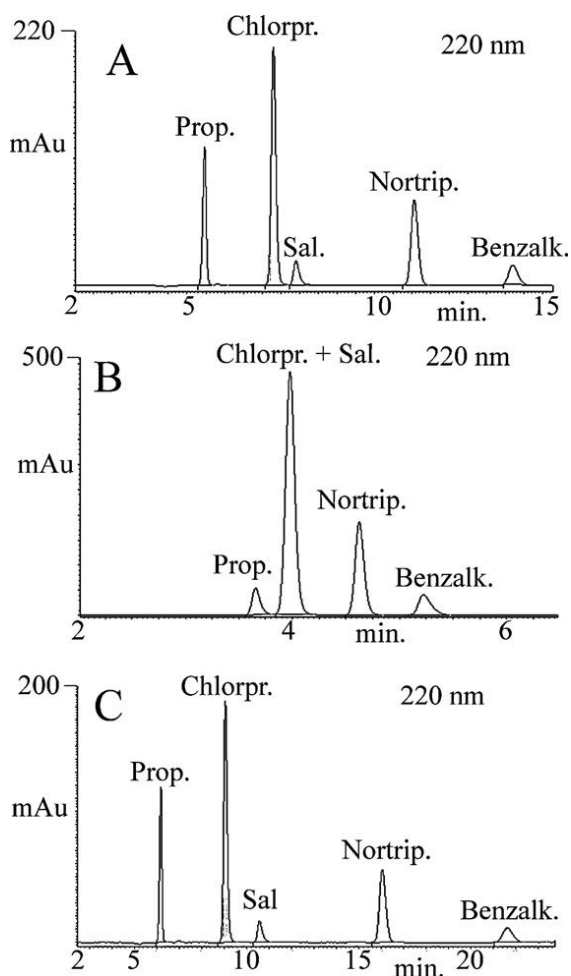
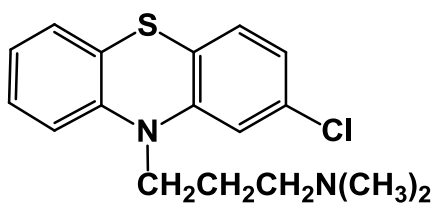
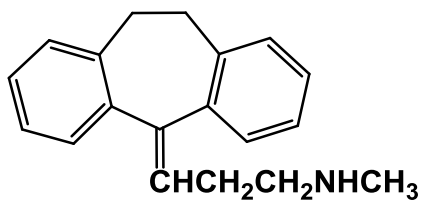


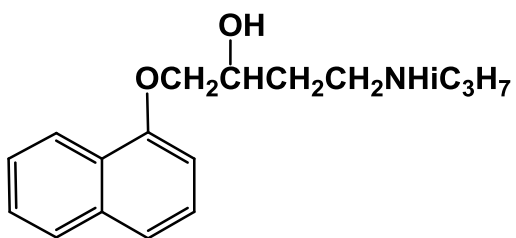
Figure 2-2 Structures of the basic compounds included in the test mixture.



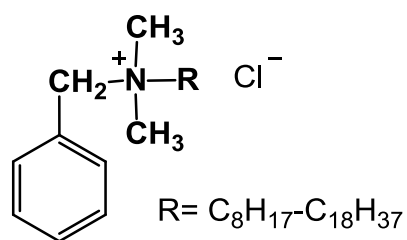
chlopromazine pKa 9.0



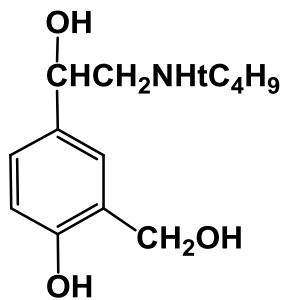
nortriptyline pKa 10.3



propranolol pKa 9.5



benzalkonium chloride



salbutamol pKa 9.5

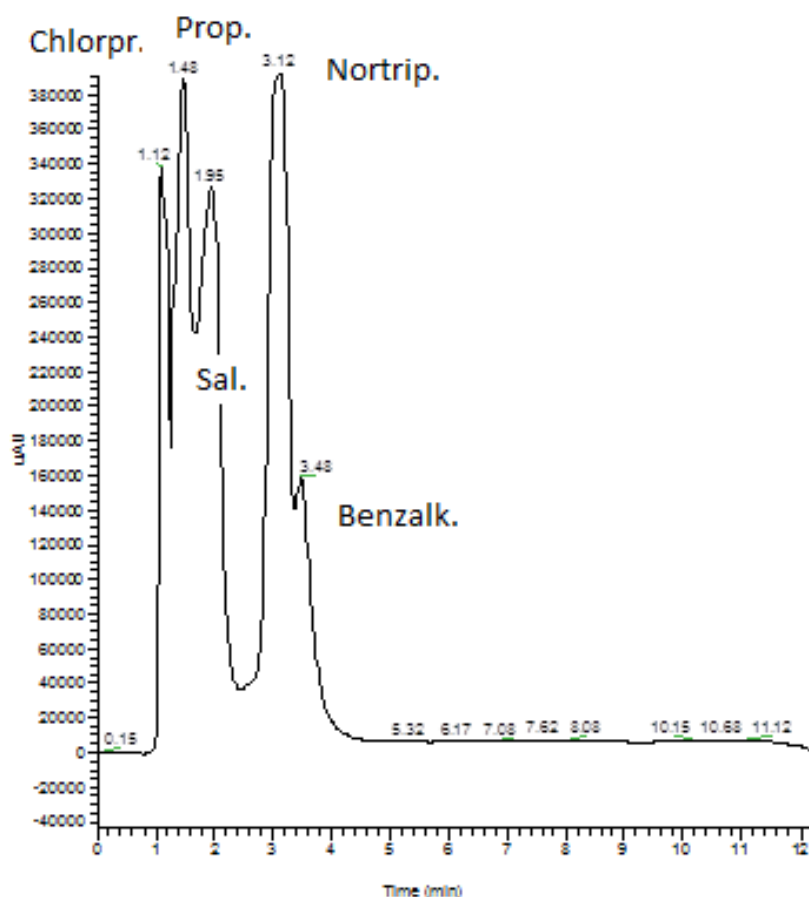
### 2.3.2 *The effect of the counter ion in the mobile phase on retention time.*

In order to test the hypothesis that retention of bases on the CN column was due to ion exchange interactions the counter ion in the mobile phase was varied. Using sodium acetate at pH 6 and 3.25 mM in the mobile phase, almost abolished the capacity of the CN column to retain the basic test compounds (table 2.1 and figure 2.3).  $\text{Na}^+$  is completely charged at all pH values unlike ammonium which in a high organic solvent environment is unlikely to be fully charged at pH6 since the presence of organic solvent suppresses ionisation. Thus the sodium competes very effectively with the basic test probes for the silanol groups and the only compound displaying appreciable retention is benzalkonium chloride which is also completely charged at all pH values. However, the benzalkonium has a much shorter retention time than when ammonium is used as the counter ion and this is because  $\text{Na}^+$  competes effectively with it since, being a smaller ion, it has a higher charge density than benzalkonium and thus interacts more strongly with the negatively charged silanol groups effectively displacing the benzalkonium.

**Table 2.1 The effect of two different counter ions on the retention time of 5 bases with an ACE CN column and mobile phase (5% buffer water: 95% acetonitrile) pH 6, flow rate 0.8 ml/min.**

	Rt (min) in 3.25 mM Ammonium acetate	Rt (min) in 3.25 mM Na acetate
Benzalkonium	20.0	3.48
Chlorpromazine	6.3	1.12
Nortriptyline	15.0	3.12
Propranolol	8.3	1.48
Salbutamol	10.1	1.95

Figure 2-3 Chromatogram obtained for the test mixture of bases with 3.25 mM sodium acetate in acetonitrile/water (95:5), flow rate 0.8 m/min. Retention times of basic compounds at pH 6 on an ACE CN column (150 x 3 mm, 3  $\mu$ m particle size).



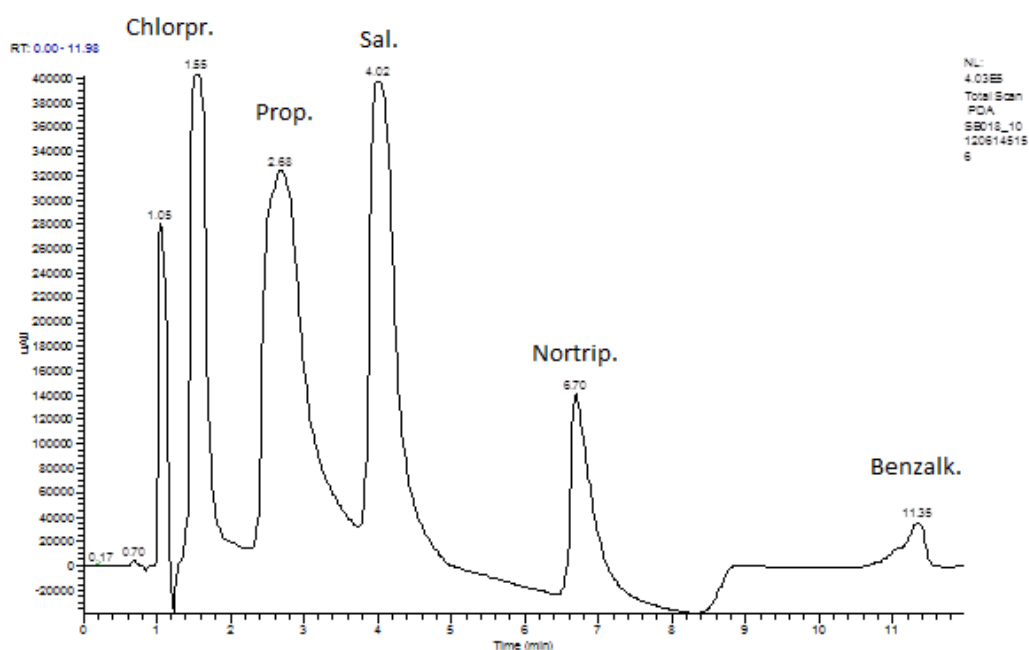
In Table 2.2 the effect of using the triethylammonium (TEA) ion at 3.25 mM and adjusted to pH 6 as a counter ion in the mobile phase can be seen. TEA like sodium is charged at all pH values and it might be expected to compete very effectively with the test bases for the silanol groups in the stationary phase. The results obtained with the triethylammonium ion showed a reduced the retention time of the bases in comparison with the ammonium ion, however, it did not abolish retention of the bases. This might have been expected because the TEA ion is a large ion and has a lower charge density than most of the test bases apart from benzalkonium. The peak shapes produced when TEA was used as counter ion were not very good (Figure 2.4) and this may be due to mass transfer effects where “off on” rates for

the counter ion varied depending on how accessible the silanol groups were. Thus TEA readily displaced the test compounds from less hindered silanol groups but not from more hindered silanols.

**Table 2.2 Retention times of basic compounds at pH 6 on an ACE CN column (150 x 3 mm, 3  $\mu$ m particle size) containing 3.25 mM tetraethylamine acetate in acetonitrile/water (95:5), flow rate 0.8 ml/min.**

Base	Rt (min)
Benzalkonium	11.35
Chlorpromazine	1.55
Nortriptyline	6.70
Propranolol	2.68
Salbutamol	4.02

**Figure 2-4 Chromatogram for the basic test compounds at pH 6 on the ACE CN column (150 x 3 mm x 3  $\mu$ m particle size) in 3.25 mM tetraethylamine acetate in acetonitrile/water (95:5), flow rate 0.8 ml/min.**



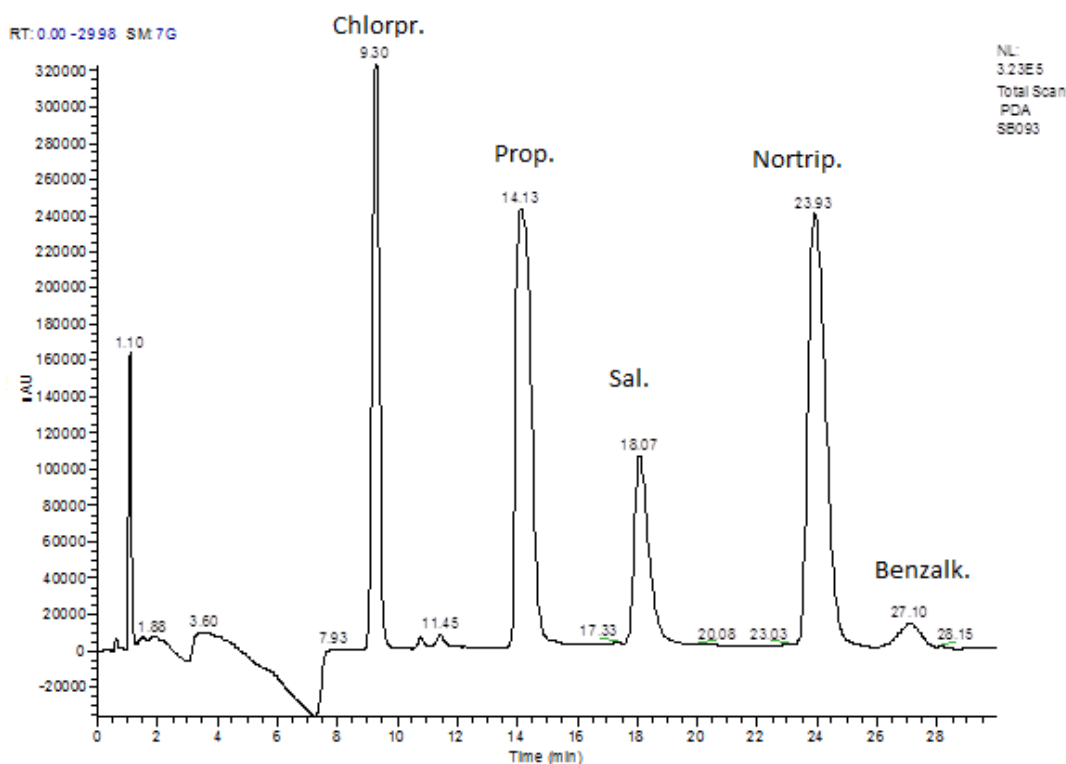


The effect of weakly basic counter ions on retention time was also examined. Table 2.3 shows the effect of using tris acetate ( $pK_a$  8.1) pH 6.0 on the retention time of the 5 base test mixture in comparison with ammonium acetate ( $pK_a$  9.25). As expected tris which is a weaker base than ammonium, and thus less charged at pH 6.0, produced longer retention times for the bases in the mixture. . In addition there was interesting change in separation with nortriptyline eluting nearly as late as benzalkonium. The chromatogram produced is shown in figure 2.5.

**Table 2.3 The effect of using 3.25 mM pH 6.0 tris acetate ( $pK_a$  8.1) as the counter ion in comparison with 3.25 mM ammonium acetate pH 6.0 on the retention times of the 5 base mixture ACE CN column (150 x 3 mm, 3  $\mu$ m particle size) (5% buffer: 95% acetonitrile) pH 6, flow rate 0.8 ml/min and UV detection at 220 nm.**

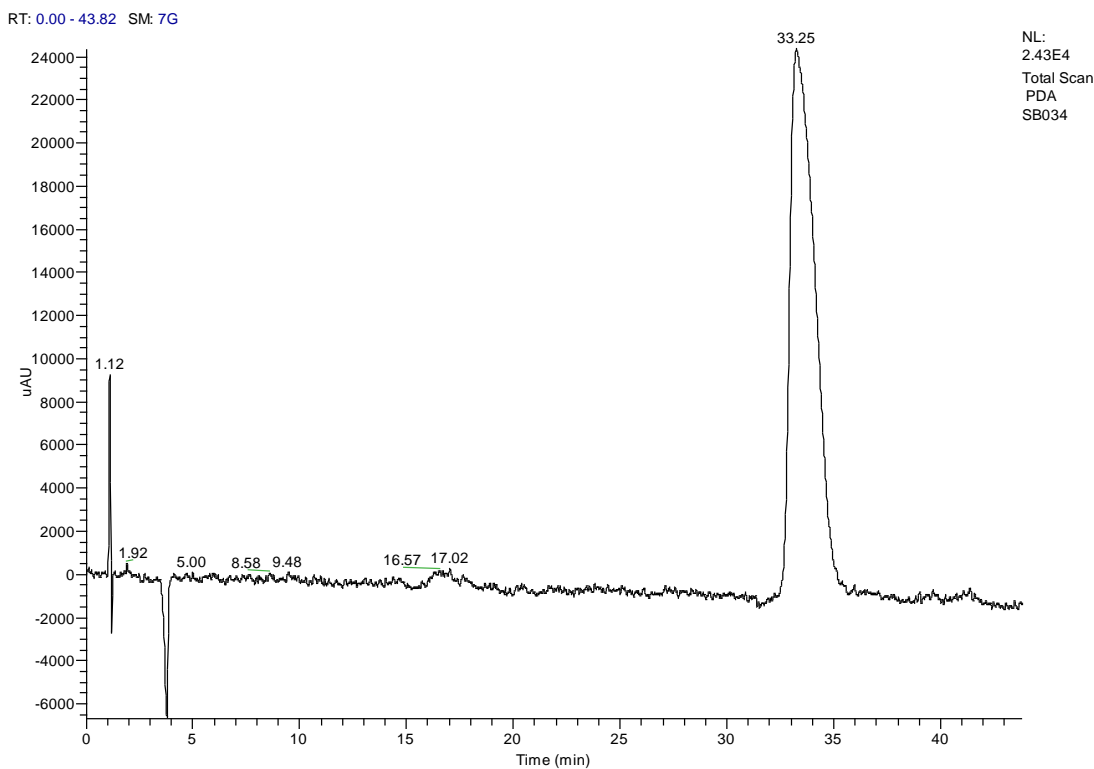
Compounds	3.25 mM ammonium acetate Rt (min)	3.25 mM Trizma acetate Rt (min)
Benzalkonium	20.0	27.1
Chlorpromazine	6.3	9.3
Nortriptyline	15.0	23.9
Propranolol	8.2	14.1
Salbutamol	10.1	18.0

**Figure 2-5 Retention times of basic compounds at pH 6 on the ACE CN column (150 x 3 mm, 3  $\mu$ m particle size) in 3.25 mM tris pH 6.0 in acetonitrile/water (95:5), flow rate 0.8 ml/min.**



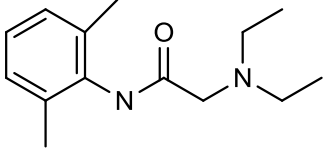
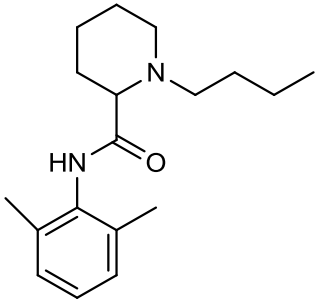
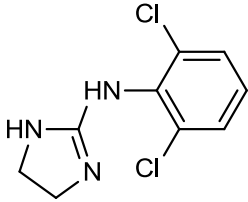
The CN column was then tested with bis tris buffer which has a  $pK_a$  value of 6.5 and thus is a very weak base. Figure 2.6 shows the chromatogram obtained for the least retained base in the 5 base test mix, chlorpromazine. Chlorpromazine elutes at 33 minutes when bis tris is used as the counter ion, the other bases failed to elute within 1 hour. Thus as expected bis tris, which is not ionised extensively at pH 6.0 in the presence of organic solvent, does not compete strongly with the bases in the test mix for silanols leading to long elution times.

**Figure 2-6 Chromatogram for chlorpromazine at pH 6 on an ACE CN column (150 x 3 mm, 3  $\mu$ m particle size) with 3.25 mM bis tris pH 6.0 in acetonitrile/water (95:5), flow rate 0.8 ml/min.**

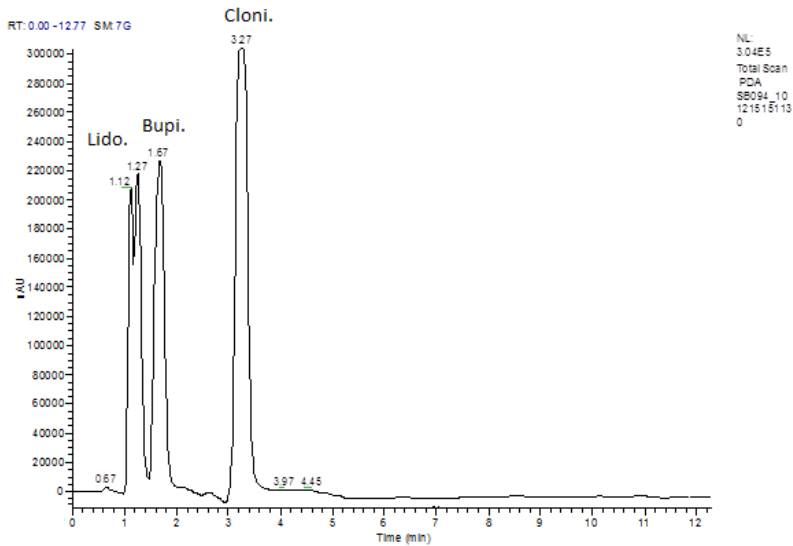


Chlorpromazine has a pKa value of *ca* 9.0 thus in order to obtain elution within a reasonable length of time a test mix of weak bases was used. The mix contained: lidocaine pKa 7.9, bupivacaine pKa 8.1 and clonidine pKa 8.2. Table 2.4 shows the retention times obtained for the weak bases with tris and with bis tris as the counter ions. Clonidine is weakly retained with tris as the counter ion on the CN column but when the more weakly basic counter ion bis tris is used clonidine becomes more strongly retained. Bupivacaine is not retained with tris as the counter ion but is retained when the weaker base bis tris is used as the counter ion (Figures 2.7 and 2.8).

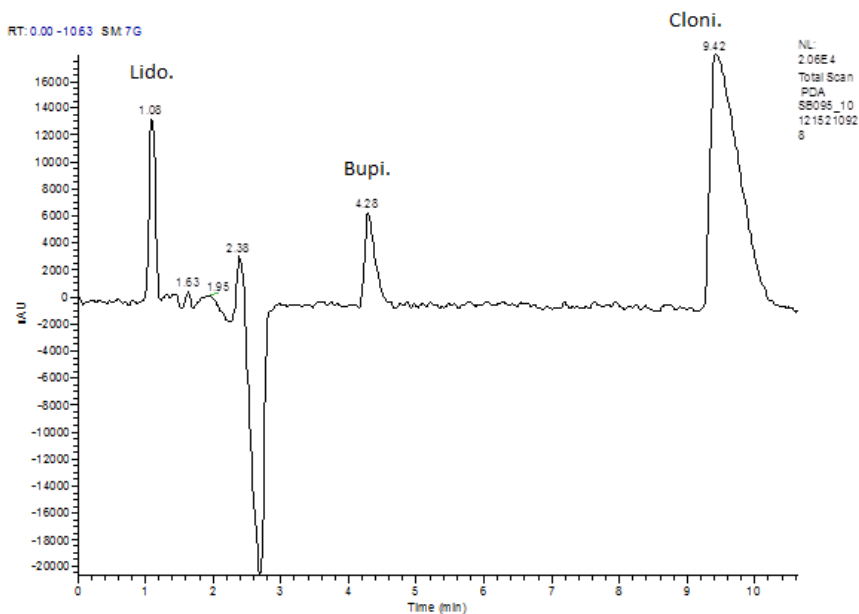
**Table 2.4 Retention times of weakly basic compounds at pH 6 on an ACE CN column (150 x 3 mm, 3  $\mu$ m particle size) with 3.25 mM tris and 3.25 mM bis tris in acetonitrile/water (95:5), flow rate 0.8 ml/min.**

	$pK_a$	Structure	Molecular weight g/mol	Tris $t_r$	Bis-tris $t_r$
<b>Lidocaine (t)</b>	7.9		234.34	1.3	1.1
<b>Bupivacaine (t)</b>	8.1		288.4	1.7	4.3
<b>Clonidine (s) (t)</b>	8.2		230.093	3.3	9.4

**Figure 2-7 Retention times of basic compounds at pH 6 on the ACE CN column (150 x 3 mm, 3  $\mu$ m particle size) in 3.25 mM tris acetate in acetonitrile/water (95:5), flow rate 0.8 ml/min.**



**Figure 2-8 Retention times of basic compounds at pH 6 on the ACE CN column (150 x 3 mm, 3  $\mu$ m particle size) in 3.25 mM bis-tris acetate in acetonitrile/water (95:5), flow rate 0.8 ml/min.**



Thus it was clear that a major determining factor for the retention of bases on a CN column is cation exchange. The basic strength of the counterion affects how strongly bases are retained. The best chromatographic performance in terms of peak shape was produced when ammonium was used as the counterion.

### ***2.3.3 Impurities in salbutamol***

In order to prove the usefulness of cation exchange on the CN column as a method in pharmaceutical analysis, a method was developed for the analysis of salbutamol and some of its impurities listed in the European Pharmacopoeia. Figure 2.9 shows the separation of salbutamol (1 mg/ml) from three of its manufacturing impurities listed in the European Pharmacopoeia (Figure 2.10) spiked at 1 µg/ml (i.e. at the 0.1% w/w level which is often used as a limit test in pharmacopoeial monographs) and although the differences in structure of the impurities from salbutamol are quite minor the column exhibits both good selectivity for the mixture and a wide dynamic range with low level impurities being efficiently eluted and detected. For measuring the linearity plots of series of concentration of impurities between 1 µg/ml and 1000 µg/ml with the peak area resulted in straight line with  $R^2$  for salbutamol ketone 0.998,  $R^2$  for salbutamol aldehyde 0.997 and desoxy salbutamol  $R^2$  is 0.999 (Figure 2.11). The RSD values ( $n = 6$ ) for the areas and retention times of the impurity peaks at the 1 µg/ml level were salbutamol ketone (area±3.4%, retention time±0.4%), salbutamol aldehyde (area±0.6%, retention time±0.4%) and desoxysalbutamol (area±1.2%, retention time±0.5%). The impurities are well resolved from the salbutamol peak and, advantageously all elute before it so that there is no interference from the tail of the overloaded salbutamol peak. The method in the European Pharmacopoeia uses a less convenient ion pairing method with a run time of 50 min [1]. The current method was also very robust with small changes in the flow rate, column temperature, mobile phase pH and

mobile phase composition (not affecting the method greatly. The limit of detection (LLOD) and lower limit of quantification (LLOQ) were measured at a signal to noise ratio of 3:1 and 10:1, respectively, by injecting a series of dilute solutions with known concentrations. The LLOD for salbutamol ketone and salbutamol aldehyde was 15 ng/ml and the LLOQ for these two impurities was 50 ng/ml, however the LLOD for desoxysalbutamol was 90 ng/ml and the LLOQ was 300 ng/ml. The symmetry factor was calculated for the impurities according to the United States Pharmacopeia with 1.5, 2 and 1.5 for the salbutamol ketone, salbutamol aldehyde and desoxysalbutamol respectively.

**Figure 2-9 Separation of salbutamol and its manufacturing impurities on an ACE CN column (150mm×3mm, 3µm) in acetonitrile/water (95:5) containing 3.25mM ammonium acetate pH 5.0, flow rate 0.8 ml/min with UV detection at 220 nm.**

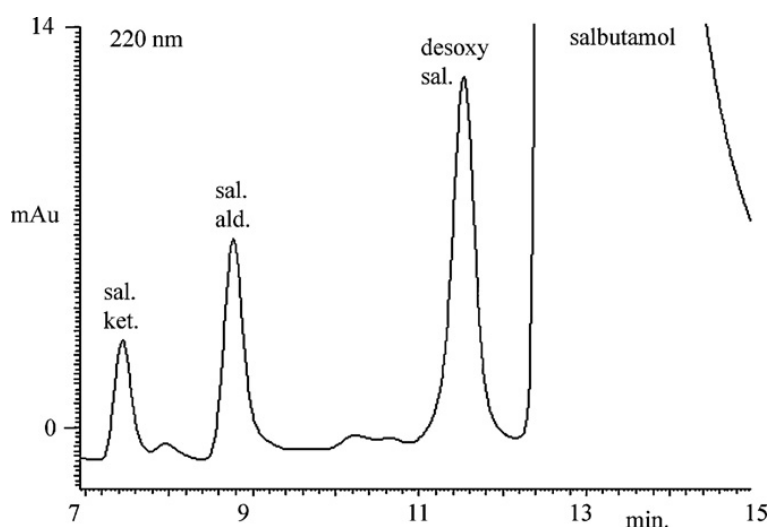


Figure 2-10 Manufacturing impurities in salbutamol.

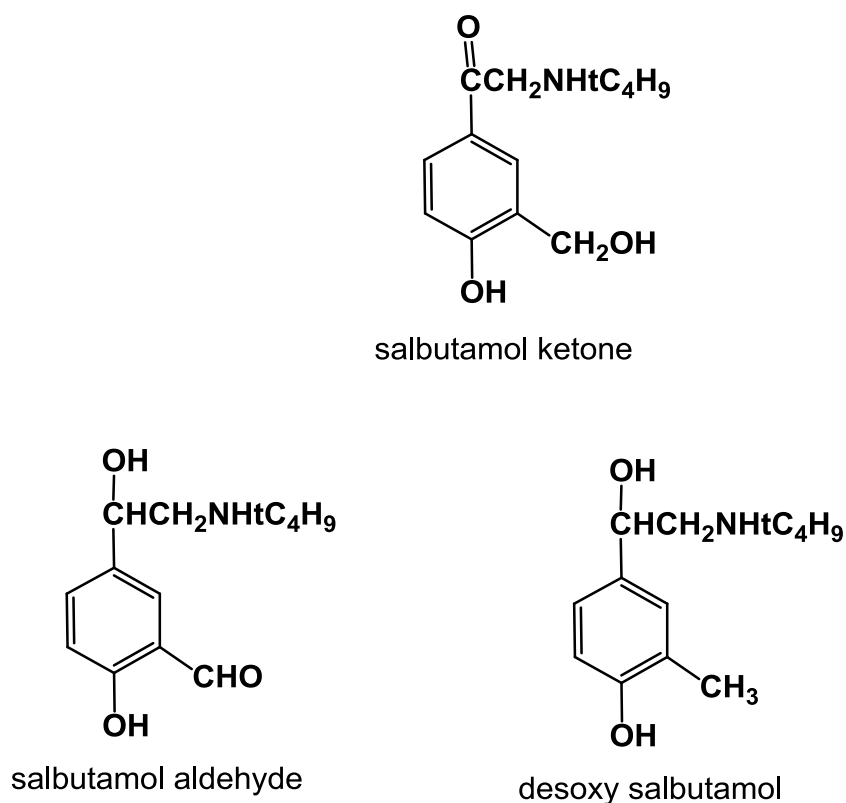
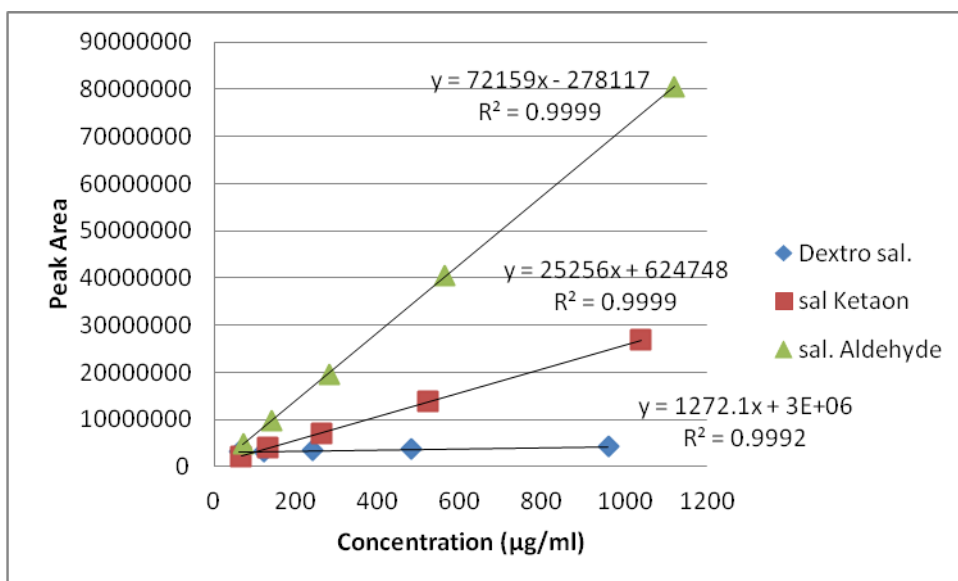


Figure 2-11 Plot of the salbutamol impurities (salbutamol ketone, salbutamol aldehyde and desoxysalbutamol) between 1 $\mu$ g/ml and 1000 $\mu$ g/ml. MP: 3.25 mM ammonium acetate in water:acetonitrile (5:95 v/v) on an ACE CN column. Flow rate 0.8ml/min.





In order to test the method further a commercial sample of salbutamol was profiled for impurities. The levels of impurities were monitored by using LC-MS. The flow rate used was 0.5ml/min. compared with 0.8 ml/min used in Figure 2.9. Figure 2.12 shows the LC-MS profile. Desoxysalbutamol is the most obvious impurity and the aldehyde and ketone impurities are at much lower levels. However, the impurity peaks are clearly visible as an extracted ion trace (Figure 2.13). The mass spectra from salbutamol and its impurities are shown in Appendix 1. There is one peak in the TIC trace just next to desoxysalbutamol which gives the mass spectrum shown in figure 2.14. The impurity has the formula  $C_{20}H_{28}NO_5$  which does not match any of the impurities listed in the EP. Its formula differs from the known impurity shown in figure 2.15 by 32 g/mol which might be two oxygen atoms or  $NH_2$  and O group and both may well be related to this impurity.

**Figure 2-12 TIC for salbutamol and its impurities on an ACE CN column (150mm×3mm) in acetonitrile/water (95:5) containing 3.25 mM ammonium acetate pH 5.0, flow rate 0.5 ml/min.**

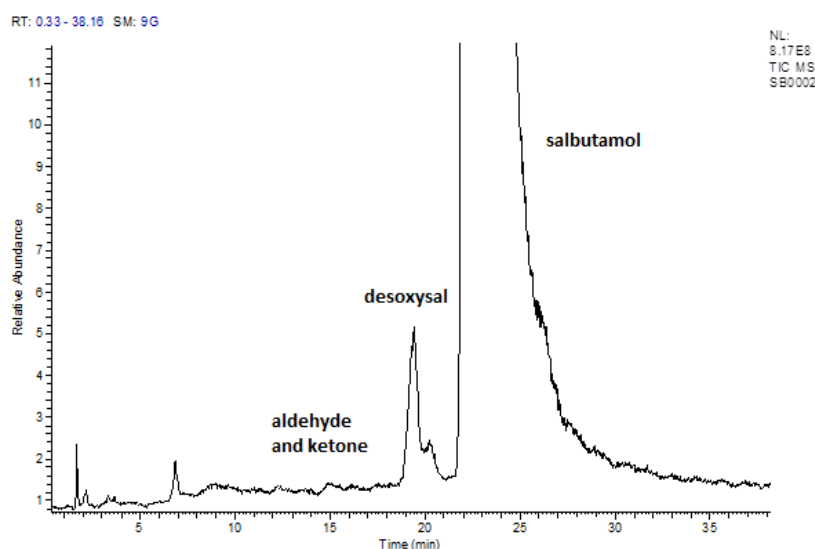


Figure 2-13 Extracted ion trace for the aldehyde and ketone impurities in salbutamol.

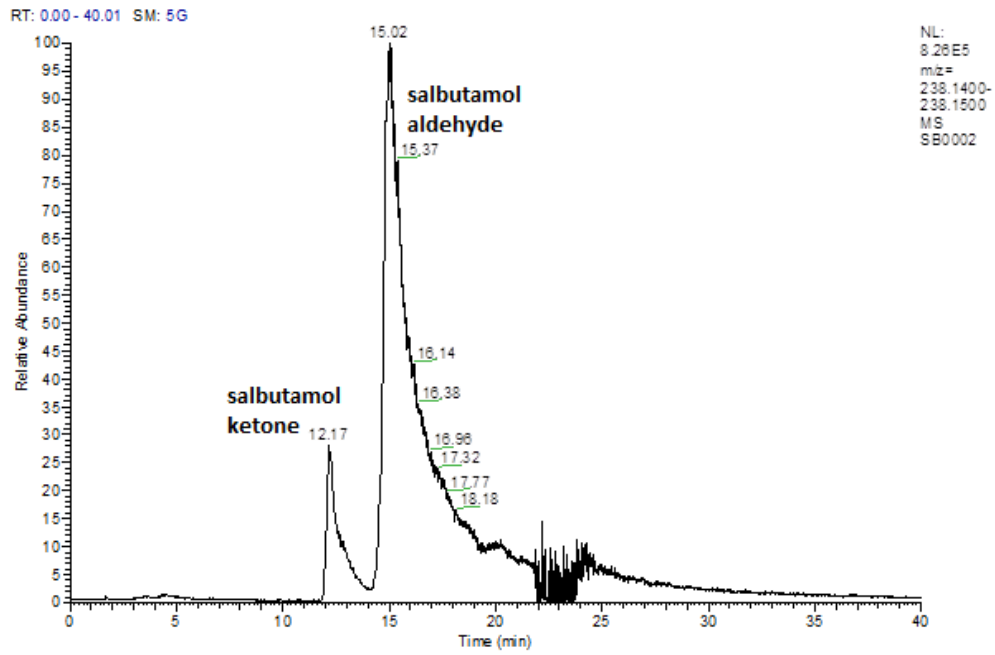
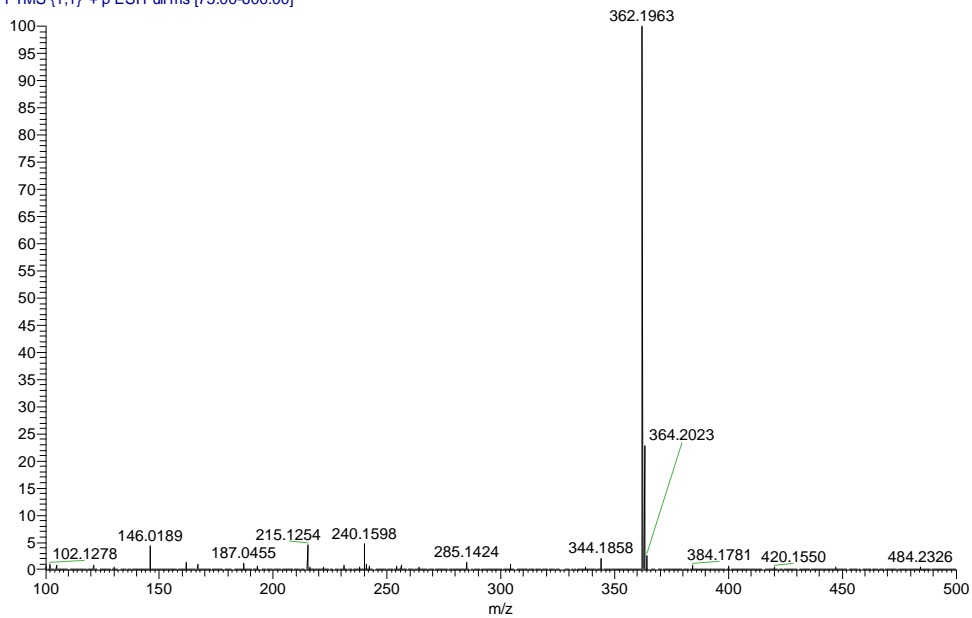
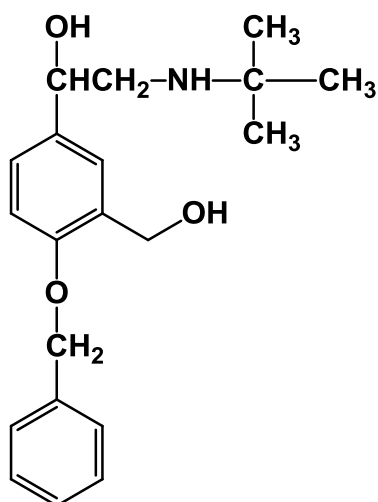


Figure 2-14 Mass spectrum of an unknown impurity in salbutamol.

SB0002 #2240 RT: 20.31 AV: 1 SB: 2 19.82, 20.88 NL: 2.71E6  
T: FTMS (1,1) + p ESI Full ms [75.00-600.00]



**Figure 2-15 Structure of known impurity in salbutamol closely related to the unknown impurity identified with the mass spectrum shown in Figure 2.14.**



#### ***2.3.4 Impurity Profiling of Promethazine by LC-MS Using an ACE CN Column***

The usefulness of the CN column for impurity profiling was further tested by using it in conjunction with LC-MS to carry out impurity profiling of promethazine. Figure 2.16 shows the TIC trace for the analysis of promethazine. Promethazine since it is a tertiary amine runs earlier than salbutamol, it has lower pKa value in the high percentage of ACN comparing with primary and secondary amine. The two major impurities in promethazine are due to desmethyl promethazine but only one desmethyl impurity is listed in the EP. The other impurities, the S-oxide, promethazine isomer and the tricyclic ring structure with the side chain missing are all listed in the EP. The mass spectra for promethazine and its impurities are shown in appendix I (A1.4-A1.7). Figure 2.17 shows the structures of promethazine and its listed impurities from the EP.

Figure 2-16 Analysis of impurities in promethazine by LC-MS. Conditions as in Figure 2.5.

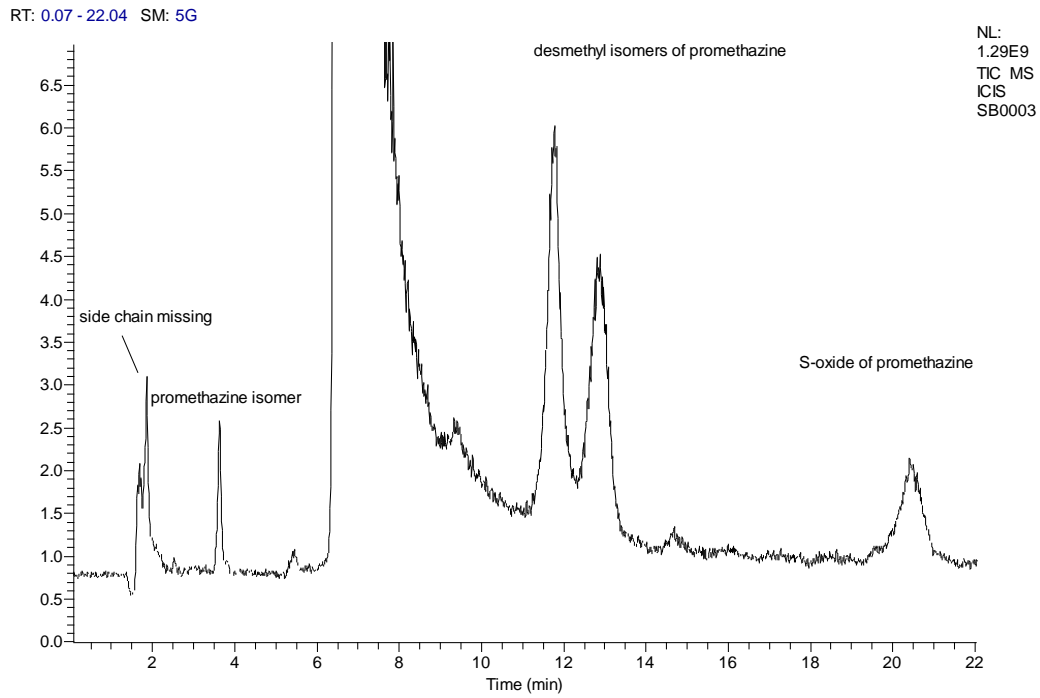
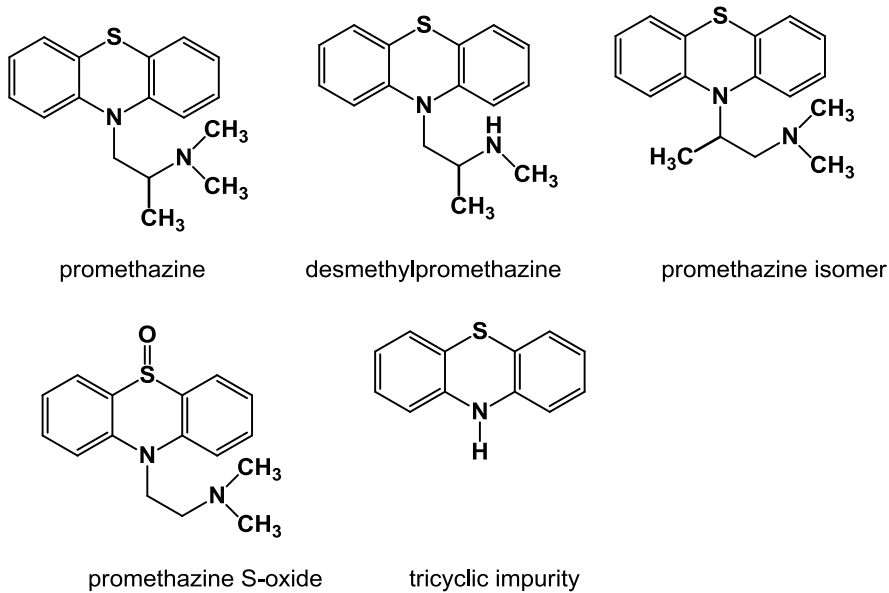


Figure 2-17 Promethazine and its impurities.

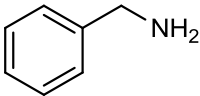
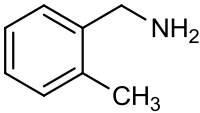
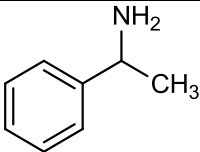
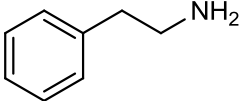


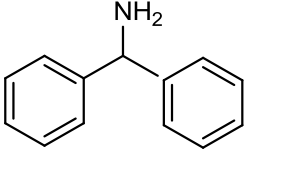
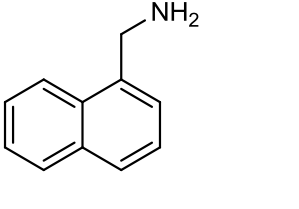
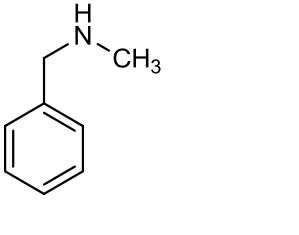
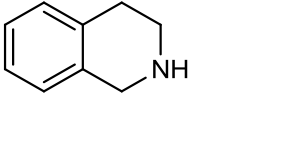
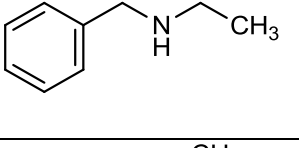
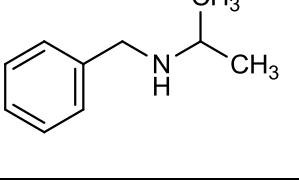
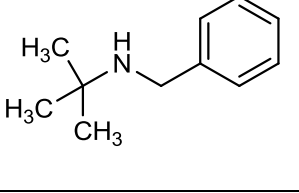
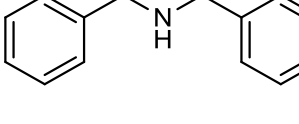
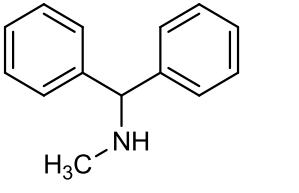
**2.3.5 Investigation of the influence of structure on the retention mechanism of an ACE CN column using some simple bases**

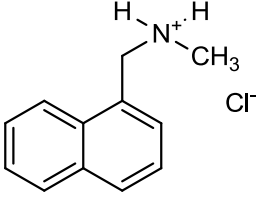
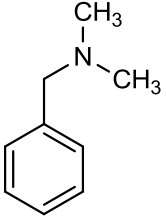
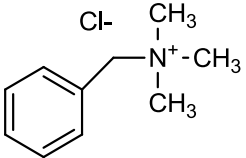
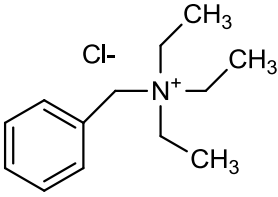
In order to discover more about the role of the basic centre in determining the degree of retention on a CN column the retention of a series of simple amines was evaluated.

Table 2.5 shows the structures of basic compounds. They are simpler compounds than the drug molecules used to investigate the column in the preceding sections. The bases were subjected to similar tests to those used in the sections above.

**Table 2.5 Structures of the organic bases used to test the mechanism of retention on an ACE CN column. P= primary amine, S= Secondary amine, T=tertiary amine, Q=quaternary amine.**

Compound	pKa	Structure	Molecular weight (g/mol)
Benzylamine (P)	9.34		107.15
2-methylbenzylamine (P)	9.50		121.18
Alpha-methylbenzylamine (P)	9.75		121.18
Phenylethylamine (P)	9.83		121.18

Aminodiphenylmethane (P)	8.61		183.25
Naphthlenemethylamine (P)	9.8		157.21
N-benzylmethylamine (S)	9.1		121.18
Tetrahydroisoquinoline (S)	9.4		133.19
Ethylbenzylamine (S)	9.3		135.21
N-Benzylisopropylamine (S)	9.76		149.23
N-(tert-Butyl)benzylamine (S)	9.77		163.26
Dibenzylamine (S)	8.76		197.28
N-(Diphenylmethyl)methylamine (S)	9.61		197.28

N-methyl-1-naphthlenemethylamine hydrochloride (S)	9.85		207.70
Benzyltrimethylammonium chloride (Q)	8.8		135.21
Benzyltrimethylammonium chloride (Q)	N/A		185.69
Benzyltriethylammonium chloride (Q)	N/A		227.77

N/A = Not Applicable

### 2.3.5.1 The Effect of the molecular weight of the Basic Centre on Retention Time.

The degree retention was correlated with the type of the amines, the tertiary amine was the least retained among all the other classes of the amines (Table 2.6) and it was found that benzyltrimethyl amine eluted at a retention time of 5.9 min. The primary amines were next with retention times between 8 min and 9 min. The separation was also affected by the size of the compound and by the molecular shape. For example in benzylamine the amine group is less sterically crowded than in  $\alpha$ -methylbenzylamine. Alpha-methylbenzylamine has one methyl group more than benzylamine, and this methyl group is close to the primary amine group and thus may hinder interaction with the silanol groups in the CN phase. Alpha-methylbenzylamine and 2-methylbenzylamine have the same molecular weight but they

have different retention times. The alpha-methylbenzylamine retains at 7.4 min and 2-methylbenzylamine retains at 8.2 min, this supports the theory of steric crowding of the amine centre since the methyl group in 2-methyl benzylamine hinders the amine centre less than the methyl group in  $\alpha$ -methylbenzylamine which is closer to the primary amine group. In the case of the secondary amines the higher molecular weight of the compounds the shorter will be retention in the CN column. This fact relates to the size of the alkyl substituent on the secondary amine, 4-tertbutylbenzylamine which has a retention time of 9.6 min has a bulky t-butyl substituent while N-benzylmethylamine, where the retention time was much longer at 16.3 min., has a much smaller methyl substituent. N-benzylisopropylamine, ethylbenzylamine and tetrahydroisoquinoline have retention times of 12.3, 14.7 and 16.0 min. respectively and have substituents intermediate in size between methyl and t-butyl. Finally the quaternary amines have the strongest retention on the CN column with benzylmethylamine being retained for 29.5 min and benzyltriethylamine being retained for 25.0 min. The benzyltriethylamine has larger substituents than benzyltrimethylamine which make it less retained benzyltrimethylamine again reflecting the effect of bulky groups in hindering the interaction between the cation and silanol groups in the CN phase. It is also possible to look at the retention in terms of the charge density at the basic centre with the centres with more bulk groups attached having lower charge density.

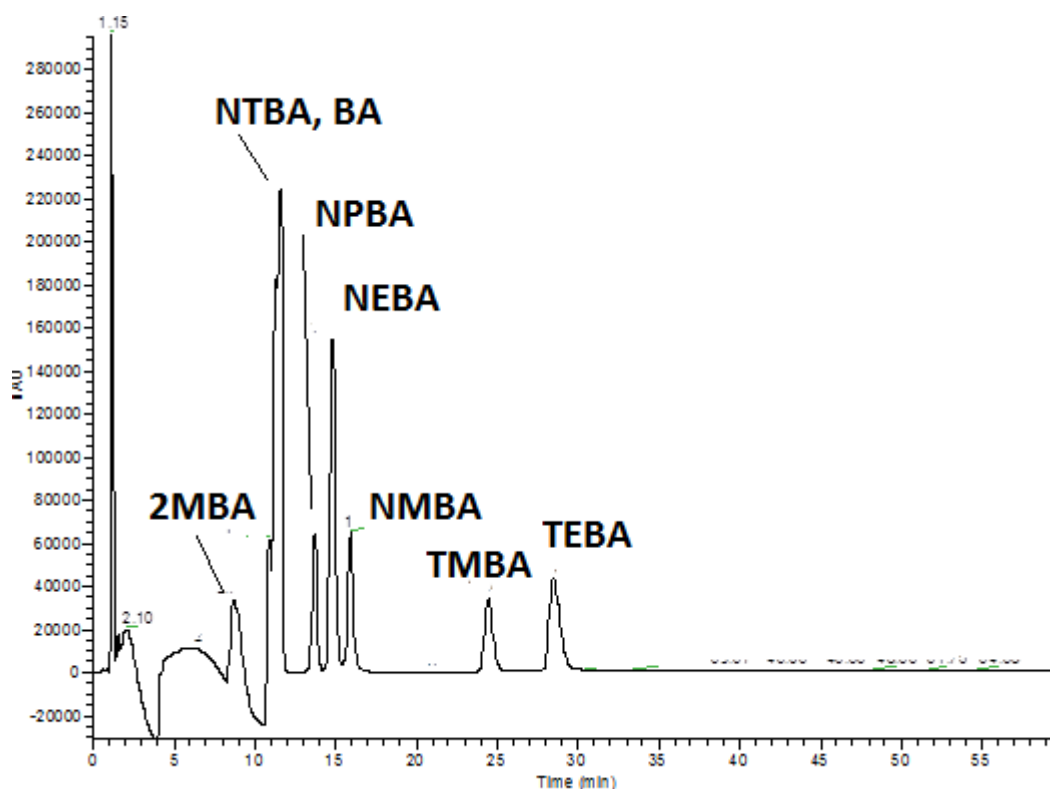


**Table 2.6 Retention times of basic compounds at pH 6 on the ACE CN column (150 x 3 mm, 3  $\mu$ m particle size) 3.25 mM ammonium acetate in acetonitrile/water (95:5), flow rate 0.8 ml/min.**

<b>Basic Compounds</b>	<b>Retention Time (min)</b>
Alpha-methylbenzylamine (P)	7.4
2-methylbenzylamine (P)	8.2
Phenylethylamine (P)	1.3
Aminodiphenylmethane (P)	1.4
Naphthalinemethylamine (P)	5.7
Benzylamine (P)	9.1
N-benzylmethylamine (S)	16.3
Ethylbenzylamine (S)	14.6
4-tertbutylbenzylamine (S)	9.6
N-benzylisopropylamine (S)	12.3
Tetrahydroisochinoline (S)	16.0
Dibenzylamine (S)	1.9
(N-diphenylmethyl)methanamine (S)	1.5
N-methene-1-naphthalineethylamine Hcl (S)	9.6
Benzyltrimethylamine (T)	5.9
Benzyltrimethylamine (Q)	29.5
Benzyltriethylamine (Q)	25.0

A chromatogram for the test bases can be seen in Figure 2.18.

**Figure 2-18 Analysis of model bases: 2-methylbenzylamine (2MBA), N-tertiarybutyl, benzylamine (NTBA), N-isopropylbenzylamine (NPBA), N-ethyl benzylamine (NEBA), N-methylbenzylamine (NMBA), trimethylbenzylamine (TMBA), triethylbenzylamine (TEBA) on an ACE CN column (150mm×3mm) in acetonitrile/water (95:5 v/v) containing 3.25mM ammonium acetate pH 6, flow rate 0.8 ml/min.**



### ***2.3.5.2 The Effect of pH on the Retention of the Simple Test Probes***

Table 2.7 shows the effect when the pH of the mobile phase is varied between pH 3, 4, 5, 6 and 7. The simplest effect is observed for benzyltrimethylamine (BTMA) and benzytriethylamine (BTEA) where retention time gradually increases between pH 3 and pH 7 which, since the charge on these compounds is not affected by pH, directly reflects the degree of ionisation of the silanol groups in the CN phase. The highest retention is at pH 7 where the greatest degree of ionisation of the silanol groups occurs. The greatest rate of increase in retention for BTMA and BTEA occurs between pH 3 and 5 suggesting that this is

the range where most of the silanol groups become ionised and there is not big difference in retention at pH 6 and pH 7 compared with pH 5 since the silanols were almost completely ionized at pH 5.0. In the case of the other amines the picture is more complicated since unlike the quaternary amines they do not carry a fixed charge and as the pH rises their degree of ionisation will decrease depending on their  $pK_a$  values. The secondary amines follow a similar pattern to the quaternary amines with the greatest increase in retention being between pH 3 and pH 5, however, between pH 6 and pH7 there is a small decrease in retention indicating that the charge on the amines is decreasing due to deprotonation. In very high organic solvent content the  $pK_a$  values of the bases are much lower than in water, in water the  $pK_a$  values of secondary amines would be expected to be between 9.5 and 10. The retention time of the tertiary amine benzyl dimethylamine steadily decreases with increasing pH suggesting that it becomes less charged above pH 3.0 and the primary amines follow a similar pattern with their retention times decreasing above pH 4.0. This indicates that the  $pK_a$  values of the primary and tertiary amines are very low in the high organic content of the mobile phase.

**Table 2.7 Retention times of basic compounds at different pH values on an ACE CN column (150 x 3 mm, 3  $\mu$ m particle size) in 3.25 mM ammonium acetate in acetonitrile/water (95:5), flow rate 0.8 ml/min.**

Compounds	pH 3	pH 4	pH 5	pH 6	pH 7
Alpha-methylbenzylamine (P)	7.7	9.0	7.9	7.4	7.30
2-methylbenzylamine (P)	7.7	9.4	8.6	8.2	7.9
Phenylethylamine (P)	3.9	1.6	1.3	1.3	1.3
Aminodiphenylmethane (P)	4.1	1.9	1.5	1.4	1.4
Naphthalinemethylamine (P)	7.6	7.9	6.1	5.7	5.7
Benzylamine (P)	8.2	10.2	9.7	9.1	9.0
N-benzylmethylamine (S)	8.7	13.4	15.8	16.2	16.1
Ethylbenzylamine (S)	7.5	10.8	13.8	14.7	14.1
4-tertbutylbenzylamine (S)	7.3	9.8	9.9	9.6	9.7
N-benzylisopropylamine (S)	7.0	9.6	11.6	12.3	11.3
Tetrahydroisochinoline (S)	8.8	13.3	15.2	16.0	15.0
Dibenzylamine (S)	4.9	2.9	2.0	1.9	1.9
(N-diphenylmethyl)methanamine (S)	4.5	2.0	1.5	1.5	1.5
N-methene-1-naphthaline ethylamine(S)	8.1	10.1	10.0	9.6	9.7
Benzyltrimethylamine (T)	8.4	7.7	6.1	5.9	5.7
Benzyltrimethylamine (Q)	10.9	17.3	26.7	29.5	30.1
Benzyltriethylamine (Q)	8.8	14.8	22.8	25.0	26.1

### ***2.3.5.3 The effect of the different buffer concentrations on the retention of simple amines***

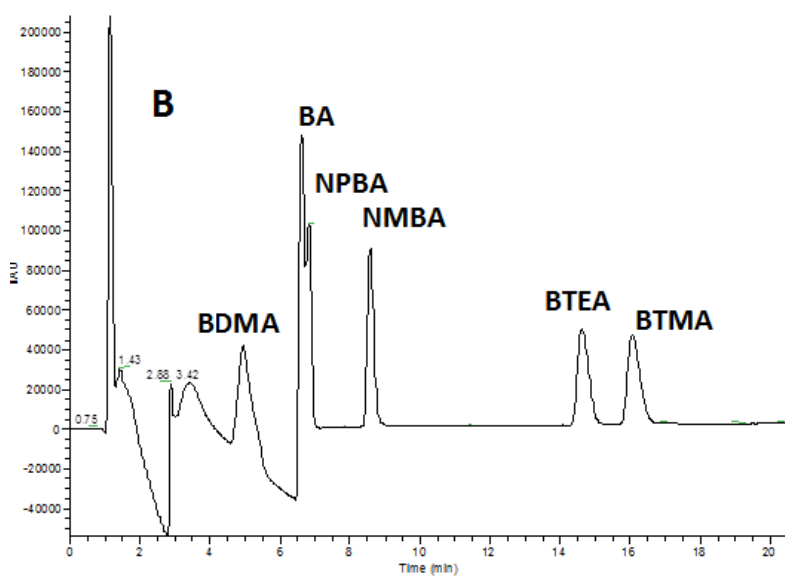
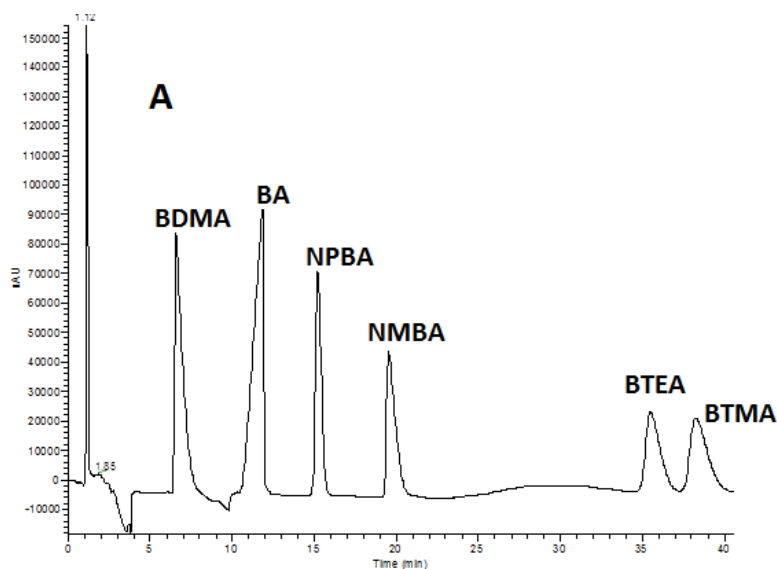
The effect of the molarity of the buffer salt on retention time of the bases was observed by varying molarity between 1.625 mM and 13 mM. Table 2.8 shows the effect when the concentration of the ammonium acetate in the mobile phase is varied between 1.625mM, 3.25mM, 6.5mM and 13 mM, which results in the retention of the basic compounds being reduced by nearly 50% for each concentration increase for all the classes of the amines (Table 2.5). This strongly supports a proposal that much of the retention mechanism is due to ion exchange with increased ionic strength of the mobile phase reducing the interaction of the basic compounds with the stationary phase. Although the ACE CN phase is endcapped, as is the case with all endcapped phases, many free silanol groups remain within the phase.

**Table 2.8 Retention times of basic compounds with different concentrations of the buffer on the ACE CN column (150 x 3 mm, 3  $\mu$ m particle size) varying strengths of ammonium acetate in acetonitrile/water (95:5), flow rate 0.8 ml/min.**

<b>Basic Compounds</b>	<b>1.625mM</b>	<b>3.25mM</b>	<b>6.5mM</b>	<b>13mM</b>
Alpha-methylbenzylamine (p)	7.8	7.4	4.4	3.5
2-methylbenzylamine (p)	8.7	8.2	4.9	3.8
Phenylethylamine (p)	1.4	1.3	1.2	1.2
Aminodiphenylmethane (p)	1.4	1.4	1.3	1.3
Naphthalinemethylamine (p)	6.2	5.7	3.7	3.0
Benzylamine (p)	11.0	9.1	5.4	4.2
N-benzylmethylamine (S)	18.3	16.3	8.5	5.8
Ethylbenzylamine(s)	15.7	14.7	7.7	5.3
4-tertbutylbenzylamine(s)	12.3	9.6	6.2	4.3
N-benzylisopropylamine (s)	14.5	12.2	6.6	4.3
Tetrahydroisoquinoline (s)	16.3	15.9	7.8	5.4
Dibenzylamine (s)	2.1	1.8	1.6	1.3
(N-diphenylmethyl)methylamine (s)	1.4	1.4	1.2	1.2
N-methyl-1-	11.9	9.6	5.8	4.1
Benzyl dimethylamine (T)	5.7	5.9	3.4	2.7
Benzyltrimethylamine (Q)	37.0	29.4	15.9	10.1
Benzyltriethylamine (Q)	34.7	24.9	14.4	8.9

Figures 2.19A and B show the separation of the basic test mix at with 1.125 mM ammonium acetate buffer and 6.5 mM ammonium acetate buffer.

**Figure 2-19 Analysis of benzyldimethylamine (BDMA), benzylamine (BA), N-isopropylbenzylamine (NPBA), N-methylbenzylamine (NMBA), benzyltriethylamine (BTEA) and benzyltrimethylamine (BTMA) on an ACE CN column (150 x 3 mm, 3  $\mu$ m particle size) with A 1.125 mM ammonium acetate in acetonitrile/water (95:5), B 6.5 mM ammonium acetate in acetonitrile/water (95:5). Flow rate 0.8 ml/min.**



#### ***2.3.5.4 The Effect of Water Content of the Mobile Phase on Retention Times***

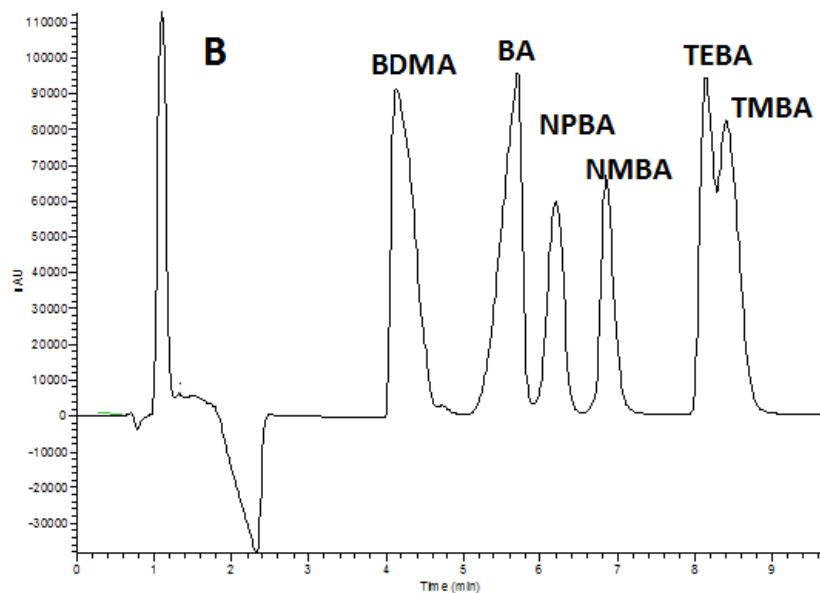
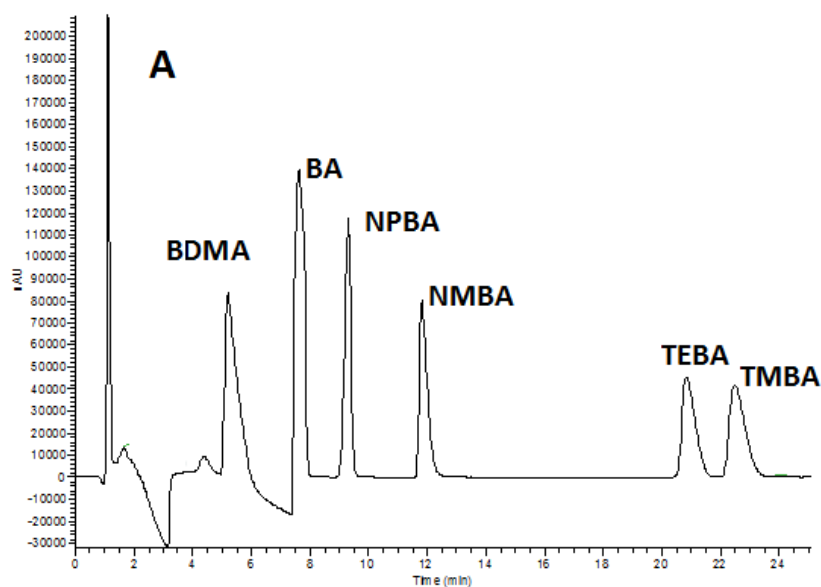
In Table 2.9 the effect of varying the water content of the mobile phase between 5%, 10% and to 15% can be seen. There was a marked decrease in retention times as the water content increased. The retention time was reduced for all the amine classes to < 8 min with 10% and < 5 min with 15% water. It is difficult to fully explain the marked decrease in retention times. BTEA and BTMA are the simplest case since their degree of ionisation would not be affected by water content. The degree of ionisation of silanol groups would be likely to increase with increased water content and this would increase retention of BTEA and BTMA. The degree of ionisation of the ammonium counter ion will also increase with increasing water content and this would cause a decrease in the retention of BTEA and BTMA. An additional consideration would be thickness of a solvating water layer which would be likely to decrease with increased water content in the mobile phase, as the water increase the polarity of the mobile phase increase more than the stationary phase which lead to decrease the water rich layer on the stationary phase. Thus the marked retention time decreases for the test compounds are probably due to a combination of these factors. The effect of increasing the water content of the mobile phase on the chromatograms obtained for the test bases can be seen in Figures 2.20 A and B as the water content in the mobile phase increase the retention time of the analyte decrease.

**Table 2.9 Retention times of basic compounds with different aqueous percentage of the mobile phase on the ACE CN column (150 x 3 mm, 3  $\mu$ m particle size) with 3.25 mM ammonium acetate in acetonitrile/water, flow rate 0.8 ml/min.**

<b>Basic Compounds</b>	<b>95% ACN</b>	<b>90% ACN</b>	<b>85% ACN</b>
Alpha-methylbenzylamine (p)	6.3	4.7	3.9
2-methylbenzylamine (p)	6.9	4.8	3.9
Phenylethylamine (p)	1.3	1.4	1.8
Aminodiphenylmethane (p)	1.4	1.4	1.8
Naphthalinemethylamine (p)	5.1	3.7	3.8
Benzylamine (p)	8.5	4.9	3.9
N-benzylmethylamine (s)	12.5	5.9	4.4
Ethylbenzylamine (s)	11.5	5.7	4.3
4-tertbutylbenzylamine (s)	9.1	5.1	4.1
N-benzylisopropylamin (s)	10.1	5.4	4.2
Tetrahydroisochinoline (s)	11.7	5.8	4.5
Dibenzylamine (s)	2.0	2.1	2.5
(N-diphenylmethyl)methyaneamine (s)	1.5	1.5	2.0
N-methene-1-naphthalinemethylamine	8.8	5.3	4.3
Benzyltrimethylamine (T)	4.8	3.8	4.0
Benzyltrimethylamine (Q)	22.3	7.3	5.0
Benzyltriethylamine (Q)	20.7	7.1	5.0



**Figure 2-20 Analysis of benzyldimethylamine (BDMA), benzylamine (BA), N-isopropylbenzylamine (NPBA), N-methylbenzylamine (NMBA), benzyltriethylamine (BTEA) and benzyltrimethylamine (BTMA) on an ACE CN column (150 x 3 mm, 3  $\mu$ m particle size) with A 3.25 mM ammonium acetate in acetonitrile/water (95:5) B 3.25 mM ammonium acetate in acetonitrile/water (90:10). Flow rate 0.8 ml/min.**



### ***2.3.5.5 Determination of the stability of the ACE CN Column***

The ACE CN column was found to produce good peak shape and reproducible retention times for the base test mixes. However, there was some question of its long term stability. With regard to the stationary phase coating, CN columns have been found to be relatively unstable and the cyanopropyl ligand is more likely to hydrolyse than purely alkyl ligands [52]. In order to evaluate the stability of the cyanopropyl ligand the column was monitored with the five base test mixture chlorpromazine, propranolol, salbutamol, nortriptyline, benzalkonium chloride run in 3.25 mM ammonium acetate/acetonitrile (5:95) pH 6 with the time, as with time the cyano ligand can hydrolysis and offering silonals group and in this case the analytical compounds will retain more. The CN column was fairly stable over 200 hours. The cyanopropyl column seems to be stable as long as the ammonium acetate buffer is the only buffer used with the column.

The result of testing a new CN column over the time can be seen in Figure 2.21. It can be seen that the retention time increases with the time due to loss on some of the CN stationary phase ligand which exposes more silanol groups. This results in making more silanol groups available for interactions with bases and thus increases the retention of the basic compounds. For example the retention time of salbutamol increased from 9.9 min to 12.4 min in 14 days. The increase occurred for all the bases which supported the hypothesis that the stationary phase is gradually lost with time.

Figure 2-21 Retention times of basic compounds (chlorpromazine, propranolol, salbutamol, nortriptyline and benzoalkonium) with different time on the ACE CN column (150 x 3 mm, 3  $\mu\text{m}$  particle size) in 3.25 mM w/v ammonium acetate in acetonitrile/water (95:5), flow rate 0.8 ml/min.

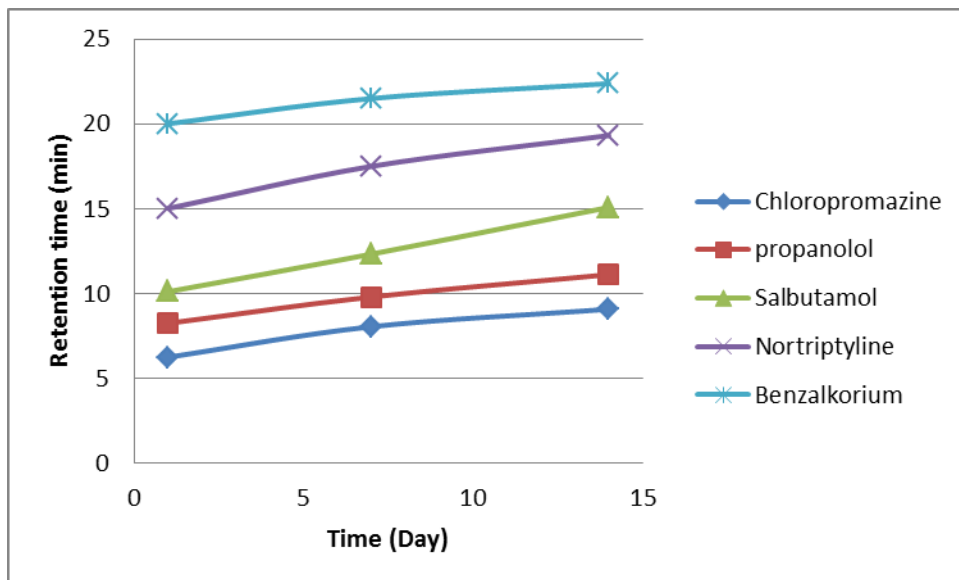
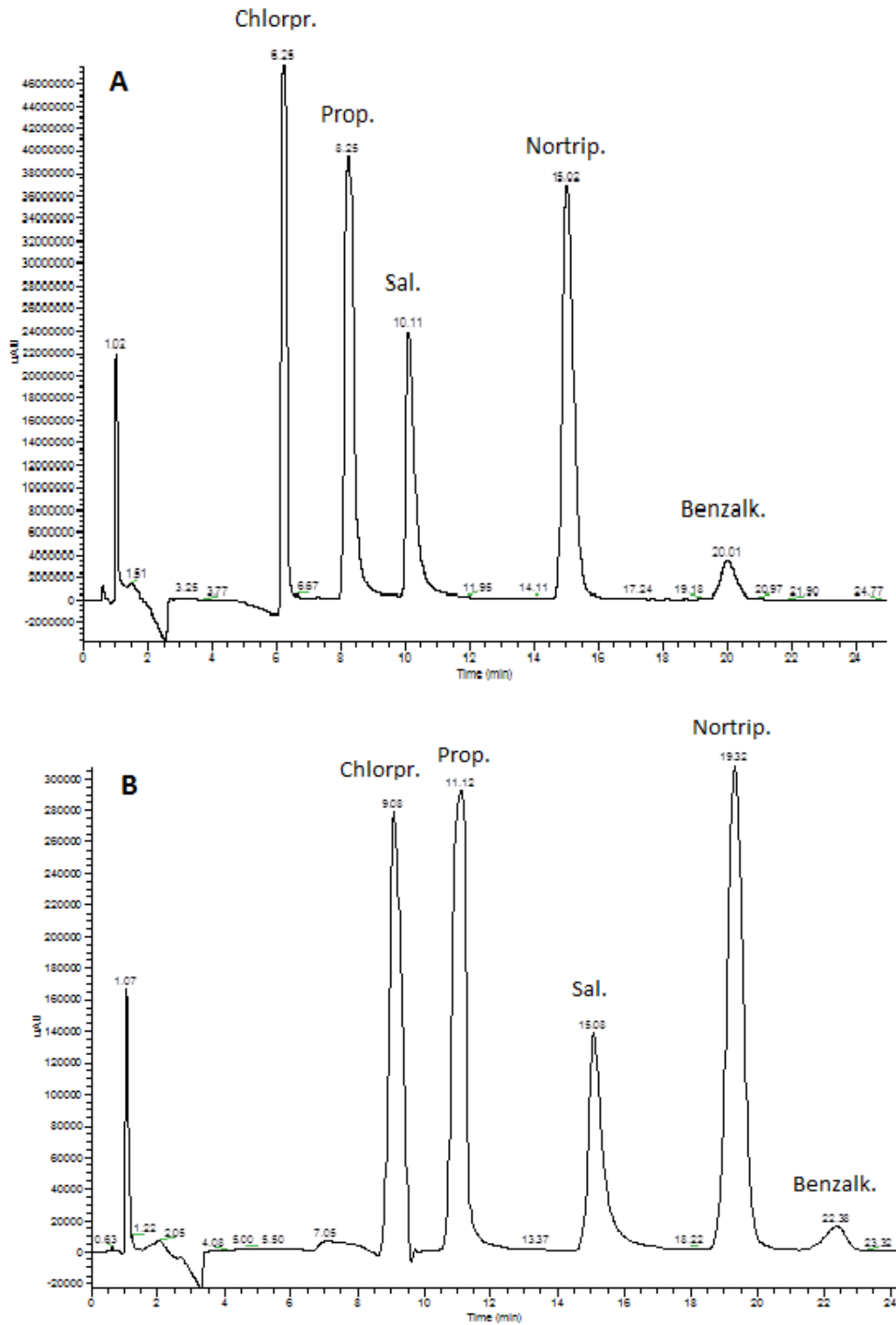


Figure 2-22. Retention times and the peak shape of 5 basic compounds at pH 6 on the ACE CN column (150 x 3 mm, 3  $\mu$ m particle size) in 3.25 mM ammonium acetate pH 6.0 in acetonitrile/water (95:5), flow rate 0.8 ml/min. A chromatograph at the first day of using the column and B chromatograph after 14 days of using the column.



## 2.4 Conclusion

The tertiary amines elute first from the CN column compared with the different amine group classifications, followed by the primary and the secondary amines as it is depend on their pKa value in the high amount of acetonitrile. The quaternary amines are the most retained compounds. The effect of the pH on the amines is clear for the quaternary and secondary amines since the quaternary amines are not affected by the pH and the secondary amines have a high pKa values which make them ionise in the pH range used. The retention of the quaternary amines reflects the degree of ionisation of the silanol groups and increases with an increase in pH. However, for the primary and tertiary amines the increase in the pH decreases the retention time of these compounds since they have low pKa values and their degree of ionisation decreases with increasing pH. Steric hindrance strongly affects the retention time for basic compounds. Increasing the buffer strength in the mobile phase can reduce the retention time of all the basic compounds due to increased competition for silanol groups. In addition, increasing in the water content in the mobile phase also reduces the retention for all the bases which is probably due to a number of different factors. The effect of increasing the pH is different, the retention of quaternary and secondary amine are increased and the primary and tertiary amines drease.

The retention for the 5 basic drugs used to test the CN column is almost abolished by using the sodium acetate instead of the ammonium acetate since the sodium ion is small and acts as a strong counter ion to the organic bases. Tris and bis-tris produced longer retention times for the bases since the basic counter ion in the buffer is weaker and they compete less effectively with the test bases for silanol groups.

Development a fast and an easy method for separation and detection salbutamol from its impurities by UV and applied the LC-MS for separation salbutamol samples, another example was separation the promethazine form its 4 comment impurities however one more impurities has been separated with HILIC mechanism which has not been list in the European Pharmacopeia.

## **Chapter 3**

**|A Comparison of the  
Chromatographic Properties of  
Silica Gel and Silicon Hydride  
Modified Silica Gels.**

### 3.1 Introduction

Silica gel has been used for many years as a chromatographic material both as a polar adsorbant and, when coated with organosilanes, as a reversed phase medium. The term hydrophilic interaction chromatography (HILIC) was coined by Alpert in 1990 [92] in order to describe chromatographic retention as a consequence of the partitioning of substances into an adsorbed water layer on a polar stationary phase. It is only more recently that HILIC has been used widely and much of the initial work utilised bare silica gel as the HILIC medium [8, 51, 93-95]. In addition various types of surface modified silica gels have been used for HILIC separation [96-100]. However, in most cases it is difficult to be certain how much of the retention characteristics of surface modified silicas belong to the silica gel itself since surface coating of silica gels always leaves a lot of unreacted silanols on the surface of the chromatographic phase. During the last 20 years Pesek and co-workers have pioneered the use of type C silica where the surface of the silica gel has been converted from bearing silanol groups to carrying silicon hydride groups [101-104]. Initially it was presumed that the Si-H bond would be hydrolytically unstable but after 20 years of experience in using the material it is apparent that the Si-H bond on the modified surface is stable. The properties of the Si-H group are very different from the Si-OH group and the Si-H surface should not undergo the ion exchange interactions which occur with Si-OH since the free silanol groups on the surface of this phase are <2% and the phase also has some weak lipophilic properties [102, 103]. According to the theory of HILIC, interaction is said to occur with surface adsorbed water and this is also believed to be the case with type C silica phases although the surface layer of water is thinner [104]. However, it is apparent that neither the Si-H surface nor indeed the Si-OH surface are fully understood and there has not been a fundamental exploration of the difference between the silanol bearing surface of silica gel



and the type C silica surface. Recently we explored the ion exchange properties of alkyl columns under hydrophilic interaction conditions with particular focus on a cyanopropyl column which displayed marked cation exchange properties with bases. The interaction of the bases with the CN column could be modulated according to the concentration and pKa value of the cationic modifier within the mobile phase [34]. The Si-H surface has potentially the same flexibility as silica gel when it comes to surface modification and alkyl groups can be bonded to it via reaction of alkenes bearing a terminal olefinic bond catalysed by Speier's catalyst.

Many different applications have already been studied for separation of the polar compounds on silica hydride phases when HILIC model is applied. Drugs such as cycloserine and its polar impurities [105] and also amino acids, organic acids, carbohydrates [106], nucleotides [107], peptides [108] and biological matrix [106] has been show a very good separation efficacy and repeatability with different detector such as UV and mass spectrometer.

The current study compares silica gel and a type C silica columns using model bases and neutral and acidic biomolecules as test analytes.

## **3.2. Materials and Methods**

### ***3.2.1 Chemicals and Reagents***

HPLC grade acetonitrile was obtained from Fisher Scientific (Loughborough, UK). Water was obtained from a Milli-Q water-purification system (Millipore, Watford UK). All other chemicals and standards were obtained from Sigma-Aldrich (Poole, UK).

### **3.2.2 Chromatography Columns and LC-MS**

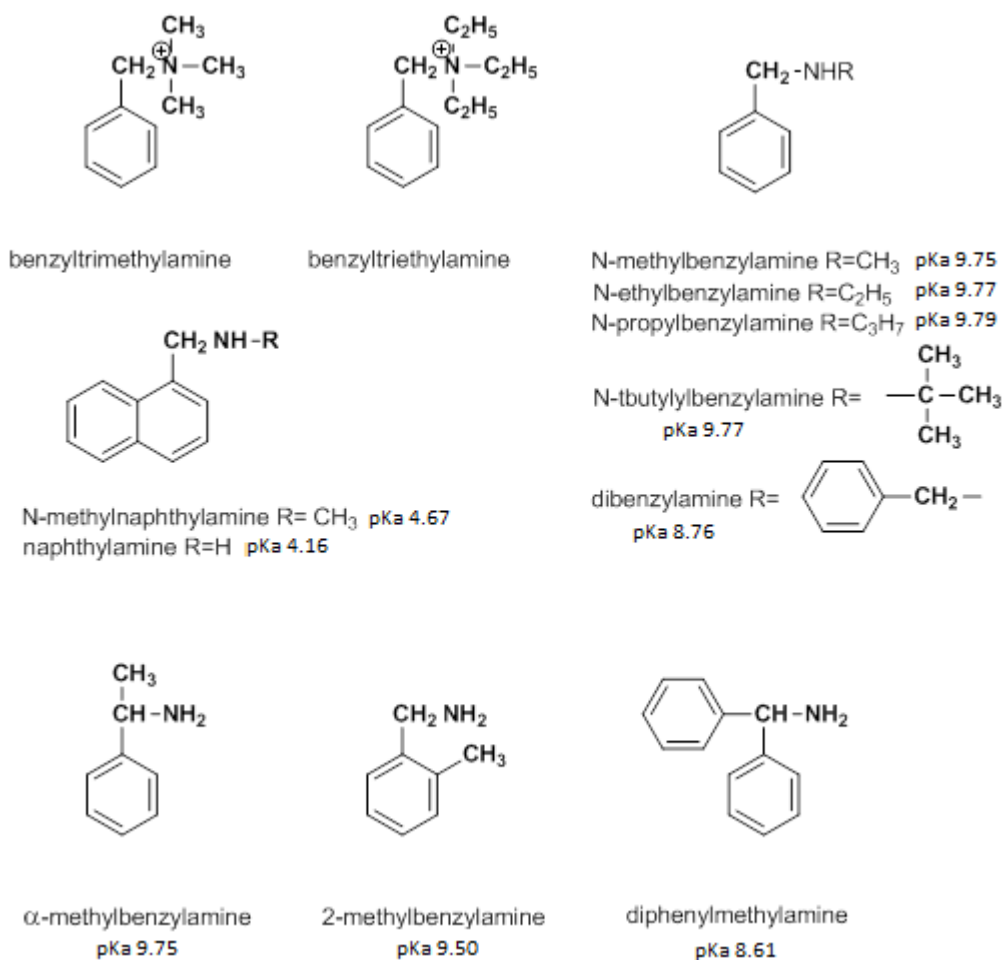
Analyses were carried out on an ACE silica column (150 x 4.6 mm x 3  $\mu\text{m}$ , surface area 300  $\text{m}^2 \text{g}^{-1}$ , pore size 100 Å) and a Cogent Type C silica column (150 x 4.6 mm, 4  $\mu\text{m}$ , base silica surface area 350  $\text{m}^2 \text{g}^{-1}$ , pore size 100Å) which were obtained from HiChrom Ltd., Reading U.K. The mobile phases used were either 0.1% v/v (22 mM) formic acid in water (A), 0.1 % v/v formic acid in acetonitrile (B) or 10 mM ammonium acetate in water (A) and acetonitrile (B). For analysis of the bases a Thermo Separations P4000 pump with a UV 6000 PDA detector and flow rate of 1 ml/ min was used with gradient between 20% A 80% B 0 min and 80% A 20% B 30 min. For the sugars and acids a Thermo Scientific Accela HPLC pump was used and the gradient was 20% A 80% B (0 min) to 50% A 50% B (12 min) to 50% A 50% B (26 min) with a flow rate of 0.3 ml/min and detection was carried out with an Orbitrap Exactive mass spectrometer as described previously [109]. The instrument was calibrated according to the manufacturer's instructions just before commencing the experiment, and was internally calibrated by lock masses (positive ion mode  $m/z$  83.06037 and  $m/z$  195.08625, due to acetonitrile dimer and caffeine respectively; and negative ion mode 91.00368 due to formic acid dimer).

## **3.3 Results**

### **3.3.1 Chromatography of basic test probes on silica gel and type C silica.**

Some of the basic test probes studies in chapter 2 (figure 3.1) were used to study the differences in separation mechanism between the bare silica and the silicon hydride stationary phase. The different between these phases is that the OH group present on the surface of silica gel has been replaced with H.

Figure 3-1 Basic compounds used to test silica gel and the type C silica column.



In Table 3.1 the results can be seen where 0.1% v/v formic acid was used as the mobile phase modifier. The retention times of organic bases on silica gel were quite short under these conditions and all very similar, all eluted around 4.5 minutes. At low pH all the bases are 100% ionised since they are all well below their pK<sub>a</sub> values. However, at low pH the degree of ionisation of silanol groups is low and thus the ion-exchange interactions of negatively charged silanol groups with the bases are weak. On the type C silica column the retention times of most bases are around 7.5 min. with 0.1% v/v formic acid as the mobile phase modifier. The silanol content of the surface of the type C silica column is < 2%

according to the manufacturers. The two quaternary amines benzyltriethylamine and benzyltrimethylamine are retained to a greater extent than the other amines on the type C silica column, although these compounds cannot hydrogen bond since this requires the availability of a lone pair on the nitrogen atom. Other modes of interaction available to quaternary ammonium compounds are ion exchange and ion-dipole interactions.

**Table 3.1 Retention times of bases on silica gel and type C silica with 0.1% v/v formic acid modifier.**

Compounds	tr (min) Silica FA	tr (min) Cogent C FA
benzyltrimethylamine	5.0	9.1
benzyltriethylamine	4.8	9.0
N-methylbenzylamine	4.8	7.5
N-ethylbenzylamine	4.7	7.5
N-propylbenzylamine	4.5	7.3
N-tert-butylbenzylamine	4.5	6.9
dibenzylamine	4.4	6.7
N-methylnaphthylamine	4.5	7.2
2-methylbenzylamine	4.8	7.3
$\alpha$ -methylbenzylamine	4.8	7.4
naphthylamine	4.4	7.2
diphenylmethylamine	4.3	6.8

The retention times of the bases when ammonium acetate was used as the mobile phase modifier can be seen in Table 3.2. At the pH of the ammonium acetate (6.5 in water), it would be expected that the silanol groups on silica gel would be extensively ionised and thus ion exchange interactions between the basic probes and the surface of silica gel would

be strong. On silica gel the bases behave in a way which is characteristic of ion exchange interactions, although it is not possible to entirely rule out interaction with an adsorbed water layer. Thus benzyltrimethylamine and benzyltriethylamine, which are 100% charged at all pH values, are most strongly retained. The smaller benzyltrimethylamine charged centre has a higher charge density than benzyltriethylamine and thus it would be more strongly retained by its ion exchange interaction with silanol groups. On the Cogent Type C silica column these compounds do not elute within the 30 minute gradient. This would suggest a very strong ion exchange interaction or a very strong ion-dipole interaction with water associated with the phase. In contrast with these results the developers of this phase have proposed that there is little potential for silanophilic activity [10, 102] because the silanol groups have largely been replaced by Si-H groups. The other amines shown in figure 3.1 have varying degrees of hydrophobicity. The secondary amines N-methylbenzylamine, N-ethylbenzylamine, N-propylbenzylamine, N-tertiarybutylbenzylamine and dibenzylamine elute from silica gel in the order than would be expected for an ion-exchange interaction where the interaction is strongest for the smallest, most densely charged, ion which in this case is N-methylbenzylamine. The pattern is similar on the type C silica column except that the retention is considerably stronger than on the silica gel column. Dibenzylamine elutes earliest from the type C silica column although it is much more lipophilic than for instance N-methylbenzylamine (table 3.2) and this indicates that hydrophobic interactions, which have been proposed to play a role in retention on silicon-hydride surfaces, are not important in the retention of ionised bases. The primary amines in the set are somewhat less retained on silica gel and type C silica than the secondary amines, which is consistent with them being slightly weaker bases. As can be seen in Figure 3.2 the peak shapes for the

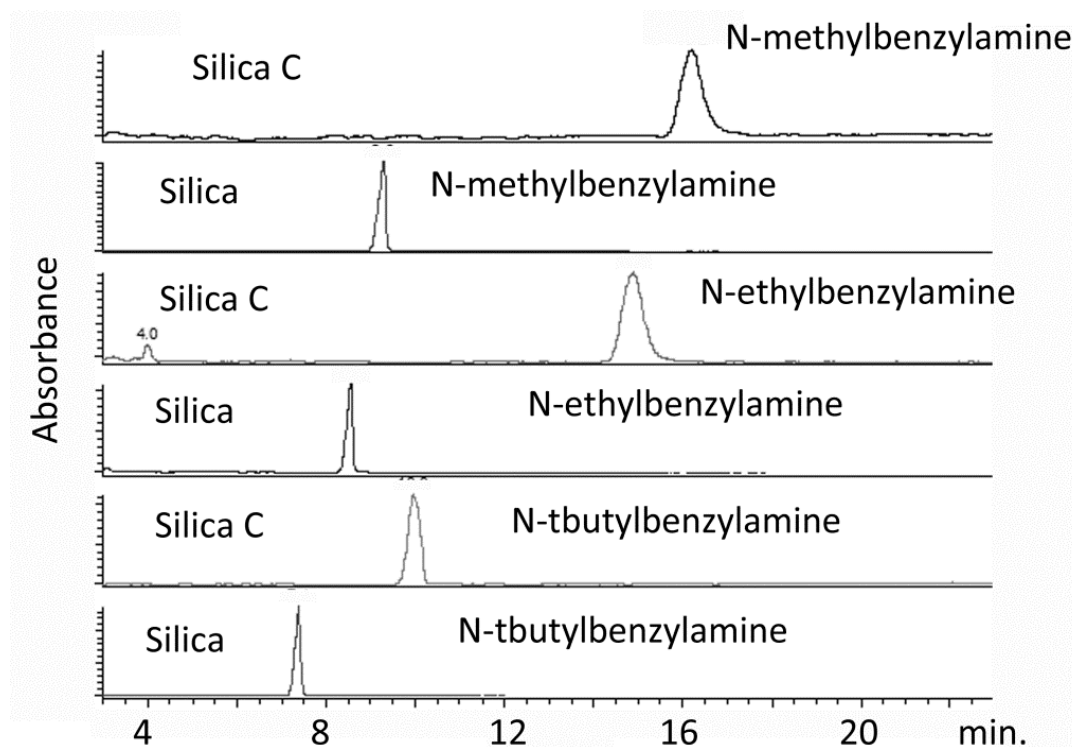
bases were good both on silica gel and type C silica in HILIC mode, the peak shapes for the bases were also good when 0.1% v/v formic acid was used as the mobile phase modifier.

**Table 3.2 Retention times of bases on silica gel and type C silica with 10 mM ammonium acetate buffer/acetonitrile.**

Compounds	tr (min.) Silica AA	tr (min.) Cogent C AA
benzyltrimethylamine	11.3	-
benzyltriethylamine	9.9	-
N-methylbenzylamine	9.3	16.3
N-ethylbenzylamine	8.6	14.9
N-propylbenzylamine	8.0	13.4
N-tert-butylbenzylamine	7.4	10.0
dibenzylamine	5.1	7.1
N-methylnaphthylamine	8.0	11.5
2-methylbenzylamine	7.9	12.4
$\alpha$ -methylbenzylamine	8.1	12.7
naphthylamine	7.4	10.6
diphenylmethylamine	3.0	5.4

- Retained > 30 min.

**Figure 3-2 HPLC-UV chromatograms for some basic test compounds on type C silica and silica gel columns using mobile phase A 10 mM ammonium acetate in water, mobile phase B acetonitrile, flow rate of 1 ml/ min, gradient 20% A 80% B 0 min and 80% A 20% B 30 min. UV detection at 254 nm.**

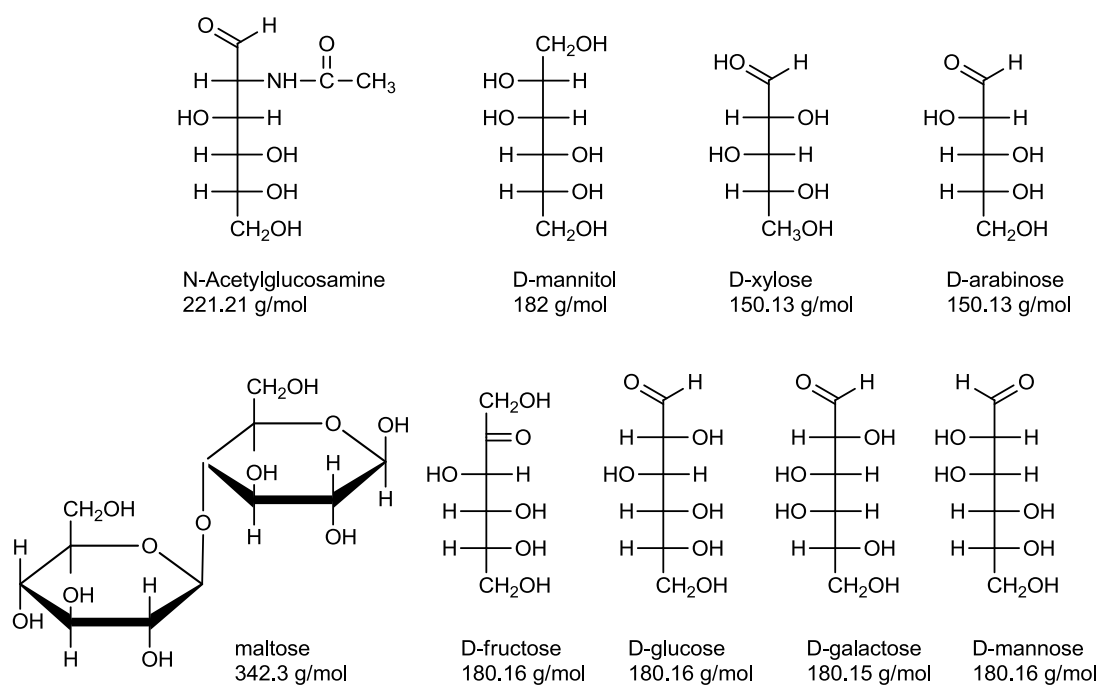


### 3.3.2 Chromatography of sugars on silica gel and type C silica

Sugar molecules are highly hydrophilic neutral molecules and are not affected by pH with regard to their degree of ionisation except at very high pH values. A selection of sugars (figure 3.3) was used to test the retention characteristics of silica gel and Silica C. On silica gel sugars were more strongly retained at low pH with formic acid as the modifier (Table 3.3) suggesting that the silica gel surface may associate with water to a greater extent at low pH, at higher pH values silanol groups might associate to a greater extent with the ammonium ions thus reducing the amount of water at the silica gel surface. Maltose, which would be expected to be the most hydrophilic sugar, as judged from comparisons of mono-

and disaccharide partition coefficients [110], was the most strongly retained sugar in the set. Sugars were retained to a similar extent on type C silica as on silica gel at low pH but became more strongly retained when ammonium acetate was used as the mobile phase modifier, in contrast to silica gel where the retention time was lower at the higher pH (table 3.3).

**Figure 3-3 Sugar compounds used to test silica gel and type C silica columns.**





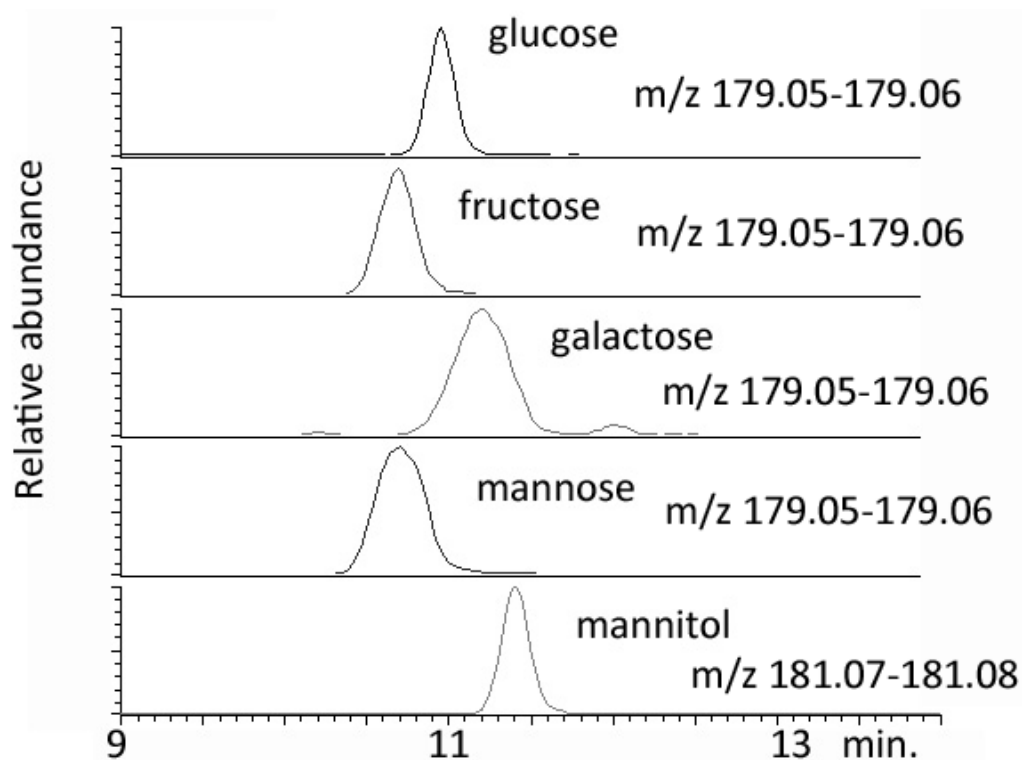
**Table 3.3 Retention times of sugars on silica gel and type C silica columns with 10mM ammonium acetate buffer and 0.1 % formic acid buffer.**

Sugars	Silica FA	Silica AA	Type C Silica	Type C silica
	tr min.	tr min.	FA tr min.	AA tr min.
glucose	9.6	7.3	9.7	11.0
fructose	9.7	7.4	9.6	10.7
xylose	6.8	7.2	8.8	9.5
arabinose	9.5	8.5	9.7	10.7
galactose	10.0	8.2	10.1	11.2
mannose	9.8	8.6	9.2, 9.9	10.7
mannitol	10.2	8.3	10.3	11.6
N-acetylglucosamine	9.8	8.1	10.1	11.0
maltose	10.7	8.4	10.7	12.2

The peak shapes of the sugars were quite good (figure 3.4) although as expected there was some broadening due the equilibration between pyranose and furanose forms and  $\alpha$ - and  $\beta$ - anomers which takes place when sugars are in solution. The best peak shape in figure 3.4 can be seen for mannitol which unlike the alditols does not have multiple stereoisomeric forms. Although the retention of these compounds was good on the silica C column it was only possible to obtain partial resolution of the four common hexoses, glucose, mannose, fructose and galactose, in mixtures even when a 25 cm column was used. However, if UHPLC

columns were available with this packing, so the smaller particle size can be use and this will increase the efficacy, resolution of these mixtures might be possible. These groups of isomers are a critical group in metabolomics studies where high resolution mass spectrometry allows confidence in elemental composition but chromatographic separation is required to distinguish isomers.

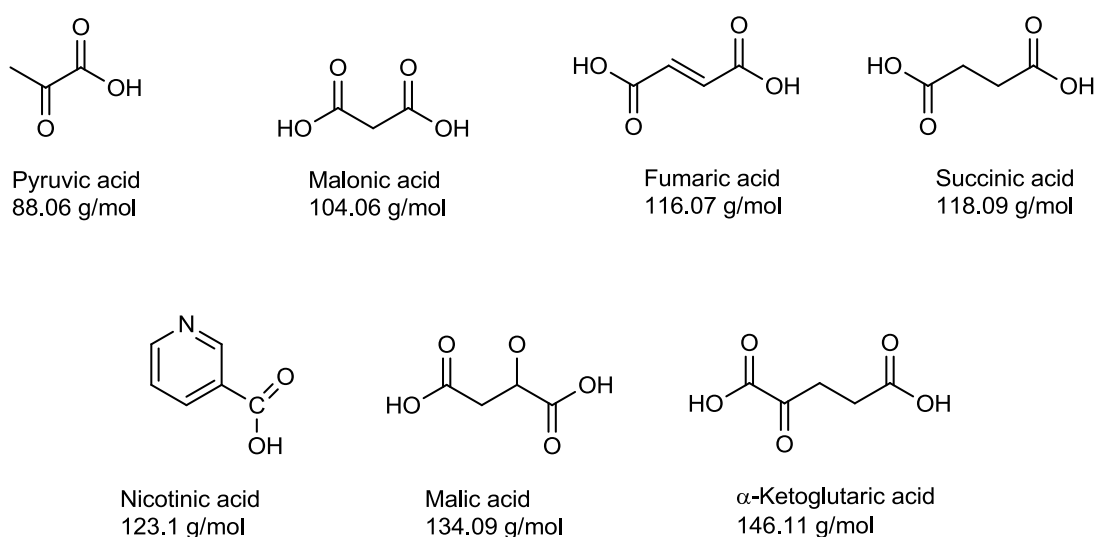
**Figure 3-4** Extracted ion chromatograms for some sugars on a type C silica column with A 10mM ammonium acetate in water, mobile phase B acetonitrile, flow rate of 0.3 ml/ min. Gradient: 20% A 80% B ( 0 min) to 50% A 50% B (12 min) to 50% A 50% B (26 min). Detection FT-MS in negative ion mode.



### 3.3.3 Chromatography of acids on silica gel and type C silica

In order to complete the picture of the differences between the silica and the silicon hydride column, the different properties of an acidic compound (figure 3.5) tested with the bare silica and the silicon hydride column.

**Figure 3-5 Acidic compounds used to test silica gel and type C silica columns.**



The acids were only weakly retained on silica gel (table 3.4) at low pH presumably because their partitioning into the water layer on the silica gel is lower in their less ionised state.

With ammonium acetate as the mobile phase modifier, where the acids are more ionised, the retention of the acids on silica gel was stronger although peak shapes were sometimes not good, possibly because of charge repulsion of the ionised acid by negatively charged silanol groups. Figure 3.6 shows chromatograms for some acids on the type C silica column.

The acids were retained more strongly on the type C silica column in the ammonium acetate containing mobile phase in comparison with when formic acid was the modifier. Retention

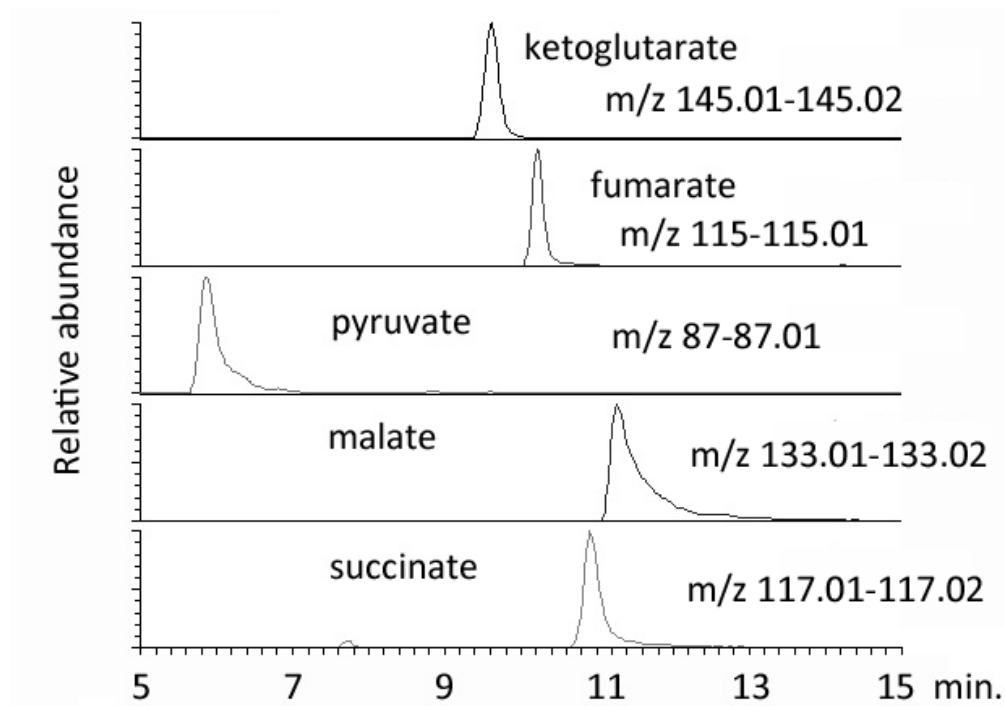
was largely as would be predicted from the polarity of the acid. Malic acid is the most polar acid shown in figure 3.5 and is most retained by the type C silica column, although it is tending to lose peak shape. The peak shape for the highly polar acid citrate was very poor on this phase.

**Table 3.4 Retention times of acids on silica gel and type C silica columns with 10 mM ammonium acetate buffer and formic acid buffer.**

Acids	Silica FA	Silica AA	Type C Silica	Type C silica
	tr min.	tr min.	FA tr min.	AA tr min.
malate	3.0	6.6	6.5	11.4
fumarate	2.8	5.4	5.9	10.2
succinate	2.9	6.1	6.1	11.2
malonate	3.0	3.7	6.5	10.8
pyruvate	7.0	7.9	-	5.9
ketoglutaric	3.0	4.6	6.1	9.6
nicotinate	3.5	4.1	8.7	10.1

- Peak not observed within the 45 minute run time.

Figure 3-6 Extracted ion chromatograms for acidic compounds on type C silica. A 10mM ammonium acetate in water, mobile phase B acetonitrile, flow rate of 0.3 ml/ min. Gradient: 20% A 80% B ( 0 min) to 50% A 50% B (12 min) to 50% A 50% B (26 min). Detection FT-MS in negative ion mode.



### 3.4 Conclusion

The behaviour of the type C silica surface is very different from that of the silica gel surface and cannot at the current time be completely explained, in particular it is difficult to explain the pH dependence of analyte retention. The behaviour of the column is consistent with high silanol activity but it is difficult to work out why the surface should have apparently higher silanol activity than bare silica gel. Even if the type C silica surface completely hydrolysed back to bare silica gel it could only have similar characteristics to bare silica gel. The originators of the phase have demonstrated using a variety of physicochemical and

spectroscopic techniques that almost all of the silanol groups on the original silica gel are removed by the silanisation procedure [10]. That is not say that the low number of remaining silanol groups do not have some unusual property but on the basis of the current work further discussion is merely speculation. Essentially the type C silica gel behaves differently from silica and highlights an exciting new aspect of chromatographic behaviour of silica gel which remains to be explored in greater depth. Although the surface modified type C silica columns, such as the Cogent Diamond Hydride column, have been more widely used [102-104]. A recent study focused on the separation of flavonoids on the Cogent Silica C column and three type C silica columns modified with alkyl chains. It was found that with <20% water in the mobile phase interactions with the type C silica surface predominated, between 20% and 55% there were mixed interactions with some contribution from the alkyl chains and with >60% water a reversed phase partition mechanism predominated [13]. These results to some extent reflect the current results and it is apparent that the simple type C silica surface represented by the packing in the Cogent Silica C column is very useful as it stands without any further modification. The column appears to be very stable and its behaviour remains well differentiated from the retention properties of bare silica gel even after extensive use. The type C silica surface is said to provide aqueous normal phase chromatography but in fact the boundaries between this type of chromatography, ion exchange chromatography based on interaction with silanol groups and HILIC are quite blurred. However, the type C silica column technology provides a useful complementary method to established HILIC methods that we have found valuable in metabolomics studies [109]. The possibilities for modifying the type C silica surface are extensive via hydrosilation reactions

## **Chapter 4**

### **|Comparison of Seven Different Columns For the Screening of Metabolites in Metabolomic Screening**

## 4.1 Introduction

Liquid chromatography mass spectrometry (LC-MS) arrived sometime after nuclear magnetic resonance (NMR) spectroscopy and gas chromatography mass spectrometry in the field of metabolomics. In the last ten years there has been a rapid growth of the applications of LC-MS in metabolomics [1-6]. An important part of getting optimal performance from a mass spectrometer is in the choice of HPLC column and also the choice of mobile phase composition. The widest coverage of the metabolome generally requires the use of more than one column type. Studies at Strathclyde have used ZICHILIC columns extensively in metabolomics screening [7-12] but in order to obtain maximum coverage of the metabolome it may be necessary to use several column systems. This chapter focuses on the application of several different columns with regard to assessing their selectivity for standard mixtures of metabolites. The columns as then assessed with regard to their ability to separate compounds in the urinary metabolome. Seven columns were compared with regard to their ability to retain and separate 100 biomolecules. The columns compared included: unmodified silica gel, a type C silica column, two surface modified Type C silica, one surface modified with Octadecyl chains, the Cogent Diamond Hydride column and a column with a  $\beta$ -pinene modified surface prepared "in house"; a Luna HILIC column; a Luna Amino column; a Nucleodur HILIC column and an ACE Silica Gel column.

Luna HILIC is manufactured by the Phenomenex Company which offers a chemically stable diol stationary phase which is bonded to the silica gel surface and stabilised by cross linking. The stabilizing effects of ethylene bridges provides flexible covalent bonds that are robust enough to withstand harsh conditions that would cause most other diol phases to bleed,



attractive water layer retention and provide non pH dependent hydrogen bonding that is important to the HILIC retention mechanism. The stationary phase is classified as neutral and was developed to overcome the stability issues with the normal diol phases. The silanol group in Luna HILIC phase is less effective in the separation mechanism as it seems that the silanol groups are shielded by the layer of cross linked diol phase [45].

The Luna NH<sub>2</sub> phase is also manufactured by Phenomenex and it is a polyamine phase, which is cross linked and contains primary and secondary amine groups. Luna NH<sub>2</sub> provides reproducible retention and selectivity with improved column lifetime. The bonded phase stability of Luna NH<sub>2</sub> is illustrated by the 1.5 to 11.0 pH stability and 100 % aqueous mobile phase stability. Normal amino columns can be problematic as the bonded phase easily hydrolyses off the silica, shortening retention time over the life of the column [45].

The Nucleodur HILIC stationary phase is prepared from type B silica which offers a totally spherical particle shape, outstanding surface microstructure, high pressure stability and low metal content. It is a Zwitterionic phase where a ligand containing a quaternary ammonium group and a sulfonic acid group is bonded to the silica gel surface. It is similar to the ZIC-HILIC column however the bonding density may be different since the Nucleodur HILIC phase has a 7% carbon content while the ZICHILIC column has approximately 10% carbon content [111].

The Diamond Hydride stationary phase is classified as type C silica where the entire silanol group in the stationary phase has been replaced by silicon hydride and after that a C18 group is linked to the Si-H via hydrosilation [45].

## 4.2 Materials and Methods

### 4.2.1 Chemicals and Reagents

HPLC grade acetonitrile was obtained from Fisher Scientific (Loughborough, UK). Water was obtained from a Milli-Q water-purification system (Millipore, Watford UK). All other chemicals and standards were obtained from Sigma-Aldrich (Poole, UK). Bare silica gel for surface modification was a gift from HiChrom UK, Ltd.

### 4.2.2 Chromatography Columns and LC-MS

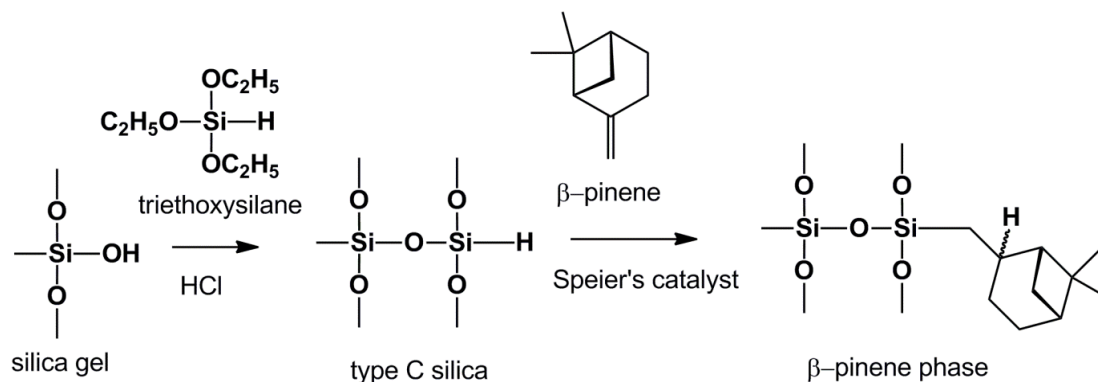
Analyses were carried out on an ACE silica column (150 x 4.6 mm, 3  $\mu\text{m}$ , surface area 300  $\text{m}^2 \text{g}^{-1}$ , pore size 100  $\text{\AA}$ ), a Cogent Type C silica column (150 x 4.6 mm, 4  $\mu\text{m}$ , base silica surface area 350  $\text{m}^2 \text{g}^{-1}$ , pore size 100 $\text{\AA}$ ), a Cogent Diamond Hydride column (150 x 4.6 mm, 4  $\mu\text{m}$ , base silica surface area 350  $\text{m}^2 \text{g}^{-1}$ , pore size 100 $\text{\AA}$ ), a Nucleodur HILIC column (150 x 4.6 mm, 3 $\mu\text{m}$ ) which were obtained from HiChrom Ltd., Reading, U.K. A Luna HILIC column (150 x 4.6 mm, 3 $\mu\text{m}$ ) and a Luna Amino column (150 x 4.6 mm, 3 $\mu\text{m}$ ) which were obtained from Phenomenex (Macclesfield, U.K.). In addition a  $\beta$ -pinene bonded type C silica column was prepared as described below. LC-MS was carried out as described in section 3.2.2.

### 4.2.3 Synthesis of $\beta$ -pinene modified type C silica

The reaction was based on a previously described two-stage procedure [10] summarised in Figure 4.1. Briefly the synthesis was as follows: Stage 1: A solution containing 0.5 M triethoxysilane in dioxane was prepared (solution A). Dried silica gel (5  $\mu\text{m}$ , 100  $\text{\AA}$ , 300  $\text{m}^2 \text{g}^{-1}$  8 g) was stirred in dioxane (160 mL) and then 11.2 mL of 2.3 M HCl solution was added. The mixture was then heated to 70-80 $^\circ\text{C}$ , then 72 mL of solution A was added dropwise over 20 minutes and gently refluxed for one hour. The hydrosilated silica gel was isolated and dried in a vacuum oven. Stage 2: Hexachloroplatinic acid (0.2 g) was dissolved in 50 ml of

isopropanol and then 2 mL of the catalyst solution was added to 75 ml of  $\beta$ -pinene in a round bottom flask. The solution was heated and stirred for one hour at 70°C as the silica hydride (5 g) was slowly added. The mixture was then heated at 100°C for 48 hours. After cooling, the  $\beta$ -pinene modified type C silica was filtered and washed with organic solvents. The  $\beta$ -pinene modified silica hydride was dried in a vacuum oven. The type C silica intermediate and the final  $\beta$ -pinene modified silica hydride were characterised by diffuse reflectance infra-red by using an Agilent 4100 ExoScan hand-held FTIR revealing good surface coverage by the type C silica and finally the  $\beta$ -pinene ligand. The derivatised type C silica was slurry packed into a 150 x 4.6 mm column by HiChrom Ltd.

**Figure 4-1 Reaction scheme showing the synthesis of type C silica and then formation of a  $\beta$ -pinene phase via hydrosilation.**



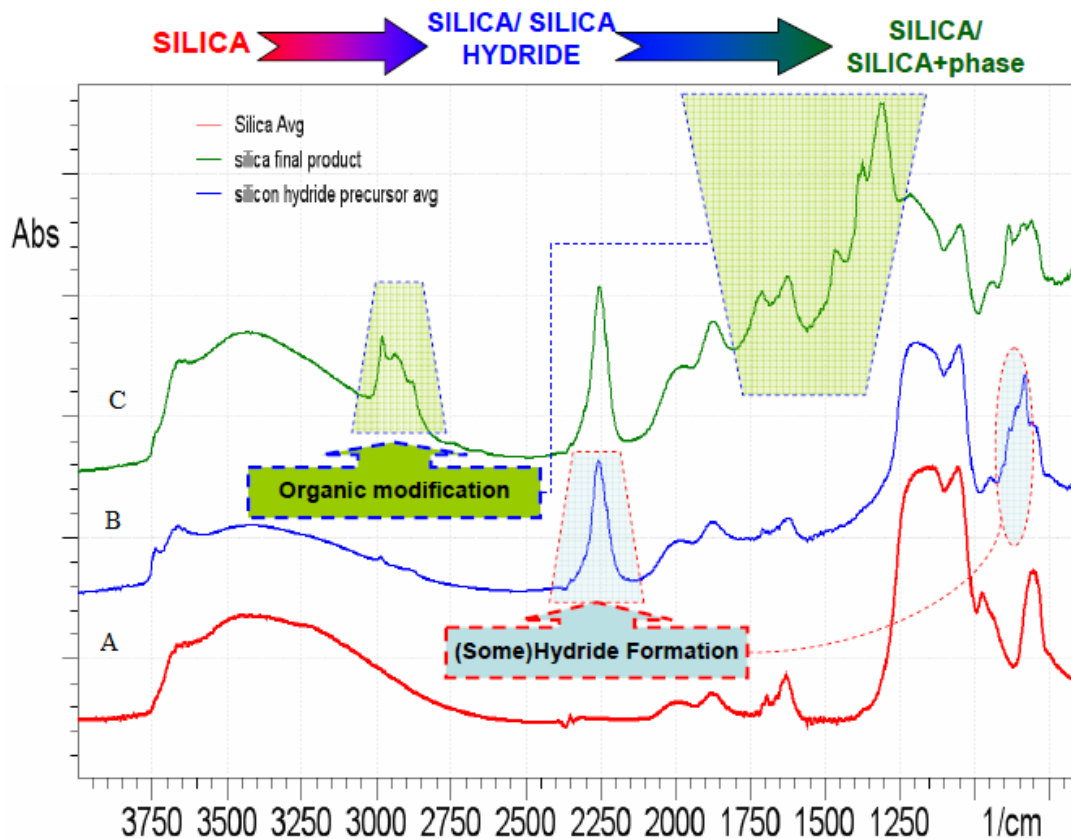
## 4.3 Results

### 4.3.1. Confirmation of the $\beta$ -pinene linkage to the stationary phase.

In order to confirm the conversion of the un-modified silica to silicon hydride and also the binding of the  $\beta$ -pinene to the silica hydride phase diffuse reflectance Fourier Transform Infrared spectrophotometry (FTIR) was used. Figure 4.2 shows FTIR spectra for the A) un-

modified silica, B) silicon hydride modified silica gel and C)  $\beta$ -pinene bonded to the silicon hydride. In figure 4.2 part A, the pure silica has no band *ca* 2250  $\text{cm}^{-1}$ . The covering of the Si-OH group by Si-H group was successful as the FTIR shows an additional absorption band at 2260  $\text{cm}^{-1}$  due to Si-H stretching (Figure 4.2 part B). Finally the bonding of the  $\beta$ -pinene to gave a clear band *ca* 3000  $\text{cm}^{-1}$  due to C-H stretching (figure 4.2 part C) which confirmed the bonding of the  $\beta$ -pinene to the modified phase (silicon hydride). However, there were clearly unbound Si-H groups remaining within the phase as evidenced by absorption *ca* 2250  $\text{cm}^{-1}$  (Figure 4.2 part C).

**Figure 4-2 A) pure silica, B) silicon hydride and C)  $\beta$ -pinene bonded to the Si-H phase scanned by Fourier transform infrared spectroscopy (Exoscan 4100) instrument.**



### ***4.3.2 Analysis of Metabolite Standards on Seven HILIC Columns***

Table AII.1 in appendix II (page 192) summarises the data for 100 metabolites analysed on the seven HILIC columns. The columns exhibited different types of selectivity. In general the hydride columns exhibited the highest retention of the polar metabolites along with the Nucleodur column which is a zwitterionic column. Figure 4.3 shows the retention of the moderately lipophilic amino acid proline on the 7 columns in 0.1% v/v formic acid. The greatest retention is on the Cogent Diamond Hydride column followed by the Cogent Silica column.

The silica gel column is more retentive than the Luna HILIC column suggesting that most of the HILIC properties of the Luna HILIC column, which is surface coated with glycol groups, is due to the underlying silica gel which in the case of the Luna HILIC column is partly masked by the surface ligand. The amino column at this pH should exhibit ion exchange interactions with the carboxyl group in proline but does not retain proline to any greater degree than bare silica gel reflecting some neutralisation of its negative charge by the charge on its amine group.

**Figure 4-3** Extracted ion traces for proline on 7 HILIC columns with 0.1% v/v formic acid as the mobile phase modifier. Conditions as in section 3.2.2.

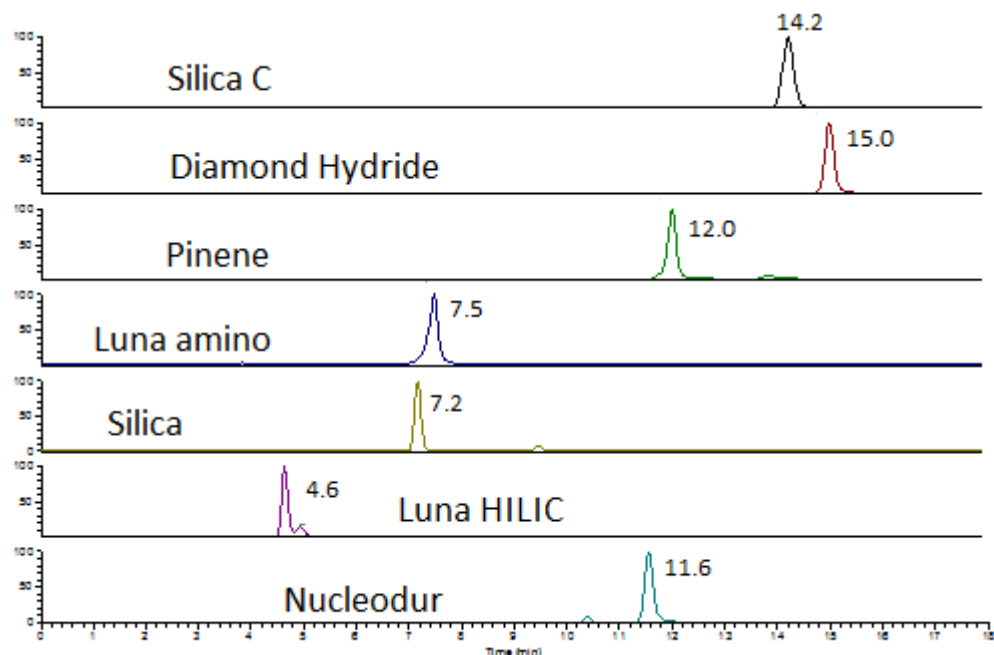
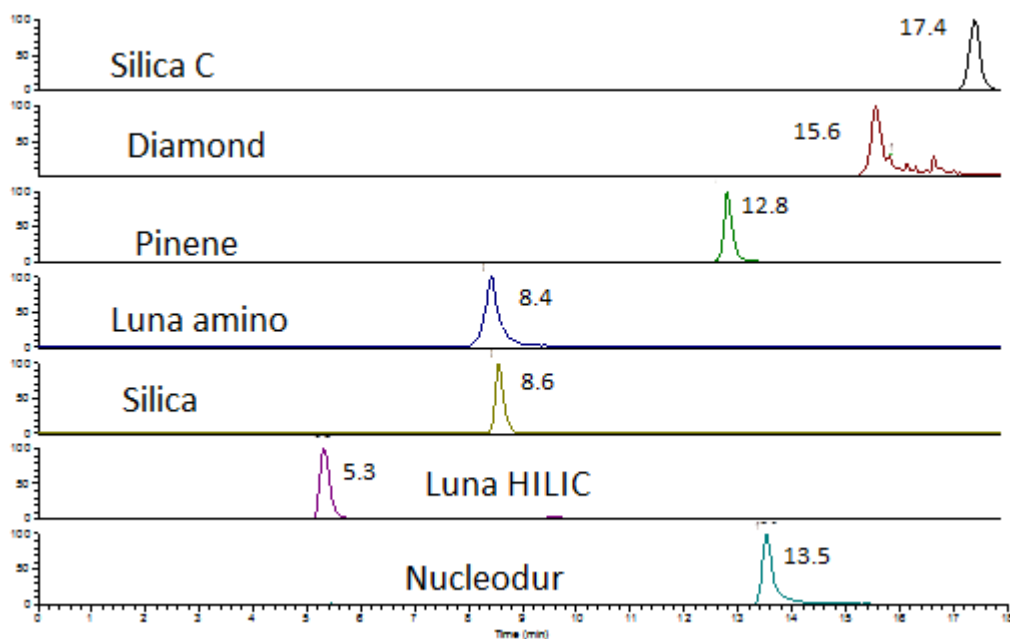


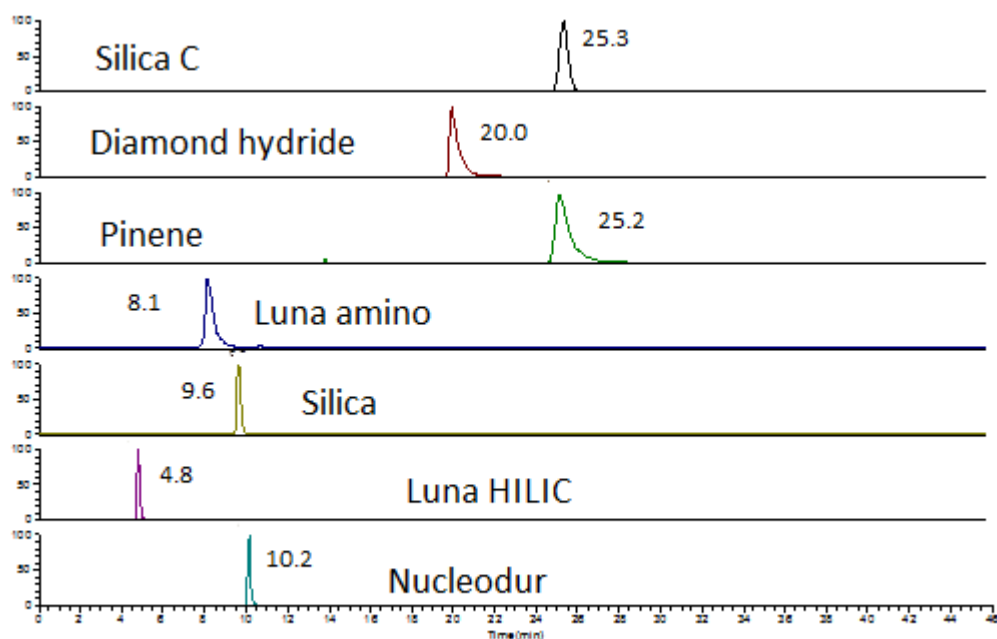
Figure 4.4 shows the effect of raising the pH of the mobile phase by using ammonium acetate as the mobile phase modifier on the retention of proline. There are three factors to consider the degree of ionisation of silanol groups increases with pH, the degree of ionisation of the carboxylic acid group in proline increases with pH and the degree of ionisation of the amine group in proline decreases. The retention time of the proline on the Cogent Silica C column increases the most with pH, interaction could be with either the acidic or amine groups of proline, as seen in chapter 3 the retention of acids and amines increases on this phase with pH. There is less increase in retention time on the Pinene and Cogent Diamond Hydride phases because the Si-H groups are partly masked by the ligands bonded to the silica gel. There is a small increase in retention of proline on silica gel indicating increased interaction of silanols with the amine group in proline. There is a small increase in retention on the Nucleodur column which might be due to increased interaction of the carboxylic acid group of proline with the positively charged centre of the zwitterion.

**Figure 4-4** Extracted ion traces for proline on 7 HILIC columns with 10 mM ammonium acetate as the mobile phase modifier. Conditions as in section 3.2.2.



In Figure 4.5 extracted ion traces for lysine run on the 7 HILIC columns with 0.1% v/v formic acid as the mobile phase modifier can be seen. Lysine is a basic amino acid with two basic centres and it is strongly retained on all the hydride columns, even under acidic conditions. It is much less retained on the silica gel column since even though there are many silanol groups which the basic centres of lysine could interact with the silanol groups are not extensively ionised under acidic conditions. Again the Luna HILIC column is much less retentive than silica gel. The lysine interacts much less strongly with the Nucleodur column in comparison with the hydride columns and also it interacts with the Nucleodur column less than proline does. This suggests that the basic centres in a molecule may not be the main thing determining retention of the Nucleodur column.

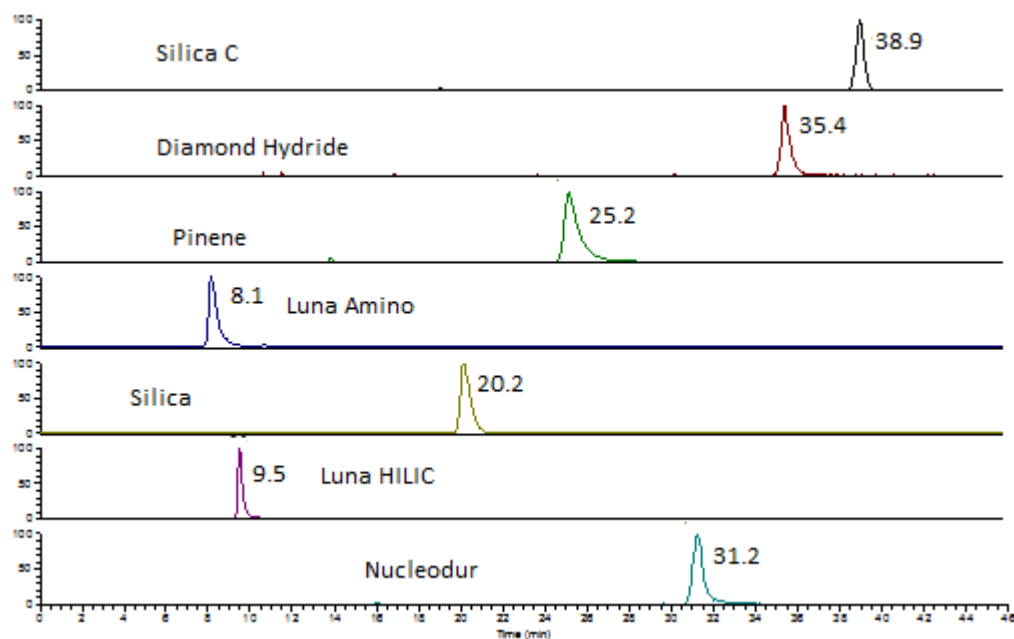
**Figure 4-5** Extracted ion traces for lysine on 7 HILIC columns with 0.1% v/v formic acid as the mobile phase modifier. Conditions as in section 3.2.2.



When the pH of the mobile phase was raised by adding ammonium acetate as modifier then the lysine peak ran later on all the columns. The shift on the silica column reflects increased ionisation of the silanol groups causing greater interaction with the basic centres in lysine (Figure 4.6). There were also large increases in retention time on the hydride column with the Silica C column showing the most marked increase since all of the Si-H groups on the surface are available to interact with lysine, although it is not possible to say at the moment exactly what that interaction is. The retention on lysine on the Luna Amino and the Luna HILIC column are much less affected by increased pH. The Nucleodur column also displays marked effect of pH although, since it is coated with a zwitterion which should have a charge independent of pH, it is difficult to say what type of interaction is causing the increase in retention time.

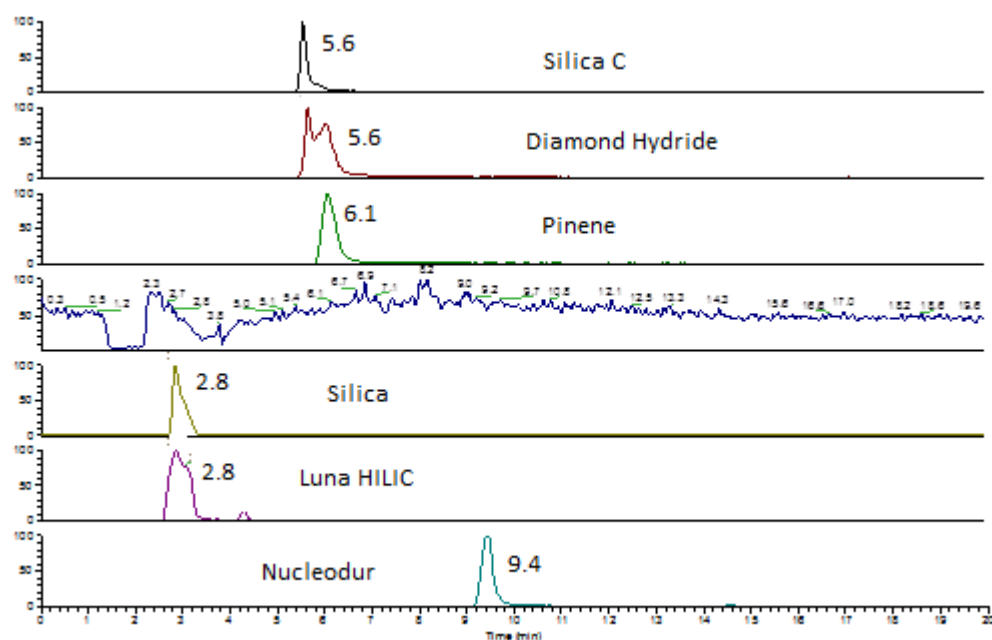


**Figure 4-6** Extracted ion traces for lysine on 7 HILIC columns with 10 mM ammonium acetate as the mobile phase modifier. Conditions as in section 3.2.2.



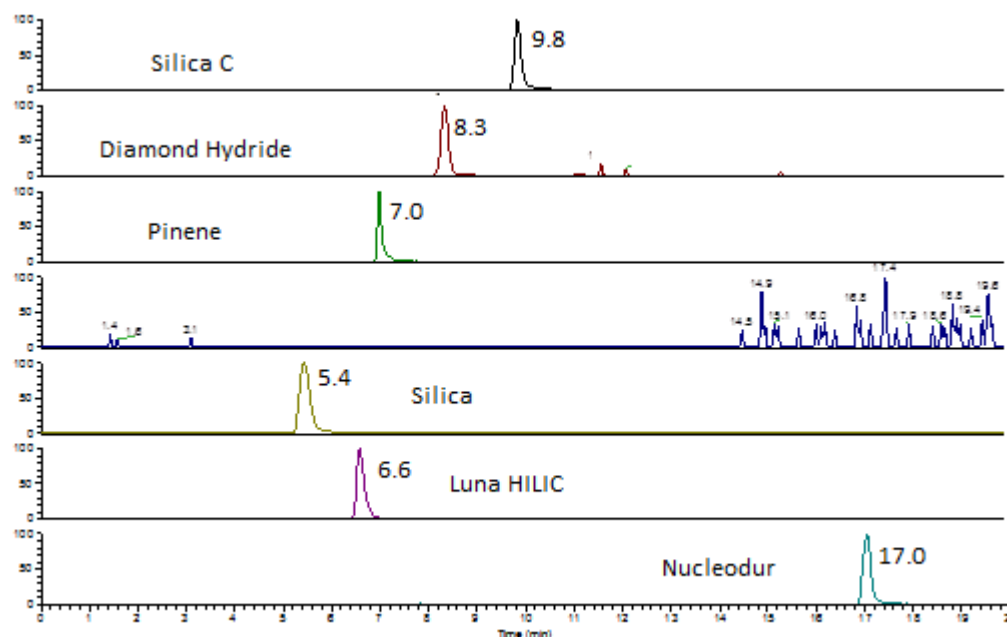
HILIC columns tend to perform less satisfactorily with acids and the best conditions generally require high pH. Fumaric acid eluted quite early from the Silica C and Diamond Hydride columns and gave poor peak shape when 0.1% v/v formic acid was used as the mobile phase modifier (Figure 4.7). The peak shape on the Pinene column was acceptable. Strong ion exchange interactions with the Luna amino column mean that fumaric acid did not elute from this column. The pH would need to be raised to the point where the amino groups on the column are no longer ionised for fumaric acid to elute. Fumaric acid eluted at the void volumes of the silica and the Luna HILIC columns exhibiting little retention. However, the Nucleodur looked as though it might be a useful column for the analysis of organic acids and gave good retention of fumaric acid even under acidic conditions.

**Figure 4-7** Extracted ion traces for fumaric acid on 7 HILIC columns with 0.1% v/v formic acid as the mobile phase modifier. Conditions as in section 3.2.2.



When ammonium acetate was used as the mobile phase modifier all the columns gave good peak shapes for fumaric acid apart from the Luna Amino column where again the acid did not elute. For the hydride columns the retention of fumaric acid reflected the availability of free Si-H groups with retention being strongest on the Silica C column (Figure 4.8). The retention on the Luna HILIC was slightly longer than on silica gel perhaps reflecting the fact that some of the silanol groups on the silica surface are masked so that there is less charge repulsion. Again the Nucleodur column gave good retention and peak shape for fumaric acid.

**Figure 4-8** Extracted ion traces for fumaric acid on 7 HILIC columns with 10 mM ammonium acetate as the mobile phase modifier. Conditions as in section 3.2.2.



In Figure 4.9 the retention of glucose with 0.1% v/v formic acid as the mobile phase modifier can be seen. The hydride columns all gave good peak shape and reasonable retention. The Luna amino column separated the  $\alpha$ - and  $\beta$ -anomers of glucose, this could also be seen for the Nucleodur column which almost resolves the anomers. Retention of glucose on the Luna HILIC and silica gel columns was quite weak. When ammonium acetate was used as the mobile phase modifier the retention time of glucose increased on all the hydride columns with the most marked increase being on the Silica C column (Figure 4.10). None of the other phases were pH sensitive with regard to the retention of glucose. The pH sensitive mechanism of retention of a neutral molecule such as glucose on the hydride columns is difficult to explain.

Figure 4-9 Extracted ion traces for glucose on 7 HILIC columns with 0.1% v/v formic acid as the mobile phase modifier. Conditions as in section 3.2.2.

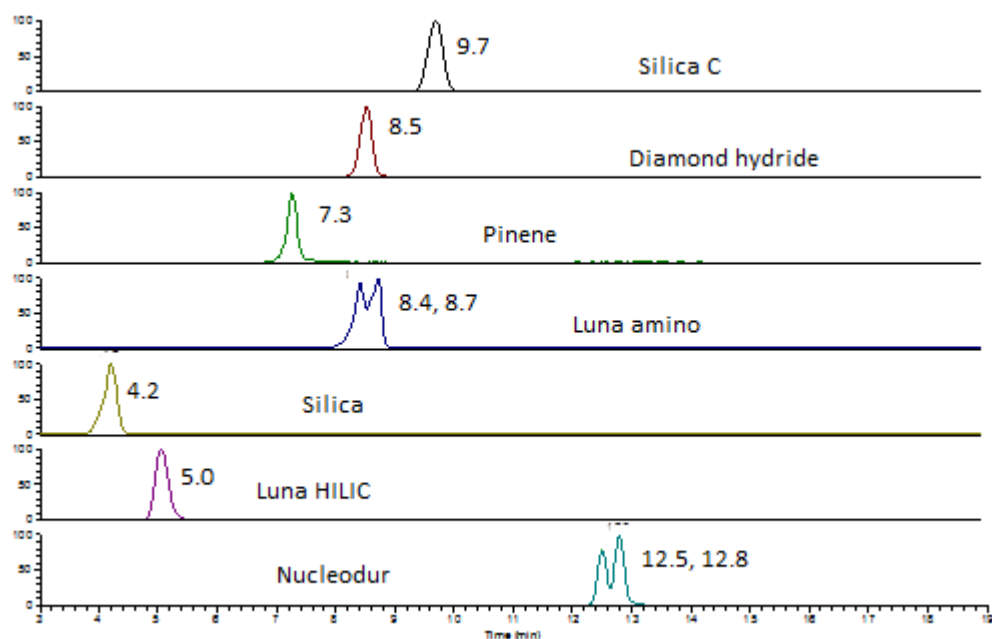
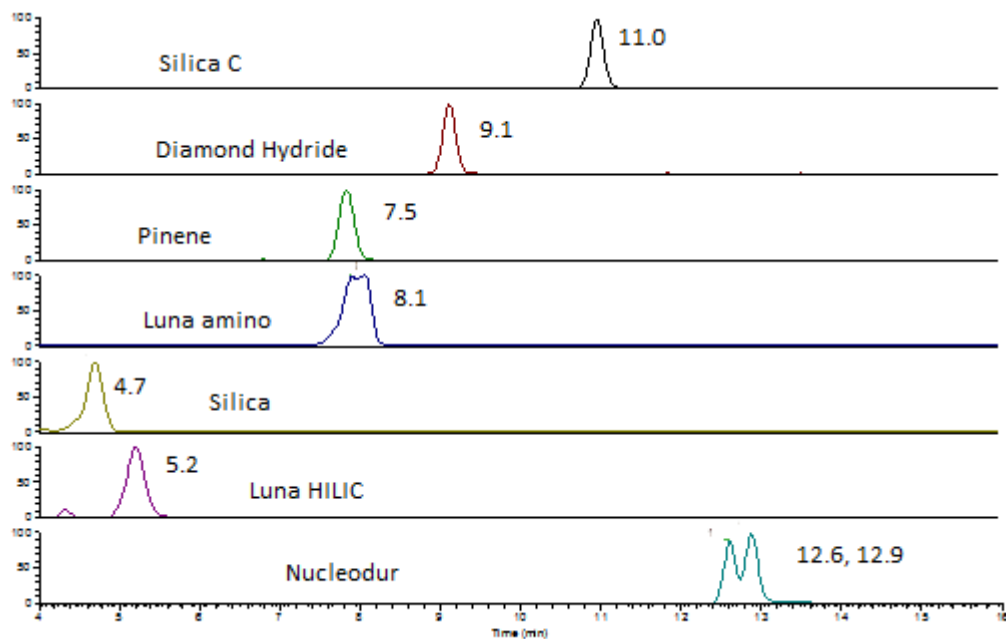
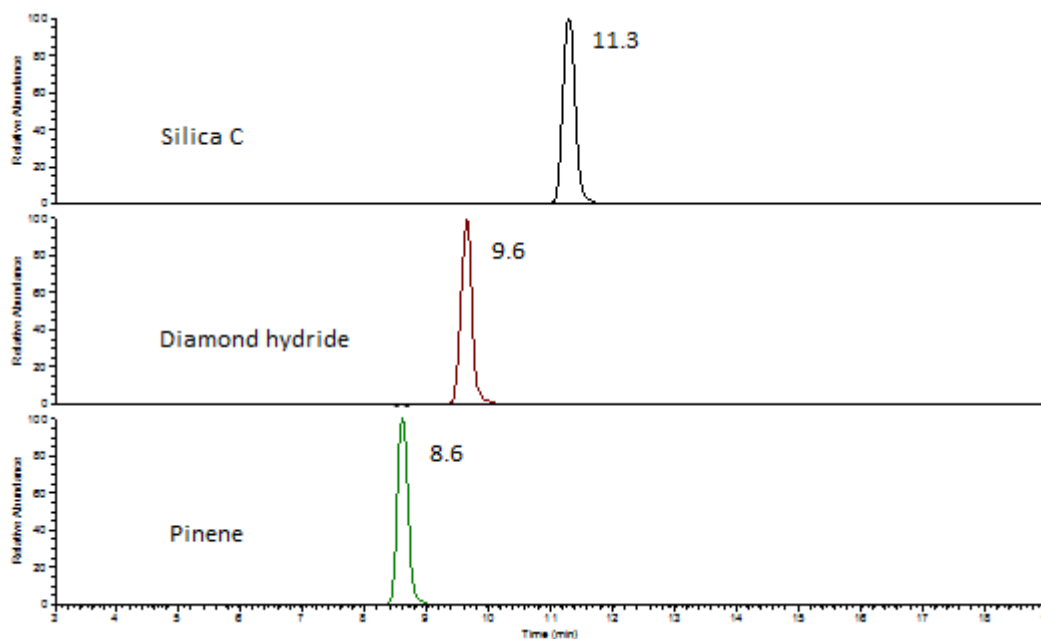


Figure 4-10 Extracted ion traces for glucose on 7 HILIC columns with 10 mM ammonium acetate as the mobile phase modifier. Conditions as in section 3.2.2.



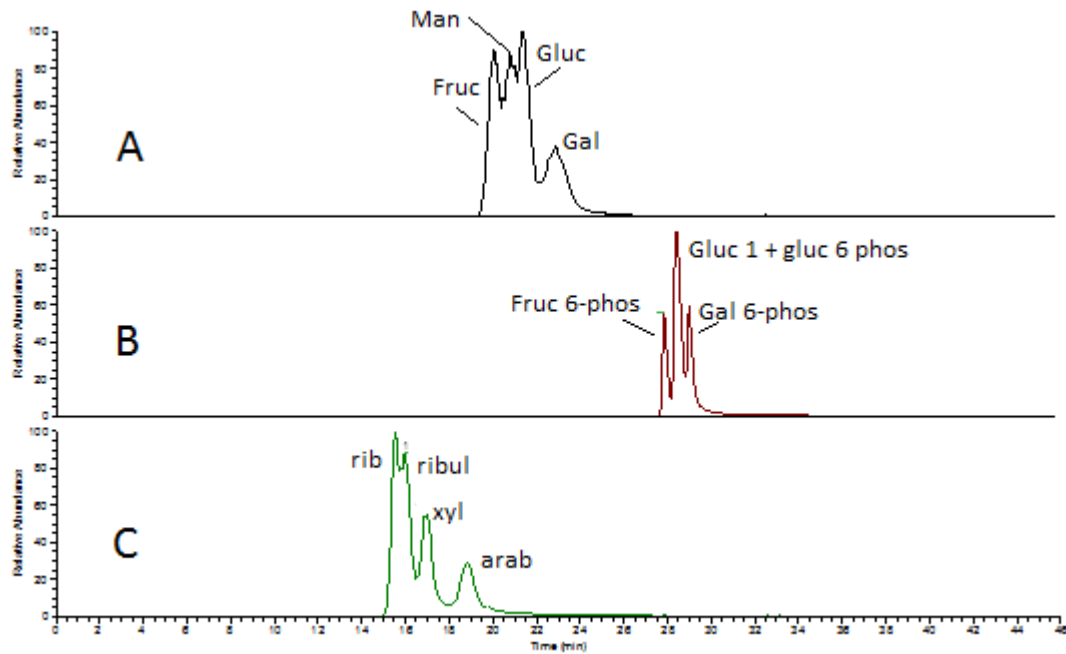
One of the problems in metabolomic profiling is with regard to how to separate isomers of sugars and sugar phosphates. It was observed that the retention of glucose increased still further if the pH of the mobile phase was raised by using the MS compatible mobile phase modifier ammonium bicarbonate (Figure 4.11).

**Figure 4-11** Extracted ion profiles for glucose on the three hydride columns using ammonium bicarbonate as the mobile phase modifier. Conditions as in section 3.2.2.



An attempt was made to see if the Silica C could resolve this problem but as can be seen in Figure 4.12 it was not possible to obtain complete resolution of common sugar isomers even by using a stepped gradient and a 25 cm Silica C column.

Figure 4-12 Extracted ion chromatograms for sugar isomers A: fructose, mannose, glucose, galactose. B: fructose 6-phosphate, glucose 1-phosphate, glucose 6-phosphate, galactose 6-phosphate. C: ribose, ribulose, xylose and arabinose. Conditions: Cogent Silica C column (250 x 4.6 mm, 4 $\mu$ m). A 10 mM aqueous ammonium bicarbonate B Acetonitrile. Time 0 83% B, time 22 70% B, time 35 70% B, 0.3 ml/min.



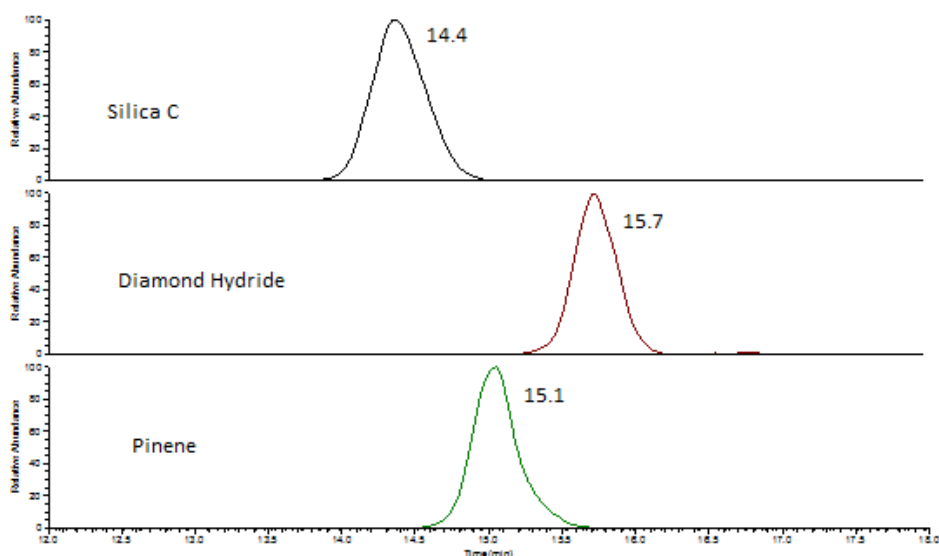
### ***4.3.3 Analysis of urine using three type C silica based columns with FT-MS detection***

The type C silica phase exhibited a good potential for metabolomic screening and it was compared with another commercially available type C silica columns, the Cogent Diamond hydride column, where the type C silica has been modified to bear alkyl chains via hydrosilation, and the “in house” synthesised  $\beta$ -pinene column in the analysis of a urine sample. In a previous study the Cogent Diamond hydride column proved to be very useful for the analysis of polar compounds in urine [104]. Urine contains many metabolites of fatty acids and two extensive series are the acyl glycines and acyl carnitines [109]. On the type C silica column the abundant glycine conjugate hippurate elutes at 7.6 min and, as an example, 3 isomeric butyryl glycines elute at 9.7, 13.0 and 16.2 min, the retention times for these compounds are shorter on the Diamond hydride and  $\beta$ -pinene columns again indicating that the interaction determining degree of retention is with the silicon hydride surface rather than with attached ligands (Table 4.1). The acyl carnitines are very strongly retained by the type C silica column under the conditions used with acetyl carnitine eluting at 28.2 min. Acetyl carnitine elutes at 23 min and 17.4 min on the Diamond Hydride and Pinene columns respectively again indicating that main determinant of retention is interaction with the silicon hydride surface (Table 4.1). Decanoyl carnitine appears to be abundant in urine [109] and this compound is more strongly retained on the Diamond hydride and Pinene columns, which have lipophilic ligands on the silicon hydride surface, than on the type C silica column and this seems to indicate that once a certain degree of lipophilicity is reached this begins to play a more important part in the overall retention mechanism (Figure 4.13).

**Table 4.1 Some acid conjugates representative compounds present in urine giving an indication of the different properties of the three hydride columns. Compounds were identified on mass matching of < 3 ppm . \*=poor peak shape.**

Compound	m/z	Type C silica AA tr min	Diamond hydride AA tr min.	$\beta$ -pinene hydride AA tr min.	Type C silica FA tr min.	Diamond hydride FA tr min.	$\beta$ -pinene hydride FA tr min.
butyryl glycines	144.0667	9.7, 13.0, 16.2	8.0, 11.0, 14.1	6.7, 9.3, 11.6	6.1	6.3, 7.3	6.3, 6.9
hippurate	178.0515	7.6	6.5	5.9	6.0	5.8	6.2
acetylcarnitine $\phi$	204.1231	28.2	23.0	17.4	22.8 *	17.4*	12.7
butyl carnitine	232.1543	24.8	21.5	16.8	26.5*	11.9* 16.3	7.4, 12.4
ferulic acid sulphate or isomer	273.0080	4.9	4.5	4.0, 4.6	3.6	4.0	4.5
decanoyl carnitine	316.2482	14.3	15.1	15.7	nd	7.9	7.3, 11.4

**Figure 4-13 Extracted ion traces for decanoyl carnitine (m/z 316.24-m/z 316.25) extracted from urine run on a Silica C, Diamond Hydride and Pinene columns. Conditions as in section 3.2.2.**





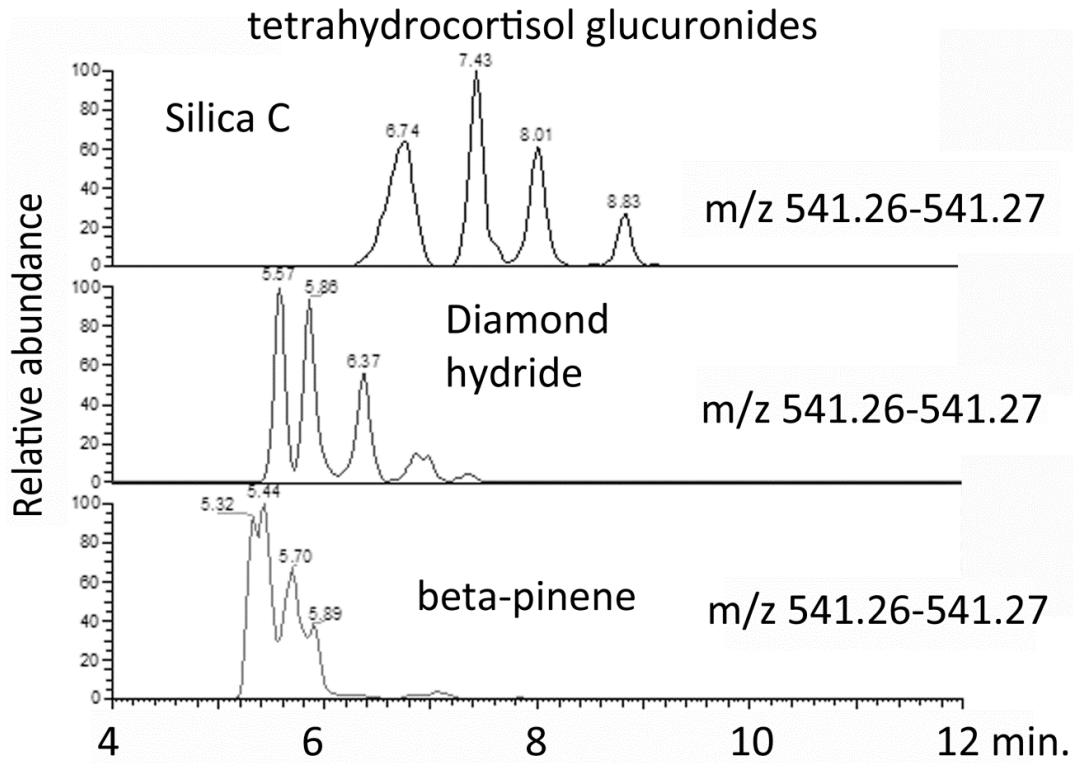
Glucuronides are abundant in urine and recently a tandem MS method was used to characterise glucuronide metabolites of the hydrocortisone [112] and four isomers of tetrahydrocortisol glucuronide were characterised in human urine (Table 4.2).

**Table 4.2 Some steroid conjugates of compounds present in urine giving an indication of the different properties of the three hydride columns. Compounds were identified on mass matching of < 3 ppm.**

Compound	m/z	Type C	Diamond	$\beta$ -pinene	Type C	Diamond	$\beta$ -pinene
		silica	hydride	hydride	silica	hydride	hydride
		AA	AA	AA	FA	FA	FA
		tr min	tr min.	tr min.	tr min.	tr min.	tr min.
Dihydrotestosterone glucuronide	425.2503	6.1	5.5	5.4	nd	nd	nd
Tetrahydrocortisol Glucuronides	541.2666	6.7, 7.4, 8.0, 8.8	5.6, 5.9, 6.6	5.3, 5.4, 5.7, 5.9	5.4, 5.5	6.2, 6.9	6.4, 6.7

These can be observed in the current case by using accurate mass measurement with the Orbitrap and figure 4.14 shows the separation of these isomers on the hydride columns with ammonium acetate as the mobile phase modifier. The most satisfactory separation is achieved on the type C silica column where all four isomers are baseline resolved and despite their high degree of lipophilicity it is interaction with the unmodified silicon hydride surface which produces the greatest degree of retention. The  $\beta$ -pinene column has the least degree of discrimination between these four isomers despite the fact that they possess an abundance of chiral centres.

**Figure 4-14** Extracted ion chromatograms for tetrahydrocortisol glucuronides run on three hydride columns. Mobile phase A 10 mM ammonium acetate in water, mobile phase B acetonitrile, flow rate of 0.3 ml/ min. Gradient: at 0 min 20% A 80% B, at 12 min 50% A 50% B and remain the same till 26 min 50% A 50% B. Detection FT-MS in negative ion mode.

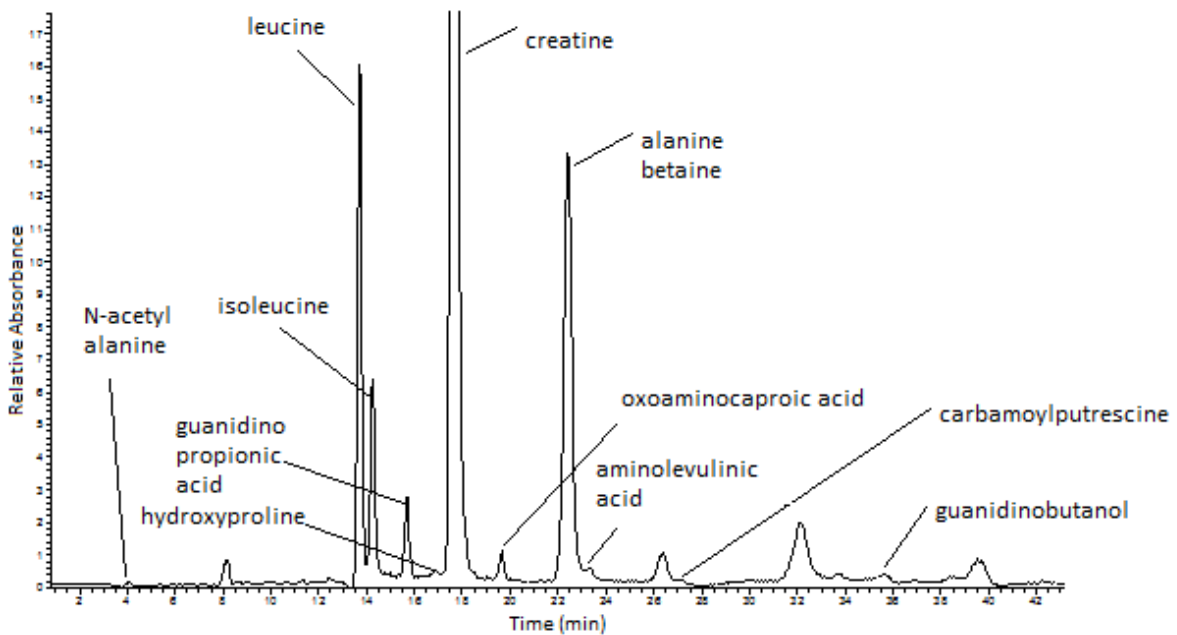


Retention times of compounds can be predicted to some extent on the hydride columns since from the extensive range of standards run shown in Table AII.1 (Appendix II) compounds have characteristic retention ranges. As an example the presence of the isobaric compounds in the range  $m/z$  132.0-132.2 can be considered (Table 4.3). Standards have been run for some of these compounds as detailed in Table AII.1 (Appendix II). Figure 4.15 shows an extracted ion chromatograph for urine in the range  $m/z$  132-132.2.

**Table 4.3 Isobaric compounds ( $[M+H]^+$  between 132.0-132.2 (taken from the Metlin database).**

Compound	Exact Mass	Molecular Formula
Iminoaspartic acid, oxosuccinamate	132.0291	C <sub>4</sub> H <sub>5</sub> NO <sub>4</sub>
N-acetylalanine, propionyl glycine, hydroxyproline, aminolevulinic acid, oxoaminopentanoic acid, N-acetyl β-alanine, glutamate semi-aldehyde,	132.0655	C <sub>5</sub> H <sub>9</sub> NO <sub>3</sub>
Creatine, guanidino propionic acid	132.0695	C <sub>4</sub> H <sub>9</sub> N <sub>3</sub> O <sub>2</sub>
Leucine, isoleucine, alanine betaine, betaleucine, alloisoleucine, aminocaproic acid.	132.1019	C <sub>6</sub> H <sub>13</sub> NO <sub>2</sub>
Guanidinobutanol, carbonyl putrescine.	132.1131	C <sub>5</sub> H <sub>13</sub> N <sub>3</sub> O

**Figure 4-15 Extracted ion trace of metabolites in urine with masses between  $m/z$  132.0-132.12 run on a Silica C column. Conditions as in section 3.2.2.**



It is possible to make tentative assignments to the identities of the metabolite peaks in figure 4.15 on the basis of what is known about the effect of physicochemical properties on retention time. Leucine, isoleucine, creatine and hydroxyproline can be assigned from their retention times shown in Table All.1. N-acetylalanine should run early since it is an amide rather than an amine, the only peak the same exact mass as creatine is assigned guanidino propionic acid, aminolevulinic acid and oxocaproic acids are isomers and both have an extra oxygen atom compared with leucine and thus will run later since they are more polar, alanine betaine is a quaternary amine and will elute at a similar time to acetylcarnitine (table All.1), carbamoylputrescine is an amine with no carboxylic acid to reduce its overall charge and thus runs later than zwitterions like the leucines and guanidine butanol is a strong base with no carboxylic acid functional group to balance the charge on the base thus will run very late.

#### **4.4 Conclusions**

Overall it is not possible to explain the behaviour of the three type C silica based columns, the only generalisation is that the unmodified type C silica column was more retentive for a range of metabolites with ammonium acetate as the mobile phase modifier but there was no clear pattern where formic acid was used as the modifier. The modified type C silica columns could offer additional lipophilic interactions but many of the compounds considered above have very low partition coefficients and thus should not interact with the lipophilic surface ligands. In the chapter seven different HILIC columns were extensively characterised with regard to their ability to retain standards for 100 metabolites. The best all round column was the silica C column which gave good peak shapes for most analytes.

The addition of lipophilic ligands to the surface of the silica C column in the Pinene and Diamond Hydride columns did not seem to offer any advantages with regard to selectivity and generally retention for most of the standards was weaker than on Silica C.

# **Chapter 5**

## **|An Application of Hydrophilic Interaction Chromatography in Bioanalysis**

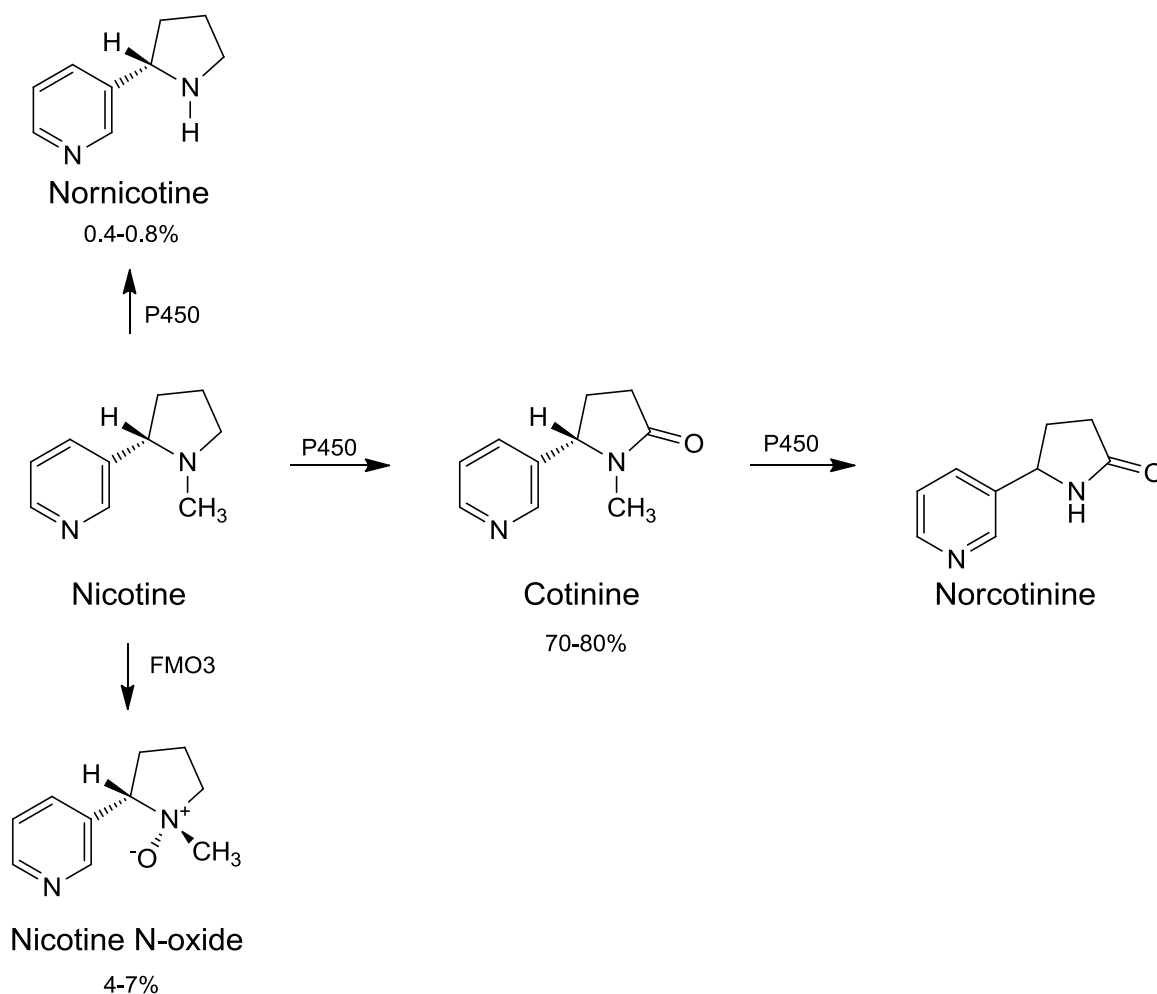
## **5 Determination of nicotine exposure in dogs subjected to passive smoking using hydrophilic interaction chromatography in combination with Fourier transform mass spectrometry**

### **5.1 Introduction**

A request was received from Glasgow Vet School to develop a method for the analysis of samples taken from dogs and cats whose owners were smokers in order to investigate the level of passive smoking to which the animals were subjected. The exposure of non-smokers to environmental tobacco smoke (ETS) has been extensively investigated [113-131]. The monitoring of nicotine and its metabolites in body fluids [113-121] has been used as one measure of nicotine exposure in non-smokers but the half-life of nicotine is only a few hours and thus monitoring of physiological fluids may be less suitable for gauging long term exposure. Hair has several advantages over other samples; hair can be collected easily, stored for long time without deterioration, and provide better information on long-term exposure and increased ability to differentiate exposure than other biological Samples. Several studies have indicated that hair nicotine concentration is a more useful biomarker of long term smoke exposure [123-130] than the levels of nicotine in body fluids. Hair nicotine concentrations have been determined by using a range of techniques, including high-performance liquid chromatography (HPLC) with UV detection [123] and with electrochemical detection [124]; liquid chromatography mass spectrometry [125-127] and gas chromatography mass spectrometry [128, 129]. Up to 15 metabolites of nicotine including nicotine N-oxide, cotinine, norcotinine, cotinine N-oxide and trans 3-hydroxy cotinine have been detected in urine [114]. Figure 5.1 shows the structure of the nicotine and some of its important metabolites [132]. The scheme shows the pathway for the conversion of nicotine to cotinine, nornicotine and the N-oxidation of nicotine. Cotinine

represents the highest percentage of the metabolism pathway where almost 75% of the nicotine is converted into cotinine in the liver by a cytochrome P450 system. Nicotine N-oxide has been found at 4-7% of total metabolism and is formed via a flavin-containing monooxygenase 3 (FMO3), this results in formation of two possible diastereoisomers since the oxidation of nitrogen introduces a second chiral centre. It has been shown that the nicotine N-oxide is not metabolized further, however, it can be reduced back into nicotine. Nornicotine is formed in the lowest amount accounting for 0.4 -0.8% of the metabolism of nicotine, nicotine converts to nornicotine via a cytochrome P450 system [132].

**Figure 5-1 Scheme for the metabolism of nicotine [132].**





In hair nicotine and its metabolite cotinine have been the most frequently measured metabolites. There have been no reports assessing the level of nicotine exposure in companion animals of smokers. Hydrophilic interaction chromatograph (HILIC) methods are becoming more common in analysis of drugs and their metabolites and HILIC has been recently used to analyse nicotine and its metabolites in urine [116]. The current study demonstrates the advantages of HILIC when used in conjunction with organic solvent extraction of hair.

## **5.2 Materials and methods**

### ***5.2.1. Chemicals***

Nicotine, cotinine, ammonium acetate, sodium hydroxide and m-chloroperoxybenzoate were obtained from Sigma Aldrich Dorset UK.  $^2\text{H}_4$ -nicotine (1 mg/ml in methanol) was obtained from CK gases, UK. HPLC grade methanol, chloroform and acetonitrile were obtained from Fisher Scientific, UK. HPLC grade water was prepared in the lab using a Milli Q purification system.

### ***5.2.2. Dog hair sample collection***

Hair was collected from dogs by clipping the neck region with the owner's consent. All hair samples were collected from the neck region to ensure consistency of sampling site as hair growth varies with anatomical location [133]. Similarly, the speed of hair growth in dogs varies according to final hair length, with longer hair growing faster [133]. Owners were asked to complete a questionnaire briefly outlining the age, breed and sex of the dog and estimating the amount of ETS to which each dog was exposed. The hair was stored in sealed envelopes and stored to ensure that no further ETS exposure occurred after hair collection.

### **5.2.3. Extraction of dog hair**

Samples of dog hair (*ca.* 30 mg) were washed with 2 ml of methanol by sonicating for 15 min at room temperature. The methanol was removed and the washings were retained for analysis. The hair was then treated with 1 M NaOH (1 ml containing 1 µg of  $^2\text{H}_4$ -nicotine) at 50 °C for 24 h. The sample was then loaded onto Strata X columns (30 mg, Phenomenex, UK), which had been prewashed with 1 ml of NaOH. The columns were then washed with 2 ml of water and then eluted with 1 ml of acetonitrile/water (95:5) containing 3.25 mM ammonium acetate. The sample was then injected into a ZICHILIC column connected to an Orbitrap Exactive mass spectrometer.

### **5.2.4. Calibration**

Calibration curves were prepared by spiking 1 µg of  $^2\text{H}_4$ - nicotine into 1 ml amounts of 1 M NaOH and 0.05, 0.1, 0.2, 0.4, 0.8 and 1.6 µg amounts of nicotine. The samples were then treated in the same way as the hair samples. The precision of the analyses was assessed for the NaOH digestion and methanol extraction procedures by repeating analysis of the hair from dog 7 three times.

### **5.2.5. Mass spectrometric analysis**

The extracts were analysed by using an Orbitrap Exactive Mass Spectrometer (ThermoElectron, UK) operated in positive ion ESI mode with a needle voltage of 4.5 kV, a heated capillary temperature of 275 °C, sheath gas flow of 50 arbitrary units and auxiliary gas flow of 17 arbitrary units. The instrument was operated at 50,000 resolution and scanned from 75–1000 amu. Chromatography was carried out using a Dionex 3000 binary HPLC pump fitted with a ZICHILIC column (150 mm × 4.6 mm; 5 µm particle size, Hichrom, UK) a gradient was used with a flow rate of 0.5 ml/min. Mobile phase A was 0.1% formic

acid in water and mobile phase B was 0.1% formic acid in acetonitrile. The gradient was as follows: 60% B 0 min to 20% B at 20 min followed by re-equilibration for 10 min.

#### ***5.2.6. Synthesis of nicotine N-oxides***

Nicotine (20 mg) in 1 ml of chloroform was cooled in ice and 20 mg of m-chloroperoxybenzoic acid in 2 ml of chloroform was then added a drop at a time to the nicotine solution shaking after each addition [131]. The mixture was left at room temperature for 2 h. The sample was used directly for qualitative characterisation of nicotine N-oxide by diluting it to 10 ml with methanol. The stock solution was diluted x 100 with mobile phase before analysis.

### **5.3. Results**

#### ***5.3.1. Consideration of the extraction method***

In order to distinguish between nicotine adhering to the surface of the hair and nicotine within the hair, hair samples are generally washed with organic solvent prior to being digested. The procedures used for the analysis of nicotine in hair are generally similar to those developed by Pichini *et al.* [123]. Digestion is most often carried out by gentle heating in 1 M NaOH following an initial wash with dichloromethane. However, there is really no definitive way to distinguish nicotine within the hair and that on the surface and although dichloromethane has been generally adopted on the basis of a relatively small study as the best solvent pre-treatment [123], it is not possible to be sure that it is optimal either in terms of removing all surface nicotine, particularly in the case of dogs where the hair character is very diverse. Dichloromethane would seem to be a less than ideal washing solvent since it is relatively non-polar, does not swell the hair [134] and is less likely to break up ion pair interactions between nicotine and acidic groups in the proteins in hair and hair

melanin than methanol. It has been demonstrated in a previous study that non-swelling solvents are ineffective at completely removing cocaine applied to the surface of the hair since they do not remove drug, which has penetrated beyond the hair cuticles [135]. Such a degree of penetration is even more likely in the case of nicotine from smoking, which is applied to the hair in the vapour phase. Since animals can also absorb nicotine via licking the surface of their fur the total nicotine levels in the hair are also relevant.

### **5.3.2. NaOH *digestion procedure for extracting nicotine from hair***

Figure 5.2 shows an extracted ion chromatogram of nicotine from NaOH digested dog hair along with extracted ion chromatograms for its metabolites cotinine and nicotine N-oxide, the mass accuracy produced by the Exactive was always <2 ppm and generally <1 ppm. This meant that there was little potential for interference from other components. Low levels of nicotine N-oxide and cotinine could also be observed in hair from dogs exposed to smoking (Figure 5.2). In addition nornicotine and an oxide of nornicotine, possibly N-hydroxyl or ring hydroxylated, could be putatively identified in some samples particularly in the dogs which had been exposed to high levels of ETS.

Figure 5-2 Extracted ion traces showing  $^2\text{H}_4$ -nicotine, nicotine, cotinine, nicotine N-oxides and nornicotine oxide extracted from the hair of dog 7 following 2 h digestion in 1 M NaOH followed by SPE.

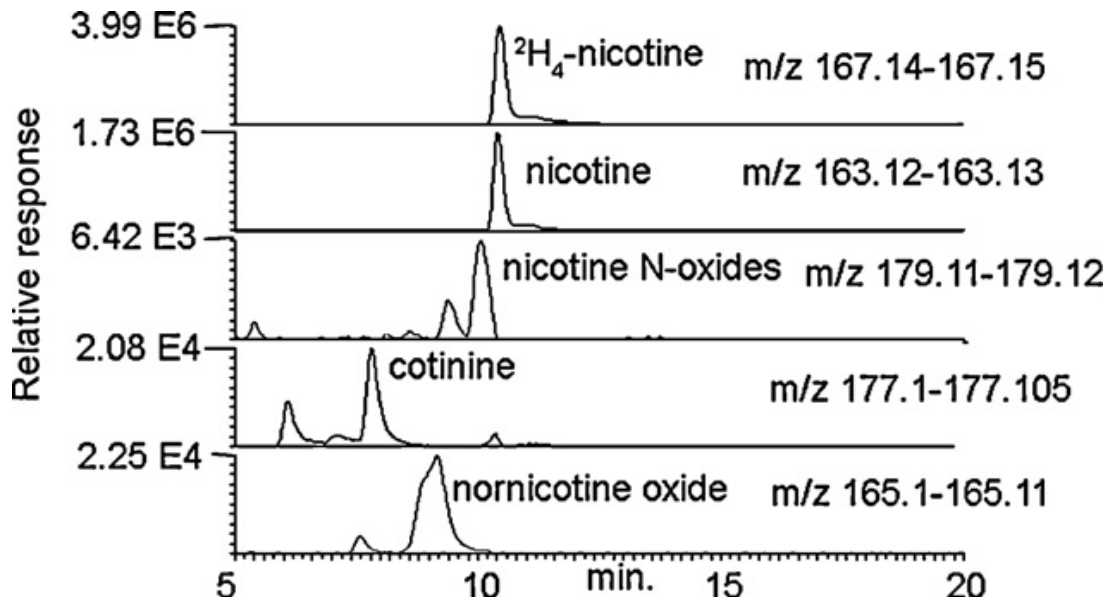


Figure 5.3 shows an extract from dog hair which has not been exposed to nicotine. It can be seen that even with addition of the relatively large amount of (1  $\mu\text{g}$ ) of deuterated internal standard there is no trace of nicotine in the blank sample.

Figure 5-3 Extracted ion traces of an extract from the hair of a dog not exposed to cigarette smoke spiked with 1  $\mu\text{g}$  of  $^2\text{H}_4$ -nicotine.

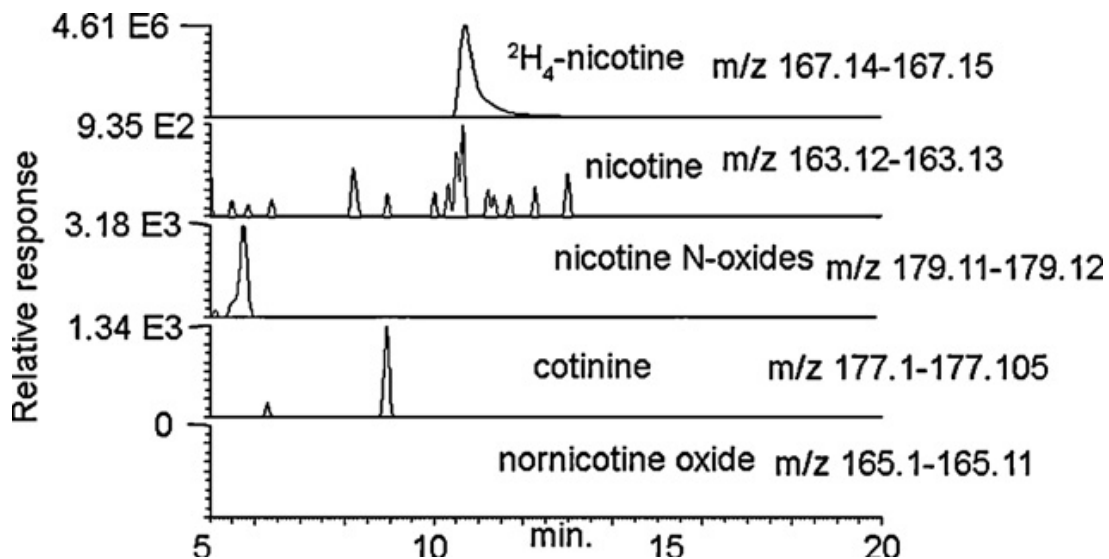


Table 5.1 shows the levels of nicotine extracted from dog hair following washing with methanol for 15 min and then digestion with NaOH. Varying amounts of nicotine are removed by the initial methanol wash perhaps reflecting the widely differing types of hair. The precision obtained for repeat analysis of dog 7 was  $\pm 3.2\%$  ( $n = 3$ ). The dog no. 9 has a high level of nicotine for a non-smoker owner. This might be because the dog was exposed to a high level of tobacco smoke before sampling, it might have eaten a cigarette from outside without the owner noticing, or it might be because the hair that was taken for was old and not 1cm above the surface of the skin.

**Table 5.1 Concentration of nicotine determined in dog hair in a 15 min methanol wash and in the NaOH digest following the methanol wash.**

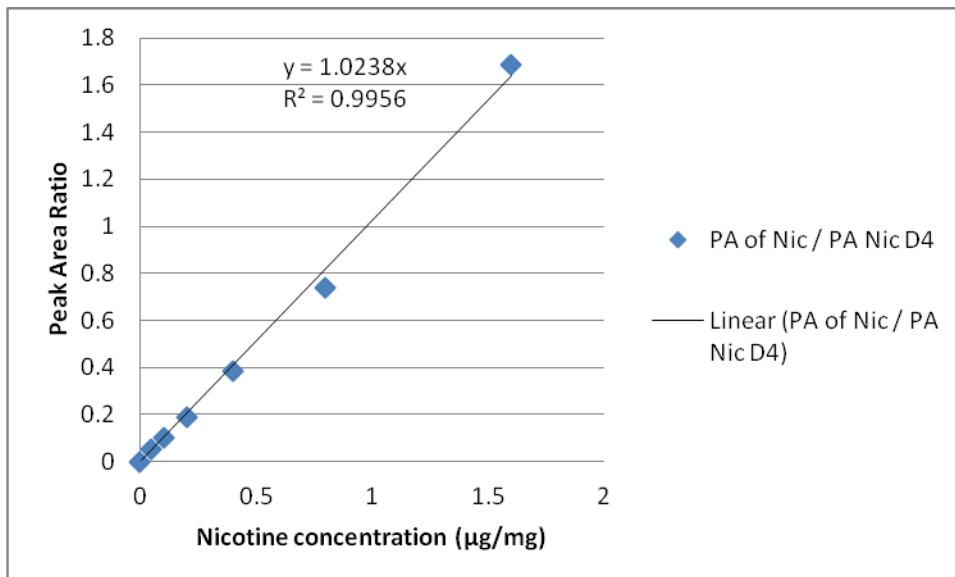
Dog no.	Category	Hydrolysate nicotine (ng/mg of hair)	Methanol wash (ng/mg of hair)
1	Smoker	0.0865	0.115
2	Smoker	0.109	0.278
3	Smoker	0.189	0.905
4	Smoker	0.150	0.812
5	Smoker	0.0136	0.0208
6	Non-smoker	0.000	0.0046
7	Smoker	9.03	9.80
8	Non-smoker	0.0000	0.00470
9	Non-smoker	3.08	0.101
10	Non-smoker	0.0281	0.0156
11	Non-smoker	0.000	0.000
12	Non-smoker	0.000	0.000
13	Non-smoker	0.000	0.000
14	Non-smoker	0.000	0.0
15	Smoker	0.489	2.77

Table 5.2 summarises the accurate mass data for the various nicotine metabolites in the dogs of smokers. Since there was no evidence for nicotine in the blank samples and the range of concentrations in the samples was wide the calibration curve was forced through 0 and the equation of the line was  $y = 1.0238x$  with  $R^2 = 0.9956$  (figure 5.4).

**Table 5.2 Metabolites of nicotine observed in smoke exposed dog hair samples with mass deviations from their exact elemental composition by using NaOH method.**

Dog no.	Continine	Nicotine N-oxide	Nornicotine	Nornicotine N-oxide
1	-0.96 ppm	0.058 ppm	ND	ND
2	0.02 ppm	0.002 ppm	ND	-0.97 ppm
3	-0.11 ppm	-0.61 ppm	ND	-1.03 ppm
4	1.02 ppm	0.28 ppm	ND	-0.42 ppm
5	ND	ND	ND	ND
7	-0.11 ppm	-0.28 ppm	0.17 ppm	0.12 ppm
15	ND	-0.39 ppm	0.17 ppm	-0.85 ppm

**Figure 5-4 Calibration curve for the nicotine fitting regression equation and the  $R^2$  value.**



### ***5.3.3. Extraction of nicotine and its metabolites using a methanol wash***

Since there was some uncertainty regarding the amount of the nicotine removed during the solvent wash, the extraction of nicotine from dog hair with methanol with length of sonication was also studied for dog 7. An advantage of using HILIC was that the methanol extract could be injected into the chromatography system without any further preparation. Figure 5.5 shows a plot of the release of nicotine from a sample of the dog hair (dog 7) over a 2 h sonication period in methanol. The nicotine released reached a plateau at around 1 h and at 30 min about half the nicotine has been released thus reflecting that which was observed for some of the samples shown in Table 5.1 although in some cases the rate of release appeared to be greater. The profile of the release of nicotine from the hair with sonication in methanol is very similar to that reported for the basic drug heroin [134]. The nicotine metabolites cotinine and nicotine N-oxide were also gradually released up to 1 h. Thus it was difficult to decide which was surface nicotine and which was nicotine from inside the hair particularly because the structure of hair is complex and to remove surface nicotine is important to ensure good contact between the extraction solvent and the hair. This is why sonication is important since it produces efficient wetting of the hair. Other way to help release the nicotine and its metabolite from the hair is to cut the hair down to smaller pieces.



Figure 5-5 Dissolution of nicotine and its metabolites from dog hair (dog 7) over 2 h of sonication in methanol.

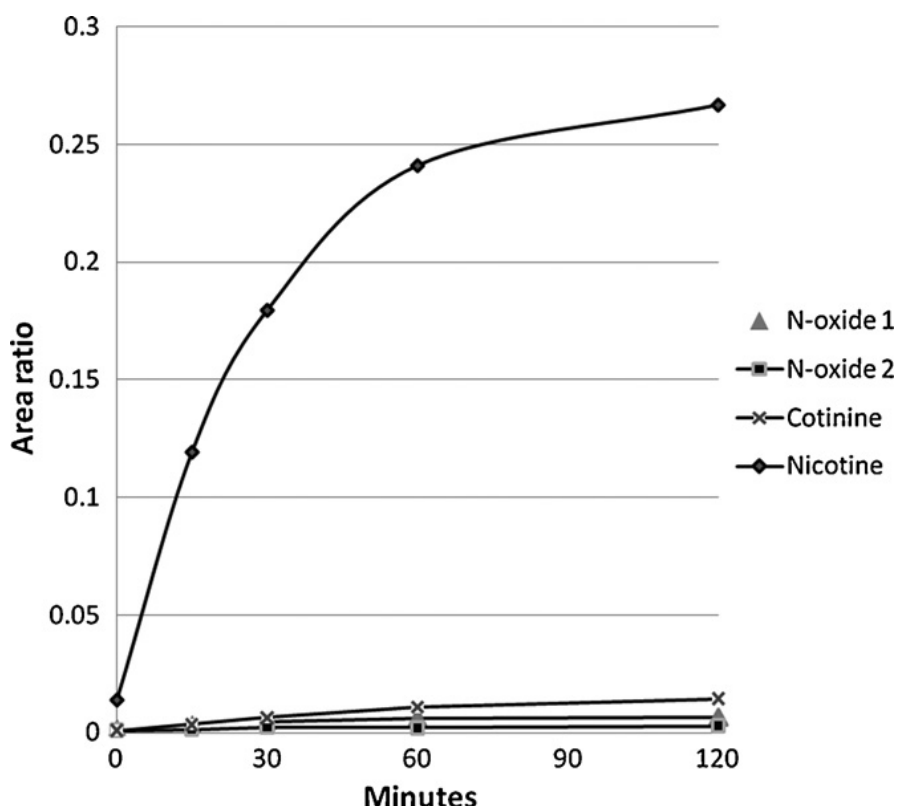


Figure 5.6 shows the chromatogram for the methanol extract of the same dog hair as shown in figure 5.2 and it can be seen that in addition to nicotine the peaks for nicotine N-oxide and cotinine are larger than was observed for the NaOH extraction. The double peak for the N-oxide is probably due to the formation of diastereoisomers of the N-oxide since nicotine contains a chiral centre and the addition of oxygen to the nitrogen creates a second chiral centre on the nitrogen. This pattern was repeated for most of the extracts containing nicotine. Thus it may be that cotinine and nicotine N-oxide are unstable in the NaOH digestion solution to some extent. It is perhaps not surprising in the case of cotinine since it contains an amide type bond, which is unstable to strongly acidic or basic conditions. Cotinine has often been measured in hair [123, 125, 126, 129, 130] but its level of recovery

has not always been rigorously assessed. Spiking of blank dog hair with 50 ng of cotinine and nicotine N-oxides resulted in good recovery when a simple methanol extraction was used. When the NaOH extraction process was used no nicotine oxide could be observed and the recovery of the cotinine was around 70% of that obtained by direct methanol extraction with a much noisier background. In some of the blank samples that were extracted with methanol there was apparently a peak for cotinine but on closer inspection this peak was due to the  $^{13}\text{C}$ -isotope peak for the amino acid citrulline which eluted close to cotinine and had a very close mass match to it. In the case of nicotine oxide it is quite possible that it is not a metabolite of nicotine but is rather due to air oxidation of nicotine adhering to the dog hair. This is made more likely by the fact that the preparation of a small amount of nicotine N-oxide by reaction of nicotine with m-chloroperoxybenzoate produced two peaks for the N-oxide in the same ratio as was observed in the methanol extracts from the dog hair suggesting chemical rather than enzymatic reaction.

**Figure 5-6** Extracted ion traces showing  $^2\text{H}_4$ -nicotine, nicotine, cotinine and nicotine N-oxides extracted from the hair of dog 7 following 2 h sonication in methanol.

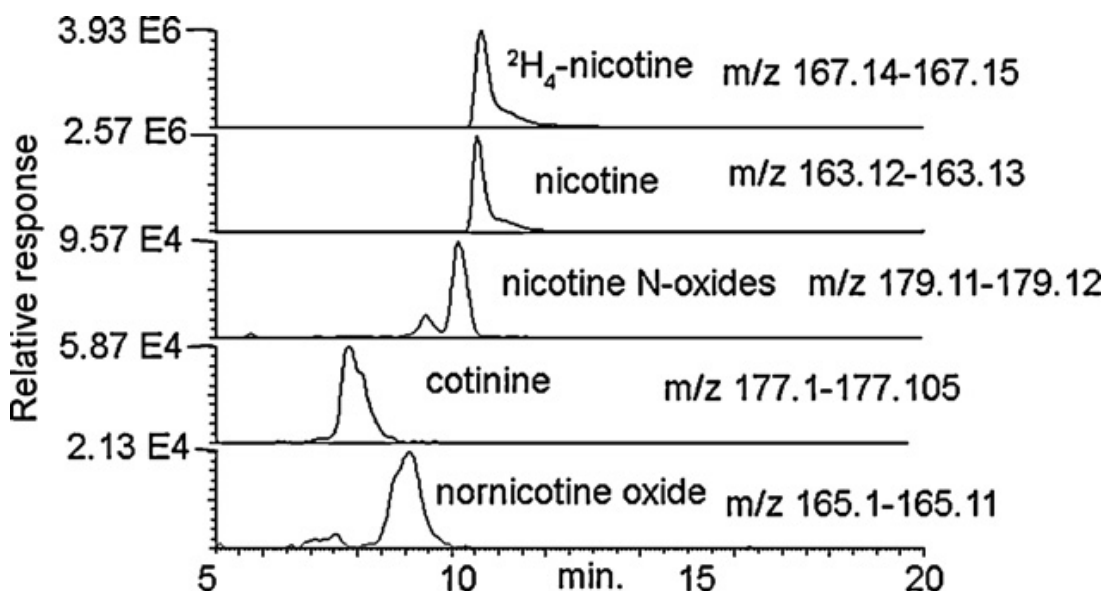


Table 5.3 shows the data obtained for samples prepared by methanol extraction and by NaOH digestion without any pre-wash. In most cases there is good agreement between the NaOH extraction process and the methanol extraction indicating that the methanol wash is removing all the nicotine in the hair. The RSD for the repeat determination of methanol in dog 7 using this method was  $\pm 1.9\%$ . The methanol extraction method in combination with HILIC analysis presents a very convenient method for determining nicotine and its metabolites and rather than pre-washing the hair it might be best to report nicotine levels after 15 min extraction and 2 h extraction. The method would also be compatible with a GC-MS analysis although perhaps a drop of methanolic ammonia might be added prior to the analysis in order to scavenge any anions which might pair with the nicotine. Although Exactive is not capable of MS-MS limits of quantification around 1 ng/ml, which were obtained for nicotine by using narrow range (0.01 amu) extracted ion chromatograms. The main inconsistency between the methanol extraction and the NaOH extraction in Table 5.4 is for dog 9, which is a poodle. This dog supposedly belongs to a non-smoker and this might mean that the smoke exposure is old and the nicotine is much more embedded within the hair or heterogeneously distributed within the hair or it may be that methanol extraction is less effective in extracting this type of dog hair.

**Table 5.3 Concentration of nicotine in dog hair determined in NaOH digests with no pre-washing of the hair and in methanol extracts prepared by 2 h of sonication.**

Dog no.	Category	NaOH extraction (ng/mg)	MeOH extraction (ng/mg)
1	Smoker	0.229	0.230
2	Smoker	0.338	0.407
3	Smoker	1.30	0.982
4	Smoker	0.955	1.078
5	Smoker	0.054	0.0
6	Non-smoker	0.0	0.0
7	Smoker	11.5	17.8
8	Non-smoker	0.0	0.0
9	Non-smoker	3.50	0.456
10	Non-smoker	0.0	0.0
11	Non-smoker	0.0	0.0
12	Non-smoker	0.0	0.0
13	Non-smoker	0.0	0.0
14	Non-smoker	0.0	0.0
15	Smoker	3.280	2.986

#### ***5.3.4 Application of the NaOH extraction method for determine the Nicotine.***

The sections above describe the development of a finished method but before the methanol extraction procedure was developed an NaOH extraction method was used. There was not sufficient remaining fur to analyse every dog. Thus a more complete set of data was obtained by the initially applied more complicated extraction method (Table 5.4). Table 5.5 correlates the levels of nicotine measured with the information obtained from the questionnaire (Appendix III). The wash nicotine and hair nicotine concentration (HNC) showed good correlation on rank analysis, although differences in the amount of adhered nicotine could be associated with removal by washing, swimming or grooming prior to sampling. Thirty-eight dogs were included in the study. The median age was 7 years old and the mean was similar (6.77 years). Eighteen dogs were male and 20 were female. The 38 dogs have been classified to three groups according to the questionnaire report. Group 0,

which had not reported ETS exposure (15 dogs), Group 1, which had reported occasional ETS (7 dogs) and group 2, which dogs had regular ETS exposure (16 dogs). High HNC was found in 22 dogs of Group 1 and 2 (23 dogs in total), however occasional ETS exposure resulted in reduced nicotine concentrations in both hair and wash compared to dogs with regular ETS exposure. This suggests that reducing exposure by smoking outdoors or by reducing the amount of direct contact with ETS will significantly reduce the amount of HNC in dogs.

Low HNC recognize from 11 of the 15 dogs in group 0, which is possible that exposure is taking place through alternative routes not recognised by the owners, such as environmental pollution. However, the HNC of dogs exposed occasionally to ETS remains greater than that of dogs that are never exposed. Five dogs (4 in group 0 and 1 in group 1) had HNC of 0.0000 ng/mg. Three of these dogs came from rural environments. The remaining 2 dogs came from a semi-rural environment with a significant amount of green space in the immediate area.

**Table 5.4** The amount of the nicotine in the Methanol wash and in the NaOH extraction for all the dogs' hair samples. (S) = smoker and (NS) = non-smoker, group exposure to nicotine (0) = Never, (1) = Occasional and (2) = regularly.

<b>Dog No.</b>	<b>Group Exposure to Nicotine</b>	<b>Hydrolysate nicotine ng/mg of hair</b>	<b>Methanol wash ng/mg of hair</b>
<b>1 (S)</b>	1	0.0615	0.0331
<b>2 (S)</b>	1	0.0256	0.0412
<b>3 (S)</b>	2	0.7248	1.4240
<b>4 (S)</b>	1	0.0865	0.1153
<b>5 (S)</b>	2	0.1093	0.2779
<b>6 (S)</b>	2	0.1886	0.9045
<b>7 (S)</b>	1	0.1499	0.8124
<b>8 (NS)</b>	0	0.0136	0.0208
<b>9 (NS)</b>	0	0.0115	0.0069
<b>10 (S)</b>	1	0.0000	0.0046
<b>11 (S)</b>	2	2.2110	0.5667
<b>12 (S)</b>	2	0.4460	0.8265
<b>13 (S)</b>	2	9.0318	9.8026
<b>14 (NS)</b>	0	0.2903	0.0409
<b>15 (S)</b>	1	0.1745	0.2614
<b>16 (S)</b>	2	2.1606	0.4089
<b>17 (S)</b>	2	0.1809	0.1682

<b>18 (NS)</b>	0	0.0212	0.0757
<b>19 (NS)</b>	0	0.0000	0.0047
<b>20 (NS)</b>	0	3.0834	0.1014
<b>21 (NS)</b>	1	0.0281	0.0156
<b>22 (S)</b>	2	0.1858	0.1682
<b>23 (S)</b>	2	0.5853	1.9034
<b>24 (S)</b>	2	0.5998	0.6827
<b>25 (S)</b>	2	0.3589	2.3088
<b>26 (S)</b>	2	0.3762	0.4911
<b>27 (S)</b>	2	0.5629	1.8886
<b>28 (S)</b>	2	3.2815	0.9210
<b>29 (S)</b>	2	11.3060	1.9186
<b>30 (NS)</b>	0	0.0049	0.0044
<b>31 (NS)</b>	0	0.0000	0.0000
<b>32 (NS)</b>	0	0.0000	0.0000
<b>33 (NS)</b>	0	0.0215	0.0191
<b>34 (NS)</b>	0	0.0225	0.1549
<b>35 (NS)</b>	0	0.0445	0.0000
<b>36 (NS)</b>	0	0.0000	0.0000
<b>37 (NS)</b>	0	0.0077	0.0017
<b>38 (S)</b>	2	0.4893	2.7683

Table 5.5 shows from the analysis of the owner questionnaires showed that 87% of dogs are exposed to ETS in their own homes and 74% of dogs are exposed during close contact with a smoker. In addition 74% of owners reported that their dogs are exposed to ETS outdoors. The number of cigarettes or tobacco products used in smoking households ranged from 5-50 per day. The mean was 25.59 and the median was 20 cigarettes or other tobacco products per day. The analysis of these data was only for the regular and occasionally smoker which represent 23 of the total number 38.

**Table 5.5 Percentage of dogs exposed to ETS in different locations (n= 23).**

Locations of ETS exposure	Regular exposure Number (%)	Occasional exposure Number (%)	Total exposure n=23
Close contact with owner	10 (43%)	7 (30%)	74%
In pets home	15 (65%)	5 (22%)	87%
During car travel	2 (9%)	6 (26%)	35%
In family or friends' home	4 (17%)	5 (22%)	39%
Outdoors	8 (35%)	9 (39%)	74%

The median HNC identified in dogs regularly exposed to ETS (0.57 ng/mg) was similar to those reported in children (0.68 ng/mg) and women (0.4 ng/mg) exposed to second hand smoke [136]. In the study by Wipfli [136] children under 5 had median HNC twice that of children over 5. This probably reflects the close contact between young children and smokers in the home. Similar scenario was for Dog 20 (16 weeks) which had HNC 3.0834



$\mu\text{g}/\text{mg}$  for Group 0 where the Dogs 30 and 34 from the same breed (poodle) and dog group but different age had HNC 0.0049 and 0.0225  $\mu\text{g}/\text{mg}$  respectively.

The data published in the study by Wipfli [136] suggests that HNC up to 10 ng/mg were recorded in these children. These figures are similar to those obtained in this study (dog number 29), suggesting that dogs experience similar risks from ETS exposure in the home. This also suggests that dog hair could provide a useful method of determining the amount of ETS exposure in all environments common to pets and children. In addition, this information could be used to aid health professionals by highlighting the risk to pets of smoking in the home.

#### **5.4. Conclusion**

In conclusion extraction of nicotine from dog hair using sonication in methanol in combination with hydrophilic interaction chromatography provides a straightforward method for determining nicotine absorption due to passive smoking in dogs. The problem still remains over whether the nicotine is on the fur or within the fur but in the case of companion animals nicotine will be orally absorbed anyway as a result of self-grooming. The determination of levels of the metabolites of nicotine might provide a more definitive answer with regard to systemic absorption, however, it is quite possible that nicotine N-oxide and even cotinine might be formed either during the burning of tobacco or via atmospheric oxidation of nicotine adhering to the fur. Perhaps the most reliable indicator of metabolism observed in the current case is nornicotine N-oxide which is quite clear in a number of samples and which is more likely to be formed via enzyme action, however, nornicotine has been reported, along with cotinine and norcotinine, as a constituent of

cigarette smoke [137]. The sample preparation steps in the current case are very simple avoiding potential losses of sample and metabolites, which can occur when digestion in NaOH followed by liquid–liquid extraction or solid phase extraction is used. Since organic solvents are weak solvents in HILIC mode the methanol extract can be injected directly onto the HILIC column without losing sample focusing and thus nicotine release with time can be readily assessed. The application of the method to the dog hair sample was successfully evaluated and it has almost the same result as had been obtained previously for children and women.

## **Chapter 6**

### **|Conclusions and further work**

## 6.1 Conclusions

The HILIC technique is a powerful method for the separation polar and very polar compounds. The type of the ligand attached to the bare silica governs chromatographic selectivity. An extensive study was made of the HILIC like properties of a CN column. Five basic drugs were used to characterise the retention properties of the column. The test compounds were retained strongly in a mobile phase consisting of acetonitrile/water (95:5) containing 3.25 mM ammonium acetate. The retention time of the drugs decreased as the amount of water in the mobile phase was increased. The retention of the basic drugs was shown to depend on the buffer used as a mobile phase additive. When sodium acetate was used as a mobile phase additive there was very little retention of the test compounds since the  $\text{Na}^+$  is fully charged at all pH values and also has a high charge density thus was able to compete strongly with the test compounds for negatively charged silanols. Apart from benzalkonium, the test compounds were only partially charged at the pH of the mobile phase and were also larger than  $\text{Na}^+$ . The test compounds were retained to a greater degree which when the quaternary ion tetraethylammonium was used as a counter ion. When counter ions with lower pKa values were used such as tris and bis-tris showed the retention times for the mixture bases was increased in comparison to ammonium acetate because they competed less effectively with the test compounds for the silanol groups in the stationary phase. The properties of the CN column were further assessed by using a series of simple primary, secondary, tertiary and quaternary amines. The two quaternary amines eluted latest from the column with smaller trimethylbenzylamine being more strongly

retained than the larger triethylbenzylamine which has a lower charge density. The secondary amines were next most strongly retained since they have relatively high  $pK_a$  values in comparison with primary and tertiary amines. The degree of retention of the secondary amines depended on the size of the basic centre with N-methyl benzylamine being most strongly retained in the series and N-tertiary butyl benzylamine being least retained. The primary amines in the test set eluted earlier than the secondary amines since they have lower  $pK_a$  values and the tertiary amine N-dimethyl benzylamine eluted earliest since the  $pK_a$  values of tertiary amines are the lowest. The retention of the test compounds was shown to increase with increasing pH up to pH 7 and to decrease with increasing ionic strength of ammonium acetate in the mobile phase. The ACE CN column was found to be stable up to around 200 hours but gradually lost some of the surface ligand which could be observed with gradually increasing retention of the test compounds as more silanol groups became exposed. Overall the CN column was very effective for the separation of basic compounds offering low backpressures due to the high organic solvent content and excellent peak shapes. Successful separation of some of the pharmaceutical products from their impurities was carried out for salbutamol and promethazine with a good peak shape and linear response.

The type C silica surface was successfully used in HILIC mode. The simple silicon hydride column (Silica C) retained bases more strongly than silica gel and the retention was pH dependent increasing with pH. The Silica C column also retained acidic compounds and polar neutral compounds such as sugars. The behaviour of the type C silica surface was very different from that of the silica gel surface, thus creating an exciting new aspect of chromatographic behaviour of silica gel which remains to be further investigated. The exact retention mechanism of this column currently cannot be fully explained. The type C silica

column technology provides a useful complementary method to established HILIC methods that have been found valuable in metabolomics studies. The Silica C column appears to be very stable and its behaviour remains well differentiated from the retention properties of bare silica gel even after extensive use.

Seven different HILIC columns were extensively characterised with regard to their ability to retain standards for 100 metabolites found in tissues and biological fluids. A comprehensive table of retention times for these metabolites was prepared for the seven columns which represent the most comprehensive study of the properties of different HILIC columns to date. The best all round column was the silica C column which gave good peak shapes for most analytes. Preparation of a new stationary phase was carried out by bonding  $\beta$ -pinene to the silicon hydride surface using the hydrosilation reaction. This phase showed different selectivity than other polar stationary phases under HILIC conditions. Three silicon hydride columns, the Silica C column, the Cogent Diamond Hydride column and the  $\beta$ -pinene column were compared with regard to their retention of metabolites in the urinary metabolome. Again Silica C offered the best all round performance.

A method was developed for the analysis of nicotine in dog fur. It was found that sonication in methanol provided effective extraction method for nicotine from dog hair and this could be followed directly with hydrophilic interaction chromatography which provided a fast and easy method for determining nicotine levels due to passive smoking in dogs. The sample preparation steps in the current case are very simple avoiding potential losses of sample and metabolites, which can occur when digestion in NaOH followed by liquid-liquid extraction or solid phase extraction is used. Since organic solvents are weak solvents in HILIC mode the methanol extract can be injected directly onto the HILIC column without losing sample focusing and thus nicotine release with time can be readily assessed. The method

produced was linear over a wide range with the calibration curve having a slope close to 1 indicating an equal response for nicotine and the deuterated internal standard, precision was determined to be  $\pm 1.9\%$ .

## **6.2 Further work**

The CN column proved very effective for the separation of basic drugs, however, the ACE CN column was not completely stable thus it would be of interest to explore the stability of different manufacturers CN columns to the chromatographic conditions used. Most pharmacopoeial monographs have impurity profiling method using HPLC and it would be of interest to see if the type of selectivity offered by HILIC like chromatography could be used to provide rapid methods for drugs and their impurities with different selectivity. The high organic solvent content of the mobile phase would be readily adaptable to UPLC methods since the high organic content results in low back pressures.

There remains more fundamental work to be done in explaining the retention mechanism of Silica C. An obvious next step would be to explore the effect of varying the anionic and cationic counter ions used in the mobile phase and observing the effect on retention e.g. switching between ammonium acetate and ammonium formate. It would be interesting to see if were possible to make silicon hydride packing with 1.7 $\mu\text{m}$  UPLC particles in order to for instance improve separation of different sugar isomers. There remains also great potential for attaching different surface ligands to the silicon hydride surface.

It would be of interest to extend the method developed for the analysis of nicotine in dog hair to the analysis of drugs in human hair.

There were a number of projects within the current work that were only partially completed hence have not been reported within the thesis. Extensive work was

carried out on a formulation used to treat urinary tract infection containing Coliurinal. This formulation contains the natural product khellin, along with piperazine and hexamine. The two basic compounds are highly polar. Several HILIC columns were tested for the separation of hexamine and piperazine but most did not give good peak shapes. The best results were obtained on an Ascentis bare silica based column which contains fused core silica particles. However, although the method was calibrated it was not possible to obtain good agreement with the label claim for the product. Further work needs to be done to explain this discrepancy and design quality control method for this product which is currently assayed by using titrimetric and colorimetric methods.

A lot of work was carried out during the course of the current study on the separation of acids and sugars on bare silica gel. Although sometimes good peak shapes were obtained this was not the case for all compounds. More work could be carried out to try to determine what conditions might produce better chromatographic performance for these compounds on silica gel.

Some initial work was carried out on the application of HILIC in the analysis of metabolites of natural products produced by incubation with hepatocytes. The application of HILIC, particularly in the analysis of polar phase II metabolites, might be very useful for a metabolism study.



## References

1. Watson, D.G., *Pharmaceutical Analysis: A Textbook for Pharmacy Students and Pharmaceutical Chemists*. 2 ed. 2005, Oxford: Churchill Livingstone.
2. Olsen, B.A., *Hydrophilic interaction chromatography using amino and silica columns for the determination of polar pharmaceuticals and impurities* *Hydrophilic interaction chromatography using amino and silica columns for the determination of polar pharmaceuticals and impurities*. Journal of Chromatography A, 2001. **913**: p. 113-122.
3. Ronald E. Majors and Matthew Przybyciel, *Columns for Reversed-Phase LC Separations in Highly Aqueous Mobile Phases*. LC.GC Europe, 2002. **12**: p. 2-7.
4. Hemström, P. and K. Irgum, *Hydrophilic interaction chromatography*. Journal of Separation Science, 2006. **29**(12): p. 1784-1821.
5. Alpert, A., *Hydrophilic-interaction chromatography for the separation of peptides, nucleic acids and other polar compounds*. Journal of Chromatography A, 1990. **499**: p. 177.
6. Martin, A.J.P. and R.L.M. Synge, *A new form of chromatogram employing two liquid phases, 1. A theory of chromatography 2. Application to the micro-determination of the higher monoamino-acids in proteins*. Biochemical Journal 1941. **35**: p. 1358.
7. McCalley, D.V. and U.D. Neue, *Estimation of the extent of the water-rich layer associated with the silica surface in hydrophilic interaction chromatography*. Journal of Chromatography A, 2008. **1192**(2): p. 225-229.
8. McCalley, D.V., *Study of the selectivity, retention mechanisms and performance of alternative silica-based stationary phases for separation of ionised solutes in hydrophilic interaction chromatography*. Journal of Chromatography A, 2010. **1217**(20): p. 3408-3417.
9. Przybyciel, M. and R.E. Majors, *Phase Collapse in Reversed-Phase LC*. LCGC Europe, 2002: p. 2.
10. Chu, C.H., et al., *A new approach for the preparation of a hydride-modified substrate used as an intermediate in the synthesis of surface-bonded materials*. Analytical Chemistry, 1993. **65**(6): p. 808-816.
11. Molíková, M. and P. Jandera, *Characterization of stationary phases for reversed-phase chromatography*. Journal of Separation Science, 2010. **33**: p. 453-463.
12. Pesek, J.J., M.T. Matyska, and S. Larrabee, *HPLC retention behavior on hydride-based stationary phases*. Journal of separation science, 2007. **30**: p. 637-647.
13. Soukup, J. and P. Jandera, *The effect of temperature and mobile phase composition on separation mechanism of flavonoid compounds on hydrosilated silica-based columns*. Journal of Chromatography A, 2012. **1245**(0): p. 98-108.
14. West, C. and E. Lesellier, *Characterisation of stationary phases in subcritical fluid chromatography with the solvation parameter model: III. Polar stationary phases*. Journal of Chromatography A, 2006. **1110**(1-2): p. 200-213.
15. Liu, X. and C. Pohl, *New hydrophilic interaction/reversed-phase mixed-mode stationary phase and its application for analysis of nonionic ethoxylated surfactants*. Journal of Chromatography A, 2008. **1191**(1-2): p. 83-89.
16. Pazourek, J., *Monitoring of mutarotation of monosaccharides by hydrophilic interaction chromatography*. Journal of separation science, 2010. **33**(6-7): p. 974-981.
17. Jandera, P., et al., *Dual hydrophilic interaction-RP retention mechanism on polar columns: Structural correlations and implementation for 2-D separations on a single column*. Journal of Separation Science, 2010. **33**(6-7): p. 841-852.
18. Jandera, P. and T. Hájek, *Utilization of dual retention mechanism on columns with bonded PEG and diol stationary phases for adjusting the separation selectivity of phenolic and flavone natural antioxidants*. Journal of Separation Science, 2009. **32**(21): p. 3603-3619.

19. Oyler, A.R., et al., *Hydrophilic interaction chromatography on amino-silica phases complements reversed-phase high-performance liquid chromatography and capillary electrophoresis for peptide analysis*. Journal of Chromatography A, 1996. **724**(1–2): p. 378-383.
20. Valette, J.C., et al., *Separation of Tetracycline Antibiotics by Hydrophilic Interaction Chromatography Using an Amino-Propyl Stationary Phase* Chromatographia 2004. **59**: p. 55-60.
21. Wonnacott, D.M. and E.V. Patton, *Hydrolytic stability of aminopropyl stationary phases used in the size-exclusion chromatography of cationic polymers*. Journal of Chromatography A, 1987. **389**(0): p. 103-113.
22. de Person, M., et al., *Development and validation of a hydrophilic interaction chromatography-mass spectrometry assay for taurine and methionine in matrices rich in carbohydrates*. Journal of Chromatography A, 2005. **1081**(2): p. 174-181.
23. Ikegami, T., et al., *Separation efficiencies in hydrophilic interaction chromatography*. Journal of Chromatography A, 2008. **1184**(1–2): p. 474-503.
24. Jandera, P., *Stationary and mobile phases in hydrophilic interaction chromatography: a review*. Analytica Chimica Acta, 2011. **692**(1–2): p. 1-25.
25. Karlsson, G., S. Winge, and H. Sandberg, *Separation of monosaccharides by hydrophilic interaction chromatography with evaporative light scattering detection*. Journal of Chromatography A, 2005. **1092**(2): p. 246-249.
26. Alpert, A.J., *Cation-exchange high-performance liquid chromatography of proteins on poly(aspartic acid)—silica*. Journal of Chromatography A, 1983. **266**(0): p. 23-37.
27. Tolstikov, V.V., N. Tanaka, and O. Fiehn, *Analysis of Highly Polar Compounds of Plant Origin: Combination of Hydrophilic Interaction Chromatography and Electrospray Ion Trap Mass Spectrometry*. Analytical Biochemistry, 2002. **301**: p. 298-307.
28. Mihailova, A., E. Lundanes, and T. Greibrokk, *Determination and removal of impurities in 2-D LC-MS of peptides*. Journal of separation science, 2006. **29**(4): p. 576-581.
29. Han, S.M., *Direct enantiomeric separations by high performance liquid chromatography using cyclodextrins*. Biomedical Chromatography, 1997. **11**(5): p. 259-271.
30. Berthod, A., et al., *Practice and mechanism of HPLC oligosaccharide separation with a cyclodextrin bonded phase*. Talanta, 1998. **47**(4): p. 1001-1012.
31. Risley, D. and M. Strege, *Chiral Separations of Polar Compounds by Hydrophilic Interaction Chromatography with Evaporative Light Scattering Detection*. Analytical Chemistry, 2000. **72**(8): p. 1736-1739.
32. Daunoravicius, Z., et al., *Simple and Rapid Determination of Denaturants in Alcohol Formulations by Hydrophilic Interaction Chromatography*. Chromatographia, 2006. **63**: p. 373-377
  
33. Yoshida, T. and T. Okada, *Peptide separation in normal-phase liquid chromatography: Study of selectivity and mobile phase effects on various columns*. Journal of Chromatography A, 1999. **840**(1): p. 1-9.
34. Al-Tannak, N.F., et al., *The hydrophilic interaction like properties of some reversed phase high performance liquid chromatography columns in the analysis of basic compounds*. Journal of Chromatography A, 2011. **1218**(11): p. 1486-1491.
35. Guo, Y. and S. Gaiki, *Retention behavior of small polar compounds on polar stationary phases in hydrophilic interaction chromatography*. Journal of Chromatography A, 2005. **1074**(1–2): p. 71-80.
36. Jiang, W. and K. Irgum, *Tentacle-Type Zwitterionic Stationary Phase Prepared by Surface-Initiated Graft Polymerization of 3-[N,N-Dimethyl-N-(Methacryloyloxyethyl)-ammonium] Propanesulfonate through Peroxide Groups Tethered on Porous Silica*. Analytical Chemistry, 2002. **74**: p. 4682-4687.

37. Kitano, H., et al., *Raman spectroscopic study on the structure of water in aqueous solution of zwitterionic surfactants*. Journal of Colloid and Interface Science, 2004. **269**(2): p. 459-465.
38. Marrubini, G., B.E.C. Mendoza, and G. Massolini, *Separation of purine and pyrimidine bases and nucleosides by hydrophilic interaction chromatography*. Journal of Separation Science, 2010. **33**(6-7): p. 803-816.
39. Weber, G., N. von Wirén, and H. Hayen, *Hydrophilic interaction chromatography of small metal species in plants using sulfobetaine- and phosphorylcholine-type zwitterionic stationary phases*. Journal of Separation Science, 2008. **31**(9): p. 1615-1622.
40. Tanaka, H., X. Zhou, and O. Masayoshi, *Characterization of a novel diol column for high-performance liquid chromatography*. Journal of Chromatography A, 2003. **987**(1-2): p. 119-125.
41. Bell, D.S., H.M. Cramer, and A.D. Jones, *Rational method development strategies on a fluorinated liquid chromatography stationary phase: Mobile phase ion concentration and temperature effects on the separation of ephedrine alkaloids*. Journal of Chromatography A, 2005. **1095**(1-2): p. 113-118.
42. Scott, R.P.W., *the different form of silica*. advanced chromatography, 1982. **20**(169-187).
43. Li, R. and J. Huang, *Chromatographic behavior of epirubicin and its analogues on high-purity silica in hydrophilic interaction chromatography*. Journal of Chromatography A, 2004. **1041**(1-2): p. 163-169.
44. Minotti G, et al., *Anthracyclines: molecular advances and pharmacologic developments in antitumor activity and cardiotoxicity*. Pharmacological Reviews, 2004. **56**(2): p. 185-229.
45. Guo, Y. and S. Gaiki, *Retention and selectivity of stationary phases for hydrophilic interaction chromatography*. Journal of Chromatography A, 2011. **1218**(35): p. 5920-5938.
46. Nesterenko, P. and P. Haddad, *Zwitterionic Ion-Exchangers in Liquid Chromatography Reviews*. Analytical Sciences, 2000. **16**: p. 565-574.
47. Karatapanis, A.E., Y.C. Fiamegos, and C.D. Stalikas, *HILIC separation and quantitation of water-soluble vitamins using diol column*. Journal of separation science, 2009. **32**(7): p. 909-917.
48. Dell'Aversano, C., P. Hess, and M.A. Quilliam, *Hydrophilic interaction liquid chromatography-mass spectrometry for the analysis of paralytic shellfish poisoning (PSP) toxins*. Journal of Chromatography A, 2005. **1081**(2): p. 190-201.
49. Bhaumik, U., et al., *Determination of Drospirenone in Human Plasma by LC-Tandem-MS*. Chromatographia, 2008. **68**(9): p. 713-720.
50. Kagan, M., et al., *Optimization of normal-phase chromatographic separation of compounds with primary, secondary and tertiary amino groups*. Journal of Chromatography A, 2008. **1194**(1): p. 80-89.
51. McCalley, D.V., *The challenges of the analysis of basic compounds by high performance liquid chromatography: Some possible approaches for improved separations*. Journal of Chromatography A, 2010. **1217**(6): p. 858-880.
52. Markopoulou, C., et al., *A Study of the Relative Importance of Lipophilic,  $\pi$ - $\pi$  and Dipole-Dipole Interactions on yanopropyl, Phenyl and Alkyl LC Phases Bonded onto the Same Base Silica* Chromatographia, 2009. **70**: p. 705-715.
53. Joshi, S.J., P.A. Karbhari, and S.I. Bhoir, *RP-LC Simultaneous Determination of Nebivolol Hydrochloride and Amlodipine Besilate in Bi-Layer Tablets*. Chromatographia, 2009. **70**: p. 557-561.
54. Grumbach, E.S., et al., *Hydrophilic Interaction Chromatography Using Silica Columns for the Retention of Polar Analytes and Enhanced ESI-MS Sensitivity*. LCGC NORTH AMERICA, 2004. **22**: p. 1010-1023.
55. Hsieh, Y. and J. Chen, *Simultaneous determination of nicotinic acid and its metabolites using hydrophilic interaction chromatography with tandem mass spectrometry*. Rapid Communications in Mass Spectrometry, 2005. **19**(21): p. 3031-3036.

56. Oertel, R., U. Renner, and W. Kirch, *Determination of neomycin by LC–tandem mass spectrometry using hydrophilic interaction chromatography*. Journal of Pharmaceutical and Biomedical Analysis, 2004. **35**(3): p. 633-638.
57. McCalley, D.V., *Evaluation of the properties of a superficially porous silica stationary phase in hydrophilic interaction chromatography*. Journal of Chromatography A, 2008. **1193**(1–2): p. 85-91.
58. Giroud, C., et al., *A fatal overdose of cocaine associated with coingestion of marijuana, buprenorphine, and fluoxetine. Body fluid and tissue distribution of cocaine and its metabolites determined by hydrophilic interaction chromatography mass spectrometry(HILIC-MS)*. Journal of Analytical Toxicology 2004. **28**: p. 464-474.
59. Khreit, O.I.G., et al., *Elucidation of the phase I and phase II metabolic pathways of (+/-)-4'-nethylmethcathinone (4-MMC) and (+/-)-4'-(trifluoromethyl)methcathinone (4-TFMMC) in rat liver hepatocytes using LC-MS and LC-MS2*. Journal of Pharmaceutical and Biomedical Analysis, 2012(Article).
60. Koh, H.-L., A.-J. Lau, and E.C.-Y. Chan, *Hydrophilic interaction liquid chromatography with tandem mass spectrometry for the determination of underivatized dencichine ( $\beta$ -N-oxalyl-L- $\alpha$ , $\beta$ -diaminopropionic acid) in Panax medicinal plant species*. Rapid Communications in Mass Spectrometry, 2005. **19**(10): p. 1237-1244.
61. Schlichtherle-Cerny, H., M. Affolter, and C. Cerny, *Hydrophilic Interaction Liquid Chromatography Coupled to Electrospray Mass Spectrometry of Small Polar Compounds in Food Analysis*. Analytical Chemistry, 2003. **75**(10): p. 2349-2354.
62. Dell'Aversano, C., G.K. Eaglesham, and M.A. Quilliam, *Analysis of cyanobacterial toxins by hydrophilic interaction liquid chromatography–mass spectrometry*. Journal of Chromatography A, 2004. **1028**(1): p. 155-164.
63. Charlwood, J., et al., *Analysis of Oligosaccharides by Microbore High-Performance Liquid Chromatography*. Analytical Chemistry, 2000. **72**(7): p. 1469-1474.
64. Yoshida, T., *Peptide separation by Hydrophilic-Interaction Chromatography: a review*. Journal of Biochemical and Biophysical Methods, 2004. **60**(3): p. 265-280.
65. Lindner, H., et al., *Separation of acetylated core histones by hydrophilic-interaction liquid chromatography*. Journal of Chromatography A, 1996. **743**(1): p. 137-144.
66. Al-Bratty, M., et al., *Metabolomic profiling of the effects of allopurinol on Drosophila melanogaster*. Metabolomics, 2011. **7**: p. 542-548.
67. <http://planetorbitrap.com/etg-ets#tab:mass-spectrometry>. 2012 [cited 2012 20/08].
68. Hao, C. and R.E. March, *A survey of recent research activity in quadrupole ion trap mass spectrometry*. International Journal of Mass Spectrometry, 2001. **212**: p. 337-357.
69. [http://www.magnet.fsu.edu/education/tutorials/tools/ionization\\_esi.html](http://www.magnet.fsu.edu/education/tutorials/tools/ionization_esi.html). 2012 [cited 2012 20/08].
70. Scigelova, M. and A. Makarov, *Orbitrap mass analyzer--overview and applications in proteomics*. Practical Proteomics, 2006. **6**: p. 16-21.
71. Pettus, B., et al., *Observation of different ceramide species from crude cellular extracts by normal-phase high-performance liquid chromatography coupled to atmospheric pressure chemical ionization mass spectrometry*. Rapid Communications in Mass Spectrometry 2003. **17**(11): p. 1203-1211.
72. Dams, R., et al., *Influence of the eluent composition on the ionization efficiency for morphine of pneumatically assisted electrospray, atmospheric-pressure chemical ionization and sonic spray*. Rapid Communications in Mass Spectrometry 2002. **16**(11): p. 1072-1077.
73. Kostianen, R. and A.P. Bruins, *Effect of solvent on dynamic range and sensitivity in pneumatically-assisted electrospray (ion spray) mass spectrometry*. Rapid Communications in Mass Spectrometry 1996. **10**(11): p. 1393-1399.
74. Songa, Q. and W. Naidongb, *Analysis of omeprazole and 5-OH omeprazole in human plasma using hydrophilic interaction chromatography with tandem mass spectrometry (HILIC–*

- MS/MS)—Eliminating evaporation and reconstitution steps in 96-well liquid/liquid extraction.* Journal of Chromatography B, 2006. **830**(1): p. 135-142.
75. Chen, X., et al., *Analysis of the acid–base reaction between solid indomethacin and sodium bicarbonate using infrared spectroscopy, X-ray powder diffraction, and solid-state nuclear magnetic resonance spectroscopy.* Journal of Pharmaceutical and Biomedical Analysis, 2005. **38**(4): p. 670-677.
  76. O’Gara, J.E., et al., *Embedded-Polar-Group Bonded Phases for High Performance Liquid Chromatography.* LCGC 2001. **19**: p. 632-642.
  77. Pavitrapok, C. and D.A. Williams, *Determination of methenamine, methenamine mandelate and methenamine hippurate in pharmaceutical preparations using ion-exchange HPLC.* Journal of Pharmaceutical and Biomedical Analysis, 2006. **40**(5): p. 1243-1248.
  78. Alpert, A.J., *Hydrophilic-interaction chromatography for the separation of peptides, nucleic acids and other polar compounds.* Journal of Chromatography A, 1990. **499**(0): p. 177-196.
  79. Park, J.H., et al., *Characterization of some normal-phase liquid chromatographic stationary phases based on linear solvation energy relationships.* Journal of Chromatography A, 1998. **796**(2): p. 249-258.
  80. Marchand, D.H., et al., *Column selectivity in reversed-phase liquid chromatography: VII. Cyanopropyl columns.* Journal of Chromatography A, 2005. **1062**(1): p. 57-64.
  81. Nikolić KI, Velasević KR, and A. LS., *Conductometric determination of methenamine.* Pharm Weekbl Sci. , 1983. **5**(1): p. 28-30.
  82. Kiridena, W. and C. Poole, *Influence of solute size and site-specific surface interactions on the prediction of retention in liquid chromatography using the solvation parameter model.* Analyst, 1998. **123**: p. 1265-1270.
  83. Cheong, W.J. and J.D. Choi, *Linear solvation energy relationships in normal phase liquid chromatography based on retention data on silica in 2-propanol/hexane eluents.* Analytica Chimica Acta, 1997. **342**(1): p. 51-57.
  84. Ismaiel SA and Y. DA., *Volumetric determination of hexamine in some pharmaceutical preparations containing peperazine.* Pharmazie, 1976. **31**(11): p. 821-822.
  85. Okusa, K., H. Tanaka, and M. Ohira, *Development of a new cyano-bonded column for high-performance liquid chromatography.* Journal of Chromatography A, 2000. **869**(1–2): p. 143-149.
  86. Smith, R.M. and S.L. Miller, *Comparison of the selectivity of cyano-bonded silica stationary phases in reversed-phase liquid chromatography.* Journal of Chromatography A, 1991. **464**(0): p. 297-306.
  87. Nieminen AL, et al., *Determination of methenamine in biological samples by gas-liquid chromatography.* journal of chromatography 1980. **181**(1): p. 11-16.
  88. *Partitional mechanism HILIC*  
[http://www.waters.com/webassets/cms/category/media/detail\\_page\\_images/atlantis\\_hilic\\_detail\\_1.gif](http://www.waters.com/webassets/cms/category/media/detail_page_images/atlantis_hilic_detail_1.gif), 2012. **2012**(15/05).
  89. Daunoravičius, Ž., et al., *Simple and Rapid Determination of Denaturants in Alcohol Formulations by Hydrophilic Interaction Chromatography.* Chromatographia, 2006. **63**(7): p. 373-377.
  90. McClintic, C., et al., *Novel Method for the Determination of Piperazine in Pharmaceutical Drug Substances Using Hydrophilic Interaction Chromatography and Evaporative Light Scattering Detection.* Journal of Liquid Chromatography & Related Technologies, 2003. **26**: p. 3093-3104.
  91. Snyder, L.R., J.W. Dolan, and P.W. Carr, *The hydrophobic-subtraction model of reversed-phase column selectivity.* Journal of Chromatography A, 2004. **1060**(1–2): p. 77-116.
  92. Alpert, A., *Hydrophilic-interaction chromatography for the separation of peptides, nucleic acids and other polar compounds.* . Journal of Chromatography A, 1990. **499**: p. 177.

93. Hmelnickis, J., et al., *Application of hydrophilic interaction chromatography for simultaneous separation of six impurities of mildronate substance*. Journal of Pharmaceutical and Biomedical Analysis, 2008. **48**(3): p. 649-656.
94. Liu, M., et al., *Stability-indicating hydrophilic interaction liquid chromatography method for highly polar and basic compounds*. Journal of Chromatography A, 2008. **1188**(2): p. 255-263.
95. Ali, M.S., et al., *A new hydrophilic interaction liquid chromatographic (HILIC) procedure for the simultaneous determination of pseudoephedrine hydrochloride (PSH), diphenhydramine hydrochloride (DPH) and dextromethorphan hydrobromide (DXH) in cough-cold formulations*. Journal of Pharmaceutical and Biomedical Analysis, 2007. **43**(1): p. 158-167.
96. Kamleh, A., et al., *Metabolomic profiling using Orbitrap Fourier transform mass spectrometry with hydrophilic interaction chromatography: a method with wide applicability to analysis of biomolecules*. Rapid Communications in Mass Spectrometry, 2008. **22**(12): p. 1912-1918.
97. Padivitage, N.L.T. and D.W. Armstrong, *Sulfonated cyclofructan 6 based stationary phase for hydrophilic interaction chromatography*. Journal of Separation Science, 2011. **34**(14): p. 1636-1647.
98. Wu, Y.-H., et al., *Determination of caprolactam and 6-aminocaproic acid in human urine using hydrophilic interaction liquid chromatography-tandem mass spectrometry*. Journal of Chromatography B, 2012. **885-886**(0): p. 61-65.
99. Qiu, H., et al., *Development of silica-based stationary phases for high-performance liquid chromatography*. Analytical Bioanalysis Chemistry, 2011. **399**: p. 3307-332.
100. Xu, Y., et al., *Metabolic profiling of fifteen amino acids in serum of chemical-induced liver injured rats by hydrophilic interaction liquid chromatography coupled with tandem mass spectrometry*. Metabolomics, 2012. **8**: p. 475-483.
101. Sandoval, J.E. and J.J. Pesek, *Hydrolytically Stable Bonded Chromatographic Phases Prepared through Hydrosilation of Olefins on a Hydride-Modified Silica Intermediate*. Analytical Chemistry 1991. **63**: p. 2634-2641.
102. Pesek, J.J. and M.T. Matyska, *Our favorite materials: Silica hydride stationary phases*. Journal of Separation Science, 2009. **32**(23-24): p. 3999-4011.
103. Young, J.E., M.T. Matyska, and J.J. Pesek, *Liquid chromatography/mass spectrometry compatible approaches for the quantitation of folic acid in fortified juices and cereals using aqueous normal phase conditions*. Journal of Chromatography A, 2011. **1218**(15): p. 2121-2126.
104. Pesek, J. and M. Matyska, *A new approach to bioanalysis: aqueous normal-phase chromatography with silica hydride stationary phases*. Bioanalysis, 2012. **4**(7): p. 845-853.
105. Pesek, J.J., M.T. Matyska, and A. Dang, *Analysis of cycloserine and related compounds using aqueous normal phase chromatography/mass spectrometry*. Journal of Pharmaceutical and Biomedical Analysis, 2012. **64-65**(0): p. 72-76.
106. Pesek, J.J., et al., *Analysis of hydrophilic metabolites by high-performance liquid chromatography-mass spectrometry using a silica hydride-based stationary phase*. Journal of Chromatography A, 2008. **1204**(1): p. 48-55.
107. Matyska MT, et al., *Aqueous normal phase retention of nucleotides on silica hydride-based columns: method development strategies for analytes relevant in clinical analysis*. Journal of Separation Science 2010. **33**(6-7): p. 930-938.
108. Boysen, R.I., et al., *Simultaneous separation of hydrophobic and hydrophilic peptides with a silica hydride stationary phase using aqueous normal phase conditions*. Journal of Chromatography A, 2011. **1218**(44): p. 8021-8026.
109. Zhang, T., et al., *Evaluation of Coupling Reversed Phase, Aqueous Normal Phase, and Hydrophilic Interaction Liquid Chromatography with Orbitrap Mass Spectrometry for Metabolomic Studies of Human Urine*. Analytical Chemistry, 2012. **84**(4): p. 1994-2001.
110. Mazzobre, M.F., et al., *Octanol-water partition coefficient of glucose, sucrose, and trehalose*. Carbohydrate Research, 2005. **340**(6): p. 1207-1211.

111. Chirita, R.-I., et al., *Investigations on the chromatographic behaviour of zwitterionic stationary phases used in hydrophilic interaction chromatography*. Journal of Chromatography A, 2011. **1218**(35): p. 5939-5963.
112. Ikegawa, S., et al., *Simultaneous Determination of Twelve Tetrahydrocorticosteroid Glucuronides in Human Urine by Liquid Chromatography/Electrospray Ionization-Linear Ion Trap Mass Spectrometry*. Analytical Chemistry, 2009. **81**(24): p. 10124-10135.
113. Jacob Iii, P., et al., *Determination of the nicotine metabolites cotinine and trans-3'-hydroxycotinine in biologic fluids of smokers and non-smokers using liquid chromatography-tandem mass spectrometry: Biomarkers for tobacco smoke exposure and for phenotyping cytochrome P450 2A6 activity*. Journal of Chromatography B, 2011. **879**(3-4): p. 267-276.
114. Rangiah, K., et al., *Nicotine exposure and metabolizer phenotypes from analysis of urinary nicotine and its 15 metabolites by LC-MS*. Bioanalysis 2011. **3**: p. 745-761.
115. Church, T., et al., *Temporal Stability of Urinary and Plasma Biomarkers of Tobacco Smoke Exposure among Cigarette Smokers*. Biomarkers, 2010. **15**(4): p. 345-352.
116. Marclay, F. and M. Saugy, *Determination of nicotine and nicotine metabolites in urine by hydrophilic interaction chromatography-tandem mass spectrometry: Potential use of smokeless tobacco products by ice hockey players*. Journal of Chromatography A, 2010. **1217**(48): p. 7528-7538.
117. Llaquet, H., et al., *Biological matrices for the evaluation of exposure to environmental tobacco smoke during prenatal life and childhood* Analytical and bioanalytical chemistry journal, 2010. **396**(1): p. 379-399.
118. Eisner, M., et al., *Longer term exposure to secondhand smoke and health outcomes in COPD: Impact of urine 4-(methylnitrosamino)-1-(3-pyridyl)-1-butanol*. Nicotine & Tobacco Research, 2009. **11**(8): p. 945-953.
119. Chadwick, C. and B. Keevil, *Measurement of cotinine in urine by liquid chromatography tandem mass spectrometry*. Annals of Clinical Biochemistry, 2007. **44**: p. 455.
120. Jacob N, et al., *Urinary cotinine and nicotine metabolites measurement*. Annals of Clinical Biochemistry 2005. **63**(4): p. 397-409.
121. Shin, H.-S., et al., *Sensitive and simple method for the determination of nicotine and cotinine in human urine, plasma and saliva by gas chromatography-mass spectrometry*. Journal of Chromatography B, 2002. **769**(1): p. 177-183.
122. Greaves R, et al., *A simple high-pressure liquid chromatography cotinine assay: validation of smoking status in pregnant women*. Annals of Clinical Biochemistry, 2001. **38**: p. 333-338.
123. Pichini, S., et al., *Hair analysis for nicotine and cotinine: evaluation of extraction procedures, hair treatments, and development of reference material*. Forensic Science International, 1997. **84**(1-3): p. 243-252.
124. Mahoney, G.N. and W. Al-Delaimy, *Measurement of nicotine in hair by reversed-phase high-performance liquid chromatography with electrochemical detection*. Journal of Chromatography B: Biomedical Sciences and Applications, 2001. **753**(2): p. 179-187.
125. Bernert, J.T., et al., *Time Course of Nicotine and Cotinine Incorporation into Samples of Nonsmokers' Beard Hair Following a Single Dose of Nicotine Polacrilex*. Journal of Analytical Toxicology, 2011. **35**: p. 1-7.
126. Ryu, H.-J., et al., *Simultaneous and sensitive measurement of nicotine and cotinine in small amounts of human hair using liquid chromatography/tandem mass spectrometry*. Rapid Communications in Mass Spectrometry, 2006. **20**(18): p. 2781-2782.
127. Chetiyankornkul, T., et al., *Hair analysis of nicotine and cotinine for evaluating tobacco smoke exposure by liquid chromatography-mass spectrometry*. Biomedical Chromatography, 2004. **18**(9): p. 655-661.
128. Man, C.N., et al., *Determination of hair nicotine by gas chromatography-mass spectrometry*. Journal of Chromatography B, 2009. **877**(3): p. 339-342.

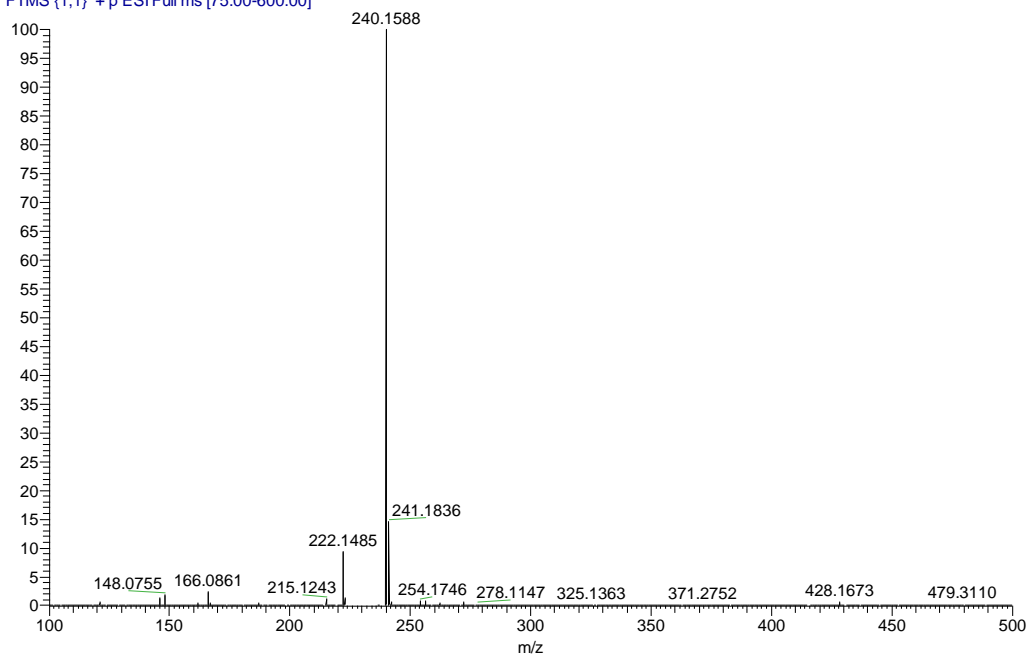
129. Toraño, J.S. and H.J.M.v. Kan, *Simultaneous determination of the tobacco smoke uptake parameters nicotine, cotinine and thiocyanate in urine, saliva and hair, using gas chromatography-mass spectrometry for characterisation of smoking status of recently exposed subjects*. *Analyst*, 2003. **128**: p. 838-843.
130. Kalkbrenner, A.E., et al., *Determinants of serum cotinine and hair cotinine as biomarkers of childhood secondhand smoke exposure*. *Journal of Exposure Science and Environmental Epidemiology*, 2010. **20**(7): p. 615-624.
131. Denk O, Skellern G, and Watson D, *Impurity profiling of pholcodine by liquid chromatography electrospray ionization mass spectrometry (LC-ESI-MS)*. *Journal of Pharmacy and Pharmacology* 2002. **54**(1): p. 87-98.
132. Janne Hukkanen, Peyton Jacob, and N.L. Benowitz, *Metabolism and Disposition Kinetics of Nicotine*. *Pharmacological Reviews* 2005. **57**: p. 79-115.
133. Diaz SF, et al., *An analysis of canine hair re-growth after clipping for a surgical procedure*. *Veterinary Dermatology* 2004. **15**(1): p. 25-30.
134. Musshoff, F. and B. Madea, *Analytical pitfalls in hair testing*. *Analytical and Bioanalytical Chemistry*, 2007. **388**(7): p. 1475-1494.
135. Hill V, Cairns T, and S. M., *Hair analysis for cocaine: factors in laboratory contamination studies and their relevance to proficiency sample preparation and hair testing practices*. *Forensic Science International* 2007. **21**(1): p. 23-33.
136. Heather Wipfli, et al., *Secondhand Smoke Exposure Among Women and Children: Evidence From 31 Countries*. *Journal of Public Health*, 2008. **98**(4): p. 672-679.
137. L.Q. Sheng, et al., *Determination of Nicotine-Related Alkaloids in Tobacco and Cigarette Smoke by GC-FID*. *Chromatographia*, 2005. **62**: p. 63--68.



## Appendix I

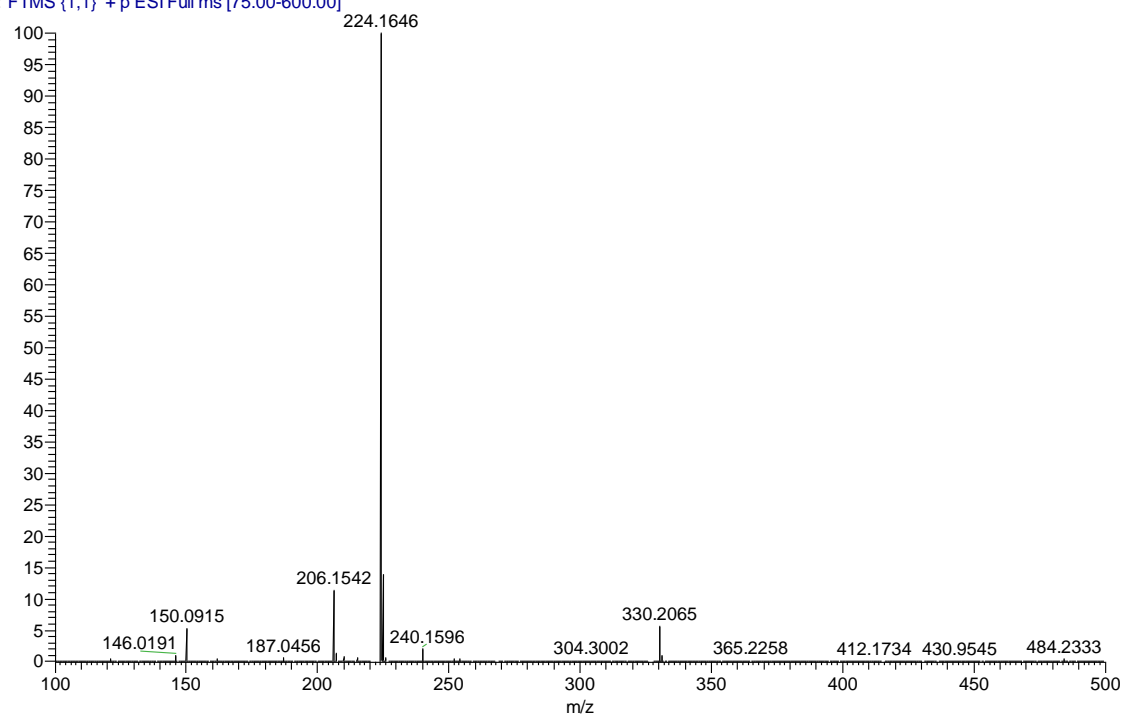
**Figure A1.1** ESI mass spectrum of salbutamol

SB0002 #2913 RT: 25.44 AV: 1 SB: 2 14.12, 16.69 NL: 2.82E7  
T: FTMS (1,1) + p ESI Full ms [75.00-600.00]



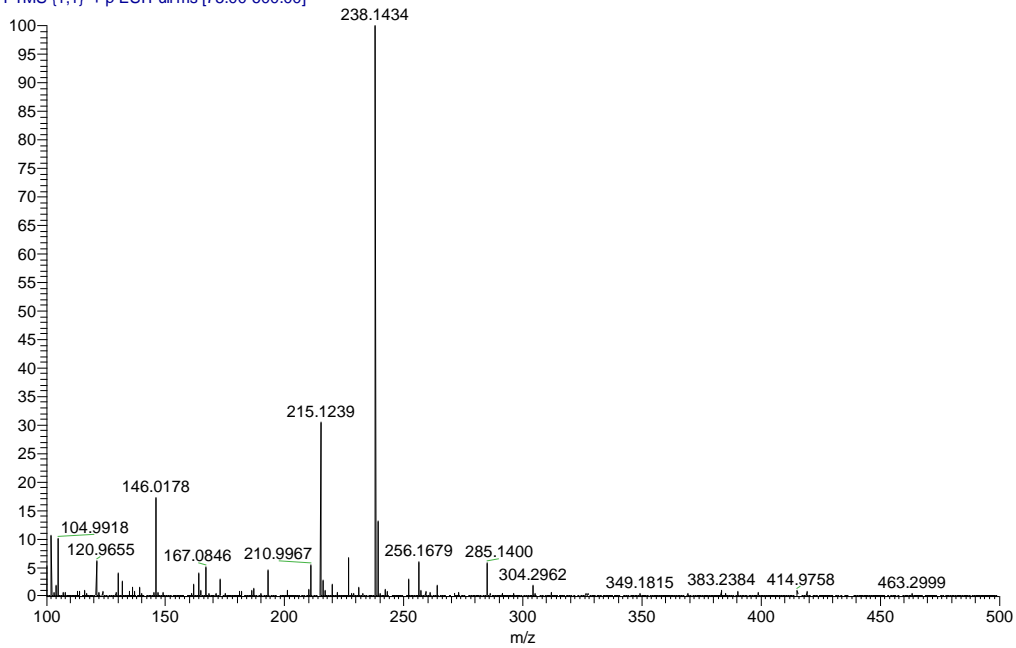
**Figure A1.2** ESI mass spectrum of desoxysalbutamol

SB0002 #2128 RT: 19.41 AV: 1 SB: 2 14.12, 16.69 NL: 1.61E7  
T: FTMS (1,1) + p ESI Full ms [75.00-600.00]

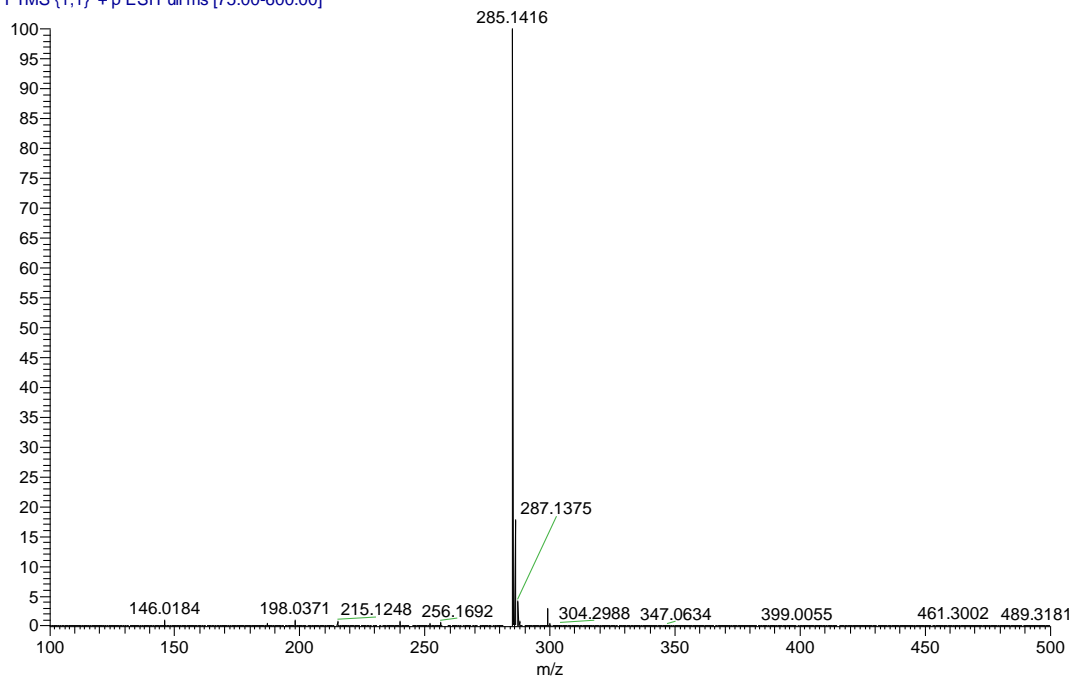


**Figure A1.3** ESI spectrum of salbutamol ketone

SB0002 #1624 RT: 15.02 AV: 1 SB: 2 14.06, 19.22 NL: 7.83E5  
T: FTMS (1,1) + p ESI Full ms [75.00-600.00]

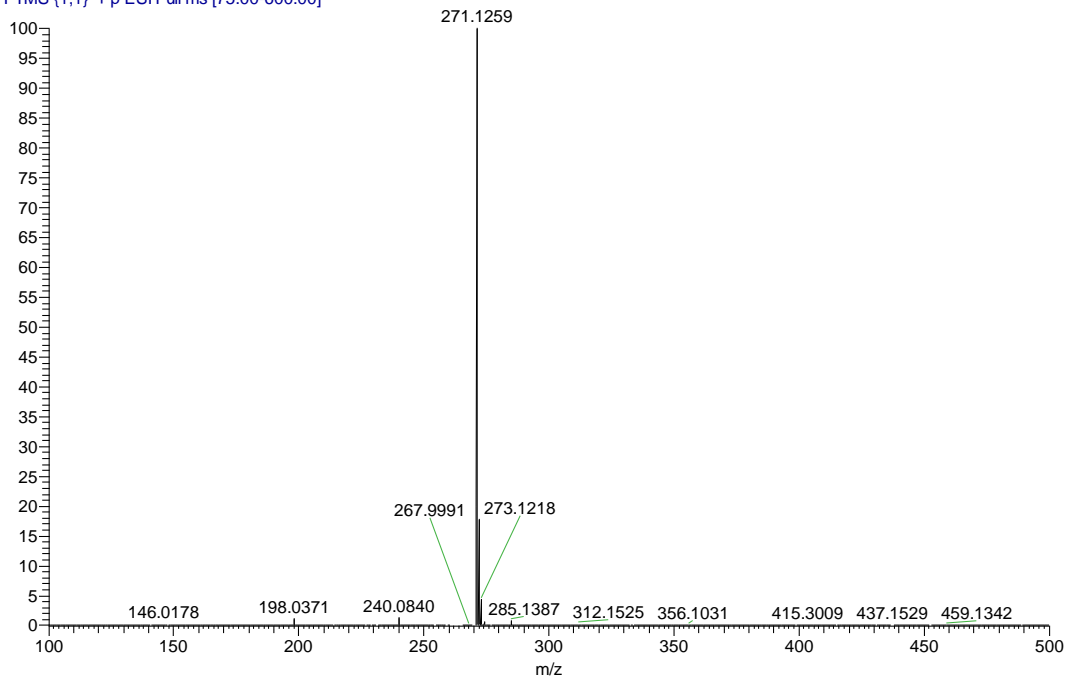
**Figure A1.4** ESI mass spectrum of promethazine.

SB0003 #978 RT: 8.22 AV: 1 SB: 2 14.05, 19.21 NL: 2.35E7  
T: FTMS (1,1) + p ESI Full ms [75.00-600.00]

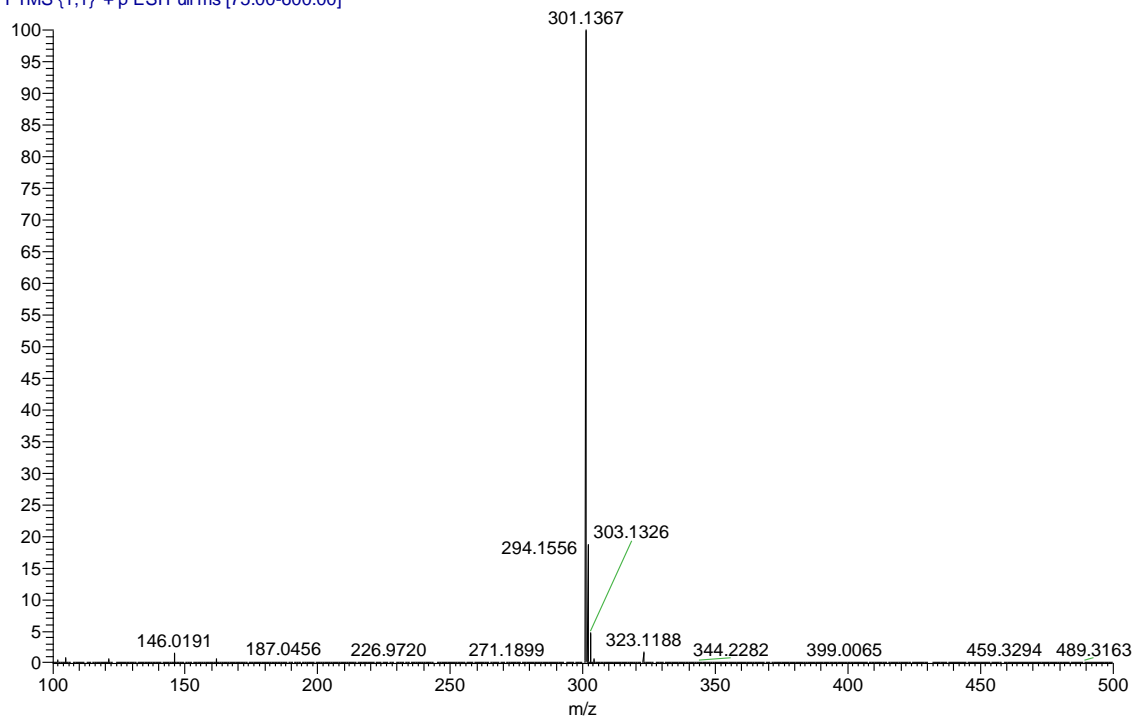


**Figure A1.5** ESI mass spectrum of desmethyl promethazine.

SB0003 #1432 RT: 11.79 AV: 1 SB: 2 10.92, 12.29 NL: 3.15E7  
T: FTMS (1,1) + p ESI Full ms [75.00-600.00]

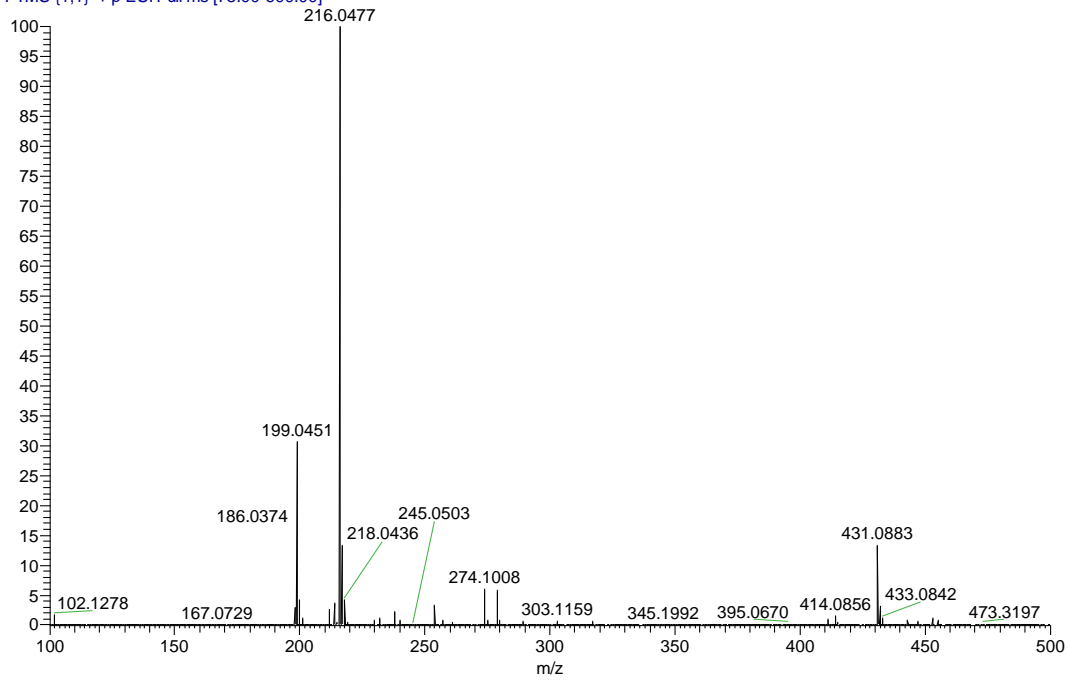
**Figure A1.6** ESI mass spectrum of promethazine S-oxide.

SB0003 #2467 RT: 20.43 AV: 1 SB: 2 10.92, 12.29 NL: 8.36E6  
T: FTMS (1,1) + p ESI Full ms [75.00-600.00]



**Figure A1.7** ESI mass spectrum of promethazine tricyclic impurity.

SB0003 #208 RT: 1.84 AV: 1 SB: 2 10.92, 12.29 NL: 1.00E7  
T: FTMS (1,1) + p ESI Full ms [75.00-600.00]



## Appendix II

**Table A II.1** Retention times of metabolite standards run with 0.1% v/v formic acid (FA) and 10 mM ammonium acetate on 7 different HILIC columns.

Compound	Silica FA	Silica AAc	Silica C FA	Silica C AAc	Luna HILIC FA	Luna HILIC AAc	Luna NH2 FA	Luna NH2 AAc	Diam Hyd FA	Diam Hyd AAc	Pin Hyd FA	Pin Hyd AAc	Nucl FA	Nucl AA
<b>Phosphates</b>														
AMP	7.9	9.1	-	12.2	8.9	7.6	-	-	12.8	11.9	10.6	10.4	8.7	9.3
dAMP	8.2	9.4	-	14.1	7.6	7.3	-	-	-	-	11.3	10.9	-	-
Glucose 6-phosphate	11.9	10.6	-	13.4	11.4	8.2	5.4	-	11.0	11.6	8.2	9.9	41.9	9.9, 16.46
N-acetylglucosamine 6-phosphate	12.0	10.8	-	14.1	10.9	7.8	-	-	10.9	11.8	8.3	10.1	-	16.0
Ethanolamine phosphate	8.4	13.5	-	20.0	7.2	8.7	24.3	-	13.5	17.5	11.1	14.9	16.5	18.0
Glucosamine phosphate	8.2	10.3	-	17.4	8.4	9.2	-	-	12.6	15.2	10.4	13.0	18.8	20.4
Phosphoenol pyruvate	-	8.9	-	13.5	9.8	8.2	-	-	-	11.8	7.6	10.1	-	18.4

UMP	5.4	8.4	-	13.5	10.5	6.9	-	-	9.6	10.7	8.1	9.3	-	-
IMP	5.8	8.8	-	13.0	10.7	7.0	8.4	-	10.9	11.3	8.7	9.9	40.1	15.2
CMP	8.2	9.7	14.9	12.9	7.5	8.1	-	-	12.8	12.3	11.7	10.7	18.3	15.8
3-Aminobutyric acid	6.1	9.1	19.5	17.5	2.6	6.0	3.9	9.1	15.3	15.6	11.5	12.9	7.6	14.6
Valine	5.6	6.3	17.1	14.8	4.5	5.3	5.5	7.8	14.0	13.3	10.9	11.0	9.7	13.0
Leucine	3.7	4.2	18.5	12.1	3.3	4.7	4.2	6.5	13.1	12.1	7.7	10.4	8.9	11.4
Isoleucine	5.5	6.4	18.2	14.0	3.5	4.8	4.5	6.9	13.8	12.5	7.5	10.6	9.1	11.9
methionine	5.6	6.3	17.1	14.8	4.3	4.9	5.5	7.8	14.0	13.3	10.9	11.0	9.8	12.2
tyrosine	3.6	4.0	22.9	10.2	2.3	3.1	2.2	4.0	15.1	10.6	7.4	8.8	4.1	7.7
Phenylalanine	5.2	5.7	17.3	12.4	3.8	4.5	4.6	6.6	12.8	11.1	10.3	9.9	9.1	11.0
Tryptophan	5.0	5.3	18.4	11.3	3.6	4.6	4.3	6.8	12.7	10.6	10.3	9.6	9.2	11.6
Proline	7.8	8.6	14.2	17.4	4.6	5.3	14.2	17.4	15.0	15.6	12.0	12.8	11.6	13.5
Taurine	4.6	5.5	5.4	12.2	5.1	5.3	9.4	9.1	9.3	10.3	7.8	8.7	13.8	13.8
Serine	6.6	7.9	14.0	14.8	5.2	5.6	9.4	10.4	13.4	13.1	10.5	10.9	12.7	15.1
Homocysteine	5.6	6.5	16.0	17.1	4.6	8.1	6.1	12.8	16.3	-	12.5	12.9	13.2	-
Homoserine	6.7	8.0	14.6	15.2	4.8	6.4	8.3	9.6	13.8	13.3	10.9	11.2	12.1	14.7
Threonine	6.1	7.1	14.5	15.0	4.8	6.3	8.5	9.6	13.4	12.9	10.1	11.0	12.2	12.99, 14.38

Glycine	6.3	8.2	15.1	15.9	4.7	6.5	8.2	9.9	12.5	13.6	9.0	11.4	12.0	15.0
Sarcoxie	6.9	8.6	14.7	16.9	4.5	5.8	7.9	9.1	14.5	14.8	11.1	12.2	11.3	14.4
Hydroxyproline	6.5	8.6	13.2	15.7	4.8	6.0	9.2	10.3	13.4	14.3	9.2	11.9	12.9	14.7
Glutamine	6.8	8.3	13.8	15.1	5.0	6.6	8.7	-	13.6	13.6	9.2	11.4	12.6	-
O-acetylserine	5.9	6.9	12.8	13.6	4.7	5.1	7.5	8.8	12.5	12.0	9.9	10.2	11.6	13.0
Glutamate	5.7	7.1	13.9	13.7	4.7	5.1	7.1	8.4	11.4	12.4	8.7	10.5	11.2	12.8
Aspartate	3.8	7.8	13.0	13.0	4.9	7.1	-	-	12.2	12.2	7.8	9.4	14.5	14.9
Lysine	9.7	20.2	25.3	39.0	4.8	9.5	3.8	8.1	19.9	35.4	14.3	25.1	10.2	21.2
N-acetyllysine	6.5	10.7	18.4	19.0	4.1	6.9	3.9	10.7	16.0	16.8	12.3	13.8	8.9	16.0
ornithine	9.5	19.5	22.2	37.4	4.9	9.6	3.8	8.4	19.3	34.0	13.8	24.2	10.4	31.5
Histidine	9.2	14.6	20.8	19.6	4.7	6.9	3.9	10.3	19.2	17.8 b	13.7	15.9	9.9	16.1
Arginine	9.1	17.9	25.5	35.3	4.7	9.0	3.5	7.2	19.6	34.0	11.5	24.2	10.1	29.0
Cystathione	9.1	11.3	14.9	17.3	6.5	8.7	12.5	13.9	15.8	15.3	11.7	13.1	15.2	17.5
Cystine	9.2	10.9	13.3	17.8	7.2	8.7	13.5	16.6	15.2	15.1	11.6 b	13.0 t	16.0	17.5
<b>Amines</b>														
Acetyl choline	6.7	13.7	-	-	2.3	3.7	52.6	1.9	20.9	-	13.4	33.2	-	-
Putrescine	9.1	-	37.8	-	4.5	11.6	1.7	13.7 t	25.3 t	-	17.4 t	-	9.0	-
Glucosamine	6.4	9.8	17.4	20.3 b	4.7	6.9	3.8	6.6	15.5	17.7 b	7.6 b	14.5 b	9.5	19.69,

														21.37
kynurenine	5.1	5.5	17.9	11.8	3.6	4.5	4.5	6.5	12.9	10.8	10.3	9.7	9.1	11.1
serotonin	5.2	7.5	13.1	16.2	2.4	4.8	-	2.1	13.1	17.5	7.4	15.8	4.2	14.9
Dopamine	3.6	9.6	20.1	17.2	2.6	4.3	1.6	2.2	9.7 b	18.2	7.3	-	7.6	16.5
Noradrenaline	5.5	11.2	19.2	17.9	2.6	5.6	1.6	3.8	14.9	18.0	11.4	-	7.6	20.3
Adrenaline	3.6	10.8	19.5	18.6	2.6	4.6	1.6	3.7	10.3	19.8	7.3	-	7.7	17.8
Metanephrine	5.4	9.0	22.0	20.2	2.2	4.3	1.5	2.1	15.3	21.7	11.4	18.1	4.3	15.1
Phenylethylamine	5.1	7.3	12.9	18.4	2.3	3.7	-	1.9	14.8	20.1	12.9	18.4	3.9	12.5
Histamine	9.2	17.9	24.6 t	-	4.3	6.7	1.5	5.2	25.3 t	-	18.1	38.2 t		
Creatine	3.7	8.9	18.0	16.7	3.4	6.1	4.3	8.8	12.5	15.3	7.4	12.8	9.5	14.6
Creatinine	3.9	5.3	20.5 t	12.8	2.4	3.9	5.0		14.1 b	11.9	7.3	10.0	-	-
Allantoin	3.5	3.7	6.4	8.0	3.8	3.9	5.6	5.8	7.3	7.6	6.8	7.1	10.4	10.5
Alanine methyl ester	4.4	6.2	15.0	33.4	4.4	4.7	1.6	2.1	15.8	27.1	11.8	19.1	4.2	13.4
Adenine	3.8	8.0	13.7	10.9	2.6	5.0	20.9	2.20, 3.66	13.4	17.8	-	15.6	7.42, 7.47	15.6
cytosine	3.9	4.8	18.7 t	11.5	-	-	-	5.1	13.5 b	10.6	7.3	9.2	-	-
cytidine	5.1	5.7	17.8	10.9	3.5	4.5	3.9	6.8	13.7 b	9.7	7.3	8.5	9.5	11.3
Methylthioadenosine	3.7	3.5	10.8	8.0	3.3	3.3	16.5	3.7	11.1	7.7	10.9	7.5	7.6	7.6



Adenosine	4.5	4.3	12.2	9.6	3.9	4.0	13.7	5.1	11.9	9.2	9.3	8.4	8.7	9.3
guanine	4.1	4.4	7.0	10.1	4.5	4.6	5.6	7.8	9.0	9.6	7.7	8.1	10.01, 11.28	10.86, 11.44
guanosine	4.1	4.4	10.1	10.1	4.5	4.6	7.2	7.8	9.0	9.1	7.7	8.1	11.3	11.4
hypoxanthine	4.0	4.1	6.6	9.9	3.8	3.9	5.1	6.4	9.1	9.2	8.0	8.2	9.1	9.4
Inosine	4.0	4.3	5.7	9.9	4.1	4.1	6.1	7.2	8.4	8.8	7.5	7.9	10.4	10.5
S-adenosyl homocysteine	8.0	8.6	18.6	15.4	5.2	7.1	7.1	10.3	17.4	13.6	14.1	11.8	11.1	14.3
Betaine	8.6	9.6	19.2	17.8	4.4	4.7	6.8	6.9	17.6	18.0	13.6	14.3	11.4	12.8
Acetylcarnitine	6.3	12.2	23.2	26.3	2.2	4.9	-	-	17.8	22.8	12.5	17.4	4.3	13.5
Sepiapterin	3.6	3.8	5.9	9.1	3.8	3.8	4.8	5.3	8.0	-	7.4	7.7	7.8	-
<b>Acids</b>														
Hydroxy butanoic	3.1	4.5	15.0	9.0	2.9	4.4	5.9	35.5	6.3	8.7	6.4	7.4	7.6	11.2
Malate	3.0	6.6	6.5	9.0	3.4	6.7	5.5	-	6.8	9.0	6.2	BP	11.0	16.6
Fumarate	2.8	5.4	5.9	10.2	2.9	6.6	-	-	5.7 sp	8.3	6.1	7.0	9.4	17.1
Succinate	2.9	6.1	6.1	11.2	3.0	6.2	-	35.7	5.8	8.8	6.0	7.3	6.9	15.2
Methylmalonate	2.9	3.6	5.6	6.2	3.1	4.3	-	29.7	6.0	5.5	6.1	5.5	9.1	10.6
Malonate	3.0	3.7	6.5	14.8	3.6	4.5	-	-	6.0	6.1	6.2	5.2	15.7	12.0
Citraconate	2.8	3.5	5.7	5.5	3.2	3.5	5.4	-	5.7	6.0	6.0	5.9	7.6	9.1

pyruvate	7.0	7.9	-	5.9	3.9	3.6	-	-	6.1	5.3	6.3	5.1	28.1	8.9
Itaconate	2.8	4.0	5.6	7.5	2.9	3.4	4.9	26.6	6.0	5.8	6.1	5.6	6.7	7.9
Ketoglutaric	3.0	4.6	6.1	7.7	4.1	6.0	5.3	-	6.0	7.5	6.0	5.9	28.3	15.9
Citrate*	3.3	14.9	20.9	6.6	3.7	8.0	5.5	-	6.0	6.5	6.1	-	9.0	9.1
Isocitrate*	3.1	8.7	-	11.3	3.6	7.3	-	-	6.4	11.2	6.1	-	14.5	17.4
Aconitic acid	2.8	4.0	4.1	5.6	3.3	5.9	5.4	-	2.7	6.0	6.0	5.2	7.8	-
nicotinate	3.5	4.1	8.7	10.1	3.1	4.3	30.9	-	8.4	8.7	7.4	7.4	8.1	11.1
nicotinamide	3.9	3.7	11.0	9.2	3.3	3.3	3.8	3.7	10.5	8.6	8.6	7.9	7.6	7.7
pantothenate	3.3	4.7	5.8	10.3	2.8	4.6	9.0	30.5	6.0	8.6	6.5	7.3	7.6	10.6
Indole carboxylic acid	2.7	2.7	5.3	5.3	2.7	3.4	6.0	3.7	5.4	5.0	10.6	5.1	5.9	8.6
N-acetyl aspartate	10.4	13.2	20.8	26.9	4.7	6.8	3.8	10.4	20.8	23.1	14.8	18.0	10.0	17.2
Oxoproline	3.4	5.4	6.1	10.0	3.4	5.1	5.9	34.2	7.2	9.6	6.8	8.1	10.6	12.3
Phenylglycine	4.4	5.8	12.2	11.8	4.4	4.9	15.7	7.9	11.9	11.2	7.4	9.8	10.0	12.2
Taurocholic acid	3.7	2.5	3.9	4.9	7.3	3.3	-	13.7	6.5	4.8	7.7	4.8	-	7.0
<b>Sugars</b>														
Glucose	9.6	7.3	9.7	11.0	5.0	5.2	5.4	8.1	8.2	8.7	7.2	7.8	12.8	12.9
Fructose	9.7	7.4	9.6	10.7	4.7	4.8	7.8	7.2	8.8	9.0	7.0	7.9	12.0	12.0
Fucose	9.2	7.4	5.7	9.8	4.3	4.3	5.7	6.3	8.2	8.7	7.2	7.8	11.2	11.3

xylose	6.8	7.2	8.8	9.5	4.3	4.5	6.7	6.5	6.1	8.4	7.0	7.4	10.97, 11.56	11.7
arabinose	9.5	8.5	9.7	10.7	4.4	4.6	7.7	6.6	8.6	8.9	7.3	7.8	11.5	11.90, 12.79
galactose	10.0	8.2	10.1	11.2	5.3	5.3	9.0	7.9	8.8	9.4	7.6	8.1	13.0	13.2
mannose	9.8	8.6	9.2, 9.9	10.7	5.0	5.0	7.9	7.5	8.4	9.2	7.3	7.9	11.03, 12.79	12.5
mannitol	10.2	8.3	10.3	11.6	5.1	5.3	8.5	7.9	8.4	8.6	7.7	8.3	12.6	12.8
N-acetylmannosamine	4.4	4.9	5.5	11.4	4.5	4.6	7.1	6.9	9.1	9.6	7.9	8.2	11.7	11.9
N-acetylglucosamine	9.8	8.1	10.1	11.0	4.7	4.7	7.2	6.8	9.1	9.5 b	5.5	11.0	11.69	11.9
maltose	10.7	8.4	10.7	12.2	6.3	6.5	10.4	9.6	9.3	10.0	7.7	8.3	14.0	14.5
glucuronate	8.5	6.3	8.2	7.8	5.0	6.4	-	-	6.8	6.1	6.5	5.5	-	-
galacturonate	8.5	7.1	8.7	10.9	5.0	6.8	4.3	-	7.6	9.2	6.8	7.4	15.6	14.4

**Appendix III**

**STUDY INTO NICOTINE CONCENTRATIONS  
IN THE HAIR OF PETS EXPOSED TO TOBACCO SMOKE**

Investigator: Professor Clare Knottenbelt BVSc MSc DSAM MRCVS,  
School of Veterinary Medicine, University of Glasgow

All information provided in this questionnaire will be used for research purposes only and will  
remain confidential

Project Pet Number:

**Please enter the date of completion of this questionnaire:** \_\_\_\_\_

*Please enter the following details for your pet:*

**Species** (*please circle*): Dog / Cat

**Age:** \_\_\_\_\_ years                      **Breed:** \_\_\_\_\_

**Sex** (*please circle*): Male / Female                      **Neutered** (*please circle*): Yes / No

**Approximately how much time does your pet spends indoors?**                      \_\_\_ hrs / day

**Approximately how much time does your pet spends outdoors?**                      \_\_\_ hrs / day

**1. Has your pet been in contact with tobacco smoke at any point in the last 3 months?** (*please circle*)  
Regularly/ Occasionally /Never

(if Never, then you do not need to complete the rest of the questionnaire)

**2. When your pet is in contact with tobacco smoke where does this take place?** (*please circle*)

During close contact with smoker                      Regularly/ Occasionally /Never

In pet's Home                      Regularly/ Occasionally /Never

During car travel                      Regularly/ Occasionally /Never

In friend's or family's Home                      Regularly/ Occasionally /Never

Outdoors                      Regularly/ Occasionally /Never

**3. How many smokers does your pet come into contact with?** \_\_\_\_\_

For each smoker, please state how many cigarettes or other tobacco products are smoked each day:

**Smoker 1**                      \_\_\_ Cigarettes per day;                      \_\_\_ other tobacco products per day

**Smoker 2**                      \_\_\_ Cigarettes per day;                      \_\_\_ other tobacco products per day

**Smoker 3**                      \_\_\_ Cigarettes per day;                      \_\_\_ other tobacco products per day

**Smoker 4**                      \_\_\_ Cigarettes per day;                      \_\_\_ other tobacco products per day

**Smoker 5**                      \_\_\_ Cigarettes per day;                      \_\_\_ other tobacco products per day

## Appendix IV

### Publications Arising From the Thesis

1. Knottenbelt CM, Bawazeer S, Hammond J, Mellor D and Watson DG (2012) Nicotine hair concentrations in dogs exposed to environmental tobacco smoke: a pilot study. *Journal of Small Animal Practice* **53**:623-626.
2. Bawazeer S, Sutcliffe OB, Euerby MR, Bawazeer S and Watson DG (2012) A comparison of the chromatographic properties of silica gel and silicon hydride modified silica gels. *Journal of Chromatography A* **1263**:61-67.
3. Bawazeer S, Watson DG and Knottenbelt C (2012) Determination of nicotine exposure in dogs subjected to passive smoking using methanol extraction of hair followed by hydrophilic interaction chromatography in combination with Fourier transform mass spectrometry. *Talanta* **88**:408-411.
4. Al-Tannak NF, Bawazeer S, Siddiqui T and Watson DG (2011) The hydrophilic interaction like properties of some reversed phase high performance liquid chromatography columns in the analysis of basic compounds. *Journal of Chromatography A* **1218**:1486-1491.