

University of Strathclyde
Department of Naval Architecture and Marine Engineering

Automatic Simulation of Ship Navigation in Confined Waterways

by

YANZHUO XUE

A thesis presented in fulfilment of the requirements
for the degree of Doctor of Philosophy

June 2010

The copyright of this thesis belongs to the author under the terms of the United Kingdom Copyright Acts as qualified by University of Strathclyde Regulation 3.50. Due acknowledgement must always be made of the use of any material contained in, or derived from, this thesis.

- Dedicated to my dearest parents Wenbo Xue and Xiuying He -

For educating me and for their endless love and support

- Dedicated to my darling wife Nana Yang -

For her endless love, support, patience, and encouragement

Acknowledgements

First of all, I wish to express my limitless thank to my supervisor, Dr B. S. Lee. I always felt that he is not only my supervisor, but also my teacher, adviser, friend, and, even more importantly, tough opponent in discussions. It is he who made me realise that a Ph.D. research work is a kind of training in how to think, present an idea, argue, debate, listen to other people, find a problem, formulate and solve it, etc. As such, I felt that it has been a painful process, requiring dedication, persistence, and patience to undertake it. Dr Lee always encouraged me when I felt “low” in conducting the research. He guided me through the research with his extensive knowledge, experience and ever optimism. Without him, this thesis could never have been accomplished.

I express sincere gratitude to Professor Peilin Zhou who offered me the opportunity to study at University of Strathclyde and opened my eyes to the wider world and gave countless encouragement and full support throughout.

Special thanks are sent to Professor Duanfeng Han and Professor Xiongliang Yao, Head of College of Shipbuilding Engineering of Harbin Engineering University, for their continual encouragement and full support throughout.

I warmly thank all my colleagues, in particular Dr. Qing Xiao, Dr. Qiuxin Gao, Xu Li, Xia Jie, Liang Shen, Hao Cui, Wei Shao, Kwang Sic Chung, Ju Young Kang, for their valuable advice and friendship during this period.

My sincere thanks to my Chinese friends in Glasgow for organizing warm social activities for relaxation.

I would like to express my deep gratitude to my parents in China who have given me endless support and encouragement. I would not be able to succeed without their support.

Finally, I would like to thank my dearest wife Nana Yang, who has given me limitless love, encouragement and understanding over the years.

Abstract

An automatic manoeuvring simulation is a cost-effective tool for minimising accidents and assisting design and operational planning which does not involve a human steersman but realistically emulates his/her performance.

Automatic simulation of ship manoeuvring has to be able to control the ship automatically to reach a destination point whilst avoiding other ships and navigational hazards, keeping well clear of non-navigable areas, such as shallow water and shore line. One of the key problems in this task is automatic route planning and collision avoidance.

This thesis concentrates on developing a simple and practical method of automatic trajectory planning and collision avoidance based on an artificial potential field. The potential field method first applied in robotic research is used for ship route finding. The method has been adopted successfully for automatic navigation in busy, dynamic and confined seaways. In this work, 3 DOF ship manoeuvring model is used based on the assumptions that the ship sails in calm water and shallow water effects and other external forces can be ignored. For the sake of simplicity sub optimal paths are accepted and location and strength of repulsion points are set manually. A simple and effective method is introduced for detecting potential collision situation. The parameters of safe passing distance, collision avoidance distance and range of checking collision are defined. Collision prevention regulations and international navigational rules are incorporated into the algorithm. A dynamic route generation method using cubic spline is developed to generate real-time route. The PID controller is designed to control the ship. The developed algorithm is fairly straightforward and simple to implement, and has been shown to be effective in

decision support and automatic ship handling for all ships involved in complex situations.

The method has been applied to some typical test cases and the simulation results illustrate its effectiveness in tackling all the problems identified.

Finally, the strengths and weaknesses of the system have been discussed and the further work to enhance the capability of the system has been identified.

Contents

Acknowledgements.....	iv
Abstract.....	vi
Contents.....	viii
List of Figures.....	xii
List of Tables	xix
Nomenclature.....	xx
Notation.....	xx
Abbreviations	xxiii
Chapter 1: Introduction	1
1.1 Background.....	1
1.2 Outline of the Thesis.....	6
Chapter 2: Aims of the Thesis.....	8
Chapter 3: Critical Review.....	10
3.1 Introduction.....	10
3.2 Ship Manoeuvring Simulation	10
3.3 Automatic Ship Navigation System.....	12
3.4 The Need for Further Research.....	22
3.4.1 Discussion of Past Work	22
3.4.2 Adopted Approach.....	23
Chapter 4: Manoeuvring Model Used.....	26
4.1 Introduction	26
4.2 Reference Frames	26

4.3 Equations of Motion	28
4.4 Manoeuvring Model Used	32
Chapter 5: Automated Route Finding	40
5.1 Introduction	40
5.2 Route Finding	40
5.3 Potential Field Method Applied to Route Finding for a Ship.....	41
5.3.1 Attractive Potential Function.....	43
5.3.2 Repulsive Potential Function.....	47
5.3.3 Total Potential Function	55
5.3.4 The Description of Obstacles	55
5.3.5 Limitations with Potential Field Method.....	61
Chapter 6: Automatic Collision Avoidance.....	69
6.1 Introduction	69
6.2 International Regulations for Prevention of Collisions at Sea	70
6.3 Determination of Possible Collision.....	71
6.3.1 Some Criteria Used in Detecting Possible Collision.....	72
6.3.2 Parameters Used in Determination of Possible Collision	74
6.4 Determination of Encounter Type	77
6.4.1 Overtaking Situation.....	77
6.4.2 Head-on Situation.....	79
6.4.3 Crossing Situation	81
6.5 Strategy of Collision Avoidance.....	82
6.5.1 Action to Avoid Collision	83
6.5.2 Two-Ship Encounter.....	85
6.5.3 Multiple-Ship Encounter	88
Chapter 7: Dynamic Route Generation and Heading Control.....	92
7.1 Introduction	92

7.2 Route Generation.....	92
7.2.1 Way-Point Representation.....	92
7.2.2 Route Generation using Straight Lines and Circular Arcs.....	94
7.2.3 Cubic Spline Algorithm for Route Generation.....	95
7.3 Dynamic Route Generation.....	96
7.4 Desired Heading along the Route.....	100
7.5 PID Controller.....	101
Chapter 8: Implementation of Simulation Tool and Case Studies	103
8.1 Introduction.....	103
8.2 The Fundamental Case Studies.....	104
8.2.1 Two Ships Crossing.....	105
8.2.2 Two Ships Head On.....	112
8.2.3 One Ship Overtaking Another.....	114
8.2.4 The Limiting Case Study.....	117
8.3 Applications of the Simulation Tool.....	119
8.3.1 Case 1: Autonomous Ship Navigation through a Channel.....	119
8.3.2 Case 2: Simulation of Navigation in Congested Areas.....	134
8.3.3 Case 3: Special Cases.....	145
8.4 Summary.....	156
Chapter 9: Discussion	157
9.1 Introduction.....	157
9.2 Strengths and Weaknesses of the System.....	157
9.2.1 Strengths.....	158
9.2.2 Weaknesses.....	160
9.3 Recommendations for Further Research.....	161
Chapter 10: Conclusions	163
References	164

Appendix A: Ship Model	172
Appendix B: The Simulation Program and GUI	174
Appendix C: Papers	184

List of Figures

Figure 1- 1: A boat on the rocks.....	2
Figure 1- 2: The outline structure of the system	5
Figure 3- 1: Full-bridge simulator at Royal Norwegian Naval Academy in Bergen, Norway.....	11
Figure 3- 2: PC-based simulator	11
Figure 3- 3: The decision-making process for ship navigation.....	15
Figure 3- 4: Navigational aid equipment and system (a) VTS (b) ARPA (c) ECDIS (d) AIS.....	17
Figure 4- 1: The Earth-centred Earth-fixed (ECEF) frame $x_e y_e z_e$ is rotating with an angular rate ω_e with respect to an Earth-centred inertial (ECI) frame $x_i y_i z_i$ fixed in space	27
Figure 4- 2: The vessel-fixed reference system and its motion variables	27
Figure 4- 3: Global and ship coordinate systems	29
Figure 4- 4: Turning circle for a constant rudder angle $\delta = -20$ degree.....	35
Figure 4- 5: Yaw rate and speed for a constant rudder angle $\delta = -20$ degree	35
Figure 4- 6: Turning circle for a constant rudder angle $\delta = -35$ degree.....	36
Figure 4- 7: Yaw rate and speed for a constant rudder angle $\delta = -35$ degree	36
Figure 4- 8: The turning-circle manoeuvre for the Mariner class ship	37
Figure 4- 9: $20^\circ - 20^\circ$ zig-zag manoeuvre	38
Figure 4- 10: $20^\circ - 20^\circ$ zig-zag manoeuvre for the Mariner class ship	38
Figure 5- 1: The potential field in ship's route planning	42
Figure 5- 2: Attractive potential function gradient plot	44
Figure 5- 3: (a) Attractive potential field in contour plot and (b) in 3D view, with $m=1$, $\alpha = 0.5$ and the goal position at $(0,0)$	45

Figure 5- 4: (a) Attractive potential field in contour plot; and (b) in 3D view, with $m=2$, $\alpha = 0.5$ and the goal position at $(0,0)$; (c) the attractive force	46
Figure 5- 5: (a) Attractive potential field in contour plot; and (b) in 3D view, with $m=3$, $\alpha = 0.5$ and the goal position at $(0,0)$; (c) the attractive force	47
Figure 5- 6: Gradient plot of a general repulsive potential field, where all the gradients point away from the obstacle	48
Figure 5- 7: A scenario in which GNRON problem can occur.....	49
Figure 5- 8: The potential contour plot of scenario shown in Figure 5-7	50
Figure 5- 9: The contour plot demonstrating the solution of GNRON problem.....	52
Figure 5- 10: A complex navigation environment	56
Figure 5- 11: Representation of a coastline with points.....	57
Figure 5- 12: Representation of a coastline with lines.....	57
Figure 5- 13: Geometry of point obstacles.....	59
Figure 5- 14: Sample screen shots of the program generating obstacle points. (a) The built map; (b) major point obstacles are placed manually; (c) the system automatically calculates obstacle points where necessary.	60
Figure 5- 15: Contour plot of the potential field due to the entire boundary	61
Figure 5- 16: A typical local minima problem.....	62
Figure 5- 17: Local minimal problem	63
Figure 5- 18: (a) Giving a small initial heading deviation; and (b) the ship safely negotiates the obstacle and proceeds to the destination.....	64
Figure 5- 19: (a) Two situations of closely positioned obstacles; (b) using the ordinal notations	65
Figure 5- 20: Ship oscillates and cannot pass	66
Figure 5- 21: Ship passes narrow passage	67
Figure 5- 22: Ship is successful to pass narrow passage.....	67
Figure 6- 1: Ship fuzzy domain.....	73
Figure 6- 2: Overtaking situation	77

Figure 6- 3: The relationship of the parameters	78
Figure 6- 4: Head-on situation	80
Figure 6- 5: Crossing situation.....	81
Figure 6- 6: The classification of encounter types.....	82
Figure 6- 7: The give-way vessel yields to the stand-on vessel.....	83
Figure 6- 8: The basic strategy of avoiding collision in the case of two ships encountering.....	85
Figure 6- 9: Multiple ships encounter situation	88
Figure 7- 1: Route composed of straight lines and circular arcs.....	94
Figure 7- 2: Route generation using cubic spline.....	96
Figure 7- 3: Predetermined waypoints and fixed route method.....	97
Figure 7- 4: Dynamic route generation	98
Figure 7- 5: Desired heading along the route.....	100
Figure 7- 6: The algorithm block diagram.....	102
Figure 8- 1: The <i>Compute_repulsive</i> subprogram	103
Figure 8- 2: The output plot	104
Figure 8- 3: Simulation starts.....	106
Figure 8- 4: Having identified the collision risk, the give-way ship starts manoeuvring.....	106
Figure 8- 5: The give-way ship turns to starboard	107
Figure 8- 6: Own ship sails to destination.....	107
Figure 8- 7: Two ships arrive at destination	108
Figure 8- 8: Own ship's yaw rate, yaw angle, speed and rudder angle.....	108
Figure 8- 9: The enlarged part in Figure 8-8 (1)	109
Figure 8- 10: The enlarged part in Figure 8-8 (2)	109
Figure 8- 11: Strange ship's yaw rate, yaw angle, speed and rudder angle	109
Figure 8- 12: The part of route.....	110
Figure 8- 13: The enlarged route.....	110

Figure 8- 14: (a) Own ship avoids collision (b) two ships arrive at the destination	111
Figure 8- 15: (a) No collision risk (b) two ships arrive at destination	111
Figure 8- 16: Simulation starts	112
Figure 8- 17: Identifying the collision risk, both ships turn to starboard	113
Figure 8- 18: Sailing to destination	113
Figure 8- 19: Arriving at the destination	114
Figure 8- 20: Simulation starts	115
Figure 8- 21: Own ship turns to port	115
Figure 8- 22: Own ship overtakes the strange ship	116
Figure 8- 23: Arriving at the destination	116
Figure 8- 24: The limiting case (a) both ships turn to starboard (b) arrive at the destination	117
Figure 8- 25: (a) Turn port to avoid collision (b) arrive at the destination	118
Figure 8- 26: The Strait of Istanbul (from Google map)	120
Figure 8- 27: The Matlab map	120
Figure 8- 28: The desired route	121
Figure 8- 29: Three dangerous areas	122
Figure 8- 30: The discrete obstacle points	123
Figure 8- 31: Calculating and placing point obstacles automatically	124
Figure 8- 32: The contour plot of the potential field	124
Figure 8- 33: The enlarged part (1)	125
Figure 8- 34: The enlarged part (2)	125
Figure 8- 35: Simulation starts	126
Figure 8- 36: Avoiding hitting the bank	126
Figure 8- 37: Negotiating the first major bend successfully	127
Figure 8- 38: Sailing on	127
Figure 8- 39: Negotiating another sharp bend	128
Figure 8- 40: Taking on a major bend	128

Figure 8- 41: Into the narrows having successfully negotiated the major bend	129
Figure 8- 42: Going through the area 2.....	129
Figure 8- 43: Negotiating the last bend and out of the narrows successfully	130
Figure 8- 44: Approaching the destination	130
Figure 8- 45: Arriving at the destination.....	131
Figure 8- 46: Simulation results in potential field	131
Figure 8- 47: The enlarged part (1).....	132
Figure 8- 48: The enlarged part (2).....	132
Figure 8- 49: The ship's yaw rate and yaw angle	133
Figure 8- 50: The ship's speed and rudder angle	133
Figure 8- 51: The setting up of simulation.....	135
Figure 8- 52: Simulation starts.....	135
Figure 8- 53: Ships converge	136
Figure 8- 54: Ship C and ship D start taking avoidance action (1).....	137
Figure 8- 55: Ship C and ship D take avoidance action (2)	137
Figure 8- 56: Ship C and ship D avoid collision (3)	138
Figure 8- 57: Ship A changes its course	138
Figure 8- 58: Ship A avoids collision with ship B.....	139
Figure 8- 59: Ship F avoids collision with ship A	140
Figure 8- 60: Ship F changes its course	140
Figure 8- 61: Ship F successfully negotiates the situation.....	141
Figure 8- 62: Every ship arrives at destination	141
Figure 8- 63: Ship A's yaw rate, yaw angle, speed and rudder angle.....	142
Figure 8- 64: Ship B's yaw rate, yaw angle, speed and rudder angle.....	142
Figure 8- 65: Ship C's yaw rate, yaw angle, speed and rudder angle.....	143
Figure 8- 66: Ship D's yaw rate, yaw angle, speed and rudder angle.....	143
Figure 8- 67: Ship E's yaw rate, yaw angle, speed and rudder angle	144
Figure 8- 68: Ship F's yaw rate, yaw angle, speed and rudder angle	144

Figure 8- 69: Normal simulation case 1 (1)	146
Figure 8- 70: Normal simulation case 1 (2)	146
Figure 8- 71: Normal simulation case 1 (3)	147
Figure 8- 72: Normal simulation case 1 (4)	147
Figure 8- 73: The solution of special case 1 (1).....	149
Figure 8- 74: The solution of special case 1 (2).....	149
Figure 8- 75: The solution of special case 1 (3).....	150
Figure 8- 76: The solution of special case 1 (4).....	150
Figure 8- 77: Normal simulation case 2 (1)	152
Figure 8- 78: Normal simulation case 2 (2)	152
Figure 8- 79: Normal simulation case 2 (3)	153
Figure 8- 80: Normal simulation case 2 (4)	153
Figure 8- 81: The solution of special case 2 (1).....	154
Figure 8- 82: The solution of special case 2 (2).....	154
Figure 8- 83: The solution of special case 2 (3).....	155
Figure 8- 84: The solution of special case 2 (4).....	155
Figure 8- 85: The solution of special case 2 (5).....	156
Figure B- 1: The program structure	175
Figure B- 2: Running the program through GUI	176
Figure B- 3: The output plot	177
Figure B- 4: The ship's key manoeuvring parameters plot.....	178
Figure B- 5: The Graphical User Interface (GUI).....	179
Figure B- 6: The parameters setting part.....	180
Figure B- 7: (a) Inputting the obstacle's information (b) adding to the list.....	180
Figure B- 8: (a) Choosing the obstacle's information (b) the data is deleted from the list.....	181
Figure B- 9: (a) Inputting the ship's information (b) adding to the list	182

Figure B- 10: (a) Choosing the ship’s information (b) the data is deleted from the list 182

Figure B- 11: The notice window 183

List of Tables

Table 4- 1: The simulation results of turning-circle manoeuvres	37
Table 6- 1: The values of f	75
Table 6- 2: Turning angle for avoiding collision	90
Table 8- 1: The position and speed of ships for the first scenario	105
Table 8- 2: The position and speed of ships.....	112
Table 8- 3: The position and speed of ships.....	114
Table 8- 4: The position and speed of ships.....	117
Table 8- 5: The positions of point obstacles	123
Table 8- 6: The position and speed of ships.....	134
Table 8- 7: The position and speed of ships.....	145
Table 8- 8: The position and speed of ships.....	151
Table A- 1: Non-dimensional hydrodynamic coefficients.....	173

Nomenclature

Notation

a	angle between the relative position and the relative speed
b	angle between the tangential line and the relative position
α	positive scalar parameter
f	factor used in collision avoidance distance
m	positive constant determining the shape of the destination
n	positive constant
η	positive scaling factor
θ	parameter used in cubic spline
ρ_{RO}	the shortest distance between the robot and the obstacle
ρ_O	the limit distance of the repulsive potential field influence
φ_S	relative bearing of the strange ship relative to own ship
φ_T	relative bearing of own ship relative to the strange ship
ψ	ship's heading
$\tilde{\psi}$	ship's heading error
ω_e	earth's rate of rotation.
ω_n	natural frequency
ξ	relative damping ratio
λ	factor
u, v	surge speed and sway speed respectively
\dot{u}, \dot{v}	surge and sway acceleration respectively

r, \dot{r}	yaw rate and yaw acceleration
\tilde{r}	yaw rate error
δ	rudder angle
$(x_d(\theta), y_d(\theta))$	position of the vessel
$x_i y_i z_i$	Earth-centred inertial frame
$x_e y_e z_e$	Earth-centred Earth-fixed frame
C_A	collision avoidance distance
C_E	position evaluation error
C_R	checking collision range
C_S	safe passing distance
\vec{F}_{att}	attractive force
\vec{F}_{rep}	repulsive force
\vec{F}_{total}	total force
H_R	true bearing of the strange ship relative to own ship
I_Z	yaw moment of inertia of the ship
K	gain constant
K_d	derivative gain constant
K_i	integral gain constant
K_p	proportional gain constant
L_{OW}	length of own ship
L_{pp}	length of ship between perpendiculars
L_{TA}	length of strange ship

M	the number of obstacles
N	yaw moment
O_h	course angle of own ship
O_s	course angle of the strange ship
\vec{p}	point on the water surface
$\vec{p}(t)$	position of ship at time t
\vec{p}_d	destination position of ship
p_o	positive constant describing the influence range of the obstacle
p_s	the shortest distance between the ship and the obstacle surface
\vec{P}_O	position vector of own ship
\vec{P}_T	position vector of the strange ship
\vec{P}_{os}	distance between own ship and the point of intersection
\vec{P}_{or}	distance between own ship and the strange ship
T	time constant
$\vec{U}(\vec{p})$	gravity potential energy
$\vec{U}_{att}(\vec{p})$	attractive potential energy
$\vec{U}_{rep}(\vec{p})$	repulsive potential energy
\vec{V}_O	speed vector of own ship
\vec{V}_T	speed vector of target ship
\vec{V}_{or}	relative speed between own ship and target ship
X	force applied on the ship in the x -direction
Y	force applied on the ship in the y -direction,

Abbreviations

ACAAS	Automatic Collision Avoidance Advisory Service
AIS	Automatic Identification System
ARPA	Automatic Radar Plotting Aids
ASGC	Automated Ship Guidance and Control
BODY	Body-Fixed Reference Frame
CAES	Collision Avoidance Expert System
COLREGS	International Regulations for Preventing Collision at sea
CPA	Closest Point of Approach
ECDIS	Electronic Chart Display and Information System
ECEF	Earth-centred Earth-fixed reference frame
ECI	Earth-centred Inertial Frame
FIRAS	Force Inducing an Artificial Repulsion from the Surface Function
GA	Genetic Algorithm
GPS	Global Positioning System
GT	Gross Ton
GNRON	Goal Non-Reachable with Obstacles Nearby
GUI	Graphical User Interface
IDS	Integrated Display System
IMO	International Maritime Organization
INS	Integrated Navigation System
LOSCAN	Line of Sight Counteraction Navigation
LVSE	Localization of Vessel States
MANTIS	Marine Avoidance Navigation, Totally Integrated System
NED	North-East-Down Coordinate Frame
Nm	Nautical mile
PCTA	Potential Collision Threat Area

PID	Proportional–Integral–Derivative
PPSS	Path Planning and Scheduling Service
TCPA	Time to Closest Point of Approach
VFF	Virtual Field Force
VICAD	Vessel Intelligent Collision Avoidance Decision
VTS	Vessel Traffic System
WOP	Wheel-Over-Point

Chapter 1:

Introduction

1.1 Background

International maritime transport has always been the crucial infrastructure for international trade, but it has taken on a much greater significance with the advent of global economy in the latter half of 20th century. Nowadays approximately 90% of international trade is carried by ships and there are more than 120,000 vessels in the global maritime fleet. More than 1.2 million mariners on board ships are calling at more than 2,800 ports in the world [Shi, 2007]. Growing shipping activities also make navigation environment more complicated, and at the same time, vessels are becoming larger and wider, more specialised and faster than ever. Accidents seem inevitable in such an environment. The increase of ship size, along with the general increase in traffic, has led to an increase in major accidents associated with navigation and ship handling, despite technological advances in navigational aids.

Accidents which occur in waterways and harbours typically take the form of collision, grounding, striking a reef or mechanical failures which may result in loss of life and pollution of the environment, in irreparable damage to cultural heritage, and in financial losses [Ince, 2004]. According to IMO statistics on total losses of ships of 100 GT and above, 148 vessels suffered total losses and 1274 people lost their lives in the year of 2002 [IMO, 2005].

It has been said that ‘the safer the vessels sail, the cleaner the ocean is’ [Yang, S., 2007]. This is only one of the reasons for the massive effort having been devoted to reducing ship accidents and improving ship safety. Hong [Hong, 2002] points out that there are three main factors in the occurrence of marine accidents: the ship, the environment and people.

Ship structures and vessel control systems are often considered to be the key factors of ship safety. However, relatively few accidents are due to ship structural failure. Vessel control systems mainly refer to rudder and engine. They can affect the ship manoeuvring performance, but it is not the most important factor in accidents.



Figure 1- 1: A boat on the rocks (after Porathe, 2004)

Statistics shows that about 75-96% of marine incidents occurred due to some form of human error [Porathe, 2004]. An investigation of 3000 marine accidents from 2002 to 2006 indicated that collisions accounted for about 22% and over 80% of accidents of collision can be put down to human decision failure [Smith, 2008].

The master's judgment in operating his ship is, of course, influenced by the data he has about his environment (geography, bathymetry, meteorological conditions, locations of other ships and what they are doing). Most vessels these days are equipped with modern and advanced navigational aids and equipment such as Automatic Radar Plotting Aids (ARPA) and Vessel Traffic System (VTS). These systems can provide masters with data on environmental conditions and display the navigational situation on the radar screen. The final decision on how to operate ships to manoeuvre, however, must still be made personally by the master or other responsible persons.

Another factor affecting marine accident is traffic regulations, or rather adherence to them. They stipulate priorities for entering a waterway and offer navigational advice for safe passage, taking into account IMO Collision Regulations, the size and weight of the vessel and the characteristics (hazardous, non-hazardous) of the cargo they carry. Following these regulations is crucial in ensuring safety for all users of the waterways. Even 'bad' regulations need to be followed by all, so that the actions taken by any ship master can be predicted by another in the vicinity.

It is, therefore, abundantly clear that human is the most important factor affecting the safety of ship navigation.

Operating a ship in restricted waters, such as harbours, canals and river inlets, is a complex task owing to many limitations and/or constraints due to ship dynamics, hydrodynamics, limitations of propulsion and control equipment on board, environment (wind, current and waves) and traffic regulations in force at the location. Furthermore, unlike road traffic, there are generally no boundaries constraining what path a ship may take moving between any two points (except perhaps by navigation buoys or bathymetric configurations). There are no traffic lights and ships are not equipped with a brake as effective as those found in ground vehicles. It is hardly surprising, therefore, that accidents of collision and grounding still happen, although most of vessels involved in accidents are equipped with modern and advanced navigational aids and equipment.

From the viewpoint of safety and economy, the most effective approaches to minimising accidents due to human failure, and consequently enhancing the general safety level of ships, are to improve the navigators' skills, increase the degree of ship automation and to provide effective tools, where appropriate, to assist decision-making process. These measures will reduce the burden of navigators in mundane operational and decision-making duties and allow them to concentrate on important decision-making based on sound data and logical basis [Yang, S., 2007].

With the rapid advances in computer signal processing technology, modern control

theory and accurate positioning and navigation systems, the ship manoeuvring simulator is becoming increasingly popular as tools for design and operational planning. It allows the user to control a ship in a virtual environment, as if he or she were controlling it for real. It provides a cost effective method of assessing ship handling capabilities in diverse scenarios and can be used by the local pilots and ship's master and officers for manoeuvring rehearsals, as well as in the design and development of new berth layouts and channel arrangements as part of port development, saving much time and resources [Burnay, 2008]. The most commonly used tools in this type of work are 'bridge simulators' with an actual person of harbour pilot calibre in charge of the simulated control of the ship. It can simulate real-time navigating environments and ship handling scenarios. In such an environment the navigators could have the real feeling and learn how to operate ships. This approach is highly realistic and effective. However, the emphasis of these simulators is more on reproducing the "feel" and it does not provide decision-making support to pilots and masters nor advise them on how to handle a ship in complicated situations. Furthermore, it limits the number of runs and conditions which can be tested, since the simulation is in 'real' time and the associated costs are high.

A much more cost-effective tool for many of the purposes mentioned above, therefore, is an automatic manoeuvring simulation which does not involve a human steersman but realistically emulates his/her performance. It can instruct each vessel in the simulation to automatically navigate according to its original mission and make intelligent decisions in navigation to avoid collision in accordance with the collision prevention regulations and other international navigational rules. Figure 1-2 shows the outline structure of the system to be simulated.

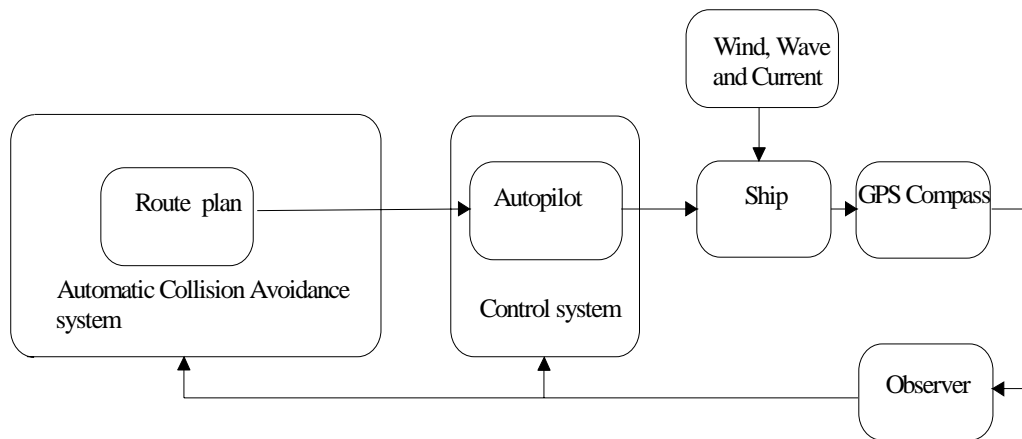

Figure 1- 2: The outline structure of the system

The automatic manoeuvring simulation should:

- (a) identify where the ship is and where it should go;
- (b) detect potential collision situation and calculate a safe path to the destination avoiding collision for each ship; and
- (c) control each ship automatically to follow the path thus identified, and calculate ship velocity and position in real-time.

It should be able to carry out these tasks in whatever waterways and traffic situation given. Such a tool can be used to assist the human navigators and waterway design. It will be capable of instructing the users on how to take collision avoidance actions and on how to handle the ship to execute the recommended actions for any given scenario. Therefore, it can also be used as a training tool which embodies and transmits the navigational skills and knowledge of experienced ship masters and pilots.

This thesis describes a research project carried out in developing such a system.

1.2 Outline of the Thesis

A brief outline of the contents of this thesis from Chapter 2 is given below:

- Chapter 2, *Aims of the Thesis*, states the overall aim and specific objectives that constitute the focus of the research presented in this thesis.
- Chapter 3, *Critical Review*, presents a review of ship manoeuvring simulators and their applications, followed by a critical analysis of relevant autonomous guidance simulation methodology regarding ship route planning and collision avoidance. Finally, the adopted method in this thesis is introduced. Reviews of other literature are included in the relevant chapters.
- Chapter 4, *Manoeuvring Model Used*, describes the ship manoeuvring model used in this project.
- Chapter 5, *Automated Route Finding*, states the problem of ship route finding, describes the potential field method developed in robotics research, presents the algorithm based on potential field method in ship route finding and discusses the limitations of this method together with possible methods of overcoming them.
- Chapter 6, *Automatic Collision Avoidance*, describes the developed method of ship automatic collision avoidance incorporating the International Regulations for Preventing Collisions at Sea.
- Chapter 7, *Dynamic Route Generation and Heading Control*, analyses the problem of route generation, describes the details of dynamic route generation using cubic spline and the PID heading controller which is adopted to control the ships automatically.

- Chapter 8, *Case Studies of Application of the Simulation Tool*, introduces the MATLAB-based simulation program, studies the fundamental cases for demonstrating the effectiveness of the method developed, and tests its validity through case studies on a number of scenarios.
- Chapter 9, *Discussion*, critically discusses the strengths and weaknesses of the simulation tool developed in the thesis, contains an account of the contribution of the thesis to the field, discusses the difficulties encountered during the research and, based upon the discussion, provides recommendations for further research.
- Chapter 10, *Conclusions*, summarises the main conclusions of the research presented in the thesis.

Chapter 2:

Aims of the Thesis

The overall aim of the thesis is to contribute to the navigational safety of ships and provide a tool for design and operational planning of harbours, channels and other constrained waterways by developing an automatic ship navigational simulation system.

Specific objectives to realise this aim are as follows:

- To undertake a critical review of the current state-of-the-art in ship manoeuvring simulation, aiming to identify the deficiencies of existing ship manoeuvring simulators and automatic navigation system.
- To review existing methods used for automatic route finding and identify the most appropriate method for application in the problem of ship route finding.
- To develop a practical algorithm for automatic trajectory planning and collision avoidance based on the route finding method selected, and to incorporate collision prevention regulations and international navigational rules into the algorithm.
- To develop a dynamic route generation method and to design an automatic ship controller.
- To implement the methods, procedures and algorithms thus developed into an automatic simulation program and test its validity through case studies on a number of scenarios.

- To offer recommendations for research required for further development of the simulation system.

Chapter 3:

Critical Review

3.1 Introduction

In this chapter a critical review of existing systems and relevant literature is carried out to provide the background and scope of the present research. It begins with an examination of two different simulators, i.e. full-bridge simulators and PC-based simulators. The factors influencing ship navigation and the process of decision-making are discussed. A brief survey of existing equipment and systems of navigational aids is made. Finally, the existing work on automatic ship navigation systems is reviewed critically.

3.2 Ship Manoeuvring Simulation

Ship manoeuvring simulation can be defined as the process of using qualified pilots or a pilot model to predicate the behaviour of a manoeuvring ship in its operating environment. Initial ship manoeuvring simulation involves remotely controlled scale models or scale models of sufficient size to accommodate human operators [Webster, 1992]. In recent years, computer-based simulation has benefited greatly from the advance of computer technology. The ship manoeuvring simulator is finding ever widening applications in training, operational planning and design of water ways. It encompasses a wide range of capabilities, facilities, and man-machine interface. It can be divided into two major forms [Burnay, 2008]:

- *Full-mission or full-bridge simulators*: The user is fully immersed in a

replica of a ship's bridge complete with 'real' out-of-the-window views and all of the tools one would normally find on the bridge. Figure 3-1 shows the full-bridge simulator at Royal Norwegian Naval Academy in Bergen.



Figure 3- 1: Full-bridge simulator at Royal Norwegian Naval Academy in Bergen, Norway (www.naval-technology.com [accessed 22 November 2008])

- *PC-based or part-task simulators*: The simulator is contained on a standard PC and can use either 3-D or 2-D (plan-view) visuals to show navigation status as shown in Figure 3-2.



Figure 3- 2: PC-based simulator (after Muirhead, 2003)

Thanks to its high reliability and wide range of applications, the ship manoeuvring simulation is capable of meeting many needs. It has become an essential tool and been widely used for safety assessment in port, harbour and narrow channel areas, research and development concerning the operation of vessels, and maritime education and operational training.

The application of ship manoeuvring simulation can be primarily classified into the following four categories [Burnay, 2008]:

- maritime education and ship-handling training
- planning and design of vessels and harbours
- determination of operational limits
- assessment and optimization of tug requirements

Both types of simulators can be, and are, used for all these applications, although their effectiveness may vary to a great extent.

3.3 Automatic Ship Navigation System

Over the centuries, ship navigation has traditionally been performed entirely manually. Today, existing ship manoeuvring simulators have become a useful means of helping navigators to master basic navigation skills and traffic regulations before they go to practice on board and there has been much development in using it to investigate safety [Kose, 1990] as well. Although an effort is being made to develop fully automatic navigators which can be used even in difficult circumstances, it remains somewhat half-hearted and at present the responsibility for collision avoidance still rests on human navigators.

It is without question that collision avoidance is one of the major responsibilities of mariners. This has become an important issue in modern times due to increase in

traffic, speed and size of modern vessels. Collision avoidance requires a constant vigil, analysis of the situation and decision-making, sometimes in a very short space of time, on the part of the mariners. Especially in areas of heavy traffic, such as harbour entrances, coastal zones, and narrow sea passages, collision avoidance takes on increased significance, and the threat of possible collision gives navigators more pressure and work load.

Therefore, an automatic ship navigation system, probably used as an advisory tool to start with, will be an effective assistant to the crew in safe and efficient navigation. Such a system will be able to guide its operator in determining the safe and near-optimum trajectory for ship navigation. In the long run, it is quite possible that trustworthy “intelligent” machines may be produced to navigate ships within waterways and ports without human supervision [Statheros et al., 2008].

(a) Factors influencing ship navigation

It does not need elaboration that the success of automatic ship navigation system will depend on the efficiency and veracity of the core simulator, and, therefore, the development of efficient real-time intelligent algorithms for collision avoidance is a prerequisite to develop an ‘automatic’ ship navigation system.

Before we can embark on this journey, it is necessary to understand the factors that influence ship navigation. These factors are discussed below [Statheros et al., 2008].

- *Ship Dynamics.* The ship dynamics defines the capabilities of the ship’s navigation, including ship’s speed, turn radius and manoeuvrability. Different ship employs different kinds of evasive manoeuvres to avoid collision, since ship dynamics can differ significantly from one ship type to another. So it is important for the captain and crew to learn their own ship’s dynamics and master its operation.

- *Navigation Environment.* Navigation environment includes two main aspects, one is geographical environment and the other is weather environment. Geographical environment can be divided into two main categories: confined environment (e.g. ports or canals); and open seaways. In both categories, different geography defines different navigation conditions and traffic complexity. These need to be taken into consideration in navigation. Weather conditions influence every aspect of the ship navigation. In different weather conditions ship navigation requires different evasive manoeuvres from the piloting crew.
- *Navigation Aid Equipments and Systems.* Many navigational aid equipments and systems (e.g. Global Positioning System (GPS), Radar and Automatic Radar Plotting Aid (ARPA)) are widely used in modern ships. These equipments may assist the crew to navigate safely and efficiently and, consequently, improve the safety.
- *Human Ability of Decision-making.* As mentioned before, at present the responsibility for ship navigation still rests on navigators. Each of the above factors and any combination of them require human decision and operation for safe navigation. Therefore, it is very important to understand the process and demands required of ship operation during decision-making for collision avoidance. It is the key point of the design of an automatic ship navigation system.

(b) The decision-making process for ship navigation

Ishioka [Ishioka et al., 1996] analysed the process by which human navigators avoid collision by interviewing captains and navigation officers. Figure 3-3 shows the process identified from this study.

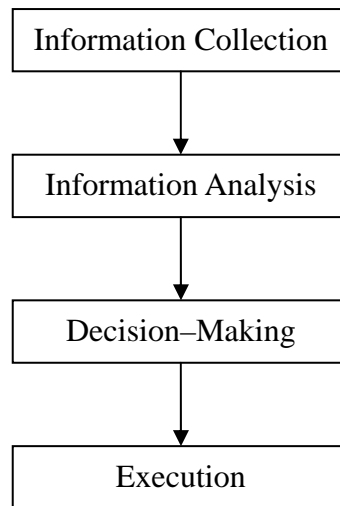

Figure 3- 3: The decision-making process for ship navigation

- **Information collection**

It is clear that the navigator has to take in many pieces of information for navigation and it is difficult for a person to sustain continuous monitoring of these information sources [Tran, 1999]. Meanwhile, the increase in traffic density and ship speed has led to an increase in the volume of information and work load of navigator. This may cause mistakes or slow response in navigation.

- **Information analysis**

Most information is presented to the navigator in its raw form and it is difficult to analyze and digest all the available data, especially in congested waters when snap decisions are often called for. Navigators, for example, tend to concentrate on a ship or ships which appear to present the highest risk and, being occupied thus, may not have spare capacity to pay attention to other hazards. Needless to say, this is an unsafe practice and there is a need to deliver the key information in an easily digestible form for rapid situation assessment to ease the stress involved in rapid decision-making process.

- **Decision-making**

Most merchant ships have high mass and consequently they are slow to respond to manoeuvring controls. Therefore, predictive analysis of the situation is very

important, and is traditionally based on the information obtained through visual observation. The navigator's responses for any given situation are constrained by many factors (e.g. interpretation of the information, unexpected events and physical and psychological factors). These factors lead to the difficulty in decision-making and increase the need in automatic ship navigation system.

- **Execution**

The collision avoidance action can be complex and can impose a high work load for the navigator. During the navigation, the navigator has to consider external environmental forces and the manoeuvrability of own ship to decide on the timing and action of the actuators. When executing the collision avoidance action, he has to pay close attention to the behaviour of other ships in the vicinity and decide the timing to initiate the actuators [Tran, 1999]. Thus, an automatic ship navigation system is very helpful in controlling or advising the movement of actuators and lessening work load of the navigator.

(c) Existing navigational aid equipments and systems

As mentioned before, many navigational aid equipments and other systems are widely used in modern ships and harbours. For example, at present, most harbours are equipped with special vessel traffic services (VTS) system for estimating safe trajectories of ships entering and leaving the harbour. Furthermore, many up to date ships are equipped with modern and advanced navigational aids and specialized radar anti-collision systems, such as Automatic Radar Plotting Aids (ARPA), Electronic Chart Display and Information System (ECDIS), Automatic Identification System (AIS), and so on, which facilitate the navigators' work considerably. Figure 3-4 shows these equipments and systems.

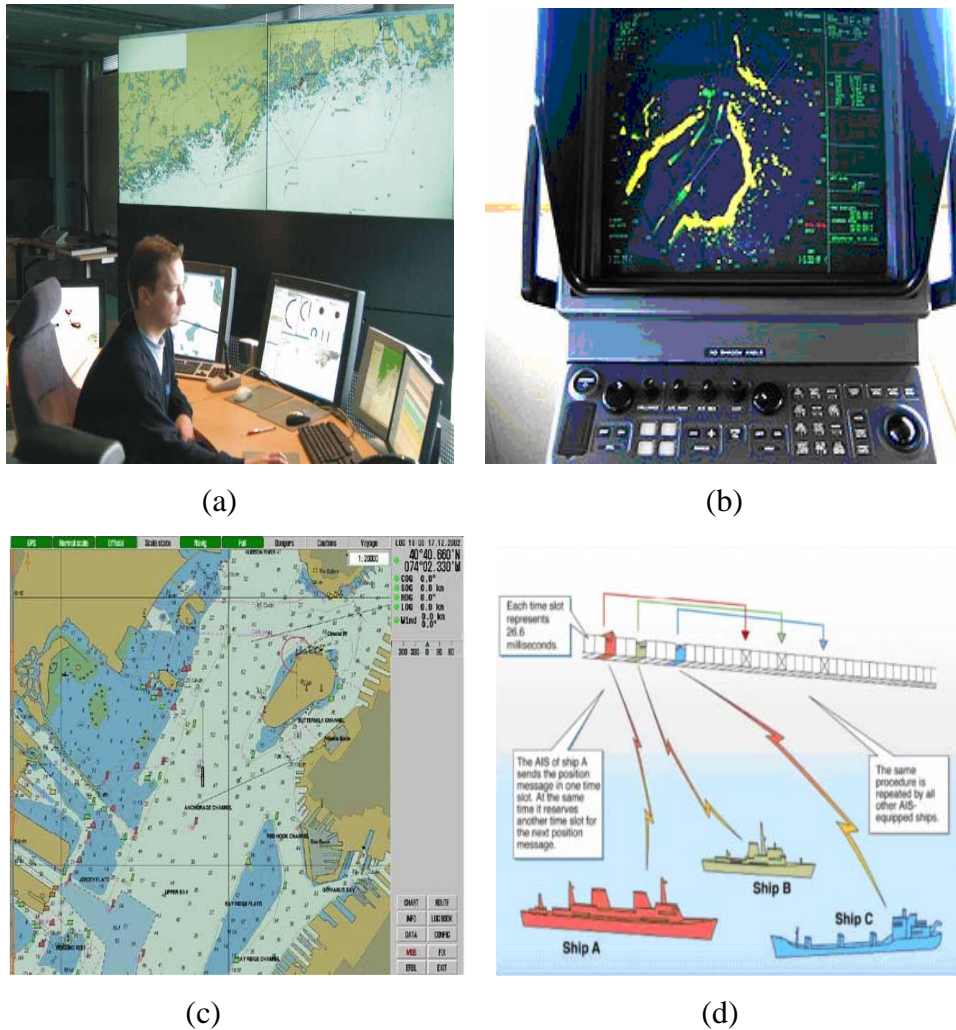

Figure 3- 4: Navigational aid equipment and system (a) VTS (b) ARPA (c) ECDIS (d) AIS (http://en.wikipedia.org/wiki/Main_Page [accessed 20 January 2009])

These navigational aids have the ability to process data and display the navigational situation. They can be used to analyze the present traffic situation to suggest possible avoidance procedures and allow the navigator to make reasonable decisions about which manoeuvre to take. However, VTS can presently only give general guidance to ships of the risks ahead. It cannot suggest precise navigational routes. This is because of the complexity of the associated management task. Due to the sheer number of ships, it is humanly impossible to plan the paths of all ships into and out of port even with a large task force of human operators. In the majority of cases, it is left to the ship navigator to perform avoidance actions en route [Tran, 2001]. Furthermore, the

use of these equipments does not guarantee safety. For example, the use of ARPA can have negative results when operated by inexperienced officers, since reported data shows that 56% of major maritime collision includes violation of “the rules of the road” (COLREGS) [Statheros et al., 2008].

Although these equipments and systems provide great help for ship navigation, the final decision on how to act in order to avoid collision must still be made personally by the navigator. Of course, he makes the decision based on the information obtained from these equipments, as well as his seamanship and intuition [Zeng, 2000]. Therefore, one of the key roles of automatic ship navigation systems is to suggest an effective manoeuvring action to the navigators and thus complement human experience and judgement when making final decision.

(d) Existing work on automatic ship navigation

One of the key elements in developing automatic ship navigation system is an intelligent decision-making capability. The problem of intelligent decision-making is connected with collision avoidance manoeuvres and route planning of vessels. In recent years, intensive research work on automatic ship navigation has been carried out along with the development of computer science and information technology.

James [James, 1986] adopted fuzzy logic to make collision avoidance decision. In his work, the avoidance actions were categorised according to distance and passing side. The developed method can search a safe path in open sea conforming to COLREGS for two ships encounter situation, but its shortcomings include the fact that the environmental conditions are not taken into consideration and that the path generated is not necessarily the optimum.

Iijima and Hagiwara [Iijima & Hagiwara, 1994] applied expert system in ship autonomous navigation. The authors developed a computer expert system to assess the collision situation, and then make a decision and give manoeuvring orders.

Graczyk [Graczyk et al., 1995] proposed the concept of Potential Collision Threat Area (PCTA) in ship navigation simulation. The principle of PCTA is to define a dangerous area and ensure that 'own' ship is outside this area. The size of the PCTA depends on the assumed safe passage distance between ships, usually between 0.5 Nm and 3 Nm, depending on the sailing conditions, such as weather, volume of traffic in the area and so on. This algorithm produced a single change of course and/or the speed of the own ship.

Hiroshima University in Japan developed an integrated navigation system (INS) [Kose, 1996]. This INS incorporates a Collision Avoidance Expert System (CAES) [Kose, 1995] [Yang, C., 1995] as an intelligent decision-making support tool to assist the operator to avoid collision during ship navigation.

Smierzchalski [Smierzchalski, 1996] adopted an evolutionary algorithm to develop a ship guidance system in collision situation. In his study, the safe trajectory was formulated as a multi-criterion optimization task and solved subject to the static and dynamic constraints. The evolutionary algorithm was mainly used for estimation of a safe trajectory. This trajectory was computed in two modes: off line and on line. The ARPA system was used to check out whether the assumption of navigating obstacles was true. The limitation of this work is that the strange ship's parameters were not changed and the environment conditions were not considered.

Yavin [Yavin et al., 1997] studied collision avoidance between ships and offshore installations or other obstacles using a realistic model of a tanker ship. The mathematical model for ship manoeuvres was based on the assumption of a planar undisturbed free surface and expressed in terms of the time-dependent ship speed, drift angle, and yaw angular velocity.

Genetic algorithms (GA) are a particular class of evolutionary algorithms. It has been widely employed successfully in mobile robots [Lin et al., 1994]. Ship automatic navigation is, in a sense, similar to the safe navigation of a mobile robot. So it is also used to solve ship navigation by many researchers. For example, Ito [Ito et al., 1999]

employed genetic algorithm to compute the collision avoidance navigation path. A simple model of collision avoidance based on a single gene approach was proposed. This gene contained only the geographical position of the ship (latitude, longitude). The solution space was defined using ship domain as the danger zone, and feasible passing points were randomly generated in the solution space. These points were considered as gene and the safe path was considered as chromosome. The model evaluated this group of path with the evaluating function and selected the best one. This work represents a rather basic implementation of genetic algorithm and doesn't consider COLREGS.

Harris [Harris et al., 1999] proposed an intelligent guidance and control system using a neurofuzzy network model for ship obstacle avoidance. The main idea of this system was using the neurofuzzy network to model the ship steering dynamics, with the rudder deflection angle as the system input and the ship heading angle as the system output. An ESSO 190000 dwt tanker model was used to demonstrate the effectiveness of the system. This approach can be readily extended to higher-dimensional control and guidance problems such as flight management of aircraft and missiles. But the reported work solved only static obstacle collision avoidance and did not consider the COLREGS in the system.

Tran [Tran, 1999] proposed to use a collision avoidance hybrid system to improve the efficiency and safety of marine transport, namely Marine Avoidance Navigation, Totally Integrated System (MANTIS). The principle behind its operation was to remove the difficulties and uncertainties involved in maritime navigation through a system. This system consisted of five parts: localization of vessel states and its environment (LVSE), automatic collision avoidance advisory service (ACAAS), an integrated display system (IDS), path planning and scheduling service (PPSS), and automated ship guidance and control (ASGC). In this system, neurofuzzy and neural networks were adopted to model and control ship and sensor. The expert system was used to construct automatic collision avoidance advisory service. In that work, the author just gave an overview of the architecture and components of MANTIS and did not show the simulation results. Another problem in this system was when both types

of networks were used together, the system to be modelled was highly complex, consisting of multiple inputs and outputs, and the computational cost increased dramatically. The author did not explicitly explain this problem.

Hwang [Hwang et al., 2001] developed a system for collision avoidance and track-keeping employing fuzzy logic. In this system, the fuzzy set theory was used to assess risk of collision and determine the collision avoidance manoeuvres. The system can only advise on collision-free manoeuvres for each strange ship, hence the final result might not be optimal because there is no optimization of any sort.

Zeng [Zeng, 2003] developed a more realistic genetic algorithm for ship collision avoidance. The author modified the conventional coding and added additional information (position and speed of own ship). The environmental conditions were considered in computation, but did not explicitly explain the approach. The reported method could generate safe path but again COLREGS was not considered.

Wilson et al. [Wilson et al., 2003] proposed a method named the Line of Sight Counteraction Navigation (LOSCAN) algorithm to aid manoeuvre decision making for collision avoidance. The main concept of their method based on an extension and revision of the basic principle of traditional proportional navigation, is to derive an acceleration command so as to increase the misalignment between the ships relative velocity and the line-of-sight. An important shortcoming of this work is that COLREGS is not taken into consideration and many constraints are ignored, for example, static obstacles.

Liu and Shi [Liu & Shi, 2005] developed a fuzzy-neural inference network model for ship collision avoidance. The model was based on a three-subnet neural network. There were the subnet 1 of classifying encounter situation and collision avoidance actions, the subnet 2 of calculating membership function of speed ratio and the subnet 3 of inferring alteration magnitude and action time. The model developed has certain intelligibility to make some valuable decisions and can be modified conveniently. However, it did not analyse the traffic beyond the strange ship with the

highest collision risk and generated only an evasive action for a specific encounter.

Yang [Yang, S., 2007] developed the system of “Vessel Intelligent Collision Avoidance Decision-making” (VICAD). The main ideas of this system were based on the method of artificial intelligence which combines the principle of expert system, analytic geometry and fuzzy logic. The VICAD system realised the effective integration of qualitative analysis from expertise knowledge and quantitative analysis from mathematical calculation. It can automatically generate and make optimized intelligent decision for vessel collision avoidance in open sea, but the environmental conditions were not taken into consideration in this system.

3.4 The Need for Further Research

3.4.1 Discussion of Past Work

In general, numerous attempts have been made in the past using different approaches to develop an automatic navigation system. Most of the reported studies can generate collision-free path for own ship, but the work is by no means completed. For example, some methods are relatively complex and time-consuming and some systems either ignore COLREGS or are incapable of describing the complex encounter situations in detail. Some algorithms even disregard the dynamic of the ship [Tam et al., 2009]. There are three important problems which have not been effectively addressed in existing research work [Xue, 2009]:

- (a) Navigational rules, including regulations of preventing collisions at sea and general practice of seaman, are usually not taken into consideration in route planning;
- (b) Most of the proposed approaches consider encounters with other vessels in open sea environment only (i.e. there is no land involved in the process of route planning) and assume that the strange ships do not change their

courses;

- (c) Most of research work is able to simulate movement of the own ship, and assumes other traffic maintain known directions and speeds of travel in the simulation.

To solve the problems mentioned above and simulate realistic situations, such as when many vessels use confined waterways simultaneously, a new approach is required. Ideally, this method should be simple and effective whilst taking advantage of state-of-the-art technology.

3.4.2 Adopted Approach

The potential field method, an idea of applying an imaginary force on the robot, was first used by Khatib [Khatib, 1986] for robot path planning in 1980s. In this method, a potential field is defined in the configuration space such that it has a minimum potential at the goal configuration, whilst all obstacles, or walls, are treated as high potential hills. Thus, in such a potential field, the robot is attracted to its goal position and repulsed away from the obstacles. The sum of all forces is then used to determine the direction and the speed of the robot.

This method is very attractive because of its mathematical elegance and simplicity. Typically, the attractive potential field and the repulsive potential fields are formulated separately, and the total potential field of the workspace is obtained by linear superposition of the two fields. Further, from a computational point of view, no prior processing is required and the method is capable of automatically indicating dynamic behaviour necessary to avoid all obstacles. It allows real-time robot operations in a complex environment and is suitable for path planning of mobile vehicle.

Thorpe [Thorpe, 1985] applied this method to off-line path planning. Borenstein and Kroen [Borenstein & Kroen, 1989] studied real-time obstacle avoidance for fast mobile robots using potential field method. Lee and Choi [Lee & Choi, 1996] applied this method to design a path planner. Their path planner can guide the robot to find a feasible path to reach the destination position in an environment with stationary obstacles. Adams [Adams, 1999] presented a simulation study using the potential field method for path following. Ge and Cui [Ge & Cui, 2000] improved Khatib's artificial potential field in the 2000s and made it suitable for dynamic environment. Tsourveloudis and Valavanis [Tsourveloudis & Valavanis, 2001] proposed a method of path planning for an autonomous mobile robot in a 2-D dynamic environment by using potential field.

In ship autonomous navigation, Lee [Lee et al., 2004] introduced a fuzzy logic autonomous navigation algorithm based on virtual field force (VFF) which is derived from the concept of potential field method. This algorithm has the ability to handle static and/or moving obstacles and can be used in either track-keeping or collision avoidance modes. However, this work did not make much progress beyond the basic idea. The author did not explain this method explicitly, for example, how to calculate virtual force and how to consider the limitation of potential field method.

Another category of potential field method is stream function algorithm. Stream function is the solution to the Laplace's equation. Connolly and Grupen [Connolly & Grupen, 1993] described the application of harmonic function to robot navigation. It offered a complete path planning algorithm and paths derived from this method were generally smooth. In this algorithm, the obstacles were considered as sources and the goal was considered to be the sink. This method had the advantage over the simple potential field as they exhibited no local minima and the path generated using this method was smooth and collision-free.

Shi [Shi, 2007] adopted this method for automatic ship navigation. With this method, ship navigation route can avoid collision and follow the navigational regulations for the specific region as well. However, the author just considered the static obstacles

and did not consider the moving obstacles. Furthermore, this algorithm also has its drawbacks. Firstly, the process of modelling configuration space is very complex and its computation time increases dramatically with the grid size. This could have impact in path planning performance when the potential region grows. The other limitation is the fact that stream functions are rapid decaying functions which reduces their usefulness for path planning in a large space [Prestes e Silva, 2002].

From the above studies, it can be seen that some attempts have been made to develop automatic navigation systems using potential field method, but there is still a lack of more in-depth research on the application of this method in automatic ship navigation. There still remain many problems requiring attention, for example, the limitations in potential field method. Nevertheless, the mathematical simplicity and elegance of this idea makes its choice in this thesis compelling. Further details of this method will be introduced in Chapter 5.

Chapter 4:

Manoeuvring Model Used

4.1 Introduction

Simulation of the ship navigation, automatic or otherwise, will require modelling of the ship manoeuvring, and the veracity of the simulation will depend upon the accuracy of this model. Ship manoeuvring has been studied thoroughly and many publications deal with its mathematical descriptions. Therefore, it is not the main aim of this chapter to provide detailed theoretical treatment of ship manoeuvring. Nevertheless, some fundamental ideas are given here for the sake of completeness, and to provide assumptions and simplifications used.

4.2 Reference Frames

To analyse a ship's motion, a total of four reference frames need to be defined to describe a ship's position and orientation on a global scale, viz. the earth-centred inertial (ECI) frame, the earth-centred earth-fixed (ECEF) reference frame, the North-East-down co-ordinate (NED) frame, and the body-fixed (BODY) reference frame. The first two are earth centred coordinate frames, while the other two are local geographical reference frames. The notation used here comes from [Fossen, 2002]. Figure 4-1 illustrates four reference frames, where the symbol ω_e denotes the earth's rate of rotation.

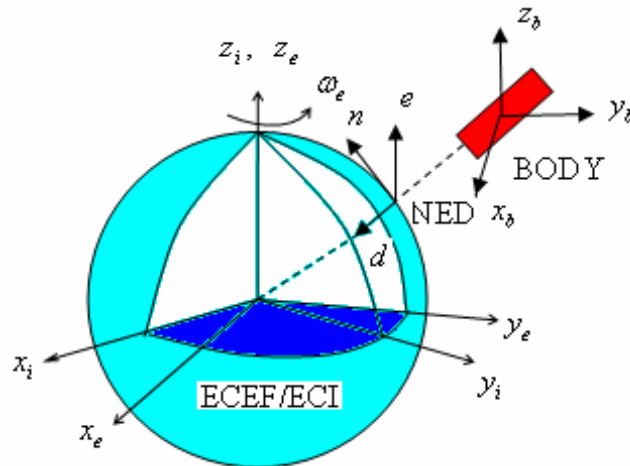

Figure 4- 1: The Earth-centred Earth-fixed (ECEF) frame $x_e y_e z_e$ is rotating with an angular rate ω_e with respect to an Earth-centred inertial (ECI) frame $x_i y_i z_i$ fixed in space (after Fossen, 2002)

In dealing with the manoeuvring motions of marine vessels, only the two geographical reference frames are of any interest. Consequently the two earth-centred reference frames are not treated further in this thesis.

To simulate the ship's motion on the ocean surface, in the most general case there are six degrees-of-freedom motion components which are defined in the reference frame of the ship, illustrated in Figure 4-2.

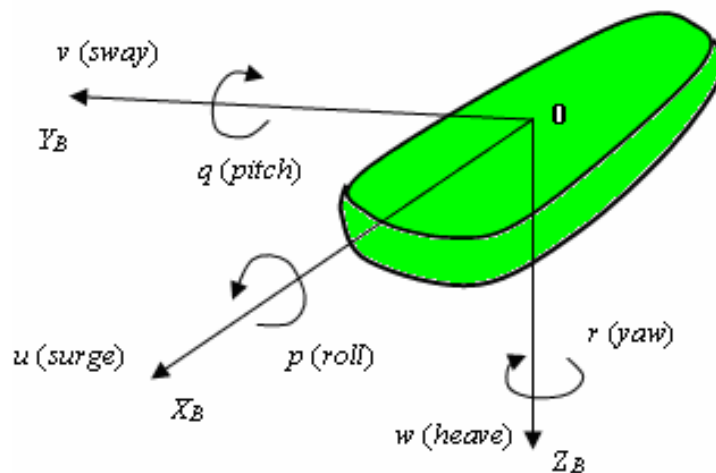

Figure 4- 2: The vessel-fixed reference system and its motion variables (SNAME 1950)

4.3 Equations of Motion

In order to simplify the problem, it is assumed that the steering of a ship can be regarded as a rigid-body motion on the horizontal plane, as is customary. Three vertical motion components of heave, roll and pitch have less effect on the ship manoeuvre in the harbour and confined waterways and can be ignored in the equations. Consequently, the mathematical model is simplified to three degrees-of-freedom in this thesis.

The basic equations of motion are obtained by writing Newton's laws in a space-fixed coordinate system, with the origin O at the centre of gravity of the ship, [SNAME, 1967] as follows:

$$m\ddot{x}_0 = X_0 \quad (4.1)$$

$$m\ddot{y}_0 = Y_0 \quad (4.2)$$

$$I_z\ddot{\psi} = N \quad (4.3)$$

where the two dots above the symbols indicate the second derivatives of those values with respect to time t , and,

X_0 and Y_0 = total forces in x_0 and y_0 -axis respectively

m = mass of ship

N = total moment about z_0 -axis

I_z = mass moment of inertia of ship about z_0 -axis

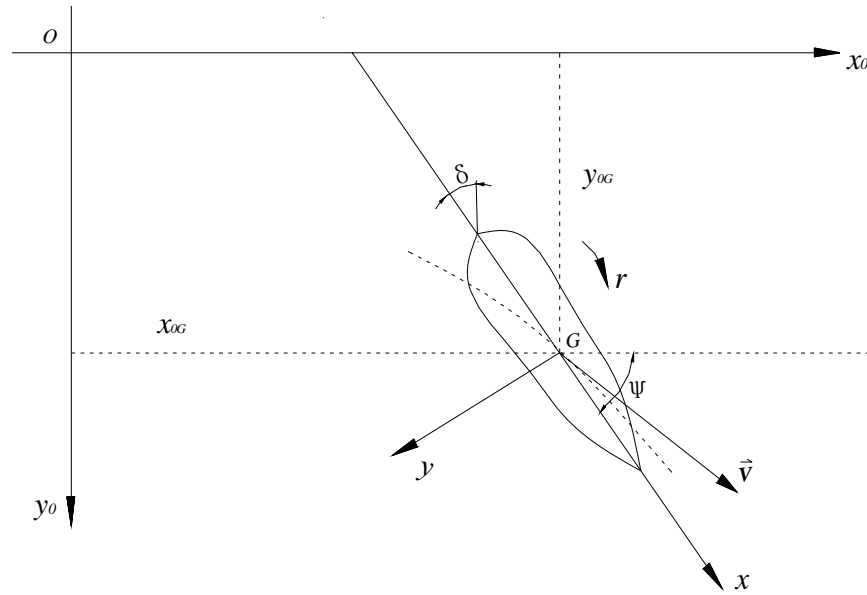

Figure 4- 3: Global and ship coordinate systems

To determine the influence of forces and moments directly acting on the hull of the ship, a ship-fixed coordinate system is more convenient as also shown in Figure 4-3. In order to convert equations (4.1) - (4.3) from earth-fixed axes to the ship-fixed moving coordinate system, the total forces X and Y in the x and y -directions, respectively, are expressed in terms of X_0 and Y_0 :

$$X = X_0 \cos \psi + Y_0 \sin \psi \quad (4.4)$$

$$Y = Y_0 \cos \psi - X_0 \sin \psi \quad (4.5)$$

likewise

$$\dot{x}_0 = u \cos \psi - v \sin \psi \quad (4.6)$$

$$\dot{y}_0 = u \sin \psi + v \cos \psi \quad (4.7)$$

where the dot above the symbols signifies the first derivative of the quantity with respect to time, and u and v are the components of \vec{V} along x and y , respectively, i.e.

$$\vec{V} = u\vec{i} + v\vec{j} \quad (4.8)$$

Then

$$\ddot{x}_0 = \dot{u} \cos \psi - \dot{v} \sin \psi - (u \sin \psi + v \cos \psi) \dot{\psi} \quad (4.9)$$

$$\ddot{y}_0 = \dot{u} \sin \psi + \dot{v} \cos \psi + (u \cos \psi - v \sin \psi) \dot{\psi} \quad (4.10)$$

Substituting expressions (4.9) and (4.10) in equations (4.1) - (4.3) and inserting the resulting values of X_0 and Y_0 in equations (4.4) and (4.5) yields the simple expressions:

$$m(\dot{u} - v\dot{\psi}) = X \quad (4.11)$$

$$m(\dot{v} + u\dot{\psi}) = Y \quad (4.12)$$

Because $\dot{\psi} = r$, equations (4.3), (4.11) and (4.12) constitute the pertinent equations of motion in the horizontal plane. For completeness:

$$m(\dot{u} - vr) = X \quad (4.13)$$

$$m(\dot{v} + ur) = Y \quad (4.14)$$

$$I_z \dot{r} = N \quad (4.15)$$

where

u , v represent surge speed and sway speed respectively

\dot{u} , \dot{v} represent surge and sway acceleration respectively

r , \dot{r} are yaw rate and yaw acceleration

X is force applied on the ship in the x -direction

Y is force applied on the ship in the y -direction

Equations (4.13) - (4.15) have been developed for the case where the origin of the axes, O is at the centre of gravity of the ship. If the origin is located at a distance R_G from the centre of gravity of the ship, where R_G has components x_G , y_G and z_G along the x , y , z -axis which are parallel to the principal axis of inertia through G , the equations (4.13) - (4.15) can be written as [Fossen, 1994]:

$$\text{Surge} \quad m(\dot{u} - vr - x_G r^2) = X \quad (4.16)$$

$$\text{Sway} \quad m(\dot{v} + ur + x_G r^2) = Y \quad (4.17)$$

$$\text{Yaw} \quad I_z \dot{r} + mx_G (\dot{v} + ur) = N \quad (4.18)$$

Because equations (4.16) - (4.18) describe motions in the horizontal plane only and the centre of gravity of the ship is in its longitudinal plane of symmetry, y_G is zero and the vertical distance z_G does not appear in the equations.

The forces X , Y and moment N can be expressed as functions of the state variables u , v , r , their time derivatives \dot{u} , \dot{v} , \dot{r} and the rudder angle δ :

$$X = X(u, v, r, \dot{u}, \dot{v}, \dot{r}, \delta) \quad (4.19)$$

$$Y = Y(u, v, r, \dot{u}, \dot{v}, \dot{r}, \delta) \quad (4.20)$$

$$N = N(u, v, r, \dot{u}, \dot{v}, \dot{r}, \delta) \quad (4.21)$$

Expanding the above equations into a Taylor series and removing terms of order higher than 3 yields [Fossen, 1994]:

$$\begin{aligned} X = & X^* + X_u \dot{u} + X_u \Delta u + X_{uu} \Delta u^2 + X_{uuu} \Delta u^3 + X_{vv} v^2 + X_{rr} r^2 + X_{\delta\delta} \delta^2 \\ & + X_{rv} rv \delta + X_{r\delta} r \delta + X_{v\delta} v \delta + X_{vuu} v^2 \Delta u + X_{ruu} r^2 \Delta u + X_{\delta\delta u} \delta^2 \Delta u \\ & + X_{rvu} rvu + X_{r\delta u} r \delta \Delta u + X_{v\delta u} v \delta \Delta u \end{aligned} \quad (4.22)$$

$$\begin{aligned} Y = & Y^* + Y_u \Delta u + Y_{uu} \Delta u^2 + Y_r r + Y_v v + Y_r \dot{r} + Y_v \dot{v} + Y_\delta \delta + Y_{rrr} r^3 + Y_{vvv} v^3 + Y_{\delta\delta\delta} \delta^3 \\ & + Y_{rr\delta} r^2 \delta + Y_{\delta\delta r} \delta^2 r + Y_{rrv} r^2 v + Y_{vvr} v^2 r + Y_{\delta\delta v} \delta^2 v + Y_{vv\delta} v^2 \delta + Y_{\delta vr} \delta vr \\ & + Y_{vu} v \Delta u + Y_{vuu} v \Delta u^2 + Y_{ru} r \Delta u + Y_{ruu} r \Delta u^2 + Y_{\delta u} \delta \Delta u + Y_{\delta uu} \delta \Delta u^2 \end{aligned} \quad (4.23)$$

$$\begin{aligned} N = & N^* + N_u \Delta u + N_{uu} \Delta u^2 + N_r r + N_v v + N_r \dot{r} + N_v \dot{v} + N_\delta \delta + N_{rrr} r^3 + N_{vvv} v^3 + N_{\delta\delta\delta} \delta^3 \\ & + N_{rr\delta} r^2 \delta + N_{\delta\delta r} \delta^2 r + N_{rrv} r^2 v + N_{vvr} v^2 r + N_{\delta\delta v} \delta^2 v + N_{vv\delta} v^2 \delta + N_{\delta vr} \delta vr \\ & + N_{vu} v \Delta u + N_{vuu} v \Delta u^2 + N_{ru} r \Delta u + N_{ruu} r \Delta u^2 + N_{\delta u} \delta \Delta u + N_{\delta uu} \delta \Delta u^2 \end{aligned} \quad (4.24)$$

The hydrodynamic derivatives in above equations are defined as [Fossen, 1994]:

$$F^* = F(\mathbf{X}_0), \quad F_{x_i} = \frac{\partial F(\mathbf{X})}{\partial x_i} \Big|_{\mathbf{X}_0}, \quad F_{x_i x_j} = \frac{1}{2} \frac{\partial^2 F(\mathbf{X})}{\partial x_i \partial x_j} \Big|_{\mathbf{X}_0}, \quad F_{x_i x_j x_k} = \frac{1}{6} \frac{\partial^3 F(\mathbf{X})}{\partial x_i \partial x_j \partial x_k} \Big|_{\mathbf{X}_0}$$

where $F \in \{X, Y, N\}$.

4.4 Manoeuvring Model Used

As mentioned in Chapter 3, the navigation environment including geographical configuration and weather condition influence ship navigation. From the operator's point of view, the geographical configuration is the main factor to consider when actions are taken to avoid collision. The weather condition is the mainly factor when ship's optimum navigation route in open water is decided and it is of less significance for navigation in harbours or confined waterways, except in the cases of extreme weather conditions.

The objective of this study described in this thesis is not to solve an optimal trajectory problem for different weather conditions, but to find safe way and achieve collision avoidance in real time in confined waterways. The key work, therefore, is to develop a simple and effective method of automatic trajectory planning and collision avoidance. Therefore, the weather environment was not taken into consideration in this thesis.

The mathematical model simulating the ship's motion in a horizontal plane is derived on the basis of the following assumption:

- the ship sails in calm water, and hydrodynamic effects of bank and shallow water and the effects of passing ships are ignored.

Therefore, with reference to the two coordinate systems as shown in Figure 4-3, the ship manoeuvring model used is as follows:

$$\begin{cases} \dot{x}_0 = u \cos \psi - v \sin \psi \\ \dot{y}_0 = u \sin \psi + v \cos \psi \\ \dot{\psi} = r \\ m(\dot{u} - vr - x_G r^2) = X \\ m(\dot{v} + ur + x_G r^2) = Y \\ I_z \dot{r} + m x_G (\dot{v} + ur) = N \end{cases} \quad (4.25)$$

This model includes six state variables $(x_0, y_0, \psi, u, v, r)$ and one control variable, the rudder angle δ . It will yield sufficient information to show the manoeuvring behaviour of the ship.

The model of Mariner class ship was chosen for the current research, because this ship has been examined in detail in various comparative studies by different authors and detailed information is available on its manoeuvring characteristics. For this ship, the main data and dimensions are taken from [Fossen, 1994], the non-dimensional mathematical model used for the simulation of three degrees-of-freedom motions is described in matrix form as follows:

$$\begin{bmatrix} m' - X'_u & 0 & 0 \\ 0 & m' - Y'_v & m' x'_G - Y'_r \\ 0 & m' x'_G - N'_v & I'_z - N'_r \end{bmatrix} \begin{bmatrix} \Delta u' \\ \Delta v' \\ \Delta r' \end{bmatrix} = \begin{bmatrix} \Delta X' \\ \Delta Y' \\ \Delta N' \end{bmatrix} \quad (4.26)$$

where all variables designed with the superscript $(')$ are normalized by Prime-System (where L_{pp} is the length of ship between perpendiculars, and ship's total speed $U = \sqrt{u^2 + v^2}$ are normalization variables) and:

$$\begin{aligned} \Delta X' &= X'_u \Delta u' + X'_{uu} \Delta u'^2 + X'_{uuu} \Delta u'^3 + X'_{vv} \Delta v'^2 + X'_{rr} \Delta r'^2 + X'_{rv} \Delta r' \Delta v' \\ &+ X'_{\delta\delta} \Delta \delta'^2 + X'_{u\delta\delta} \Delta u' \Delta \delta'^2 + X'_{v\delta} \Delta v' \Delta \delta' + X'_{uv\delta} \Delta u' \Delta v' \Delta \delta' \end{aligned} \quad (4.27)$$

$$\begin{aligned}
\Delta Y' &= Y'_v \Delta v' + Y'_r \Delta r' + Y'_{vvv} \Delta v'^3 + Y'_{vvr} \Delta v'^2 \Delta r' + Y'_{vu} \Delta v' \Delta u' + Y'_{ru} \Delta r' \Delta u' \\
&+ Y'_\delta \Delta \delta' + Y'_{\delta\delta\delta} \Delta \delta'^3 + Y'_{u\delta} \Delta u' \Delta \delta' + Y'_{uu\delta} \Delta u'^2 \Delta \delta' + Y'_{v\delta\delta} \Delta v' \Delta \delta'^2 \\
&+ Y'_{vv\delta} \Delta v'^2 \Delta \delta' + Y^{0'} + Y_u^{0'} \Delta u' + Y_{uu}^{0'} \Delta u'^2
\end{aligned} \tag{4.28}$$

$$\begin{aligned}
\Delta N' &= N'_v \Delta v' + N'_r \Delta r' + N'_{vvv} \Delta v'^3 + N'_{vvr} \Delta v'^2 \Delta r' + N'_{vu} \Delta v' \Delta u' + N'_{ru} \Delta r' \Delta u' \\
&+ N'_\delta \Delta \delta' + N'_{\delta\delta\delta} \Delta \delta'^3 + N'_{u\delta} \Delta u' \Delta \delta' + N'_{uu\delta} \Delta u'^2 \Delta \delta' + N'_{v\delta\delta} \Delta v' \Delta \delta'^2 \\
&+ N'_{vv\delta} \Delta v'^2 \Delta \delta' + N^{0'} + N_u^{0'} \Delta u' + N_{uu}^{0'} \Delta u'^2
\end{aligned} \tag{4.29}$$

More details about this model can be found in Appendix A.

In order to verify this mathematical model, turning-circle manoeuvres and zig-zag manoeuvres were simulated. In both cases the approach was made at a constant speed along a straight line path.

Figure 4-4 and 4-5 show the track of the ship's centre of gravity, yaw rate and speed variation during turning-circle manoeuvre for a Mariner class ship for a constant rudder angle of 20 degrees to starboard applied at $t = 50$ seconds. The manoeuvring characteristics were computed. The simulation results can be found in Table 4-1.

Figure 4-6 and 4-7 show the same for a constant rudder angle of 35 degrees to starboard applied at $t = 50$ seconds. The simulation results can be found in Table 4-1.

The simulation results are compared with the reference results as shown in Figure 4-8 [Jia & Yang, 1999] and can be found in Table 4-1.

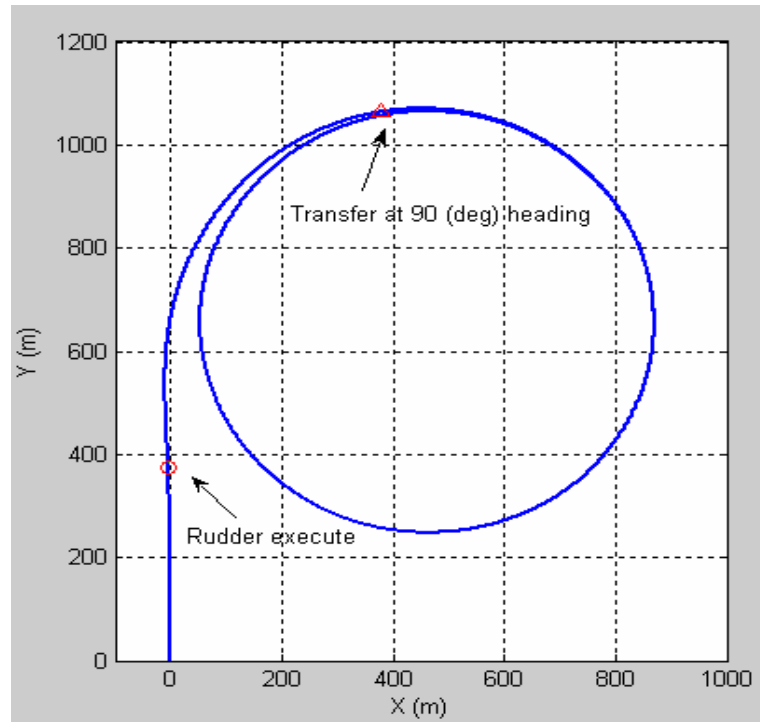

Figure 4- 4: Turning circle for a constant rudder angle $\delta = -20$ degree

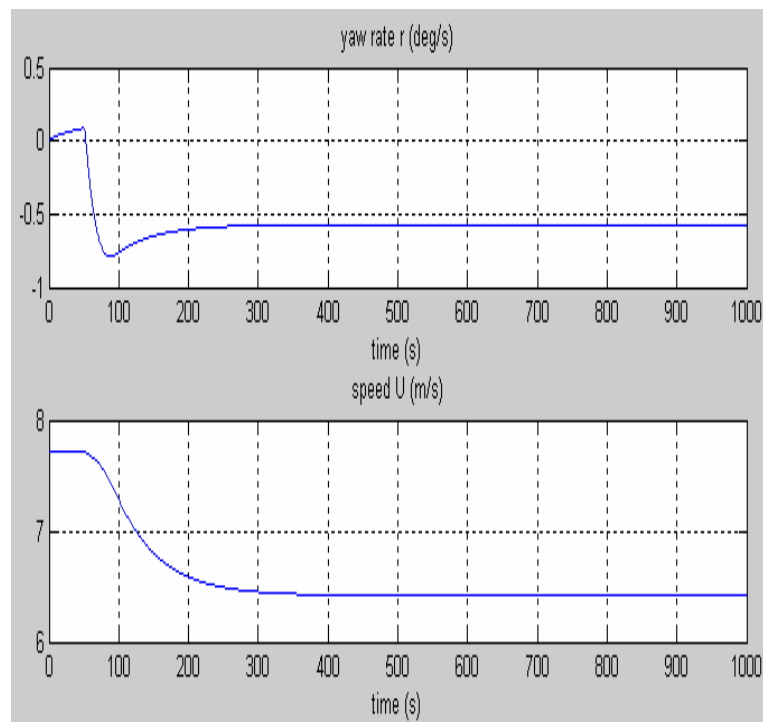

Figure 4- 5: Yaw rate and speed for a constant rudder angle $\delta = -20$ degree

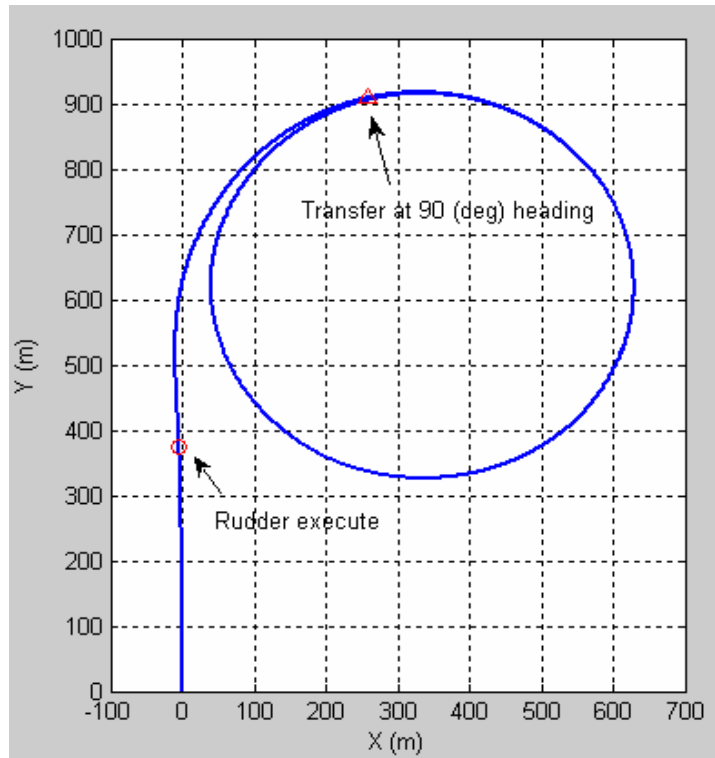

Figure 4- 6: Turning circle for a constant rudder angle $\delta = -35$ degree

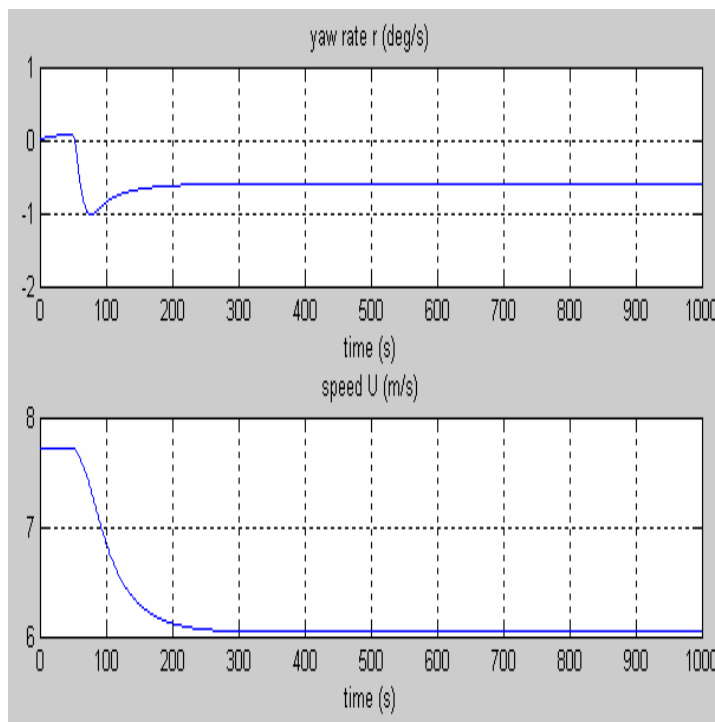

Figure 4- 7: Yaw rate and speed for a constant rudder angle $\delta = -35$ degree

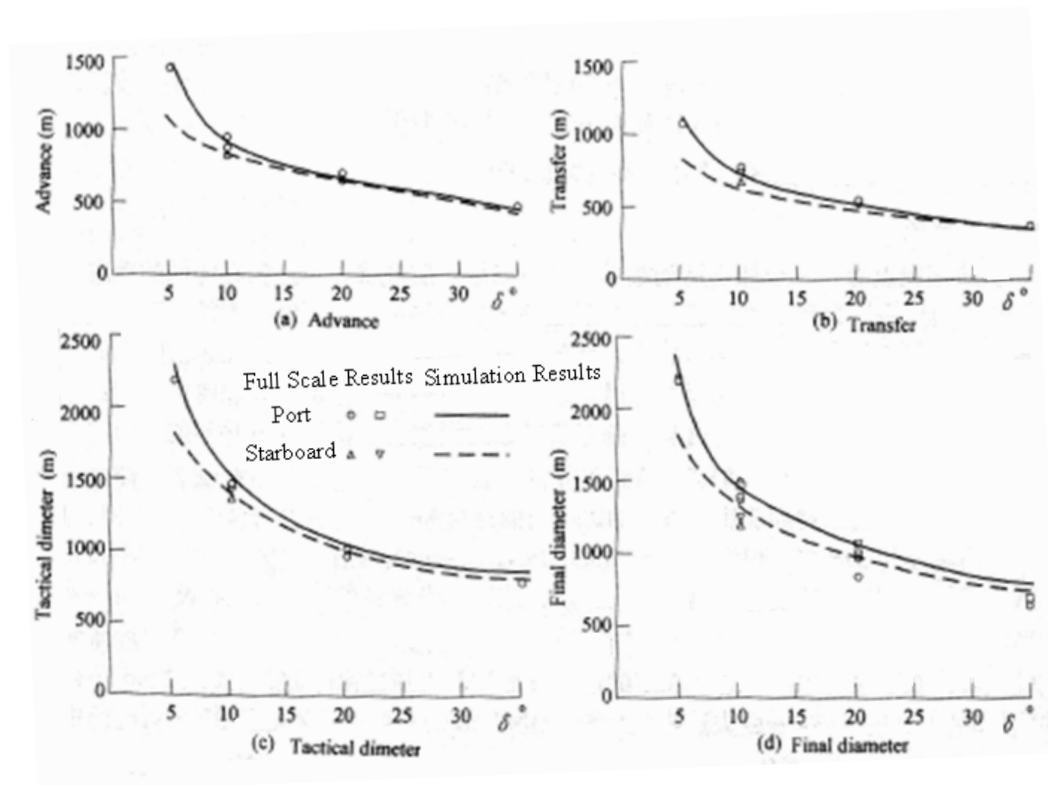

Figure 4- 8: The turning-circle manoeuvre for the Mariner class ship (after Jia & Yang, 1999)

Table 4- 1: The simulation results of turning-circle manoeuvres

Turning-circle manoeuvres	The manoeuvring characteristics	The results of the developed program	The full scale results [Jia & Yang, 1999]
Rudder angle $\delta = -20$ degree	Advance	685 m	730 m
	Transfer	380 m	510 m
	Tactical diameter	863 m	930 m
	Final diameter	810 m	850 m
Rudder angle $\delta = -35$ degree	Advance	523 m	570 m
	Transfer	257 m	380 m
	Tactical diameter	621 m	720 m
	Final diameter	590 m	650 m

Figure 4-9 shows the result of a $20^\circ - 20^\circ$ zig-zag manoeuvre. Figure 4-10 shows the same simulation results in the reference [Jia & Yang, 1999].

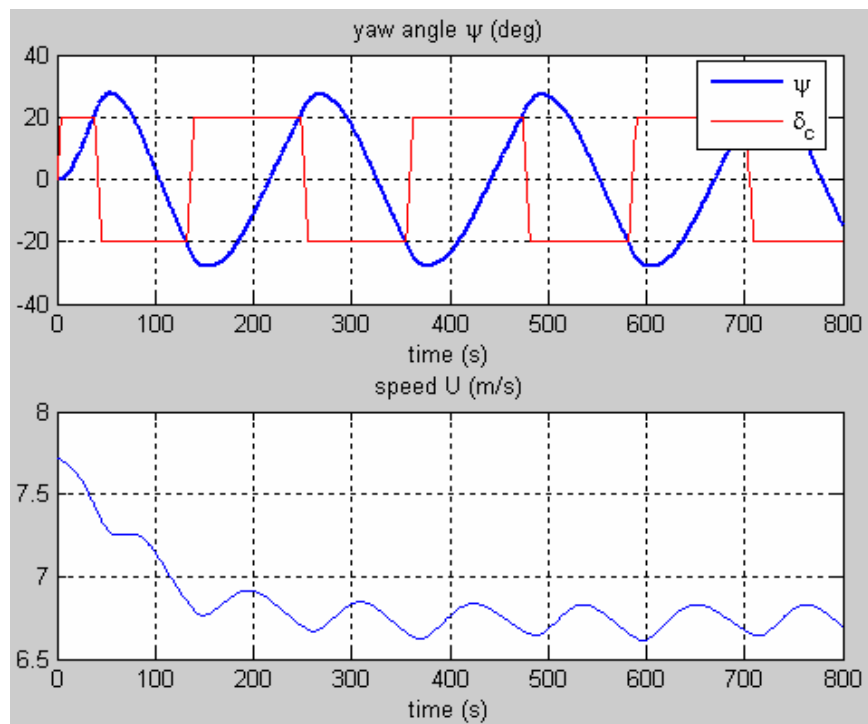

Figure 4- 9: $20^\circ - 20^\circ$ zig-zag manoeuvre

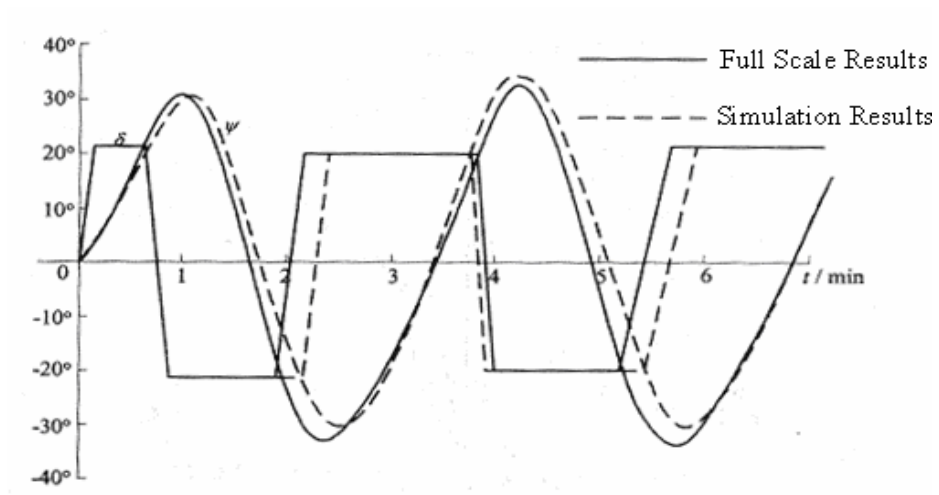

Figure 4- 10: $20^\circ - 20^\circ$ zig-zag manoeuvre for the Mariner class ship (after Jia & Yang, 1999)

From Table 4-1, we can see the simulation results of turning-circle manoeuvres are close to the reference results. From Figure 4-9 and 4-10, we can see that the angle of overshoot and the time it takes to reach the second execution of the heading as calculated by the simulation are close enough to the full scale results.

From this comparison, we can conclude that the mathematical model used for the current study is accurate enough for our purposes.

Adopted Terminologies

In this thesis, several terminologies have been adopted.

The term “confined waterway” means a restricted area in which a ship has to comply with safety regulations and negotiate many static obstacles possibly in the presence of other traffic.

In this thesis, ‘own ship’ is the ship which is in direct control of the user/reader. ‘Strange ships’ are any other ships beside own ship.

Chapter 5:

Automated Route Finding

5.1 Introduction

One of the key elements in automatic ship navigation simulation is the ability to find safe paths for the ship automatically. A similar problem was faced by researchers working in autonomous robots. One of the methods developed as a result is based on the concept of potential field.

This method is applied to ship's route finding, the details of which including attractive potential function, repulsive potential function and total force, are explained in this chapter. Finally, the limitations of potential field method are addressed.

5.2 Route Finding

Route finding in congested waterways is a complex task because of many limitations and/or constraints due to ship kinematics, mechanics and manoeuvrability, hydrodynamics and the operating environment. This is further complicated by the vessel mission, geographical constraints, existence of obstacles, requirement of collision avoidance and feasibility [Fossen, 2002].

Finding a safe route for a ship to follow avoiding any risk of collision is traditionally assisted by ARPA system. The ARPA system can process positional data and display the navigational situation on the radar screen and allow the navigator to make reasonable decisions on what manoeuvre to take. The final decision on how to act in

order to avoid the collision where a risk of such exists, however, must still be the responsibility of the navigator.

An intelligent route planning method of a route advisory system should, for a given circumstance (e.g. a potential collision situation), be able to find a set of feasible safe routes, calculate the anti-collision manoeuvres, and communicate these manoeuvres clearly to the navigator who steers the ship. When a simulator equipped with such a capability is used for training purposes, it can teach the navigator good habits and enhance his general decision-making skills.

5.3 Potential Field Method Applied to Route Finding for a Ship

As described in Chapter 3, route finding for a ship is, in a sense, similar to the path finding of a mobile robot. Consider a ship wishing to sail from its starting position to its destination point. There is an obstacle in the way of a direct route between the two points. The shortest route for the ship to follow is shown in blue line ('Desired Track') in Figure 5-1. However, the actual safe route will be something like that shown as the 'Actual Track'. This actual track can be determined by applying the potential field method.

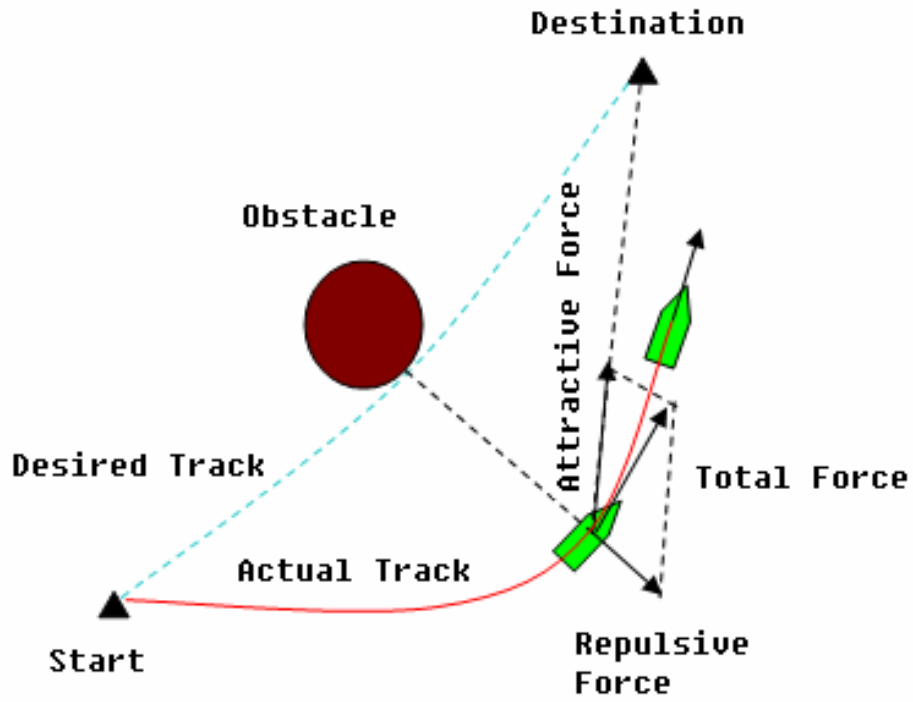

Figure 5- 1: The potential field in ship's route planning

If the ship is designed to follow the negative gradient in the total potential energy, it will finally converge to the destination since that is the lowest point in the potential field which may be likened as an upside-down bell.

Since the ship is pulled towards the destination, the potential energy responsible for it can be regarded as something similar to gravitational. The obstacle can be represented with imaginary potential field energy which can be denoted as \vec{U}_{rep} . Thus,

$$\vec{U}(\vec{p}) = \vec{U}_{att}(\vec{p}) + \vec{U}_{rep}(\vec{p}) \quad (5.1)$$

where $\vec{U}(\vec{p})$ is the total potential energy;

$\vec{U}_{att}(\vec{p})$ is the potential energy due to attraction towards destination point;

$\vec{U}_{rep}(\vec{p})$ is the potential energy due to repulsion of the obstacle;

\vec{p} denotes a point on the water surface;

The ship then is subjected to a force which is derived from this total potential energy as follows:

$$\vec{F} = \vec{F}_{att} + \vec{F}_{rep} \quad (5.2)$$

$$\text{where } \vec{F}_{att} = -grad(\vec{U}_{att}(\vec{p}))$$

$$\vec{F}_{rep} = -grad(\vec{U}_{rep}(\vec{p}))$$

\vec{F}_{att} is the attractive force, and it pulls the ship towards the destination; \vec{F}_{rep} is repulsive force, and it pushes the ship away from the obstacle thus avoiding collision. The feasible path now can be found by following the direction of the total force at any given position. More than one obstacle can be accounted for by summing all their repulsive forces.

5.3.1 Attractive Potential Function

In general, the attractive potential field has the form shown in Figure 5-2, where in every point of the workspace, the negative gradient flows towards the goal.

In general, the attractive potential is a function of the relative distance between the ship and the destination point. In this thesis, the attractive potential function is presented as follows

$$\vec{U}_{att}(\vec{p}) = \alpha \|\vec{p}_d - \vec{p}(t)\|^m \quad (5.3)$$

where \vec{p}_d and $\vec{p}(t)$ denote the destination position and the position of ship at time t , respectively;

$\|\vec{p}_d - \vec{p}(t)\|$ is the Euclidean distance between the ship at time t and the destination position;

α is a gain parameter and is a positive scalar quantity; and

m is a positive constant determining the shape of the destination ‘bell’ or ‘trap’.

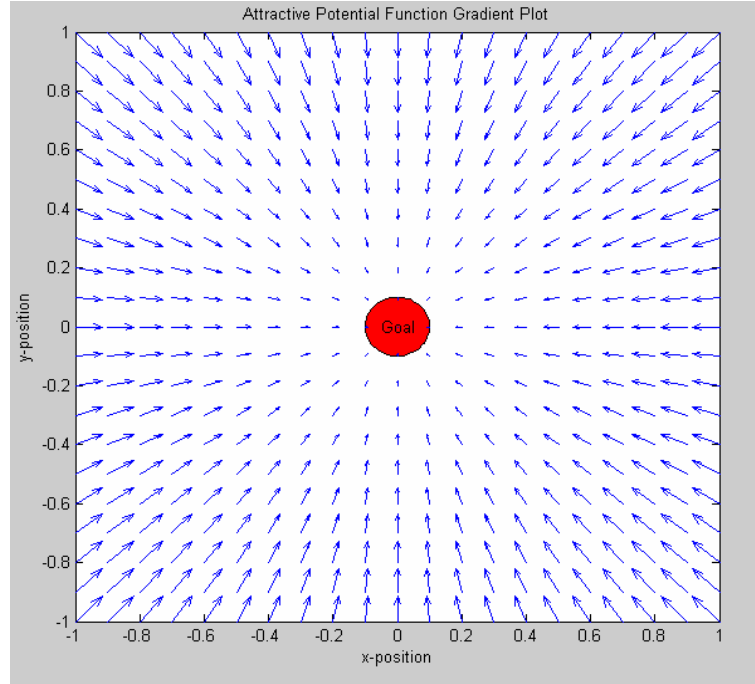

Figure 5- 2: Attractive potential function gradient plot

Since the virtual attractive force is the negative gradient of the attractive potential,

$$\vec{F}_{att}(\vec{p}) = -\nabla \vec{U}_{att}(\vec{p}) = -\frac{\partial \vec{U}_{att}(\vec{p})}{\partial \vec{p}} \quad (5.4)$$

Substituting (5.3) into (5.4),

$$\vec{F}_{att}(\vec{p}) = m\alpha \|\vec{p}_d - \vec{p}(t)\|^{m-1} \quad (5.5)$$

From equation (5.3) and (5.5), we can modify the shape of the attractive potential field by changing the value of m , and we can modify the strength of the attractive potential field by modifying the value of α .

- (1) For $m=1$, as shown in Figure 5-3, the attractive potential field is conic in shape and the resulting attractive force has constant amplitude except at the destination position, where $\vec{U}_{att}(\vec{p})$ is singular and when $\vec{p}_d = \vec{p}(t)$, $\vec{F}_{att}(\vec{p}) = 0$.

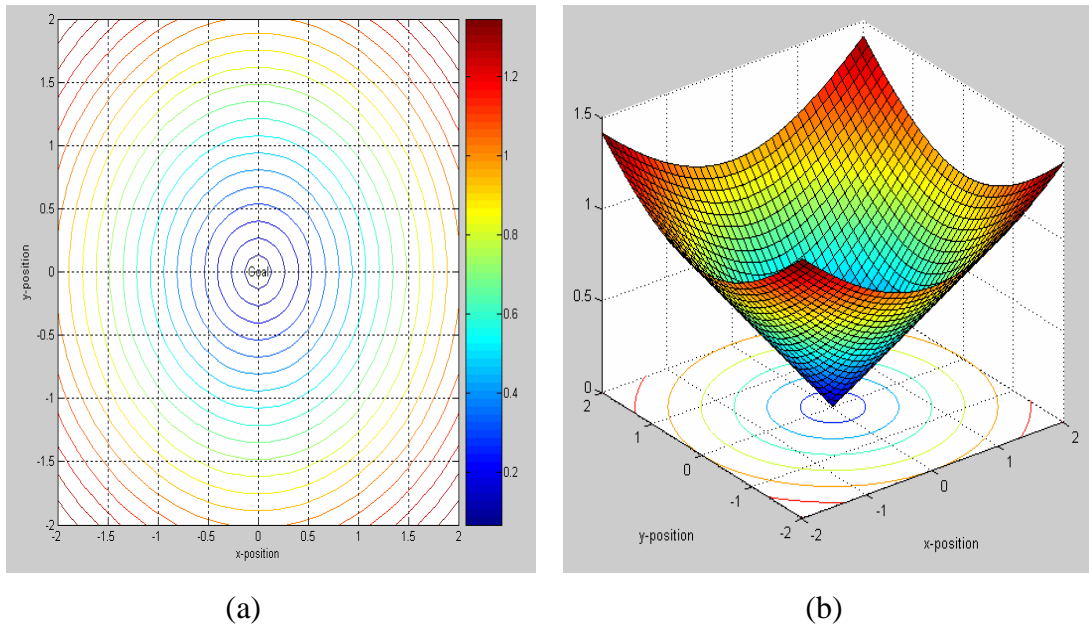
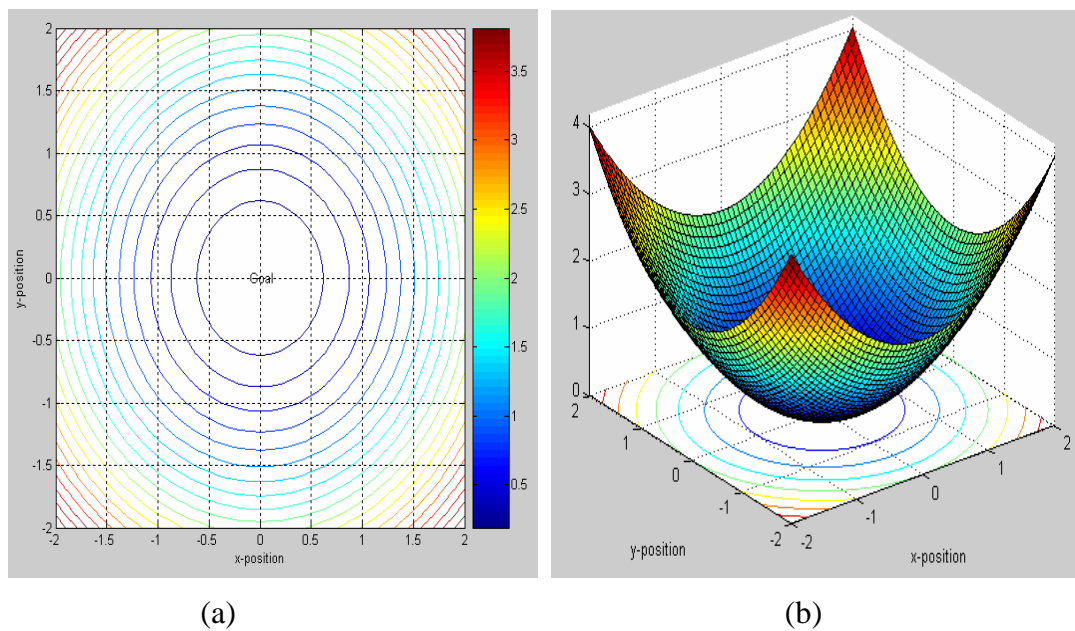
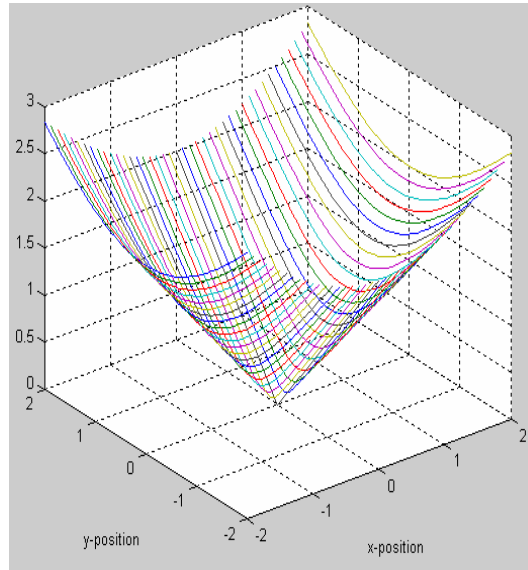

Figure 5- 3: (a) Attractive potential field in contour plot; and (b) in 3D view, with $m=1$, $\alpha = 0.5$ and the goal position at $(0,0)$

(2) For $m=2$, the attractive potential is parabolic in shape. The corresponding attractive force converges linearly toward zero as the ship approaches the destination as shown in Figure 5-4.





(c)

Figure 5- 4: (a) Attractive potential field in contour plot; and (b) in 3D view, with $m=2$, $\alpha = 0.5$ and the goal position at $(0,0)$; (c) the attractive force

(3) For $m=3$, the attractive potential and the corresponding attractive force are shown in Figure 5-5.

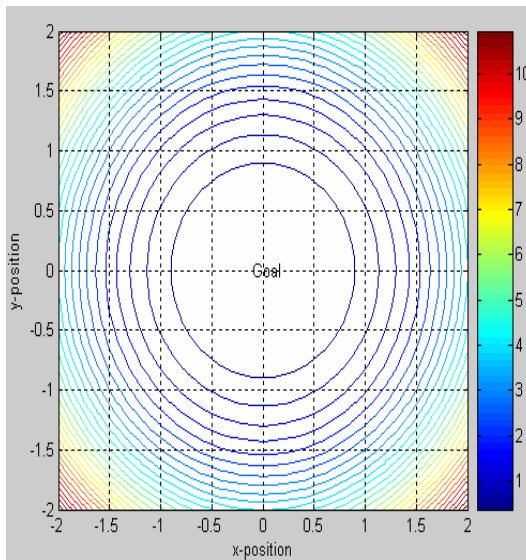

(a)

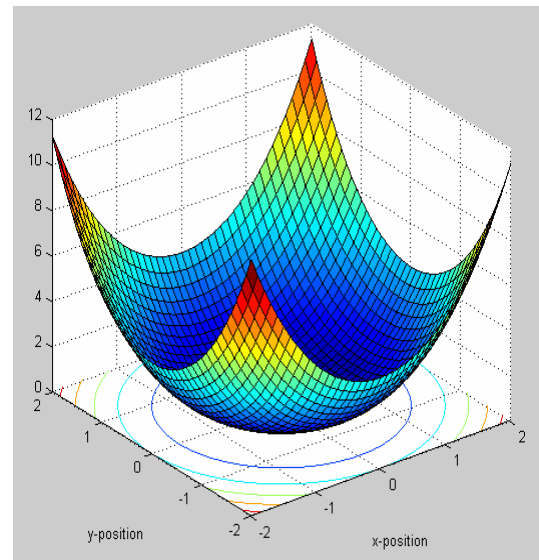

(b)

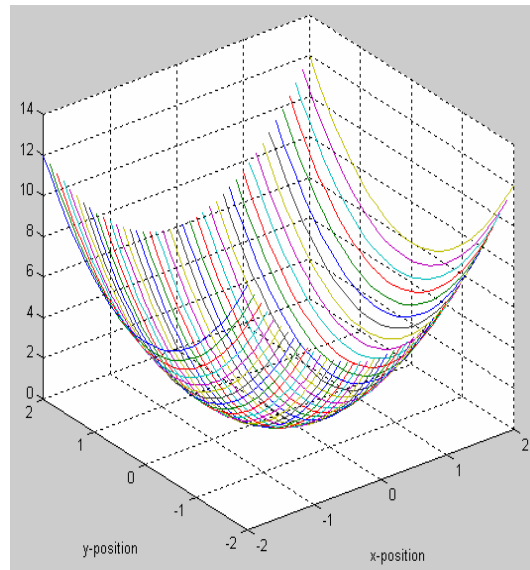

(c)

Figure 5- 5: (a) Attractive potential field in contour plot; and (b) in 3D view, with $m=3$, $\alpha = 0.5$ and the goal position at $(0,0)$; (c) the attractive force

From the above studies, the attractive force is seen to converge linearly toward zero as the ship approaches the destination when $m=2$. So it is common to use $m \geq 2$ to provide a minimum attractive potential value at the destination position.

5.3.2 Repulsive Potential Function

In general, the repulsive potential fields have high potential around the obstacle, so that the gradient flow points away from the obstacle, as shown in Figure 5-6.

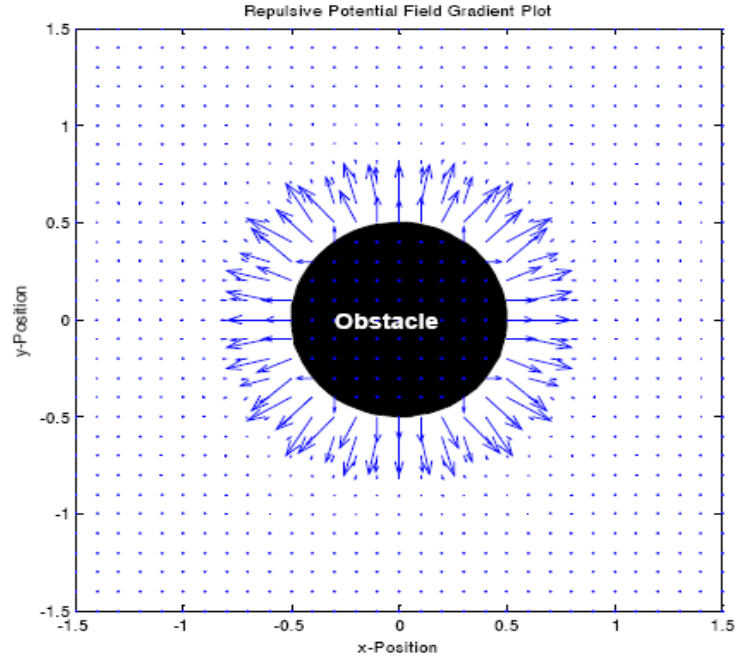

Figure 5- 6: Gradient plot of a general repulsive potential field, where all the gradients point away from the obstacle

There are many examples of repulsive potential functions. The *Force Inducing an Artificial Repulsion from the Surface Function* (FIRAS Function), as proposed by Khatib [Khatib, 1986], is one of the examples of the most commonly used.

In his method, the potential of the FIRAS function is described by:

$$\vec{U}_{rep}(\vec{p}) = \begin{cases} \frac{1}{2}\eta \left(\frac{1}{\rho_{RO}} - \frac{1}{\rho_o} \right)^2 & \text{if } \rho_{RO} \leq \rho_o \\ 0 & \text{if } \rho_{RO} > \rho_o \end{cases} \quad (5.6)$$

where $\vec{U}_{rep}(\vec{p})$ denotes the repulsive potential generated by the obstacle;

η is a positive scaling factor;

$\rho_{RO} = \|\vec{p}_{Obs} - \vec{p}_{Rob}\|$ is the shortest Euclidean distance between the robot and the obstacle surface, and \vec{p}_{Obs} is the position of obstacle, \vec{p}_{Rob} is the position of robot;

ρ_o is the limit distance of the repulsive potential field influence.

With this commonly used FIRAS function, a problem named GNRON (*Goal Non-Reachable with Obstacles Nearby*) is found in some cases. When a destination is placed very close to the obstacle, that is, within the influence range of the obstacle, the global minimum point may not be at the destination position. In this scenario, (unlike local minima problem which will be discussed later in this Chapter), the global minimum is ‘pushed’ away from where it is supposed to be (i.e. the target), to another position. As a result, the robot cannot reach the correct target point. This GNRON problem is well documented in [Khosla, 1988], [Ge & Cui, 2000] and [Ge & Cui, 2002].

Consider a situation shown in Figure 5-7. The target is placed at (13,10), and a circular obstacle of radius 2 is located at (10,10). The repulsive potential field is created using FIRAS function given by equation (5.6) with $\eta = 4$ and the influence range of the repulsive potential field ρ_0 is 5. The attractive potential is created using equation (5.3) with $m = 2$ and $\alpha = 0.1$. The contour plot of the total potential field for this scenario is shown in Figure 5-8.

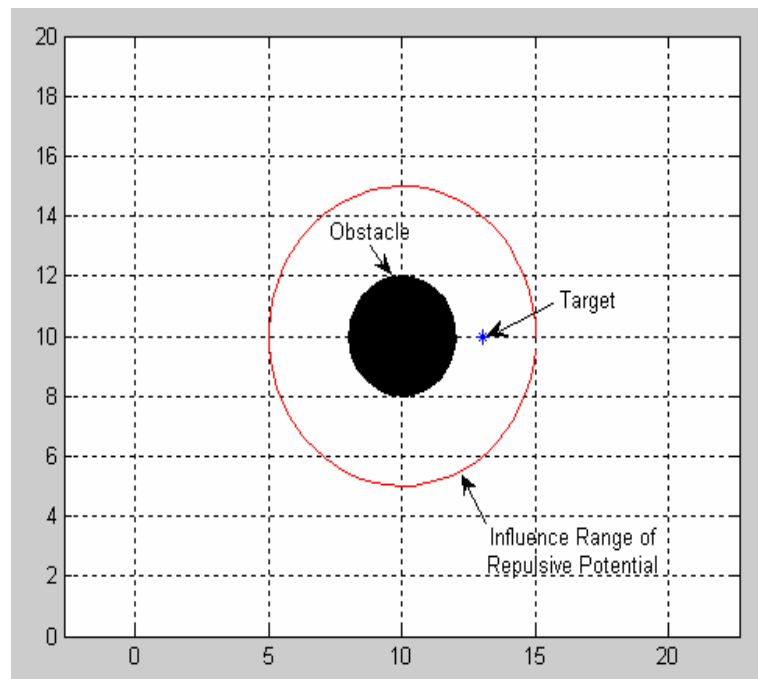

Figure 5- 7: A scenario in which GNRON problem can occur

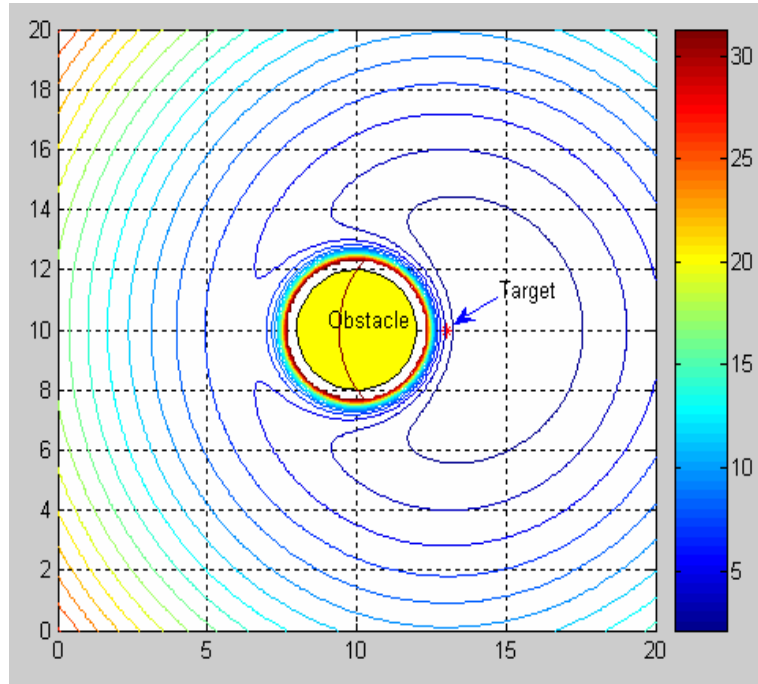

Figure 5- 8: The potential contour plot of scenario shown in Figure 5-7

From this we can see that the global minimum point is not located at the target position, but to the right of it.

In applying the potential field method for ship's route finding in ship navigation, the GNRON problem is likely to be encountered. For example, the destination point ('target') can be near other structures, or a moving ship can pass near the target. In order to alleviate this problem a new repulsive potential function, due to Ge and Cui [Ge & Cui, 2002], is adopted.

This repulsive potential function is described as follows:

$$\bar{U}_{rep}(\bar{p}) = \begin{cases} \frac{1}{2}\eta \left(\frac{1}{p_s} - \frac{1}{p_o} \right)^2 \|\bar{p}(t) - \bar{p}_d\|^n & \text{if } p_s \leq p_o \\ 0 & \text{if } p_s > p_o \end{cases} \quad (5.7)$$

where, $\bar{U}_{rep}(\bar{p})$ denotes the repulsive potential generated by the obstacle;

η and n are positive constants;

\vec{p}_d and $\vec{p}(t)$ denote the destination and the position of ship at time t respectively;

p_s is the shortest Euclidean distance between the ship and the obstacle surface;

p_o is a positive constant describing the influence range of the obstacle.

When equation (5.7) is compared to the FIRAS function given in equation (5.6), it can be seen that the introduction of the term $\|\vec{p}(t) - \vec{p}_d\|^n$ ensures that total potential will reach its global minimum, if and only if the ship reaches the destination where $\|\vec{p}(t) - \vec{p}_d\| = 0$.

Similar to the definition of the attractive force, the corresponding repulsive force is defined as the negative gradient of the repulsive potential in terms of position, i.e.

$$\vec{F}_{rep}(\vec{p}) = -\nabla \vec{U}_{rep}(\vec{p}) = -\frac{\partial \vec{U}_{rep}(\vec{p})}{\partial \vec{p}} \quad (5.8)$$

Substituting equation (5.7) into (5.8), the equation is

$$\vec{F}_{rep}(\vec{p}) = \begin{cases} \vec{F}_{rep1} + \vec{F}_{rep2} & \text{if } p_s \leq p_o \\ 0 & \text{if } p_s > p_o \end{cases} \quad (5.9)$$

where

$$\begin{aligned} \vec{F}_{rep1} &= \eta \left(\frac{1}{p_s} - \frac{1}{p_o} \right) \frac{1}{p_s^2} \|\vec{p}(t) - \vec{p}_d\|^n \\ \vec{F}_{rep2} &= \frac{n}{2} \eta \left(\frac{1}{p_s} - \frac{1}{p_o} \right)^2 \|\vec{p}(t) - \vec{p}_d\|^{n-1} \end{aligned} \quad (5.10)$$

In order to demonstrate that the GNRON problem can be avoided using this new repulsive potential function, the scenario examined previously was studied again and with the same parameters. The new contour plot of the total potential field is shown in Figure 5-9.

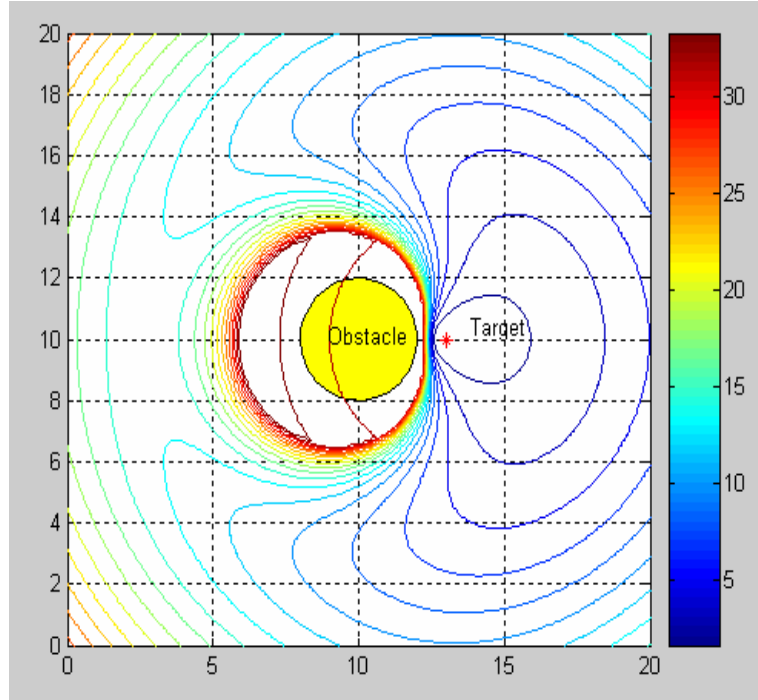

Figure 5- 9: The contour plot demonstrating the solution of GNRON problem

From this, we can see that, even when the target is placed close to the obstacle and well within the influence range of the repulsive potential field, the total minimum is still located at the target position. The GNRON problem, therefore, is resolved.

From equation (5.7) and (5.10), we can modify the nature of the repulsive potential function by changing the value of n , and we can control the effect of the repulsive potential field by modifying the value of η .

For different choices of n , the corresponding mathematical properties are as follows:

(1) If $n = 0$, the repulsive potential function degenerates to the conventional form

$$\vec{U}_{rep}(\vec{p}) = \begin{cases} \frac{1}{2}\eta\left(\frac{1}{p_s} - \frac{1}{p_o}\right)^2 & \text{if } p_s \leq p_o \\ 0 & \text{if } p_s > p_o \end{cases}$$

This is inappropriate as a GNRON problem can occur as discussed above.

(2) For $0 < n < 1$, when $p_s < p_o$ and $\vec{p}(t) \neq \vec{p}_d$, the repulsive force is

$$\begin{aligned}\vec{F}_{rep1} &= \eta \left(\frac{1}{p_s} - \frac{1}{p_o} \right) \frac{1}{p_s^2} \|\vec{p}(t) - \vec{p}_d\|^n \\ \vec{F}_{rep2} &= \frac{n}{2} \eta \left(\frac{1}{p_s} - \frac{1}{p_o} \right)^2 \frac{1}{\|\vec{p}(t) - \vec{p}_d\|^{1-n}}\end{aligned}\quad (5.11)$$

As the ship approaches the destination, $\|\vec{p}(t) - \vec{p}_d\|$ approaches zero. Thus, the first component of the repulsive force \vec{F}_{rep1} approaches zero, while the second component \vec{F}_{rep2} approaches infinity.

(3) For $n = 1$, when $p_s \leq p_o$ and $\vec{p}(t) \neq \vec{p}_d$, the repulsive force is

$$\begin{aligned}\vec{F}_{rep1} &= \eta \left(\frac{1}{p_s} - \frac{1}{p_o} \right) \frac{1}{p_s^2} \|\vec{p}(t) - \vec{p}_d\| \\ \vec{F}_{rep2} &= \frac{1}{2} \eta \left(\frac{1}{p_s} - \frac{1}{p_o} \right)^2\end{aligned}\quad (5.12)$$

As the ship approaches the destination, $\|\vec{p}(t) - \vec{p}_d\|$ approaches zero and consequently p_s approaches a constant distance between destination and the obstacle. The first component of the repulsive force \vec{F}_{rep1} approaches zero, the second component \vec{F}_{rep2} approaches a constant.

$$\frac{1}{2} \eta \left(\frac{1}{p_s} - \frac{1}{p_o} \right)^2 \quad (5.13)$$

(4) For $n > 1$, as the ship approaches the destination, both of the repulsive force element \vec{F}_{rep1} and \vec{F}_{rep2} approach zero, rendering the total force converging to zero.

It is, therefore, common to use $n > 1$ to create repulsive potential function. However, if n is too large, the repulsive force will be too large. In this thesis, therefore, a value of 2 was chosen for n .

The influence range of the obstacle p_o can be adjusted depending upon the ship, its speed and the sailing experience. Normally the selection of this coefficient should take into account some factors as follows:

1) Sailing practice.

When selecting the coefficient p_o , the prevailing sailing practice should be taken into consideration. For example, when the distance between the ship and the obstacle is in the range of 3 Nm to 6 Nm, the operator is required to take action to avoid collision [Hilgert & Baldauf, 1997].

2) Ship's dynamic characteristics.

a) Ship's speed and deceleration ability.

If a ship is moving toward the obstacle at time t , and if the ship uses its maximum deceleration (magnitude α_{\max}) to reduce its speed, then the distance travelled by the ship (approaching at a speed U) before it comes to stop is

$$p_{\max} = \frac{U^2}{2\alpha_{\max}} \quad (5.14)$$

Considering the ship's inertia, therefore, the influence range of the obstacle p_o should be larger than p_{\max} .

b) Ship's advance.

If a rudder angle is applied instead deceleration in order to avoid the obstacle, then the distance p_o should be larger than the ship's advance for that rudder angle.

5.3.3 Total Potential Function

Once the attractive and repulsive potential functions are determined, the total potential can be obtained by

$$\vec{U}(\vec{p}) = \vec{U}_{att}(\vec{p}) + \vec{U}_{rep}(\vec{p}) \quad (5.15)$$

The total virtual force can be obtained by

$$\vec{F}_{total}(\vec{p}) = \vec{F}_{att}(\vec{p}) + \vec{F}_{rep}(\vec{p}) \quad (5.16)$$

where $\vec{F}_{att}(\vec{p})$ and $\vec{F}_{rep}(\vec{p})$ can be calculated through equation (5.5) and (5.10).

When there are multiple obstacles, the repulsive force is given by

$$\vec{F}_{rep}(\vec{p}) = \sum_{i=1}^M (\vec{F}_{rep})_i \quad (5.17)$$

where M is the number of obstacles and $(\vec{F}_{rep})_i$ is the repulsive force generated by the i th obstacle. The total virtual force \vec{F}_{total} will be used for passage planning.

5.3.4 The Description of Obstacles

In using potential field method for ship's route finding, one of the main tasks is representation of the obstacles. This must be done automatically if possible, but in such a manner as to ensure that a ship is not allowed to go through a continuous barrier whilst allowing it to proceed through any feasible narrow gap between two close obstacles. In robotics this is achieved by a mixture of 'primitives'. Typical geometric primitives include points, lines, ellipsoids, parallelepipeds, cones, and cylinders [Khatib, 1986].

Confined waterways, such as channels or straits as shown in Figure 5-10, have complex topology. The coastline is long and its shape is random, and thus rendering

ellipsoid, parallelepiped, cone, and cylinder not very useful as primitives.

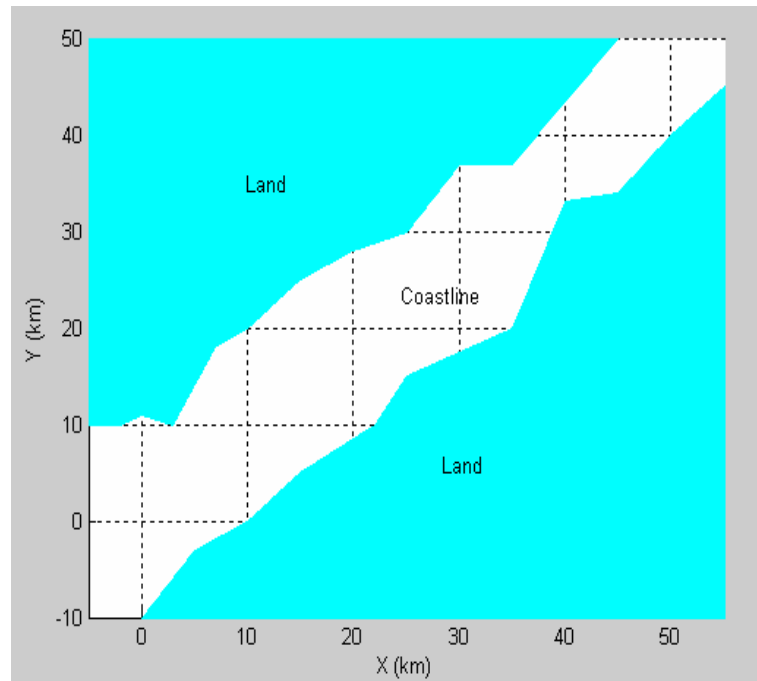

Figure 5- 10: A complex navigation environment

For representing such random obstacles in 2-D, points and lines are not only simple, but probably the most useful as primitives.

The point primitives are the simplest and convenient to describe obstacles. Larger obstacles, such as coastlines and islands, can be represented as a series of point obstacles judiciously placed on the boundaries as shown in Figure 5-11 (the scale used in the figures in the thesis is km).

The method of using lines to represent obstacles is similar to the method of using the point. It needs to place some key points on the boundaries firstly, and then connect these points to make line represent obstacles as shown in Figure 5-12.

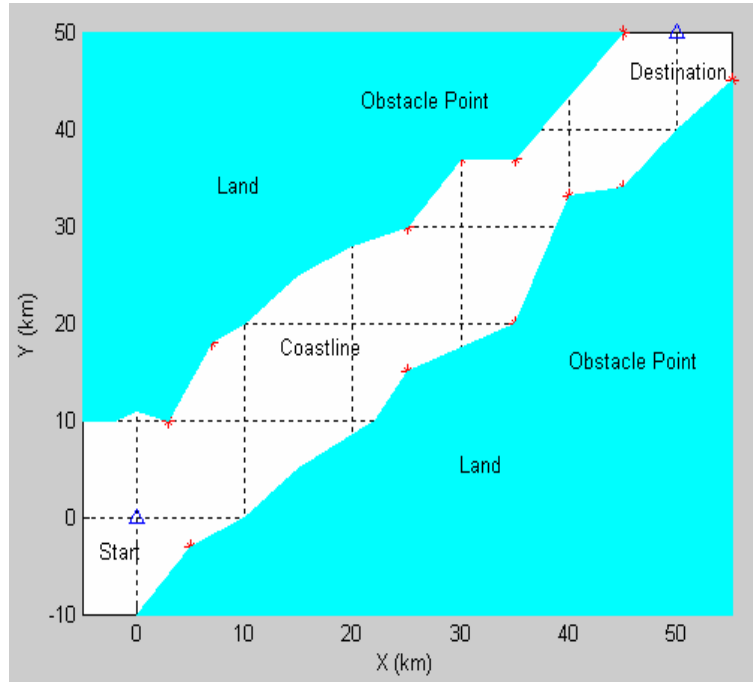

Figure 5- 11: Representation of a coastline with points

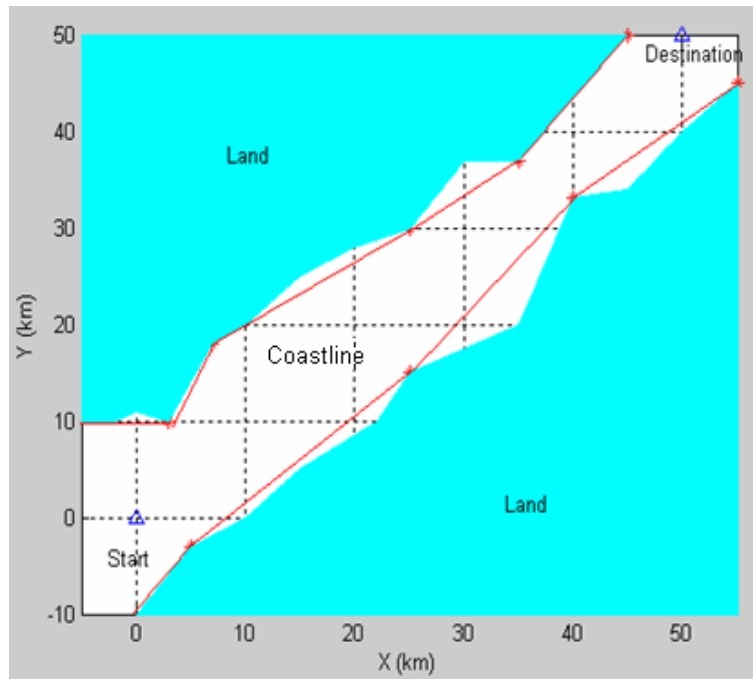

Figure 5- 12: Representation of a coastline with lines

Compared to the point, the line appears to be more realistic. However, if lines are used to represent obstacles, an additional algorithm for finding the shortest distance between the ship and the line is required. This process increases computation time and complexity in simulation compared to simple point obstacles. In any case, once the idea of potential field method is fully developed with point obstacles, only fairly minor adjustments will be required to use lines as primitives. Consequently point primitives are exclusively used in this thesis to describe obstacles.

Placing of point obstacles to represent coastlines and islands can be done in two stages. Firstly, obstacle points should be placed at major bends and prominences of the navigational boundaries. Secondly, intermediate point obstacles should be placed so that the entire boundary is covered by the influence range of the repulsive potential of the obstacle points. The latter is to ensure that the ship is not allowed to cross the boundary lines.

The second stage can be formalised as follows:

Consider Figure 5-13 where the lines AB and BC represent a part of the boundary. Point obstacles are placed on A, B and C in the first stage. L is the distance between points A and B. It is reasonably clear that, if $L - 2p_o \leq 0$, no more obstacle point is required between A and B. However, if $L - 2p_o > 0$, more point obstacles need to be placed. The number of extra point obstacles required is the smallest integer greater than or equal to

$$\frac{L - 2p_o}{2p_o} \quad (5.18)$$

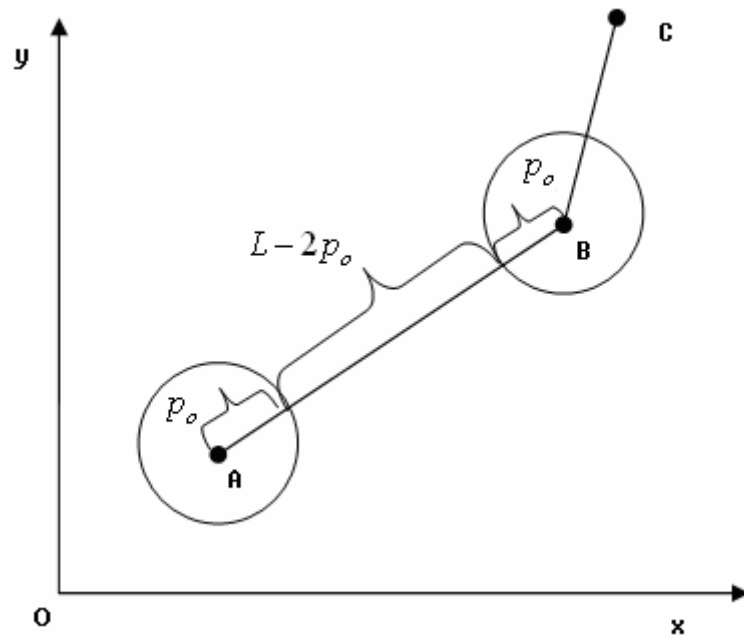
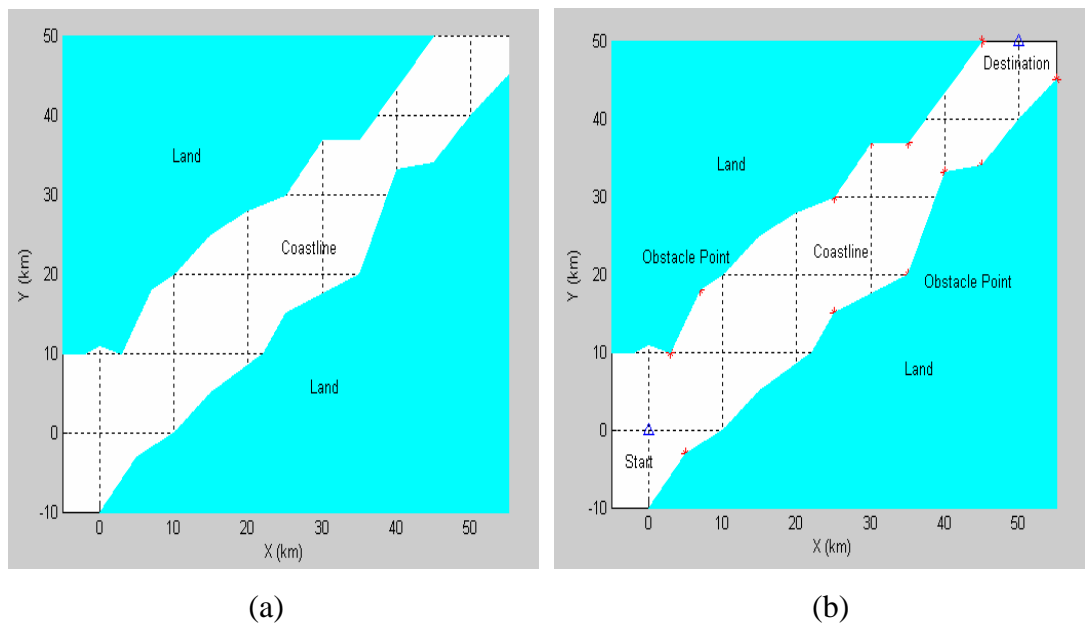
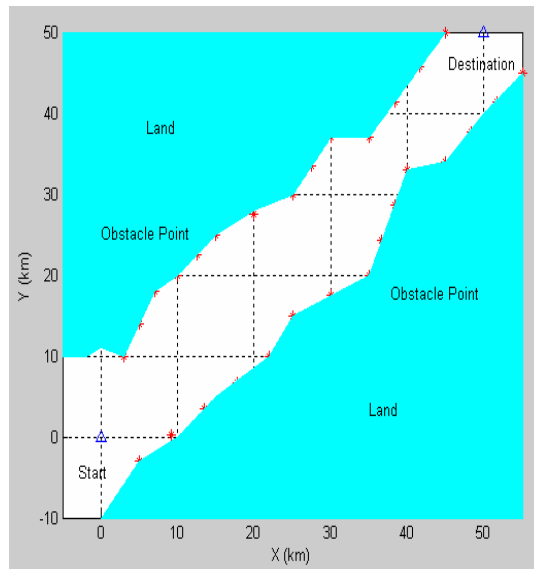

Figure 5-13: Geometry of point obstacles

This idea was implemented a short utility program to generate the point obstacles semi-automatically. Sample screen shots of the program output are shown in Figure 5-14.





(c)

Figure 5- 14: Sample screen shots of the program generating obstacle points. (a) The built map; (b) major point obstacles are placed manually; (c) the system automatically calculates obstacle points where necessary.

The potential field plot of the entire boundary is given in Figure 5-15. The repulsive potential is created using equation (5.7) with $\eta = 10$ and $p_o = 3$ (km). On the other hand, the attractive potential is created using equation (5.3) with $m = 2$ and $\alpha = 1$ within a workspace of $-10 < x < 50$ and $-10 < y < 50$.

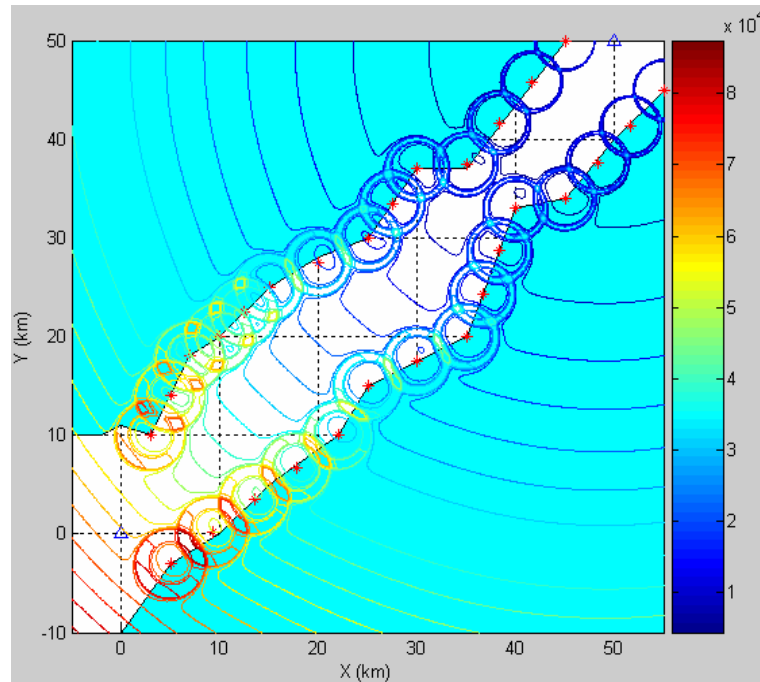

Figure 5- 15: Contour plot of the potential field due to the entire boundary

5.3.5 Limitations with Potential Field Method

As stated previously, potential field method is attractive because of its mathematical elegance and simplicity. However, several limitations inherent in potential field method had been addressed systematically based on mathematical analysis done by Koren [Koren, 1991]. Some of these limitations when applied to robotics were also well documented in [Ge & Cui, 2002] [Rimon, 1992] [Volpe, 1990] [Kim, 1991]. These limitations include:

- (1) situations wherein the robot becomes trapped due to local minima;
- (2) no passage between closely spaced obstacles;
- (3) oscillations in the presence of obstacles;
- (4) oscillations in narrow passages;
- (5) goal non-reachable with obstacles nearby.

It is expected that similar problem will also be present in ship navigation problem. Since GNRON problem has been explored earlier in this Chapter, only the first four will be discussed below.

(a) Local Minima Problem

This problem can occur when the robot runs into a dead end (e.g., inside a U-shaped obstacle), getting trapped therein. In that situation, the sum of all repulsive forces and the sum of all attractive forces act opposite to each other and create a local minimum. This is called a local minima problem, and it is in fact the best-known and most cited problem with potential field method.

When the potential field is applied to ship's route finding, the problem of local minima does exist under a certain condition. Consider the case shown in Figure 5-16 where the ship is proceeding towards its destination and a point obstacle exists exactly in line with the destination. The repulsive force and attractive force will act in the opposite direction and there will be no component at right angles to the ship's heading. No safe route can be found in this case and the algorithm breaks down.

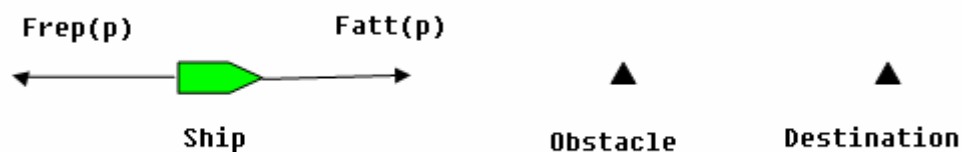

Figure 5- 16: A typical local minima problem

However uncommon such a situation may be, some provision has to be made to resolve this potential difficulty. When this problem is detected, the ship is given a small initial deviation in its heading to avoid the ship being 'trapped', if the ship has an initial non-zero speed. If, for any reason, the initial speed is zero and the local minima problem occurs, the ship can be given a small displacement

sideways so that the situation is no longer as shown in Figure 5-16.

Consider the situation shown in Figure 5-17. The ship's start point is at $(0,0)$ (km) and the destination is at $(20,20)$ (km). There is an obstacle at $(10,10)$ (km). The ship, the obstacle and the destination is exactly in line and local minima problem exists.

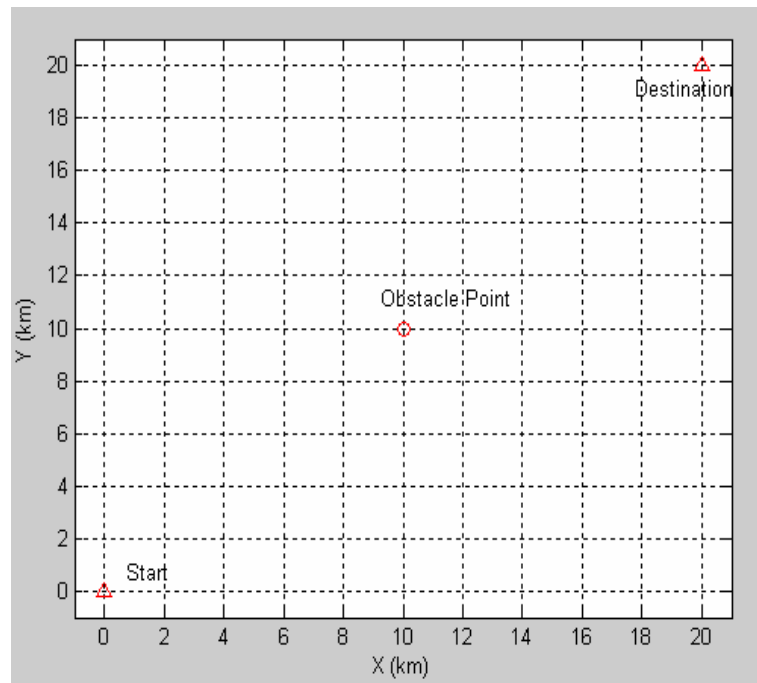

Figure 5- 17: Local minimal problem

Figure 5-18 shows how the difficulty of local minima is overcome by giving a small initial deviation. The parameters of simulation used are as follows: the attractive potential parameters $m=2$ and $\alpha=20$, the repulsive potential parameters $n=2$, $\eta=30$ and $p_o=3$ (km), and the initial heading deviation is 5 degrees.

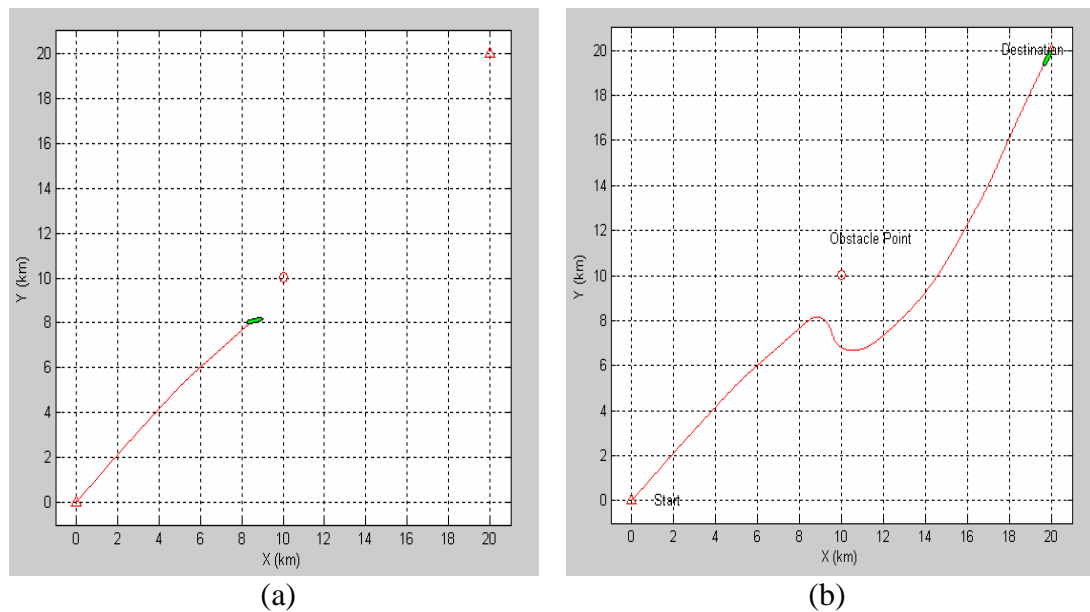

Figure 5- 18: (a) Giving a small initial heading deviation; and (b) the ship safely negotiates the obstacle and proceeds to the destination

(b) No Passage between Closely Spaced Obstacles

Koren and Borenstein [Koren & Borenstein, 1991] demonstrated that there is a possibility that the robot cannot pass through two closely spaced obstacles as a result from the repulsive forces created by the two obstacles if the attractive force is not large enough to overcome this repulsive force. This situation can arise, for example, when the robot needs to pass through a door, and the target's location does not allow it to generate sufficient attractive force.

A similar problem can occur in ship navigation when the passage is through a narrow channel between two major obstacles. To complicate matters, a similar feature of obstacle points representing impassable boundary should indeed be treated as such.

The two situations shown in Figure 5-19 (a) appear to be similar, but what they represent are the opposite in that the gap in Situation 1 must not be crossed, while the ship must be forced through the gap in Situation 2. The discernment

of the two kinds of gaps can be achieved by using ordinals, for example, as shown in Figure 5-19 (b). Here the parameter P_o was set as 3 km. It is reasonably clear that the gap between two points of neighbouring ordinals is a boundary and must not be crossed. If this stratagem is to be used, the two points at opposite sides of a channel must not be given neighbouring ordinals.

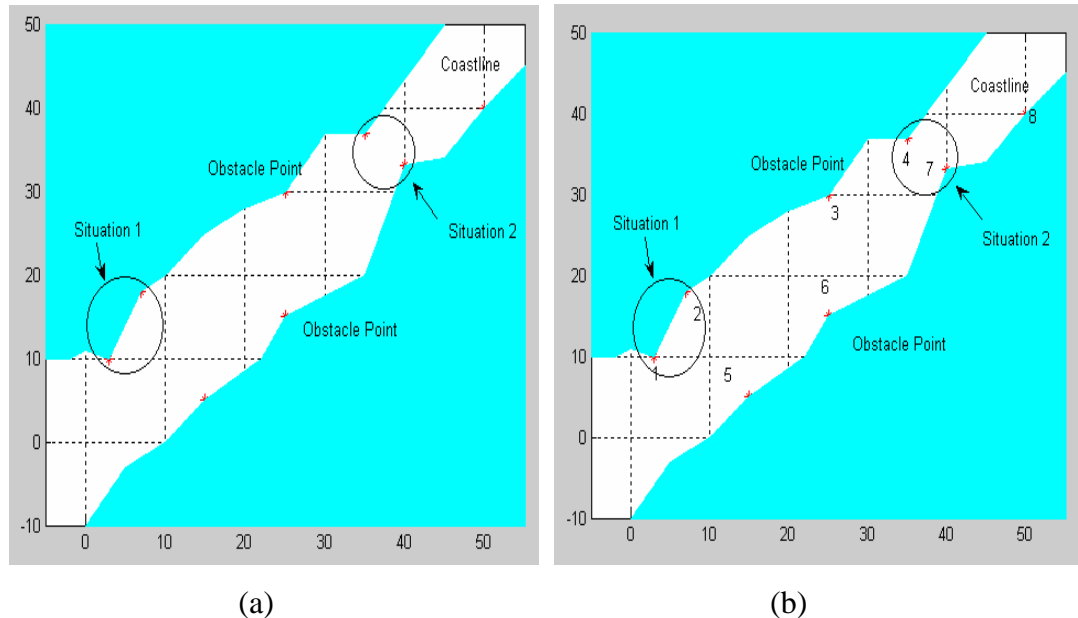

Figure 5- 19: (a) Two situations of closely positioned obstacles; (b) using the ordinal notations

(c) Oscillations in the Presence of Obstacles

One of the most significant limitations of potential field methods is their tendency to cause unstable motion in the presence of obstacles. Abrupt change of obstacle shapes also can result abrupt change of the repulsive forces and this may lead to oscillatory response [Koren & Borenstein, 1991].

(d) Oscillations in Narrow Passages

When a robot travels in a narrow corridor, the net repulsive force acting on the robot in the transverse direction of travel may change its sign around zero. This

switching consequently produces an oscillatory robot motion. A similar situation exists when a ship is forced to travel along a long, narrow, and often twisty channel. It has been found that most of this type of difficulties can be overcome through changing the obstacle position, changing the strength of repulsive force or adding extra obstacle points along the channel.

The situations that were mentioned in the last three limitations above are common in robotics. Similar situations do exist in ship navigation. For example, consider the case shown in Figure 5-20. The ship's start position is at $(0,0)$ (km), the destination is at $(50,45)$ (km) and the speed is 6.2 m/s. The value of P_o is 3 km.

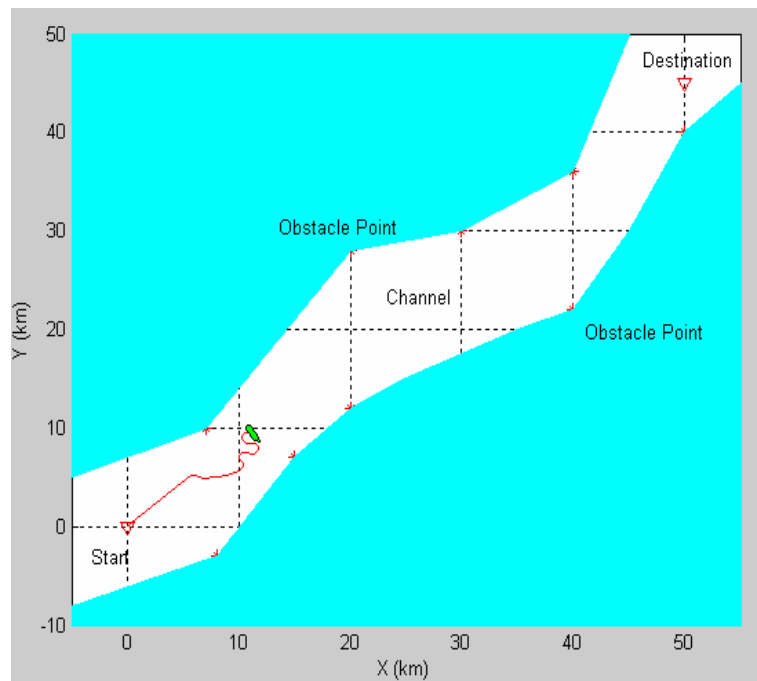

Figure 5- 20: Ship oscillates and cannot pass

In this particular case, it was found that the ship got stuck after a few oscillations. This difficulty was overcome through the following two methods:

- (a) The obstacle positions were changed in the simulation as shown in Figure 5-21. In this case, P_o is maintained at 3 km but one obstacle point is removed. This appears to solve this particular problem.

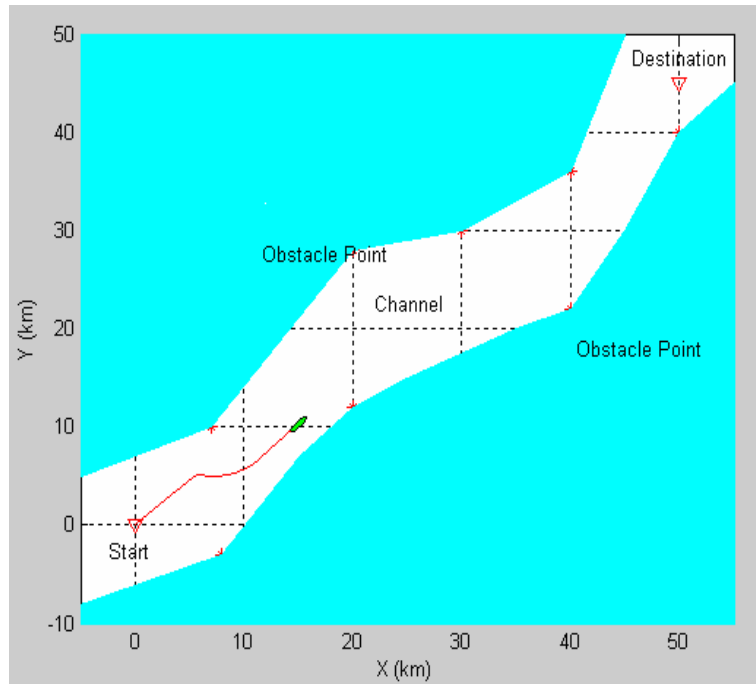

Figure 5- 21: Ship passes narrow passage

(b) In Figure 5-22, the method of changing the strength of repulsive force is used and this resolves the problem as well.

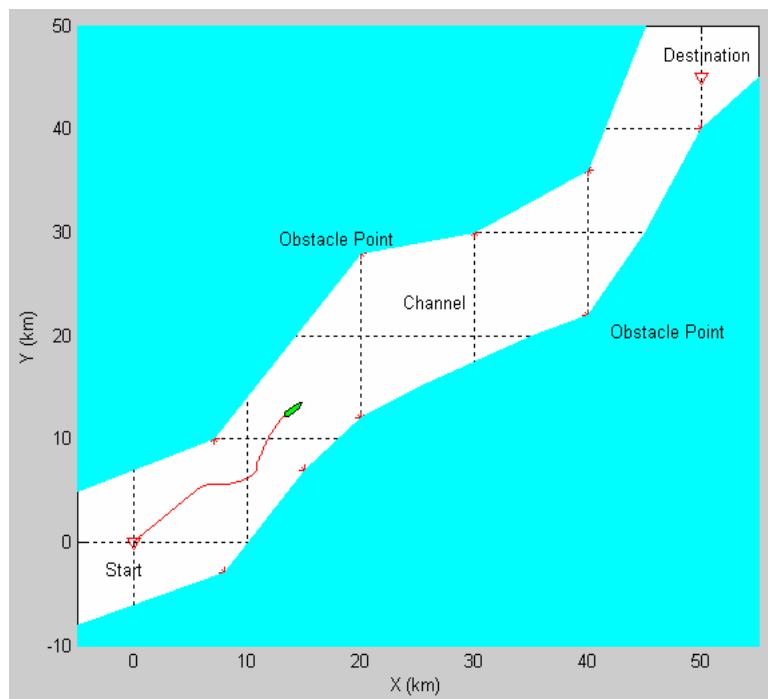

Figure 5- 22: Ship is successful to pass narrow passage

Although these limitations do exist in ship navigation, they are uncommon because the environment of waterways along which a ship sails is well-defined. If, for any reason, these situations do occur, there are a few adjustments that can be made to make it work.

For verifying the effectiveness of potential field method in ship's route finding, simulation studies on a number of scenarios are carried out in Chapter 8.

Chapter 6:

Automatic Collision Avoidance

6.1 Introduction

The main function of the automatic ship navigation system, such as that required for automatic navigation simulation, is to steer a ship without, or with very little, human intervention safely and efficiently. Such a system, therefore, must be able to detect any potential hazards and deal with them automatically in a safe and effective manner. The same applies if the system is an advisory tool for the ship's master or a part of the automatic simulation system. Avoidance of stationary obstacles has been dealt with in Chapter 5. In this chapter the focus will be on avoiding collision with moving obstacles, such as other traffic on the seaway.

Since 1980s, intensive research work on automatic collision avoidance has been carried out along with the development of computer science as mentioned in Chapter 3. However, these systems either do not take the international regulations for preventing collision into consideration or are incapable of dealing with the complex encounter situations at sea. Sometimes the route recommended by these systems was against the general practice of seamanship or the regulations of collision avoidance. Furthermore, many methods of collision avoidance are associated with optimisation algorithms. They can identify an optimum or near optimum route between the specified waypoints. However, in some situations, such as busy channels and harbours, the number of moving obstacles in addition to static obstacles might be quite significant, substantially increasing the risk of collision. In such cases it may not be possible to designate waypoints in advance, or adhere to them rigidly when they are designated. Therefore, the objective of this study is not to solve an optimisation problem for a pre-defined set of waypoints, but to achieve collision

avoidance in real time whilst en-route to the destination. This, after all, is how the ship masters operate.

In this study, all the ships within the scope of simulation will be steaming to their own destination points, whilst making sure that they do not collide with any obstacles. For ships at sea, navigational rules, such as collision regulations (COLREGS) will also have to be obeyed.

This chapter presents a method of avoiding obstacles, either moving or static. The parameters for defining possible collision situation are defined. The basic ship passing situations as recommended by COLREGS are presented. The strategy of collision avoidance is described.

6.2 International Regulations for Prevention of Collisions at Sea

To maintain a high level of safety at sea, the Convention on the International Regulations for Preventing Collisions at Sea (COLREGS) was issued in 1972. The COLREGS defines the rules for navigation and collision avoidance. These rules can be used for guiding human behaviour and, therefore, they are essential for collision avoidance and referenced throughout this thesis.

There are nearly 40 rules that comprise the COLREGS, most of which concern lighting, warning signals, application of rules, and definitions amongst others, and are of no concern to the designer of automatic ship navigation system. Some specific rules that are relevant for the current purpose and thus require our attention are as follows:

- Rules 7 and 8 (identification of a possible collision and the action to take);
- Rule 13 (overtaking);

- Rule 14 (head-on situation);
- Rule 15 (crossing situation);
- Rules 16-18 (hierarchy of the right-of-way).

These rules will be discussed in the following sections. Further details concerning these rules and others can be found in [Crockcroft & Lameijer, 1996].

6.3 Determination of Possible Collision

According to COLREGS, the navigator has to decide if a risk of collision exists and, if so, what manoeuvre to take to avoid collision. An automatic collision avoidance system has to do this automatically. Since there are no clear criteria for determining when the risk of collision is high enough to cause concern, a collision detection algorithm has to be formalised. The COLREGS have the following to say about determining if a risk of collision exists:

Rule 7: Risk of collision

“(a) Every vessel shall use all available means appropriate to the prevailing circumstances and conditions to determine if risk of collision exists. If there is any doubt such risk shall be deemed to exist.”

This rule does not give specifications with respect to the existence of collision risk. Therefore, it is not suitable for inclusion directly in an automatic navigation system. To translate this into a more specific definition, some criteria for detecting possible collision have been devised by many researchers.

6.3.1 Some Criteria Used in Detecting Possible Collision

(1) Closest Point of Approach (CPA) Criterion

This criterion is widely used for detecting possible collision in ARPA. The navigator determines the minimum safe distance at which other objects should be passed (CPA_L). If the closest point of approach (CPA) is expected to be less than the minimum safe distance, i.e.

$$CPA \leq CPA_L \quad (6.1)$$

a collision avoidance manoeuvre has to be made for the ship to clear the object in question at a safe distance. Time to closest point of approach (TCPA) is an additional criterion. Its minimum required value $TCPA_L$ is also defined by the navigator. If the condition (6.2) is satisfied

$$TCPA \leq TCPA_L \quad (6.2)$$

a collision avoidance manoeuvre has to be carried out immediately. Sometimes these two criteria are taken into account simultaneously.

(2) Ship Domain Criterion

A navigator tends to maintain a certain area around the ship clear of other navigational objects. One of the frequently quoted definitions of ship domain is that formulated by Goodwin [Goodwin, 1975]: “*the surrounding effective waters which the navigator of a ship wants to keep clear of other ships or fixed objects*”. The domains can be two- or three-dimensional, but two-dimensional domain is sufficient for ship navigation. The shape of two-dimensional domains can be circular, rectangular, elliptical, polygon, or more complex figures. The domain shape and size depend on a number of factors, such as size and type of ship,

movement parameters and encounter type, which makes the determination of the domain difficult.

(3) Ship Fuzzy Domain Criterion

Zhao [Zhao et al., 1993] improved the ship domain criterion. He made a hypothesis that there was a “fuzzy boundary” of a ship domain. This fuzzy boundary defines an area around the ship which should be maintained free from other craft and objects by the navigator as shown in Figure 6-1. Its shape and size depend on the preset level of navigational safety, understood as the degree of membership of a navigational situation to the fuzzy set “safe navigation” (“dangerous navigation”). In Figure 6-1, r indicates the navigation safety level ($0 \leq r \leq 1$): $r=0$ represents very safe situation and $r=1$ means very dangerous situation.

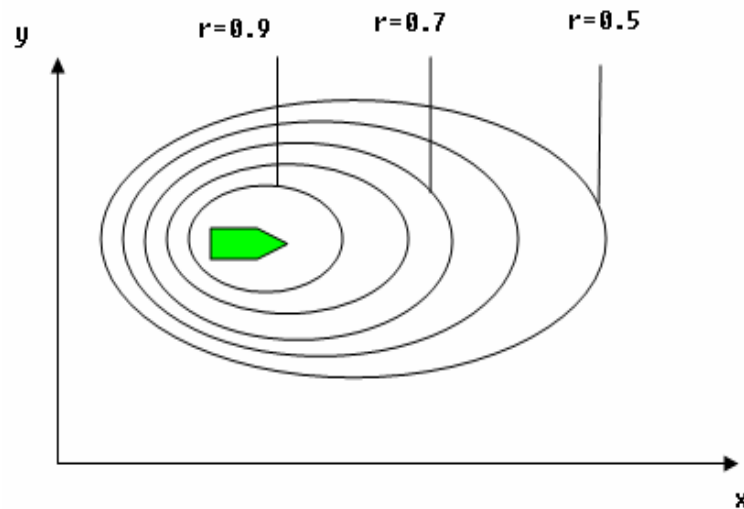

Figure 6- 1: Ship fuzzy domain

The above three criteria are now widely used in different navigation systems. Depending on the situation, the navigator can use different criteria to detect possible collision.

6.3.2 Parameters Used in Determination of Possible Collision

A simple method is introduced for determining possible collision inspired by the basic concept of ship fuzzy domain. Some parameters in this method are defined as follows.

(1) Safe Passing Distance

Safe passing distance C_S is used to define navigational boundaries. It is the smallest possible distance between two passing vessels (measured between the centre points amidships) which must be maintained for safe passage, defined here as

$$C_S = L_{OW} + L_{TA} \quad (6.3)$$

where L_{OW} and L_{TA} are the length of own ship and strange ship respectively. The minimum passing distance requirement can also be interpreted as the centre point of the own ship not crossing the circle of radius of $(L_{OW} + L_{TA})$ with the centre at the centre point of the strange ship.

(2) Collision Avoidance Distance

From the theoretical point of view, the safe passing distance is sufficient for safety. However, in real navigation, a common practice is to allow for uncertainties and add a certain safety factor. Zhao [Zhao et al., 1993] discussed the factors to consider when determining ship domain shape and size. These factors include:

- Human factor (knowledge, skills, nationality, mental and physical qualities)
- Type of the area: open or restricted
- Size and type of own ship
- Movement parameters: relative speed of other ships, traffic intensity

- Hydro-meteorological conditions
- Encounter-type
- Size of the other ships

Taking some of the above factors into consideration, collision avoidance distance (C_A) can be written:

$$C_A = f \times C_S + C_E + V_r \times T \quad (6.4)$$

where C_S is the safe passing distance and C_E is the position evaluation error. Different values for f may be adopted depending on the situation and visibility as given in Table 6-1 [Hilgert & Baldauf, 1997]. V_r is the relative speed, T is the time that operator takes to make a decision. In real operational situations, the operators need to take some time to make their decision on what action to take. Usually this decision time is taken to be 3 to 6 minutes. When determining the collision avoidance distance C_A , this factor therefore needs to be taken into account.

In the current work, the collision avoidance distance C_A is determined in real time according to the length of the ship encountered, relative speed and environment.

Table 6- 1: The values of f

Kind of encounter situation	f (good visibility)	f (restricted visibility)
Head-on meeting port/port-side overtaking	2.5	5
Head-on meeting starboard/starboard-side crossing situation	5	10

(3) Range of Checking Collision

According to COLREGS 17, there are four stages for ships in threat of collision [Hilgert & Baldauf, 1997] as follows:

- At long range, if there is no risk of collision, both vessels are free to take any preventive action.
- When risk of collision first begins to be apparent, the give-way vessel is required to take early and substantial action to achieve a collision avoidance distance and the other vessel must maintain course and speed.
- When it becomes apparent that the give-way vessel is not taking appropriate action in compliance with the rules, the stand-on vessel is permitted to take action to avoid collision by its manoeuvre alone.
- When the give-way vessel alone cannot avoid collision, the stand-on vessel is required to act as best it can to avoid collision.

As mentioned before, in some situations, a number of ships may be in the vicinity of the vessel. However, not all of them may be in a situation with potential collision with the vessel. Therefore, it is necessary to determine under what circumstances the risk of collision needs to be evaluated. It is reasonable to assume that the most crucial factor determining this will be the distance between the two ships. In this study, the distance at which collision risk begins to be assessed is termed collision checking range C_R . The magnitude of C_R depends on weather condition, sailing area, and the speed of the own ship.

6.4 Determination of Encounter Type

If the strange ship is within the collision checking range, a potential encounter situation comes into being. Three different encounter situations of ships, namely, overtaking, head-on, and crossing are classified in COLREGS and the rule of “action to avoid collision” for each situation is stipulated.

6.4.1 Overtaking Situation

Rule 13 states the conditions for the overtaking situation,

“ (b) A vessel shall be deemed to be overtaking when coming up with another vessel from a direction more than 22.5 degrees abaft her beam, that is, in such a position with reference to the vessel she is overtaking, that at night she would be able to see only the stern light of that vessel but neither of her sidelights.”

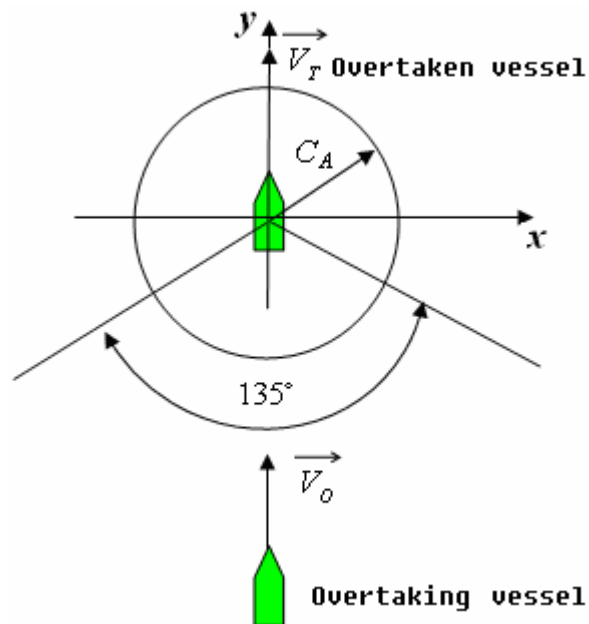

Figure 6- 2: Overtaking situation

A pictorial interpretation of the rule is shown in Figure 6-2. The rule is written in such a way as to be interpreted by a human operator. This poses some issues when

trying to incorporate the rule into an automatic navigation system that typically requires more precise definitions.

It was decided to use the rules shown in equation (6.5) and (6.6). The relationship of these parameters used in this equation can be seen in Figure 6-3.

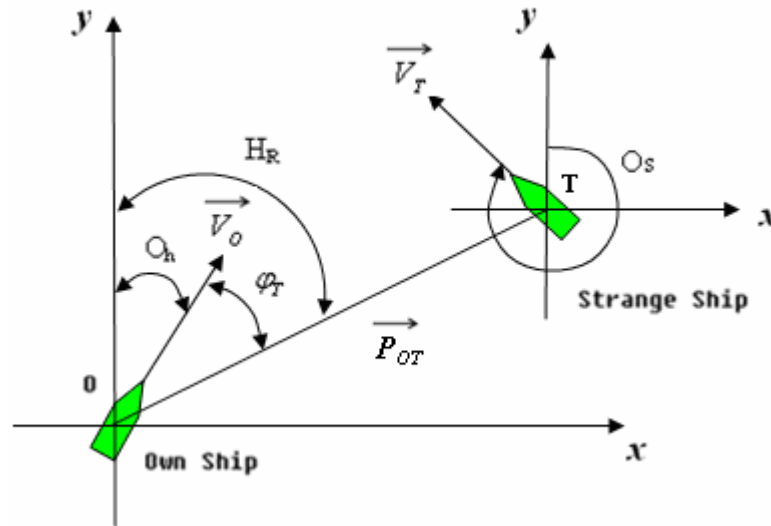

Figure 6- 3: The relationship of the parameters

Strange ship overtaking, if

$$112.5^\circ < \varphi_T < 247.5^\circ, \quad |\vec{P}_{OT}| < C_R, \quad V_O < V_T \quad \text{and} \quad |\Delta O_T| \leq 67.5^\circ \quad (6.5)$$

$$\text{or } 112.5^\circ < \varphi_T < 247.5^\circ, \quad |\vec{P}_{OT}| < C_R, \quad V_O < V_T \quad \text{and} \quad 292.5^\circ \leq |\Delta O_T| \leq 360^\circ \quad (6.6)$$

where V_O and V_T are the speeds of own ship and the strange ship respectively. The magnitude of vector \vec{P}_{OT} is the distance between own ship and the strange ship at time t and C_R is collision checking range. $\Delta O_T = O_h - O_s$, O_h is the course angle of own ship and O_s is the course angle of the strange ship.

φ_T is the relative bearing of the own ship relative to the strange ship which can be obtained by

$$\varphi_T = \begin{cases} H_R - O_h & H_R - O_h > 0 \\ H_R - O_h + 360^\circ & H_R - O_h < 0 \end{cases} \quad (6.7)$$

where H_R is the true bearing of the strange ship relative to own ship. It can be calculated by the following equations [Xu, 2005]:

$$H_R = \arctan \frac{x_T - x_o}{y_T - y_o} + \lambda \quad (6.8)$$

$$\lambda = \begin{cases} 0^\circ & \text{if: } (x_T - x_o) \geq 0, (y_T - y_o) \geq 0 \\ 180^\circ & \text{if: } (x_T - x_o) < 0, (y_T - y_o) < 0 \\ 180^\circ & \text{if: } (x_T - x_o) \geq 0, (y_T - y_o) < 0 \\ 360^\circ & \text{if: } (x_T - x_o) < 0, (y_T - y_o) \geq 0 \end{cases} \quad (6.9)$$

where (x_o, y_o) is the position of the own ship and (x_T, y_T) is the position of the strange ship.

For the situation of strange ship being overtaken, the criterion is

$$112.5^\circ < \varphi_S < 247.5^\circ, \quad |\vec{P}_{OT}| < C_R, \quad V_O > V_T \quad \text{and} \quad |\Delta O_T| \leq 67.5^\circ \quad (6.10)$$

$$\text{or } 112.5^\circ < \varphi_S < 247.5^\circ, \quad |\vec{P}_{OT}| < C_R, \quad V_O > V_T \quad \text{and} \quad 292.5^\circ \leq |\Delta O_T| \leq 360^\circ \quad (6.11)$$

where φ_S is the relative bearing of the strange ship relative to own ship, the calculation method is the same as φ_T .

6.4.2 Head-on Situation

The rule regarding two vessels approaching head-on is Rule 14:

“(a) When two power-driven vessels are meeting on reciprocal or nearly reciprocal courses so as to involve risk of collision, each shall alter her course to starboard so that each shall pass on the port side of the other.

(b) Such a situation shall be deemed to exist when a vessel sees the other ahead or nearly ahead and by night she could see the masthead lights of the other in a line or nearly in a line and/or both sidelights and by day she observes the corresponding aspect of the other vessel.

(c) When a vessel is in any doubt as to whether such a situation exists she shall assume that it does exist and act accordingly.”

Figure 6-4 shows the head-on situation.

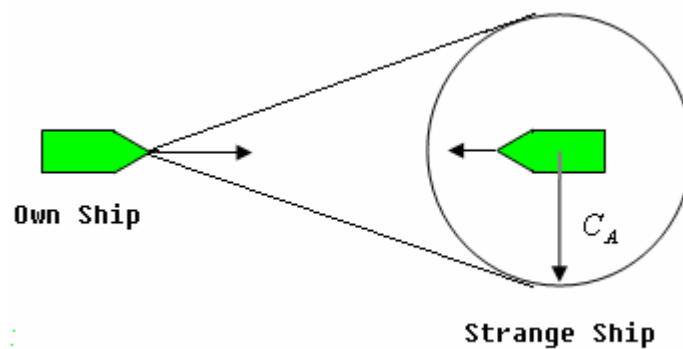

Figure 6- 4: Head-on situation

This rule, as with rule 13, allows considerable room for interpretation by the vessel operator. The rule has been interpreted as the relation shown in equation (6.12) and (6.13).

We are in a head-on situation, if

$$000^\circ \leq \varphi_T \leq 005^\circ, \quad 175^\circ \leq |\Delta O_T| \leq 185^\circ \quad \text{and} \quad |\vec{P}_{OT}| < C_R \quad (6.12)$$

$$\text{or} \quad 355^\circ \leq \varphi_T \leq 360^\circ, \quad 175^\circ \leq |\Delta O_T| \leq 185^\circ \quad \text{and} \quad |\vec{P}_{OT}| < C_R \quad (6.13)$$

6.4.3 Crossing Situation

Rule 15 pertains to a crossing situation. It states,

“When two power-driven vessels are crossing so as to involve risk of collision, the vessel which has the other on her own starboard side shall keep out of the way and shall, if the circumstances of the case admit, avoid crossing ahead of the other vessel.”

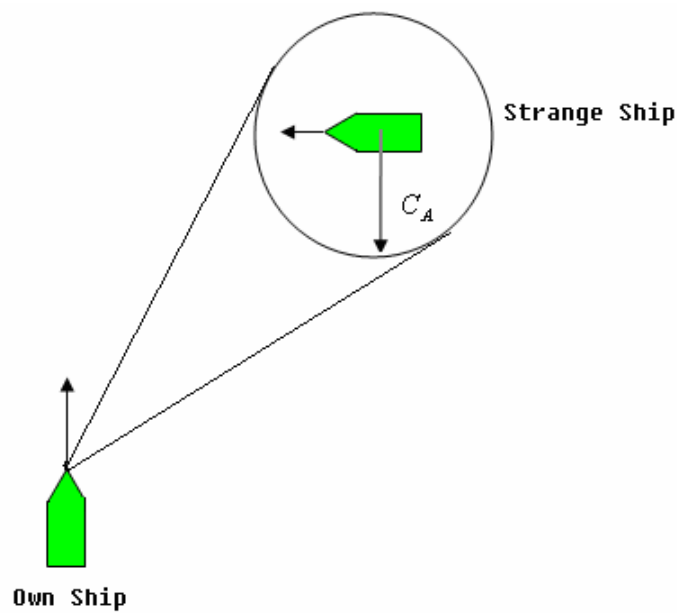

Figure 6- 5: Crossing situation

The pictorial interpretation of the rule is shown in Figure 6-5. The interpretation is given in equation (6.14) and (6.15), where the definition of φ_T is the same as in the above two scenarios.

Strange ship crossing starboard-to-port, if $005^\circ < \varphi_T \leq 112.5^\circ$ and $|\vec{P}_{OT}| < C_R$ (6.14)

Strange ship crossing port-to-starboard, if $247.5^\circ \leq \varphi_T < 355^\circ$ and $|\vec{P}_{OT}| < C_R$ (6.15)

Finally, Figure 6-6 shows the classification of encounter types.

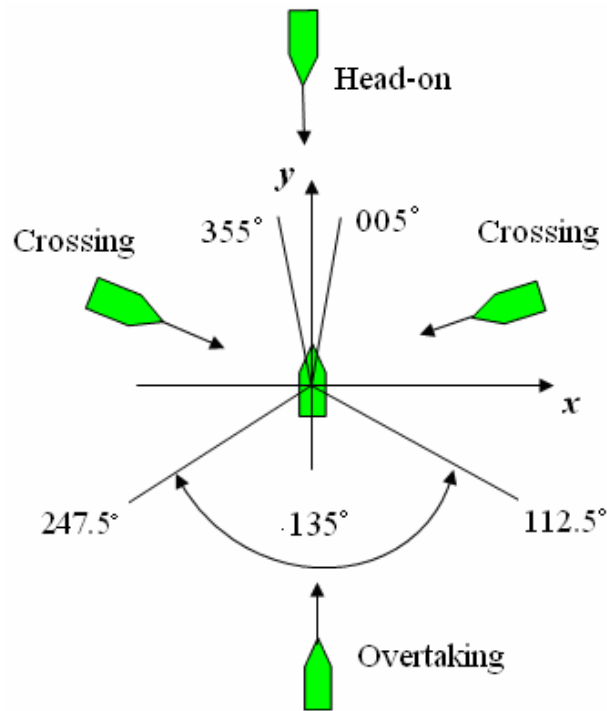

Figure 6- 6: The classification of encounter types

6.5 Strategy of Collision Avoidance

As described previously in Chapter 5, the potential field method has been found very effective in avoiding stationary obstacles. However, the situation becomes a little more complex when the obstacle is moving, as for example, when two ships are sailing towards the same point at the same time.

When two ships experience an ‘encounter situation’ other than head-on, COLREGS states that one ship should maintain course and speed (stand-on vessel), while the other is responsible for the avoidance manoeuvre (give-way vessel) (COLREGS 16 and 17) as shown in Figure 6-7.

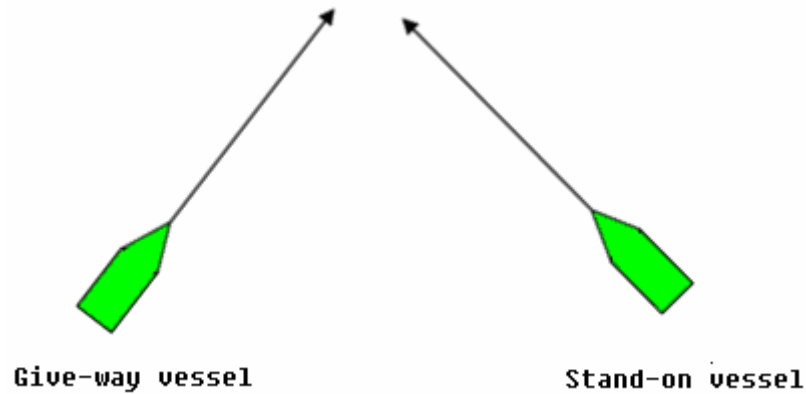

Figure 6- 7: The give-way vessel yields to the stand-on vessel

The reasoning behind assigning one vessel to stand-on while the other as the give-way vessel is to minimise the possibility of uncoordinated ship manoeuvres. The avoiding manoeuvres to be taken, therefore, should be in accordance with the regulations which all maritime traffic are required to adhere to.

6.5.1 Action to Avoid Collision

Having determined the encounter type, the action to avoid collision is addressed by Rule 8:

- “(b) Any alteration of course and/or speed to avoid collision shall, if the circumstances of the case admit, be large enough to be readily apparent to another vessel observing visually or by radar; a succession of small alterations of course and/or speed should be avoided.*

- “(c) If there is sufficient sea room, alteration of course alone may be the most effective action to avoid a close-quarters situation provided that is made in good time, is substantial and does not result in another close-quarters situation*

(d) Action taken to avoid collision with another vessel shall be such as to result in passing at a safe distance. The effectiveness of the action shall be carefully checked until the other vessel is finally past and clear.

(e) If necessary to avoid collision or allow more time to assess the situation, a vessel shall slacken her speed or take all way off by stopping or reversing her means of propulsion. ”

As is common in almost all rules, this rule reveals a measure of the flexibility common in the rules, suitable for humans, but tricky for automatic navigation system, such as “large enough to be readily apparent”, and “small alterations of course”. Generally the flexibility is found in both the condition of the rules and the application of the rules. Exploiting the latter is of paramount importance, since the rules at times need to co-exist with other rules as well as the efforts of the ship to complete its task. Therefore, when we have to use this rule in automatic ship navigation system, the features of action to avoid collision must be considered. There are three features as follows [Zhao et al., 1995]:

1. According to the risk of collision, collision avoidance action varies continuously as time passes;
2. Generally speaking, collision avoidance action is not fixed precisely. For example, if an action is taken such as altering course 20 degrees to starboard at a distance of 4 Nm between here and the target, this does not mean that it is better than one which has an alteration of course of 19 degrees to starboard at 4.1 Nm;
3. Collision avoidance action is related to the mariner's psychology, knowledge, skill and experience.

These features can influence the decision of collision avoidance. They are very important for automatic navigation system when the system has to choose a proper

action to avoid collision by itself.

6.5.2 Two-Ship Encounter

The challenges of achieving automatic collision avoidance lie in, firstly, detecting potentially dangerous situations and, secondly, in preventing them from developing into actual collision. The basic idea, therefore, of collision avoidance in the case of two ships encountering is presented below:

Consider the situation of manoeuvring the own ship toward a waypoint when a strange ship is encountered and it is judged that there is a potential collision risk. The starting point of the strategy is to assess the risk of collision and to determine whether a collision avoidance manoeuvre is required. If it is, the action will be calculated using a certain navigation command law in order to alleviate and minimise the risk.

The pictorial interpretation of this strategy is given in Figure 6-8 which shows the relationship between vectors used in the strategy.

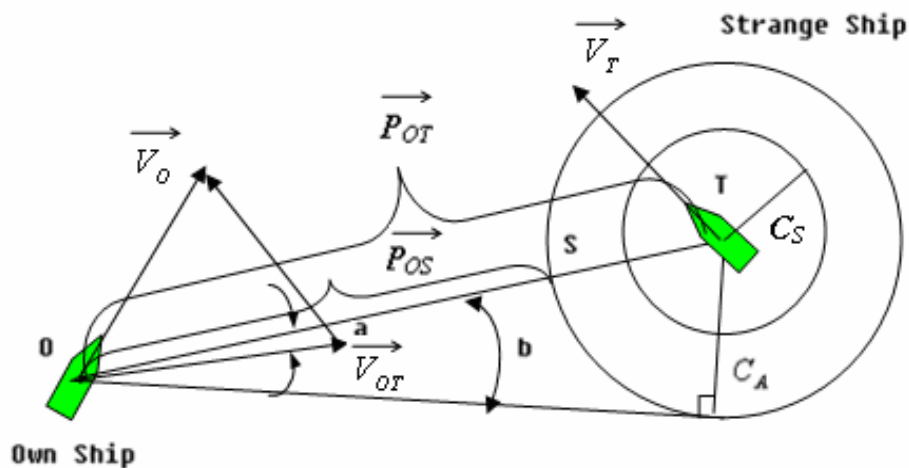

Figure 6- 8: The basic strategy of avoiding collision in the case of two ships encountering

In Figure 6-8, the radius of the inner circle around the strange ship is the safe passing distance C_S and the radius of the outer circle is the collision avoidance distance C_A . The magnitude of vector \vec{P}_{OT} is the distance between own ship and the strange ship at time t . \vec{P}_{OT} can be written as:

$$\vec{P}_{OT} = \vec{P}_T - \vec{P}_O \quad (6.16)$$

where \vec{P}_T and \vec{P}_O are positions of the strange ship and own ship respectively.

S is the point of intersection of \vec{P}_{OT} and a circle of radius C_A with the centre at the midship of the strange ship. \vec{P}_{OS} can be written as:

$$\vec{P}_{OS} = \vec{P}_{OT} - C_A \quad (6.17)$$

\vec{V}_{OT} is the relative velocity of the own ship with respect to that of the strange ship. It can be written as:

$$\vec{V}_{OT} = \vec{V}_O - \vec{V}_T \quad (6.18)$$

where \vec{V}_O and \vec{V}_T denote the velocity of own ship and strange ship at time t , respectively.

A straight line is drawn from the position of own ship to be tangential to the outer circle around the strange ship and b is defined as the angle between the tangential line and the relative position \vec{P}_{OT} . a is the angle between the relative position \vec{P}_{OT} and the relative speed \vec{V}_{OT} as shown in Figure 6-8.

If the relative distance between own ship and the strange ship $|\vec{P}_{OT}|$ is less than the range of collision checking C_R , then own ship starts checking if the collision risk exists.

It can easily be seen that the risk of collision exists, if the extension of the relative

velocity \vec{V}_{OT} of the two ships crosses a circle of radius C_A around the strange ship. This condition can be formalised as $a < b$. Thus the two necessary conditions for potential collision risk in two-ship encounter situation are:

- (a) the distance between the two ships is less than the range of checking collision, i.e. $|\vec{P}_{OT}| < C_R$;
- (b) the extension of the relative velocity \vec{V}_{OT} of the two ships crosses a circle of radius C_A around the strange ship, i.e. $a < b$.

The strategy for collision detection, therefore, is reduced to checking these two factors at each time step.

If $a < b$, the situation can be rectified by changing the velocity of either or both ships. For practical operations, this means changing the speed and/or heading of either or both ships. It has been known that ship masters do not like changing speed as the primary means of navigation unless it is unavoidable because it is not very effective for collision avoidance since a moving power-driven ship has an inertial momentum. For emergencies where collision cannot be avoided by changing heading alone, the method of reducing speed can be considered. However, such emergencies only occur when appropriate preventive action is not taken well in advance. Consequently, heading changes only are used as the means of avoiding collision in this work.

Assuming that both ships are moving with a constant velocity, and both ships' positions and velocities are precisely known at each time instant t , the strategy for avoiding collision in the case of two ships encountering can be simply summarized as follows:

- (i) At each time instant t , the collision risk detecting is carried out using two conditions for two-ship encounter situation. If a risk exists,
- (ii) change own ship or strange ship's heading angle (depending on encounter

situations according to relevant regulations) to make the angle a larger than the angle b to avoid collision.

- (iii) If no collision risk is reported (i.e. necessary condition for collision is not satisfied), no manoeuvre applies to either ship.

6.5.3 Multiple-Ship Encounter

When there are more than two ships involved in encounters in relative proximity, the situation can become much more complicated as shown in Figure 6-9. However, even in this situation the procedures used for two-ship encounter can be applied, if, while one ship manoeuvres to avoid collision with another ship, no other ships are within the range of collision checking with $a < b$.

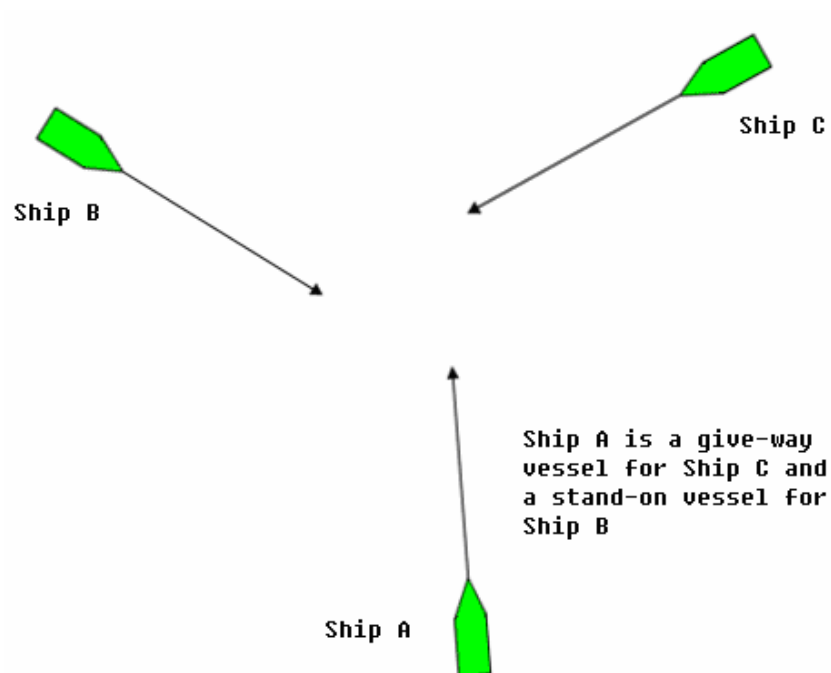

Figure 6- 9: Multiple ships encounter situation

A true multiple-ship encounter situation arises when a ship has to deal with two or more ships all at the same time. The main problem in this scenario is that there will

be a vast number of likely situations. It is suggested that the best way of overcoming this difficulty is to analyse the situation and treat it as a series of ‘urgent’ two-ship encounter problems. In order to do this we need to assign priority to each two-ship problem with the intention of dealing with the situation with the highest priority. The situation is re-evaluated at every time step, and thus the system does not need to deal with the situation of lower priority. Of course, one situation with a lower priority can turn into the top priority as the situation develops.

Meanwhile, it is worth reminding that this automatic simulation program will find safe route not only for the ‘own’ ship but for all the ships concerned. In other words, the program has to consider each moving ship in turn as the ‘own’ ship.

In practice, a navigator tends to use the distance between two ships to judge the risk of collision. Consequently, $|\vec{p}_{os}|$ is used as the main criterion to determine the priority of a situation involving a pair of ships.

More specifically the following method is used to prioritise the situation:

- (1) The existence of a static obstacle

Ships which need to avoid static obstacles will be given the highest priority to manoeuvre, because their avoidance manoeuvre is necessary regardless of whether or not they face threats from other ships.

- (2) The distance $|\vec{p}_{os}|$

This distance is used to determine which pair of ships is in the most imminent danger. The pair of ships with the shortest distance $|\vec{p}_{os}|$ is given the next highest priority.

- (3) Encounter type

If the above two conditions are the same, then the encounter type of each pair of ships is taken into consideration. The highest priority is given to the

head-on situation; followed by the strange ship crossing from port to starboard; the strange ship overtaking; the strange ship crossing from starboard to port; and finally the strange ship being overtaken.

As mentioned above, course-changing was adopted as the primary means of avoiding collision in normal circumstances in this work. In accordance with practical operational experience reported in [Li & Wang, 1983], the turning angle that the ship is required to take to avoid collision is calculated for various ship speeds, encounter types and collision avoidance distance. The results are given in Table 6-2.

Table 6- 2: Turning angle for avoiding collision [Li & Wang, 1983]

Collision avoidance distance C_A	The magnitude of \bar{P}_{OT} when taking action	Encounter type	The speed ratio				
			2:1	1.5:1	1:1	1:1.5	1:2
1 Nm	3 Nm	Head-on	28°	32°	39°	49°	62°
		Crossing	28°	30°	39°	54°	68°
	2 Nm	Head-on	45°	50°	60°	78°	120°
		Crossing	40°	45°	60°	79°	98°
0.5 Nm	2 Nm	Head-on	22°	25°	29°	36°	45°
		Crossing	19°	22°	29°	39°	52°
	1 Nm	Head-on	45°	50°	60°	78°	120°
		Crossing	40°	45°	60°	79°	98°

In summary, the algorithm adopted for multiple-ship encounter situation can be described as follows:

- At each time step the system examines each ship in turn to see if it is within the collision checking range and with which ship(s).
- If the ship is within the checking range of one or more ships, then the collision risk detection procedure is carried out for each strange ship.
- If it is judged that the ship is in danger of collision with one ship only, then the procedure for two-ship encounter situation is applied.
- If it is judged that there is a risk of collision avoidance with two or more strange ships, the priority will be determined for each strange ship and the avoidance manoeuvre is carried out (based on the two-ship encounter procedure) for the ship with the highest priority.

This process is repeated throughout the entire simulation while the ship is in motion.

In order to verify the effectiveness of the algorithm described here some case studies are carried out as shown in Chapter 8.

Chapter 7:

Dynamic Route Generation and Heading Control

7.1 Introduction

The aim of this research is to develop an automatic ship navigation/manoeuvring simulation in relatively confined spaces in the presence of static and moving obstacles. Having decided on the methods of automated route finding and collision avoidance, they have to be translated into proper control algorithms so that the navigational requirements can be used to derive the ship control parameters. It is not difficult to see that these will be influenced by the ship's current position, heading and velocity and the required position, heading and velocity of the ship in the immediate future.

Before establishing how the control parameters can be derived, it will be worth examining how sailing routes are represented and generated.

7.2 Route Generation

7.2.1 Way-Point Representation

In general, particularly in voyage planning (*macro* planning), the operator decides on a desired route the vessel must follow from its starting point to the final destination. This route is usually specified in terms of way-points [Fossen, 2002]. Each way-point is defined using Cartesian coordinates (x_i, y_i, z_i) for $i = 1, \dots, n$. In other words, the route information is represented by a set of discrete points, and the

navigator will endeavour to make the ship pass through these points or as near as possible, if the situation does not change from when the waypoints were picked.

In time-domain simulation where the human navigator's thinking and actions have to be emulated, however, all way-points are stored in a way-point database and the actual (continuous as against discrete) route for the moving ship to follow can be generated by interpolation of some sort.

More formally, the way-point database therefore can be said to consist of:

$$wpt.pos = \{(x_0, y_0, z_0), (x_1, y_1, z_1), \dots, (x_n, y_n, z_n)\}$$

Since we are dealing with surface vessels, this is simplified to two-coordinate set (x_i, y_i) . Additionally, other way-point properties, such as speed, heading and so on, can be defined, i.e.:

$$wpt.speed = \{U_0, U_1, \dots, U_n\}$$

$$wpt.heading = \{\psi_0, \psi_1, \dots, \psi_n\}$$

For surface vessels this means that the vessel should pass through a way-point (x_i, y_i) at forward speed U_i with heading angle ψ_i . The way-point database can be generated based on a set of factors. These are usually based on [Fossen, 2002]:

- Mission: the vessel should move from some starting point (x_0, y_0) to the terminal point (x_n, y_n) via the way-points (x_i, y_i) .
- Environmental data: information about wind, waves, and currents can be used for energy optimal routing (or avoidance of bad weather for safety reasons).
- Geographical data: information about shallow waters, islands, navigable channels and so on should be included.
- Obstacles: floating structures and other static obstacles must be avoided.

- Collision avoidance: provisions against potential collision dangers for sailing along or crossing busy sea lanes.
- Feasibility: each way-point must be feasible, in that it must be possible to manoeuvre to the next way-point without exceeding maximum speed, turning rate, etc.

7.2.2 Route Generation using Straight Lines and Circular Arcs

In practice it is common to represent the desired route using straight lines and circular arcs to connect the way-points (or to interpolate between one waypoint and the next). This is shown in Figure 7-1. The radius related to each waypoint defines the circular arc that is the desired route for the vessel to follow during the turn related to that waypoint. It can be seen from Figure 7-1 how the radius at each waypoint defines a Wheel-Over-Point (WOP), as defined by [Holzhueter & Schultze, 1995]. The WOP is the point on each sub-route at which the route changes from a straight line to a circular arc. In other words it is the point on the track where the ship should start turning toward the next sub-route.

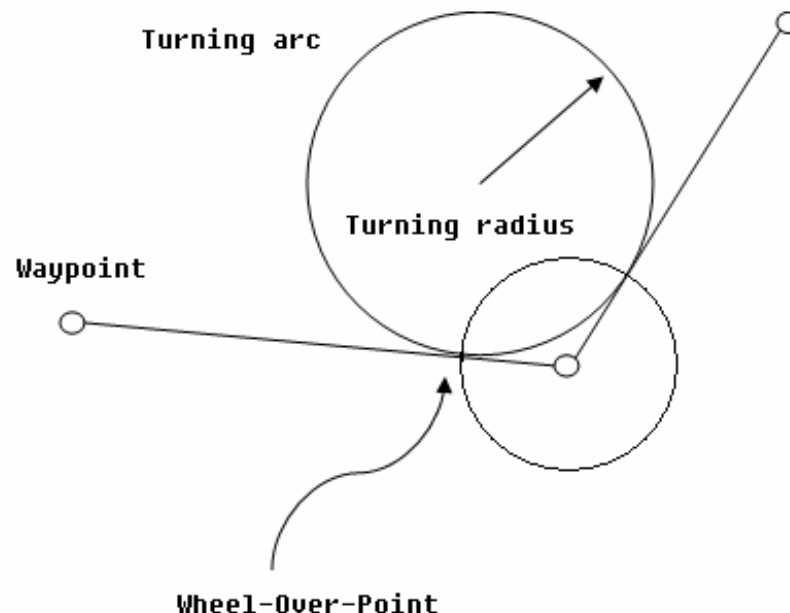

Figure 7- 1: Route composed of straight lines and circular arcs

The drawback of this strategy is that a jump in the desired yaw rate r_d is experienced. This is due to the fact that the desired yaw rate along the straight line is $r_d = 0$ while it is $r_d = \text{constant}$ on the arc during steady turning. Such discontinuities in the desired yaw rate require infinite forces in the actuators and usually result in transitional oscillation [Fossen, 2002], and thus should be avoided if at all possible.

7.2.3 Cubic Spline Algorithm for Route Generation

If a smooth reference trajectory is used, e.g. those defined by a mathematical spline which ensures continuity at the joints [Fossen, 2002], those drawbacks mentioned in above section can be overcome. One such mathematical spline well-known to naval architects is cubic spline, or mathematical spline of order 4 or degree 3. By definition, cubic spline ensures continuity of order 2 (second derivative) at the joints. This means continuity of yaw rate at the joints (or in our case waypoints).

This spline is analogous to a physical spline which is a strip of wood or other suitable homogenous material of uniform cross section. The curve thus generated is constrained to pass through all the points given, resulting in a pleasingly smooth curve.

Using cubic spline, every sub-route can be described by a unique cubic polynomial, expressed in a parameterised form [Fossen, 2002]:

$$x_i(\theta) = a_3\theta^3 + a_2\theta^2 + a_1\theta + a_0 \quad (7.1)$$

$$y_i(\theta) = b_3\theta^3 + b_2\theta^2 + b_1\theta + b_0 \quad (7.2)$$

where $(x_i(\theta), y_i(\theta))$ are the position of the vessel and θ is the parameter.

There are many textbooks (see e.g. Rogers, 1990) and papers describing the basic principles of cubic spline technique, and therefore the methods are not discussed any further here, except to note that the gradient of the curve at the waypoints are analogous to the heading the ship is required to take.

Figure 7-2 shows a route generated using cubic spline. It can be seen that the route generated is smooth and the yaw rate is continuous at the joints.

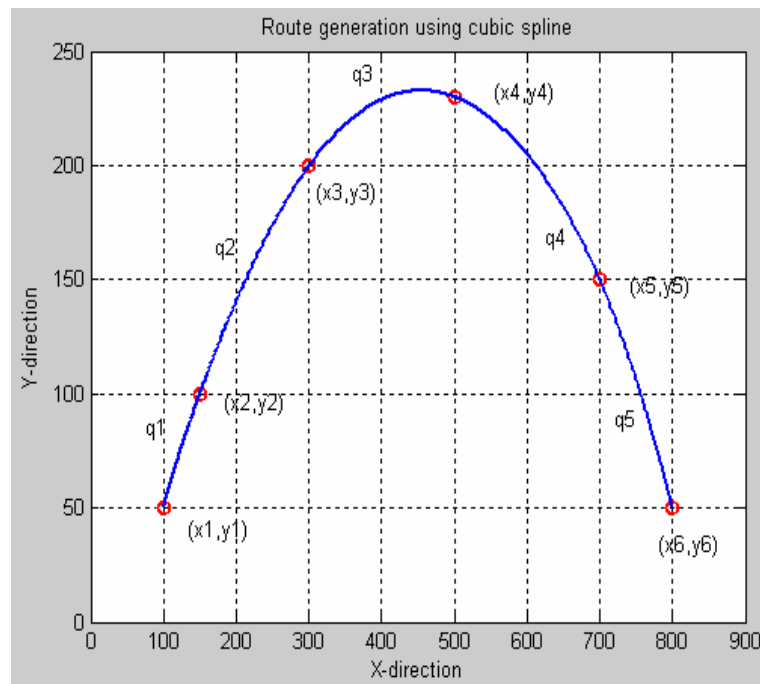

Figure 7- 2: Route generation using cubic spline

7.3 Dynamic Route Generation

In most of the previous studies, the ship's waypoints are pre-defined in advance and the route is fixed as shown in Figure 7-3.

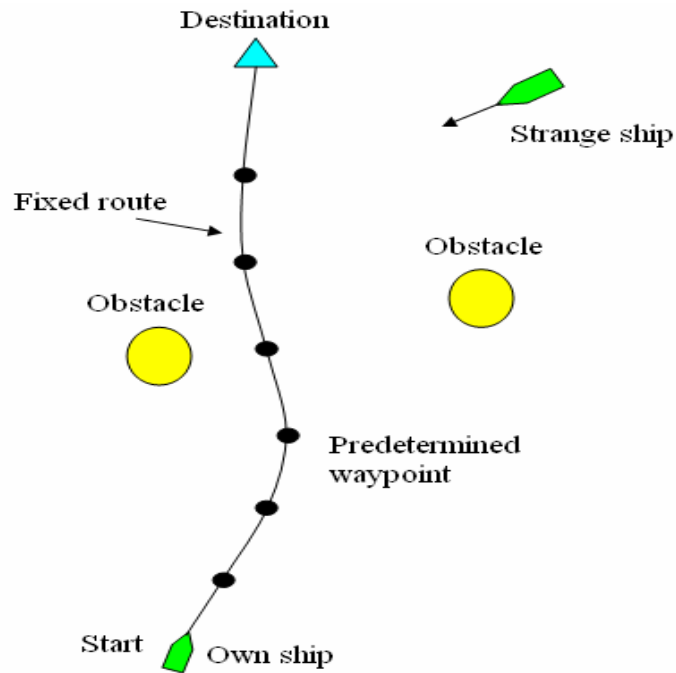

Figure 7- 3: Predetermined waypoints and fixed route method

But in real navigation the environment in which the ship sails changes continuously, and, therefore, to simulate ship navigation in real time, the ship states (including the route to follow) need to be updated at every time step in simulation. Consequently, having a set of waypoints is not very helpful, as they will be renewed at every time step any way. However, since what route the ship has to follow immediately hereafter needs to be decided. The simulation program developed in this study, therefore, only generates the part of the route closest to the current position. At the next time step this manoeuvring requirement may have to be altered due to changing circumstances and difficulty in implementing the manoeuvre. This procedure can thus be called 'dynamic route generation' or '*micro* planning'. Figure 7-4 shows how dynamic route is generated.

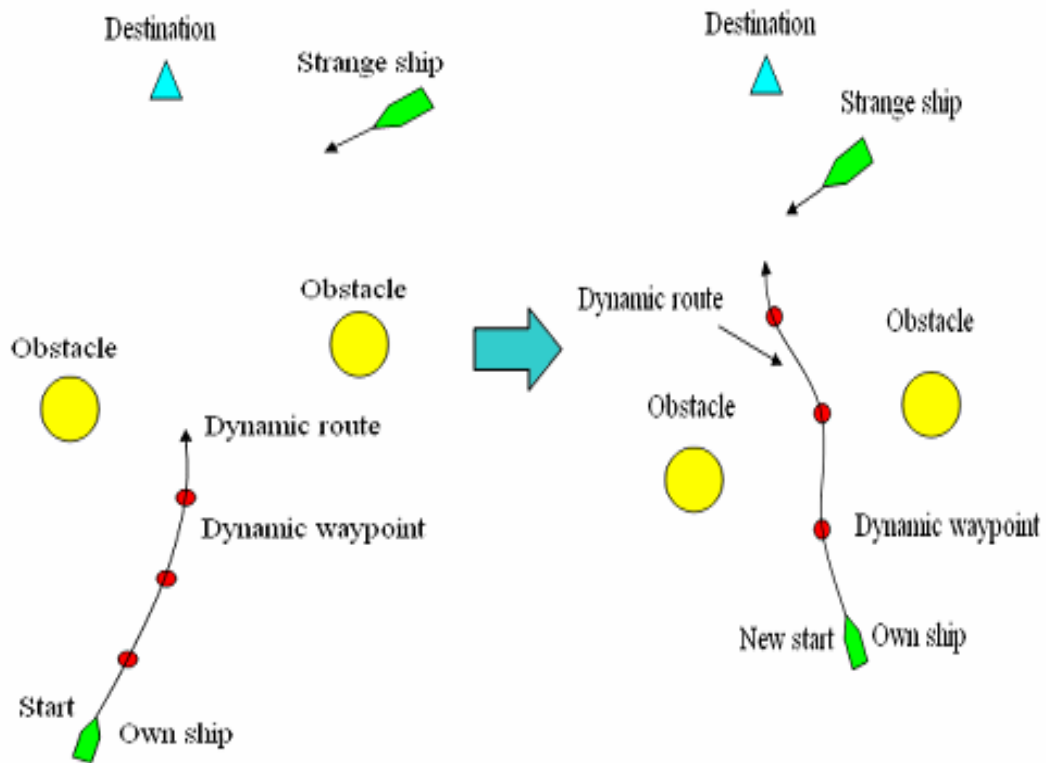

Figure 7- 4: Dynamic route generation

In Figure 7-4, the ship moves with constant speed from the start point. At the first time step, the required location of the ship at the end of the current time step is calculated by automatic route finding and collision avoidance system according to the environmental information. Using the required location at the end of current time step as the provisional start point, the required location at the end of the next time step is estimated. This process is repeated until all the required ‘waypoints’ are gathered. These are the waypoints valid for the current time step. The simulation continues to the next time step and the ‘actual’ location of the ship reached at the end of the previous time step is used as the new start point and the whole process is repeated until the ship reaches the destination. In this *micro* planning the waypoints are changed dynamically at every time step. Meanwhile, the ship states updated at every time step are put into automatic collision avoidance system to calculate the dynamic route immediately in front of the ship in the form of waypoints. This can be translated into heading requirement. The command is analogous to a rudder command that would be issued by heading autopilot. Thus the system can automatically control ship to sail to destination.

The whole process of dynamic route generation can be summarized as follows:

1. The ship's start point and destination are P_s and P_d . The ship is assumed to have constant speed U .
2. Under the potential force, the ship sails towards destination P_d . At time t , the ship's position is at $(x(t), y(t))$. Then this position is denoted as the new start point $P_s(t) = (x(t), y(t))$.
3. Using automatic route finding algorithm and collision avoidance algorithm, the system calculates the ship's heading $\psi_{(t+\Delta t)}$ (where Δt is time step) at next time step. Then the ship's position at next time step $P_s(t + \Delta t)$ can be calculated as follows:

$$\begin{aligned} x(t + \Delta t) &= x(t) + U \times \cos \psi_{(t+\Delta t)} \times \Delta t \\ y(t + \Delta t) &= y(t) + U \times \sin \psi_{(t+\Delta t)} \times \Delta t \end{aligned} \quad (7.3)$$

4. According to these equations, the system automatically calculates the ship's positions at subsequent 3 more time steps. These positions are stored into way-point database. The ship's route can be generated using cubic spline to connect every point.
5. At time $(t + \Delta t)$ the location that the ship actually reached at the end of the previous time step is designated the new start point, and the above processes are repeated until the ship arrives at the destination P_d .

Throughout this work the time step Δt of 1 second was used. Therefore the distance between two consecutive waypoints is the distance that the ship is expected to sail in one second. Since the waypoints are dynamically changed during whole simulation, the ship's route is not fixed, but changes in real time (updating every second) with the change of navigation environment. This is one major point in which

the current study differs from the previous studies.

7.4 Desired Heading along the Route

After calculating the route through the waypoints, the system can get the desired heading $\psi_i(\theta)$ along the route at any given point as shown in Figure 7-5, by calculating the direction of the tangential vector at that point:

$$\psi_i(\theta) = \arctan\left(\frac{y_i^\theta(\theta)}{x_i^\theta(\theta)}\right) \quad (7.4)$$

where $y_i^\theta(\theta) = \frac{\partial y_i(\theta)}{\partial \theta}$ and $x_i^\theta(\theta) = \frac{\partial x_i(\theta)}{\partial \theta}$

Then the desired yaw rate r_i is:

$$r_i = \dot{\psi}_i(\theta) = \frac{x_i^\theta(\theta)y_i^{\theta^2}(\theta) - x_i^{\theta^2}(\theta)y_i^\theta(\theta)}{x_i^\theta(\theta)^2 + y_i^\theta(\theta)^2} \quad (7.5)$$

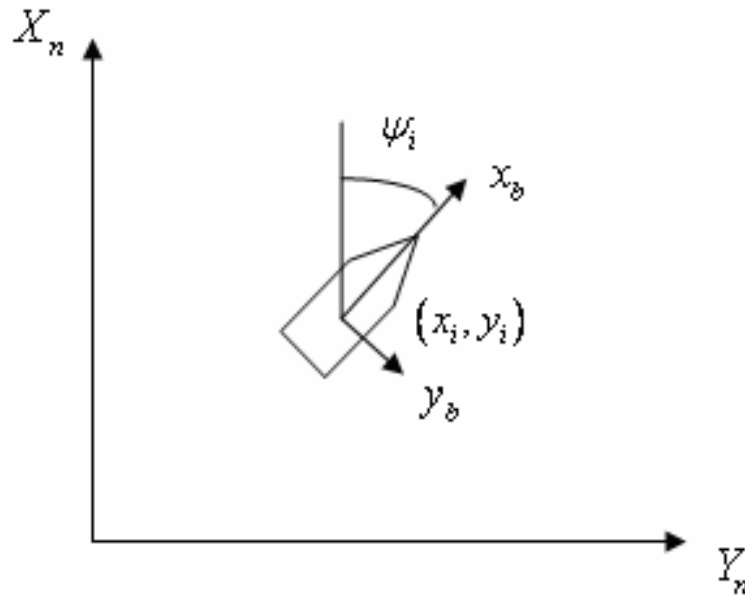

Figure 7- 5: Desired heading along the route

7.5 PID Controller

Having computed the viable route with its way-points and desired heading at any given point in real time, the ship has to be steered to achieve this. Modelling of human pilot behaviour requires a serious amount of pilot tests and complex modelling which is beyond the scope of this study. Therefore, the solution adopted for the current study was to use an automatic pilot based on PID control system.

The PID-controller can be designed as follows [Fossen, 2002]:

$$\delta_{PID}(t) = -K_p \tilde{\psi} - K_d \tilde{r} - K_i \int_0^t \tilde{\psi}(\tau) d\tau \quad (7.6)$$

where δ is the rudder angle; $\tilde{\psi} = \psi - \psi_i$ is the heading error; K_p is the proportional gain constant; K_d is the derivative gain constant; $\tilde{r} = r - r_i$ is the yaw rate error; K_i is the integral gain constant.

The controller gains can be found in terms of the design parameters ω_n and ξ , through [Fossen, 2002]:

$$\begin{aligned} K_p &= \frac{\omega_n^2 T}{K} > 0 \\ K_d &= \frac{2 \xi \omega_n T - 1}{K} > 0 \\ K_i &= \frac{\omega_n^3 T}{10 K} > 0 \end{aligned} \quad (7.7)$$

where ω_n is the natural frequency and ξ is the relative damping ratio, T and K are time constant and gain constant, respectively.

The developed algorithm block diagram based on the summary of the above sections is given in Figure 7-6. It can help the operator to understand the whole progress more clearly.

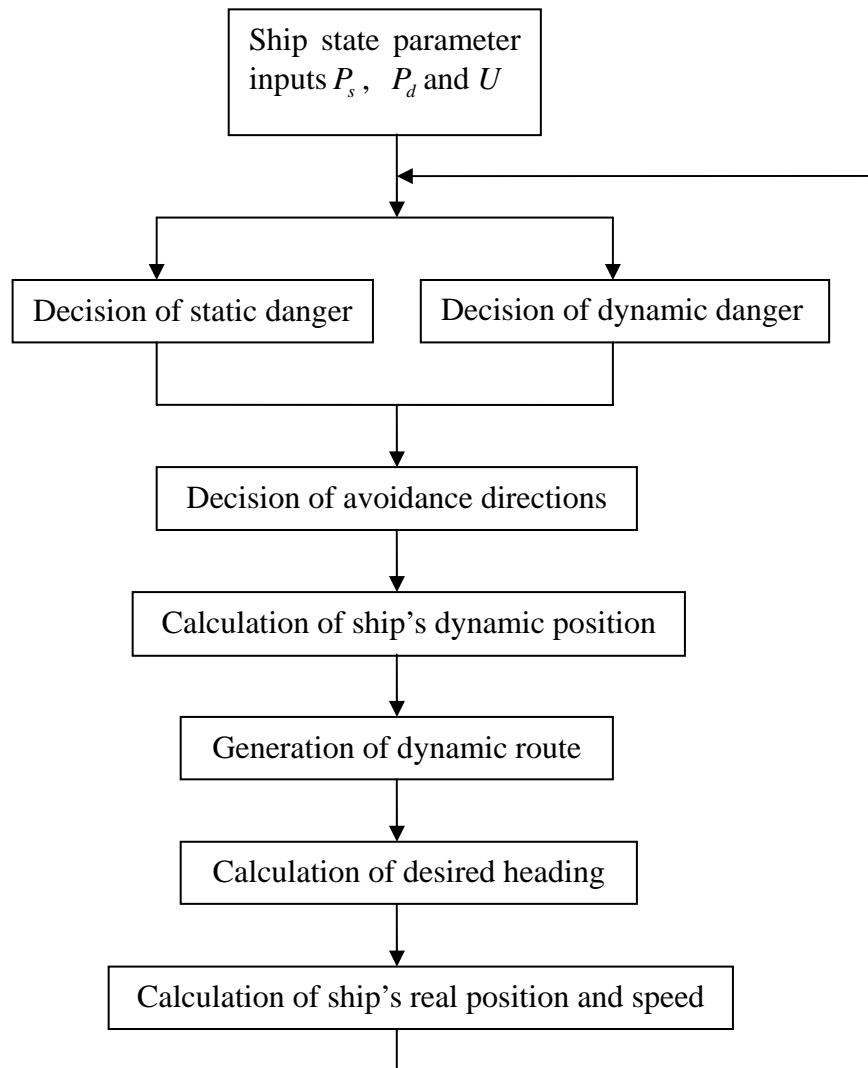

Figure 7- 6: The algorithm block diagram

Chapter 8:

Implementation of Simulation Tool and Case Studies

8.1 Introduction

The ideas developed and discussed in the foregoing chapters were implemented into a MATLAB-based simulation tool. The program is designed with a decentralized structure and the complete simulation program consists of one main program and 13 subprograms. These subprograms can be modified according to different requirements. Figure 8-1 shows the *Compute_repulsive* subprogram.

```

4  %% Pa is the coefficient of attracting force, Pr is the coefficient of repulsive force,
5  %% Pd is the distance of checking static collision, n is the number of obstacle
6  %% R is rotatinal matrix
7  %% The obstacle position in world coordiante has been changed into local coordiante
8  %%
9  %%%%%%%%%%%%%%%%%%%%%%%%%%%%%%%%%%%%%%%%%%%%%%%%%%%%%%%%%%%%%%%%%%%%%%%%%
10
11 function [Frep1x,Frep1y,Frep2x,Frep2y]=Compute_repulsive(Pow_s,Xsum,R,r,Pr,angle_at,angle_re,Pa,n,Pd)
12
13 for j=1:n
14     X=R*[Xsum(j,1);Xsum(j,2)];
15     rs(j)=sqrt((Pow_s(1)-X(1))^2+(Pow_s(2)-X(2))^2);
16     if rs(j)<Pd
17         Frep1(j)=Pr*(1/rs(j)-1/Pd)*1/rs(j)^2*r^2;
18         Frep2(j)=Pr*((1/rs(j)-1/Pd)^2)*r;
19         Frep1_x(j)=Frep1(j)*cos(angle_re(j));
20         Frep1_y(j)=Frep1(j)*sin(angle_re(j));
21         Frep2_x(j)=Frep2(j)*cos(angle_at);
22         Frep2_y(j)=Frep2(j)*sin(angle_at);
23     else
24         Frep1(j)=0;
25         Frep2(j)=0;
26         Frep1_x(j)=0;
27         Frep1_y(j)=0;
28         Frep2_x(j)=0;
29         Frep2_y(j)=0;
30     end
31     Frep1x=sum(Frep1_x);

```

Figure 8- 1: The *Compute_repulsive* subprogram

The inputs to this program consist of ships' positions, obstacles' positions and ships' speeds.

The output consists of two plots. The first plot shows the progress of the simulation in real time as shown in Figure 8-2. The user can see the whole ship's movement through this plot during the simulation. The second plot displays the ship's key manoeuvring parameters against time. From this plot, the user can analyze the ship's performance during simulation. Further details about this program can be found in Appendix B.

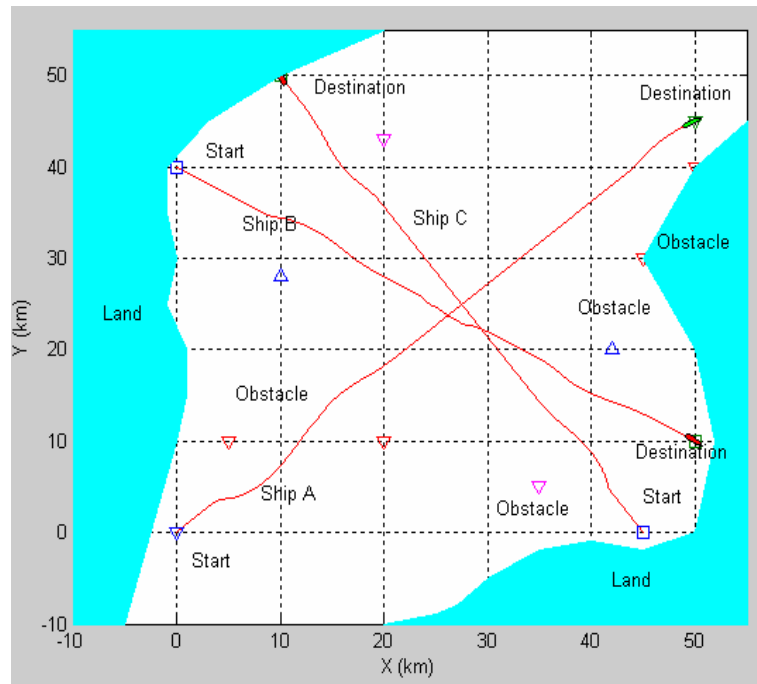

Figure 8- 2: The output plot

8.2 The Fundamental Case Studies

In order to demonstrate the effectiveness of the method developed, two-ship encounter conditions including crossing, head on and overtaking are simulated in the first instance. The same algorithm is applied to both ships featured in the simulation.

For the sake of simplicity all the moving ships within the simulation range are assumed to be Mariner class in these studies, because this ship has been studied in

detail in various comparative studies by different authors and detailed information is available on its manoeuvring characteristics. The ship model parameters can be found in Appendix A. The parameters of simulation are given as follows: the positive constant m and the positive scalar quantity α in attractive potential function are 2 and 20 respectively; the positive constant η and n in repulsive potential function are 200 and 2 respectively; the influence range of the obstacle p_o is 3 (Nm), the value of f is 2.5 and the position evaluation error C_E is 0.04 (Nm); the time constant $T = 107.3$ (s) and the gain constant $K = 0.185$ (1/s); the natural frequency $\omega_n = 0.03$ (rad/s) and the relative damping ratio ξ is 1.

8.2.1 Two Ships Crossing

The cases of two ships crossing with a number of different speeds and course scenarios are simulated. This was done primarily to verify that the simulation program is capable of manoeuvring the ships in compliance with COLREGS.

The position and speed of ships for the first scenario tested are given in Table 8-1.

Table 8- 1: The position and speed of ships for the first scenario

	Start (km)	Destination (km)	Speed (m/s)
Own Ship	(0,0)	(20,20)	7.7
Strange Ship	(20,0)	(0,20)	7.7

To begin with, own ship and the strange ship set off towards their respective destinations as shown in Figure 8-3. In Figure 8-4, the program decides that there is a risk of collision and identifies the ship on the left ('own' ship) as the give-way ship according to COLREGS. It then starts manoeuvring to starboard to avoid collision, whilst the stand-on ship on the right ('strange' ship) maintains its course and speed.

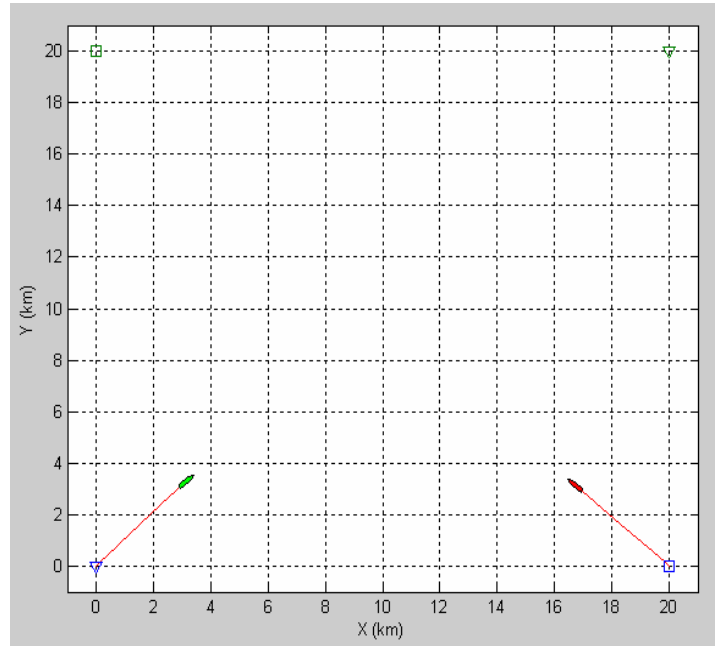

Figure 8- 3: Simulation starts

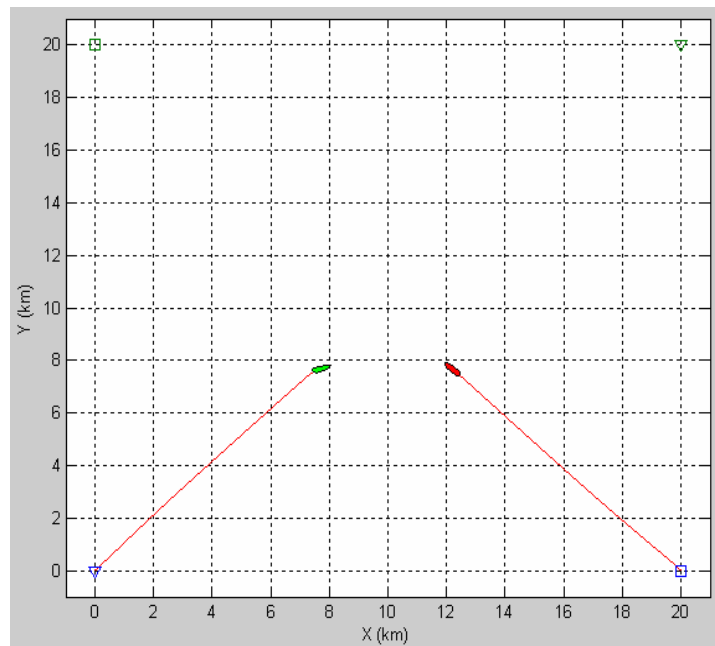

Figure 8- 4: Having identified the collision risk, the give-way ship starts manoeuvring

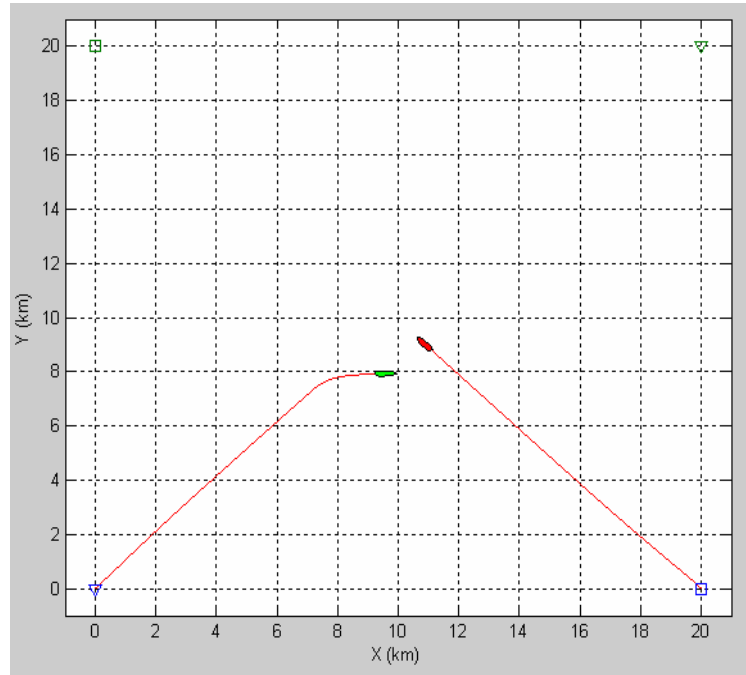

Figure 8- 5: The give-way ship turns to starboard

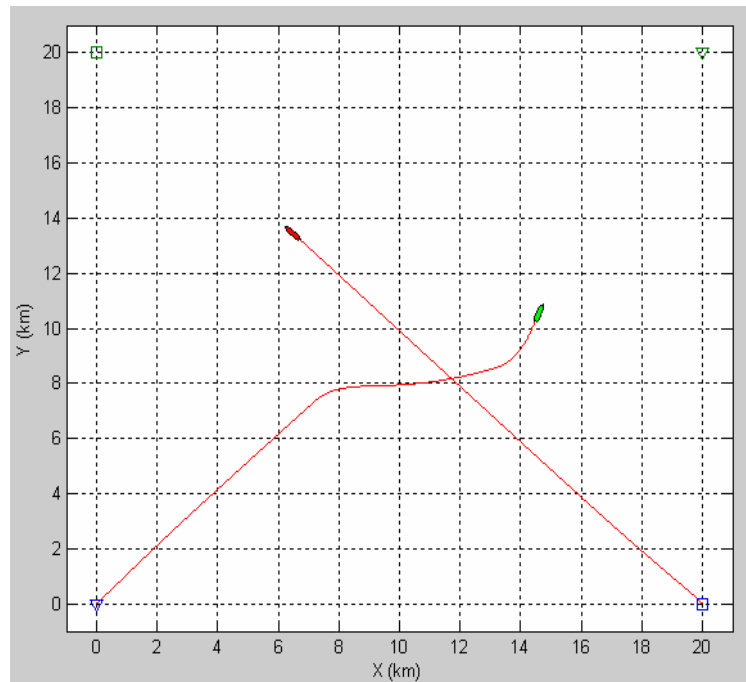

Figure 8- 6: Own ship sails to destination

From Figure 8-6, it can be seen that the ships have negotiated the potential collision situation successfully and both ships continue towards their respective destinations.

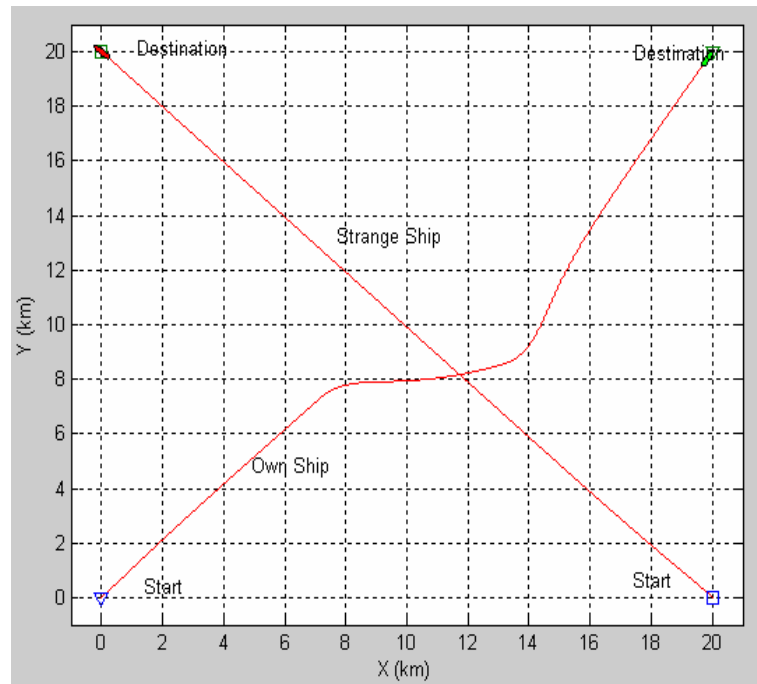

Figure 8- 7: Two ships arrive at destination

The time history of own ship's yaw rate, yaw angle, speed and rudder angle during the manoeuvre are given in Figure 8-8. The same for the strange ship are given in Figure 8-11. The circled parts in Figure 8-8 are enlarged as shown in Figure 8-9 and 8-10.

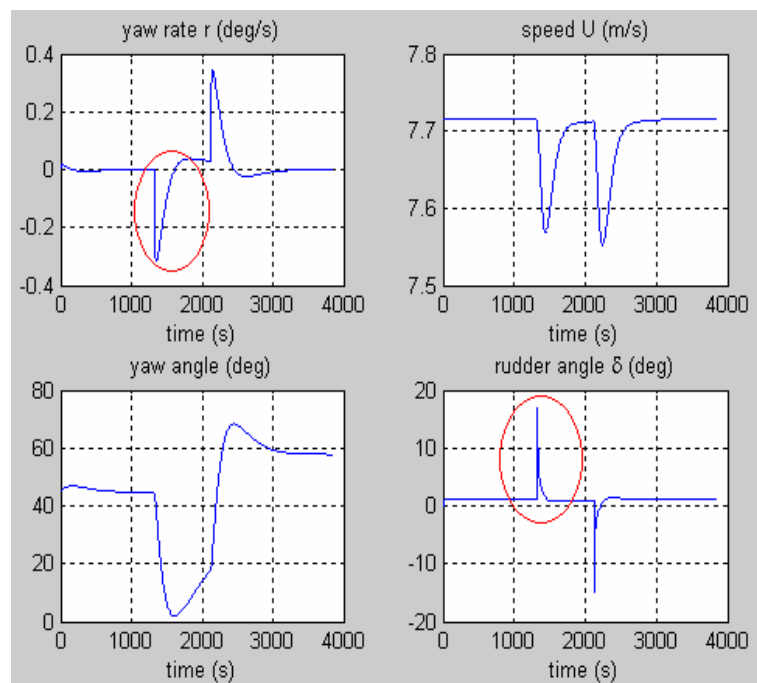

Figure 8- 8: Own ship's yaw rate, yaw angle, speed and rudder angle

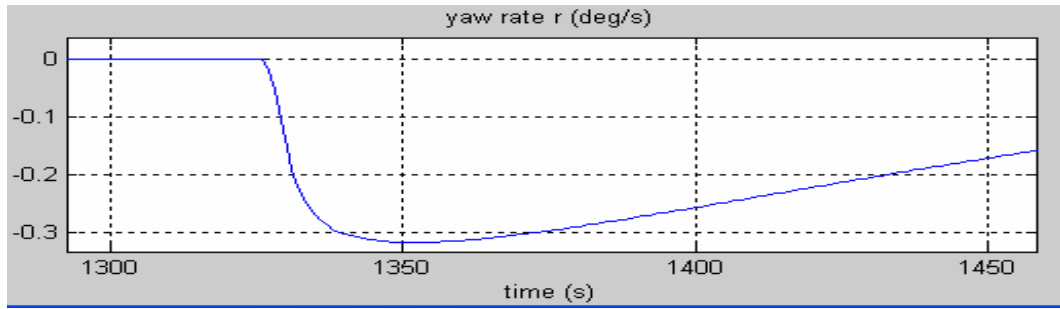

Figure 8- 9: The enlarged part in Figure 8-8 (1)

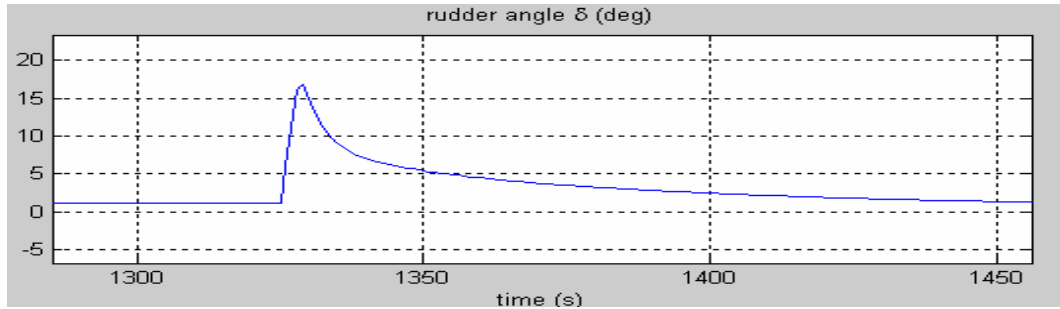

Figure 8- 10: The enlarged part in Figure 8-8 (2)

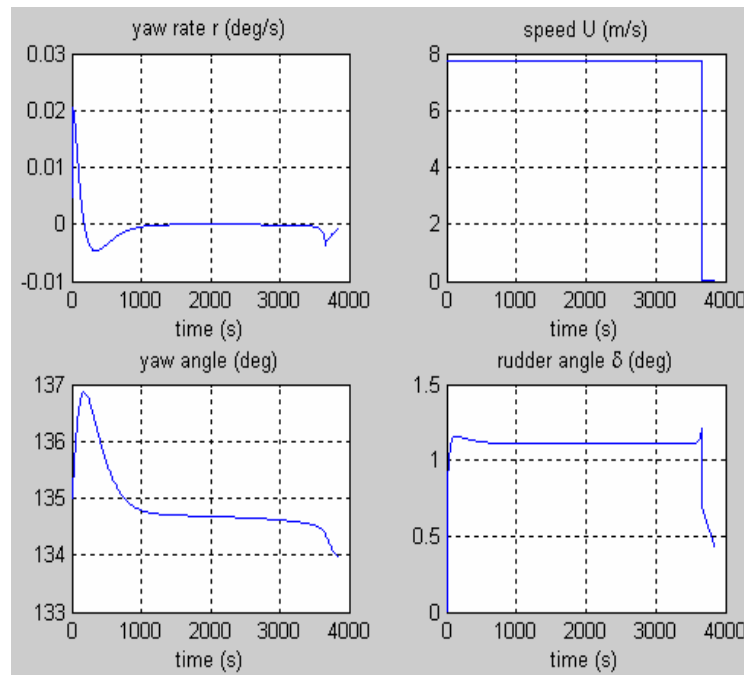

Figure 8- 11: Strange ship's yaw rate, yaw angle, speed and rudder angle

In order to illustrate the performance of the cubic spline algorithm discussed in Chapter 7, the part of ship's route (the circled part in the Figure 8-12) is enlarged.

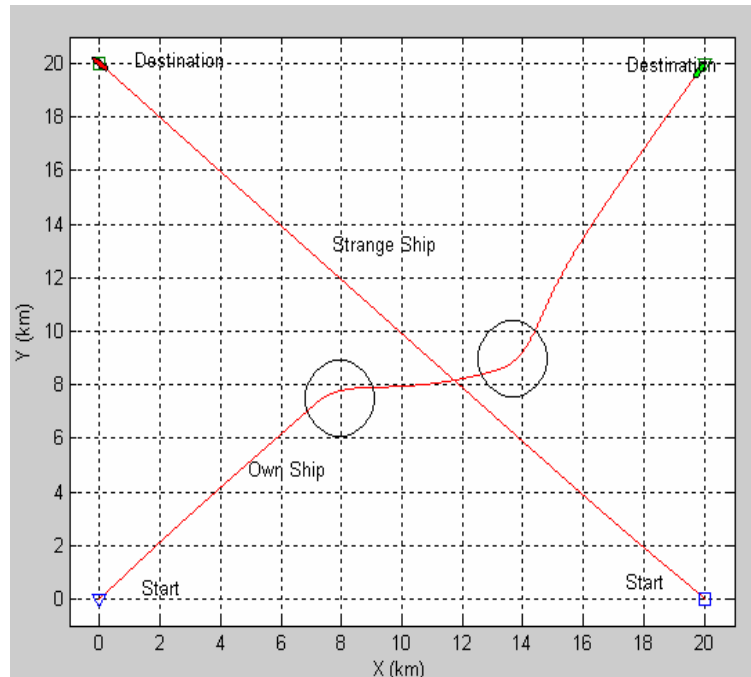

Figure 8- 12: The part of route

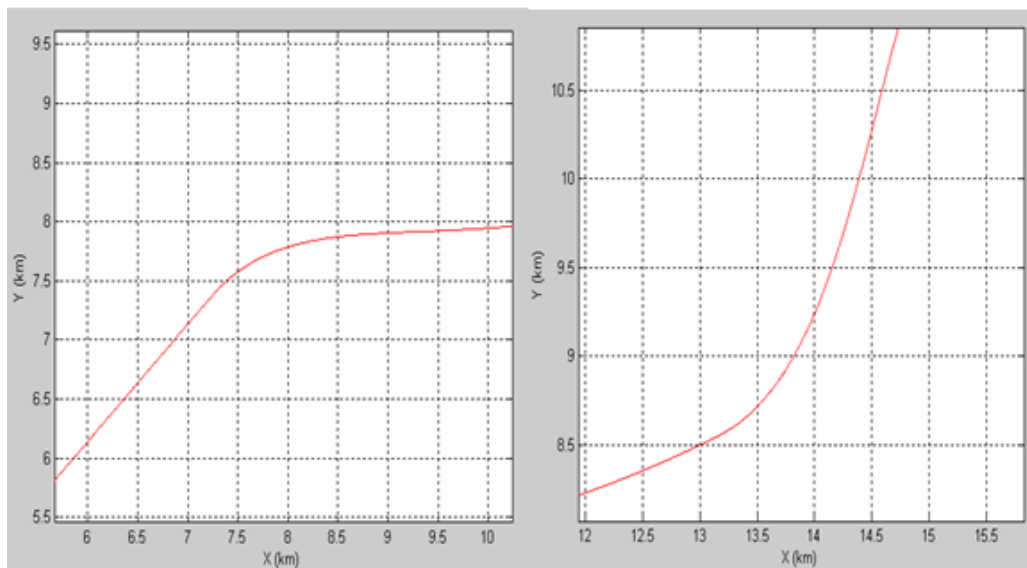

Figure 8- 13: The enlarged route

Although the actual ship's paths may not be precisely as shown, these are considered sufficiently accurate for our purpose here.

In the second scenario, own ship's speed is reduced to 6.7 (m/s) and the strange ship's speed is maintained at 7.7 (m/s). The simulation results are presented in Figure 8-14. In the third scenario, own ship's speed is 7.7 (m/s) and strange ship's speed is 6.2 (m/s). The simulation progress is shown in Figure 8-15.

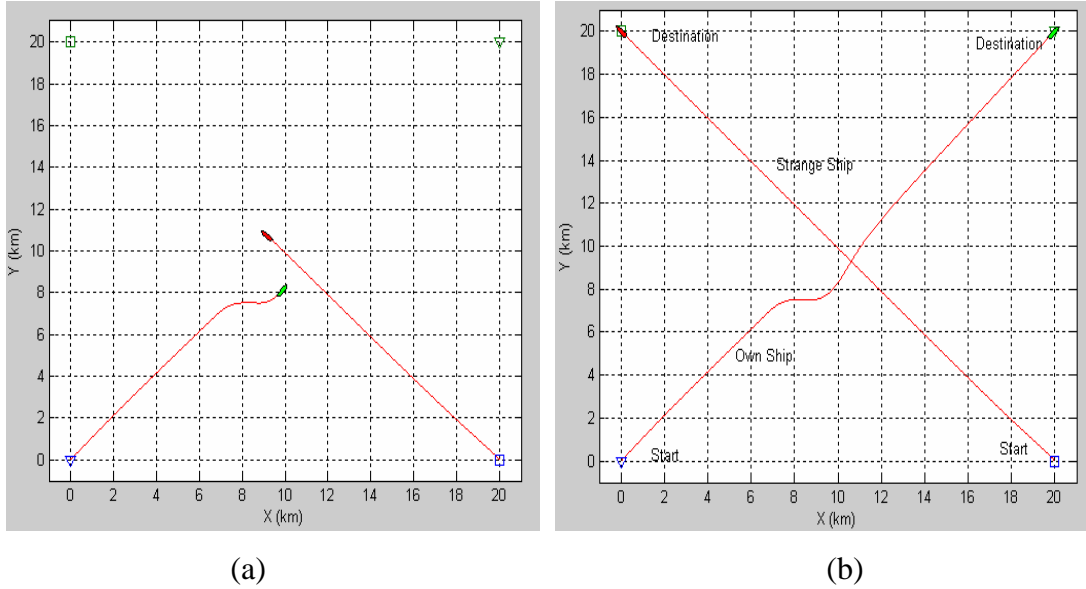

Figure 8- 14: (a) Own ship avoids collision (b) two ships arrive at the destination

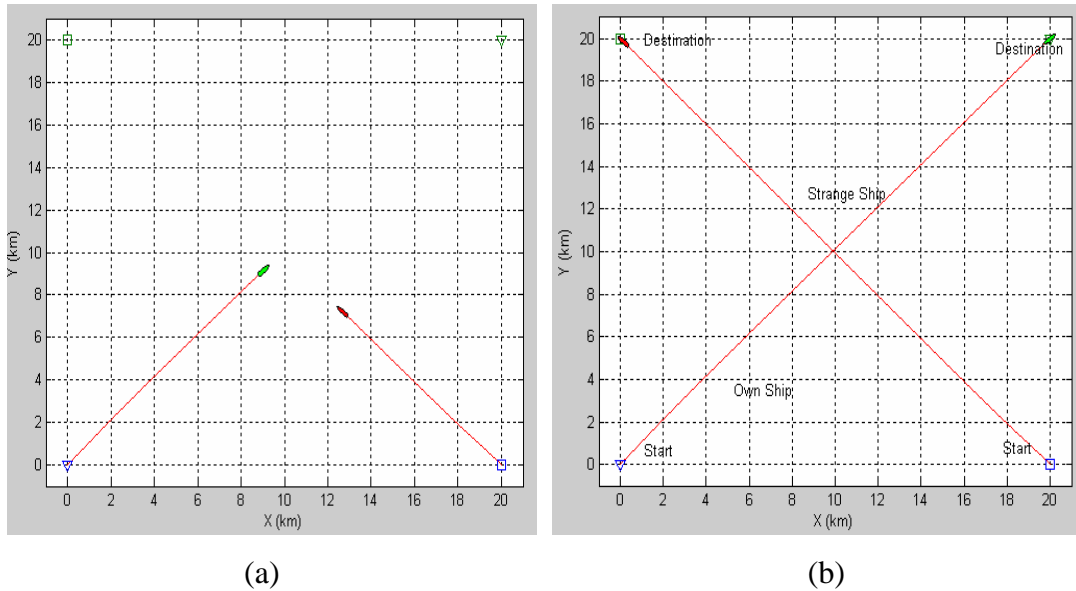

Figure 8- 15: (a) No collision risk (b) two ships arrive at destination

These simulation studies have shown that the program can make proper decisions as to the collision risk and which ship(s) needs to take action, and automatically calculate the turning angle required to avoid collision according to the speeds of own ship and the strange ship. This is one capability of this program that has not been addressed by other recent research work on collision avoidance.

8.2.2 Two Ships Head On

In this scenario the position and speed of ships are given in Table 8-2.

Table 8- 2: The position and speed of ships

	Start (km)	Destination (km)	Speed (m/s)
Own Ship	(11,0)	(11,28)	7.7
Strange Ship	(10,28)	(10,0)	7.7

In accordance with the provisions in COLREGS both ships turn to starboard. The progress of the simulation is given in the following figures.

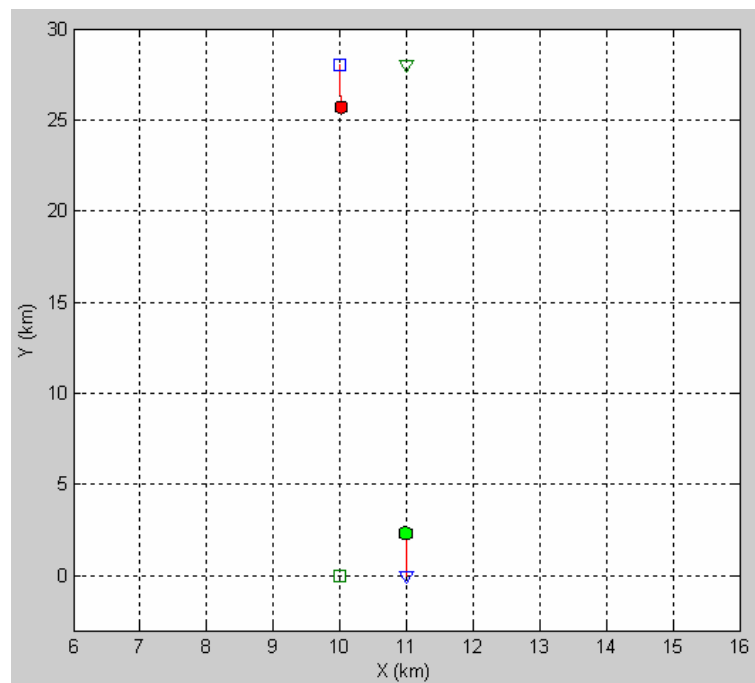

Figure 8- 16: Simulation starts

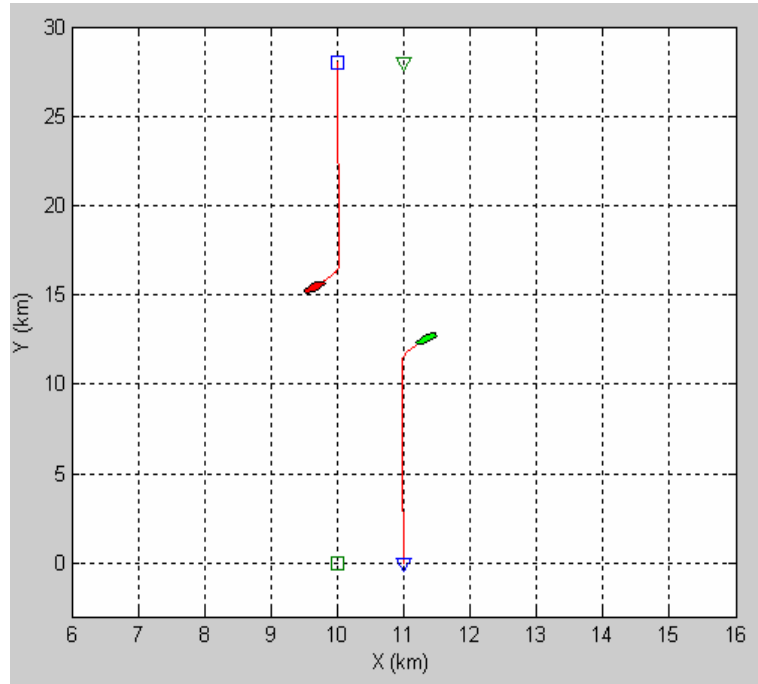

Figure 8- 17: Identifying the collision risk, both ships turn to starboard

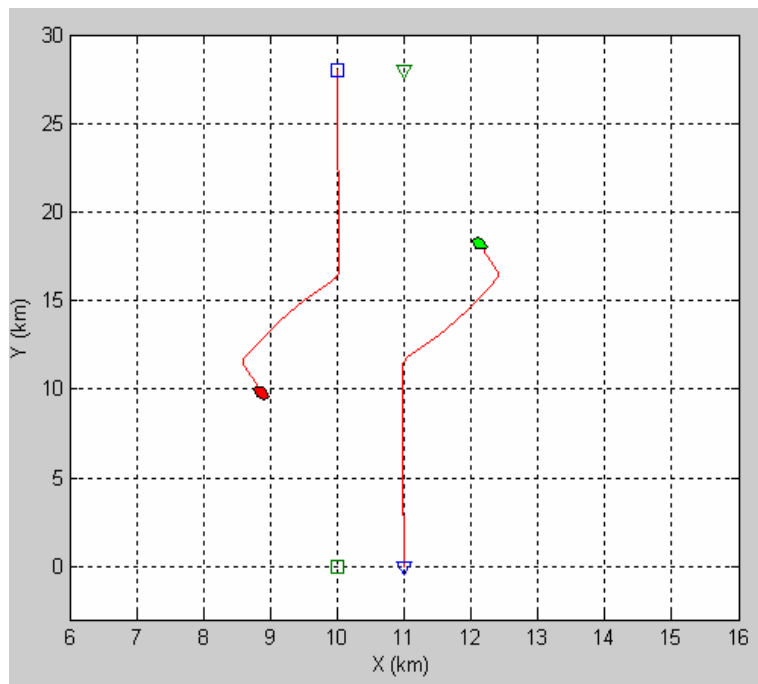

Figure 8- 18: Sailing to destination

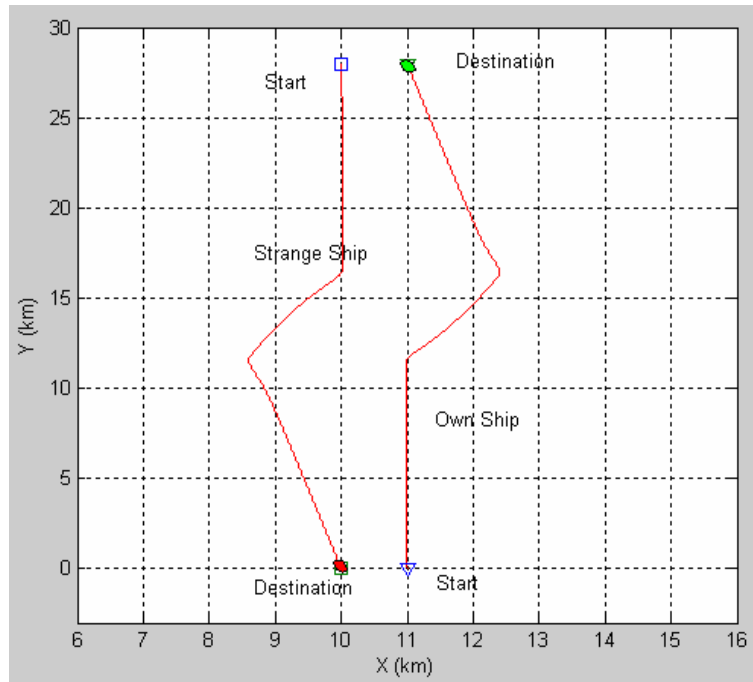

Figure 8- 19: Arriving at the destination

8.2.3 One Ship Overtaking Another

The situation of one ship overtaking another is simulated. The position and speed of ships in this scenario are given in Table 8-3

Table 8- 3: The position and speed of ships

	Start (km)	Destination (km)	Speed (m/s)
Own Ship	(11, -2)	(11, 19)	10.2
Strange Ship	(11, 4)	(11,14)	5.1

Because own ship is faster than the strange ship, it is to turn to port to overtake the strange ship in accordance with the rule. The result is presented in Figures 8-20 to 8-23.

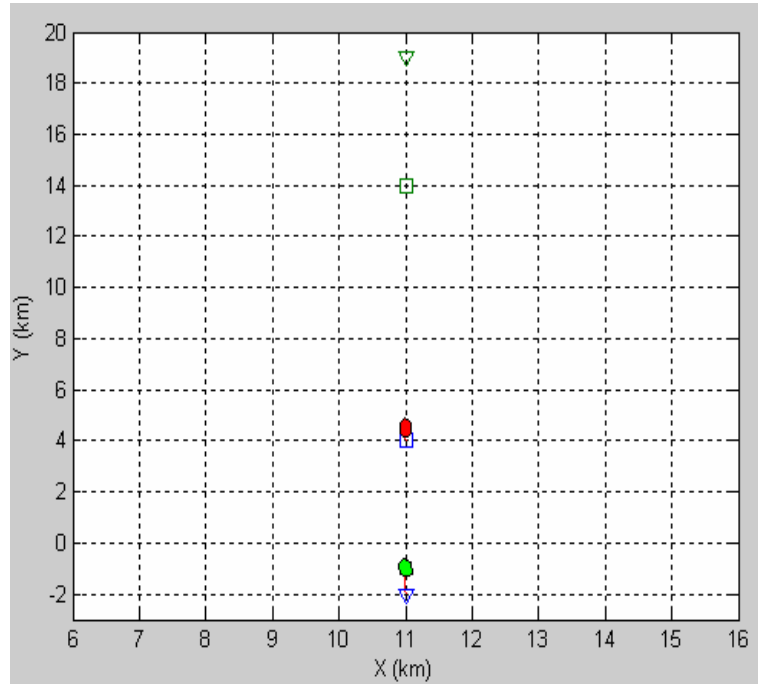

Figure 8- 20: Simulation starts

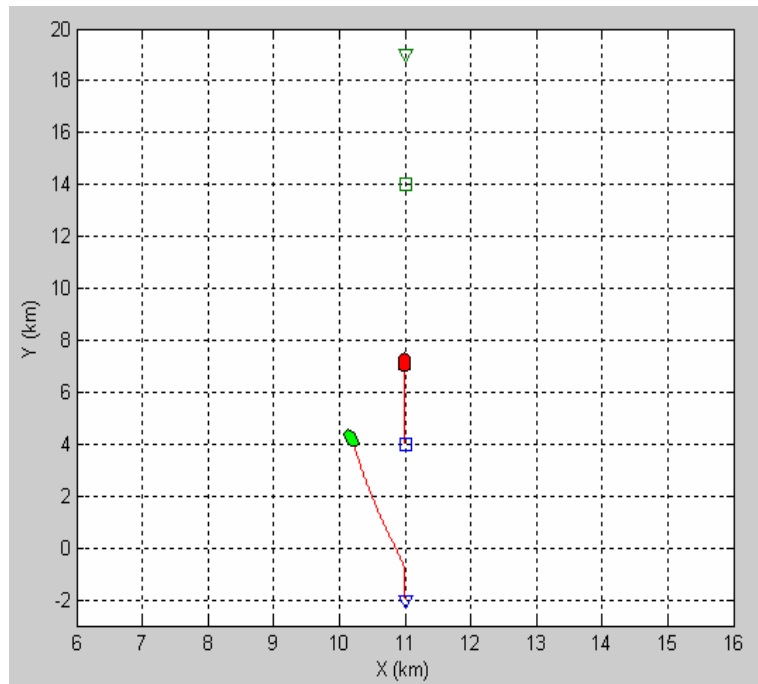

Figure 8- 21: Own ship turns to port

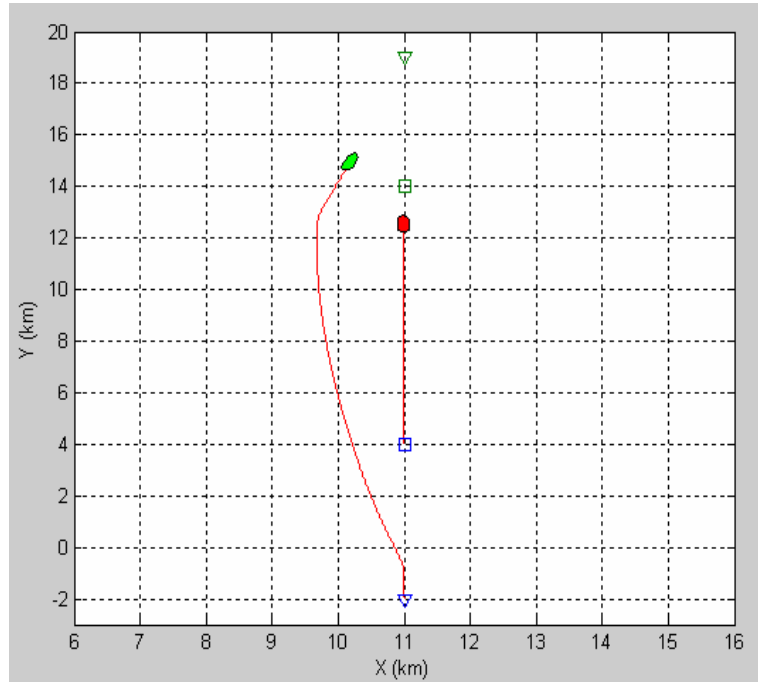

Figure 8- 22: Own ship overtakes the strange ship

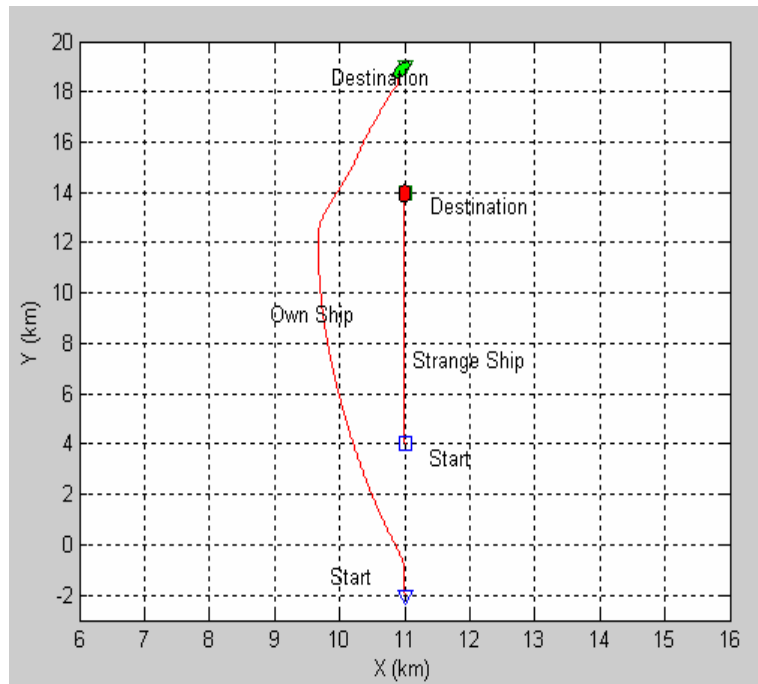

Figure 8- 23: Arriving at the destination

8.2.4 The Limiting Case Study

According to international regulations for preventing collision at sea, ships should turn to starboard to avoid collision, but in some special situations, the starboard manoeuvre is not advisable choice for collision avoidance. The following case illustrates this point. The position and speed of ships are given in Table 8-4.

Table 8- 4: The position and speed of ships

	Start (km)	Destination (km)	Speed (m/s)
Own Ship	(10, 0)	(10,18)	7.7
Strange Ship	(11,18)	(11,0)	7.7

The simulation progress can be seen in Figure 8-24.

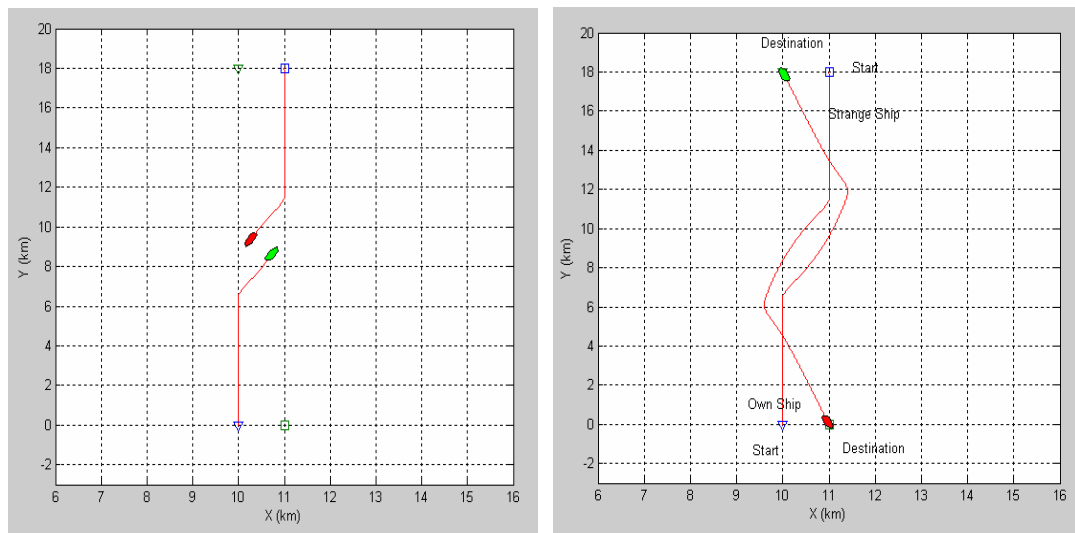

Figure 8- 24: The limiting case (a) both ships turn to starboard (b) arrive at the destination

Figure 8-24 illustrates a condition where two ships approach each other. According to COLREGS Rule 14, both ships are supposed to take a starboard manoeuvre for a safe passage. From the results, it can be seen that the two ships pass too close to each other when taking the starboard manoeuvre and this is neither advisable nor

reasonable according to practical operational experience reported in [Xu, 2005].

Based on Rule 8: “(c) *If there is sufficient sea room, alteration of course alone may be the most effective action to avoid a close-quarters situation provided that is made in good time, is substantial and does not result in another close-quarters situation*”, in this program, the port manoeuvre is adopted to avoid collision when two ships have the starboard head-on encounter situation and the distance between two ships is less than 3 Nm. Obviously, if the distance between two ships is enough large (e.g. 6 Nm), then two ships have enough time and sufficient sea room to turn starboard for a safe passage. In that condition, the program will follow the rule of turning starboard to avoid collision.

This change can be seen in Figure 8-25. The position and speed of ships are the same as before.

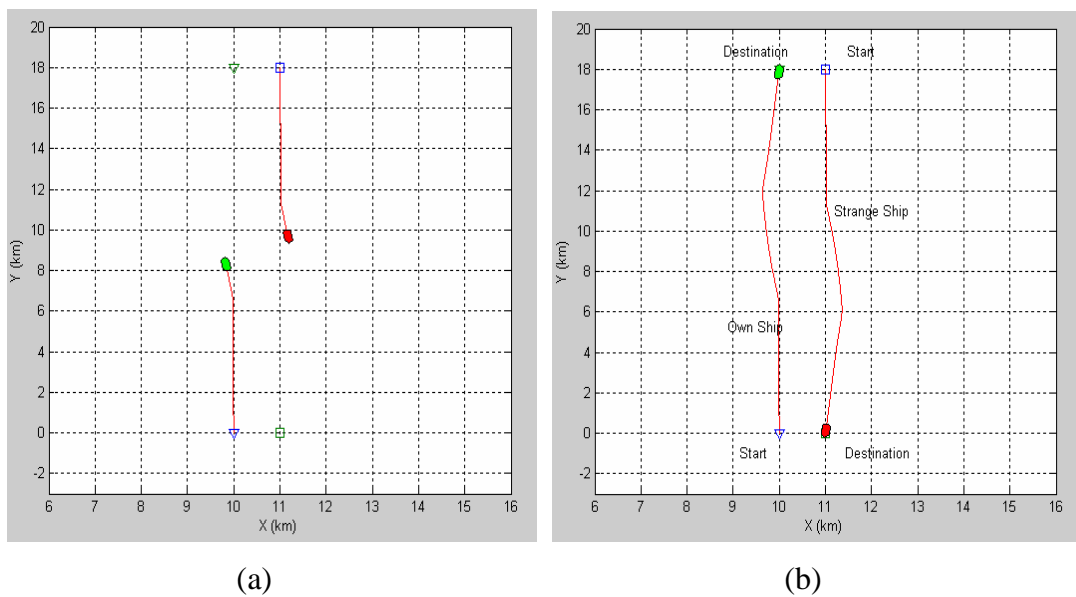

Figure 8- 25: (a) Turn port to avoid collision (b) arrive at the destination

The simulation progress shows the proposed algorithm of port manoeuvre can solve collision avoidance well when two ships have starboard head-on encounter.

From the above cases, we can see the algorithm used is in accordance with COLREGS.

8.3 Applications of the Simulation Tool

It has been shown the method developed in this project is capable of dealing with the basic situations described above. More complicated situations are tested in this section. One of the more difficult problems to cope with is when the channel or waterway has narrow sections with sharp turns.

8.3.1 Case 1: Autonomous Ship Navigation through a Channel

In order to validate the method developed, one “extreme” case, the Strait of Istanbul was chosen. It presents one of the greatest challenges for navigation as it snakes through the heart of Istanbul [Kose et al., 2003].

The Strait is approximately 31 km long, with an average width of 1.5 km and a mere 698 m at its narrowest point. It takes several sharp turns, forcing the ships to alter course at least 12 times, sometimes executing turns of up to 80 degrees [Kose et al., 2003]. The Figure 8-26 shows a satellite photograph of the Strait of Istanbul and its vicinity. The part of this strait between two red lines is used to test the developed program.

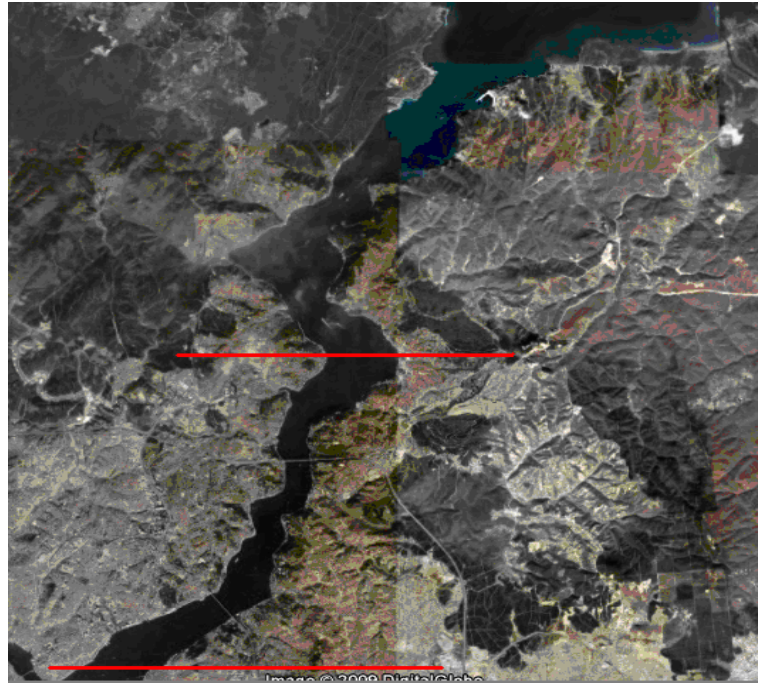

Figure 8- 26: The Strait of Istanbul (from Google map)

Based on the Google map, a map representing the major features of the Strait is built in Matlab environment as shown in Figure 8-27.

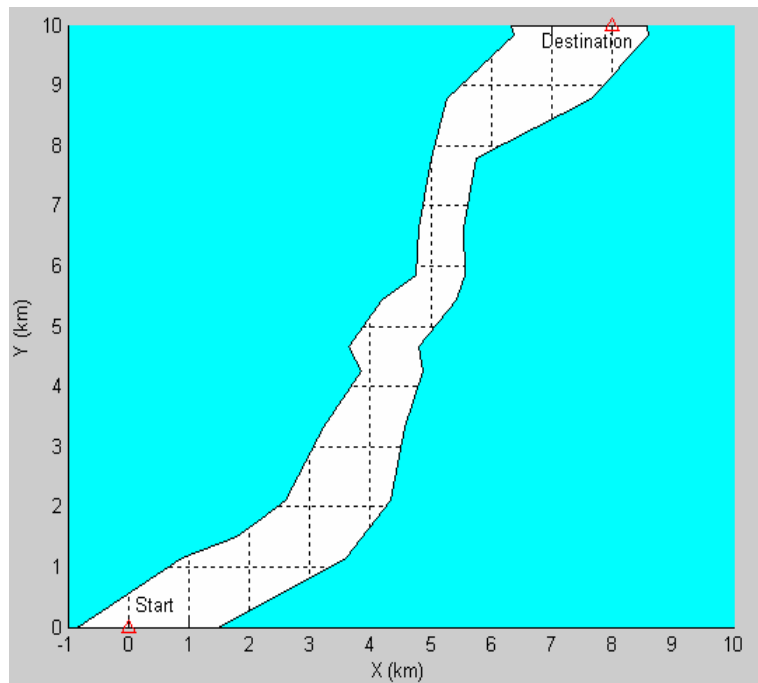

Figure 8- 27: The Matlab map

Because of the average width of 1.5 km with a minimum of 698 m, the influence range of the obstacle is set at 0.3 km. The ship's speed is 3.9 (m/s) and starting point is at $(x_s, y_s) = (0,0)$ (km) and the destination point is $(x_d, y_d) = (8,10)$ (km).

According to the description in Chapter 5, the coastlines of the strait can be represented by discrete point obstacles. This navigation environment is so complex that an analysis of the ship's route under potential field force is carried out before placing the obstacle points.

The ship will go straight from the start to the destination under the attractive force if there are no limitations of the coastline. The route will be the red line as shown in Figure 8-28.

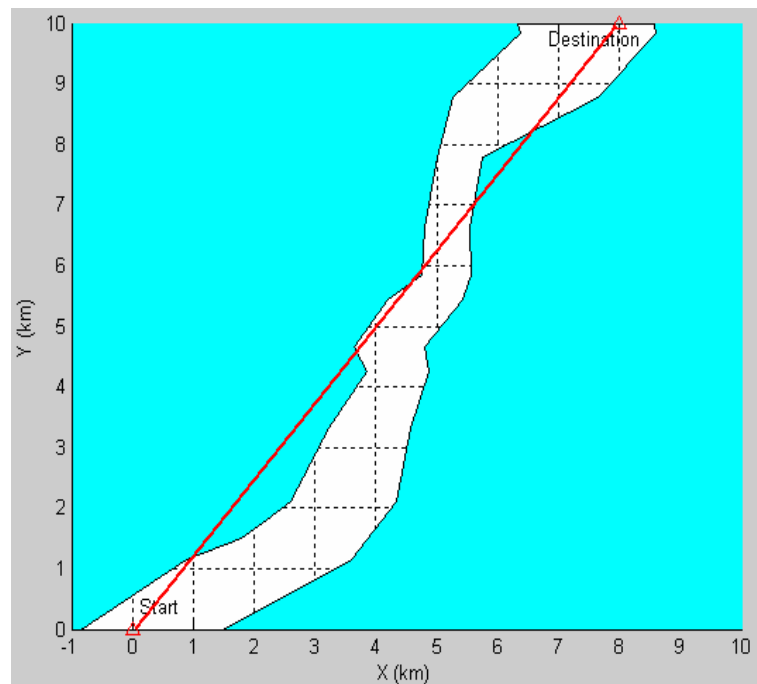

Figure 8- 28: The desired route

If this route is followed, the ship will hit the coastline at least at three areas as shown in Figure 8-29.

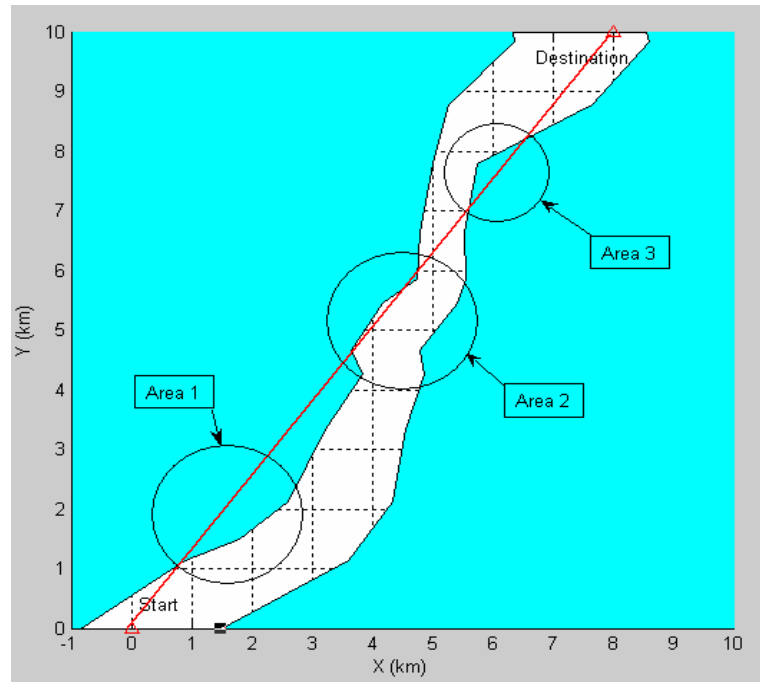

Figure 8- 29: Three dangerous areas

Analyzing these three dangerous areas, it can be seen that there exists a possibility of no passage between closely spaced point obstacles as discussed in Chapter 5. In order to ensure a safe passage whilst ensuring satisfactory progress through the Strait, these areas need to be given close attention when placing point obstacles along the coastline. After the analysis, the primary point obstacles were placed as given in Table 8-5 and shown in Figure 8-30.

Table 8- 5: The positions of point obstacles

Number	Position (km)	Number	Position (km)	Number	Position (km)
1	(0,0.5)	10	(4.8,6.63)	19	(4.8,4.67)
2	(0.89,1.14)	11	(5,7.79)	20	(5.4,5.45)
3	(1.8,1.5)	12	(5.27,8.78)	21	(5.56,5.85)
4	(2.6,2.12)	13	(6.37,9.83)	22	(5.54,6.63)
5	(3.23,3.33)	14	(1.49,0)	23	(5.75,7.79)
6	(3.84,4.25)	15	(3.6,1.14)	24	(7.66,8.78)
7	(3.65,4.67)	16	(4.34,2.12)	25	(8.61,9.83)
8	(4.19,5.45)	17	(4.57,3.33)		
9	(4.75,5.85)	18	(4.88,4.25)		

Using the primary point obstacles and the method described in Chapter 5, the system proceeded to place the intermediate point obstacles along the coastline as shown in Figure 8-31.

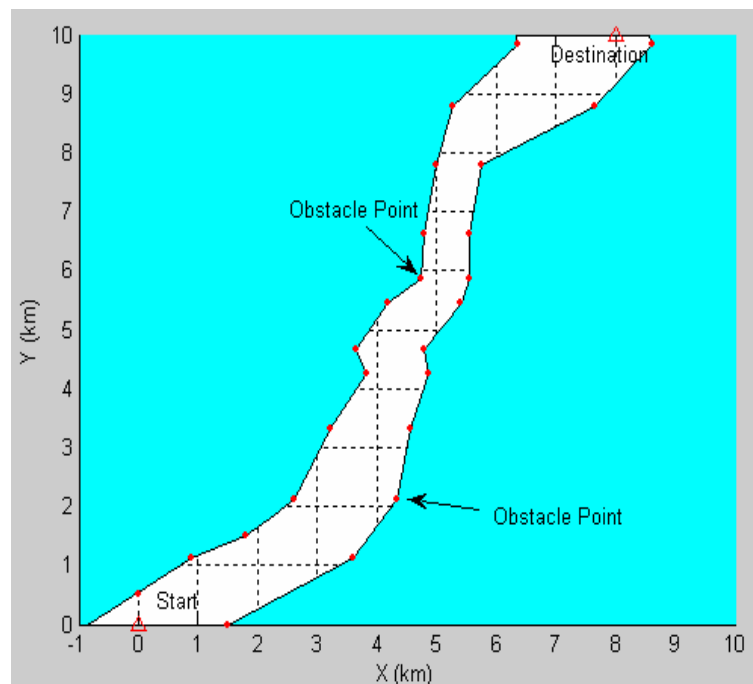

Figure 8- 30: The discrete obstacle points

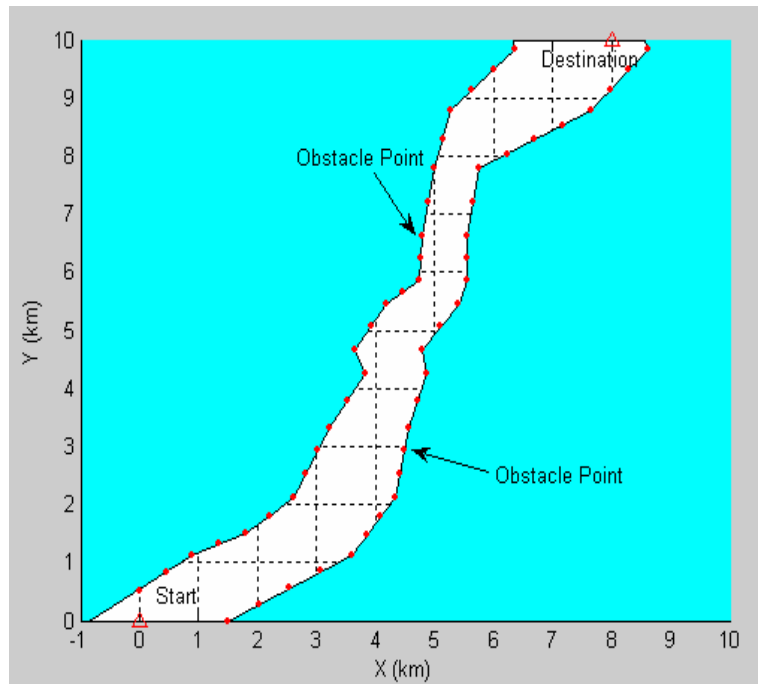

Figure 8- 31: Calculating and placing point obstacles automatically

The corresponding potential field is generated using potential field function given in Chapter 5. Figure 8-32 shows the contour plot of the potential field. Some parts of this figure are enlarged as shown in Figures 8-33 and 8-34 for better viewing.

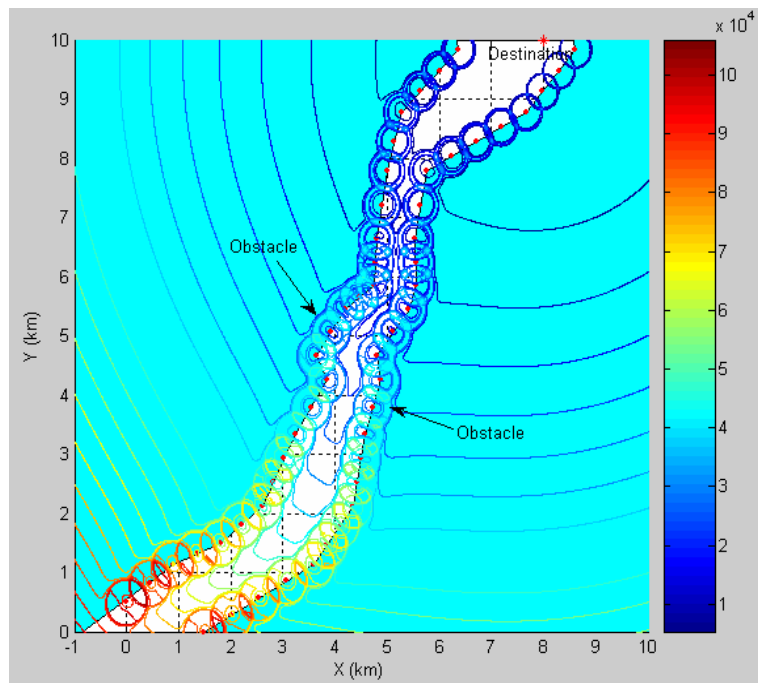

Figure 8- 32: The contour plot of the potential field

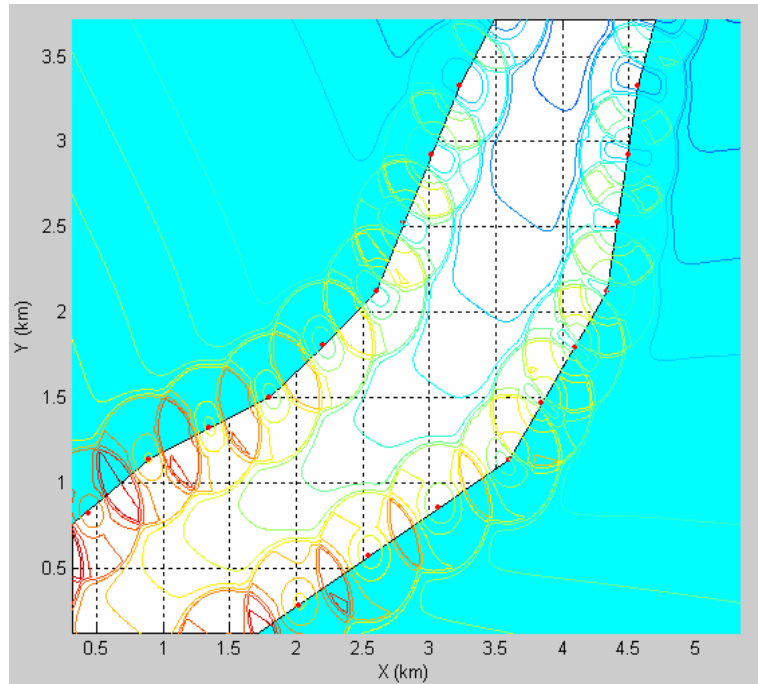

Figure 8- 33: The enlarged part (1)

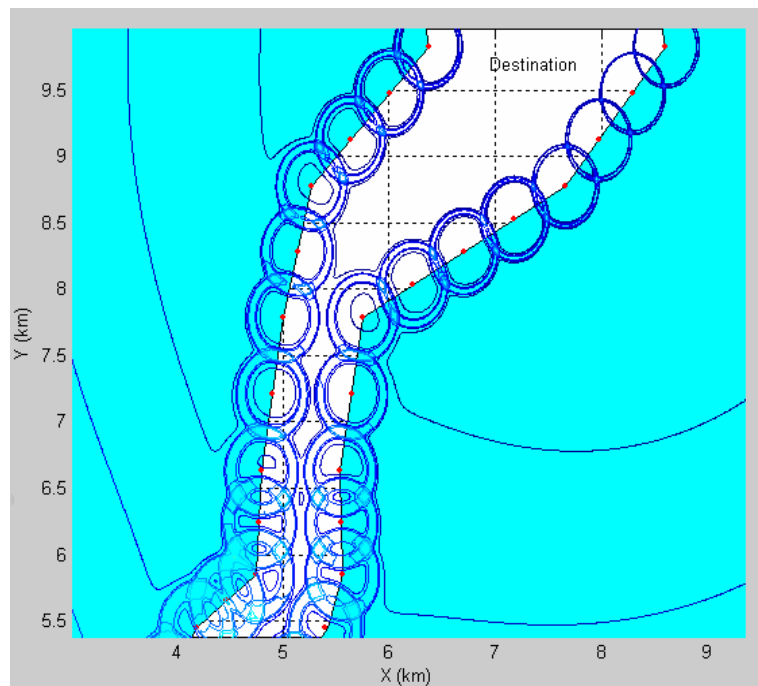

Figure 8- 34: The enlarged part (2)

From the contour plot, we can see that potential field function generates high potential at the surface of the obstacle, and the coastline is covered by the potential. The ship in the potential field will follow the gradient of the potential field, and eventually converge to the destination.

The simulation starts its run as shown in Figure 8-35.

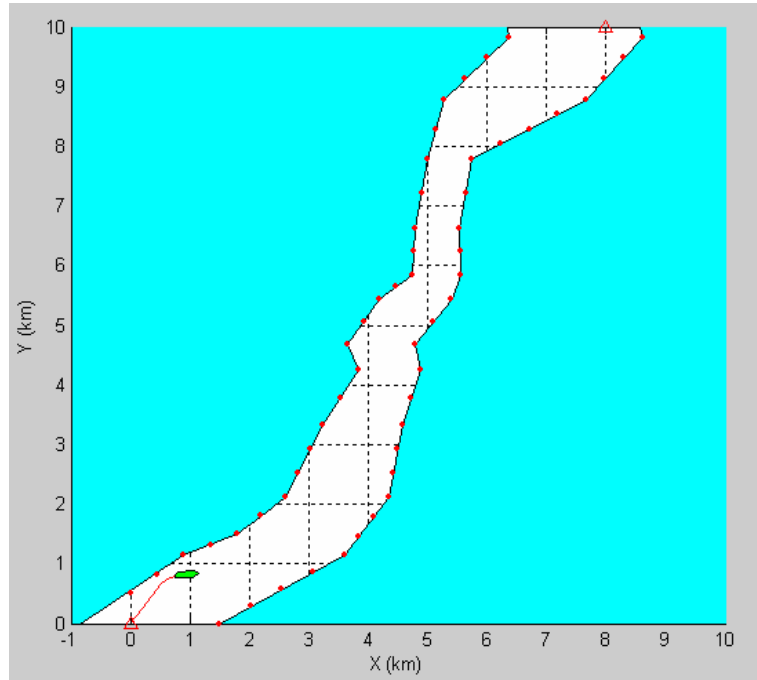

Figure 8- 35: Simulation starts

The ship successfully avoids hitting the bank and negotiates the first major bend as shown in Figures 8-36 and 8- 37.

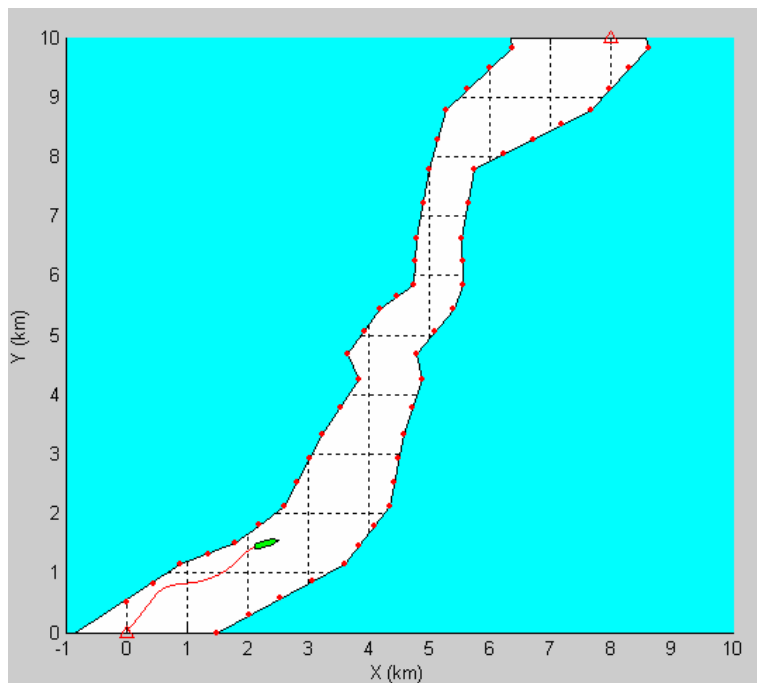

Figure 8- 36: Avoiding hitting the bank

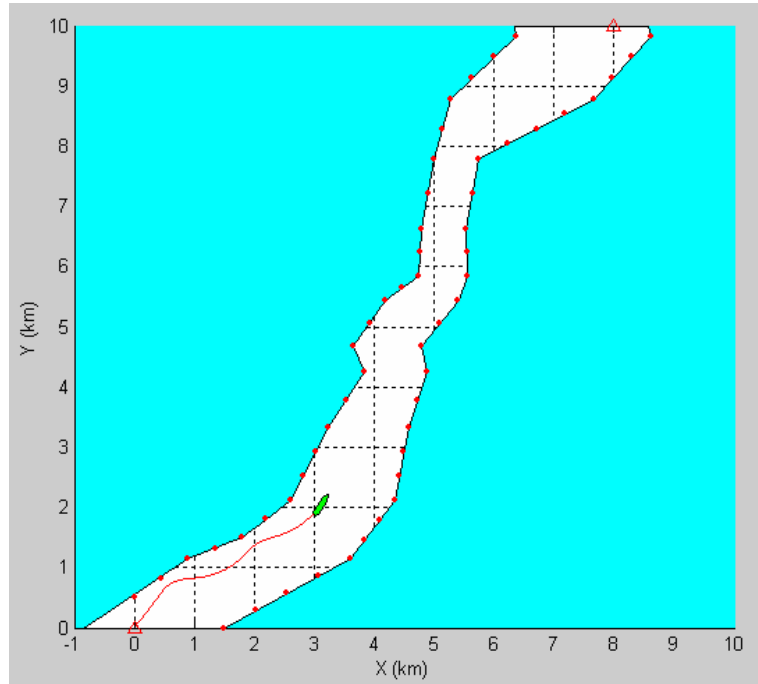

Figure 8- 37: Negotiating the first major bend successfully

The ship continues on its way (Figure 8-38).

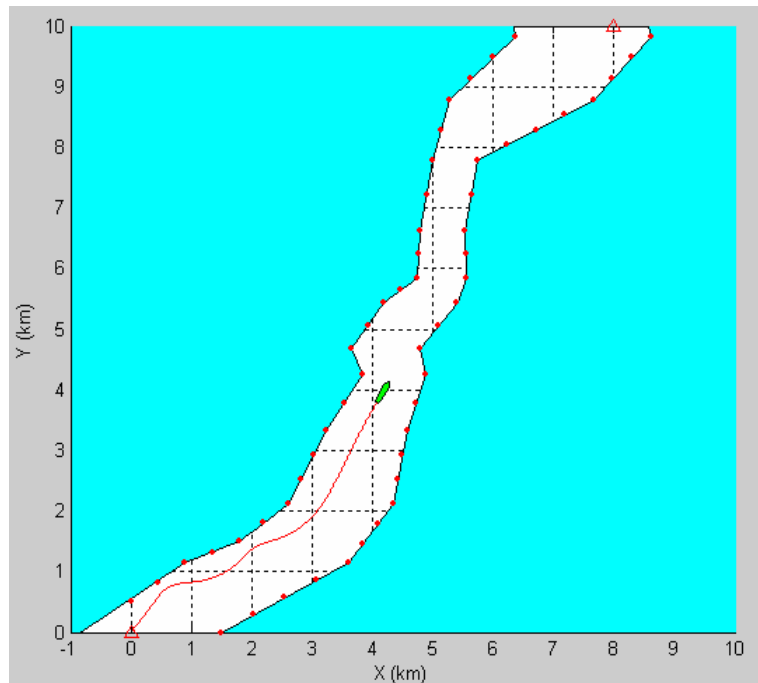

Figure 8- 38: Sailing on

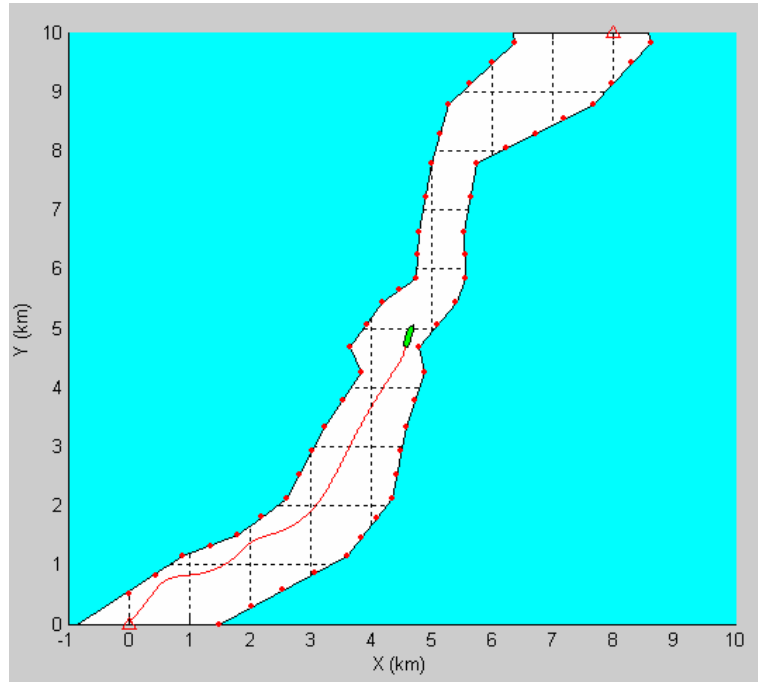

Figure 8-39: Negotiating another sharp bend

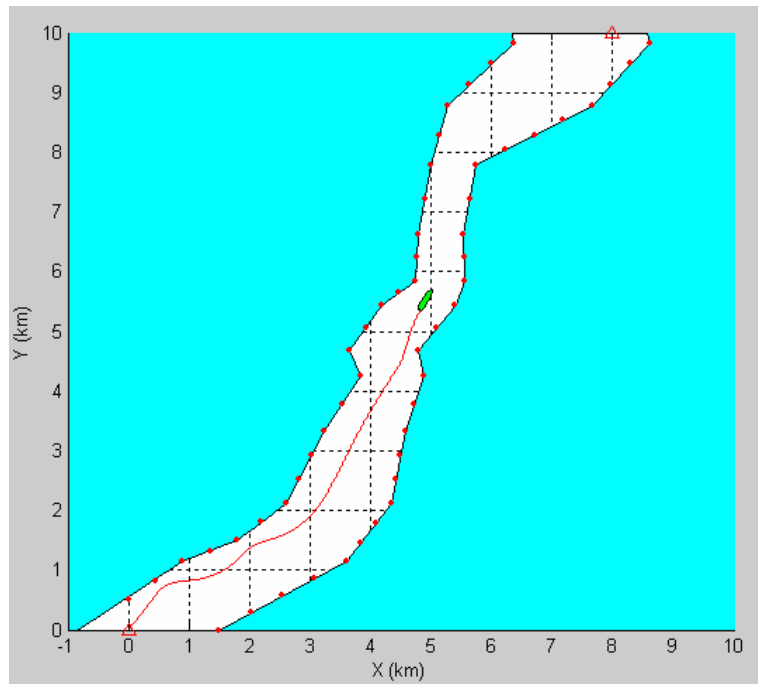

Figure 8-40: Taking on a major bend

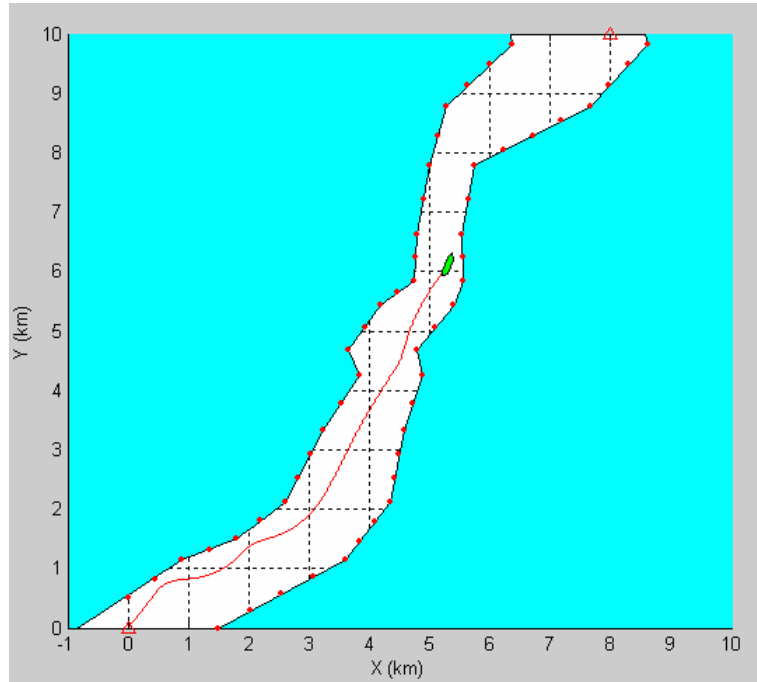

Figure 8- 41: Into the narrows having successfully negotiated the major bend

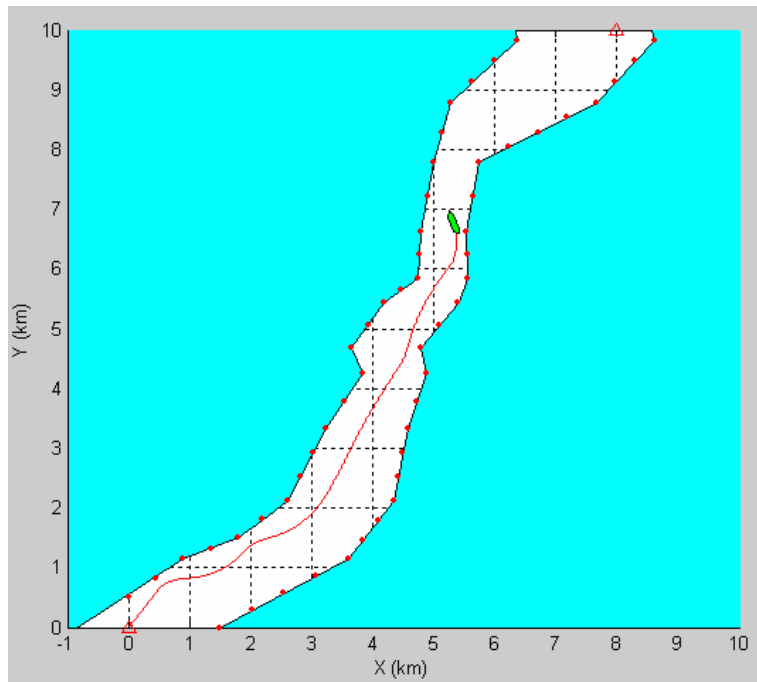

Figure 8- 42: Going through the area 2

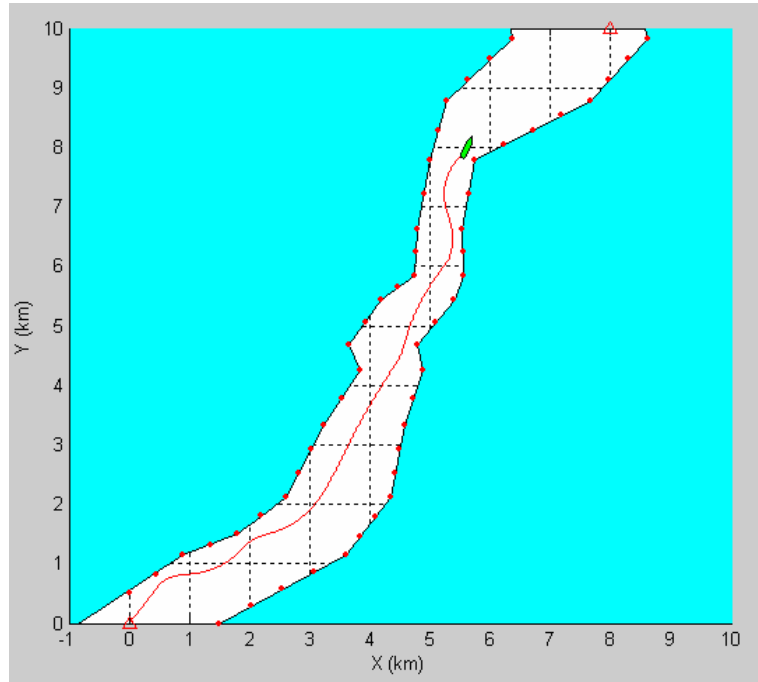

Figure 8- 43: Negotiating the last bend and out of the narrows successfully

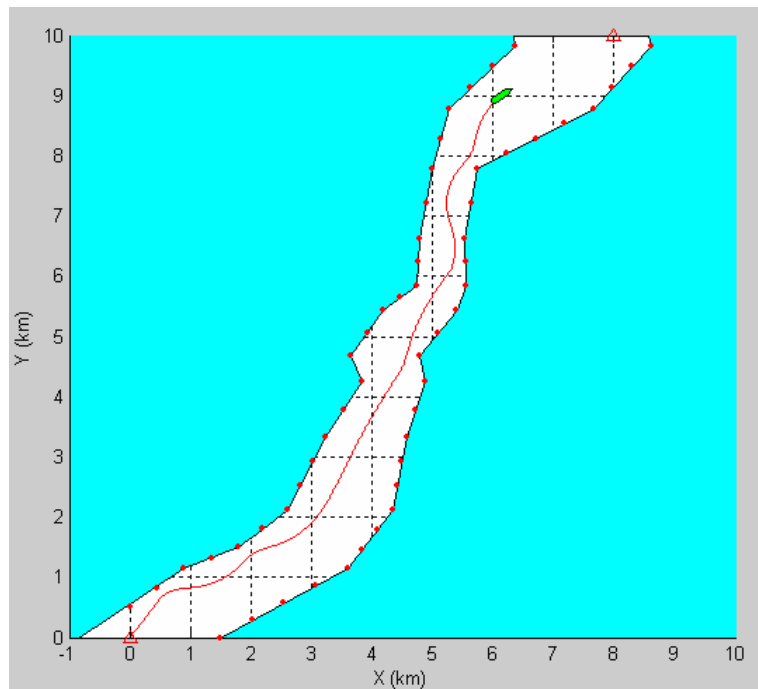

Figure 8- 44: Approaching the destination

Finally, the ship arrives at the destination safely as shown in Figure 8-45.

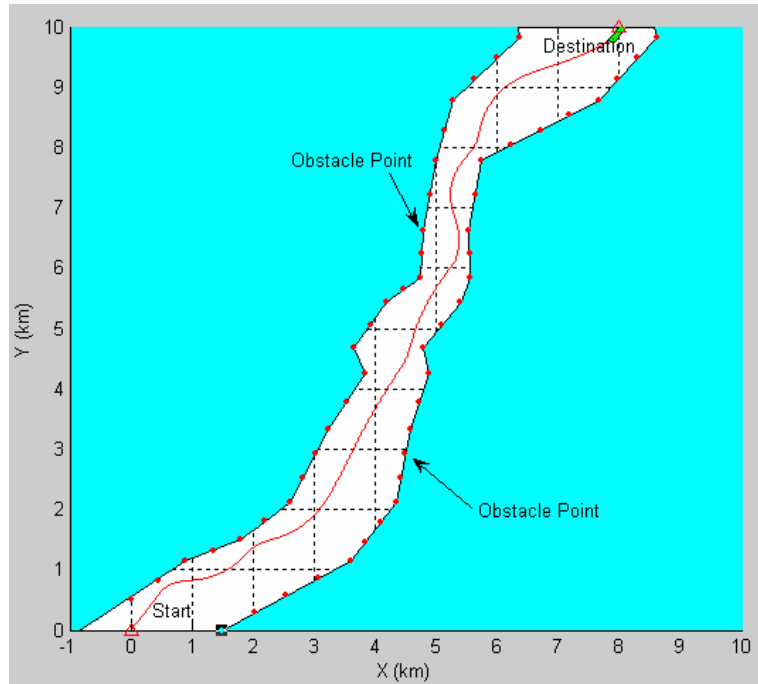

Figure 8-45: Arriving at the destination

In order to examine the apparently erratic path of the ship, the simulation results are plotted with the potential filed contour plot in Figure 8-46. This figure is enlarged for clarity in Figures 8-47 to 8-48.

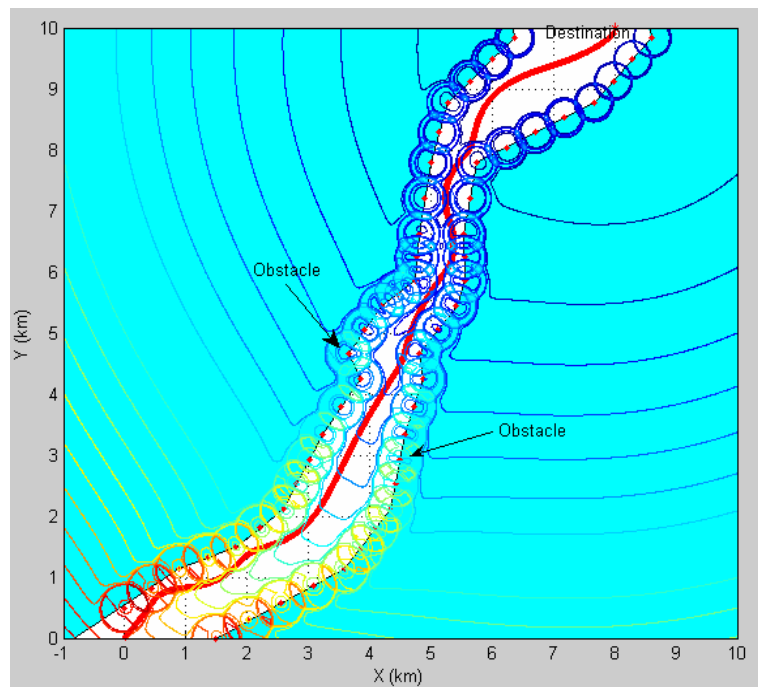

Figure 8-46: Simulation results in potential field

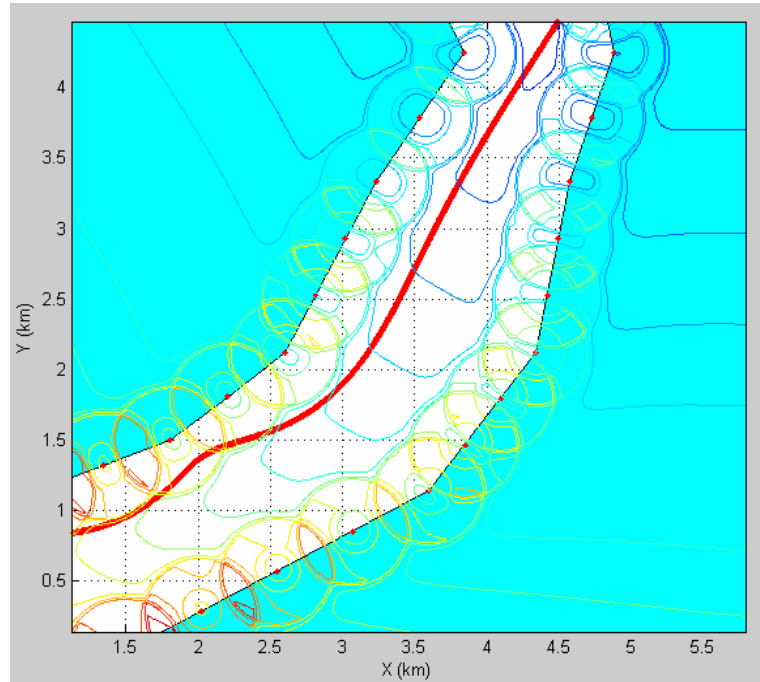

Figure 8- 47: The enlarged part (1)

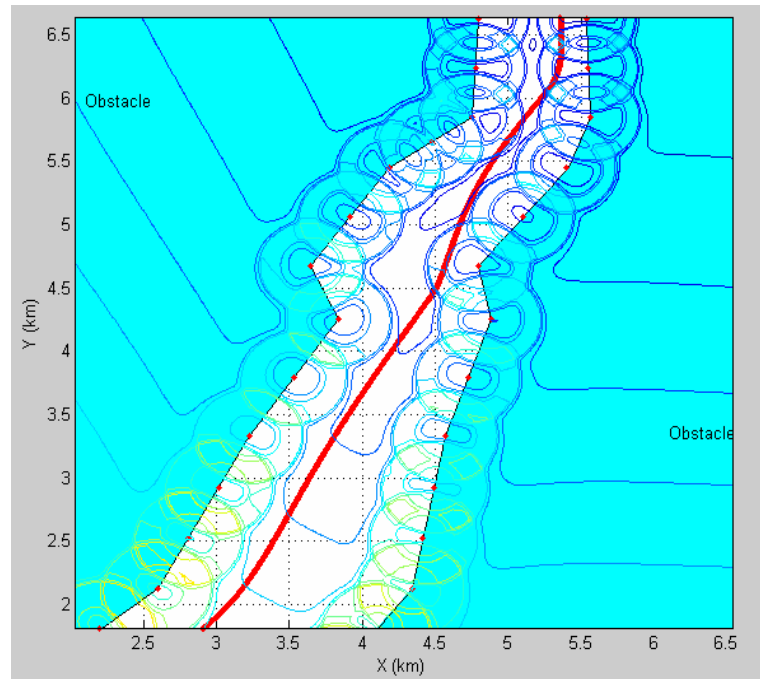

Figure 8- 48: The enlarged part (2)

It can be seen that the ship's path eventually converge to the destination as expected. It can be concluded, therefore, that the ship's sailing environment can be modeled as a potential field. The manoeuvring parameters are shown against time in Figure 8-49 and Figure 8-50.

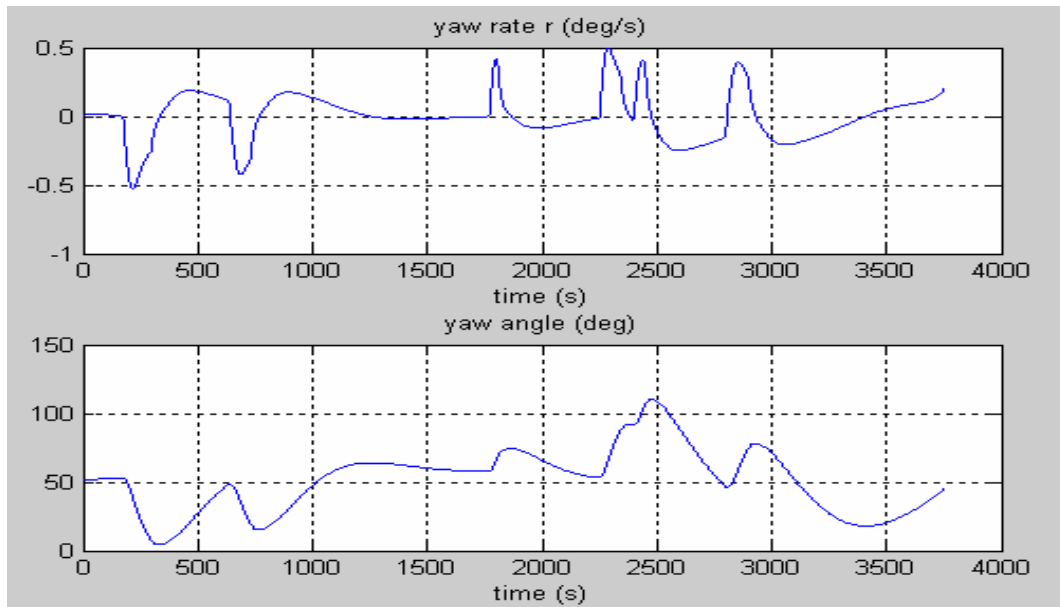

Figure 8- 49: The ship's yaw rate and yaw angle

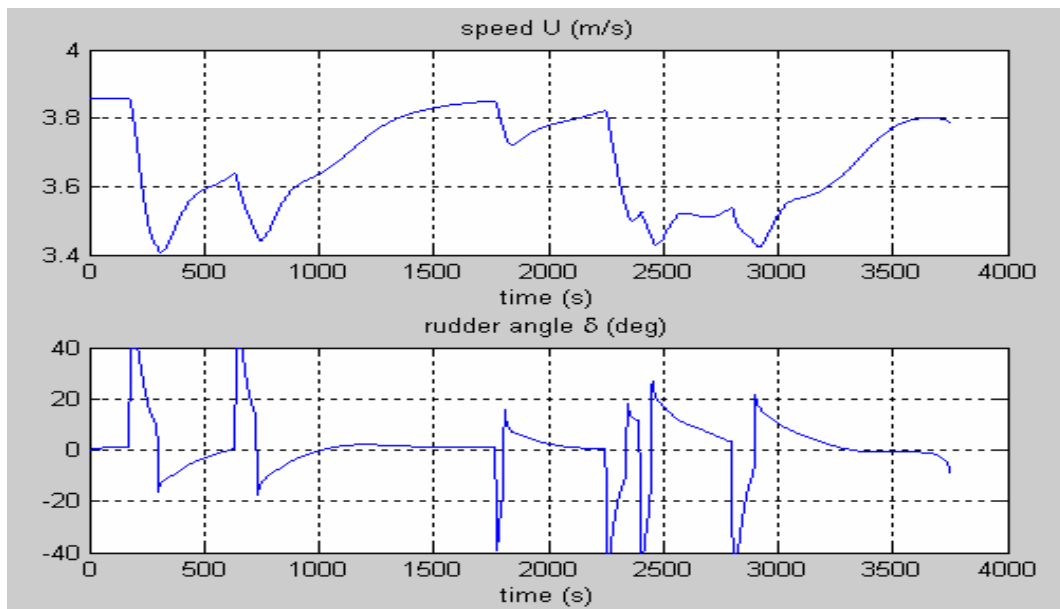

Figure 8- 50: The ship's speed and rudder angle

In practice, the navigator tends to make the ship sail along the traffic lane, so the path

of the real ship might be different from the simulation result. The main reason for this somewhat erratic route that the ship appears to take is the lack of route optimization in the algorithm used. It can be achieved to a degree by carefully selecting the coefficients and other parameters of the potential function. This is certainly one area that requires further study.

Through this case study, general steps used in realizing automatic ship navigation using potential field method have been demonstrated. The potential field approach used and the consequent simulation results demonstrate the performance and effectiveness of this method.

8.3.2 Case 2: Simulation of Navigation in Congested Areas

Navigation in waterways with high volume of traffic can be very taxing for the ship's master to deal with in some cases. Since one of the key applications for automatic ship navigation system is to help navigator to solve highly complex encounter situation in congested areas, a test case was created to examine the performance of the simulator involving six ships converging into a narrow area from all directions.

The position and speed of every ship are given in Table 8-6.

Table 8- 6: The position and speed of ships

	Start (km)	Destination (km)	Speed (m/s)
Ship A (green)	(0,0)	(45,40)	7.7
Ship B (red)	(40,0)	(3,40)	7.2
Ship C (magenta)	(45,30)	(3,20)	7.2
Ship D (blue)	(0,30)	(45,20)	7.2
Ship E (yellow)	(40,50)	(25,0)	7.7
Ship F (black)	(4,50)	(40,10)	7.2

In this case, the parameters of simulation are the same as those given in Section 8.2. The map of the bay and the parameters are input through the GUI as shown in Figure 8-51.

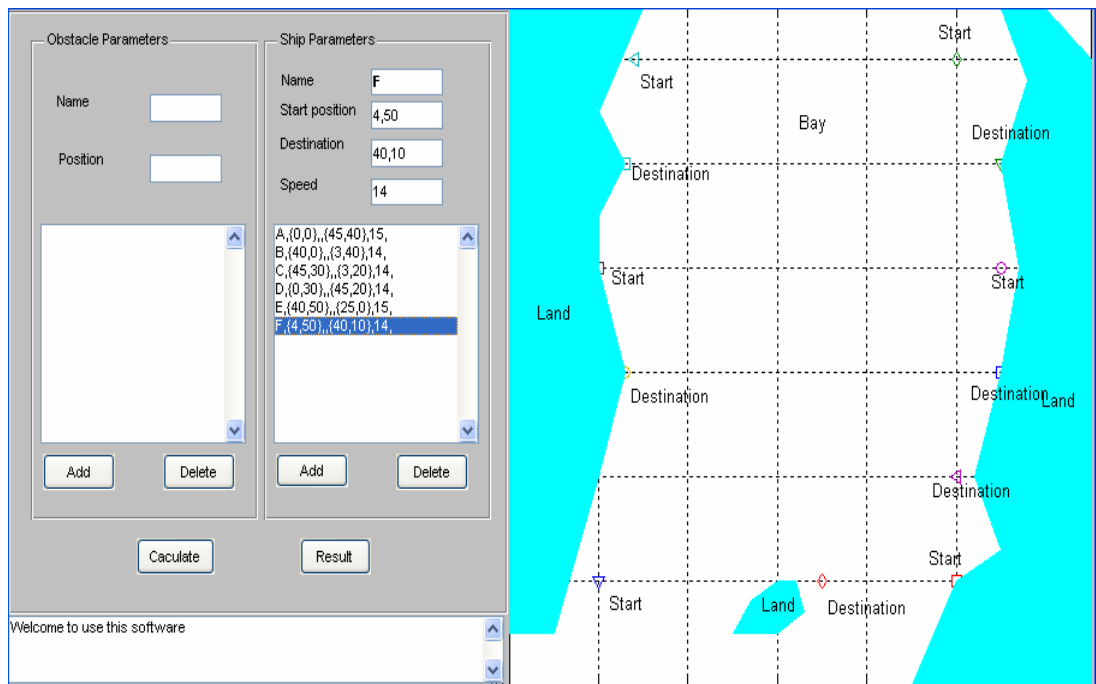

Figure 8- 51: The setting up of simulation

Major milestones of the simulation are as follows:

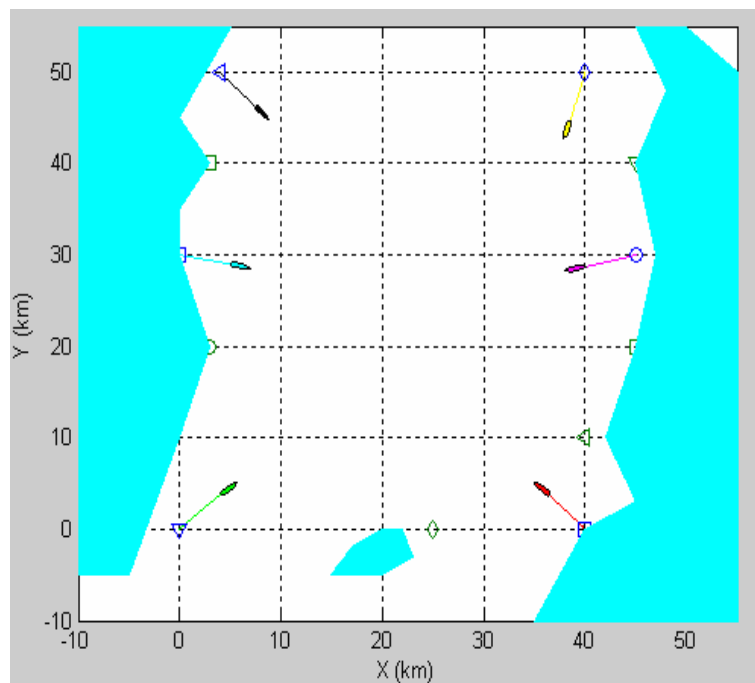

Figure 8- 52: Simulation starts

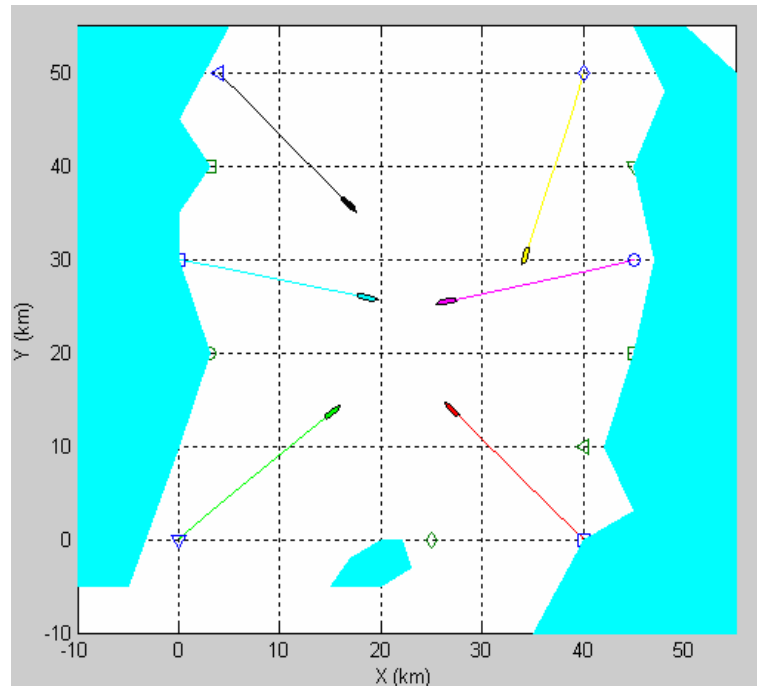

Figure 8- 53: Ships converge

An encounter situation develops as shown in Figure 8-53. The program begins to calculate the danger of collision and then automatically decides which ships should be given the priority for making avoidance manoeuvre. In Figure 8-54, ship D (blue) and ship C (magenta) are going to enter into an encounter situation first, so they are given the priority. According to the navigation rule, ship D and ship C should both turn to starboard as shown in Figure 8-55.

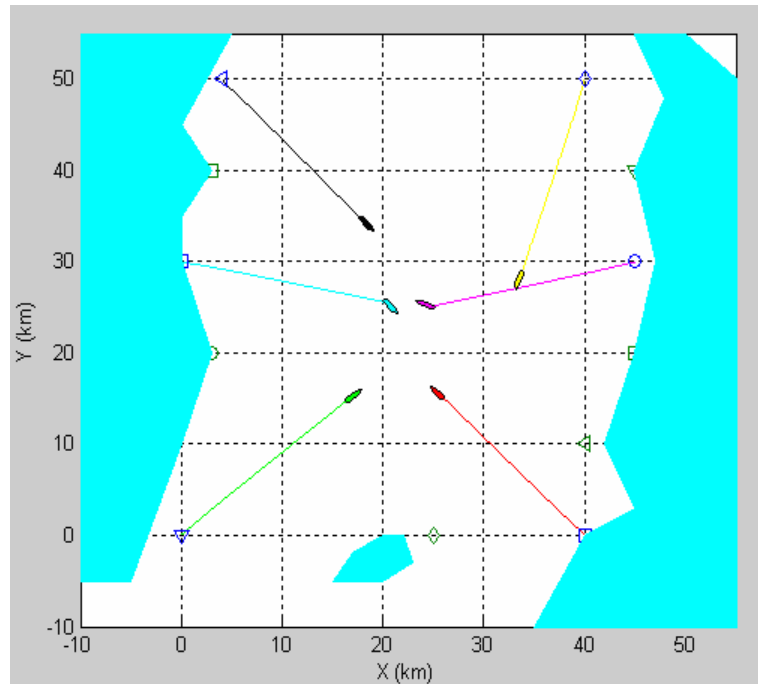

Figure 8- 54: Ship C and ship D start taking avoidance action (1)

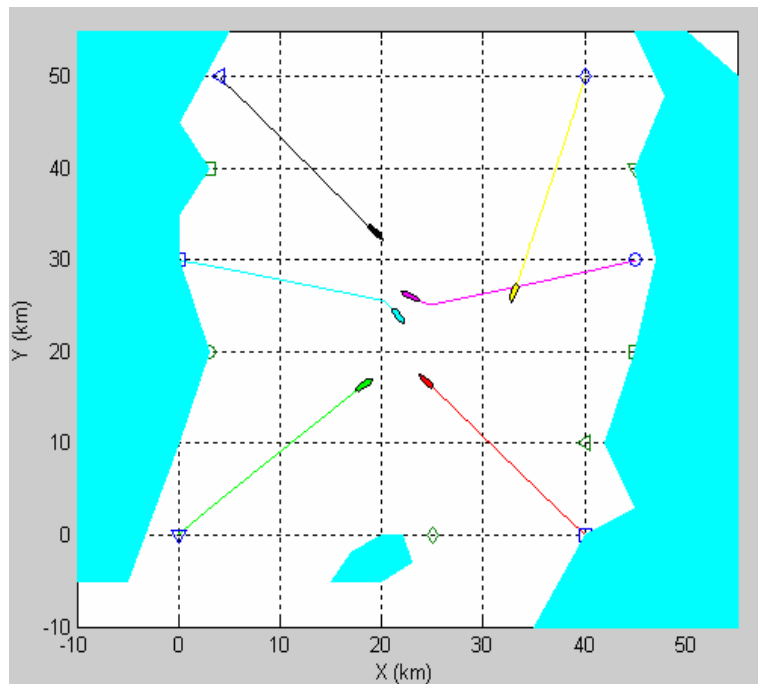

Figure 8- 55: Ship C and ship D take avoidance action (2)

Figure 8-56 shows that ship D and ship C have successfully negotiated the situation.

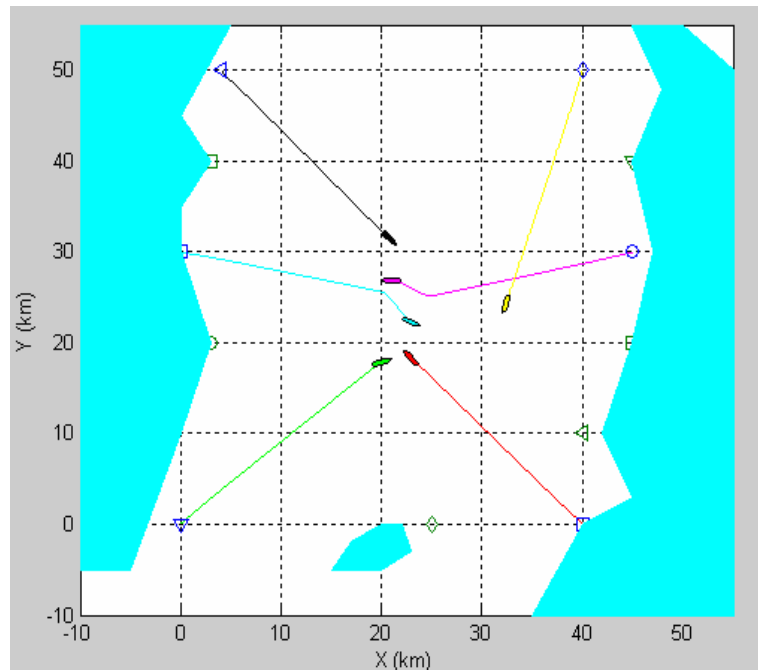

Figure 8- 56: Ship C and ship D avoid collision (3)

Meanwhile, the system detects a risk of collision between ship A (green) and ship B (red). This is a crossing situation and, therefore, ship A gets the order to change its course to starboard in order to avoid collision with ship B.

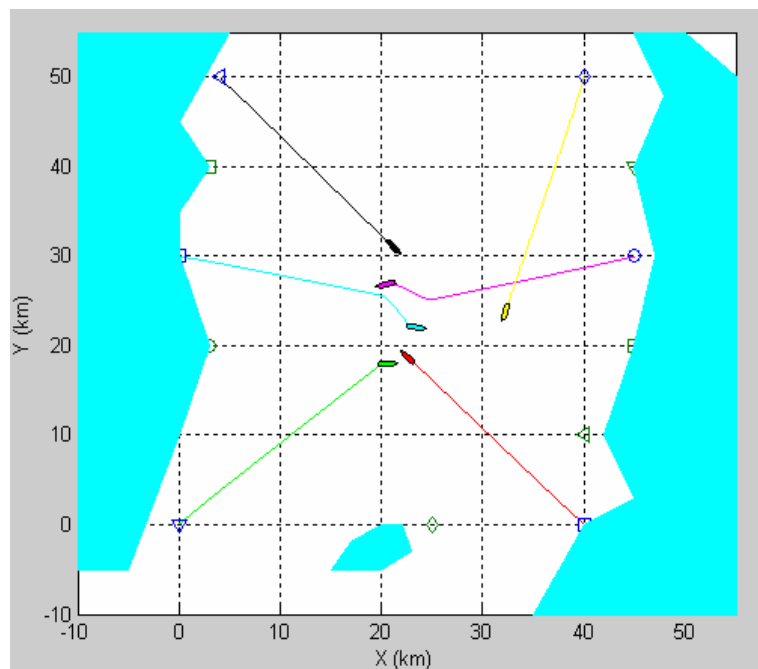

Figure 8- 57: Ship A changes its course

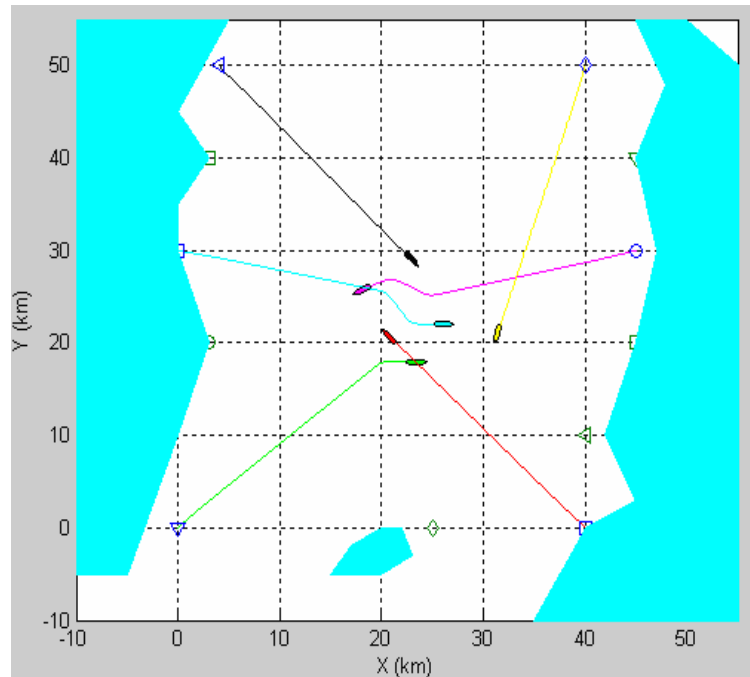

Figure 8- 58: Ship A avoids collision with ship B

Having negotiated this situation, ship A continues to its destination. Then a new encounter situation develops between ship A and ship F (black). According to the COLREGS, in this situation, ship A is the stand-on ship and therefore it maintains its course. Ship F is the give-way ship and it turns starboard to avoid ship A.

Figures 8-59, 8-60 and 8-61 show the whole process.

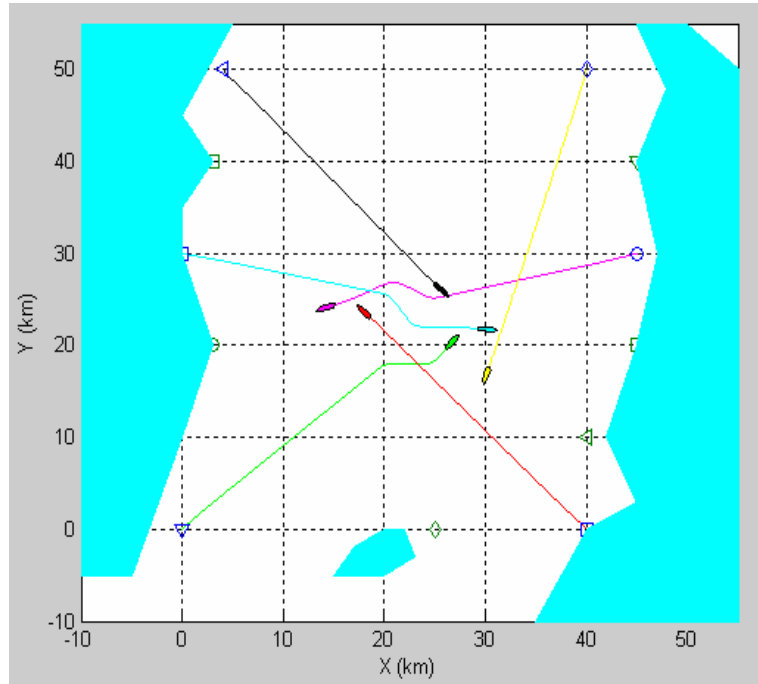

Figure 8- 59: Ship F avoids collision with ship A

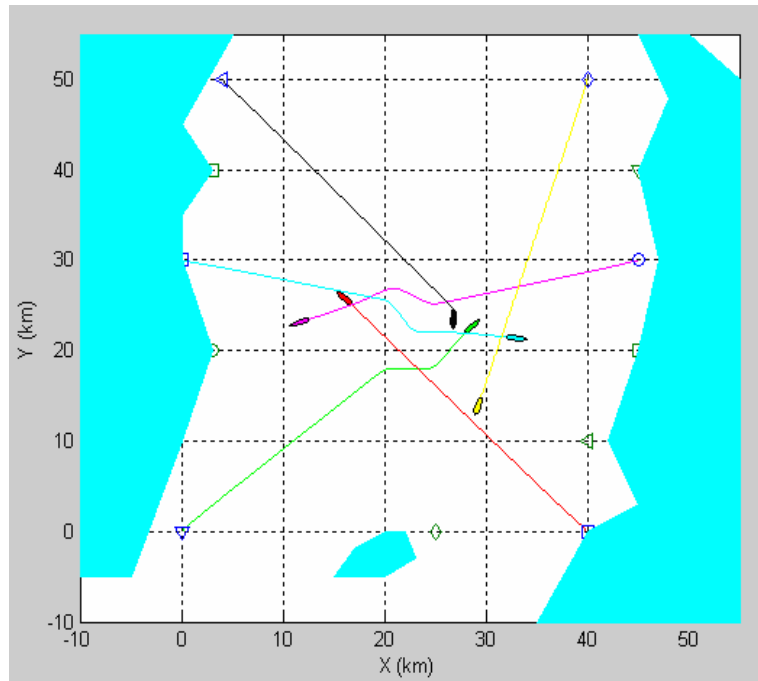

Figure 8- 60: Ship F changes its course

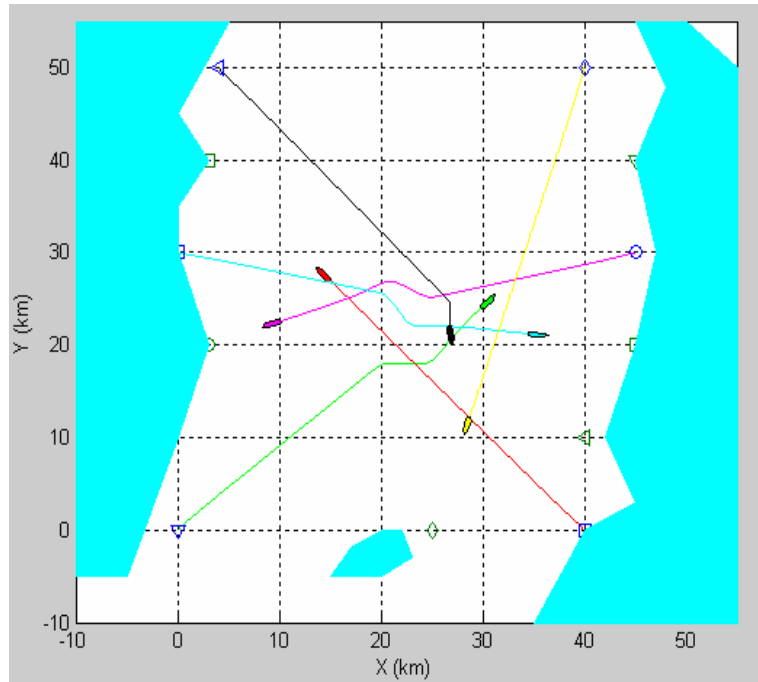

Figure 8- 61: Ship F successfully negotiates the situation

From then on no collision danger is detected by the system and every ship maintains its course and sails to its destination. Finally, every ship arrives at its destination as shown in Figure 8-62.

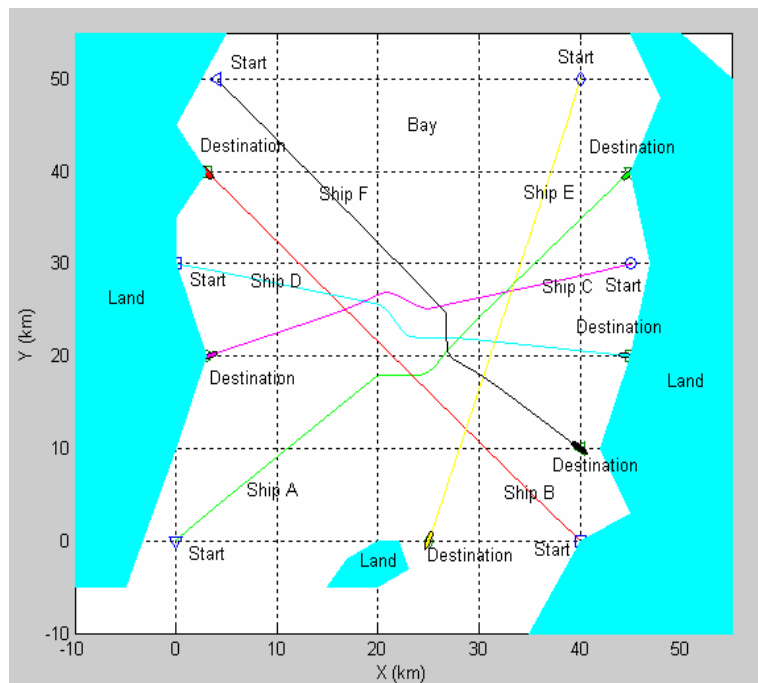

Figure 8- 62: Every ship arrives at destination

The key manoeuvring parameters of every ship are shown against time in Figures 8-63 to 8-68.

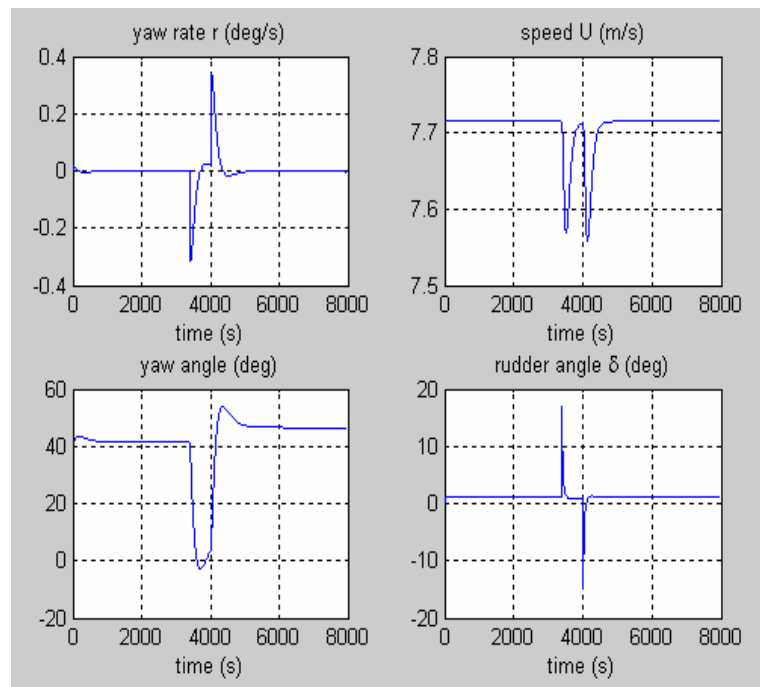

Figure 8- 63: Ship A's yaw rate, yaw angle, speed and rudder angle

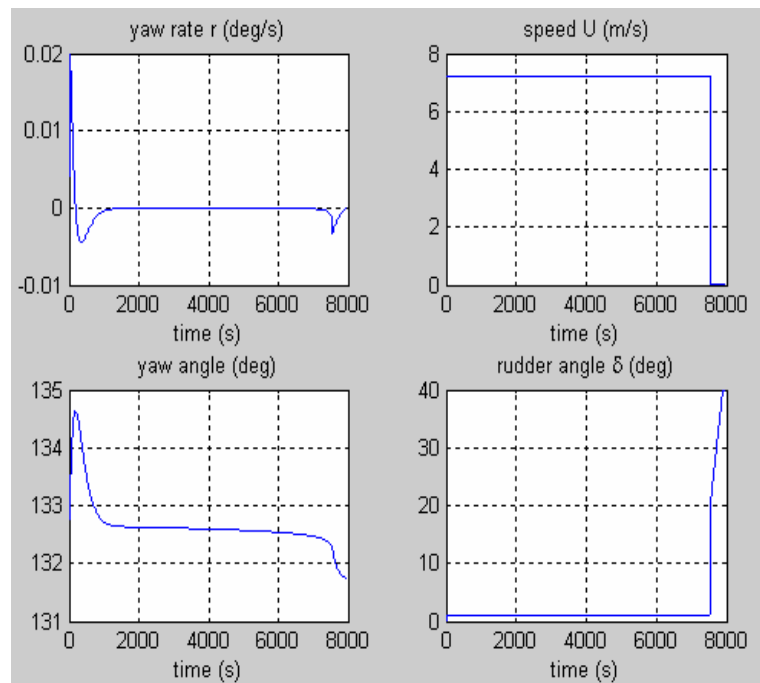

Figure 8- 64: Ship B's yaw rate, yaw angle, speed and rudder angle

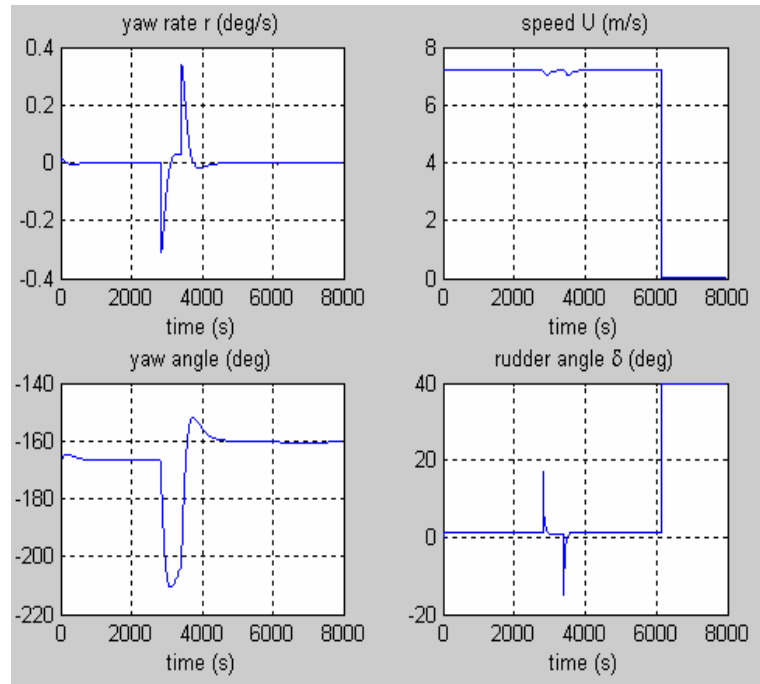

Figure 8- 65: Ship C's yaw rate, yaw angle, speed and rudder angle

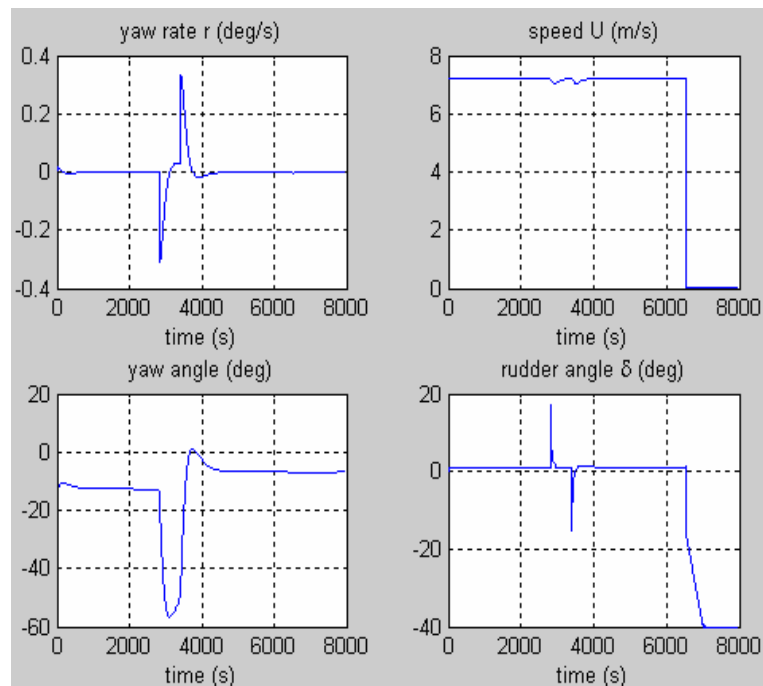

Figure 8- 66: Ship D's yaw rate, yaw angle, speed and rudder angle

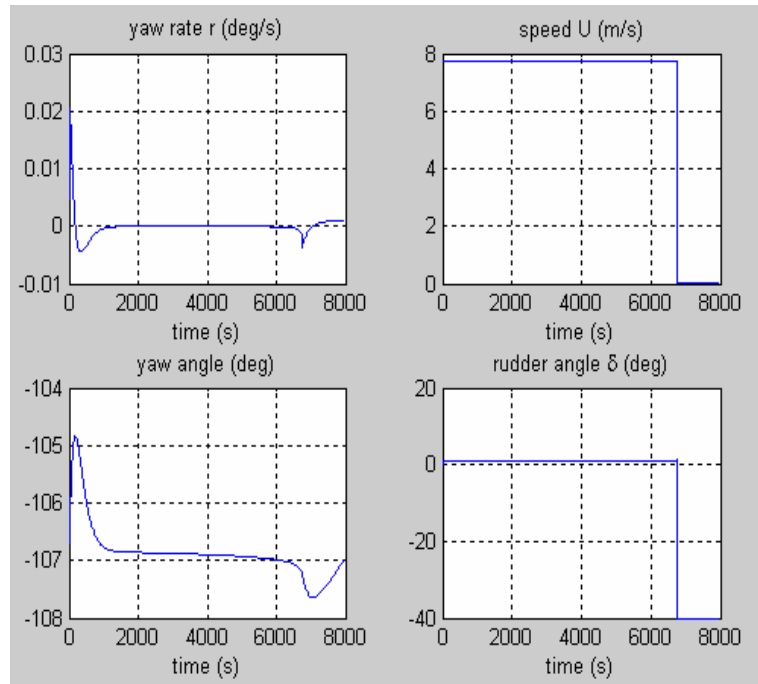

Figure 8- 67: Ship E's yaw rate, yaw angle, speed and rudder angle

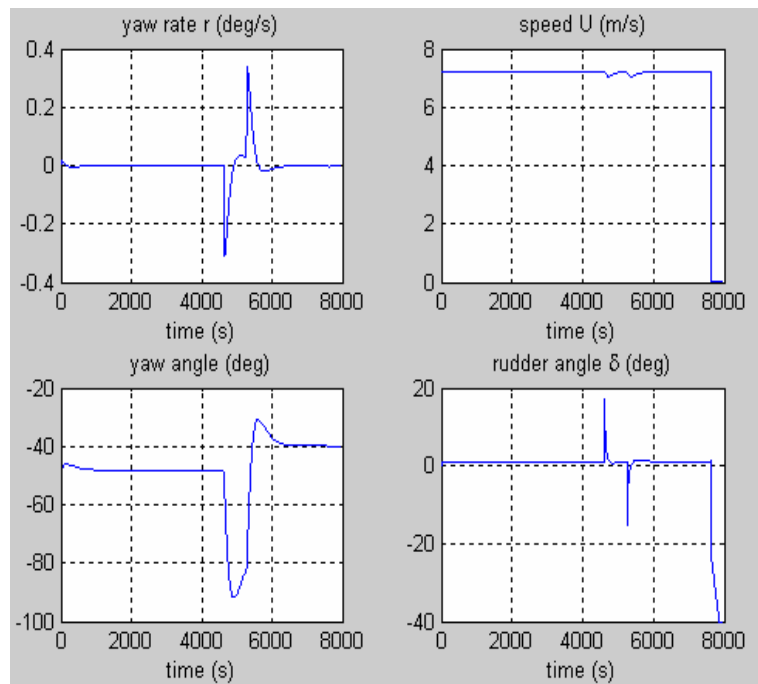

Figure 8- 68: Ship F's yaw rate, yaw angle, speed and rudder angle

From this case, it can be seen that the system is capable of automatically piloting all the ships safely through a complex encounter situation which can easily develop into a disastrous multiple collision situation. It may be possible to manufacture more complex, even impossible, situations. However, the case studied above is thought to be extreme enough, as measures will be taken long before such a situation develops.

8.3.3 Case 3: Special Cases

In this section, some special cases are presented to verify the effectiveness of the developed algorithm in some emergency situations.

In real navigation, the emergency situations can arise due to the following [Szlupczynski, 2009]:

- an error in estimation of expected relative positions of the ships involved,
- the strange ship is detected too late,
- the strange ship disregards COLREGS and alters its course or speed unexpectedly.

With the enhancement of navigational aids, such as ARPA, the first of the three factors mentioned above is becoming rarer. Therefore, only the last two factors are studied here.

(1) Special Case 1

The position and speed of ships are given in Table 8-7.

Table 8- 7: The position and speed of ships

	Start (km)	Destination (km)	Speed (m/s)
Ship A (green)	(0,-5)	(40,40)	9.8
Ship B (red)	(50,10)	(0,40)	8.7
Ship C (blue)	(0,40)	(50,10)	8.7

The progress of simulation can be described as follows:

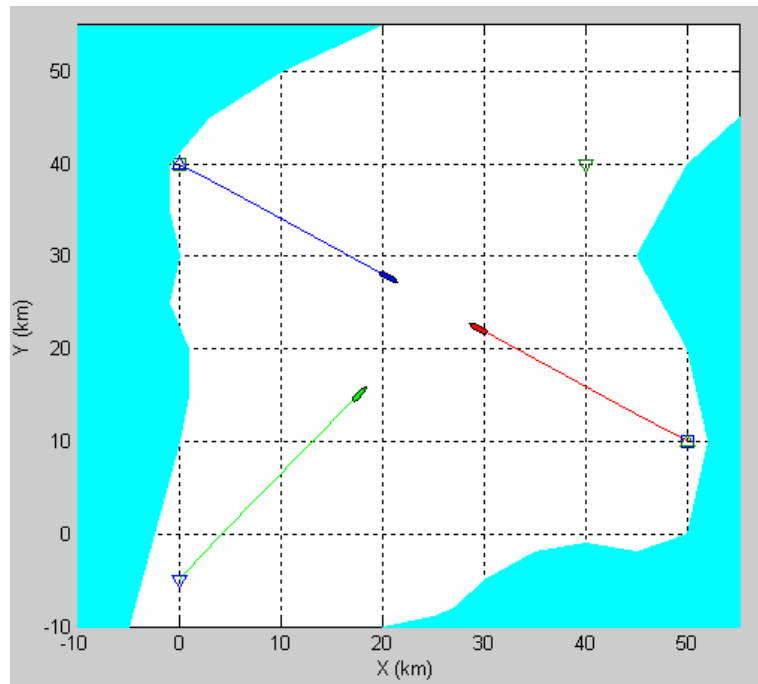

Figure 8- 69: Normal simulation case 1 (1)

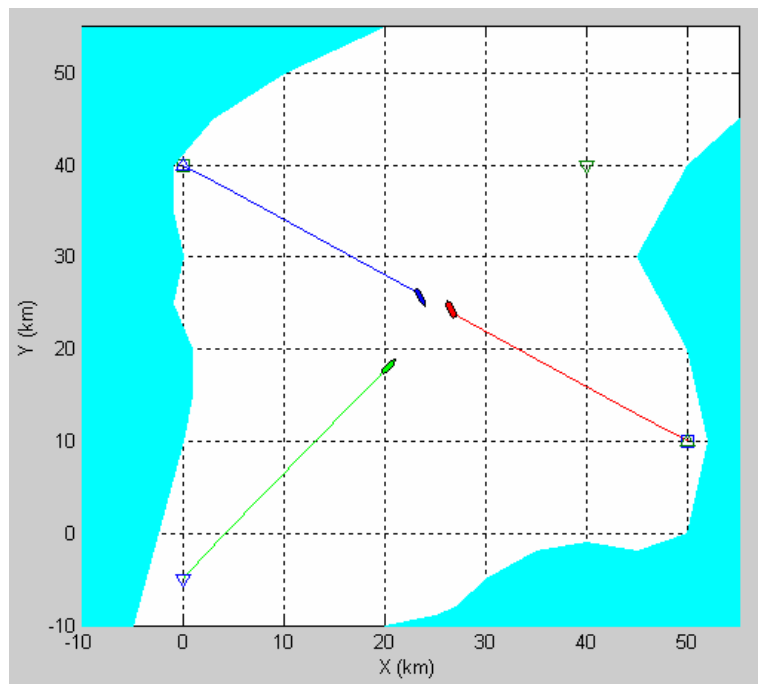

Figure 8- 70: Normal simulation case 1 (2)

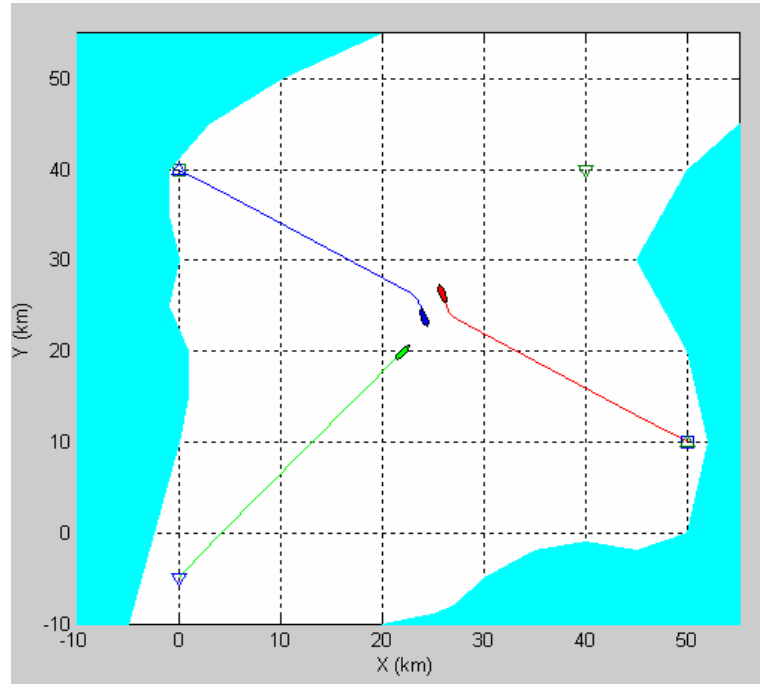

Figure 8- 71: Normal simulation case 1 (3)

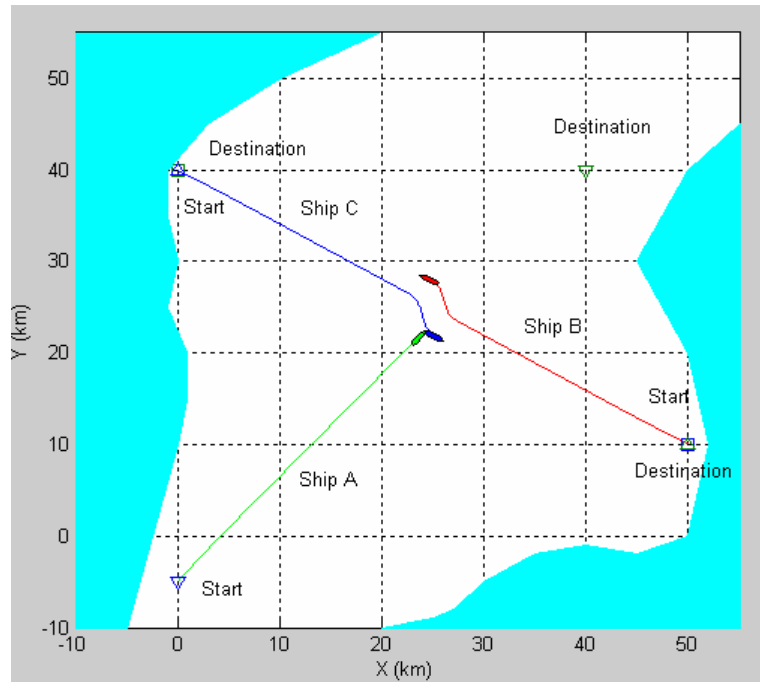

Figure 8- 72: Normal simulation case 1 (4)

Ships B and C take action to avoid collision first according to the strategy of mentioned in Chapter 6 as shown in Figure 8-70. However, as Ship C turns starboard to avoid Ship B, an emergency situation arises between Ship C and Ship A as shown in Figure 8-71. According to the COLREGS, Ship A is the stand-on ship and Ship C is the give-way ship. Ship C should take action to avoid Ship A. However, there is insufficient time for Ship C to change its heading. If no other avoiding action is taken, an accident is inevitable as shown in Figure 8-72.

According to COLREGS 17 and the practical operational experience as mentioned in Chapter 6: (a) when it becomes apparent that the give-way vessel is not taking appropriate action in compliance with the rules, the stand-on vessel is permitted to take action to avoid collision by its manoeuvre alone; (b) when the give-way vessel alone cannot avoid collision, the stand-on vessel is required to act as best it can to avoid collision. So in this situation the stand-on ship (Ship A) will have to take action to avoid collision according to the practical operational experience [Li & Wang, 1983]. To achieve this, the program was modified and the limit distance (in this thesis, this value is 1.5 km) was used to detect special cases of this kind. When the distance between two ships is less than 1.5 km and there exists a risk of collision, the program identifies this as an emergency situation. Then the program orders the stand-on ship to take action to avoid collision and the give-way ship to keep its course and speed. The simulation results can be seen in Figures 8-74 and 8-75.

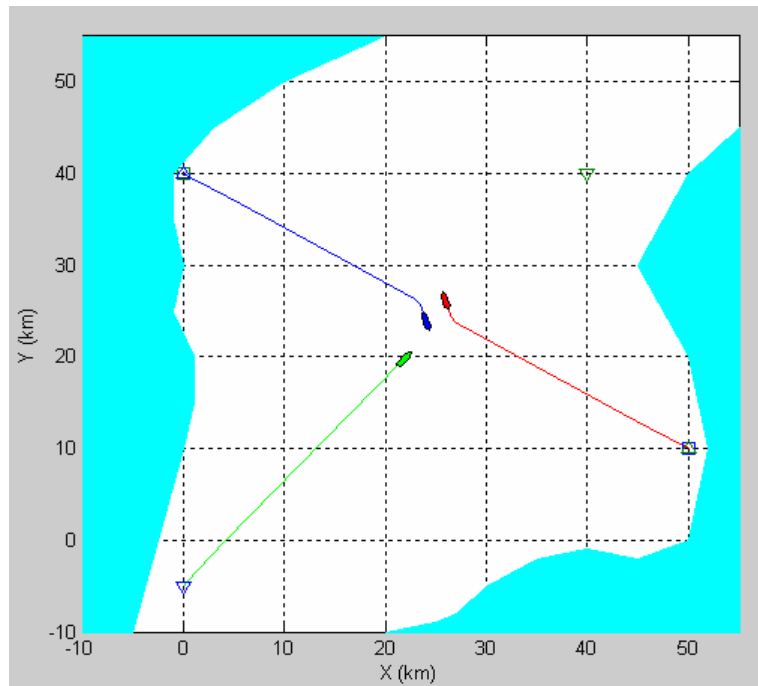

Figure 8- 73: The solution of special case 1 (1)

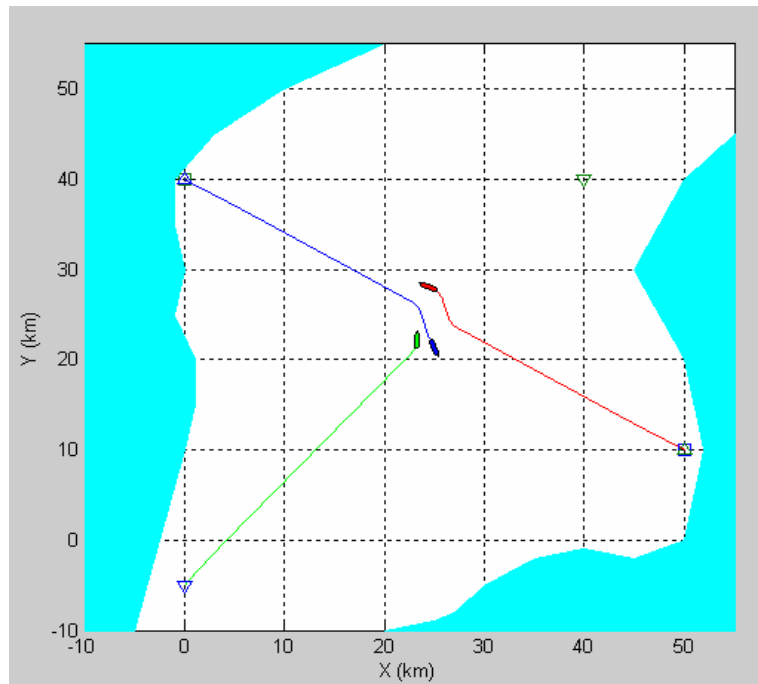

Figure 8- 74: The solution of special case 1 (2)

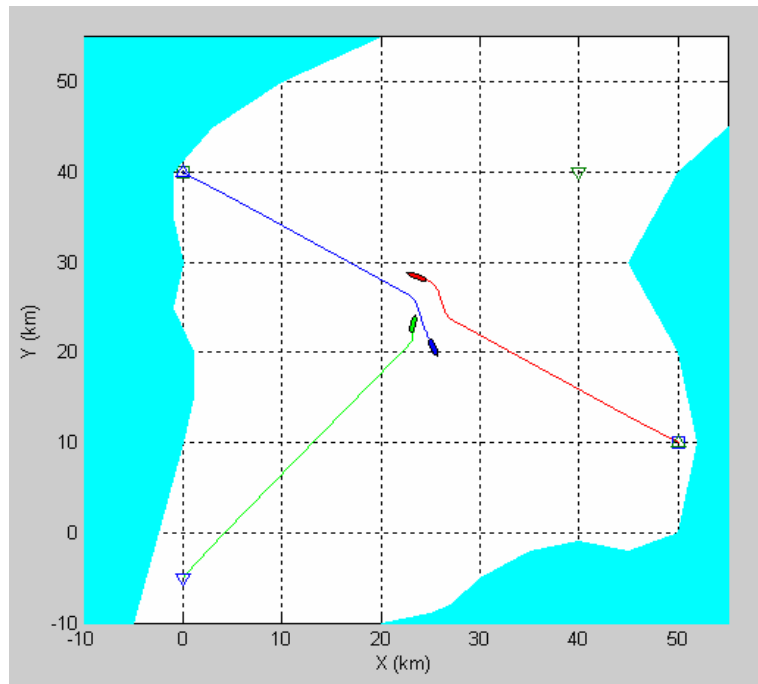

Figure 8- 75: The solution of special case 1 (3)

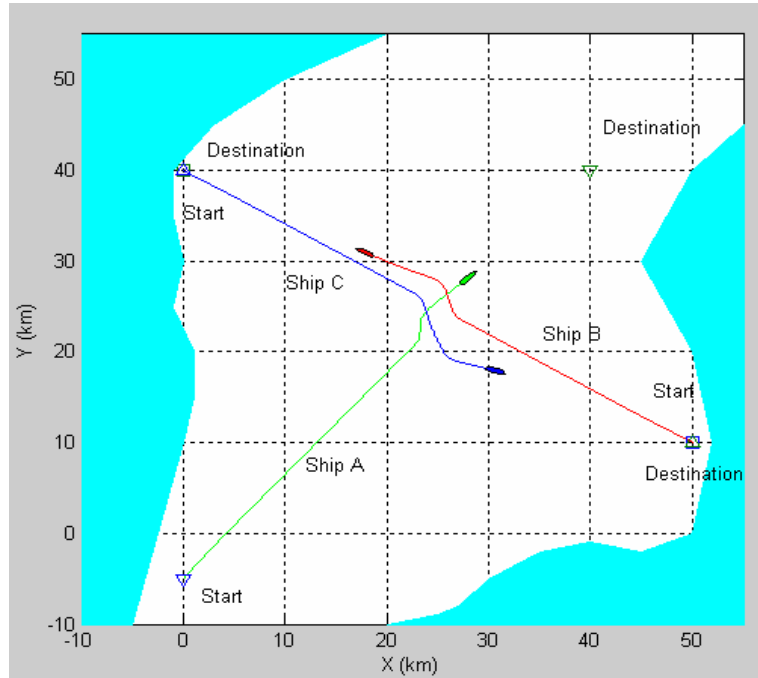

Figure 8- 76: The solution of special case 1 (4)

(2) Special Case 2

Even though it has been assumed that all ships will adhere to the provisions of COLREGS, there will be occasions in real life when a ship, knowingly or by mistake, takes a manoeuvre contravening the rules. This kind of emergencies will not occur in the current simulation program, as all ships are programmed to act within the bounds of the rules. Nevertheless, this case has been studied to ensure that the program is capable of dealing with such extraordinary situation.

The position and speed of ships are given in Table 8-8.

Table 8- 8: The position and speed of ships

	Start (km)	Destination (km)	Speed (m/s)
Ship A (green)	(0,0)	(50,45)	7.7
Ship B (red)	(45,0)	(10,50)	8.7
Ship C (blue)	(0,40)	(50,10)	8.7

If the ships comply with COLREGS, the safe navigation would be as seen in Figure 8-77 and Figure 8-78.

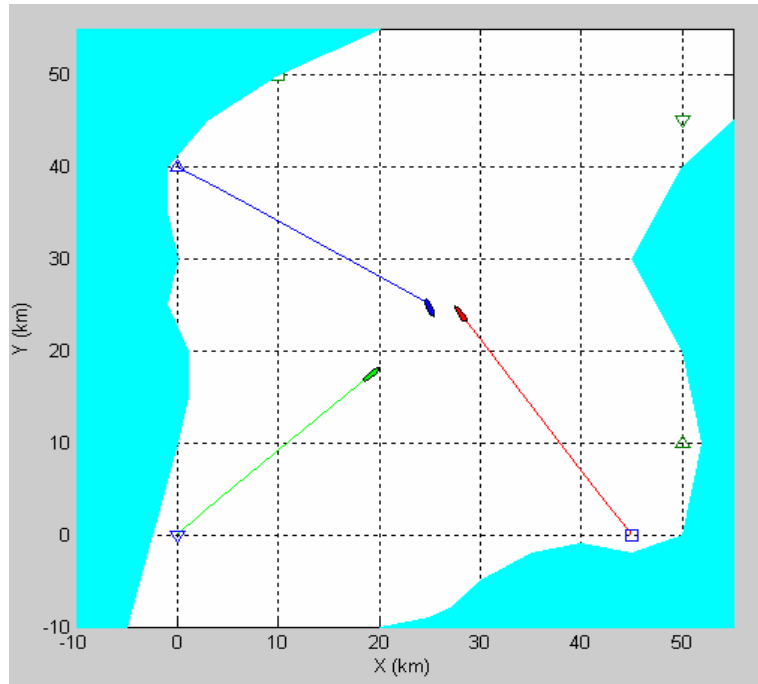

Figure 8- 77: Normal simulation case 2 (1)

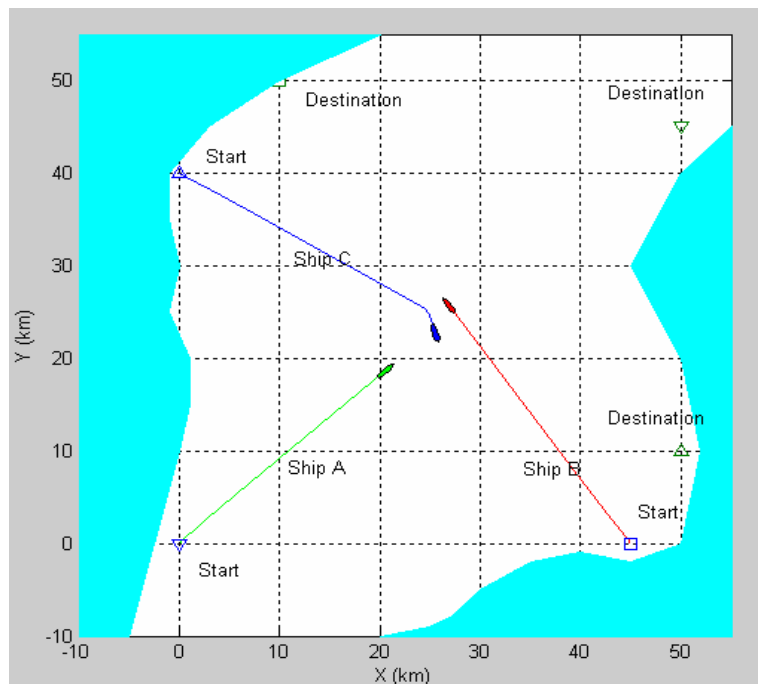

Figure 8- 78: Normal simulation case 2 (2)

In Figure 8-78, Ship B is crossing ship C, and according to COLREGS Ship C is the give-way ship and Ship B is the stand-on ship. Thus, Ship C should turn starboard. However, if Ship C turns to port instead, then an accident will occur as shown in

Figure 8-80.

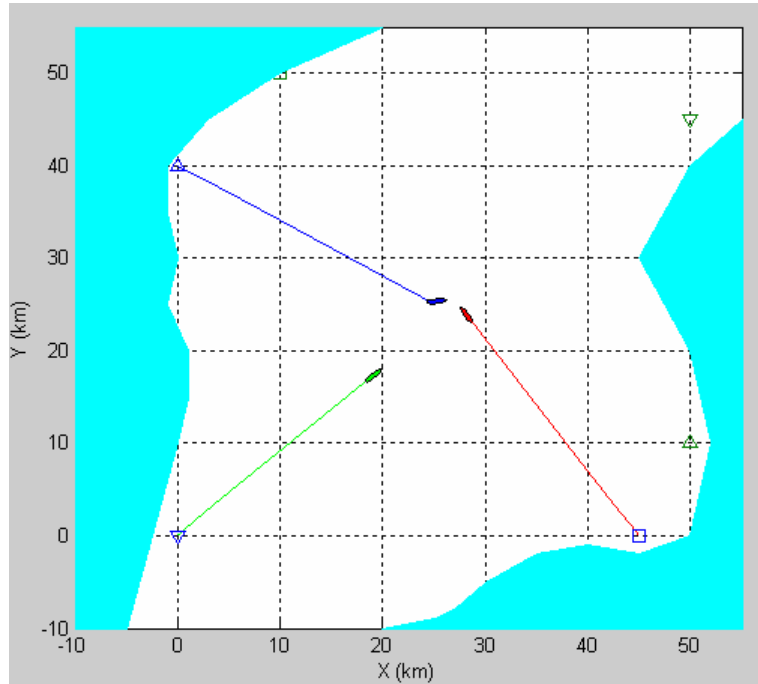

Figure 8- 79: Normal simulation case 2 (3)

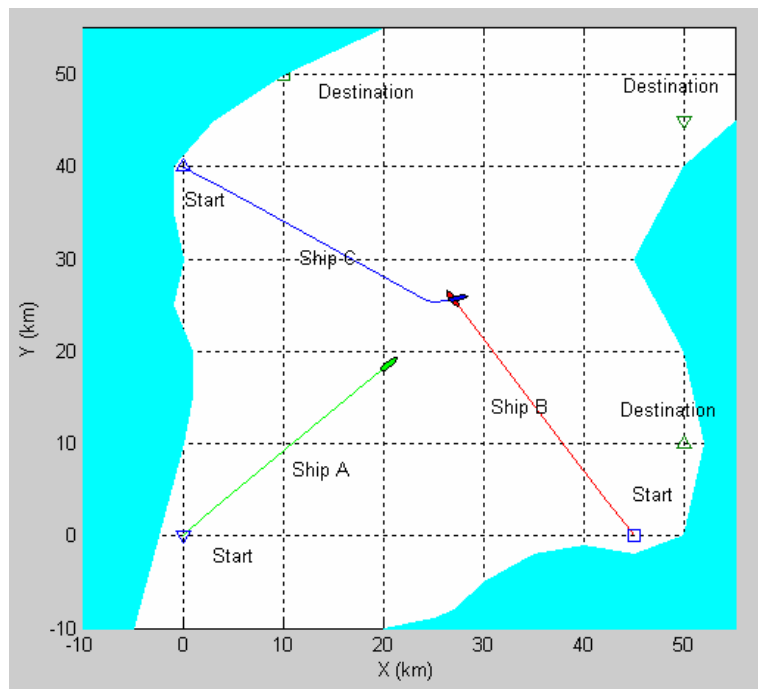

Figure 8- 80: Normal simulation case 2 (4)

To deal with this kind of emergency situation, the same strategy as taken for the first special case is applied as shown in Figures 8-81 and 8-82.

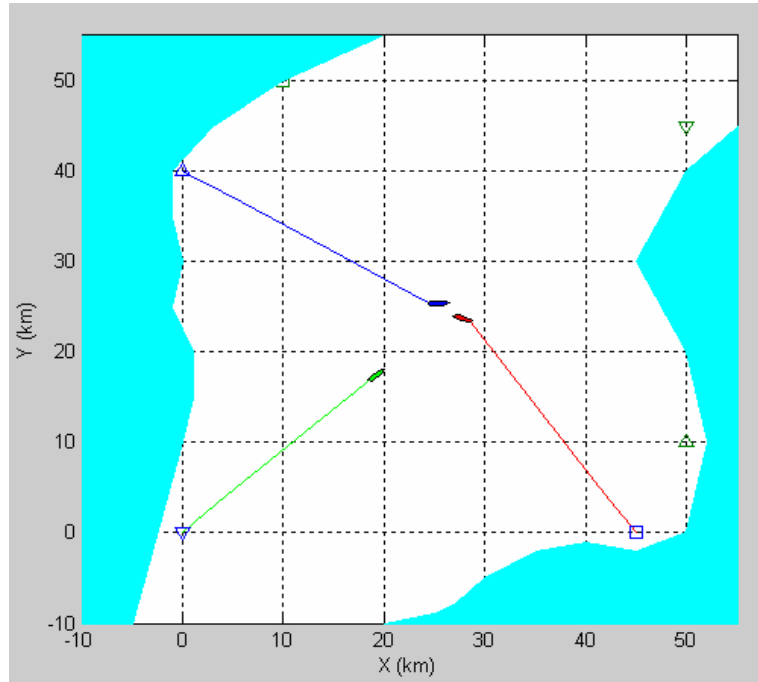

Figure 8- 81: The solution of special case 2 (1)

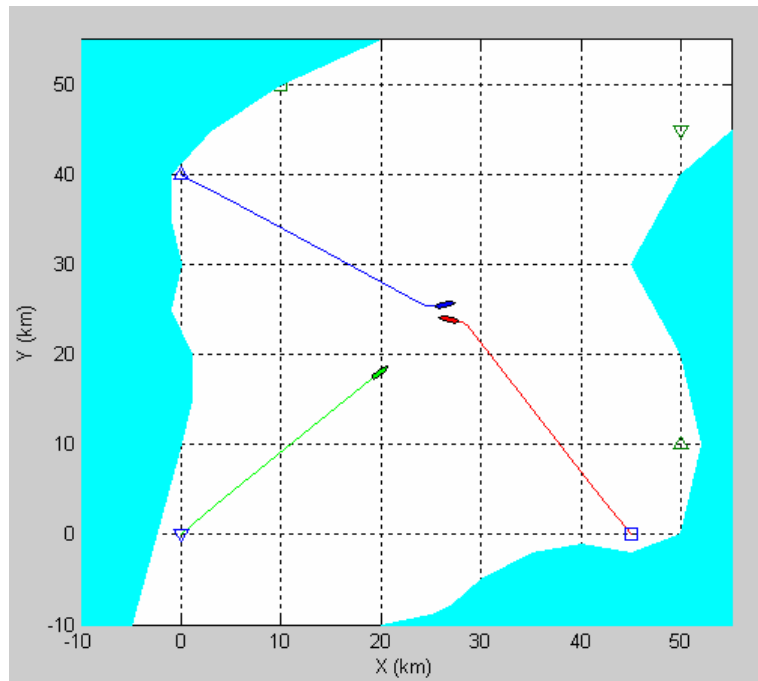

Figure 8- 82: The solution of special case 2 (2)

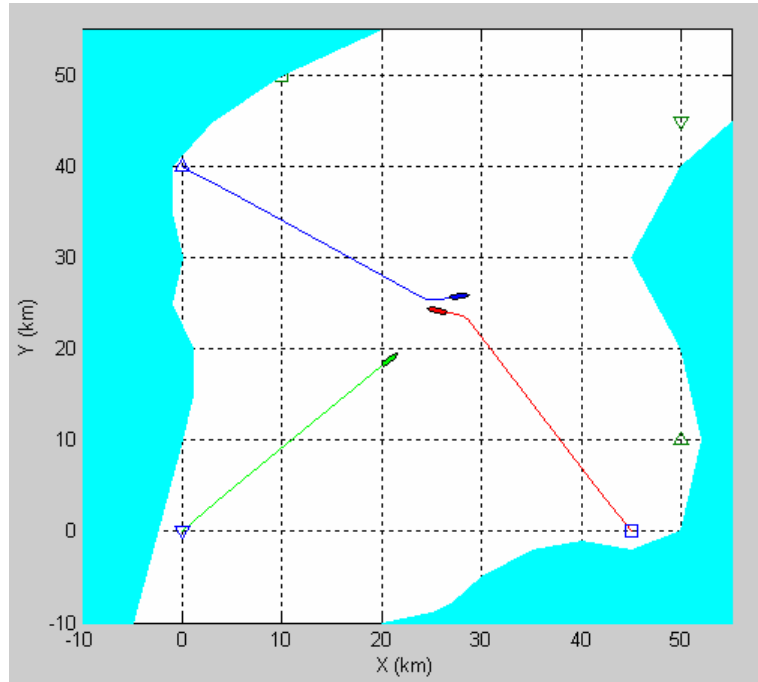

Figure 8- 83: The solution of special case 2 (3)

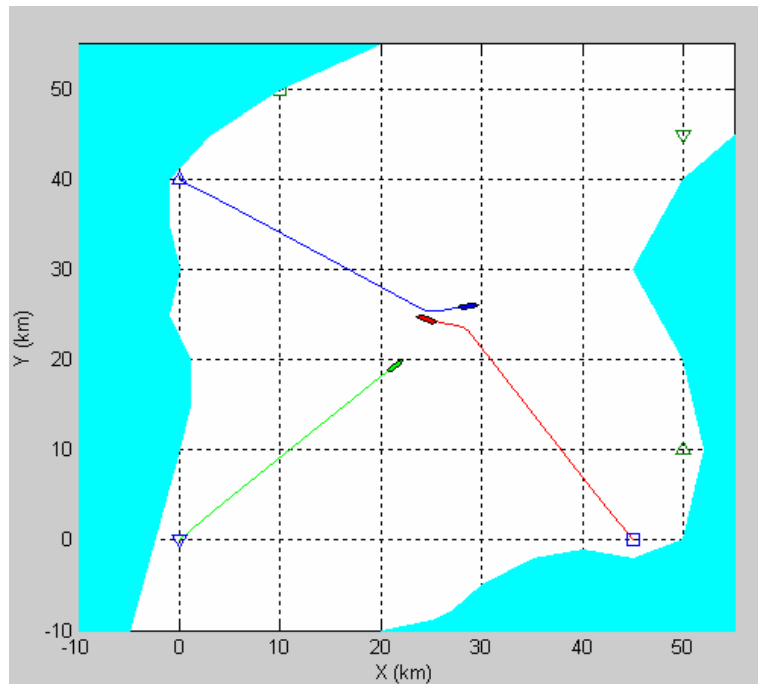

Figure 8- 84: The solution of special case 2 (4)

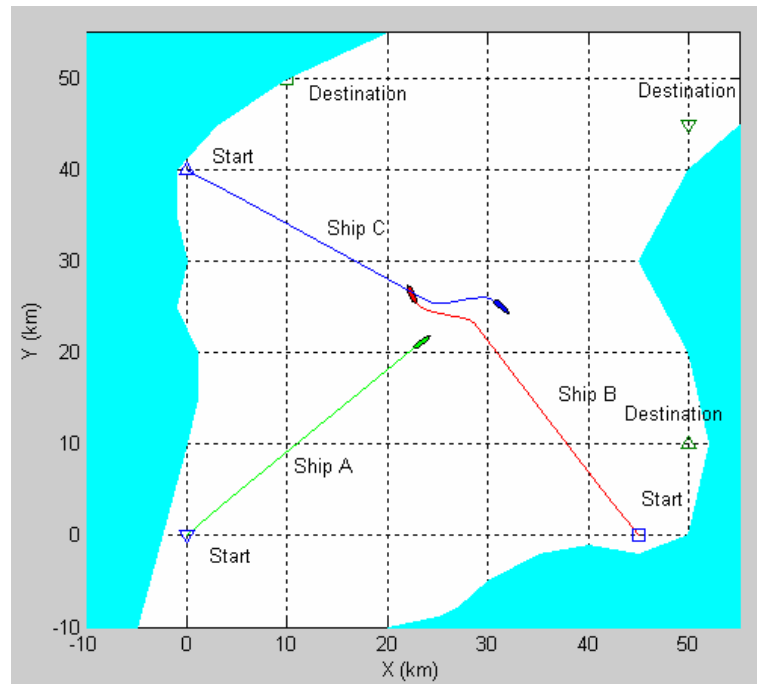

Figure 8- 85: The solution of special case 2 (5)

From the above two cases, we can see that the current simulation program is capable of achieving collision avoidance in some emergency situations. As mentioned in Chapter 6, for some extreme emergency situations where collision cannot be avoided by changing heading alone, the method of reducing speed should be considered. However, such emergencies only occur when appropriate preventive action is not taken well in advance. Hence, in the current work we didn't consider that kind of emergency situations.

8.4 Summary

In this chapter, the simulation tool developed was applied to a number of cases in order to demonstrate its ability. The system is seen to be perfectly capable of dealing with the situations given. It is, of course, possible to think of more complicated scenarios, but it is thought that some of the cases tested here are of sufficient complexity representing some extreme situations unlikely to be encountered in real life.

Chapter 9:

Discussion

9.1 Introduction

The motivation behind the work presented in this thesis is to develop an automatic ship navigation simulation to provide intelligent decision-making support for ship operation and port design. This has been achieved by proposing a simple and practical method of automatic trajectory planning and collision avoidance based on artificial potential field. A series of simulation tests have been conducted to demonstrate the effectiveness of the developed method. The simulation results produced by the software show that it can guide all the ships appearing in the simulation to their destinations and deal with any encounter situations in accordance with the COLREGS.

9.2 Strengths and Weaknesses of the System

From the simulation it is possible to obtain time history of various factors, such action taken for collision avoidance, operation time, ship's trajectory and so on. These data and results can help operators judge the correctness of collision avoidance manoeuvre and the navigational safety achieved. Using this system, it is possible to carry out automatic simulation of ship operation and to provide an effective support to operator's decision-making thus alleviating their burden on decision-making. The strengths and weaknesses of this system are discussed as follows.

9.2.1 Strengths

The main purposes of the automatic ship manoeuvring simulation are to assist ship navigators in their decision-making process to avoid collision and to assist planners and designers by allowing a large number of autonomous simulation studies to be carried out. The simulation results demonstrate the effectiveness of the developed system. The strengths of the developed system are summarized as below.

1. Problem-solving Ability for Collision Avoidance

The collision avoidance problem-solving ability can be defined as the ability to ensure that no collision will happen during ship navigation and the collision avoidance action is reasonable and can abide by collision regulations [Yang, C., 2000]. In this system, the potential field method is used to achieve automatic route finding. The system was seen to be able to cope with complex situations competently even with no alteration to the speed of any of the ships involved in all the scenarios tested, some of which are quite extreme and unlikely to be encountered in real life. The COLREGS rules are referenced through this work, since they are essential for collision avoidance. From simulation results shown in Chapter 8, it can be seen that the actions of the collision avoidance are reasonable and in accordance with COLREGS. Therefore, it can be said that the developed automatic ship navigation system possesses sophisticated problem-solving ability for collision avoidance.

2. Intelligent Decision-making Support Ability

Although the system was originally conceived and developed for automatic simulation of ship navigation in congested waterways, it can be used for a tool for decision-making support. In this system, the operators just need to know the ship's start position, destination position, velocity and the positions of the obstacles, all of which are readily available. The strange ships can also be detected and tracked by most modern radar systems and their positions, speeds and directions of travel can be deduced. Using these data, the own ship's required actions can be computed. This of

course works only if all the strange ships follow the COLREGS strictly and to the letter. However, since ships are normally required to follow these rules, it is not unreasonable to make such an assumption.

The PID autopilot is used to replace the human steersman in this system, effectively removing all necessity of human involvement in the simulation. The scenarios and the simulation results thus obtained can be an effective tool for training pilots and navigators, enhancing their decision-making ability.

3. Realistic Navigational Safety

Some parameters are used in this system including safe passing distance, avoidance collision distance and range of checking collision. These parameters are defined according to ship dynamics, navigator's experience and environment. They are made quite realistic and a safety factor is used to enhance safety further. A straightforward and effective method is used to detect collision danger. The collision avoidance action adopted is based on practical operational experience.

4. Multi-ship Encounter Problem-solving Ability

Multi-ship encounter situation is a very complex one in ship navigation. The ability of solving multi-ship encounter is the important criteria of evaluating the developed system. The strategy used in this thesis for multi-ship encounter collision avoidance was to analyse the situation and treat it as a series of "urgent" two-ship encounter problems according to certain priorities. Meanwhile, the system can find safe route not only for the 'own' ship but for all the ships concerned. In other words, the system can simulate each moving ship in turn as the 'own' ship. Therefore, using this system, the operator can get the data of all ships involved during the period of the scenario. This kind of study can also be used to develop traffic management system.

5. Real-time Response

In previous work the researchers have always considered ship routes fixed and unchanging. However, the environment in which the ship sails changes dynamically. It, therefore, requires the ship navigation to respond to these changes in real time. The current system plans the route at every time step, automatically taking into account any changes in environmental condition or traffic situation just as human navigator would do.

9.2.2 Weaknesses

There are also some weaknesses of the system as follows:

- In this system, the ship's manoeuvring model was simplified to 3 DOF and the environmental conditions including shallow water effects, passing ship's effects and external forces are ignored. Although in most automatic navigation algorithms these conditions are rarely considered [Zeng, 2003], they influence every aspect of the ship navigation. Furthermore, collision avoidance in different weather conditions requires different evasive manoeuvres. For example, in severe weather conditions, the ship manoeuvres have to combine safety (avoid capsizing or sinking) and collision avoidance concurrently. Therefore, even in this point alone, the developed system cannot simulate ship navigation in severe weather conditions.
- Because of the advantages and limitations of the potential field method used in this system, the system is well suited for real time route planning. The route found will be safe but not necessarily optimal, because no optimization process is involved in this method. In practice, the location and strength of repulsion points need to be set manually and the operator has to carefully select the values of coefficients such as P_o in order to guarantee obstacle avoidance, so it is difficult to predict the actual trajectory.

- According to practical operation and ship masters' experience, the strategy used in this system for avoiding collision is to change ship's heading only. However, for some extreme emergency situation where collision cannot be avoided by changing heading alone, the method of reducing speed should be considered. Such emergencies only occur when appropriate preventive action is not taken well in advance, and consequently a decision was made to leave out this type of collision avoidance action from the current program. Nevertheless, this is one of the functionality which will have to be introduced in any future development of this work.
- In this system, the PID autopilot is used. Although it is effective and widely used in practice, the drawback of this method is that it depends on a reliable model of the vessel and its dynamic responses. Many of the system parameters contained in the full vessel model may be hard to calculate [Golding, 2004]. With the development of modern control theory, many advanced control methods have been used in ship navigation system, and the system can be enhanced by incorporating these control methods.

9.3 Recommendations for Further Research

Automatic ship navigation system is an area of research involved in the mathematical model of ship motion, control theory, sea environment, navigators' experience and traffic regulations. Although the vast range of research effort is currently devoted to this research area, the development of an effective and trustworthy "intelligent" ship navigation system will be the task for many researchers worldwide for many years to come, considering the urgent need for automatic ship navigation system,

The following are some recommendations for further research and development:

- Developing more precise mathematical models and algorithms of ship motion to describe ships' dynamics and its neighbouring environment in automatic ship navigation system.
- Considering the influence of every aspect of the ship navigation by weather conditions.
- Developing a more accurate method of detecting the danger of collision. Gathering and applying appropriate empirical data for collision avoidance action from helmsman and shipmaster in many different conditions, i.e., different sea states, various encounter situations, etc.
- Designing more advanced autopilot to improve the degree of ship automation and realizing the automation of intelligent decision-making for vessel manoeuvring gradually.
- Improving the strategy of ship's collision avoidance in emergency situation.
- Improving the functions of automatic ship navigation system, considering how to combine automatic ship navigation system with full-bridge simulators to train ship's crew.

Chapter 10:

Conclusions

The main conclusions drawn from the research presented in the thesis can be summarized as follows:

- A critical review of the existing approaches of automatic ship navigation system disclosed some important problems which were not effectively addressed in previous works.
- The potential field method widely applied in the robotic research is used in developing automatic ship navigation simulation. A simple and practical method of automatic route planning and collision avoidance based on the artificial potential field was presented in this work. This method is suitable for both route planning and collision avoidance in static and dynamic ship environment within COLREGS guideline.
- An automatic time-domain simulation program of ship navigation in congested waterways has been developed based on the potential field method. The system makes some simplifications and therefore has much room for improvement in finer details. However, it has been proven a useful tool to demonstrate the soundness of the algorithms and strategies developed for automatic navigation simulation.
- The simulation software, in its refined form, could be used for training mariners in ship handling in difficult circumstances in conjunction with full-bridge simulators.

References

- Adams, M. D. (1999). High speed target pursuit and asymptotic stability in mobile robotics. *IEEE Transaction on Robotics and Automation*, Vol.15, No.2, pp.230-237.
- Borenstein, J. & Kroen, Y. (1989). Real-time obstacle avoidance for fast mobile robots. *IEEE Trans. Sys. Man, Cyb.*, 19(5): 1179-1187.
- Burnay, S. (2008). Manoeuvring simulation: a valuable aid to ship mooring and berthing. Retrieved 8 December 2008, from: <<http://www.bmtseatech.co.uk>>.
- Chislett, M. S. & Strom-Tejsen, J. (1965). Planar motion mechanism tests and full-scale steering and manoeuvring predictions for a mariner class vessel. *Technical Report, Hy-6*, Hydro- and Aerodynamics Laboratory, Lyngby, Denmark.
- Connolly, C. I. & Grupen, R. A. (1993). On the applications of harmonic functions to robotics. *Journal of Robotic Systems*, 10(5): 931-946.
- Crockcroft, A. N. & Lameijer, J. N. F. (1996). *A guide to the collision avoidance rules*. 5th edition, BH Newnes, Oxford.
- Fossen, T. I. (1994). *Guidance and control of ocean vehicles*. Wiley, Chichester.
- Fossen, T. I. (2002). *Marine control systems: guidance, navigation and control of ships, rigs and underwater vehicles*. First edition, Marine Cybernetics, Trondheim, Norway.
- Ge, S. S. & Cui, Y. J. (2000). Path planning for mobile robots using new potential functions. *Proc. Asian Control Conference*, Shanghai.

- Ge, S. S. & Cui, Y. J. (2002). New potential functions for mobile robot path planning. *IEEE Transactions on Robotics and Automation*, Vol. 16, No. 5, pp. 615.
- Golding, B. K. (2004). Industrial systems for guidance and control of marine surface vessels. *Project Assignment*, NTNU.
- Goodwin, E. M. (1975). A statistical study of ship domain. *Journal of Navigation*, 28.
- Graczyk, T., Jarzebski, C. A., Brebbia, C. A. & Burns, R. S. (1995). Methods to assign the safe manoeuvre and trajectory avoiding collision at sea. *Proc. 1st Int. Conf. Marine Technol.*, 495-502.
- Harris, C. J., Hong, X. & Wilson, P. A. (1999). An intelligent guidance and control system for ship obstacle avoidance. *Proceedings of The Institution of Mechanical Engineers Part I- Journal of Systems and Control Engineering*, 213, 311-320.
- Hilgert, H. & Baldauf, M. (1997). A common risk model for the assessment of encounter situations on board ships. *Ocean Dynamics*, 49(4), 531-542.
- Holzhueter, T. & Schultze, D. (1995). Operating experience with a high precision track controller for commercial ships. *Proceedings of the Third IFAC Workshop on Control Applications in Marine Systems*, pp. 270-278. Trondheim, Norway.
- Hong, B. & Jia, C. (2002). Synthetic evaluation of large ship manoeuvrability. *Journal of Traffic and Transportation Engineering*, 6, Vol. 2, 2.
- Hwang, C. N., Yang, J. M. & Chiang, C. Y. (2001). The design of fuzzy collision avoidance expert system implemented by H-infinity autopilot. *Journal of Marine Science and Technology*, 9, 25-37.

Iijima, Y. & Hagiwara, H. (1994). Results of collision avoidance manoeuvre experiments using a knowledge-based autonomous piloting system. *Journal of Navigation*, 47: 194-202.

IMO (2005). Casualty statistics and investigations: very serious and serious casualties for the year 2002. *FSI.3/Circ.5*, 23 February 2005.

Ince, A. N. & Topuz, E. (2004). Modelling and simulation for safe and efficient navigation in narrow waterways. *Journal of Navigation*, 57, 53-71.

Ishioka, Y. & Nakamura, S. (1996). A study on a support of decision-making for collision avoidance in INS. *Marine Simulation and Ship Manoeuvrability*, Chislett (ed.) Balkema, Rotterdam.

Ito, M., Zhang, F. & Yoshida, N. (1999). Collision avoidance control of ship with genetic algorithms. *Proceedings of the 1999 IEEE International Conference on Control Applications*, Kohala Coast, Hawaii, USA, August, Vol. 2, pp. 1791–1796.

James, M. K. (1986). Modelling the decision process in computer simulation of ship navigation. *The Journal of Navigation*, 39, 32-48.

Jia, X. Y. & Yang, Y. S. (1999). *Ship motion mathematical model: mechanism modelling and identification modelling*. Dalian Maritime University Press.

Khatib, O. (1986). Real-time obstacle avoidance for manipulators and mobile robots. *J. Robotics Res.*, 5(1), 90-98.

Khosla, P. & Volpe, R. (1988). Superquadric artificial potentials for obstacle avoidance and approach. *Proc. 1988 IEEE International Conference on Robotics and Automation*, Philadelphia, PA, April 26-28.

- Kim, J. O. & Khosla, P. (1991). Real-time obstacle using harmonic potential functions. *Proc. IEEE Conference on Robotics and Automation*, Sacramento, CA, pp. 790-796.
- Koren, Y. & Borenstein, J. (1991). Potential field methods and their inherent limitations for mobile robot navigation. *Proc. International Conference on Robotics and Automation*, Sacramento, California.
- Kose, E., Basar, E., Demirci, E., Guneroglu, A. & Erkebay, S. (2003). Simulation of marine traffic in Istanbul strait. *Simulation Modelling Practice and Theory*, 11, 597-608.
- Kose, K. (1990). On an intelligent harbour manoeuvring simulator and its application. *MARSIM & ICSM 90*.
- Kose, K., Ishioka, Y. & Yang, C. (1996). A study on a collision avoidance expert system for decision-making support in integrated navigation system. *Journal of the Society of Naval Architects of Japan*, Vol.178.
- Kose, K. & Yang, C. (1995). A collision avoidance expert system for integrated navigation system and its brush-up. *Journal of the Society of Naval architects of Japan*, Vol. 177.
- Lee, J. J. & Choi, C. (1996). Dynamical path-planning algorithm of a mobile robot: local minima problem and nonstationary environments. *Mechatronics*, Vol. 6, No.1, pp. 81-100.
- Lee, S. M., Kwon, K. Y. & Joh, J. (2004). A fuzzy logic for autonomous navigation of marine vehicles satisfying COLREG guidelines. *International Journal of Control, Automation and Systems*, Vol. 2, No. 2.

-
- Li, J. & Wang, F. (1983). *The ship collision avoidance at sea*. (in Chinese). People's Communications Press, Beijing.
- Lin, H. S., Xiao, J. & Michalewicz, Z. (1994). Evolutionary algorithm for path planning in mobile robot environment. *Proceedings of the First IEEE Conference, IEEE World Congress on Computational Intelligence*, 211–216.
- Liu, Y. & Shi, C. (2005). A fuzzy-neural inference network for ship collision avoidance. *Proceedings of IEEE the Third International Conference on Machine Learning and Cybernetics ICMLC2005*, Guangzhou, China, pp.4754-4759.
- Muirhead, P. (2003). Broadband technology and marine simulation: why not simulator training anywhere, anytime? *International Conference on Marine Simulation and Ship Manoeuvrability (MARSIM'03) conference proceedings*, Japan, Vol.1. RA-1-1-RA-1-8.
- Porathe, T. (2004). Visualizing the decision space of a ship's manoeuvrability in a real-time 3-D nautical chart. The NATO Research and Technology Organisation IST-043/RWS-006 Workshop *Visualisation and the Common Operational Picture (VizCOP)*, 14-17 September, Toronto, Canada.
- Prestes e Silva, E., Engel, P. M., Trevisan, M. & Idiart, M. A. P. (2002). Exploration method using harmonic functions. *Robotic and Autonomous Systems*, Vol. 40(1), pp.25-42.
- Rimon, E. & Koditchek, D. E. (1992). Exact robot navigation using artificial potential functions. *IEEE Transactions on Robotics and Automation*, Vol. 8, No. 5, 1992.
- Rogers, D. F. & Adams, J. A. (1990). *Mathematical elements for computer graphics*. Second Edition. McGraw-Hill Publishing Company, New York.

Shi, C., Zhang, M. & Peng, J. (2007). Harmonic potential field method for autonomous ship navigation. *Telecommunications, 7th International Conference on ITS*, 6-8 June.

Smierzchalski, R. (1996). The decision support system to design the safe manoeuvre avoiding collision at sea. *14th International Conference Information Systems and Synthesis*, Orlando, USA.

Smith, C. (2008). Collision avoidance system & safe path generation. *4th year Project*, University of Strathclyde.

SNAME (1950). *Nomenclature for treating the motion of a submerged body through a fluid*. The Society of Naval Architects and Marine Engineers, Technical and Research Bulletin No. 1-5, April 1950, pp. 1-15.

SNAME (1967). *Principles of naval architecture*. The Society of Naval Architects and Marine Engineers, Revised Edition 1967.

Statheros, T., Howells, W. G. J. & McDonald-Maier, K. D. (2008). Autonomous ship collision avoidance navigation concepts, technologies and techniques. *Journal of Navigation*, 61, 129–142.

Szlapczynski, R. (2009). Planning emergency manoeuvres. *Journal of Navigation*, 62, 79–91.

Tam, C. K., Bucknall, R. & Greig, A. (2009). Review of collision avoidance and path planning methods for ships in close range encounters. *Journal of Navigation*, 62, 455-476.

Thorpe, C. F. (1985). *Path relaxation: path planning for a mobile robot*. Carnegie-Mellon University, the Robotics Institute, Mobile Robots Laboratory, Autonomous Mobile Robots, Annual Report 1985, pp. 39-42.

- Tran, T., Harris, C. J. & Wilson, P. A. (1999). Maritime avoidance navigation totally integrated system (MANTIS). *Proceedings of the Twelfth Ship Control Systems Symposium (12th SCSS 1999)*, The Hague, Netherlands, Royal Dutch Navy.
- Tran, T., Harris, C. J. & Wilson, P. A. (2001). Vessel management expert system. *2001 IEEE Intelligent Transportation Systems Conference Proceedings*, Oakland (CA) USA, August 25-29.
- Tsourveloudis, N. C., Valavanis, K. P. & Hebert, T. (2001). Autonomous vehicle navigation utilizing electrostatic potential field and fuzzy logic. *IEEE Transaction on Robotics and Automation*, Vol. 17, No.4, pp. 490-497.
- Volpe, R. & Khosla, P. (1990). Manipulator control with superquadric artificial potential functions: theory and experiments. *IEEE Transactions on Systems, Man, and Cybernetics*, Vol. 20, No. 6.
- Webster, W. C. (1992). *Shiphandling simulation: application to waterway design*. Committee on Assessment of Shiphandling Simulation, Marine Board, National Research Council.
- Wilson, P. A., Harris, C. J. & Hong, X. (2003). A line of sight counteraction navigation algorithm for ship encounter collision avoidance. *The Journal of Navigation*, 56, 477-490.
- Xu, Z. J. (2005). *Intelligence automatic collision avoidance expert system for ships*. Ph.D. Thesis, Tongji University, China.
- Xue, Y., Lee, B. S. & Han, D. (2009). Automatic collision avoidance of ships. Proc. IMechE Part M: *J. Engineering for the Maritime Environment*, Vol. 223, Number 1/2009.

- Yang, C. (1995). *An expert system for collision avoidance and its application*. Ph.D. Thesis, Hiroshima University, Japan
- Yang, C., Kose, K., Phan, S. & Kuo, P. (2000). A simulation-based procedure for expert system evaluation. *Proceedings of the IEA/AIE 13th International Conference*, New Orleans, Louisiana, USA. June 19-22.
- Yang, S., Li, L., Suo, Y. & Chen, G. (2007). Study on construction of simulation platform for vessel automatic anti-collision and its test method. *Proceedings of the IEEE International Conference on Automation and Logistics*, August 18-21, Jinan, China.
- Yavin, Y., Frangos, C., Miloh, T. & Zilman, G. (1997). Collision avoidance by a ship with a moving obstacle: computation of feasible command strategies. *Journal of Optimization Theory and Applications*, 93, 53–66.
- Zeng, X. M. (2000). Evolutionary path planning for ship using genetic algorithms. *6th International Conference on Methods and Models in Automation and Robotics*, Poland.
- Zeng, X. M. (2003). Evolution of the safe path for ship navigation. *Applied Artificial Intelligence*, 17, 87–104.
- Zhao, J, Wu, Z. & Wang, F. (1993). Comments of ship domains. *Journal of Navigation*, 46.
- Zhao, J., Price, W. G. & Wilson, P. A. (1995). Automatic collision avoidance: towards the 21st century. *In ACAS*, Sep 1994, Shanghai, China.

Appendix A:

Ship Model

In this work, the Mariner class ship is used for the case studies. The main data and dimensions of the Mariner class ship are [Chislett & Strom-Tejsen, 1965]:

Length overall (L_{oa})	171.80	(m)
Length between perpendiculars (L_{pp}).....	160.93	(m)
Maximum beam (B).....	23.17	(m)
Design draft (T).....	8.23	(m)
Design displacement (∇).....	18541	(m ³)
Design speed (u_0).....	15	(knots)

The non-dimensional coefficients in the model are:

$$m' = 798 \cdot 10^{-5}; \quad I'_z = 39.2 \cdot 10^{-5}; \quad x'_G = -0.023$$

Non-dimensional hydrodynamic coefficients for the Mariner class ship are given in Table A-1

Table A- 1: Non-dimensional hydrodynamic coefficients

X-equation	Y-equation	N-equation
$X'_{\dot{u}} = -840 \cdot 10^{-5}$	$Y'_{\dot{v}} = -1546 \cdot 10^{-5}$ $Y'_{\dot{r}} = 9 \cdot 10^{-5}$	$N'_{\dot{v}} = 23 \cdot 10^{-5}$ $N'_{\dot{r}} = -83 \cdot 10^{-5}$
$X'_u = -184 \cdot 10^{-5}$ $X'_{uu} = -110 \cdot 10^{-5}$ $X'_{uuu} = -215 \cdot 10^{-5}$ $X'_{uv} = -899 \cdot 10^{-5}$ $X'_{rr} = 18 \cdot 10^{-5}$ $X'_{\delta\delta} = -95 \cdot 10^{-5}$ $X'_{u\delta\delta} = -190 \cdot 10^{-5}$ $X'_{rv} = 798 \cdot 10^{-5}$ $X'_{v\delta} = 93 \cdot 10^{-5}$ $X'_{uv\delta} = 93 \cdot 10^{-5}$	$Y'_v = -1160 \cdot 10^{-5}$ $Y'_r = -499 \cdot 10^{-5}$ $Y'_{vvv} = -8078 \cdot 10^{-5}$ $Y'_{vvr} = -15356 \cdot 10^{-5}$ $Y'_{vu} = -1160 \cdot 10^{-5}$ $Y'_{ru} = -499 \cdot 10^{-5}$ $Y'_{\delta} = 278 \cdot 10^{-5}$ $Y'_{\delta\delta\delta} = -90 \cdot 10^{-5}$ $Y'_{u\delta} = 556 \cdot 10^{-5}$ $Y'_{uu\delta} = 278 \cdot 10^{-5}$ $Y'_{v\delta\delta} = -4 \cdot 10^{-5}$ $Y'_{vv\delta} = 1190 \cdot 10^{-5}$ $Y^{0'} = -4 \cdot 10^{-5}$ $Y_u^{0'} = -8 \cdot 10^{-5}$ $Y_{uu}^{0'} = -4 \cdot 10^{-5}$	$N'_v = -264 \cdot 10^{-5}$ $N'_r = -166 \cdot 10^{-5}$ $N'_{vvv} = 1636 \cdot 10^{-5}$ $N'_{vvr} = -5483 \cdot 10^{-5}$ $N'_{vu} = -264 \cdot 10^{-5}$ $N'_{ru} = -166 \cdot 10^{-5}$ $N'_{\delta} = -139 \cdot 10^{-5}$ $N'_{\delta\delta\delta} = 45 \cdot 10^{-5}$ $N'_{u\delta} = -278 \cdot 10^{-5}$ $N'_{uu\delta} = -139 \cdot 10^{-5}$ $N'_{v\delta\delta} = 13 \cdot 10^{-5}$ $N'_{vv\delta} = -489 \cdot 10^{-5}$ $N^{0'} = 3 \cdot 10^{-5}$ $N_u^{0'} = 6 \cdot 10^{-5}$ $N_{uu}^{0'} = 3 \cdot 10^{-5}$

Appendix B:

The Simulation Program and GUI

In this appendix, the simulation program developed in this thesis is introduced.

● Program Structure

This program is implemented using MATLAB. The complete simulation program consists of one main program and 13 subprograms as shown in Figure B-1. These subprograms can be modified according to different requirements. For example, the subprogram of Ship model is ship's mathematical model. If the user wants to simulate a tanker's navigation, he/she just needs to modify this subprogram using tanker's parameters. The most important subprograms are as follows:

1. *RTCA*: This is the main program that contains the main collision avoidance algorithm, the user interface and the plotting functions. This file controls the whole simulation process. The user is able to input the number of ships and obstacles and their locations. The plotting function can show real time simulation process. The trajectory and the manoeuvring parameters can be recorded.
2. *Parameter*: This file is used to determine some important parameters used in the program, such as safe passing distance C_S , collision avoidance distance C_A and checking collision distance.
3. *Repulsive_angle*: This file calculates the repulsive angle between ship and obstacle. It is an important parameter to calculate the repulsive force.

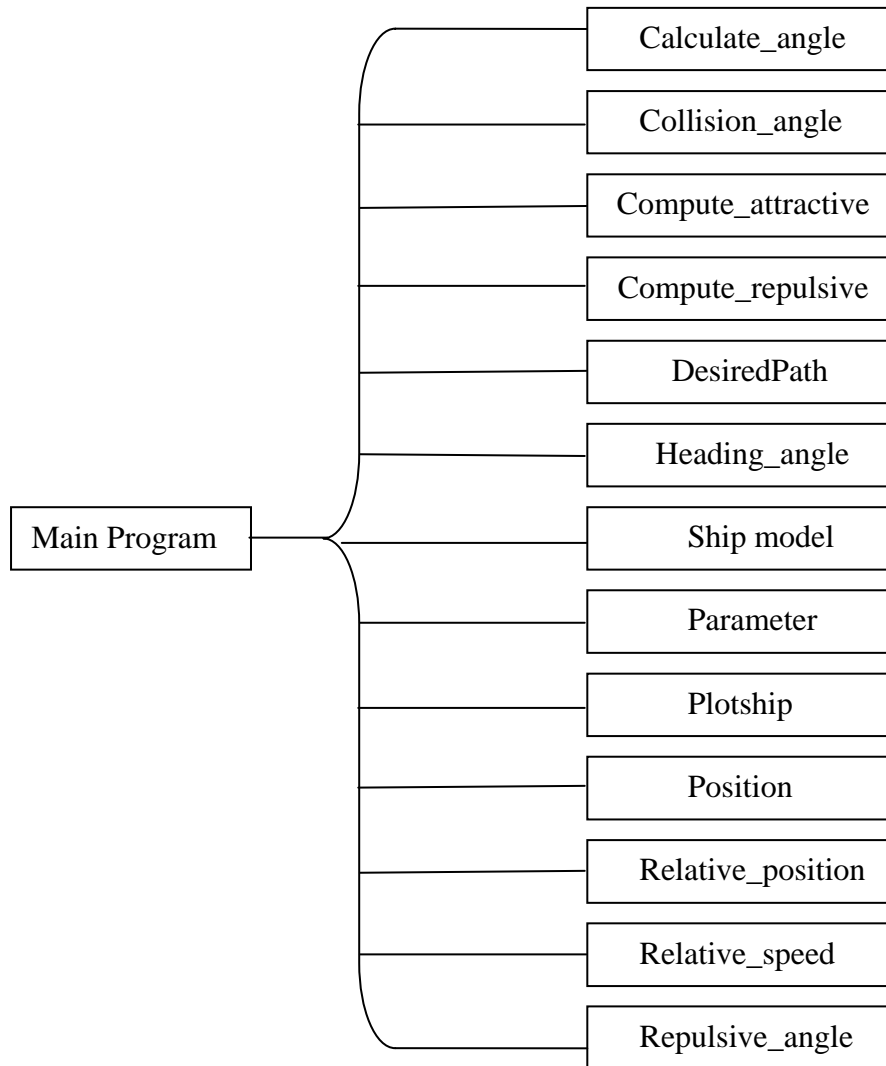

Figure B- 1: The program structure

4. *Compute_attractive, Compute_repulsive*: Taking into consideration the data of ships and obstacles provided by *RTCA* file and repulsive angle calculated by *Repulsive_angle* subprogram, these two subprograms calculate the attractive force and repulsive force.
5. *Position*: This file determines the next position of the ship. The time step, ship's speed and the current position (X, Y) are utilized to get the next position (X_1, Y_1) .

6. *Relative_speed, Relative_position*: These two files calculate the relative speed and position. These data can be used to calculate the angle a (described in Chapter 6). This angle, a , is the angle in the vector triangle made by the vectors between own ship's position and the strange ship's position.

● Operation

The program can be run in two different ways. One is to run the main program *RTCA* directly. The user inputs details of obstacles and ship parameters in this file. They can adjust the parameters used in program. Once all the details of obstacles and ship parameters are input as required by the user, the simulation can be initiated by clicking on the run button. The other mode is to use the GUI to operate the simulation. A screen shot of the GUI is shown in Figure B-2.

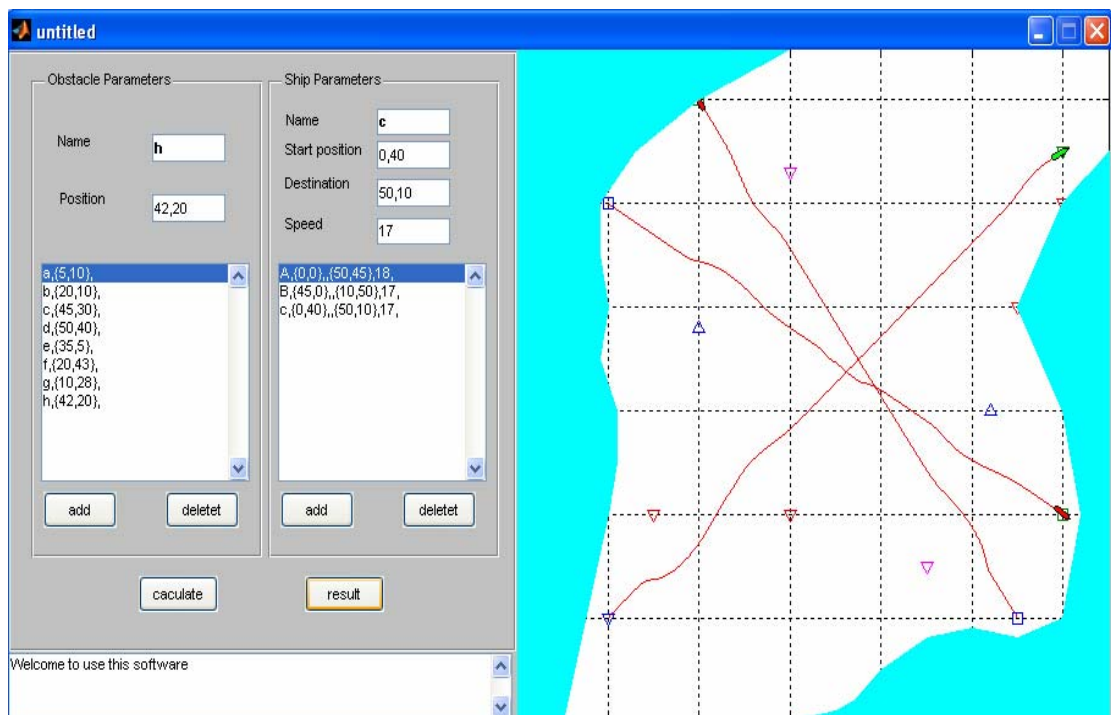

Figure B- 2: Running the program through GUI

● Outputs

There are two main outputs. The first plot shows the whole simulation progress in real time. The ship's movement in every time step is dynamically shown. The ships' positions are tracked using different colour lines as shown in Figure B-3.

The second plot displays the ship's key manoeuvring parameters against time as shown in Figure B-4. From this plot, the user can analyze the ship's performance during the simulation run.

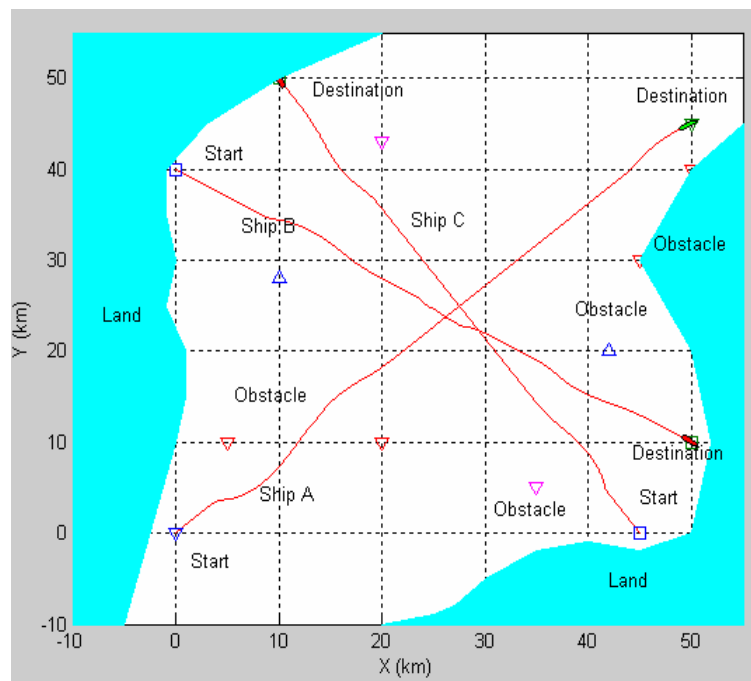

Figure B- 3: The output plot

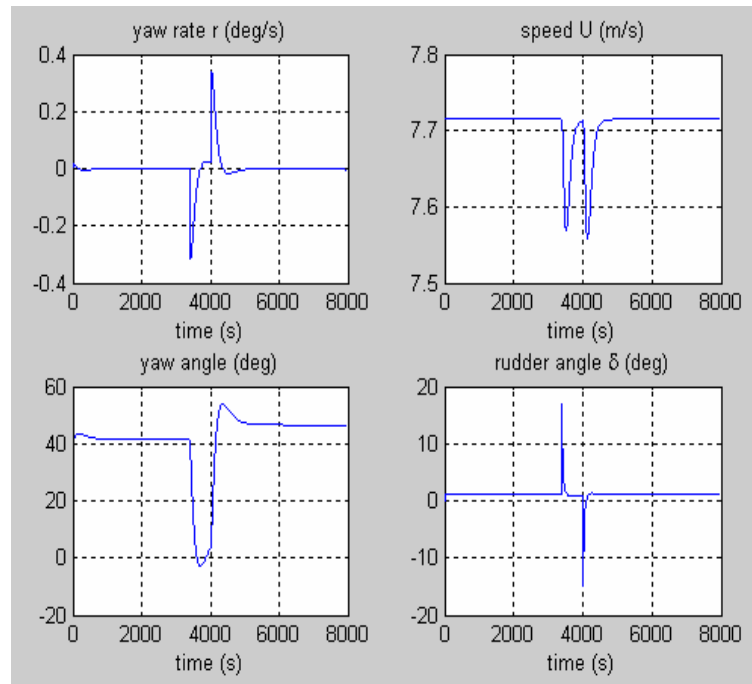

Figure B- 4: The ship's key manoeuvring parameters plot

● Graphical User Interface (GUI)

The Graphical User Interface (GUI) is designed as shown in Figure B-5. It consists of two main parts: parameters setting area; and the graphical display window.

▪ The Parameters Setting Area

The parameters setting area is on the left hand side of the display as shown in Figure B-5. The user inputs details of obstacles and ship parameters here. It also has the 'calculate' button, 'results' button and the notice window as shown in Figure B-6. Once all the details of obstacles and ship parameters are input as required by the user, the simulation can be initiated by clicking on the 'start' button. The functions of various fields of the GUI are as follows.

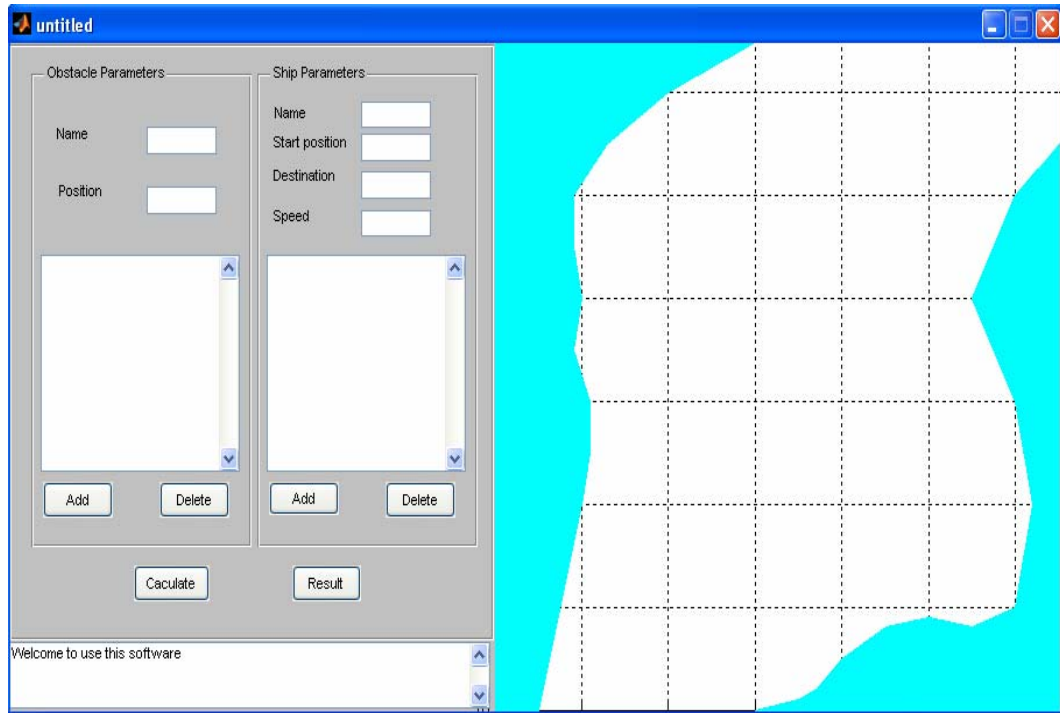

Figure B- 5: The Graphical User Interface (GUI)

- 1) Obstacle Parameters. The function of this part is to set obstacle information. To specify a stationary obstacle, the user needs to input the name and position of the obstacle. Pressing the 'add' button will add the information just entered to the obstacles list. Any unwanted obstacles or erroneous data can be deleted as shown in Figure B-8.

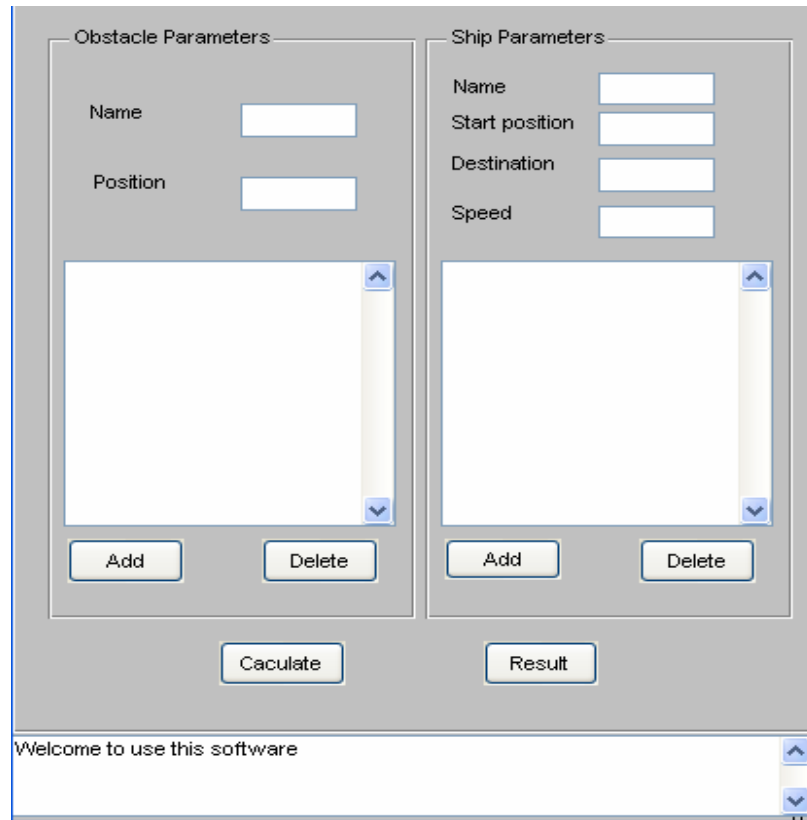

Figure B- 6: The parameters setting part

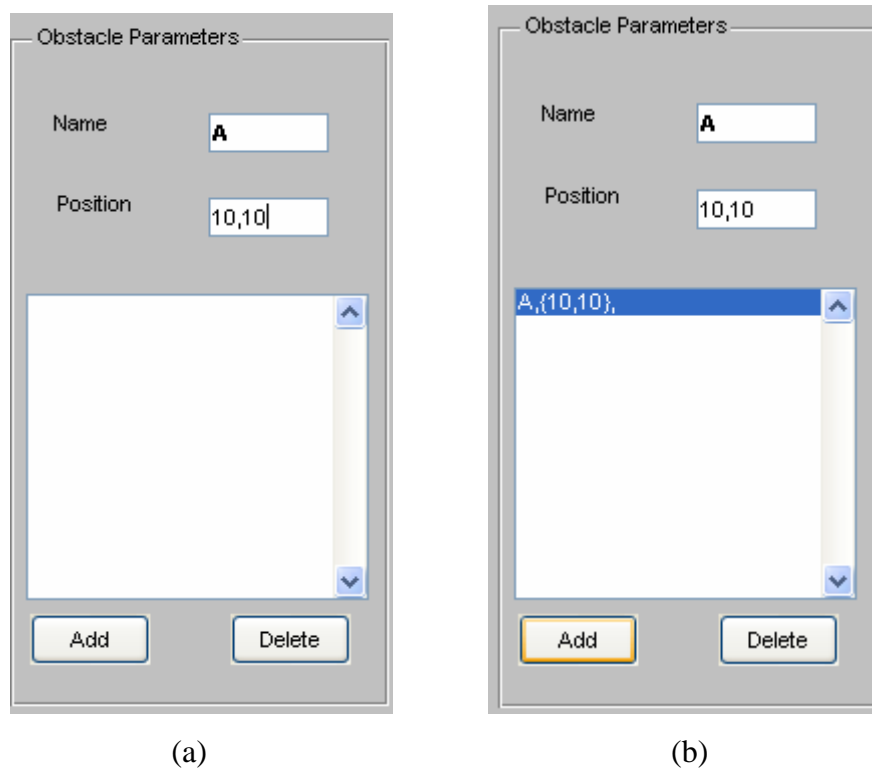

Figure B- 7: (a) Inputting the obstacle's information (b) adding to the list

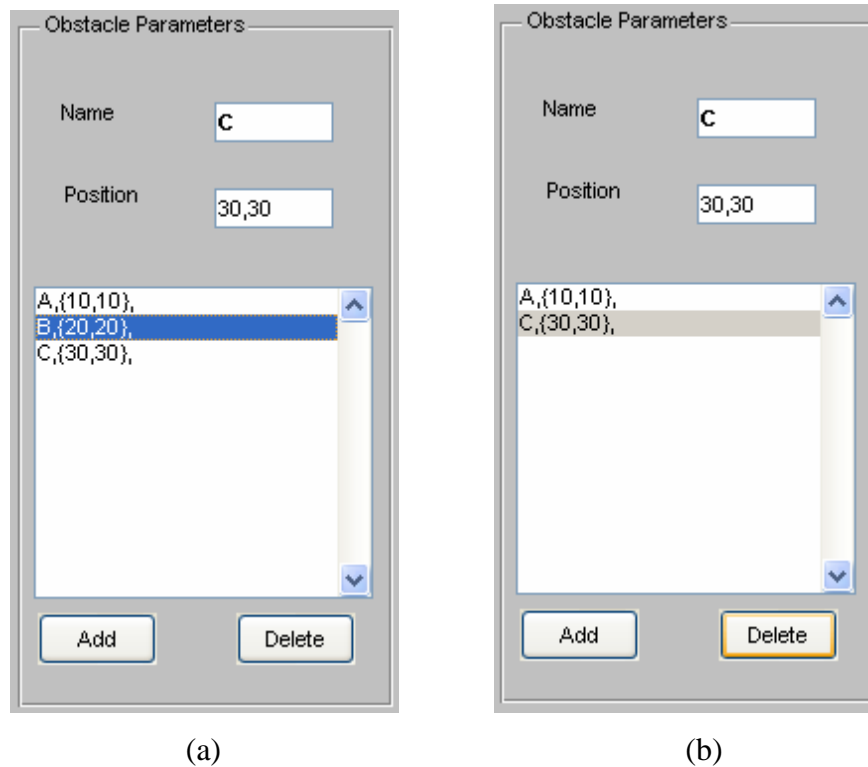

Figure B- 8: (a) Choosing the obstacle's information (b) the data is deleted from the list

- 2) Ship Parameters. This part is used to set ship information. The information includes: ship's name, start position, destination and ship's speed. Again, these can be added or deleted in the same manner as shown for the obstacle parameters as shown in Figures B-9 and B-10.
- 3) Calculate and Results. These two buttons are used to run simulation and get results. After setting the parameters of obstacles and ships, the user can run the simulation by pressing the 'calculate' button. When the simulation is completed, the 'results' button can be press to obtain the simulation results.
- 4) The Notice Window. The main function of this window is to give prompts to the user, particularly when wrong parameters are entered as shown in Figure B-11. For example, when the ship's speed entered exceeds its limitation, it will point this out.

Ship Parameters

Name

Start position

Destination

Speed

(a)

Ship Parameters

Name

Start position

Destination

Speed

A,{0,0},{10,10},18,

(b)

Figure B- 9: (a) Inputting the ship's information (b) adding to the list

Ship Parameters

Name

Start position

Destination

Speed

A,{0,0},{10,10},18,

B,{10,10},{20,20},17,

C,{0,10},{0,20},16,

d,{10,30},{20,50},13,

(a)

Ship Parameters

Name

Start position

Destination

Speed

A,{0,0},{10,10},18,

B,{10,10},{20,20},17,

C,{0,10},{0,20},16,

(b)

Figure B- 10: (a) Choosing the ship's information (b) the data is deleted from the list

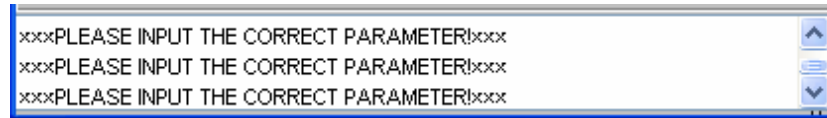

Figure B- 11: The notice window

- **Graphical Display Window**

The graphical display window (shown on the right side of Figure B-5) shows the progress of the simulation in real time. The ships' positions are updated at every time step and their routes are tracked using different colour lines as shown in Figure B-3.

This window also displays the 2-D topographical configuration of the waterways and the obstacles.

Appendix C:

Papers

The papers written based on the thesis and published in journal or presented for international conferences are as follows:

- [1] Xue, Y., Lee, B. S. & Han, D. (2009). Automatic collision avoidance of ships. Proc. IMechE Vol. 223, Number 1/2009, Part M: *J. Engineering for the Maritime Environment*.
- [2] Xue, Y., Lee, B. S. & Han, D. (2007). Modelling of ship manoeuvring in harbour. *Proceedings of the 12th International Congress of the International Maritime Association of the Mediterranean*, IMAM 2007, 2-6 September 2007, Varna, Bulgaria.
- [3] Xue, Y., Lee, B. S. (2007). Automatic simulation of manoeuvring in harbour. *The Asialink-EAMARNET International Conference on Ship Design, Production and Operation*, 17-18 Jan 07, Harbin, China.