

**Evaluation of direct PCR for forensic  
DNA profiling and the development of a  
direct PCR multiplex**

**By**

**Yuvaneswari Chandramoulee Swaran**

Centre for Forensic Science  
Department of Pure and Applied Chemistry  
University of Strathclyde

A thesis presented in fulfilment of the requirements for the  
degree of Doctor of Philosophy

2012

This thesis is the result of the author's original research. It has been composed by the author and has not been previously submitted for examination which has led to the award to the degree.

The copyright of this thesis belongs to the author under the terms of the United Kingdom Copyright Acts as qualified by University of Strathclyde Regulation 3.50. Due acknowledgement must always be made use of any material contained in, or derived from, this thesis.

Signed:

Date:

## **Abstract**

The use of direct PCR with different types of sample was explored in this study. Genomic DNA preparations at various concentrations and buccal cell counts were deposited on commonly encountered substrates, recovered and amplified using direct PCR before subjecting them to capillary electrophoresis. The electropherograms obtained were compared to those obtained using the standard DNA profiling protocol which involves extraction and amplification prior to capillary electrophoresis. Direct PCR was found to be better than the standard DNA profiling protocol in both studies and was further tested with fingerprints, touch DNA on fabric and blood and semen stains on fabrics. All these tests were successful with direct PCR indicating that this technique has the potential to be incorporated into routine forensic DNA testing.

Supplementary tests were also carried out to compare the efficiency of the swabbing technique utilised and the effect different substrates had on DNA recovery. Four non-porous substrates, which were glass, stainless steel, plastic and ceramic, and four types of dyed fabrics, which were white cotton, light blue denim, nylon and brown cotton, were used to deposit DNA and the resulting DNA profiles were evaluated. Of the non-porous substrates tested, the highest recovery of DNA was observed with plastic while the lowest was observed with stainless steel. DNA deposited on fabric on the other hand gave variable results which we believe is dependent on the dye used to stain the fabric and the thickness of the fibres used. The results in this experiment indicated that the substrate DNA is deposited on plays an important role in determining the resulting DNA profiles.

Finally, a novel multiplex consisting of five autosomal and two Y-chromosomal STRs which also provides the inhibitor status of the sample was developed. This multiplex also addresses the issues concerning sensitivity and robustness that was encountered with other commercially available multiplexes. The multiplex was developed, validated and tested with various mock crime scene samples successfully. Allelic ladder, panels and bins were created to be used with this multiplex to aid in sample designation when subjected to capillary electrophoresis.

## **Acknowledgements**

I would first like to thank all my supervisors starting from Adrian, Lindsey, Marielle and finally Lynn for their support and patience. Thank you for all the encouragements and motivations you gave me throughout the duration of my PhD. I've learned a great deal from all of you which have made me a better person than I was yesterday.

Special thanks also go to the Malaysian Government for the sponsorship and the opportunity to allow me to pursue one of my life long dreams.

I would like to take this opportunity to thank all my 'volunteers' and 'sample donors' which allowed me to carry out all my experiments smoothly. This project could not have been a success without all of you.

To all the FFBS past and present namely, The Chiefs, Ice, Four, Kevin and Anika, thank you for those countless gaming nights, dinners, movies and outings that helped cure the week's stresses. Thank you also goes to Shane who has helped me throughout the years with various advice and tips.

A special thank you also goes to all the staff at the Centre for Forensic Science, academic and technical, who have helped me throughout these 3 years: Georgie and Lynn who have helped me with the procurements of various laboratory reagents, Niamh who has helped me with the ethics forms and Lorraine for handling the various issues and complaints. To Nigel, it has been a pleasure working with you and thank you for the countless chats and discussions we've had.

I would also like to thank my family for being there for me. Your encouragements and belief in me has kept me going through those tough times

Most importantly, I would like thank my husband, Sara, for the unconditional support and unwavering patience. You believed in me when I doubted myself, and for that I am sincerely thankful. This PhD is yours too.

## **Publications and presentations relating to this research**

### **Publications**

Linacre A, Pekarek V, Swaran YC, Tobe SS. *Generation of DNA profiles from fabrics without DNA extraction*. Forensic Science International: Genetics. 2010; 4 (2): 137-41.

Swaran YC, Welch L. *A comparison between direct PCR and extraction to generate DNA profiles from samples retrieved from various substrates*. Forensic Science International Genetics. 2011. 6: 407-412.

### **Oral Presentation**

Yuvaneswari C.Swaran. Direct PCR with PowerPlex 16 HS. Presented at the 11<sup>th</sup> European STR Working Group Meeting. 23<sup>rd</sup> to 25<sup>th</sup> November 2010, Budapest Hungary.

### **Poster Presentation**

Yuvaneswari C.Swaran, Lindsey Welch. *Evaluation of alternative polymerases for Direct PCR*. Presented at the 24th World Congress of the International Society for Forensic Genetics (ISFG). 29<sup>th</sup> Aug – 4<sup>th</sup> Sept 2011, Vienna Austria.

Yuvaneswari C. Swaran, Lindsey Welch. *Successful generation of DNA profiles using Direct PCR*. Presented at the 2nd International Conference on Forensic Genetics FORENSICA 2010. 24<sup>th</sup> – 26<sup>th</sup> May 2010, Telc Czech Republic.

Yuvaneswari C.Swaran. *Generation of DNA profiles with Direct PCR*. Presented at the University of Strathclyde Research Day 2010.

Yuvaneswari C.Swaran, Lynn Dennany. *Development of a multiplex reaction for the simultaneous analysis of STR and Y-STR markers (Part 1)*. To be presented at EAFS 2012, 20<sup>th</sup>-24<sup>th</sup> August 2012, The Hague.

Yuvaneswari C.Swaran, Lynn Dennany. *Validation of multiplex for simultaneous amplification of STR and Y-STR markers (Part 2)*. To be presented at EAFS 2012, 20<sup>th</sup>-24<sup>th</sup> August 2012, The Hague.

## List of Abbreviations

£	British Pound Sterling
°C	Degrees Celsius
% $E_f$	Percentage efficiency
% $P$	Percentage profile
µg	Microgram
µL	Microlitre
µM	Micromolar
A	Adenine
bp	Base pairs
C	Cytosine
CE	Capillary electrophoresis
dH <sub>2</sub> O	Deionised water
DNA	Deoxyribonucleic acid
dNTP	Deoxynucleotide triphosphate
EDNAP	European DNA Profiling Group
EDTA	Ethylenediaminetetraacetic acid
ENFSI	European Network of Forensic Science Institutes
EPG	Electropherogram
G	Guanine
Hbx	Heterozygous balance
IPC	Internal PCR control

LCN	Low copy number
LT-DNA	Low template DNA
MgCl <sub>2</sub>	Magnesium chloride
mL	Millilitre
mm	millimeter
mM	Millimolar
ng	Nanogram
nM	Nanomolar
OL	Off-ladder
PCR	Polymerase chain reaction
pg	Picogram
PP16-HS	PowerPlex 16 HS
rfu	Relative fluorescence unit
SD	Standard deviation
SGMPlus	AmpFISTR <sup>®</sup> SGM Plus <sup>®</sup>
STR	Short tandem repeat
T	Thymine
<i>Taq</i>	<i>Thermus aquaticus</i> DNA polymerase
T <sub>m</sub>	Melting temperature
TPH	Total peak height
Tris	Tris(hydroxymethyl)methylamine
UV	Ultraviolet

## Table of Contents

<b>Abstract</b>	<b>i</b>
<b>Acknowledgements</b>	<b>ii</b>
<b>Publications and presentations relating to this research</b>	<b>iii</b>
<b>List of abbreviations</b>	<b>iv</b>
<b>List of Figures</b>	<b>xii</b>
<b>List of Tables</b>	<b>xviii</b>
<b>Chapter Overview.....</b>	<b>xxi</b>
<b>1 General Introduction .....</b>	<b>1</b>
1.1 The science of DNA .....	1
1.2 Short tandem repeats (STR) .....	3
1.3 DNA Profiling Protocol.....	5
1.3.1 Sample Extraction .....	5
1.3.2 Polymerase Chain Reaction (PCR) .....	6
1.3.3 Multiplex PCR .....	9
1.3.4 DNA separation and detection .....	11
1.3.5 Interpretation of raw data .....	11
1.4 Analysis of low template DNA .....	18
1.5 Direct PCR.....	20
1.5.1 Why use direct PCR? .....	22
1.6 Aims and objectives .....	26



<b>2</b>	<b>Comparison of Direct PCR and extraction of DNA traces recovered from four different substrates .....</b>	<b>27</b>
2.1	Introduction .....	27
2.1.1	DNA recovery by swabbing .....	27
2.1.2	Substrates .....	28
2.1.3	Pre-PCR treatments .....	32
2.1.4	Multiplex kits .....	33
2.1.5	Aims and objectives .....	36
2.2	Materials and method .....	37
2.2.1	Swabbing Technique .....	37
2.2.2	Retrieval of DNA .....	37
2.2.3	Amplification and electrophoresis .....	38
2.2.4	Duplicate injection using 310 Genetic Analyser .....	40
2.2.5	Comparison between direct PCR and QiaAmp DNA Micro extraction on different substrates using two commercial STR kits .....	40
2.2.6	Data interpretation .....	44
2.3	Results and discussion .....	45
2.3.1	Retrieval of DNA .....	45
2.3.2	Duplicate injection using a 310 Genetic Analyser .....	49
2.3.3	Comparison between direct PCR and Qiagen extraction on different substrates using two commercial STR kits .....	50
2.4	Conclusion .....	64
<b>3</b>	<b>Analysis of buccal cells and fingerprints using direct PCR .....</b>	<b>66</b>
3.1	Introduction .....	66

3.1.1	Buccal cells as a source of DNA.....	66
3.1.2	Fingerprints as source of DNA .....	66
3.1.3	Compound light microscope .....	71
3.1.4	Hematoxylin-Eosin staining (H&E staining).....	72
3.1.5	Aims and objectives .....	73
3.2	Materials and methods.....	74
3.2.1	Comparison between direct PCR and extraction from buccal cells.....	74
3.2.2	Reference samples.....	75
3.2.3	Direct PCR of fingerprints on glass and plastic .....	77
3.2.4	Amplification and Electrophoresis.....	77
3.2.5	Data analysis .....	79
3.3	Results and discussion.....	80
3.3.1	Comparison between direct PCR and extraction on buccal cells.....	80
3.3.2	Direct PCR of fingerprints on glass and plastic .....	90
3.4	Conclusion.....	93
<b>4</b>	<b>Analysis of touch DNA and body fluids on fabric using direct PCR .....</b>	<b>94</b>
4.1	Introduction .....	94
4.1.1	Blood and semen as sources of DNA.....	94
4.1.2	Textile fibres .....	97
4.1.3	PowerPlex ESX kit.....	100
4.1.4	Aims and objectives .....	101
4.2	Materials and methods.....	102
4.2.1	Direct PCR on touched fabric .....	102

4.2.2	Analysis of body fluids on fabric using direct PCR.....	104
4.2.3	Data analysis .....	106
4.3	Results and discussion.....	107
4.3.1	Direct PCR on touched fabric .....	107
4.3.2	Analysis of body fluids on fabrics using direct PCR.....	109
4.4	Conclusion.....	118
<b>5</b>	<b>Multiplex development and validation for the use of direct PCR .....</b>	<b>119</b>
5.1	Introduction .....	119
5.1.1	Multiplex PCR .....	119
5.1.2	The new European Standard Set (ESS) loci.....	122
5.1.3	Amelogenin Y null.....	123
5.1.4	Y chromosome Short tandem repeats .....	124
5.1.5	Internal PCR Control.....	126
5.1.6	Touchdown protocol .....	127
5.1.7	Multiplex developmental validation .....	127
5.1.8	Aims and objectives .....	128
5.2	Materials and methods.....	130
5.2.1	Multiplex development .....	130
5.2.2	Multiplex optimisation.....	138
5.2.3	Multiplex validation.....	143
5.3	Results and discussion.....	149
5.3.1	Primer selection and testing .....	149
5.3.2	Primer cross-reactivity .....	155

5.3.3	Multiplex optimisation.....	157
5.3.4	Multiplex validation.....	176
5.3.5	Mock crime scene samples-direct PCR.....	190
5.4	Conclusion.....	197
<b>6</b>	<b>General discussion and conclusion .....</b>	<b>199</b>
6.1	Recommendations for future work.....	202
<b>7</b>	<b>References .....</b>	<b>204</b>
	<b>Appendix 1: Sequence of the Internal Positive Control (IPC) Gene .....</b>	<b>233</b>
	<b>Appendix 2: Plasmid DNA Quality Assurance documentation .....</b>	<b>234</b>
	<b>Appendix 3: Bin set for Multiplex .....</b>	<b>235</b>
	<b>Appendix 4: Publications.....</b>	<b>239</b>

## List of Figures

Figure 1.1. The chemical structure of a DNA molecule showing the phosphodiester backbone, deoxyribose sugars and nucleotides.....	2
Figure 1.2. An example of simple, compound and complex repeats. ....	4
Figure 1.3. A graph showing an exponential increase in the quantity of DNA after 20 cycles of amplification starting from 0.01 µg of template DNA. ....	6
Figure 1.4. The position of a stutter peak compared to a true peak. ....	13
Figure 1.5. Example of split peaks with -A and +A peaks. ....	14
Figure 1.6. A comparison between balanced and imbalanced alleles in two different loci.....	15
Figure 1.7. PCR product reduces with increased in size.....	16
Figure 1.8. This figure shows two DNA profiles originating from the same source. ....	17
Figure 1.9. Completeness of DNA profiles obtained based on type of touch samples. ....	23
Figure 1.10. The number of cases and yearend backlogs from 2005 to 2009 in the US.....	25
Figure 2.1. Typical network structure of a sodium silica glass in 2 dimensions. ....	29
Figure 2.2. In the presence of acidic high ionic strength solution, DNA molecules interact with the cations which form a positively charged double layer with the negatively charged silanols. ....	30
Figure 2.3. The basic subunit of the polypropylene polymer. ....	31
Figure 2.4. General size ranges in basepairs (bp) for each loci and dye labelling strategies for the AMPF/STR SGMPlus kit.....	34
Figure 2.5. General size ranges in basepairs (bp) for each loci and dye labelling strategies for the PowerPlex 16 and PowerPlex 16 HS kits.....	35
Figure 2.6. Extraction protocol for the QIAamp spin columns.....	41

Figure 2.7. Percentage allelic dropout calculated from DNA profiles obtained from the three recovery techniques on glass.....	47
Figure 2.8. Percentage allelic dropout calculated from DNA profiles obtained from the three recovery techniques on plastic. ....	48
Figure 2.9. Scatter plot with a regression line indicating the peak heights for duplicate injections are similar.....	50
Figure 2.10. A normal probability plot using the Anderson-Darling Normality test on peak height and allele dropout data.....	51
Figure 2.11. Example of electropherogram obtained from (a) SGMPlus at 1000 rfu and (b) PP16-HS at 3000 rfu, with the same amount of DNA.....	53
Figure 2.12. Box plot for PP16-HS and SGMPlus using the new dataset which excludes null values. ....	55
Figure 2.13. Comparison of total peak heights between direct PCR and extraction on all four substrates. ....	57
Figure 2.14. Mains effect plot where mean total peak height was plotted against the technique used.....	57
Figure 2.15. A comparison of electropherograms at 2000 rfu. ....	59
Figure 2.16. Average percentage profile obtained using direct PCR and Qiagen extraction for glass, plastic, ceramic and stainless steel. ....	60
Figure 2.17. Kruskal-Wallis test comparing median of the four substrates tested.. ..	61
Figure 2.18. Example of EPG obtained using PP16-HS from four of the substrates tested .....	63
Figure 3.1. The anatomy of the Human Skin: Epidermis, Dermis and Subcutaneous layer.....	67
Figure 3.2. The different components of a compound light microscope. ....	71
Figure 3.3. Epithelial cells under 400 x magnification without staining. ....	72

Figure 3.4. Epithelial cells stained using H&E stain under 400 x magnification .....	73
Figure 3.5. QiaAmp <sup>®</sup> DNA Mini extraction protocol with modifications.....	76
Figure 3.6. Boxplot showing the percentage efficiency of recovering cells by swabbing .....	83
Figure 3.7. Scatterplot illustrating the distribution of data for TPH vs %P.....	85
Figure 3.8. Boxplot of TPH based on the different techniques used, 1: direct PCR; 2: Qiagen extraction. ....	86
Figure 3.9. Boxplot of %P based on different techniques, 1: direct PCR; 2: Qiagen extraction.....	87
Figure 3.10. Boxplots of TPH based on different techniques, which were divided into groups based on cell count 1: < 20; 2: 21 - 40; 3: 41 - 60 and 4: > 60. ....	88
Figure 3.11. Boxplots of %P based on different techniques, which were divided into groups based on cell count 1: < 20; 2: 21 - 40; 3: 41 - 60 and 4: > 60. ....	89
Figure 4.1. A light microscopy image showing a smear of blood on a microscopy slide. ....	95
Figure 4.2. Diagram of a human spermatozoa. ....	96
Figure 4.3. Molecular structure of the subunit of cellulose, glucose. ....	97
Figure 4.4. The molecular structure of the most commonly used forms of nylon, Nylon 6 and Nylon 6,6. ....	99
Figure 4.5. Configuration of the PowerPlex ESX 16 kit utilising the five dye detection system.....	101
Figure 4.6. Bar and line graph showing the total peak heights and mean allele peak height obtained from the five fibres tested.....	110
Figure 4.7. Peak heights (rfu) from bloodstained fabric arranged according to marker size and dyes .....	112

Figure 4.8. Regression line indicating a decrease in peak height at the larger molecular weight loci obtained from bloodstained fabrics.....	114
Figure 4.9. Average total peak height and average locus peak height obtained from semen stains on five different fibres tested.....	115
Figure 4.10. Peak heights (rfu) from semen stained fabric arranged according to marker size and dye.....	116
Figure 4.11. Regression line indicating a decrease inn peak height at the larger molecular weight loci for peak heights obtained from semen stained fabrics. ....	117
Figure 5.1. The schematic of Y chromosome and positions of Y-STR. ....	125
Figure 5.2. Singleplex amplification using D22S1045 prime pairs tagged with 6FAM.....	150
Figure 5.3. Singleplex amplification using D1S1656 primer pairs tagged with 6FAM.....	150
Figure 5.4. Singleplex amplification using D2S441 primer pairs tagged with VIC <sup>®</sup> . ....	151
Figure 5.5. Singleplex amplification using D12S391 primer pairs tagged with VIC <sup>®</sup> . ....	151
Figure 5.6. Singplex amplification using D10S1248 primer pairs tagged with NED <sup>®</sup> . ....	152
Figure 5.7. Singleplex amplification using DYS437 primer pairs tagged with NED <sup>®</sup> . ....	152
Figure 5.8. Singleplex amplification using DYS439 primer pairs tagged with PET <sup>®</sup> . ....	153
Figure 5.9. Singleplex amplification using 1F1_1_1-23/1R4_1_64-85 (IPCI) primer pairs tagged with PET <sup>®</sup> .....	153
Figure 5.10. Singlex amplification using 1F1_1_1-23/1R2_1_192-215 (IPCII) primer pairs tagged with PET <sup>®</sup> .....	154



Figure 5.11. Amplification of IPCI and IPCII in one reaction using a shared forward primer. Scale of Y-axis was set at 7000 rfu. ....	154
Figure 5.12. Electropherogram obtained from initial multiplex amplification indicating expected and non specific peaks due to primer cross-reactivity. ....	155
Figure 5.13. Non-specific peaks observed in the amplification reaction with forward primer of D1S1656 and reverse primer of DYS438. ....	156
Figure 5.14. EPG obtained when 0.2 $\mu$ M of all primers were added to the multiplex. ....	159
Figure 5.15. EPG obtained when reverse primer of IPCI was decreased, reverse primer of IPCII was increased and forward and reverse primers of D10 was increased.....	159
Figure 5.16. EPG obtained when forward and reverse primers of D1, D12, D2 and D22 were increased.....	160
Figure 5.17. EPG obtained when forward and reverse primers of D22, D1, D10 and D12 were increased.....	160
Figure 5.18. EPG obtained when D22 primers were altered.....	161
Figure 5.19. EPG obtained using the final primer concentration.....	161
Figure 5.20. A close up of the EPG obtained from polymerase titration experiment; .....	163
Figure 5.21. Split peak was still observed when tested using Bio-X-Act Short. ....	164
Figure 5.22. MgCl <sub>2</sub> titration .....	165
Figure 5.23. D22S1045 initial primer titration with forward primer to reverse primer ratio. ....	167
Figure 5.24. D22S1045 reverse primer titration with 2 $\mu$ M forward primer with decreasing amount of reverse primer .....	167

Figure 5.25. An image of an electropherogram obtained using the optimised multiplex with 0.3 ng of DNA sample.....	168
Figure 5.26. Allelic ladder created for the use during runs with samples amplified with the multiplex. ....	170
Figure 5.27. Testing the optimal DNA input for the multiplex .....	176
Figure 5.28. Sensitivity testing for the multiplex.....	177
Figure 5.29. OL allele for Reference 7 at D1S1656 which was recorded at 115.78 bp .....	183
Figure 5.30. OL allele of Human placental DNA at D12S391 of PowerPlex ESI 16 kit recorded at 345.32 bp.....	183
Figure 5.31. OL allele of Human placental DNA at D12S391 of PowerPlex ESX 16 recorded at 191.01 bp.....	184
Figure 5.32. OL allele of Human placental DNA at D12S391 of Multiplex recorded at 181.09 bp.....	184
Figure 5.33. Cumulative peak height according to locus.....	185
Figure 5.34. Heterozygous peak balance of five STR loci at five different DNA concentrations. Boxplots are colour coded according to loci. ....	186
Figure 5.35. Heterozygous peak balance for 5 STR loci with sub-optimal amounts of DNA. Boxplots are colour coded according to loci. ....	187
Figure 5.36. Heterozygous balance between IPCI and IPCII using 0.01 ng up to 1.0 ng of DNA in the reaction.....	188
Figure 5.37. Stutter peak height ratio for five STR and two Y-STR loci. ....	189
Figure 5.38. Electropherogram obtained from sample C2, showing a dropout of the IPCII fragment indicating the presence of inhibitors.....	194
Figure 5.39. Electropherogram obtained from sample C21 showing that the last peak to drop out in a inhibited profile is the IPCI fragment.....	195

## List of tables

Table 1.1. Typical components and their respective concentration for PCR amplification. ....	8
Table 1.2. STR markers incorporated into commonly used commercial STR kits....	10
Table 2.1. Amplification multi mix components for the different samples amplified.. ....	39
Table 2.2. Amplification protocol for PP16-HS using 2720 thermal cyclers.....	39
Table 2.3. Difference in procedure for Direct PCR and Qiagen extraction kit.....	42
Table 2.4. Multi mix components of PP16-HS for direct PCR and Qiagen extracted samples.....	43
Table 2.5. Multi mix components of SGMPlus for direct PCR and Qiagen extracted samples.....	43
Table 2.6. Comparison of average percentage allelic dropout using PP16-HS and SGMPlus for all substrates with different amounts of DNA. ....	52
Table 3.1. Summary of the amount of DNA obtained from various touched item as reported in literature.....	69
Table 3.2. Reaction volumes for each component of the AmpFISTR SGMPlus used in each amplification reaction.....	78
Table 3.3. Amplification protocol of AmpFISTR SGMPlus with 2720 thermal cyclers.....	78
Table 3.4. Electrophoresis parameters used to run samples amplified with SGMPlus.....	79
Table 3.5. The number of cells present on the slides and on the swab before and after swabbing for samples subjected to direct PCR. ....	81
Table 3.6. Number of cells present on the slides and in the PCR before and after swabbing for samples subjected to QIAamp DNA Micro extraction. ....	82

Table 3.7. Total peak height and Percentage profile for thumbprints deposited on glass microscope slides. ....	91
Table 4.1. Garment and type of fabric used in this study. ....	102
Table 4.2. Reaction volumes for each component of the AmpFISTR SGMPlus used in each amplification reaction. ....	103
Table 4.3. Amplification protocol using AmpFISTR SGMPlus with 2720 thermal cycler. ....	103
Table 4.4. Electrophoresis parameters used to run samples amplified with AmpFISTR SGMPlus. ....	103
Table 4.5. Components of the PowerPlex ESX 16 Multi Mix used for direct PCR of stained fabric. ....	105
Table 4.6. Amplification protocol for Powerplex ESX 16 using 2720 thermal cycler. ....	105
Table 4.7. TPH and %P obtained from volunteer 1 (VA) and volunteer 2 (VB) for 4 replicates. ....	107
Table 5.1. A list of the autosomal STR and Y-STR loci selected for inclusion in the multiplex and their properties. ....	131
Table 5.2. Primer sequence for the selected STR and Y-STR loci, the tagged fluorescent dyes and the melting temperatures ( $T_m$ ). ....	132
Table 5.3. A list of primer pairs generated using FastPCR based on the artificial IPC gene. The primers highlighted were subsequently used in the multiplex. ....	135
Table 5.4. Initial PCR mixtures for singleplex reactions ( $\mu$ L). ....	137
Table 5.5. PCR protocol used for the initial singleplex reactions. The protocol of 28 cycles was used for all reactions. ....	137
Table 5.6. Concentration of various components in the multiplex after optimisation. ....	140

Table 5.7. Run module used for samples amplified with the multiplex. ....	143
Table 5.8. Multi mix preparation for PowerPlex ESI and SX 16 kits.....	145
Table 5.9. Description of mock crime scene samples obtained from two proficiency tests and volunteers. ....	146
Table 5.10. Steps taken to optimise the primer concentration in the multiplex, observations and corresponding EPG obtained.....	158
Table 5.11. Multiplex touchdown PCR protocol using the Veriti Thermal cycler..	169
Table 5.12. Comparison between the expected and observed product size in all the loci.....	171
Table 5.13. Results for the run variation used to create the bins and panels. ....	173
Table 5.14. Peak height of Y-STR alleles obtained with excess female DNA.....	179
Table 5.15. Allele concordance between developed multiplex, PowerPlex ESX 16 (ESX) and PowerPlex ESI 16 (ESI).....	181
Table 5.16. Percentage Profile ( $\%P$ ), Total peak height (TPH) and IPC peak height ratio (IPC PHR) for FTA samples.....	190
Table 5.17. Percentage profile ( $\%P$ ), Total peak height (TPH) and peak height ratio of IPC fragments (IPC PHR) obtained from mock crime scene samples. ....	193
Table 5.18. The minimum number of contributors, the number of Y-STR alleles observed and the IPC PHR for samples with mixtures. ....	196

## **Chapter overview**

Chapter 1 gives an overall introduction to the concepts covered in this thesis. The science of DNA and some basic terminologies used in DNA profiling is explained. A brief history of DNA profiling to the current technique of STR typing together with its significance in forensic analysis is also covered. This goes on to discuss the methods of DNA typing currently used in forensic laboratories together with the caveats of analysing low template DNA and why it has been so controversial in recent years. Finally the direct PCR technique is explained from when it was used in molecular biology to its current standing where its wide application has made it suitable to be used to analyse DNA evidence.

Chapter 2 discusses the differences in DNA profiles obtained when samples were subjected to conventional DNA typing methods and direct PCR. One technique of extraction is compared to amplifying samples without extraction and the quality of the DNA profiles obtained is discussed. This chapter also discusses the quality of DNA profiles obtained when using two different commercially available multiplex kits to amplify samples using direct PCR. The interactions of DNA with different substrates are also explained.

In chapter 3, the ability of direct PCR to produce DNA profiles from buccal cells and fingerprints on glass slides are discussed. The significance of being able to obtain reportable DNA profiles in the presence of very low amounts of DNA using direct PCR is further explained and discussed.

The ability of one commercial STR kit to analyse direct PCR samples obtained from 'touch DNA' and two types of body fluids on different types of fabric is discussed in chapter 4. As these body fluids are known to have inhibitory effects on PCR, the effect of not purifying the samples on the STR kit was observed and discussed.

In chapter 5, a multiplex reaction which can co-amplify both STR and Y-STR loci was developed and validated to be used for direct PCR. Since samples are to be amplified directly, two IPC fragments were included in the multiplex which enables

the detection of the presence of inhibitors in the sample. The advantages of being able to amplify both STR and Y-STR loci in one multiplex reaction are further discussed.

# 1 General Introduction

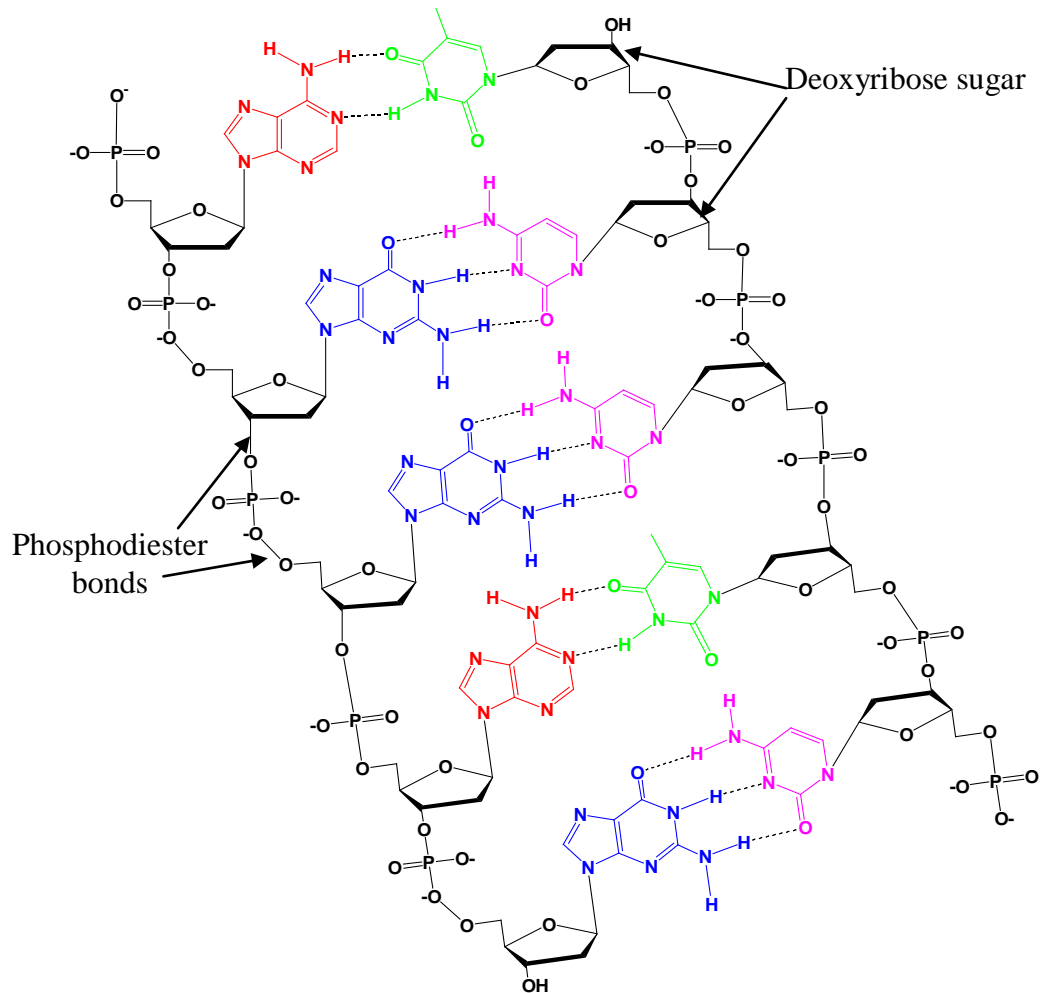
## 1.1 The science of DNA

An average human being is made up of approximately 100 trillion cells, all of which originated from a single cell of a fertilised egg. Within the nucleus of the cells lies the genetic codes which contain a complete set of instructions for making an organism [1]. These genetic codes are called deoxyribonucleic acid or DNA.

DNA is a chemical substance which is made up of three different families of chemicals which in combination is called a nucleotide; phosphate, deoxyribose (sugar) and base, [2] as shown in Figure 1.1. The phosphate group is composed of a phosphorous atom surrounded by four oxygen atoms [2]. It is hydrophilic and acidic in nature and is linked to the sugar moieties on either side by covalent phosphodiester bonds [3]. The phosphate and sugar residues form the backbone of DNA single strands. The bases are hydrophobic and basic in nature. There are four types of possible bases which attach to the sugar moiety through glycosidic bonds; adenine (A), guanine (G), cytosine (C) and thymine (T). Adenine and guanine belong to family called purines, while cytosine and thymine belong to the pyrimidines [3]. The purines and pyrimidines contain carbon and nitrogen atoms arranged in a ring. Purines contain a hexagonal and pentagonal ring fused together, while pyrimidines have just a hexagonal ring [3]. DNA is a helical structure composed of two strands that are linked together through a process called hybridization. Individual nucleotides pair up with their complimentary bases through hydrogen bonds. Complementary bases are governed by the base pairing rule which originated from the Chargaff's rule [4] which states that there's always the equal amount of A to T and G to C in a DNA strand. The base pairing rule states that A always binds to T while G will always bind to C. A binds to T with two hydrogen bonds while G binds to C with three hydrogen bonds, making GC pairing slightly stronger than the AT base pairs. The two strands of DNA are anti-parallel, that is if the first strand is in the 5' to 3' orientation, then the second strand is in the 3' to 5' orientation. By knowing the sequence of one strand,



the sequence of the complimentary strand can be determined using the base pairing rule.



**Figure 1.1. The chemical structure of a DNA molecule showing the phosphodiester backbone, deoxyribose sugars and nucleotides. Provided with courtesy by Dennany L.**

DNA is tightly packed into chromosomes in the nucleus of a human cell. Humans have 22 pairs of autosomal chromosomes which are numbered 1 to 22 by descending length, and two sex determining chromosomes, either XX or XY. Males have one copy of the X chromosome and one copy of the Y chromosome, while females have two copies of the X chromosome. The DNA material in chromosomes is composed

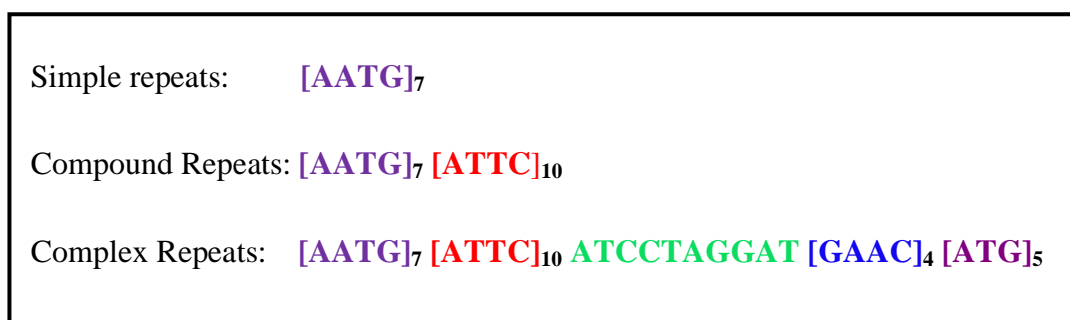
of 'coding' and 'noncoding' regions. The coding regions are called genes, which contain the information needed to make proteins. Genes consists of the protein-coding portion, which are termed exons, and intervening portions called introns. The non-coding regions of DNA are not related directly to making proteins. Markers used for human identity testing are found in the non-coding regions and in the introns, and thus do not code for genetic variation.

The position of a gene or DNA marker is called a locus. Pairs of chromosome contain the same genetic structure and size, thus are called homologous, but may not contain the same genetic information due to mutations. A copy of each gene resides at the locus of the homologous chromosome. One chromosome in each pair is inherited from the mother and the other from the father. The alternate possibility of a gene or marker is called an allele. If two alleles at a locus on homologous chromosomes are identical, they are called homozygous, if they are different, they're called heterozygous. A genotype is the characterisation of alleles present at a locus. A combination of genotypes obtained from multiple loci gives rise to a DNA profile. The differences in the combination of alleles in a DNA profile is used to aid in human identity testing.

## **1.2 Short tandem repeats (STR)**

DNA profiling has evolved since it was introduced by Alec Jeffreys in 1985 [5]. In the early 1990s, STR markers were first described as an effective tool in human identity testing [6, 7]. About 3% of the genome is comprised of STRs [1], of which around 92% are situated in the non-coding regions [8]. STR DNA markers are currently the loci of choice as they offer high power of discrimination and rapidity of analysis. Furthermore, data sharing can facilitate inter-laboratory comparisons and thus, databases can be constructed. Since the loci are short and multiple, many STRs can be analysed simultaneously, giving rise to the term 'multiplex' STR testing. STR or microsatellites consists of tandemly repeated sequences, with repeat motifs of 2 to 6 base pairs in length, and exhibit a high degree of length polymorphism due to the variation in the number of repeat units [9].

STRs are often divided into several categories based on their repeat pattern. The most common repeat pattern used in forensic DNA analysis are ‘Simple’, ‘Compound’ and ‘Complex’ repeats. ‘Simple repeats’ contain units of identical length and sequence, ‘Compound repeats’ contain two or more adjacent simple repeats, while ‘complex repeats’ are comprised of several repeat blocks of variable unit length as well as variable intervening sequences [10]. Examples of simple, compound and complex repeat structures are illustrated in Figure 1.2.



**Figure 1.2. An example of simple, compound and complex repeats. The coloured codes are the repeat sequences and the numbers denote the unit length the sequences are repeated.**

Previous studies showed that it is possible to amplify multiple STR loci in one reaction [7, 11]. The first quadruplex multiplex system using STR loci HUMVWA31/A, HUMTH01, HUMF13A1 and HUMFES/FPS was validated for forensic casework by the UK Forensic Science Service (FSS) in 1994 [12]. The detection of STR products is achieved by the incorporation of fluorescently labelled primers during amplification. These fluorescent dyes are detected by a laser during electrophoresis using an automated sequencer [13-15]. This multiplex system was found to be robust and sensitive, therefore suitable for forensic use [12].

A six STR multiplex system was introduced by the FSS called the Second Generation Multiplex (SGM). It co-amplifies six STR loci HUMTH01, D21S11, D18S51, D8S1179, HUMVWA31/A and HUMFIBRA (FGA), in conjunction with the amelogenin gene, which is homologous on the X and Y chromosomes [16, 17]. The system proved to be human specific and suitable for use with both aged and

degraded materials [16, 17]. This system was highly discriminative displaying a probability of a chance association of  $1 \times 10^{-8}$  [16]. In 1999, Applied Biosystems developed the commercially available AmpFISTR<sup>®</sup> SGM Plus<sup>™</sup> system, which is a ten locus multiplex that comprises the six SGM loci, the amelogenin sex test, along with four additional STR loci, D3S1358, D16S539, D2S1338 and D19S433 [18]. This system was validated for forensic use by the manufacturer, according to the Technical Working Group on DNA Analysis Methods (TWGDAM) guideline recommendations [19, 20]. Generally, STR multiplex systems work at their optimum efficiency when 0.5 ng to 1 ng of DNA is analysed, and 26 to 32 cycles of amplification are carried out [16, 17]. This equates to approximately 80 to 160 cells, given that there is 6 pg of DNA in a 6.2 billion base pair diploid genome [21]. The technology of STR typing now allows for the development of ‘megaplex’ STR systems, simultaneously examining anything up to 21 STR loci per reaction [22, 23].

### **1.3 DNA Profiling Protocol**

#### **1.3.1 Sample Extraction**

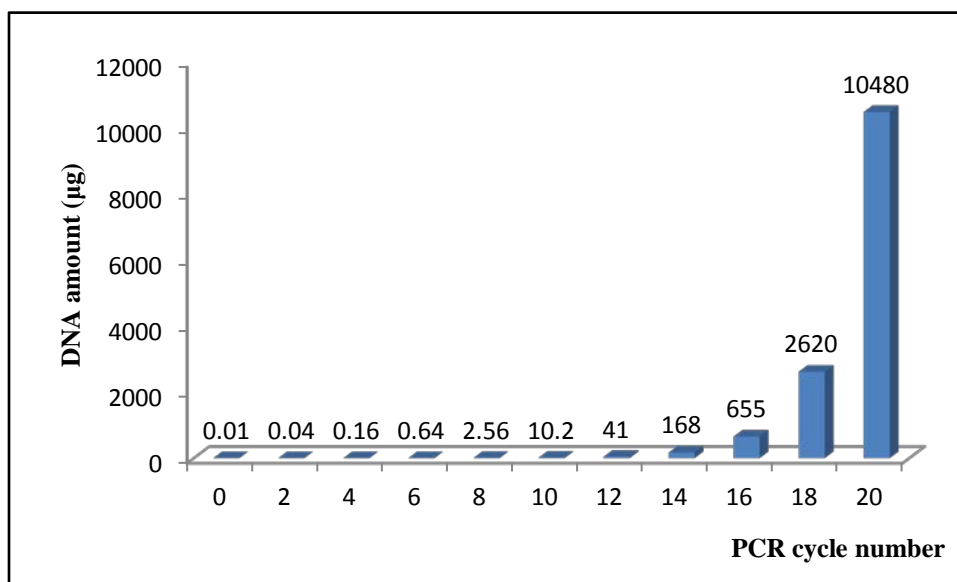
Sample extraction is performed to extract the DNA that is present in the collection material into an aqueous solution, usually water or Tris-EDTA (TE) buffer, for downstream analysis [24]. There are many extraction methods and kits available on the market today. The primary factors that influence the use of these kits are efficiency of the method/kit to extract the DNA, the purity of the DNA yield, and time and costs involved to complete the extraction process. The four extraction protocols most commonly used involves phenol-chloroform, Chelex<sup>®</sup>-100 resin, FTA<sup>®</sup> paper and silica based extraction [25-27]. All these methods involve the degradation of the protein complex, separation of DNA from the protein debris and purification of extracted DNA.

There is an inevitable loss of DNA when samples are subjected to extraction. The multiple tube changes during the extraction and purification steps cause the loss of valuable DNA material. This is not much of an issue when reference samples with

high amounts of DNA are being used. However, when dealing with small amounts of template DNA, such as touch DNA, any small amount of DNA loss will have an impact on the profile generated. When samples are subjected to the extraction process, a loss of up to 30% of valuable DNA is observed, depending on the extraction system used [28]. By omitting the extraction step, particularly for low template DNA, the chance of obtaining a DNA profile can be increased.

### 1.3.2 Polymerase Chain Reaction (PCR)

PCR is an enzymatic process in which a specific region of a DNA molecule is replicated *in vitro* over and over again to yield many copies of a particular sequence [29-31]. This molecular ‘xeroxing’ process involves the heating and cooling of samples in a thermal cycling pattern over a number of cycles, usually ranging from 26 to 34 cycles. The products from the amplification reaction accumulate exponentially with each round of amplification as shown in Figure 1.3.



**Figure 1.3. A graph showing an exponential increase in the quantity of DNA after 20 cycles of amplification starting from 0.01 µg of template DNA.**

During each cycle, a copy of the target sequence is generated for every molecule containing the target sequence. A PCR has the following components: template DNA, at least one set of reverse and forward primers, a thermo stable polymerase, magnesium chloride, deoxynucleotide triphosphates (dNTPs) and a buffer [21]. Forward and reverse primers are short DNA sequences that act to identify the region to be copied and ‘flank’ this region. It is a synthesised oligonucleotide that is added into the PCR in high concentration. Magnesium chloride ( $MgCl_2$ ) is a critical component in PCR which is needed to stabilise the primer-template duplex. It also acts as a co-factor for the *Taq* polymerase to function [32]. The buffer is critical in optimising the pH and salt concentration in the reaction. dNTPs are the “building blocks” that make up the four nucleotides, and the polymerase adds these building blocks to the synthesised strand by following the ‘base-pairing’ rule. The DNA polymerase is an enzyme which is best known for its role *in vivo* in DNA replication, in which the DNA polymerase ‘reads’ an intact DNA strand and attaches nucleotides to form a new strand. In PCR, *Taq* polymerase, a DNA polymerase obtained from the thermophilic bacterium *Thermus aquaticus* is used to make ‘copies’ and multiply the DNA template. However *Taq* polymerase is active at room temperature and causes the formation of primer dimers. Due to their small size, these primer dimers will be preferentially amplified and cause fewer DNA templates to be amplified. To remedy this situation, a modified version of *Taq* polymerase was developed called AmpliTaq Gold™ DNA Polymerase (Applied Biosystems). It is a chemically modified enzyme which is inactive until heated at elevated temperatures of 95°C for approximately 10 minutes [33]. PCR components and their respective optimal concentration range are shown in Table 1.1.

**Table 1.1. Typical components and their respective concentration for PCR amplification.**

<b>Reagents</b>	<b>Optimal concentration</b>
<b>Tris-HCL, pH 8.3</b>	10-50 mM
<b>Magnesium Chloride</b>	1.2-2.5 mM
<b>Potassium chloride</b>	50 mM
<b>Thermal stable DNA polymerase</b>	0.5-5U
<b>Deoxynucleotide triphosphates (dNTPs)</b>	200 $\mu$ M each dATP, dTTP, dCTP and dGTP
<b>Bovine Serum Albumin</b>	100 $\mu$ g/mL
<b>Primers</b>	0.1-1.0 $\mu$ M
<b>Template DNA</b>	1-10 ng genomic DNA

The process of PCR consists of three stages: denaturation, annealing and extension. In the denaturation stage, the sample is heated to 94°C. This causes the hydrogen bonds to break and results in two single stranded DNA molecules. When the temperature is lowered to 50°C to 65°C, the oligonucleotide primers anneal to the template DNA. The temperature is then increased to 72°C, which is the optimum temperature for *Taq* polymerase. The *Taq* incorporates the nucleotides that are complimentary to the template strand to the 3' ends of the primers during the elongation process. At this stage, the hydrogen bonds are formed between the nucleotides of both the DNA strands to form a double stranded copy of the template DNA. These three stages in the PCR process are repeated usually for 26 to 34 cycles, producing tens of millions of copies of the target sequence [34].

### **1.3.3 Multiplex PCR**

The PCR permits more than one region of DNA to be copied simultaneously by simply adding more than one primer set to the reaction mix [16, 17, 35]. A few companies have developed a series of multiplexes that are now widely used in many forensic laboratories, namely Applied Biosystems, Promega Corp. and Qiagen Inc. In addition to the STR loci, the amelogenin locus, which is present on the X and Y chromosomes, has been incorporated into all the common STR multiplex kit to identify the sex of the individual. The STR markers incorporated in the most commonly used commercial STR kits are shown in Table 1.2.



**Table 1.2. STR markers incorporated into commonly used commercial STR kits.**

<b>Locus</b>	<b>SGMPlus</b>	<b>PowerPlex 16 HS</b>	<b>Identifiler</b>	<b>PowerPlex ESI/ESX 17</b>	<b>NGM SElect</b>
<b>D3S1358</b>	√	√	√	√	√
<b>vWA</b>	√	√	√	√	√
<b>D16S539</b>	√	√	√	√	√
<b>D2S1338</b>	√		√	√	√
<b>D8S1179</b>	√	√	√	√	√
<b>D21S11</b>	√	√	√	√	√
<b>D18S51</b>	√	√	√	√	√
<b>D19S433</b>	√		√	√	√
<b>TH01</b>	√	√	√	√	√
<b>FGA</b>	√	√	√	√	√
<b>CSF1PO</b>		√	√		
<b>TPOX</b>		√	√		
<b>D5S818</b>		√	√		
<b>D7S820</b>		√	√		
<b>D13S317</b>		√	√		
<b>Penta D</b>		√			
<b>Penta E</b>		√			
<b>D2S441</b>				√	√
<b>D10S1248</b>				√	√
<b>D22S1045</b>				√	√
<b>D1S1656</b>				√	√
<b>D12S391</b>				√	√
<b>SE33</b>				√	√
<b>Amelogenin</b>	√	√	√	√	√

### **1.3.4 DNA separation and detection**

After the STR polymorphism has been amplified using PCR, it has to be separated according to its length variation. Today, the separation is performed by capillary electrophoresis (CE) as compared to slab gel technology used 10 years ago [21]. There are many instruments that can be used to separate the DNA, but the most commonly used instruments are the 310, 3100, 3130 and more recently the 3500 Genetic Analysers by Applied Biosystems [36]. The array used in CE is a narrow glass tube filled with an entangled polymer solution to separate the DNA molecules. Before electrophoresis, the sample is prepared by mixing 1  $\mu\text{L}$  to 2  $\mu\text{L}$  of the PCR product with 15  $\mu\text{L}$  to 20  $\mu\text{L}$  of a formamide-Internal Size Standard (ISS) solution. The ISS contains fragments of DNA of known lengths that are labelled with fluorescent dyes and are used to size the PCR products while the formamide is used to denature the DNA. Heating the sample at 95°C is done routinely to ensure that the DNA is single stranded when the sample is injected into the array. The samples are transferred into the capillary by electrokinetic injection. When charge is applied, charged molecules, including the amplified DNA and ISS which are negatively charged, migrate towards the positively charged anode, while being separated according to size by the polymer solution. As the PCR products that are coupled with fluorescently labelled primers pass through the laser source, the fluorescent dye is excited and the fluorescence emitted is detected by the charged coupled device (CCD) camera, and then recorded by the collection software [21, 34]. Once the electrophoresis is complete, the polymer in the capillary is flushed out and replaced with fresh polymer for the next sample.

### **1.3.5 Interpretation of raw data**

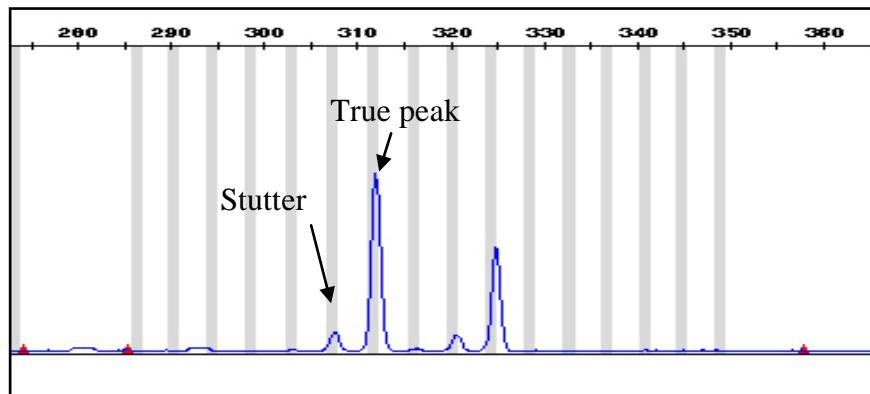
The spectrum of the dyes that are used to label the PCR products overlap and the data contains peaks that are composed of more than one dye colour. The GeneScan® or GeneMapper™ *ID* software removes these spectral overlap in the profile and calculates the size of the fragments using the ISS. The height of the peak is measured in relative fluorescent units (rfu), which is proportionate to the amount of PCR

product that is detected. The minimum threshold for the limit of detection is usually set at three times the standard deviation ( $3 \times SD$ ) the height of the baseline. Most forensic laboratories in the UK set the threshold at 75 rfu for heterozygous and 150 rfu for homozygous peaks. The threshold is not a fixed value and can be adjusted according to the case scientist's judgement. The end result after analysis by the software is an electropherogram with a range of peaks that represent the different loci that were being analysed. Each peak is given a number that corresponds to the number of repeats each loci has. Together with the PCR products, an allelic ladder is also injected and treated as one of the sample. The allelic ladder contains all the common alleles that are found in the population. When assigning the alleles, the unknown peaks are compared to the allelic ladder and should fall within one base pair ( $\pm 0.5$  bp) of the allelic ladder. If the unknown allele differs more than this, then it is labelled as Off Ladder (OL) [21, 34].

The DNA profiles generated require some amount of experience to interpret. This is especially the case when dealing with samples that contain small amounts of DNA, degraded DNA or mixtures of two or more individuals. Artefacts that occur due to amplification inefficiencies or instrument calibration can also cause complications when interpreting the DNA profiles. Some of the common artefacts found in a DNA profile are discussed below.

### 1.3.5.1 Stutter peaks

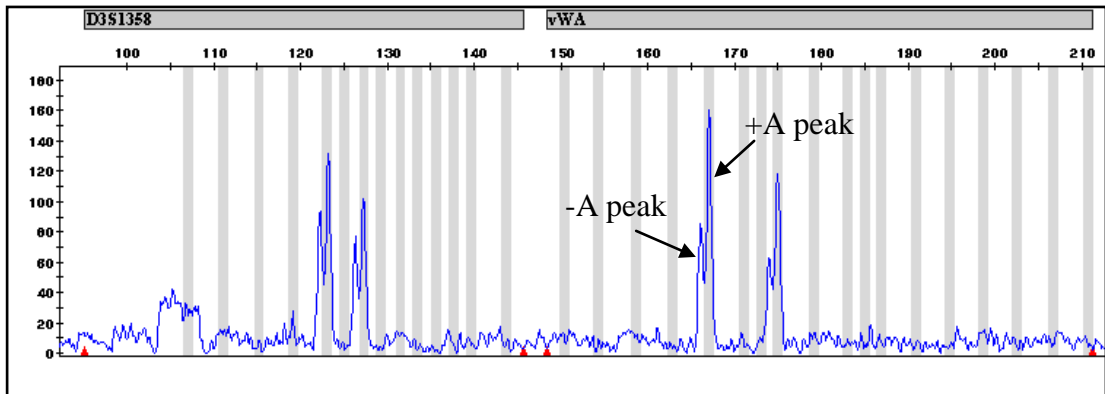
Stutter peaks are peaks that are one repeat unit smaller or bigger than the true allele, with the former occurring more frequently [37]. Stutter peaks are formed by slippage of the polymerase during the extension of the nascent DNA strand during PCR amplification [37-39]. Stutters are usually recognisable and do not interfere with the interpretation of the profile, though caution has to be taken when interpreting mixtures. The stutter peaks are normally less than 15% of the true amplification peak [40]. Different STR loci have different tendencies to stutter. Shorter di- and trinucleotide repeats are more susceptible to stutter than tetra- and pentanucleotide repeats [37]. The amount of stutter produced may also be related to the type of polymerase used. Stutter products have been shown to increase relative to their corresponding alleles with a slower polymerase [37]. Example of stutters is shown in Figure 1.4.



**Figure 1.4.** The position of a stutter peak compared to a true peak. The stutter peak is generally one repeat unit or 4 bp smaller and is less than 15% of the true peak.

### 1.3.5.2 Split peaks

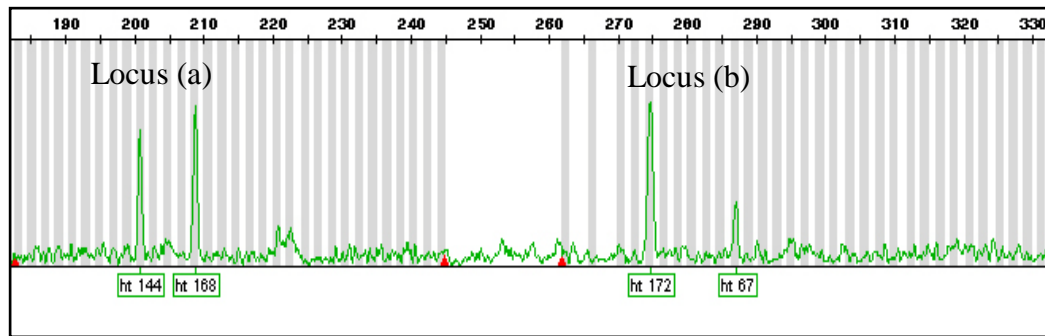
Besides having polymerase activity, the *Taq* polymerase also has an activity, called terminal transferase, whereby it adds a nucleotide to the 3' end of the PCR product, almost always with an adenine moiety [41]. This non-template addition is often referred to as adenylation (+A) and results in a PCR product which is one base pair longer than the actual target sequence. Split peaks occur in incomplete or partial adenylation of the PCR product. It is usually caused either by sub-optimal activity of the polymerase, or by too much template DNA in the PCR. The occurrence of split peaks can be reduced by adding a final incubation step of 60°C to 70°C for 60 minutes during PCR [41].



**Figure 1.5. Example of split peaks with -A and +A peaks. The -A peak is always 1 bp smaller than the actual +A peak.**

### 1.3.5.3 Peak Imbalance

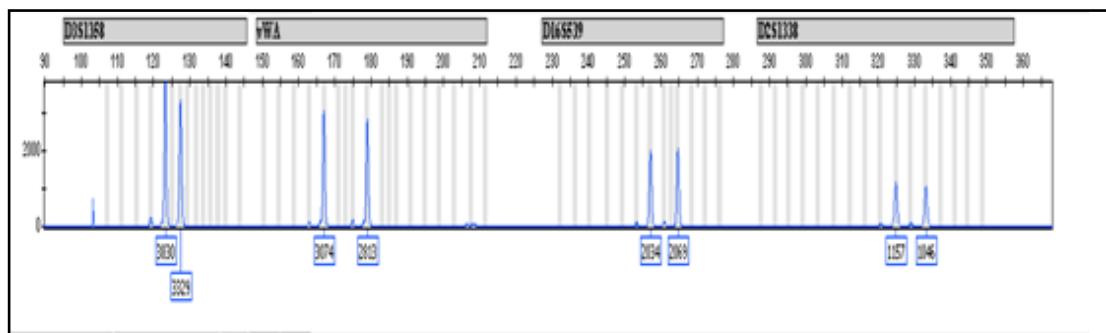
STR loci commonly used in forensic analysis can be either homozygous or heterozygous. A homozygous locus would have a single allele while a heterozygous locus would have two alleles in an electropherogram. In a heterozygous locus the two peaks should be balanced in height and area, but that is not usually the case. The variation in peak height and area is mainly due to the differences in length of the allele, whereby the shorter allele has a higher PCR efficiency and preferentially amplified. In good quality DNA extracts, the smaller peak is usually more than 60% the size of the larger peak [40]. Peak balance can be less than 60% when dealing with degraded DNA or low amounts of template DNA. On very rare occasions though, mutations on the primer binding site can cause reduction in PCR efficiency for one allele, which then results in severe peak imbalance, or even allelic drop-out. New multiplexes have been developed which are called reduced size STRs or MiniSTRs with the primers positioned close to the repeat regions of the STR, thereby minimising the length of the amplicons and increase the tendency of obtaining a DNA profile.



**Figure 1.6. A comparison between balanced and imbalanced alleles in two different loci. A good profile should have peak height ratios at least 60%. Locus (a) shows a peak height ratio of 85% while locus (b) shows a peak height ratio of 39%.**

### 1.3.5.4 Degraded DNA

Samples that are commonly found at the crime scene may have been exposed to the environment for hours, days, or longer prior to collection. In cases of identifying human remains, the remains may be several years old before they were found and therefore would have been exposed to severe environmental insult such as high temperatures or humidity. All these conditions can cause DNA in the cellular material to degrade. Degraded DNA has a characteristic profile whereby there is over amplification of the smaller loci and the successful amplification declines as the size of the alleles increase. Interpretation of a degraded DNA profile becomes tricky when there is a homozygous locus present, as questions if that homozygous locus is a true homozygous or if it is a heterozygous succumbed to allelic drop-out. MiniSTRs are found to increase the potential of obtaining a DNA profile from degraded samples [42, 43].



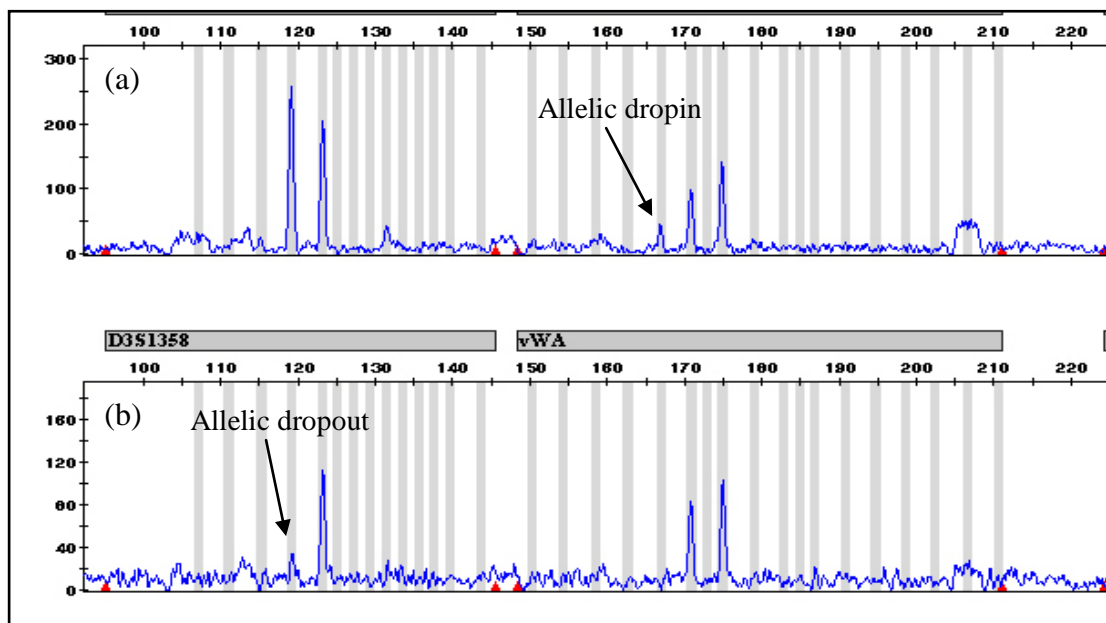
**Figure 1.7. PCR product reduces with increased in size. Longer DNA fragments succumb to degradation easier than shorter fragments. Provided with courtesy by Thanakiatkrai [44].**

### 1.3.5.5 Allelic drop out

Allelic drop out occurs when there is too little DNA in the template, when the sample is degraded or if there is a mutation in the primer binding site on one of the alleles. The normal DNA template range should be between 500 pg and 1000 pg (1.0 ng) in order to obtain a good profile. Allelic drop out is most prominent when dealing with heterozygous peaks, where one allele is preferentially amplified, causing the other to be present below the threshold value, thus ‘dropping out’ [45].

### 1.3.5.6 Allelic drop in

Allelic drop in is a common phenomenon when amplifying low amounts of template DNA. It is an observation when single alleles are detected in a profile which are not supposed to be present in the sample. They are most often traces of fragmented DNA found either in the laboratory environment, reagents or plastic-ware used in the amplification process [45, 46].



**Figure 1.8.** This figure shows two DNA profiles originating from the same source. Profile (a) has an allelic drop in whilst profile (b) has an allelic dropout.



#### 1.4 Analysis of low template DNA

Generally the lower limit of sensitivity recommended by the manufacturer of a multiplex STR kit is about 250 pg [47] with a 28 cycle amplification protocol [48]. Nevertheless, researchers are always finding ways to increase the sensitivity of the methods [47]. There are a number of ways that have been used to increase the sensitivity of a method, including but not limited to nested PCR [49], whole genome amplification (WGA) [50], increased sample injection [51] and post-PCR purification [52]. Nested PCR has been used to amplify single cells since 1994 [49, 53]. In this technique two sets of primers are designed; the external primer pair is used for 15 to 25 cycles followed by an internal primer pair that amplifies a further 15 to 25 cycles [49]. Following the initial rounds of PCR using the external pair, the resulting amplification product is transferred to another tube which contains fresh buffer, *Taq* and the internal pair of primers [54]. Nested PCR has shown to increase specificity and sensitivity of the reaction [49, 54]. However, the opening of the PCR tube after the external primer reaction can potentially introduce contamination to the sample.

Another technique which has been used to increase sensitivity is the low copy number analysis (LCN). The term LCN was first coined by Gill *et al.* for amplification of less than 100 pg of DNA using a 34 instead of 28 cycle amplification protocol [45]. LCN has proved to be a success with samples such as bone [55], touch DNA [56] and hairs [57]. Countries like the UK and New Zealand have adopted this technique in the examination of crime scene samples [45, 58]. Though it has been a success in some cases, there have been some caveats about this technique. Studies have shown that the amount of artefacts that are detected above 34 cycles outweigh the benefits of increased sensitivity [45]. LCN analysis suffers from several disadvantages, primarily due to stochastic variation. When chance amplification occurs in the early stages of amplification allele drop-out, drop-in, severe peak imbalance, locus drop-out and increased stutter is observed [45]. Because there is an increase of these artefacts when using LCN, Gill *et al.*

recommended that all samples subjected to LCN analysis be analysed in duplicate and a consensus profile created to show reproducibility [45, 59]. As less than 100 pg of template DNA is already being used, decreasing the DNA template by dividing the sample into two for duplicate analysis only further exacerbates the success rate of obtaining good quality profile. As the cycle number increases, incidences of in-house contamination became unavoidable. In these instances, negative controls do not act as a reliable indicator of low-level contamination and cannot be used as such [45]. To circumvent around this issue, WGA, post PCR purification and increased sample injection were tried but they too suffer from the same analytical problems [52, 60, 61].

LCN has been shrouded in doubt as to whether the term refers to the increased cycle technique (34 cycles), the interpretation criteria and/or the stochastic effects observed [62]. In 2007, LCN analysis came under close scrutiny when the main suspect in the Omagh case trial was exonerated based on the results of DNA analysis which were obtained using LCN increased cycle technique [63]. This prompted further debate on the robustness of the technique and its suitability to be used to analyse forensic evidence [64-68]. In view of these events, LCN has been deemed unsatisfactory by some as a technique and this has prompted this research into a technique to address the problems observed with low template DNA samples. In 2010, Gill and Buckleton recommended that the term LCN be abandoned and the term Low Template (LT) DNA be used instead to refer to low levels of DNA template [62]. However, the debate on LCN or LTDNA is still ongoing, and the general acceptance of the increased cycle number to increase sensitivity is still debatable [65, 66].

For the purpose of this thesis, LT-DNA will be used to refer to the low levels of DNA used as template for PCR and LCN will be used to refer to the technique of increasing the number of PCR cycles as a mode of enhancement.

## 1.5 Direct PCR

Direct PCR is a technique where samples are subjected to amplification without first having to go through the extraction process. Direct PCR has been widely used in molecular microbiology since 1989 [69], where it is more commonly known as colony PCR. Colony PCR is used as a rapid screening method for large numbers of bacterial cells for a gene of interest [70, 71]. It can be used to confirm success of ligation of a gene of interest into a plasmid and transformation of plasmids into bacterial cells. It has been known to be more cost effective and less time consuming compared to conventional miniprep techniques. To perform colony PCR, well isolated colonies are picked up by either using a pipette tip or a toothpick, suspended in either sterile distilled water or TE buffer and incubated at 95°C for about 5 to 10 minutes [70]. An aliquot of the suspension is then subjected to PCR. It is also possible to skip the incubation step and suspend the colony in the PCR master mix and proceed for amplification. Besides immersion in a hypotonic solution (water), high temperatures during the initial hot start cycle will aid in rupturing bacterial cell walls and release the bacterial DNA/plasmid into the master mix to be subsequently amplified. The same principle behind colony PCR is also applied in direct PCR.

Currently there are many applications to direct PCR. Direct PCR is used to identify target DNA sequence of pathogens in clinical samples to decide on the treatment strategy [72, 73]. Often diagnosis is achieved with standard PCR but even this takes time as the samples will first have to undergo extraction and purification. With direct PCR, rapid diagnosis followed by treatment is possible. A multiplex protocol for detection of virulent genes in *E.coli* in cases of severe food poisoning has also been found successful by using direct PCR [74]. Direct PCR has also been used in botany whereby plant DNA is amplified directly from the leaves [75, 76].

The use of direct PCR in forensic science is currently being explored after its introduction in molecular biology 20 years ago [69]. Direct PCR has been used to amplify buccal and bloodstained FTA<sup>®</sup> cards [77, 78], and various crime scene samples [79-81] especially those with blood and semen stains. Semen stains are quite

common in sexual assault cases, where sperm cells are the main source of DNA from the (often male) offender. Unlike epithelial cells, sperm cells need more stringent techniques to release their DNA due to their structure [82]. DNA contained in the sperm heads are tightly associated with a group of proteins called protamines, which make the sperm DNA highly condensed [82, 83]. This makes obtaining DNA from sperm cells challenging, however by increasing the incubation time at high temperature during the hot start cycle, it was possible to obtain DNA from sperm cells using direct PCR [81].

There are a few concerns with direct PCR. Firstly, inhibitors present in samples such as blood, soil and denim may inhibit polymerase enzymes. Blood contains haematin and various other compounds which are known inhibitors to polymerase enzymes [84, 85]. Samples which have come in contact with soil might have humic acid which is also a known inhibitor [86, 87]. Samples deposited on denim usually pose problems in obtaining DNA profiles due to the presence of indigo dyes [88, 89]. There has been advancements in buffer-polymerase technology which can reduce the influence of these inhibitors on the PCR process [90]. An indication of the presence of inhibitors in the sample, such as the use Internal PCR controls (IPC) in multiplexes, could be useful to differentiate no profiles obtained due to insufficient template DNA and those caused by inhibitors, and to decide if purification is necessary in order to obtain a good quality DNA profile [91]. Secondly, the absence of a quantification step complicates STR analysis as most multiplexes work best within a narrow range. No profiles might be observed when amplifying less than 200 pg of DNA, whilst amplifying more than 2 ng might give rise to various artefacts that complicate interpretation [48, 92]. Without being able to find out how much DNA is in the sample, finding the right balance in DNA quantity would be an issue. That is why there are strict guidelines to follow when using commercial direct PCR kits available in the market.

The immergence of commercial direct PCR kits in the market in recent years has shown that there is potential for this technique to develop. Most of the kits target

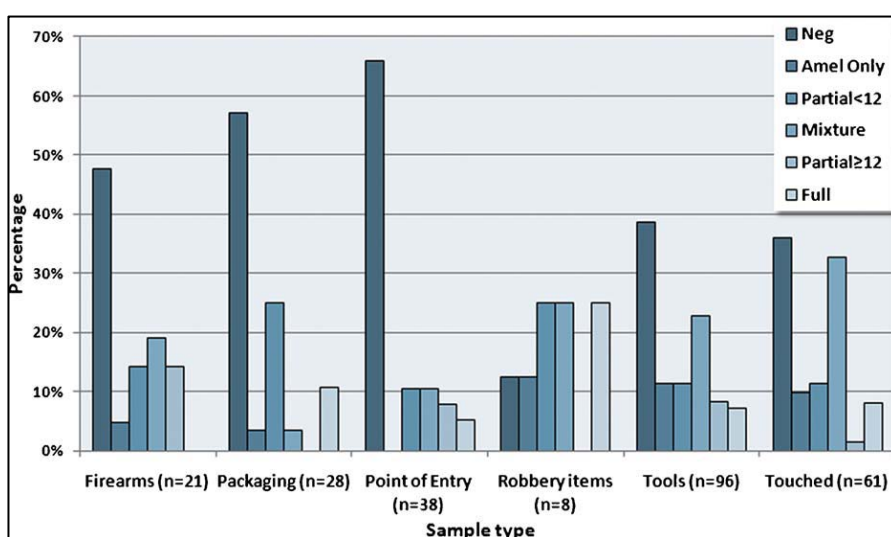
FTA<sup>®</sup> samples deposited with blood or buccal cells [93-95]. These kits are specifically designed to cater for database or paternity cases where the majority of samples analysed are FTA<sup>®</sup> cards. Components of FTA<sup>®</sup> cards include agents to lyse blood cells and preserve DNA from further degradation [96, 97]. These components, if not removed prior to PCR can inhibit most DNA polymerases. The direct PCR kits have better buffer systems which allow the amplification of blood cells on FTA<sup>®</sup> without the need for prior washing [93, 94]. However, there have been reports of less satisfactory results obtained from buccal cells collected using Omni swabs indicating that these kits may not be as versatile in their application [98].

### **1.5.1 Why use direct PCR?**

In 2004, the UK government published the Police Science and Technology Strategy which highlighted the need to continue improving police capabilities in the areas of recovering evidence and rapid analysis of body fluids and other relevant forensic samples [99]. Based on the recommendations of this strategy, Mennell and Shaw [100] identified drivers for the improvements highlighted by this strategy which include the development of faster, better and cheaper forensic science. The speeding up of the investigative process leads to benefits such as increased public confidence in the process of investigation, reduced crime by catching offenders earlier and reduced overall cost of an investigation [100]. By subjecting forensic samples to direct PCR, it has the potential of obtaining DNA profiles faster, with an increased chance of obtaining a good quality DNA profile, and at a reduced cost compared to conventional DNA profiling procedures.

Most of the samples so far typed using direct PCR have been blood, semen or buccal cells. No reports have been obtained to date on the use of direct PCR to analyse low template DNA samples in forensic casework. When samples are subjected to extraction, there is a significant loss of DNA regardless of which extraction method is applied [28, 101]. When dealing with low template DNA where less than 100 pg of starting template is obtained, any further loss of DNA can considerably affect the quality of DNA profiles obtained. In a study carried out by Raymond *et al.* [102]

where various touched items were subjected to conventional DNA profiling, almost half of the samples tested did not produce a DNA profile while only 8% of the samples gave full single DNA profiles (Figure 1.9). Factors that are thought to influence loss of DNA during extraction are the number of tube changes, the number of washing steps and the capacity of DNA to adsorb to matrices [101]. If it is possible to influence any one or more of those factors, the loss of DNA can be significantly reduced. There is also an increased risk for sample contamination and transfer error because of the increase in sample handling time during extraction.



**Figure 1.9. Completeness of DNA profiles obtained based on type of touch samples. Adapted in full from [102]. Reproduced with permission.**

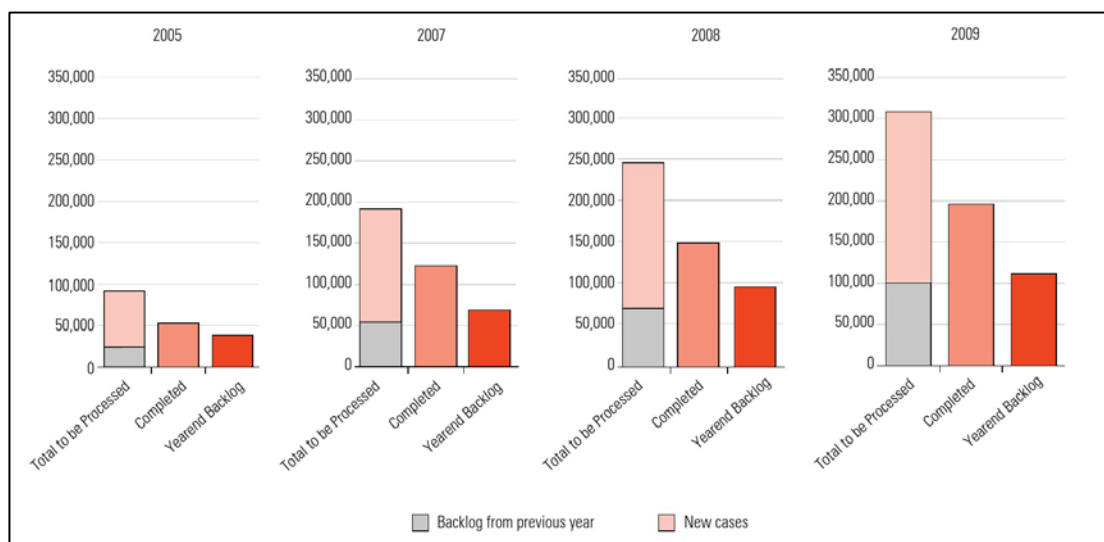
With direct PCR, there is no tube transfer and purification steps involved after the initial transfer of sample into the PCR tube [103]. Therefore, the loss of DNA associated with tube transfers and washings can be eliminated. Since the PCR tube is the only tube the DNA comes in direct contact with, there is minimal loss of DNA due to adsorption to polyethylene reaction tubes [104]. By subjecting DNA samples to direct PCR all three factors leading to loss of DNA can be minimised. Furthermore, reduction in tube transfers leads to the possibility of less handling errors such as contamination, transfer error or loss of samples [103, 105].

The number of cases subjected to forensic analysis in recent years has increased significantly [106]. The implementation of the DNA Expansion Program in 2000 by the British Home Office saw a 74% increase in DNA material collected, a 76% increase in DNA submitted for processing, and a 32% increase in crime scene samples uploaded into the National Database over the course of the program [107]. Following the success of the DNA Expansion Program, the U.S. Department of Justice implemented a similar program called the DNA Field Experiment to evaluate the expansion of DNA evidence collection and testing to the investigation of property crimes [108]. Prior to this, DNA evidence was almost exclusively used to investigate violent criminal incidents [108].

Since the implementation of these two programs, more samples are collected and submitted for DNA analysis especially those involving volume crimes like burglary and vehicle crimes [108]. Samples obtained from volume crimes involve body fluids and swabs of touched items from entry and exit points, searching the house, gathering items, tools and items left behind and disposing of items [108]. In a report put together by the US Department of Justice, it showed a significant increase in the number of cases received and the number of yearend backlogs from 2005 to 2009, which is illustrated in Figure 1.10 [109]. The same report claims that the demand for DNA testing is rising due to the increased awareness of the potential value of DNA evidence [109]. There has been an increased request for analysis of 'touch DNA' samples because of the awareness that it is now possible to test smaller amounts of DNA [109]. By implementing direct PCR for these samples, the amount of time it would take to extract, purify and quantify the sample can be eliminated altogether, and with faster turnaround for DNA analysis exceptionally quick arrests of offenders can be achieved [100].

Tilley and Ford [110] in 1996 were the first to raise the issue of processing DNA material from crime scene and recommended that the time taken should be reduced by both the police and the forensic science service providers in order to maximise the opportunities to solve crime with DNA evidence. Fast-tracking of investigations

involving DNA evidence has shown that it leads to more suspects being charged as a result of DNA matches [111]. Fast-tracking was a joint initiative between a UK police force and forensic science provider to speed up investigation of residential burglary offenses where DNA material had been recovered [111, 112]. With the implementation of this initiative, the duration of a burglary being reported and a suspect being charged was reduced from an average of 89 days to 45 days [111, 112]. With direct PCR, this duration could further be reduced as it eliminates the need for the extraction and quantification steps.



**Figure 1.10. The number of cases and yearend backlogs from 2005 to 2009 in the US. Adapted in full with permission from [109].**

Since the UK police force faced budget cuts of 20% after the government’s spending review recently, costs involved for forensic analysis has been an issue [113]. Direct PCR is more cost effective as there is no need for expensive extraction, purification and quantification kits. Given that in most laboratories the principle cost lies in wages, the net labour time (*i.e.* the actual hands on time needed performing extraction, purification and quantification) is a good indication of the cost involved to generate a DNA profile [105]. A commercial extraction kit can cost around £200 to £400 for every 100 samples [114, 115], while a quantification kit can cost around £370 to £430 for every 200 samples [116-118]. The time involved to extract and



quantify a batch of DNA samples can be anything from an hour to a few days, depending on the extraction methods used. If the net labour time is taken into account together with consumable and reagent costs, these figures can increase significantly. If the extraction, purification and quantification processes are eliminated, the amount of time and resources spent on a sample is reduced, and so would the net cost of processing each sample.

## **1.6 Aims and objectives**

The objectives of the work described in this thesis are:

- ❖ To evaluate the use of direct PCR to be used in forensic DNA profiling. This was carried out by first using direct PCR to amplify genomic DNA materials, then subsequently epithelial cells, fingerprints, touch DNA and blood and semen stains.
- ❖ To determine if the substrate DNA is deposited on has an effect on the generation of DNA profile using direct PCR. Various non-porous substrates, glass, plastic, stainless steel and ceramic; and various dyed fabrics white cotton, denim, dyed cotton and nylon; were tested and the effect the substrate had, if any, on direct PCR was discussed.
- ❖ Finally, a novel multiplex which co-amplifies autosomal STR and Y-STR which also includes Internal PCR Control for the detection of inhibitors was developed and validated to be used with direct PCR.

## **2 Comparison of Direct PCR and extraction of DNA traces recovered from four different substrates**

### **2.1 Introduction**

This chapter describes the initial testing of direct PCR by comparing it with conventional DNA profiling method. The work carried out in this chapter was necessary to evaluate the potential of direct PCR using known amounts of DNA in comparison with a commonly used extraction method.

#### **2.1.1 DNA recovery by swabbing**

When body fluids or dried stains are found at a crime scene which might contain human cells and a forensic analysis should be performed, the area of interest is usually rubbed with a swab to retrieve the sample and transfer it to the lab. There are various swabs available on the market for the retrieval of DNA, but the cheapest and most commonly used are cotton swabs [119]. Cotton swabs consist of a small wad of cotton wrapped around a shaft, usually made of plastic, wood or rolled paper.

A common approach for the recovery of dried stains is the so-called double swab technique [120, 121]. In this technique, a moist swab is first used to rehydrate and lift the cells/DNA; while a second dry swab is used to further recover any remaining cells/DNA [121, 122]. Epithelial cells adhere more easily to cotton swabs in their rehydrated state [121, 123]. The theory behind the recovery of DNA/cells using the double swab technique is that when moisture from the first wet swab is applied to the surface, epithelial cells and DNA are rehydrated which makes them adhere easily to the cotton fibres. The dry second swab is then used to recover remaining cells and DNA through capillary action by reabsorbing the moisture and rehydrated cells/DNA present on the surface of the substrate [121, 123]. The double swab technique has obvious advantages when extracting samples since both the first and second swabs are combined to yield a single extract. For direct PCR, only a small portion of the swab is used and therefore, the double swab technique was not suitable for this application. Due to the limitations of the double swab technique, a single swab was

used in this study to retrieve known amounts of DNA material from various substrates. It is thought that by prolonging the duration of swabbing, a single swab can have the advantages of the double swab technique. When moisture is applied to the swab, the process of swabbing would spread the moisture around the surface of the substrate, rehydrating the DNA and cells present. During prolonged swabbing, most of the moisture would have been applied onto the surface which dehydrates the swab, and when the swab is sufficiently dehydrated, it would then act as a dry swab by recovering cells/DNA present through capillary action.

The work involved in this chapter investigated three different DNA recovery methods and the effects of various substrates on which DNA was adhered to have on DNA recovery, while work carried out in Chapter 3 would further explain the efficiency of the swabbing technique used in this study in comparison with the double swab technique.

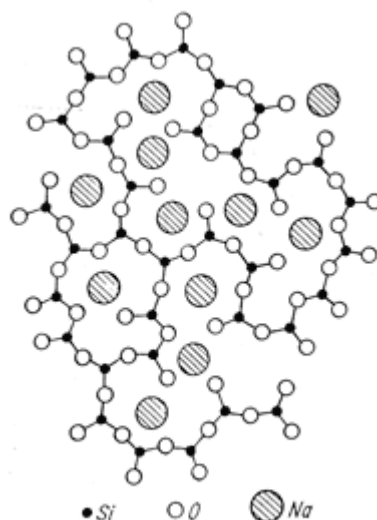
### **2.1.2 Substrates**

The popular use of glass, plastic, ceramic and stainless steel in our living environment make them one of the most frequently encountered surfaces at crime scenes and they often come in contact with either the victim or the perpetrator. It is quite common to find palm and finger prints on windows, bottles, or heavy blunt objects, traces of saliva on drinking bottles and mugs, or blood spatter on floor and wall tiles, which are then usually dusted for prints or swabbed for DNA analysis.

The substrates used in this study were glass (microscope slides), plastic (pipette box lids), ceramic (glazed tiles) and stainless steel (kitchen tiles), which represent the common non-absorbent surfaces encountered in a crime scene.

### 2.1.2.1 Glass

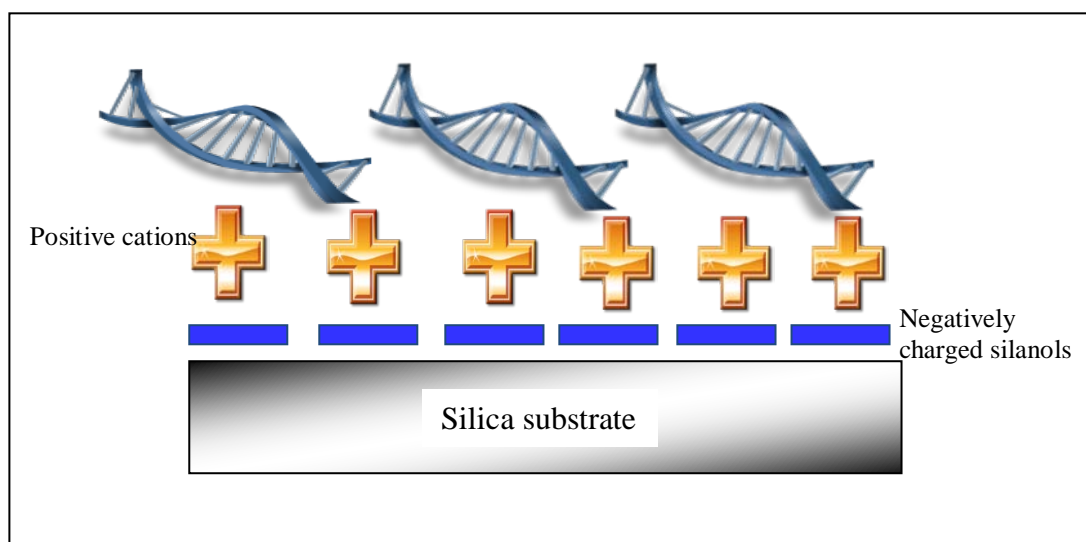
Glass as we know it is a man-made product, although it can occur naturally where molten rock is cooled rapidly, such as near volcanoes, where molten magma is rapidly cooled when exposed to air or water. The basic component of glass is silicon dioxide ( $\text{SiO}_2$ ), with other components being added to achieve specific properties. Glass is produced by fusing and heating inorganic materials in suitable quantities and rapidly cooling the material, thus preventing crystallization from occurring. The atomic structure of glass differs from that of crystalline structures, but is quite similar to that of liquids, where they both lack long-range regularity, as shown in Figure 2.1.



**Figure 2.1. Typical network structure of a sodium silica glass in 2 dimensions. Si: silica, O: Oxygen, and Na: sodium atoms. Adapted in full with permission from [124].**

The interaction between glass and DNA has long been established [125] and has been widely used in many applications such as DNA microarrays, microchip technology, and nucleic acid purification kits [126, 127]. The interaction between DNA and glass is attributed to the hydrogen bonding between surface silanol groups and the phosphate-sugar backbone of the DNA molecule [128]. Silanols are compounds containing the Si-OH group. The interaction of DNA with silica is dependent on pH and ionic strength of the solution. The surface of silica in contact

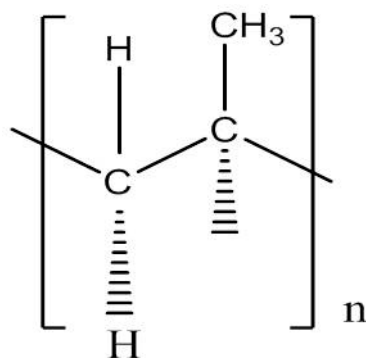
with acidic/neutral deionised water (low ionic strength) is negatively charged, because some of the surface silanol groups dissociate ( $-\text{Si-O-H} \rightleftharpoons -\text{Si-O}^-$ ) [129]. This causes an electrostatic repulsion as the DNA molecule has an overall net negative charge [130]. In acidic high ionic strength solutions, DNA molecules adsorb to the silica surface as the cations from the solution form a positively charged double layer which the DNA molecules can interact with (Figure 2.2) [127, 130].



**Figure 2.2.** In the presence of acidic high ionic strength solution, DNA molecules interact with the cations which form a positively charged double layer with the negatively charged silanols.

### 2.1.2.2 Plastic

Plastic is a type of synthetic or man-made polymer, very similar to natural resins found on trees and plants [131]. Natural gas and oil are the two major raw materials used to manufacture synthetic plastic [131]. The plastic that was used in this research was polypropylene. Polypropylene is widely used as food storage containers, textiles, laboratory consumables, automotive components, and polymer banknotes due to its resistance to many chemical solvents, bases and acids. The polypropylene monomer has a molecular formula of  $(\text{C}_3\text{H}_6)_n$  with a molecular structure shown in Figure 2.3.



**Figure 2.3. The basic subunit of the polypropylene polymer.**

Plastic has been used in microfluidic technologies to replace glass because it is relatively cheaper to manufacture and easier to manipulate in mass production [132]. Because of its hydrophobicity, polypropylene substrates have to be treated in order for it to be used as microchips. Gaillard and Strauss discovered that even though the physical characteristics of polypropylene (very hydrophobic) and DNA (highly charged) should minimise their interactions, there is still sufficient interaction that results in significant loss of DNA [104]. This loss was attributed firstly due to DNA sticking to the tube walls, and secondly, denaturation or change in structural conformation of DNA strands when bound to polypropylene surfaces [104, 133, 134]. When trying to recover very low levels of DNA, there could be a significant amount of DNA left behind on the surface of substrate which could subsequently impair the quality of the DNA profiles generated.

### **2.1.2.3 Ceramic**

Ceramic is an inorganic, nonmetallic material which is formed from molten substances which is then cooled to form solids [135]. The types of ceramic ranges from structural, including bricks and tiles, to engineering, which are used in space shuttle programs and ballistic protection, just to name some of its uses. Ceramic is also widely used as tableware, cookware and utensils, which makes them common

items in households. Ceramic materials are brittle, hard, and strong in compression, able to withstand chemical corrosion and high temperatures [136]. Composition of traditional ceramic is mainly clay which contains alumina ( $\text{Al}_2\text{O}_3$ ) with some iron oxide, which gives it its distinctive red-orange colour. The ceramic tile used in this study was glazed to give it a white smooth finish. Glazes generally contain silica in combination with a mixture of metal oxides such as aluminium, sodium, potassium and calcium. The various metal oxides present on the surface of ceramic may cause a difference to the interaction between DNA and the substrate as was observed by Nguyen *et al.* [130].

#### **2.1.2.4 Stainless steel**

Stainless steels derive their name from their nature when exposed to the environment under normal temperatures which causes ordinary steel and iron to tarnish and rust [137]. Any piece of iron or steel is immediately covered in a thin layer of oxide when exposed to the environment. In ordinary steel and iron, the iron oxide layer is active, and accelerates the formation of rust. In stainless steel, which contains no less than 11% chromium, oxidation produces a thin film of chromium oxide, which prevents the metal from further oxidisation, and the surface remains bright because the film is too thin to be visible, giving it the ‘stainless’ property. Stainless steel is preferred to common steel in many household appliances due to this property and is commonly encountered as potential weapons at crime scenes.

#### **2.1.3 Pre-PCR treatments**

Standard protocols in forensic DNA laboratories will almost always involve extracting crime scene samples and quantifying them before subjecting the sample for amplification and electrophoresis. Extraction is thought to be an essential step as it purifies the DNA from unwanted materials such as proteins, metallic ions, dust/dirt, and other materials that may inhibit the polymerase at the amplification stage [138]. The extraction method used as comparison to direct PCR in this study is a silica-based extraction method from Qiagen called the QiaAmp<sup>®</sup> DNA Micro

extraction kit [139]. In this extraction method, nucleic acids selectively bind to the silica-gel membrane in the presence of high concentrations of a chaotropic salt, guanidine hydrochloride. These chaotropic salts act by disrupting the hydrogen-bonding networks in liquid water and make denatured proteins and nucleic acids more thermodynamically stable than their correctly folded counterparts [140]. In an acidic solution, the adsorption of DNA to the silica membrane is most efficient and the unwanted impurities are washed away. In an alkaline environment with low salt concentrations, the DNA bound to the silica membrane will elute. The QIAamp DNA Micro extraction procedure as recommended by the manufacturer is illustrated in Figure 2.6 [139].

#### **2.1.4 Multiplex kits**

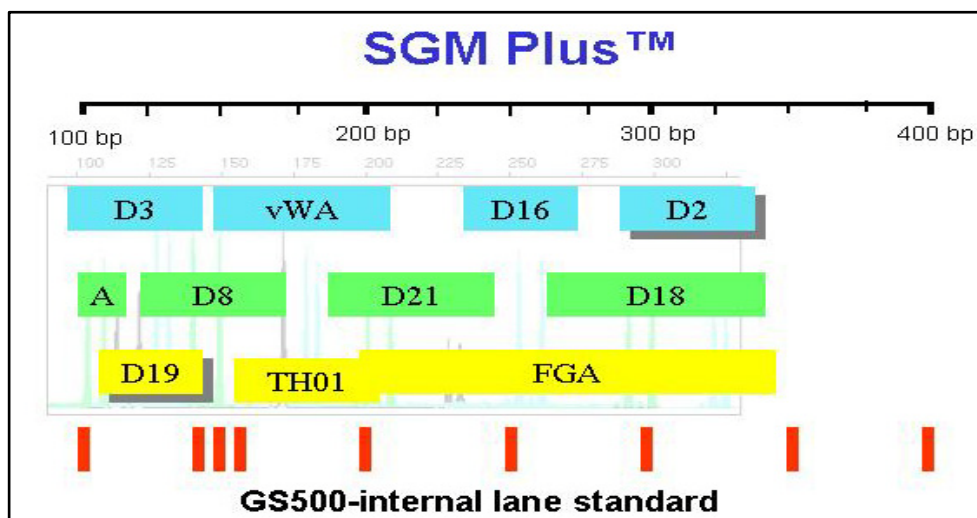
Forensic DNA profiles are obtained by the use of commercially available multiplex PCR kits, which has been explained in 1.3.3. The two most commonly used kits in Europe are the AmpFISTR SGMPlus (Life Technologies) and PowerPlex 16 (Promega Corporation) which will be discussed further in this chapter.

##### **2.1.4.1 AmpFISTR SGMPlus**

The Second Generation Multiplex Plus (SGMPlus, would be referred to as SGMPlus from here on) is an extended version of the Second Generation Multiplex which was developed by the Forensic Science Service (FSS) in the UK [16]. SGMPlus consists of six SGM Short Tandem Repeat (STR) loci FGA, TH01, vWA, D8S117, D18S51, D21S11, and a sex determination locus amelogenin, plus four additional loci D2S1338, D3S1358, D16S539 and D19S433 [18, 48, 141]. It utilises the Filter Set F dyes, which are 5-FAM (blue), JOE (green) and NED (yellow) labelled STR primers, and ROX (red) as the Genescan-500 Internal Lane Size Standard [48]. The alleles range from the smallest of 107 bp to the largest of 353 bp. Figure 2.4 illustrates the loci size range and fluorescent labels associated with each primer. Currently in the UK, SGMPlus is almost exclusively used for routine forensic DNA analysis as to allow easy comparison between the unknown crime scene sample and UK DNA



database generated DNA profiles [142]. An arbitrary conservative estimate of one in one billion is reported for a match probability of a full SGMPlus DNA profile between unrelated individuals [143].



**Figure 2.4.** General size ranges in basepairs (bp) for each loci and dye labelling strategies (indicated by the colour of the boxes) for the AMPF/STR SGMPlus kit. Adapted in full with permission from [144].

#### 2.1.4.2 PowerPlex 16 HS

The PowerPlex 16 HS (PP16-HS) is an updated version of the PowerPlex 16 system, which was developed for forensic analysis, relationship testing and research [92]. Both these systems contain the same primers, dyes, size standards and allelic ladder, with the PP16-HS system having a Hotstart *Taq* DNA polymerase-buffer system [145]. It enables co-amplification of 15 STR and amelogenin loci which includes D3S1358, TH01, D21S11, D18S51 and Penta E primers labelled with Fluorescein (blue), D5S818, D13S317, D7S820, D16S539, CSF1PO and Penta D labelled with JOE (Green), while vWA, D8S1179, TPOX, and FGA primers are labelled with TAMRA (yellow) with the CXR (red) dye as the ILS600 Internal Lane Size Standard [21]. Components of the allelic ladder range from the smallest of 106 bp (amelogenin) to the largest of 444 bp (FGA) [92]. The power of discrimination for a full profile on the PP16-HS kit was conservatively given as 1 in  $10^7$  [92].

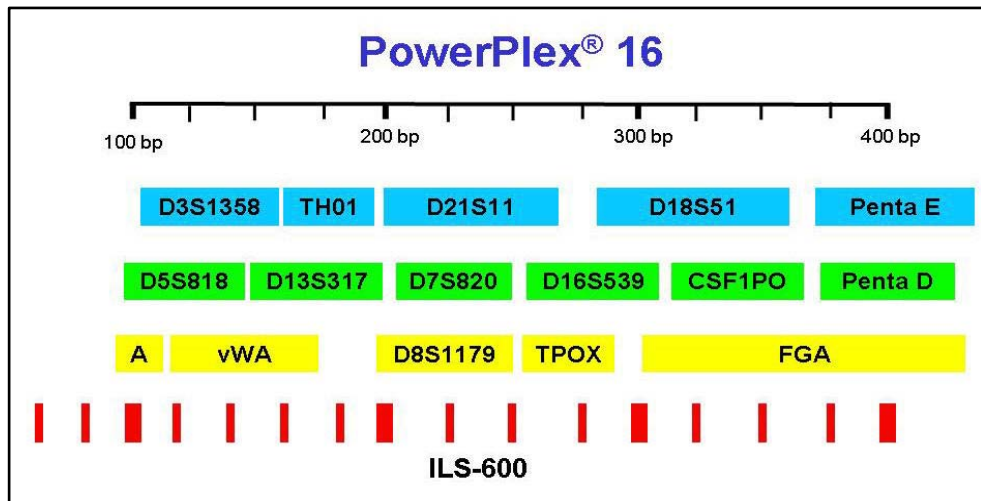


Figure 2.5. General size ranges in basepairs (bp) for each loci and dye labelling strategies (indicated by the colour of the boxes) for the PowerPlex 16 and PowerPlex 16 HS kits. Adapted in full with permission from [144].

### 2.1.5 Aims and objectives

The objective of this research was to:

- ❖ Investigate the effects of different substrates on DNA recovery using direct PCR. A pre-study was first carried out to evaluate the performance of three DNA recovery techniques and its suitability of its use to recover DNA deposited on two types of surfaces, glass and plastic.
- ❖ Subsequently test four commonly encountered surfaces, glass, plastic, ceramic and stainless steel to evaluate if materials recovered from these substrates had an effect on direct PCR and how they compared to DNA profiles generated via the standard DNA profiling protocol.
- ❖ Test and compare two commercially available STR multiplex kits to be used with direct PCR. SGMPlus and PP16-HS were used in this study as these kits were commonly used to obtain DNA profiles in forensic DNA analysis. Furthermore, these multiplex kits have different polymerase-buffer systems and manufacturer's recommended protocols which may result in different efficiencies to amplify samples and generate DNA profiles.
- ❖ Compare the ability of the QiaAmp DNA Micro extraction and subsequently standard PCR with direct PCR to generate DNA profiles.

## **2.2 Materials and method**

### **2.2.1 Swabbing Technique**

A standard swabbing technique was used to swab the DNA sample from the substrate to minimise as much variation as possible. The technique described here is the technique of swabbing used throughout the research unless stated otherwise.

A sterile cotton tipped swab (Technical Services Consultants Ltd, UK) was moistened with 40  $\mu\text{L}$  of sterile deionised water. The cotton swabs used for retrieving DNA in this study were 15 cm long with a wooden shaft and cotton wad at one end. The swabs came sterilised and packaged individually in plastic tubes. The swab was held at a  $90^\circ$  angle to the surface to be swabbed using the thumb and index finger, in such a way that only the tip of the swab was in contact with the surface. This was to ensure concentration of the recovered material on one area of the swab. The area was then swabbed using a circular motion to ensure the entire substrate surface was covered. Each substrate was swabbed for about 30 sec to recover as much DNA as possible from the substrate.

### **2.2.2 Retrieval of DNA**

This experiment was carried out as a pre-study to evaluate the effectiveness of three recovery techniques to recover DNA from two surfaces, glass and plastic.

Human male placental DNA (Cambio, Cambs, UK) was diluted into five different concentrations: 0.1  $\text{ng}/\mu\text{L}$ , 0.075  $\text{ng}/\mu\text{L}$ , 0.05  $\text{ng}/\mu\text{L}$ , 0.025  $\text{ng}/\mu\text{L}$  and 0.01  $\text{ng}/\mu\text{L}$ . A total 10  $\mu\text{L}$  of each sample was pipetted onto sterile, DNA-free glass and plastic substrates and left to air dry overnight in a biohazard cabinet. Three DNA retrieval techniques were tested on these substrates, using three replicates per substrate. A negative control was taken using a moist swab by swabbing an area of the substrate where DNA had not been deposited.

#### **2.2.2.1 Swabbing using a moist swab**

A sterile cotton swab was moistened with 40  $\mu\text{L}$  of sterile deionised water. The area smeared with DNA was then swabbed using a circular motion following the protocol described in 2.2.1. A small (2 mm x 2 mm) area of the swab was cut and placed into a sterile 0.2 mL thin wall PCR tube.

#### **2.2.2.2 Swabbing using a dry swab on a moist surface**

Around 40  $\mu\text{L}$  of sterile deionised water was pipetted onto the substrate. The area was then swabbed with a dry sterile cotton swab using the protocol described in 2.2.1 until all the water has been absorbed by the swab. A small (2 mm x 2 mm) area of the swab was cut and placed into a sterile 0.2 mL thin wall PCR tube.

#### **2.2.2.3 Direct retrieval by pipetting**

Around 40  $\mu\text{L}$  of sterile deionised water was pipetted onto the substrate and aspirated and expunged slowly across the area where the DNA was smeared. Finally, the water was aspirated (final volume would be slightly less than 40  $\mu\text{L}$ ) and placed in a 1.5 mL tube.

### **2.2.3 Amplification and electrophoresis**

Amplification was carried out in a 25  $\mu\text{L}$  reaction (Table 2.1) using the PP16-HS system (Promega, UK) according to the manufacturer's recommended protocol [92]. Every batch of samples amplified was accompanied by a positive and negative control sample. Amplification was carried out on a 2720 thermal cycler (Life Technologies, UK) following the amplification cycle protocol in Table 2.2.

**Table 2.1. Amplification multi mix components for the different samples amplified. Volumes shown are for each sample amplified using PP16-HS. Multi mix was prepared for  $n + 1$  for  $n$  number of samples.**

	Sample retrieved by swabbing	Sample retrieved by pipetting	Positive Control	Negative Control
<b>Master Mix (Buffer)</b>	5.0 $\mu$ L	5.0 $\mu$ L	5.0 $\mu$ L	5.0 $\mu$ L
<b>Primer Mix</b>	2.5 $\mu$ L	2.5 $\mu$ L	2.5 $\mu$ L	2.5 $\mu$ L
<b>Sample</b>	-	17.5 $\mu$ L	-	-
<b>Amplification Grade Water</b>	17.5	-	16.0 $\mu$ L	17.5 $\mu$ L
<b>Control DNA (0.5 ng/<math>\mu</math>L)</b>	-	-	1.5 $\mu$ L	-
<b>Total reaction volume</b>	<b>25 <math>\mu</math>L</b>	<b>25 <math>\mu</math>L</b>	<b>25 <math>\mu</math>L</b>	<b>25 <math>\mu</math>L</b>

**Table 2.2. Amplification protocol for PP16-HS using 2720 thermal cycler.**

<b>1 cycle</b>	<b>32 cycles</b>			<b>1 cycle</b>
96°C	94°C	62°C	72°C	60°C
2 min	30 sec	90 sec	90 sec	45 min

Capillary electrophoresis was carried out on a 310 Genetic Analyser (Applied Biosystems, UK). 15  $\mu$ L of ILS-600:HIDI-Formamide (0.75:16) mix was added to 2  $\mu$ L of sample. Control samples and an allelic ladder were run for each set of samples. Parameters (injection time, voltage, run time) were set according to the Powerplex-16 protocol [146].

The retrieval technique used in further experiments was decided based on the results obtained in this experiment.

#### **2.2.4 Duplicate injection using 310 Genetic Analyser**

Amplified products were injected twice in a 310 Genetic Analyser (Life Technologies, UK). The peak heights obtained for each allele in each locus [n = 300] were compared between the two injections to observe the variability.

Based on the results obtained in this experiment (refer Results and discussion 2.3.2), subsequent analysis was carried out with a single injection of the PCR product.

#### **2.2.5 Comparison between direct PCR and QiaAmp DNA Micro extraction on different substrates using two commercial STR kits**

Glass microscope slides, polypropylene plastic sheets, ceramic tiles and stainless steel tiles, were cleaned with 96% ethanol and UV cross-linked for 20 min. Human male Placental DNA (Cambio Ltd.) was diluted to five different concentrations; 0.1 ng/ $\mu$ L, 0.075 ng/ $\mu$ L, 0.05 ng/ $\mu$ L, 0.025 ng/ $\mu$ L and 0.01 ng/ $\mu$ L. Two sets of samples were prepared, one for direct PCR and one for Qiagen extraction, by pipetting 10  $\mu$ L of each sample onto the four different substrates which were left to air dry in a biohazard cabinet overnight. Three replicates were processed for each dilution on each substrate using both direct PCR and the Qiagen extraction method. The same diluted DNA was used for the four substrates and two commercial kits compared in this chapter to minimise the variation between experiments.

Based on the results obtained from 2.3.1, swabbing using a moist swab was chosen as the preferred method for DNA retrieval from the various substrates used. An extract negative was taken by swabbing an area of the substrate not smeared with DNA. One set of swabs was subjected to direct PCR and another set was subjected to Qiagen extraction using the swab extraction protocol (Figure 2.6) prior to PCR amplification [139]. The difference in procedure for direct PCR and Qiagen extraction is described in Table 2.3.

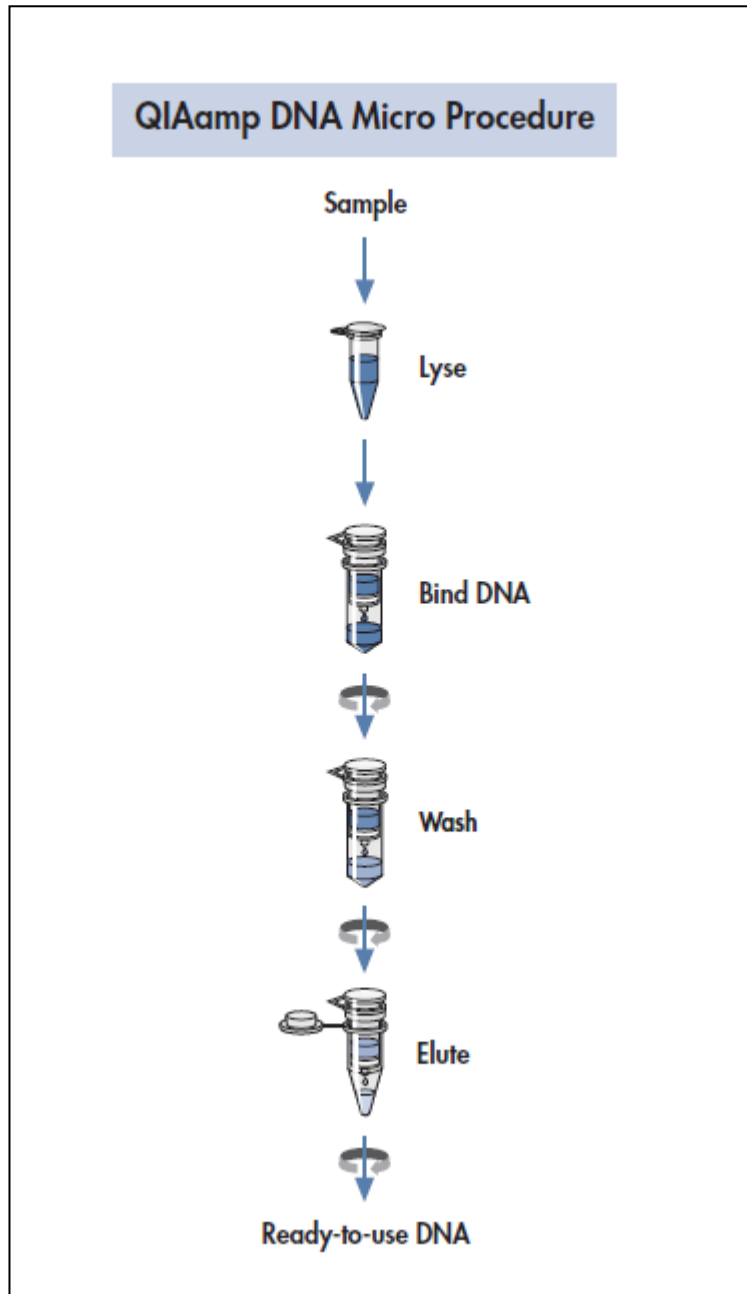


Figure 2.6. Extraction protocol for the QIAamp spin columns. Adapted in full from [139].



**Table 2.3. Difference in procedure for Direct PCR and Qiagen extraction kit.**

Direct PCR	Qiagen extraction kit
The tip of the cotton swab (which measures approximately 2mm <sup>2</sup> ) was cut and placed directly into an amplification tube.	The entire swab was cut and placed in a 1.5 mL tube and extracted following the Swab protocol. Samples were eluted in 20 µL SDW. A positive control (buccal swab) was extracted together with the samples.

PCR amplification and thermal cycling protocols were set up with PP16-HS (Promega, UK) or SGMPlus (Life Technologies, UK) following manufacturers' recommended protocols [92, 147] in a final volume of 25 µL (Table 2.4 and Table 2.5). After thermal cycling was complete, samples were stored at 4°C until use.

Capillary electrophoresis was carried out on a 310 Genetic Analyser (Life Technologies, UK) using the manufacturer's recommended protocols for PP16-HS and SGMPlus. A total volume of 15 µL of ILS-600:HIDI-Formamide (0.75:16) mix [PP16-HS] or 15 µL of ROX 500:HIDI-Formamide (0.5:16) mix [SGMPlus] was added to 2 µL of PCR product.

**Table 2.4. Multi mix components of PP16-HS for direct PCR and Qiagen extracted samples. Volumes shown are for each sample amplified. Multi mix was prepared for  $n + 1$  for  $n$  number of samples. Samples were amplified using the 32 cycle amplification protocol as recommended by the manufacturer [92].**

	<b>Direct PCR</b>	<b>Qiagen Extraction</b>
<b>Master Mix (Buffer)</b>	5.0 $\mu\text{L}$	5.0 $\mu\text{L}$
<b>Primer Mix</b>	2.5 $\mu\text{L}$	2.5 $\mu\text{L}$
<b>DNA template</b>	-	17.5 $\mu\text{L}$
<b>Amplification Grade Water</b>	17.5 $\mu\text{L}$	-

**Table 2.5. Multi mix components of SGMPlus for direct PCR and Qiagen extracted samples. Multi mix is prepared in a separate tube for  $n$  number of samples. A total of 15  $\mu\text{L}$  and 25  $\mu\text{L}$  of the multi mix were aliquoted into each PCR tube for extracts and direct PCR samples respectively. Samples were amplified using the 28 cycle amplification protocol as recommended by the manufacturer [48].**

	<b>Direct PCR</b>	<b>Qiagen Extraction</b>
<b>Reaction Mix</b>	10.0 $\mu\text{L}$	10.0 $\mu\text{L}$
<b>Primer Set</b>	5.0 $\mu\text{L}$	5.0 $\mu\text{L}$
<b>Ampli<i>Taq</i> Gold</b>	0.75 $\mu\text{L}$	0.75 $\mu\text{L}$
<b>DNA template</b>	-	10.0 $\mu\text{L}$
<b>Amplification Grade Water</b>	10.0 $\mu\text{L}$	-

### 2.2.6 Data interpretation

Raw data were analysed using Genemapper ID v.3.2.1 software (Life Technologies, UK). A threshold of 50 rfu was used to set the limit of detection of the system. Statistical calculations were performed using Microsoft Excel (Microsoft Corp.) and Minitab 16 (Minitab Inc.) softwares.

Percentage of allelic dropout (%AD) was calculated based on the formula:

$$\frac{\text{No. of expected alleles} - \text{No. of observed alleles}}{\text{No. of expected alleles}} \times 100 \quad \text{Equation 2.1}$$

while percentage profile (%P) was calculated based on the formula:

$$\frac{\text{No. of observed alleles}}{\text{No. of expected alleles}} \times 100 \quad \text{Equation 2.2}$$

The term ‘reportable profiles’ was used to indicate the DNA profiles of which more than 50% of the expected peaks were observed in the electropherogram.

Total peak height (TPH) was obtained by summing the peak heights of all the alleles observed above the 50 rfu threshold in an electropherogram. Heterozygous balance (Hbx) was calculated by dividing the smaller peak height allele (rfu) with the larger peak height allele (rfu). The Hbx value which is closest to 1.0 would indicate well balanced peaks.

## **2.3 Results and discussion**

### **2.3.1 Retrieval of DNA**

The recovered DNA was amplified with PP16-HS kit and the peak heights from the electropherograms obtained were used to determine the efficiency of the recovery technique. Although quantification of the swab would have given an accurate measure of the amount of DNA recovered, attempts on using real time PCR on the swabs did not yield any quantification results. This was attributed to the presence of the cotton fibres in the reaction which inhibited the fluorescence detection. For this reason, the swabbed DNA was amplified using multiplex kits and peak heights obtained from the electropherograms were used as a comparison. However, the efficiency of recovering epithelial cells from microscope slides using cotton swabs could be made and is discussed in Chapter 3.

The different recovery techniques have different efficiencies on glass and plastic, as is shown in Figure 2.7 and Figure 2.8. All the negative controls were free of DNA. DNA recovery by pipetting failed to give a full DNA profile with any amount of DNA, including optimal DNA (1.0 ng) on plastic, but worked well with glass, until the lowest amount of DNA (100 pg). DNA recovery using a dry swab on a moist surface failed to give full DNA profiles with either substrate.

Recovery of DNA by pipetting exhibited different efficiencies between the two substrates. Only 26% of the samples recovered from plastic exhibited reportable profiles. In contrast, 93% of the samples recovered from glass showed reportable profiles. One possible explanation for this difference could be the physical properties of the substrates. The polypropylene sheet that was used in this research demonstrated hydrophobic properties, whereby the water droplet formed a spherical shape to minimise the contact with the hydrophobic surface, which was not observed with glass. Polypropylene has been known to be one of the most hydrophobic among plastic materials, with a contact angle of around 92° [132] while glass slides have a contact angle of approximately 37°, indicating lower hydrophobicity [148]. Contact

angle is the angle at which a liquid/vapour interface meets a solid surface and is a reflection of how strongly the liquid and solid molecules interact with each other [149]. As the interaction between water and plastic was reduced, retrieval by pipetting might not have been able to recover most of the DNA deposited.

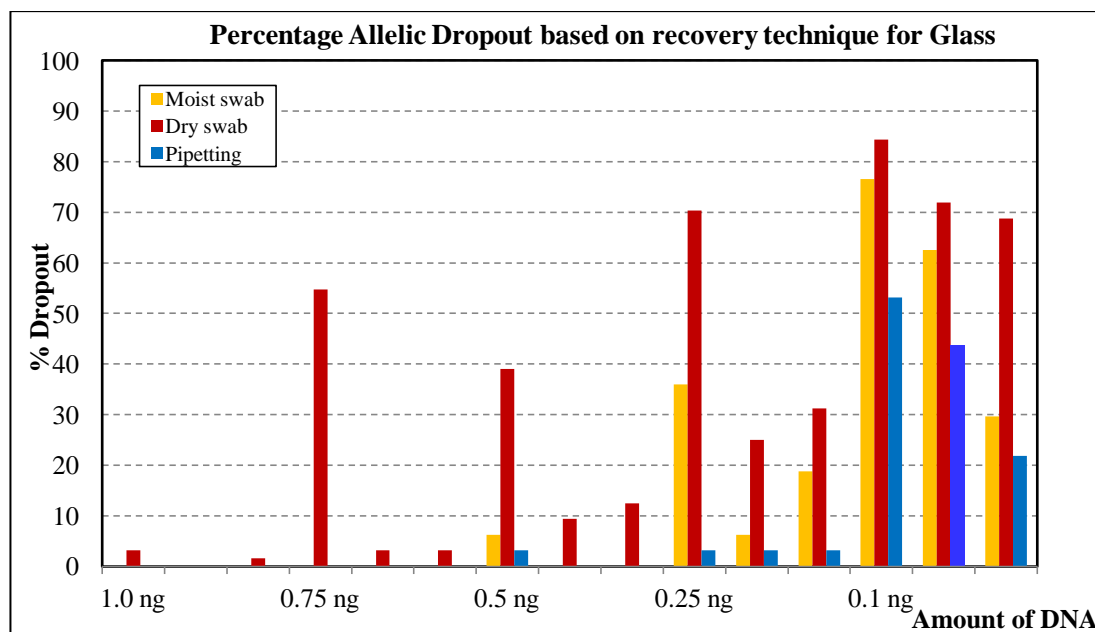
Besides having low hydrophobic interactions, DNA adsorption on glass surfaces can also be disrupted by the presence of low ionic strength solution, like distilled water. Water or Tris-EDTA (TE) buffer is used to elute DNA during QiaAmp DNA extraction because the interaction between DNA and silica is disrupted due to the change in the surface charge of the silica layer [130]. The surface of silica in contact with distilled water is negatively charged, causing an electrostatic repulsion with the negatively charged DNA molecule. As the DNA phosphate backbone is hydrophilic, this makes DNA more water soluble and is easily recovered by pipetting.

Recovery using a dry swab on a moist surface demonstrated similar results on both substrates, as demonstrated in Figure 2.7 and Figure 2.8. Approximately 80% of the samples obtained from plastic and 73% of the samples from glass exhibited reportable profiles. Full profiles were still observed at 0.5 ng of total DNA for glass in comparison to 0.75 ng of total DNA for plastic. In general terms, more allelic dropouts were observed in glass compared to plastic.

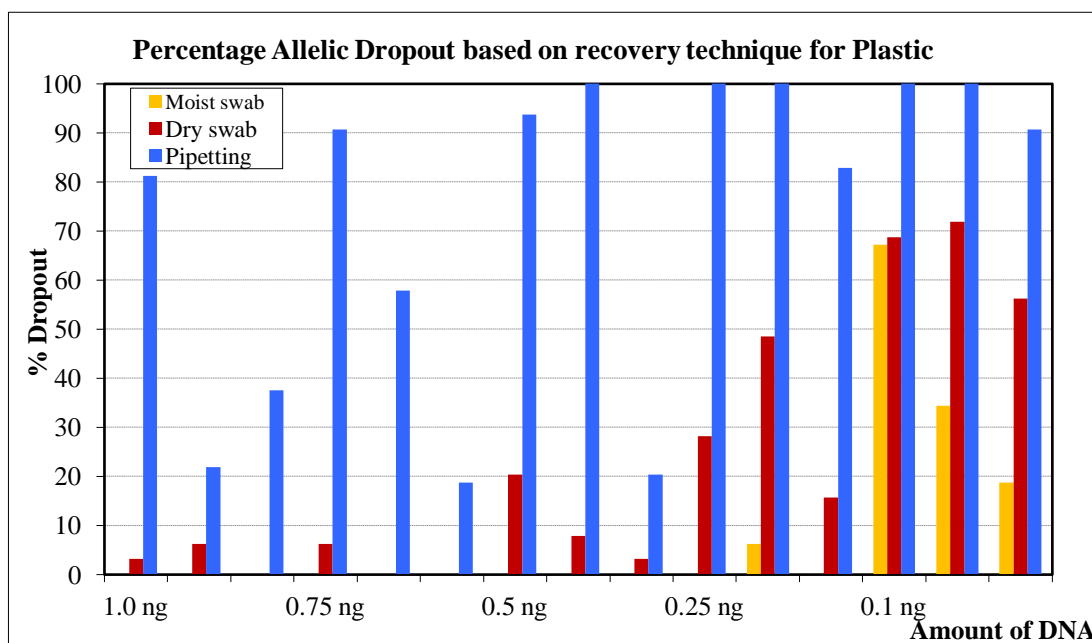
Recovery using moist swab was also quite similar between the two substrates, but less allelic dropout was observed compared to dry swab on moist surface. Around 93% of the samples gave reportable profiles for plastic whilst 87% of the samples showed reportable profiles for glass. Full profiles were observed up to 250 pg of total DNA for recovery on plastic, as compared to glass, where full profiles were observed up to 500 pg of total DNA.

Although better recovery was obtained from moist swab on a dry surface compared to dry swab on a moist surface, the difference was not great and this was as expected. One of the factors influencing DNA recovery by swabbing is the moisturised state of the cells/DNA on the substrate whereby moisturised biological material are better

recovered by the cotton fibres than those that are dehydrated [121, 123]. Capillary action is also thought to be critical in further recovering these materials from the surface of a substrate [121, 123]. During swabbing, the moisture applied either directly on the surface or through a swab, rehydrates the cells/DNA, making them adhere easily to the swabs while facilitating DNA recovery by capillary action [121, 123].



**Figure 2.7. Percentage allelic dropout calculated from DNA profiles obtained from the three recovery techniques on glass.**



**Figure 2.8. Percentage allelic dropout calculated from DNA profiles obtained from the three recovery techniques on plastic.**

Even though recovery by pipetting gave the best recovery results from glass among the three recovery techniques tested, there were few difficulties encountered with this technique and thus deemed impractical to be used in real case scenarios for reasons stated below:

- It was difficult to recover biological materials from uneven glass surfaces. Glass surfaces such as patterned, ridged or notched would pose a problem for DNA recovery by pipetting.
- Recovery by pipetting from vertical items such as windows and mirrors, or rounded items like bottles would not be possible as the moisturiser would drip down even before the surface could be ‘wetted’. It is only possible to recover materials using the pipetting technique from flat horizontal glass surfaces.
- Recovery by pipetting was only suitable for targeting small areas. It was not possible to recover DNA/cellular material from larger areas because the amount of water used (40  $\mu$ L) was insufficient to cover large areas and increasing the

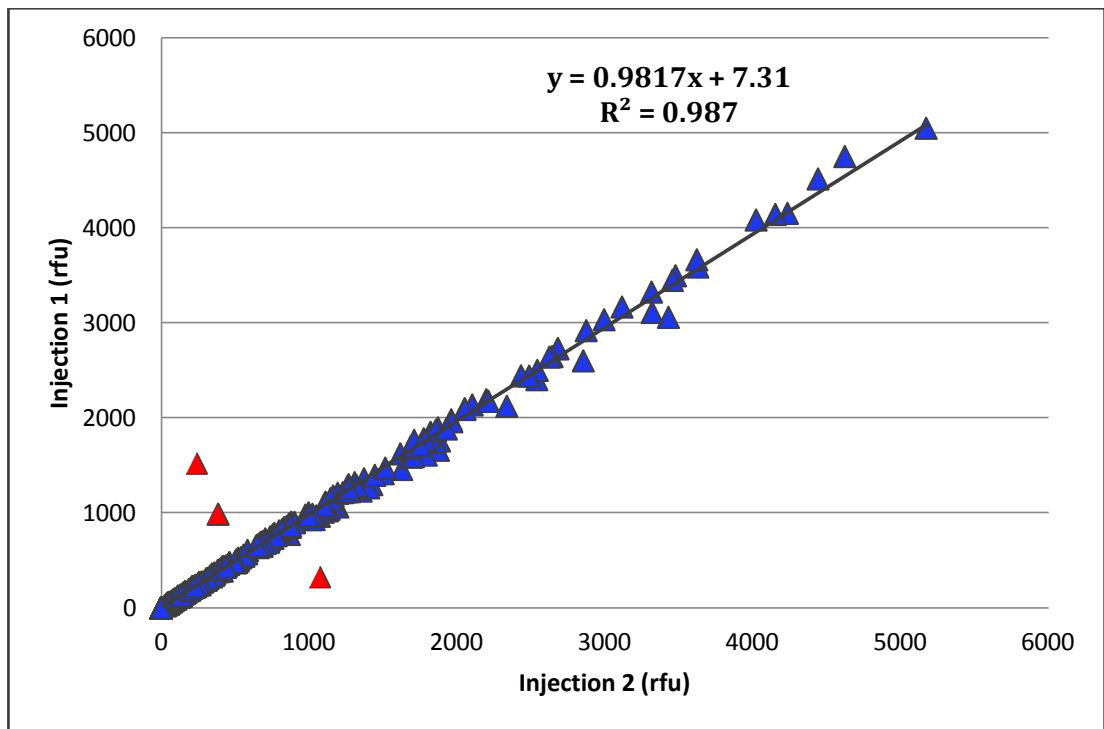
volume of water used as moisturiser would further dilute the trace levels of DNA present which would then make sample concentration a necessity. Sample concentration processes lose DNA through washing away or DNA adhering to tube walls and membranes [150].

After taking into account the results obtained and the practicality of each technique, it was decided that recovery by swabbing with a moist swab was the most practical and appropriate and therefore, this technique was subsequently used as the recovery technique for future experiments. This preliminary study indicates that it may be necessary to use different recovery techniques when DNA is deposited on different types of substrates.

### **2.3.2 Duplicate injection using a 310 Genetic Analyser**

The peak heights obtained for each allele in each locus [n = 300] were compared between the two injections to observe the variability. A paired t-test was calculated. A p-value of 0.239 indicates that the null hypothesis can be accepted and that differences in peak height between the two injections are not significant. Figure 2.9 shows a scatter plot on the relationship between injection 1 and injection 2 [n = 300]. As indicated in the scatter plot, all data points for both the injections fall on the regression line except for three outliers which are indicated in red, thus indicating that the values for duplicate injections are very similar. Based on the results obtained here, further experiments were conducted with only a single injection on the 310.



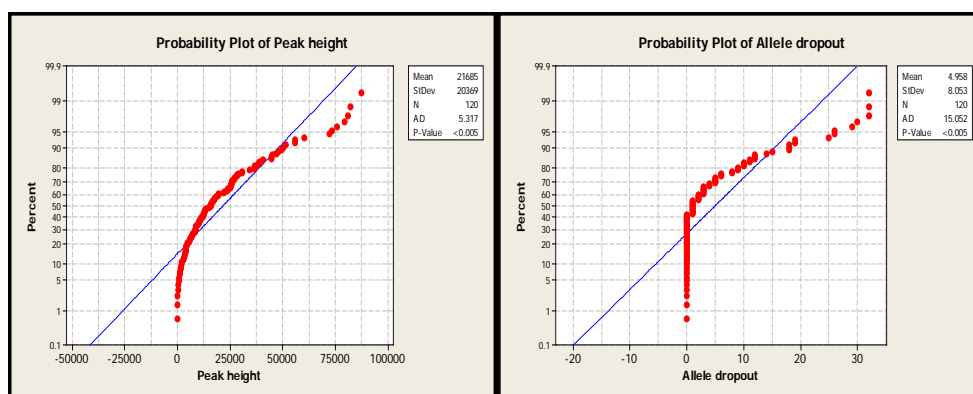


**Figure 2.9.** Scatter plot with a regression line indicating the peak heights for duplicate injections are similar.

### **2.3.3 Comparison between direct PCR and Qiagen extraction on different substrates using two commercial STR kits**

#### **2.3.3.1 Sample replicates**

Three replicates were carried out for each dilution on each substrate using direct PCR and extraction and amplified with PP16-HS [n = 120]. Only peak heights of 50 rfu and above were used in the statistical calculations. The Anderson-Darling normality test was carried out on the peak height and allele dropout data to test for normality (Figure 2.10). Results indicated that the samples were not normally distributed; therefore, non-parametric analysis was used for statistical analysis.



**Figure 2.10. A normal probability plot using the Anderson-Darling Normality test on peak height and allele dropout data.**

The Kruskal-Wallis test was carried out on the peak height and allelic dropout data to observe if there was a significant difference between the three replicates. P-values of 0.537 for peak height versus replicate, and 0.462 for allele dropout versus replicate indicate that there is a no significant difference in the median of the peak heights and allele dropouts of the three replicates. An average of the peak height and allelic dropout data of the replicates were used for subsequent statistical analyses.

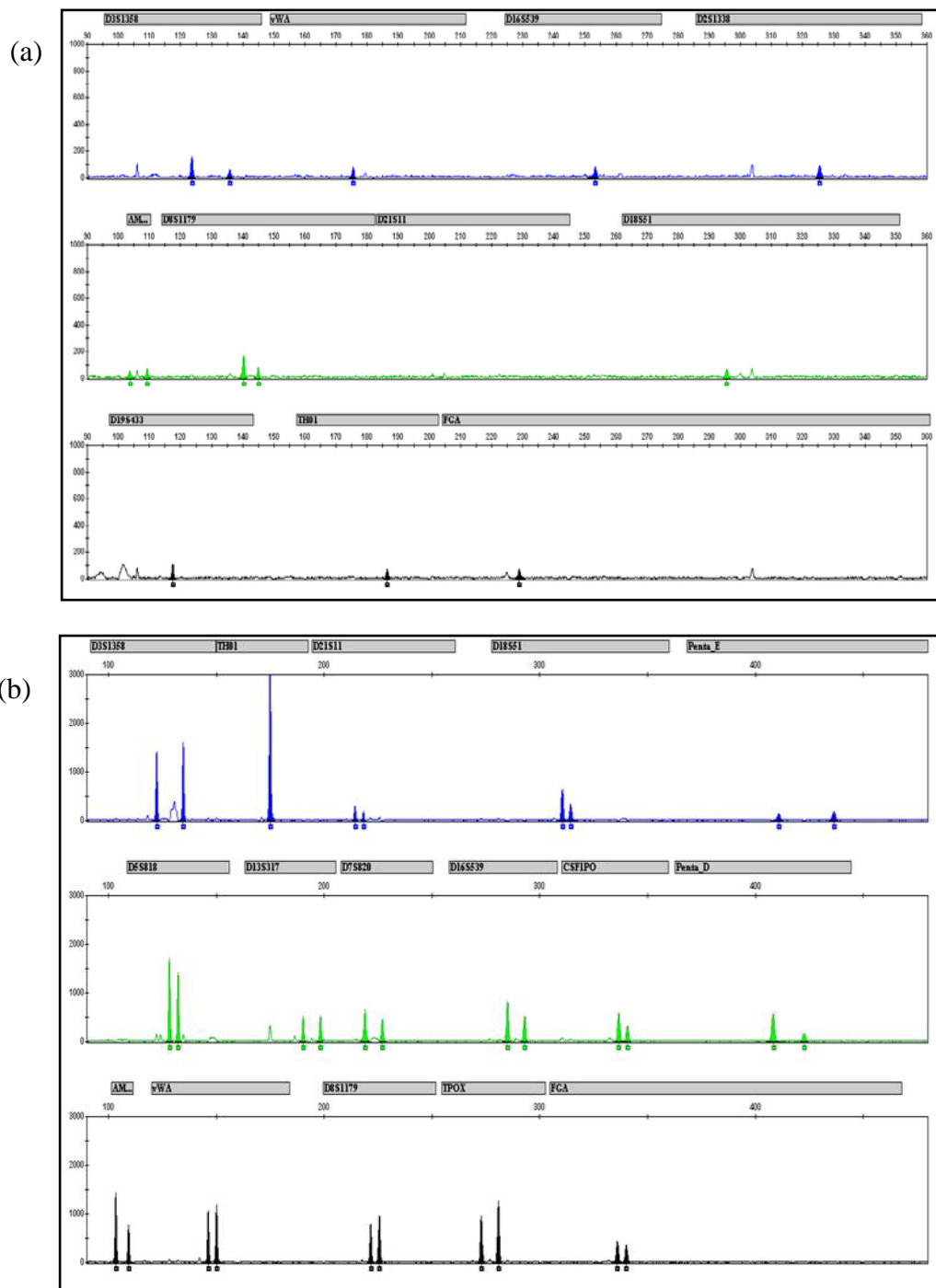
### **2.3.3.2 Comparison between PP16-HS and SGMPlus using direct PCR**

No alleles were detected in any of the negative controls. Data obtained from SGMPlus demonstrated more allelic dropout than PP16-HS (Table 2.6). Complete allelic dropout (100%) was observed with lower amounts of DNA (0.25 ng and 0.1 ng) when samples were amplified using SGMPlus. Stainless steel and glass showed the highest percentage of allelic dropout for all amounts of DNA when amplified using SGMPlus. A 100% allelic dropout was observed from 0.1 ng total DNA from glass and stainless steel amplified with SGMPlus while the same amount of DNA amplified with PP16-HS only gave 57% and 25% allelic dropout respectively. No full DNA profiles were obtained with SGMPlus even with 1.0 ng total DNA. Up to 70% of the alleles were observed in the DNA profile of DNA recovered from ceramic and amplified using PP16-HS as opposed to 20% when

amplified using SGMPlus. An example of electropherograms obtained using PP16-HS and SGMPlus is shown in Figure 2.11.

**Table 2.6. Comparison of average percentage allelic dropout using PP16-HS and SGMPlus for all substrates with different amounts of DNA.**

<b>Total DNA Amount</b>	<b>Amplification kit</b>	<b>Substrate (% Allelic Dropout)</b>			
		<b>Glass</b>	<b>Plastic</b>	<b>Ceramic</b>	<b>Stainless steel</b>
<b>1.0 ng</b>	<b>PP16-HS</b>	0	4	0	0
	<b>SGMPlus</b>	68	52	38	73
<b>0.75 ng</b>	<b>PP16-HS</b>	0	4	0	0
	<b>SGMPlus</b>	71	52	32	82
<b>0.5 ng</b>	<b>PP16-HS</b>	3	2	3	2
	<b>SGMPlus</b>	88	53	44	86
<b>0.25 ng</b>	<b>PP16-HS</b>	14	5	4	5
	<b>SGMPlus</b>	100	52	67	88
<b>0.1 ng</b>	<b>PP16-HS</b>	57	32	31	25
	<b>SGMPlus</b>	100	70	83	100



**Figure 2.11. Example of electropherogram obtained from (a) SGMPlus at 1000 rfu and (b) PP16-HS at 3000 rfu, with the same amount of DNA.**

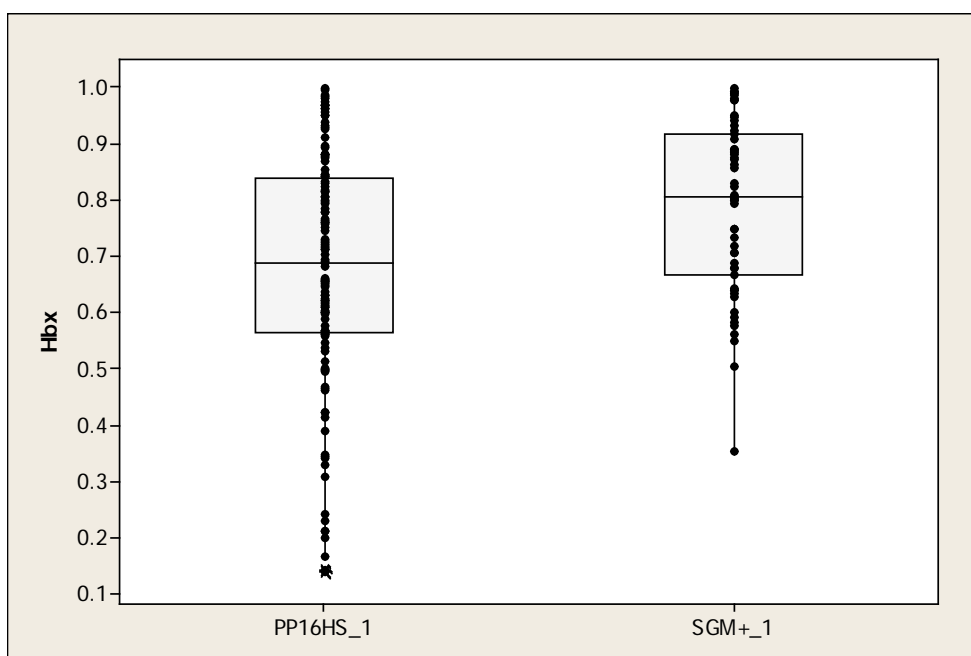
Samples amplified using PP16-HS consistently gave lower %AD compared to SGMPlus. A possible explanation for this difference could be the chemistry of the amplification reagents used in each kit. *AmpliTaq* Gold has been known to be susceptible to various inhibitors [151]. It may also be possible that the swab is inhibiting the action of *AmpliTaq* Gold in the SGMPlus kit but does not affect the processivity of the *Taq* in PP16-HS. There have been reports of some kits being unable to amplify DNA samples in the presence of cotton swabs but worked efficiently when the cotton fibres were not present (Tobe S. and McCallum N., personal communication, 2012). Since SGMPlus was first validated in 2000 [18], it has not benefited from the improved buffer and polymerase systems of the more recent amplification kits, like the PP16-HS, which may be more inhibitor tolerant and sensitive to low amounts of DNA [145, 152].

The lower %AD obtained from samples amplified using PP16-HS can also be attributed to the increased number of cycles the kit was validated with. PP16-HS has been validated with a 32 cycle protocol for less than 0.5 ng of DNA [92] as opposed to 28 cycles for SGMPlus [48]. The additional four cycles would explain the lower allelic dropout observed in samples amplified with PP16-HS.

Heterozygous peak balance ( $H_{bx}$ ) between PP16-HS and SGMPlus pooled from triplicate amplification for 1.0 ng to 0.1 ng of total DNA was compared to observe the quality of the profiles generated. Approximately 59% of alleles obtained using PP16-HS and 56% of alleles obtained using SGMPlus had  $H_{bx}$  above 0.6, a widely used guideline to aid mixture interpretation [153]. Profiles obtained using PP16-HS had a mean  $H_{bx}$  of 0.58 while those obtained using SGMPlus had a mean  $H_{bx}$  of 0.48. From Table 2.6, it was observed that SGMPlus had more allelic dropouts, especially at lower amounts of DNA and thus the dataset for  $H_{bx}$  calculations for SGMPlus was much smaller than for PP16-HS.  $H_{bx}$  generally increases when the amount of DNA template is reduced and the number of PCR cycles is increased [45] therefore a decrease in  $H_{bx}$  for PP16-HS was expected, but the data obtained here did not support this. It was likely that the null values (which indicate either one or

both the alleles in a heterozygous loci fall below the 50 rfu threshold) in the dataset were skewing the data.

In order to overcome this aberration, all the null values were removed from the dataset and a box plot was plotted using the new dataset Figure 2.12. Approximately 70% of profiles obtained using PP16-HS and 88% of profiles using SGMPlus had Hbx above the 0.6 guideline. The mean Hbx for profiles obtained using SGMPlus was higher this time with a value of 0.79 compared to profiles generated using PP16-HS with a mean Hbx value of 0.68. Other studies have indicated that for 1 ng of DNA, minimum Hbx value of 0.58 is expected for profiles generated using SGMPlus [154]. Data in this study has indicated that even when the total DNA amount was less than 1 ng for SGMPlus, almost all the Hbx values were above 0.5. Even though the sample size for Hbx calculation from profiles generated using SGMPlus is small, it does indicate that the SGMPlus kit generates better quality DNA profiles compared to PP16-HS despite its disadvantages of being inhibitor susceptible and less sensitive to small amounts of DNA.



**Figure 2.12. Box plot for PP16-HS (n=128) and SGMPlus (n=55) using the new dataset which excludes null values.**

### 2.3.3.3 Direct PCR versus QiaAmp DNA Micro extraction

Only alleles that were above the 50 rfu threshold were used to calculate the %P and TPH (Figure 2.13 and Figure 2.16). No alleles were observed in the negative controls. Direct PCR gave an overall higher TPH compared to samples that were extracted using Qiagen extraction. Samples of 0.5 ng and 0.1 ng total DNA gave lower TPH but were observed to have higher %P from glass and stainless steel when compared to extraction. Only DNA retrieved from plastic demonstrated higher %P when extracted compared to using direct PCR. Samples subjected to direct PCR demonstrated higher mean peak heights compared to samples that were extracted (Figure 2.14), indicating that better peak heights were obtained from samples subjected to direct PCR.

During swabbing, only the tip of the swab was used to recover the deposited DNA. The entire tip of the swab that had come in contact with the surface, which is approximately 2 mm<sup>2</sup> in size, is used for direct PCR. The QiaAmp DNA micro kit allows elution of DNA to be as low as 20 µL, and the PP16-HS kit enables a maximum of 17.5 µL of DNA solution to be amplified. In both direct PCR and extraction, almost all the DNA that was extracted was subsequently amplified. The difference in %P obtained is therefore thought to be the amount of DNA lost during extraction. The extraction process involves multiple steps of purification and sample transfers. During each of these steps, there is a tendency to lose some of the DNA material. Barboro *et al.* observed that up to 30% of the collected DNA material was lost when using the QiaAmp DNA Blood Mini kit [28], which may also be the case here.

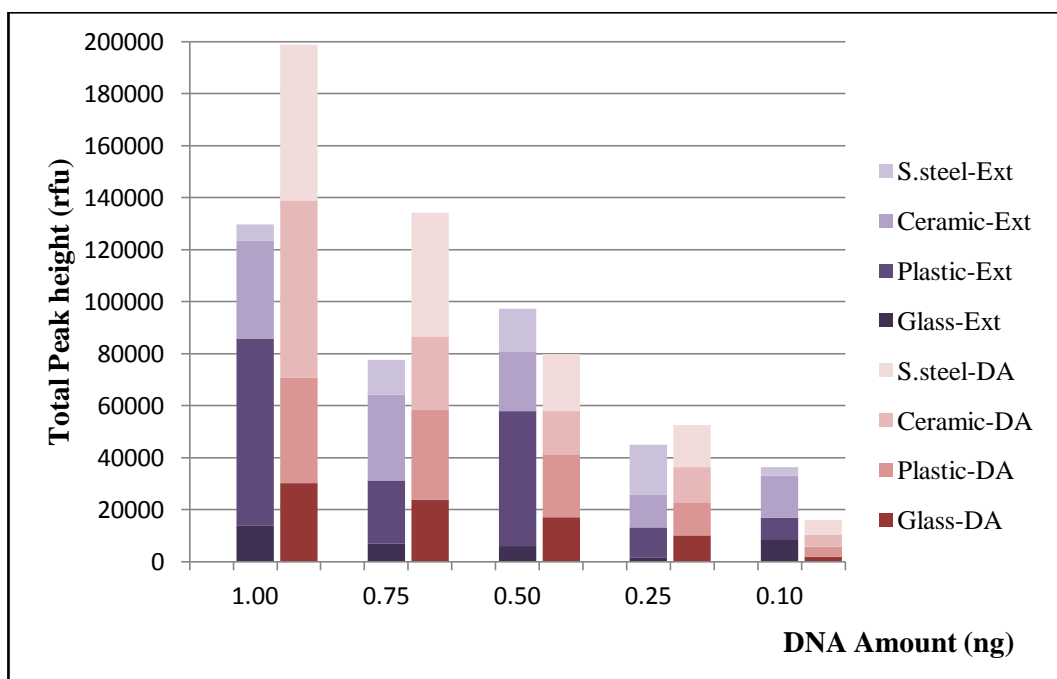


Figure 2.13. Comparison of total peak heights between direct PCR and extraction on all four substrates.

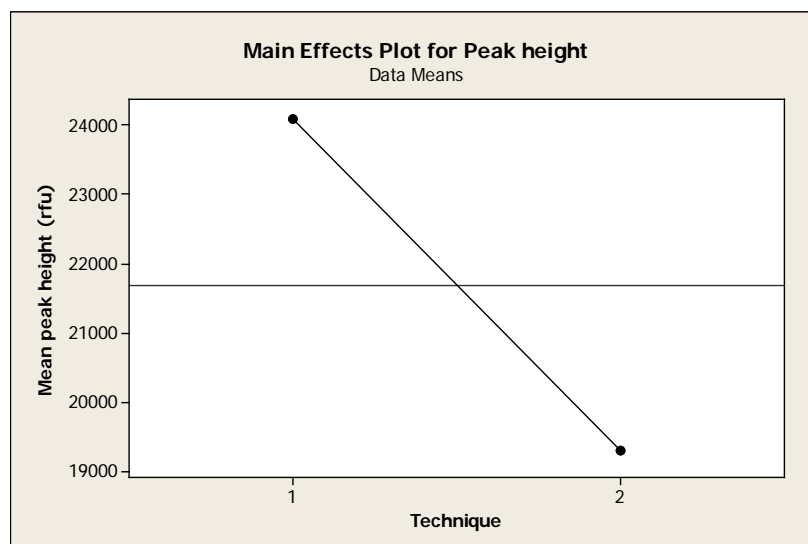
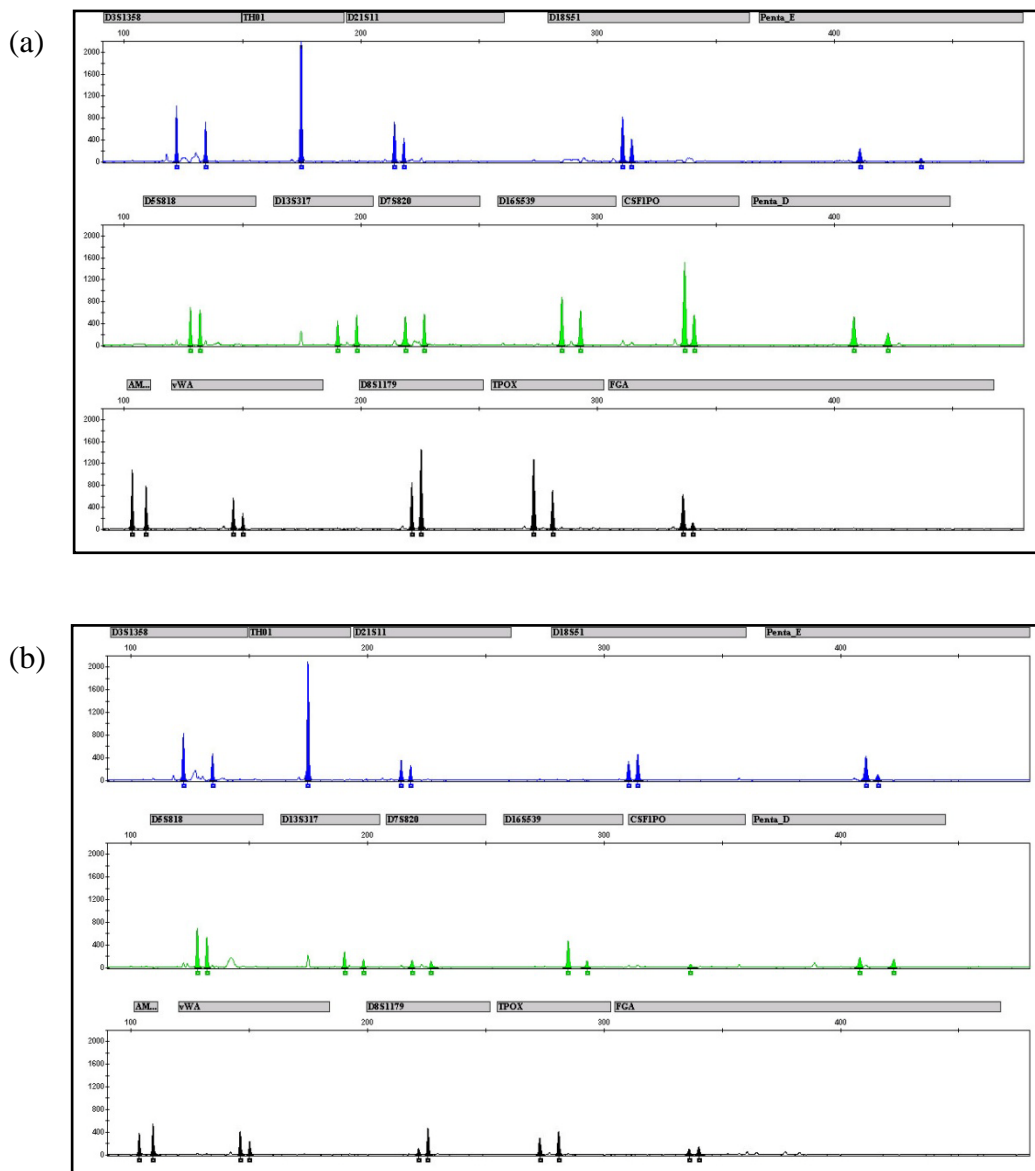


Figure 2.14. Mains effect plot where mean total peak height was plotted against the technique used. 1: Direct PCR; 2: Extraction



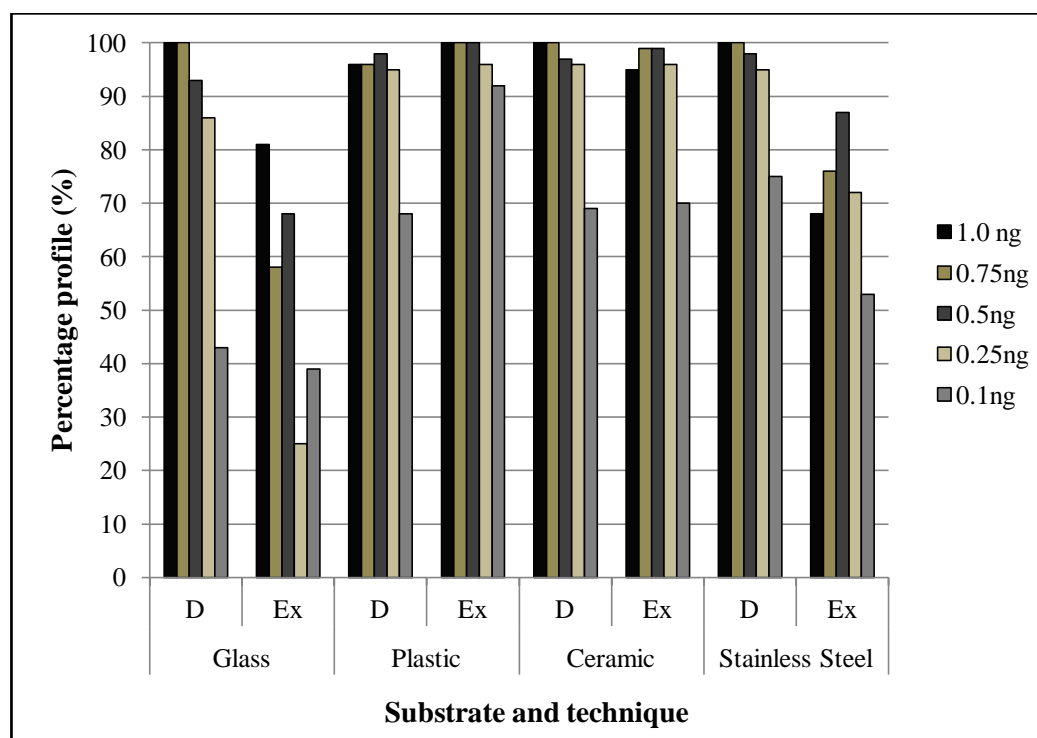
Samples amplified using direct PCR showed a gradual decrease as the amount of starting DNA material decreased. This consistency was not observed with samples that were extracted, indicating that the extraction technique may be less reliable in producing consistent results. Though all effort was taken to minimise the variations, factors such as temperature of buffers and variations in pipetting may have played a role in the results observed. It may also be possible that residues of buffers (such as guanidine hydrochloride) and ethanol may have been eluted together with the DNA and act as inhibitors in some of the amplification reactions. An example electropherogram and TPH obtained from direct PCR and extraction is shown in Figure 2.15.



**Figure 2.15.** A comparison of electropherograms at 2000 rf. DNA profile obtained from 0.5 ng of total starting DNA subjected to (a) Direct PCR (TPH=21382) and (b) extraction (TPH=3445).

### 2.3.3.4 Analysis of substrates

Overall, better %P was obtained from samples retrieved from plastic and ceramic for both direct PCR and extraction (Figure 2.16). More than 90% of the profile was obtained for 0.1 ng of DNA retrieved from plastic and extracted, compared to only 68% from the same sample subjected to direct PCR. The %P obtained from samples retrieved from ceramic and extracted for all amounts of DNA were almost the same as the results obtained using direct PCR.



**Figure 2.16. Average percentage profile obtained using direct PCR (D) and Qiagen extraction (Ex) for glass, plastic, ceramic and stainless steel.**

In order to compare the effects of different substrates on total peak height, the Kruskal-Wallis test was used (Figure 2.17). The median peak height for substrates retrieved from glass was significantly lower than the medians for plastic, ceramic and stainless steel, indicating that the total peak heights of DNA retrieved from glass was lowest compared to the other three substrates. DNA retrieved from plastic indicated to have the highest total peak height. The p-value of 0.007 is smaller than the  $\alpha$ -value

of 0.05, thus the null hypothesis (that the median of total peak heights for all four substrates are the same), can be rejected. The difference in EPG obtained from DNA retrieved from the different substrates tested is illustrated in Figure 2.18.

<b>Kruskal-Wallis Test: Peak height versus substrate</b>				
Kruskal-Wallis Test on Peak height				
substrate	N	Median	Ave Rank	Z
1	30	9976	42.9	-3.19
2	30	19576	70.9	1.89
3	30	17120	69.0	1.55
4	30	15793	59.2	-0.24
Overall	120		60.5	

**Figure 2.17. Kruskal-Wallis test comparing median of the four substrates tested. 1: Glass; 2: Plastic; 3: Ceramic; and 4: Stainless steel.**

As with results obtained in 2.3.1, DNA recovery from glass has demonstrated to be less efficient compared to the other substrates tested. Even though wetting the glass surface with water should have made the surface unsuitable for adsorption of DNA, and made recovery more efficient, this was not observed. The only explanation for this behaviour that I could think of was that the surface of the silica was more conducive for DNA adsorption than the moist cotton fibres were, resulting in the DNA molecules preferring to stick to the surface of the silica than it was to the cotton fibres. In my opinion, changing the type of swab to nylon flocked swabs [155] or changing the moisturiser from water to a buffer, like TE, could potentially increase the efficiency of DNA recovery from glass surfaces.

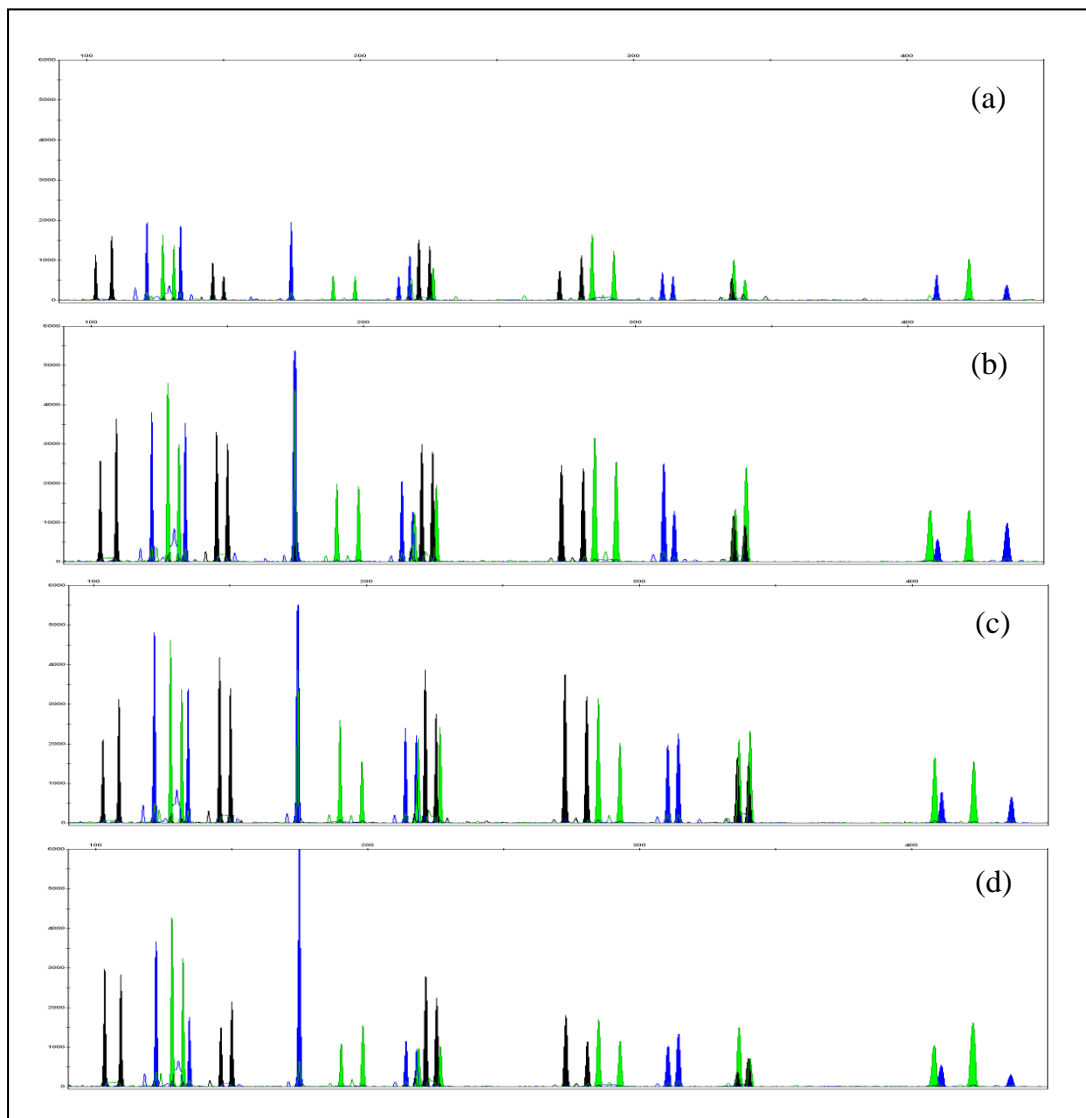
The results obtained from DNA recovered from plastic were quite similar between direct PCR and Qiagen extraction, although Qiagen extraction did perform slightly better than direct PCR. Some types of plastic, especially polypropylene, is known to cause denaturation and adsorption of DNA to the polypropylene material [133, 134]. Since the plastic material that was used in this study was polypropylene based, loss of DNA was anticipated, but this was not observed. Samples retrieved from plastic

gave one of the highest peak heights and percentage profiles compared to the other substrates tested. This may be due to the hydrophobic nature of the polypropylene sheet used in this study. Polypropylene has a contact angle of around  $92^\circ$ , which indicates properties of high hydrophobicity [132]. Belotserkovskii and Johnston [133, 134] also observed moderate denaturation of DNA with some polypropylene substrates, which may potentially expose the hydrophobic DNA bases and cause hydrophobic repulsion and made recovery of DNA from polypropylene surfaces easier.

Studies on DNA–ceramic and DNA–metal interactions *in vitro* are not widely published. Results obtained here indicate that direct PCR worked much better than extraction on samples retrieved from stainless steel, therefore metal ions which are common PCR inhibitors could not have been the cause of the low peak heights obtained from the extracted samples. When DNA is retrieved from stainless steel, some of the chromium oxide layer could have swabbed off together with the deposited DNA. These chromium ions can be attracted and associate with the negatively charged DNA-phosphate backbone initially through electrostatic interaction which then leads to the formation of a metal-ligand complex with the phosphate oxygens [156, 157]. This ligand formation could have interrupted the adsorption of DNA to the silica membrane which is crucial in the Qiagen extraction protocols. Without the ability to adsorb to the silica membrane during purification, DNA in the sample gets washed away, resulting in insufficient quantities to generate DNA profiles.

The DNA profiles obtained from DNA recovered from ceramic did not show much difference between direct PCR and Qiagen extraction. The ceramic used in this study was silica glazed, and results similar to those obtained with glass were anticipated, but this was not the case. The reason for this is thought to be caused by the increased aluminium concentration in ceramic compared to glass. The electrostatic interaction between aluminium ions and DNA increases as the pH increases which causes more DNA to be adsorbed to the aluminium ions [158]. The pH of deionised water is

typically around 6, because it dissolves carbon dioxide in the air. As the slightly acidic water moisturises the ceramic surface, it is thought that this causes the pH of the substrate surface to drop. The electrostatic interaction between the aluminium ions and DNA is pH dependent and is weakened in lower pH, which then makes the DNA molecules to be swabbed off more easily.



**Figure 2.18.** Example of EPG obtained using PP16-HS from four of the substrates tested (a) Glass; (b) Plastic; (c) Ceramic and (d) Stainless steel. The Y-axis for the electropherograms are set at 6000 rf.u.

## 2.4 Conclusion

The preliminary work carried out in this chapter looked into the different types of recovery techniques from two types of substrates using water and cotton swabs. Once the ideal recovery technique had been determined, DNA was deposited in various known amounts on glass, plastic, ceramic and stainless steel, recovered using moist swabs and profiled using two techniques, one amplified directly using direct PCR and the other subjected to Qiagen extraction prior to standard amplification, and then compared using two different commercially available multiplex kits.

Even though the preliminary study was carried out with only two substrates, it does indicate that it may be necessary to use different recovery techniques on different substrates. Pipetting was very successful in retrieving DNA from glass surfaces but not from plastic, while moist swab and dry swab on moist surface were successful in recovering most of the DNA deposited on both substrates. Different moisturisers, for example water vs buffer solution and different types of swabs were not evaluated in this study but could be important for efficient recovery of low amounts of DNA from different substrates. The different substrates used in this study also provided information that DNA adheres or adsorbs to different substrates differently and using a single recovery technique may not be sufficient in recovering most of the DNA deposited.

The comparison with two commercial STR multiplex kits indicated that some STR kits may not be suitable to be used for direct PCR. SGMPlus is widely used in the UK and many other countries but studies have shown that this kit is especially susceptible to inhibitors [151]. The work carried out here also proves that it may not be suitable to be used for direct PCR but kits like PP16-HS and probably other newer kits like PowerPlex ESI/ESX 16 (Promega) and NGM (Life Technologies) may be more suited for direct PCR usage due to their improved buffer-polymerase chemistry.

Finally, the most important part of this chapter was the comparison study between direct PCR and Qiagen extraction. This study was to evaluate the potential use of direct PCR and its performance compared to a widely used extraction kit. From the results obtained here, it can safely be concluded that better DNA profiles were consistently obtained from direct PCR compared to extraction. Therefore direct PCR has the potential to be developed which will be evaluated further in work carried out in later chapters.



### **3 Analysis of buccal cells and fingerprints using direct PCR**

#### **3.1 Introduction**

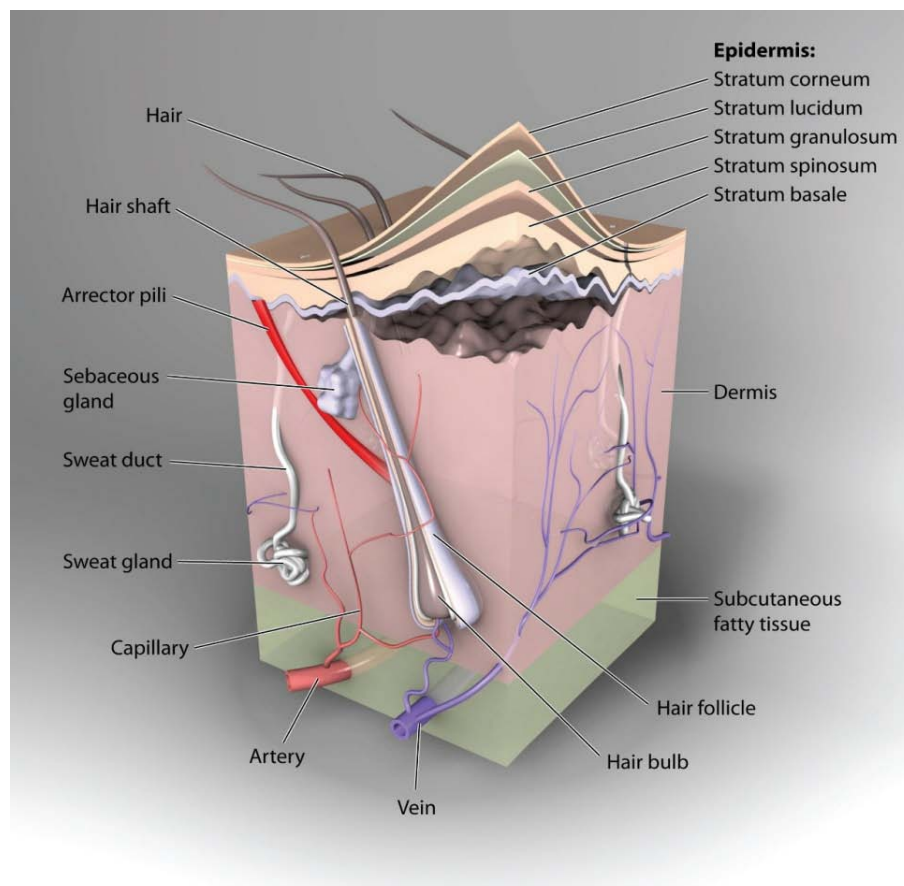
##### **3.1.1 Buccal cells as a source of DNA**

Buccal scrapings are commonly used in forensic genetics as a non-invasive method of obtaining a reference sample. When these cells are ‘scraped’, they come off the stratified squamous epithelial lining on the inner surface of the oral cavity. Sampling of buccal cells is more cost effective than drawing blood, reduces exposure to harmful pathogens and obviates the need for liquid sample handling [159]. An oral swab could potentially contain between 100 ng and 1500 ng of DNA per swab [160]. Epithelial cells have thin cell membranes which would easily break open to release the DNA stored inside when heat is applied. This property of the epithelial cell makes it suitable for direct PCR where heat during the denaturation or hot start cycle can be utilised to release DNA into the PCR mix without any extraction steps.

##### **3.1.2 Fingerprints as source of DNA**

The skin surface provides a large potential as a source of DNA to obtain a DNA profile. The skin is the largest organ of the human body, comprising 15% of the total body weight [161]. Each square centimetre of skin has 100 sweat glands and 10 oil glands [161]. Secretions produced by these glands make their way to the skin surface via ducts and pores, exposing them to a large number of cells. These cells provide an additional source of DNA, aside from the large amount of skin cells shed daily, with approximately 400,000 cells shed per day [161]. Research has shown that besides cells, double and single stranded extracellular DNA are also shed from the skin [162]. In the skin, keratinocytes become condensed in the granular layer of epidermis, and lose their nuclei as they move through the cornified layers (Figure 3.1). The loss of these nuclei is said to be the cause of apoptosis, a sequence of cytoplasmic and nuclear changes that result in the death of single cells [163]. The DNA is cleaved by endonucleases and the nucleus condenses and fragments [164], releasing DNA in its free floating form on the top layer of the skin.

The Locard Exchange Principle dictates that when two items come into contact, there is an exchange of materials [165]. This also forms the essence of the science of fingerprints. When an object is touched, sweat, oil and DNA from the fingers are transferred to the surface of the object. The resulting DNA that is left behind on the item is referred to as touch DNA. With the large number of potential DNA available for transfer, and the minute amounts required to develop a DNA profile, it is reasonable to conclude that all objects that come into contact with the skin are a potential source of DNA and therefore, for the development of DNA profiles. The DNA can then be retrieved by swabbing the surface that has been touched [166].



**Figure 3.1. The anatomy of the Human Skin: Epidermis, Dermis and Subcutaneous layer. Adapted in full with permission from [167].**

At crime scenes, it may be possible to deduce surfaces where the perpetrator has had physical contact on certain substrates, for example the door handle, handle of gun, a knife, or a piece of torn garment from struggles. These 'touched' areas can be swabbed (large items), or a fibre cut out (fabrics and garments), to collect any epithelial cells that may be shed during the contact [168-175]. The amount of touch DNA recovered from these samples can vary from none to several hundred picograms. The amount of DNA detected via contact is summarised in Table 3.1. In cases where the amount of DNA detected is less than 100 pg, or what is termed Low Template DNA (LTDNA), the PCR cycle number is generally increased to 34 cycles in order to obtain a successful profile, a technique called Low Copy Number (LCN) DNA analysis [45-47]. This increase in sensitivity does not come without its limitations. The issues surrounding LCN technology has been discussed in Chapter 1 (refer section 1.4).

**Table 3.1. Summary of the amount of DNA obtained from various touched item as reported in literature.**

<b>Substrate</b>	<b>Amount of DNA</b>	<b>Average DNA amount</b>	<b>Reference</b>
<b>Glass held for 60 s</b>	0 - 5.2 ng	0.52 ng	[176]
<b>Cotton fabric held for 60 s</b>	0 – 14.8 ng	1.23 ng	[176]
<b>Wood held for 60 s</b>	0 – 169 ng	5.85 ng	[176]
<b>Thumbprint on glass</b>	0 – 2 ng	-	[177]
<b>Thumbprint on wood</b>	0 – 2 ng	-	[177]
<b>Thumbprint on metal</b>	0 – 3 ng	-	[177]
<b>Swab of hands</b>	0.16 – 6.4 ng	-	[168]
<b>Tapelift of shoe insoles</b>	0 – 2 ng	-	[168]
<b>Touched Robbery items (wallet and mobile)</b>	-	8 ng	[102]
<b>Touched firearms</b>	-	0.6 ng	[102]
<b>Touched Tools (screwdrivers and knives)</b>	-	2.3 ng	[102]

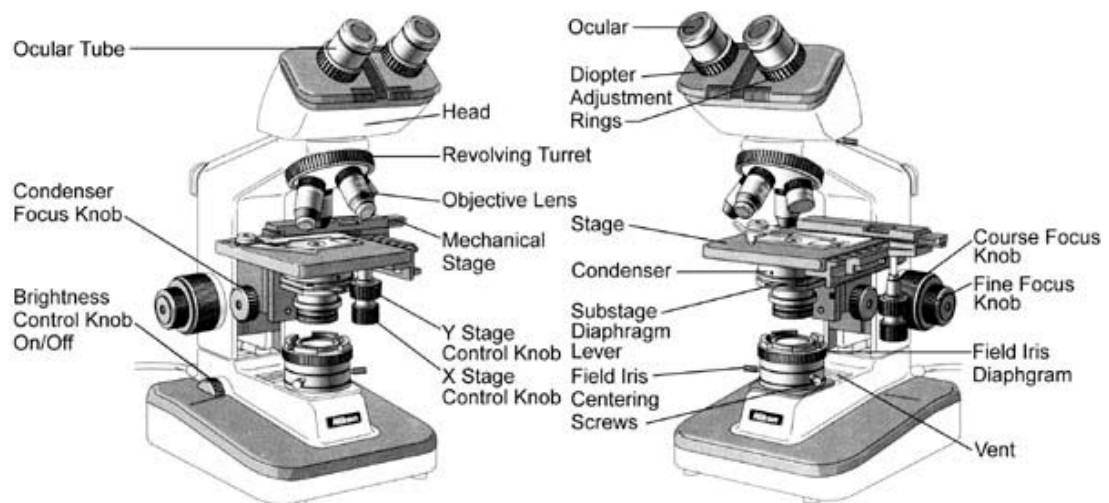
In 2002, Lowe *et al.* described the propensity of individuals to deposit DNA on inert surfaces [178]. They categorised individuals as being ‘good shedders’ or ‘bad shedders’ depending on the ability to deposit their DNA onto an item 15 min after hand wash. In their experiment, volunteers were requested to wash their hands and after 15 min, were asked to grip a plastic tube for 10 sec. The tubes were swabbed and amplified using the LCN protocol. Those individuals leaving a full profile were categorised as ‘good shedders’ while the individuals leaving a partial or no profile

were categorised as ‘poor shedders’. Farmen *et al.* agreed with the findings that individuals can be categorised as ‘good shedders’ and ‘bad shedders’ [56]. Allen *et al.* showed that the distribution of good and bad shedders were influenced by gender, where males tend to shed more than females [179] but this was not supported by other research [176]. However, the experiment by Lowe *et al.* was repeated by Phipps *et al.* and they indicated that an individual cannot be relied upon to shed a consistent amount of DNA over time [172]. They stated that it may be more difficult than expected to classify individuals merely as ‘good’ and ‘bad’ shedder, though they do concur with Lowe *et al.* in stating that individuals do vary in the ability to deposit DNA on items. No assumption is made on the shedder status of the volunteers used in this study to mimic real case scenarios whereby the shedder status of the DNA source at a crime scene is usually not known.

The quantity of DNA that can be recovered from fingerprints depends on two main factors: (1) the amount of DNA left by an individual by touching an object and (2) the suitability of recovery and extraction techniques employed [177]. There are other factors, such as substrate characteristics and action of atmospheric agents to name a few which can be considered as secondary factors that occasionally intervene and are capable of influencing the DNA profiles obtained [177]. The amount of DNA left by an individual cannot be controlled as it depends on various biological and physiological factors such as the turnover rate of epidermal maturation and differentiation. The suitability of recovery and extraction, however, can be influenced. By eliminating the extraction step, as in direct PCR, it can be assumed that most of the DNA that is recovered will be available as a template for amplification, creating a better opportunity for the generation of DNA profiles.

### 3.1.3 Compound light microscope

The compound light microscope uses a combination of different lenses to produce a magnified image of very small samples, for example epithelial cells, which are not possible to see with the naked eye. The different components in the light microscope gather light and redirect the light path so that the magnified image can be focused at a very short distance. The basic components of the compound microscope can be seen in Figure 3.2 [180].



**Figure 3.2. The different components of a compound light microscope. Adapted in full with permission from [180].**

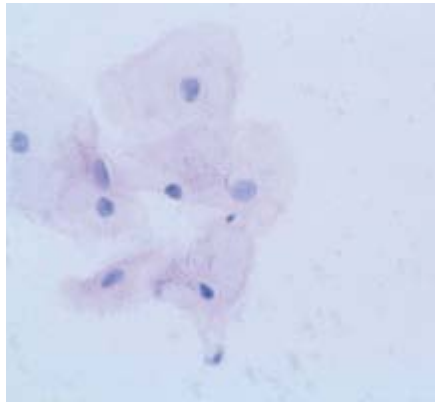
The light originates from the illuminator and is collimated by the condenser. The light then interacts with the sample that is placed on the stage, which is then collected by the objective lens [181]. The function of the objective is to re-focus the image onto the back focal plane of the microscope [181]. The oculars then receive the image and focus it into the viewer's eye [181]. The compound light microscope offers total magnification usually within the range of 40x to 400x [181].

### 3.1.4 Hematoxylin-Eosin staining (H&E staining)

Most cells are colourless and transparent (Figure 3.3) and therefore need to be stained in order to make them readily visible. Staining usually works by using a dye that stains some of the cell components a bright colour while counterstaining the rest of the cell a different colour. The H&E stain contains two dyes, hematoxylin and eosin. Hematoxylin is actually a dye called hematein used in combination with aluminium ions [182]. Hematoxylin is used with a 'mordant' that makes this stain act as a basic dye and stain acidic structures blue. The mordant binds to the tissue, and then hematoxylin binds to the mordant, forming a tissue-mordant-hematoxylin structure [182]. DNA in the nucleus and RNA in the rough endoplasmic reticulum are acidic, which makes hematoxylin bind to them and staining them blue [183]. Eosin is an acidic dye which is negatively charged [183]. It stains basic structures red or pink. Most proteins in the cytoplasm are basic, causing eosin to bind to them staining them pink. An epithelial cell after staining with H&E is shown in Figure 3.4.



**Figure 3.3. Epithelial cells under 400 x magnification without staining.**



**Figure 3.4. Epithelial cells stained using H&E stain under 400 x magnification**

### **3.1.5 Aims and objectives**

There were three main objectives for conducting the experiments described in this chapter, which were:

- ❖ To observe if direct PCR can be used to obtain DNA profiles from intact buccal cells. The assumption is that the hotstart cycle during PCR is sufficient in breaking open the cell to release DNA for amplification and this assumption is tested in this experiment.
- ❖ To investigate the efficiency of recovery of a moist cotton swab using the swabbing technique described in Chapter 2.
- ❖ To compare the DNA profiles obtained from buccal cells when subjected to direct PCR and QiaAmp DNA extraction.
- ❖ The possibility of obtaining a DNA profile from fingerprints using direct PCR. In this study two commonly found substrates were used to deposit fingerprints which were then subjected to direct PCR.



## **3.2 Materials and methods**

### **3.2.1 Comparison between direct PCR and extraction from buccal cells**

Buccal cells were collected from three volunteers by scraping the inner lining of the cheek using cotton tipped swabs. The cotton swabs were cut and immersed in deionised water and incubated for 30 min at 37°C to loosen the cells from the cotton fibres. The cotton swabs were removed and the samples were centrifuged at high speed to pellet the cells. A washing step was carried out by removing the supernatant carefully without disturbing the pellet and reconstituting the cell pellet in 200 µL of deionised water. The cells were then pipetted onto the glass slides and allowed to air dry overnight at room temperature. The number of cells on each slide was counted under the microscope without staining so the stains would not affect the amplification reaction. After counting, the cells were then swabbed off the slide with a sterile cotton swab using the technique described in Chapter 2. The slides were divided into two sets depending on the number of cells present on each slide, for direct amplification and Qiagen extraction. The slides were then stained using H&E staining, and the cells remaining on the slides were counted. The number of cells that were present on the swab was then determined by subtracting the number of cells present on the slide after swabbing from the number of cells that were present before swabbing.

#### **3.2.1.1 H&E staining**

The cells were fixed on the slide by passing the slide through flame a few times. One drop of hematoxylin (Sigma Aldrich) was dropped onto the slides and left for 5 min. The slides were washed with deionised water and left to drain. One drop of eosin (BDH Chemicals) was then dropped onto the slides and left for 1 min. The slides were washed again with deionised water thoroughly and the excess water was wiped off. The slides were placed in the oven to dry before observing the cells under the microscope.

### 3.2.1.2 Direct PCR

A 2 mm<sup>2</sup> portion of the tip of the swab was cut and placed in a 0.2 mL PCR tube for direct PCR. A total of 25 samples with various cell counts were amplified. It was assumed that all cells swabbed from the slides were present in the amplification reaction.

### 3.2.1.3 QIAamp<sup>®</sup> DNA Micro Extraction

The whole swab was cut and placed in a 1.5 mL tube. The swabs were extracted using the QIAamp<sup>®</sup> DNA Micro Extraction Kit (Qiagen, UK) following the manufacturer's recommended protocol [139]. A total of 25 samples with various cell counts were extracted and eluted in an end volume of 20 µL to 40 µL with sterile distilled water, depending on the cell count. No quantification of the samples were carried out, therefore the amount of DNA in the sample was only estimated. Since the volume of sample used for amplification was 10 µL, the number of cells (or DNA equivalent to the number of cells present, assuming each cell contains 6 pg of DNA [21]) in the amplification reaction was calculated using the formula:

$$\text{Cell count / final volume (}\mu\text{L)} \times 10 \qquad \text{Equation 3.1}$$

### 3.2.2 Reference samples

Reference samples were collected to compare the DNA profiles obtained from the fingerprint experiments detailed in section 3.2.3 with the reference profiles. Buccal swabs were obtained from ten volunteers and extracted using the QIAamp<sup>®</sup> DNA Mini extraction kit following the QIAamp DNA Mini extraction protocol with modification (Figure 3.5). The final elution volume was 150 µL in sterile deionised water. An extract negative was extracted together with each batch of extracts to detect contamination. Informed consent was obtained from all volunteers after gaining ethical approval from the University of Strathclyde ethics committee.

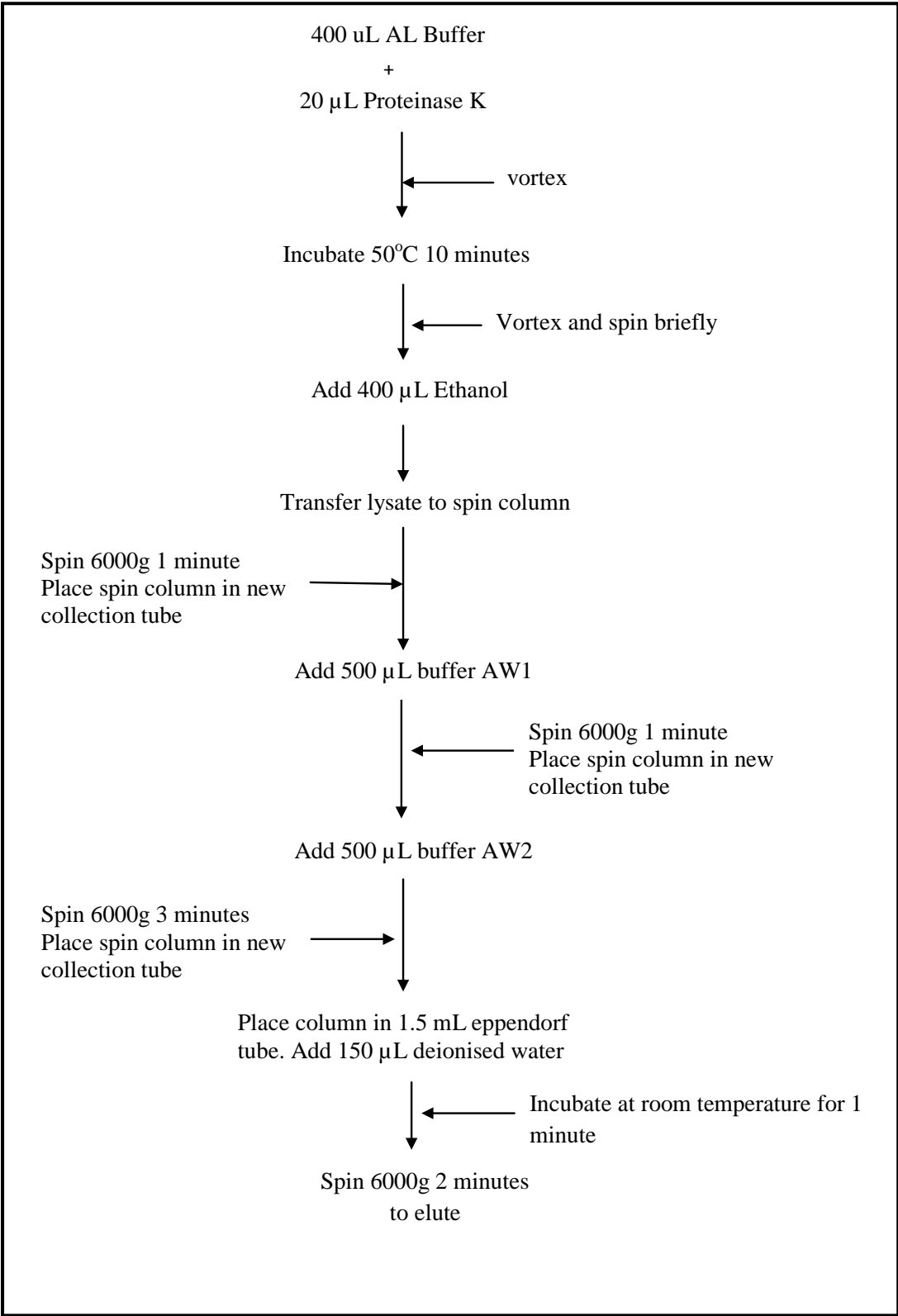


Figure 3.5. QiaAmp<sup>®</sup> DNA Mini extraction protocol with modifications.

### **3.2.3 Direct PCR of fingerprints on glass and plastic**

Glass microscope slides and plastic containers were cleaned with Trigene (Medimark Scientific, UK) and UV crosslinked in a cross linker for 30 min to destroy any DNA present on the slides prior to conducting the experiment. Ten volunteers were requested to wash their hands one hour prior to the experiment. They were then requested to place their right and left thumbprints on both the substrates, pressing using mild pressure for approximately 5 sec. The prints were taken at different times on different days for both substrates. Some of the prints deposited on the glass slides were visualised under the microscope to observe if there were intact cells present. The prints were then swabbed separately using a sterile moist cotton tipped swab. A 2 mm<sup>2</sup> piece of the tip of the swab was cut off and placed in a 0.2 mL amplification tube for direct PCR.

### **3.2.4 Amplification and Electrophoresis**

The samples were amplified using the SGMPlus™ (Life Technologies, UK) amplification kit in a 25 µL reaction volume at 28 cycles. Amplification were carried out in a 2720 thermal cycler (Life Technologies, UK). All batches of amplification were performed together with negative and positive controls. The results for the batch of amplification were accepted only when no peaks were observed in the extract blanks and negative and positive controls revealed the expected STR profile. The PCR master mix components and volumes for each component used are stated in Table 3.2 whilst the PCR thermal cycler conditions are shown in Table 3.3.

**Table 3.2. Reaction volumes for each component of the AmpFISTR SGMPlus used in each amplification reaction. Multi mix was prepared for  $n + 1$  for  $n$  number of samples and 15  $\mu$ L and 25  $\mu$ L of the master mix were aliquot for amplification of extracts and direct PCR respectively.**

Master mix component	Volume per sample per reaction ( $\mu$ L)	
	Extracts	Direct PCR
Reaction mix	10	10
Primer set	5	5
Ampli <i>Taq</i> Gold DNA polymerase	0.75	0.75
ddH <sub>2</sub> O	-	10
DNA template	10	-

**Table 3.3. Amplification protocol of AmpFISTR SGMPlus with 2720 thermal cyclers.**

1 cycle	28 cycles			1 cycle
95°C	94°C	59°C	72°C	60°C
11 min	60 sec	60 sec	60 sec	45 min

Electrophoresis was performed using the 310 Genetic Analyser (Life Technologies, UK). The formamide:Rox-500 ratio used was 16:0.5 per 2  $\mu$ L of PCR sample. The electrophoresis parameters used for all the samples are described in Table 3.4.

**Table 3.4. Electrophoresis parameters used to run samples amplified with SGMPlus.**

<b>Injection time</b>	5 sec
<b>Oven temperature</b>	60°C
<b>Injection Voltage</b>	1.5 kv
<b>Run time</b>	28 min

### 3.2.5 Data analysis

The percentage efficiency ( $\%E_f$ ) of recovery using cotton tipped swabs was calculated using the formula:

$$\frac{\text{No. of cells retrieved by swabbing}}{\text{Total no. of cells present before swabbing}} \times 100 \quad \text{Equation 3.2}$$

$\%E_f$  was calculated to demonstrate the effectiveness of retrieving buccal cells using cotton tipped swabs moistened with sterile distilled water.

Raw data and electropherograms (EPGs) were analysed using the GeneMapper ID v.3.2.1 software. The EPG data were then exported into Microsoft® Excel before carrying out statistical analysis using the Minitab® 16 software.

From the EPGs obtained, percentage profile ( $\%P$ ) was calculated by using the formula:

$$\frac{\text{No. of observed alleles}}{\text{No. of expected alleles}} \times 100 \quad \text{Equation 3.3}$$

while total peak height (TPH) was obtained by summing the peaks heights of all alleles above the threshold. The threshold set for calculating  $\%P$  and TPH was 50 rfu, which meant that all alleles observed above this threshold were included in the calculations.

### **3.3 Results and discussion**

#### **3.3.1 Comparison between direct PCR and extraction on buccal cells**

Buccal cells were deposited onto glass microscope slides and the number of cells on each slide was counted. The results of the number of cells observed on the slides before and after swabbing and grouped for direct PCR are tabulated in Table 3.5 while samples assigned to be subjected for QIAamp DNA Micro extraction are tabulated in Table 3.6. The data obtained was used to calculate the efficiency of recovery (3.3.1.1) and total peak height and percentage profile (3.3.1.2).

**Table 3.5. The number of cells present on the slides and on the swab before and after swabbing for samples subjected to direct PCR.**

Sample ID	Cells on slide		Number of cells present on swab
	Before swabbing	After swabbing	
1	14	3	11
2	25	2	23
3	24	5	19
4	9	3	6
5	28	3	25
6	32	7	25
7	35	13	22
8	68	12	56
9	17	2	15
10	52	20	32
11	76	21	55
12	116	26	90
13	11	0	11
36	40	12	28
38	36	5	31
42	54	2	52
46	188	80	64
48	130	39	91
49	115	21	94
50	113	33	80
51	141	59	82
52	120	29	91
53	92	52	40
55	79	42	37
58	31	16	15

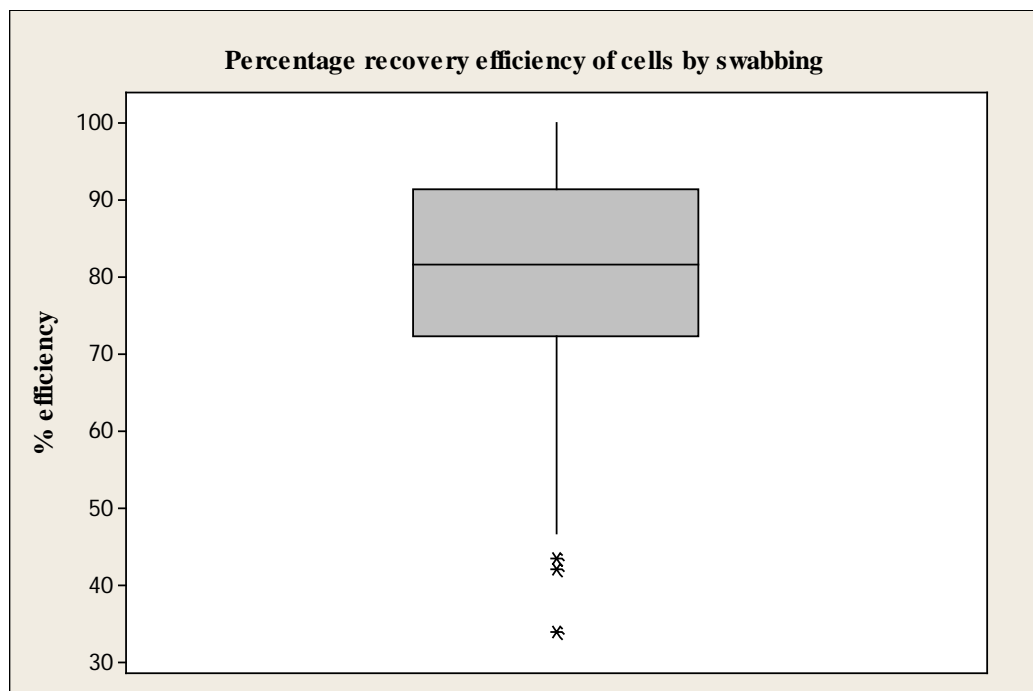


**Table 3.6. Number of cells present on the slides and in the PCR before and after swabbing for samples subjected to QIAamp DNA Micro extraction.**

Sample ID	Cells on slide		Number of cells on swab	Estimated number of cells in PCR
	Before swabbing	After swabbing		
14	78	9	69	23
15	75	16	59	20
16	59	16	43	14
17	57	33	24	8
18	50	13	37	12
19	79	17	62	31
20	106	9	97	33
21	88	6	82	27
22	162	14	148	37
23	95	13	82	41
24	118	12	106	53
25	121	5	116	58
26	140	1	139	69
27	165	10	155	51
28	216	23	193	64
29	265	30	233	58
30	216	27	189	94
31	204	45	159	80
32	319	22	297	99
33	403	22	381	95
34	263	20	243	81
35	366	34	332	83
54	191	52	139	40
56	127	11	116	38
57	64	17	47	15

### 3.3.1.1 Efficiency of recovery

With the data obtained in 3.3.1, the efficiency of cotton swabs to retrieve buccal cells from glass substrate could be calculated. This data provides a general idea on how much biological material a moist cotton swab can retrieve from a substrate using the swabbing technique described in Chapter 2. The  $\%E_f$  is shown in Figure 3.6. The  $\%E_f$  shows that the efficiency of retrieving cells from a glass slide using cotton tipped swabs ranged from around 50% to 100%. In general, three out of four swabbings showed a cell loss of less than 30%. The data was observed to have a median value of around 80% efficiency of recovery.



**Figure 3.6. Boxplot showing the percentage efficiency of recovering cells by swabbing. The whiskers indicate the minimum and maximum range of 47% to 100% respectively with a median of 81%. The interquartile range is 19%. Outliers are indicated in asterisks.**

The amount of biological material retrieved in this experiment was found to be superior to those reported by Sweet *et al.* [121] where they compared the efficiency of DNA recovery using the single and double swab techniques. In their study, they found that single moist swab recovered approximately 35% while the double swab technique recovered approximately 44% of the DNA deposited, although their calculation for DNA recovery was carried out after the extraction step, and thus includes the amount of DNA lost during extraction [121]. However, it is reasonable to conclude that the single moist swab in combination with the swabbing technique described in Chapter 2 and used for the collection of biological material in this thesis is as efficient, if not better, in retrieving biological materials compared to the single or double swab techniques described in literature [121, 123, 150].

The efficiency of DNA recovery using cotton swabs is claimed to be dependent on the substrate on which the cells are adhered to and the dehydrated state of the cells [123]. The effect of the substrate on which DNA is adhered to on DNA recovery has been explored in Chapter 2. The moisturiser from the swab gets transferred to the substrate and rehydrates the epithelial cells present. The epithelial cells adhere more easily to the cotton swab in their rehydrated state [121, 123]. In addition, capillary action is thought to be an important mechanism to remove the epithelial cells from the surface [121, 123]. In the double swab technique, the first wet swab rehydrates the epithelial cells to loosen and recover it, and through capillary action, the second swab retrieves the remaining epithelial cells from the surface. When using a single moist swab, it is thought that by prolonging the duration of swabbing, the single swab can act as both the wet and dry swabs utilised in the double swab technique. When moisturiser is applied to the swab, the process of swabbing would spread the moisture around the surface of the substrate to rehydrate the cells at the same time dehydrating the swab. When the swab is sufficiently dehydrated, it would then act as a dry swab by recovering the cells and moisture present on the surface through capillary action.

Although water was still the preferred moisturising agent by many [150] and was used in this experiment, there have been reports in using other moisturising agents such as 0.01% sodium dodecyl sulphate (SDS) [51]. SDS is a surfactant which is commonly used to denature proteins. SDS in the amplification reaction can denature the polymerase enzyme and for this reason this moisturising agent was not used in this experiment. There could be other moisturising agents, such as buffers like Tris-EDTA (TE), which were not tested in this experiment but could help improve the amount of DNA recovered.

### 3.3.1.2 Total peak height and Percentage profile

A scatterplot TPH and %P data is illustrated in Figure 3.7. Pearson's correlation indicates that there is a strong linear positive correlation between TPH and %P (Pearson Correlation 0.829; p-value 0.000) for an  $\alpha$  value of 0.05. The scatter plot indicates that when %P increases there is an increase in TPH. This is as expected as both the TPH and %P are extrapolated from the allele peak height data obtained.

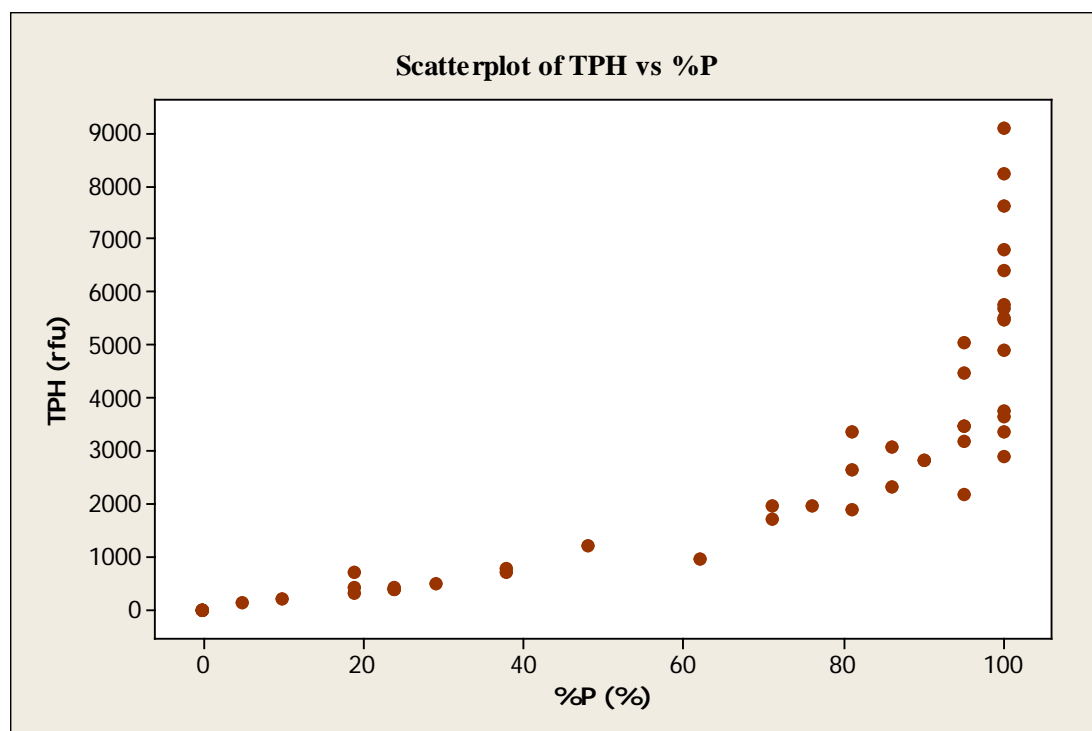
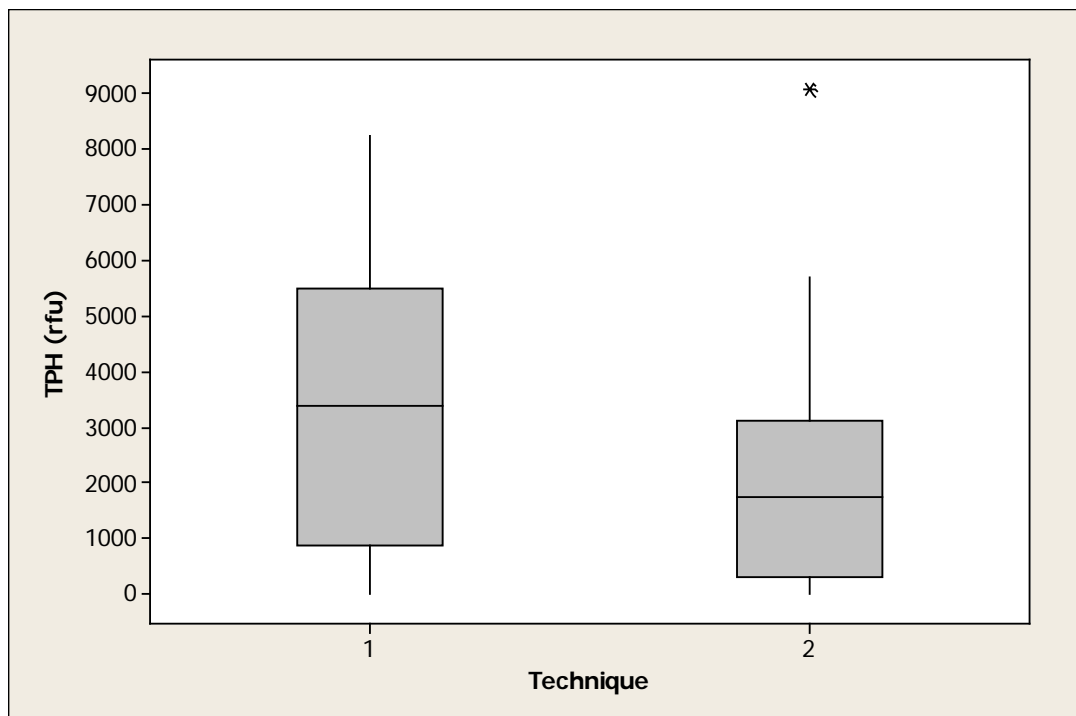
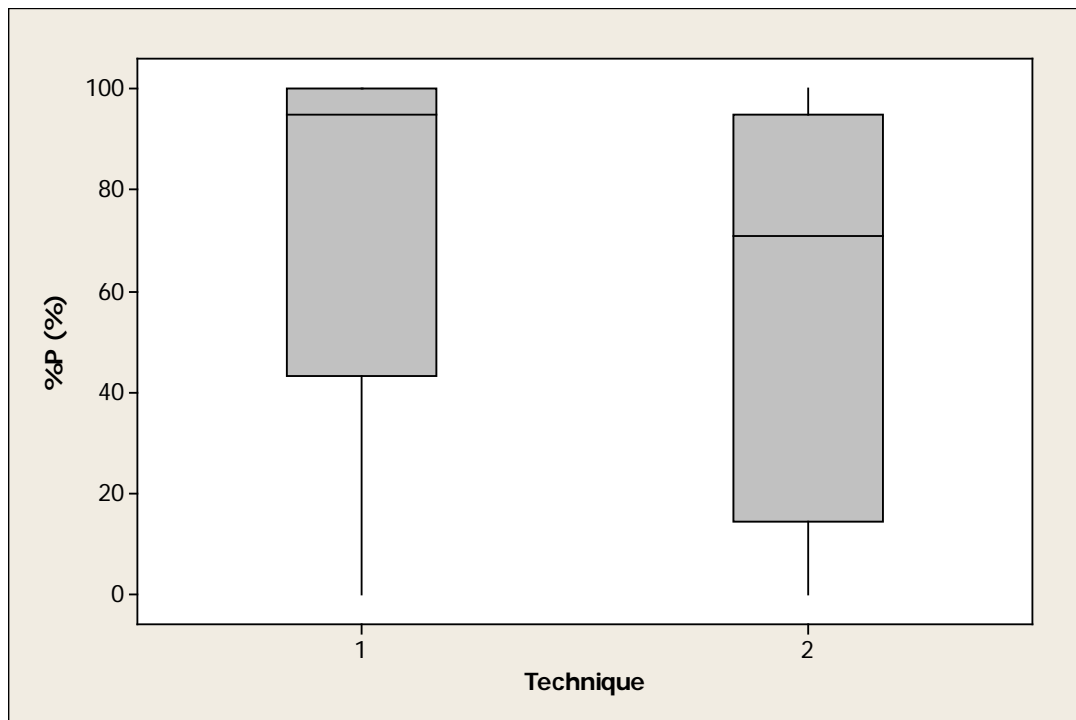


Figure 3.7. Scatterplot illustrating the distribution of data for TPH vs %P.

The data were then used to formulate boxplots as shown in Figure 3.8 and Figure 3.9 to compare the results between direct PCR and Qiagen extraction for both TPH and %P. Overall, direct PCR gave better TPH and %P compared to Qiagen extraction. The median TPH for direct PCR was 3375 rfu with a minimum of 0 rfu and maximum of 8235 rfu, while for Qiagen extraction, the median TPH was 1727 rfu with a minimum and maximum of 0 rfu and 5702 rfu respectively. Half the samples subjected to direct PCR gave %P of more than 95% while for Qiagen extraction, half the samples gave %P of more than 71%. The Mann-Whitney test indicated that the medians for TPH and %P were significantly different between direct PCR and Qiagen extraction (p-value = 0.022 for TPH and p-value = 0.027 for %P). This confirms the findings that direct PCR gave better TPH and %P than Qiagen extraction on buccal cell samples.



**Figure 3.8. Boxplot of TPH based on the different techniques used, 1: direct PCR; 2: Qiagen extraction. The whiskers indicate the minimum and maximum values for 1: 0 rfu to 8235 rfu, 2: 0 rfu to 5702 rfu; interquartile range for 1: 4621 rfu, 2: 2845 rfu; and median of 1: 3375 rfu, 2: 1727 rfu. Outlier is indicated in asterisk.**

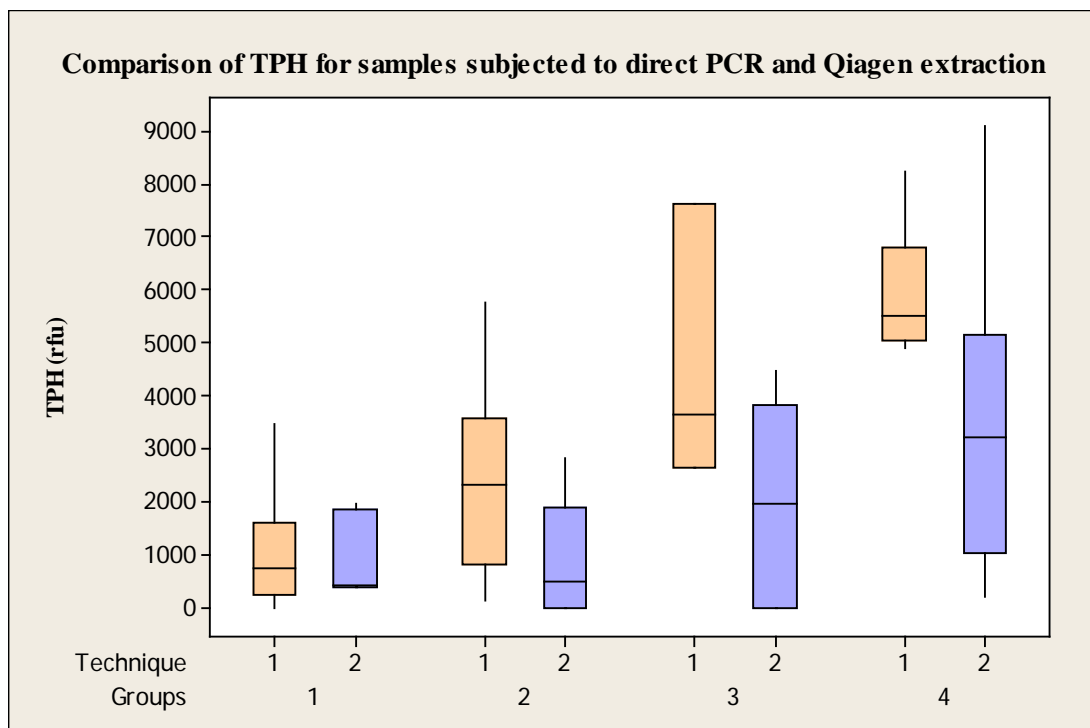


**Figure 3.9. Boxplot of %P based on different techniques, 1: direct PCR; 2: Qiagen extraction. The whiskers indicate the minimum and maximum values for both 1 and 2 are 0% to 100%; interquartile range for 1: 57%, 2: 80.5%; and median of 1: 95%, 2: 71%.**

As it was not possible to compare both the techniques based on cell count, the buccal cell samples were grouped into four categories according to the number of cells found in each sample. The categories include group 1 to group 4 which contained < 20 cells, 21 - 40 cells, 41 - 60 cells and > 60 cells respectively. The data were reanalysed for TPH and %P and shown in Figure 3.10 and Figure 3.11.

When the samples were reanalysed according to their groups, the results indicated that for low cell count (group 1), the TPH obtained from direct PCR and Qiagen extraction were quite similar with both their median TPH of less than 1000 rfu. As the number of cell counts increased, median TPH for both direct PCR and Qiagen extraction also increased, but direct PCR showed a higher increase in median TPH compared to Qiagen extraction. For cell counts of more than 60 (group 4), all EPGs obtained using direct PCR had peak heights of more than 5000 rfu. Although direct

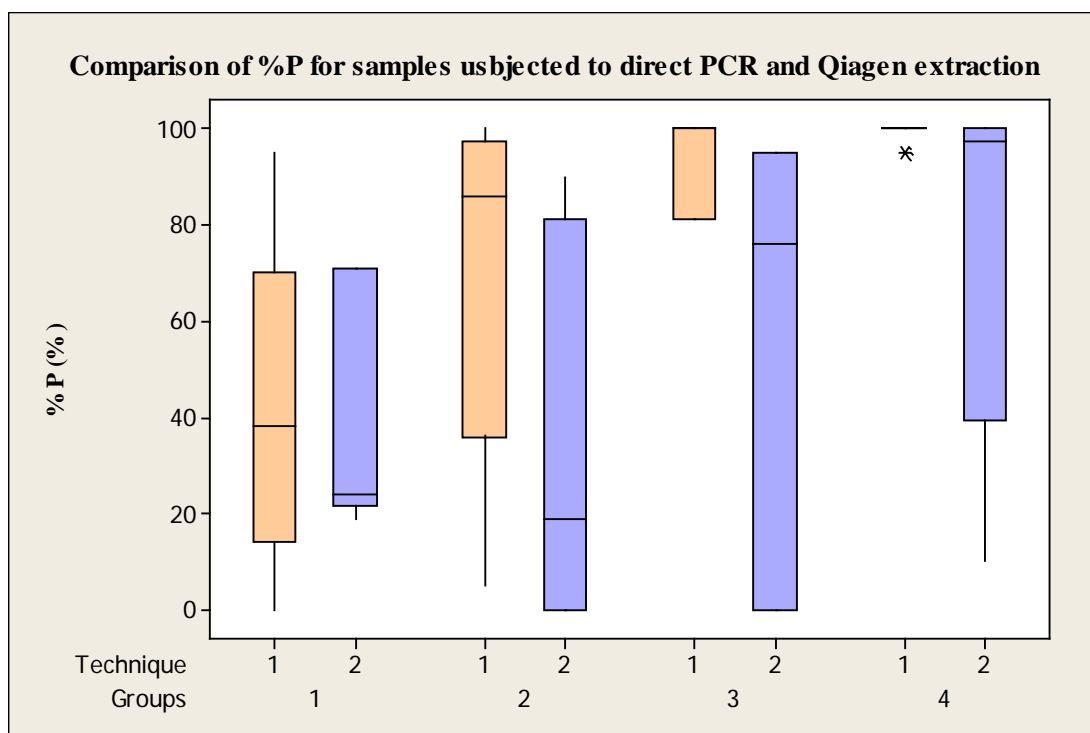
PCR was observed to give better TPH when compared to Qiagen extraction, the Mann-Whitney test indicated that there was no significant difference for median TPH between direct PCR and Qiagen extraction for groups 1, 3 and 4 (p-values 0.927, 0.233 and 0.056 respectively), but there was a statistical difference for median TPH for group 2 (p-values 0.050).



**Figure 3.10. Boxplots of TPH based on different techniques, 1: direct PCR; 2: Qiagen extraction; which were divided into groups based on cell count 1: < 20; 2: 21 - 40; 3: 41 - 60 and 4: > 60.**

Samples analysed for %P showed similar results as in TPH whereby the %P for group 1 were similar in both direct PCR and Qiagen extraction. A big difference could be observed in groups 3 and 4 where all the samples in group 3 showed more than 80% of profile, while in group 4 almost all samples analysed showed 100% profile for samples subjected to direct PCR. Qiagen extracted samples for both these groups showed a wide range of %P even though more than 40 cells were analysed, which is equivalent to more than 240 pg [21]. The same statistical findings as TPH data were obtained for %P where there was no significant difference for median %P

between direct PCR and Qiagen extraction for groups 1, 3 and 4 (p-values 1.000, 0.129 and 0.129 respectively) but there was a significant difference for median %P for group 2 (p-value 0.043).



**Figure 3.11. Boxplots of %P based on different techniques, 1: direct PCR; 2: Qiagen extraction; which were divided into groups based on cell count 1: < 20; 2: 21 - 40; 3: 41 - 60 and 4: > 60. Outlier is indicated as an asterisk.**

From this experiment, it has been proven that direct PCR gives better TPH and %P when compared to buccal samples that are subjected to Qiagen extraction. One of the possible reasons that direct PCR was observed to give better TPH and %P when compared to Qiagen extraction could be the amount of DNA loss during extraction. Barboro *et al.* discovered DNA loss of around 30% when DNA is extracted using the Qiagen spin columns [28]. This includes DNA that is washed away during the washing steps and those that adhere to the multiple plastic tubes during sample transfer. It has been reported that DNA commonly adheres to the plastic, membrane and rubber components of the Centricon<sup>®</sup> device [150], and this could also be true



for the Qiagen spin columns. In addition, not all the DNA extracted may have been eluted from the silica membrane of the Qiagen spin column, adding to the amount of DNA lost during extraction. Most laboratory consumables such as sample tubes and pipette tips are made of polypropylene due to its resistance to solvents, strength, ease of use and low price [104]. In the presence of high ionic strength solutions, such as guanidine hydrochloride which is used as an extraction buffer with the Qiagen spin columns, the amount of DNA adsorbed to the polypropylene tubes can be as high as  $5 \text{ ng/mm}^2$  of tube wall [104]. The high ionic strength solution stimulates interaction of DNA with polypropylene and leads to more DNA being lost. Therefore, the elimination of an extraction step not only reduces loss of DNA during the purification stages, but also minimises the exposure of the DNA molecules to polypropylene tubes, and thus resulting in increased chances of obtaining a DNA profile.

### **3.3.2 Direct PCR of fingerprints on glass and plastic**

TPH and %P were calculated for fingerprints deposited on the glass microscope slide and plastic container (Table 3.7). All thumbprints were clearly visible on both the substrates under bright light indicating that transfer of materials from thumb onto the substrate surface had occurred. When the thumbprints were visualised under the microscope, three of the slides showed fragmented cells without nucleus, but no intact cells were present on any of the slides observed, which somewhat corroborate the results of Alessandrini *et al.* [177] and Balogh *et al.* [184]. Alessandrini *et al.* found that out of 44 fingerprints tested, the number of nucleated cells and stripped nuclei left on a slide after thumb pressure of around 30 sec varied within the same donor and ranged from none to 14, with a median of around 3 cells and nuclei [177]. Balogh *et al.* stated that the majority of cells present on the latent thumbprint were nuclei-free corneocytes with 'minimal incidences of nucleated cells', but did not state the amount of nucleated cells present, or the number of samples tested [184]. Loss of corneocytes from the skin can be affected by diseases (psoriasis and carcinoma) or by the regulation in keratinocyte cycle where accelerated turnover of

epidermal maturation and differentiation can cause an increase in the presence of nucleated cells and stripped nuclei.

**Table 3.7. Total peak height and Percentage profile for thumbprints deposited on glass microscope slides.**

Donor	Hand	Glass		Plastic	
		TPH	%P	TPH	%P
1	Right	0	0	175	5
	Left	0	0	0	0
2	Right	60	5	0	0
	Left	68	5	690	21
3	Right	7303	100	7686	85
	Left	951	21	11536	100
4	Right	1085	58	0	0
	Left	846	37	851	26
5	Right	57559	100	656	19
	Left	213	14	6739	100
6	Right	0	0	320	10
	Left	0	0	6580	100
7	Right	1056	32	0	0
	Left	361	21	109	5
8	Right	50	5	0	0
	Left	356	16	970	37
9	Right	241	21	1077	42
	Left	1063	59	973	37
10	Right	2357	95	0	0
	Left	11341	100	0	0

Based on the DNA profiles obtained, only two volunteers (volunteers 3 and 5) provided fingerprints which gave full DNA profiles on both the substrates tested. From the fingerprints provided by volunteers 6 and 10, full DNA profiles were obtained from one of the substrates but not on the other suggesting that individuals do not consistently deposit DNA when an item is touched [172].

Though all thumbprints were clearly visible indicating there was a strong contact and transfer of materials between thumb and substrate, this does not correlate with the amount of DNA that was deposited, which confirms the literature [185, 186]. In other words, the presence of a clear fingerprint does not indicate the potential success of obtaining a DNA profile. The number of fingerprints which were observed to produce more than 50% of alleles in the profile was six in glass and four in plastic out of the 20 fingerprints analysed. This represents about 30% and 20% of the fingerprints respectively. This does not seem to be a large success rate and could be attributed to a number of factors. Firstly, since only a small area of skin (thumb) which came in contact with the substrate, the amount of DNA that was deposited may have been very small. Higher success rates of obtaining DNA profiles have been reported when individuals were asked to hold a substrate and the entire surface area was swabbed for DNA profiling [171, 187]. Secondly, the SGMPlus kit utilised to obtain DNA profiles have a sensitivity of about 250 pg when a 28 cycle protocol is used [47, 48]. Similar success rates of obtaining DNA profiles as found in this study were reported by Alessandrini *et al.* when they amplified DNA retrieved from fingerprints using LCN amplification protocol [177]. However, they also reported the occurrences of allelic dropins, dropouts, laboratory-based contamination and increased stutter ratios which are all common artefacts when using LCN [45, 188]. These artefacts were not encountered in the laboratory when experiments using direct PCR were carried out, which again emphasises the benefits of using direct PCR for low template DNA analysis.

### 3.4 Conclusion

The results obtained from this study suggested that the swabbing technique used here was able to retrieve more cells/DNA compared to other techniques of swabbing using single moist swabs and found to be similar if not superior to the efficiency of the double swab technique described by Sweet *et al.* [121]. This, in my opinion, is attributed to the prolonged swabbing time applied with the single moist swab which allows the swab to function with the same principle as the double swab technique. This study has also proven that it is possible to obtain DNA profiles from intact buccal cells using direct PCR. The hotstart cycle during PCR has an elevated temperature of around 95°C for approximately 10 min, which is sufficient in breaking open the cells to release the DNA stored inside to act as a template for the amplification reaction. In fact, direct PCR was observed to give better DNA profiles than Qiagen extracted buccal cells, which proves that DNA loss associated with extraction techniques can affect the quality of the DNA profile obtained.

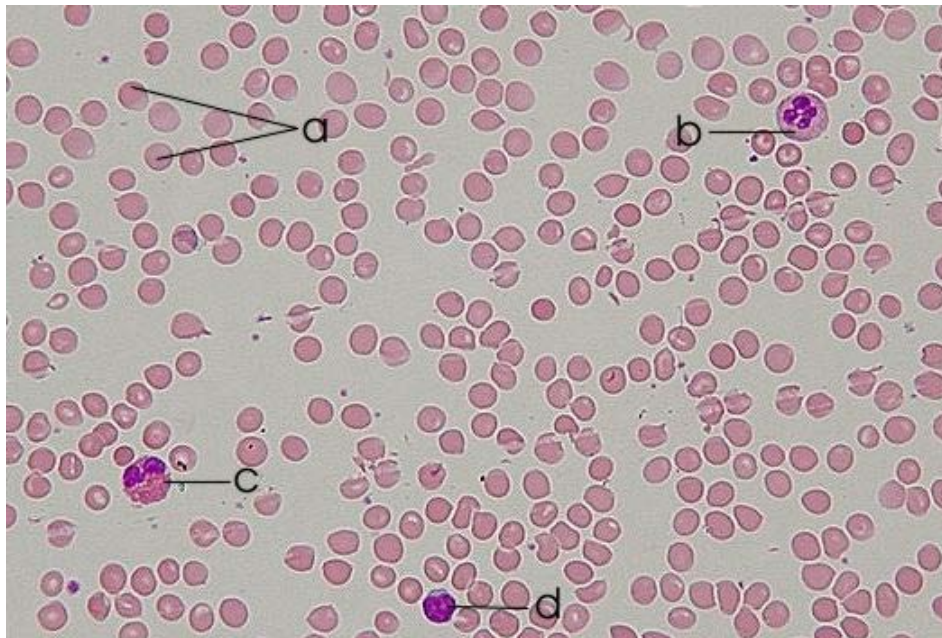
## **4 Analysis of touch DNA and body fluids on fabric using direct PCR**

### **4.1 Introduction**

In previous chapters, the use of direct PCR for low template DNA retrieved from non-porous substrates has been established. This chapter will go on to discuss the use of direct PCR to obtain DNA profiles from touched fabrics and fabrics with blood and semen stains.

#### **4.1.1 Blood and semen as sources of DNA**

Blood in the form of bloodstains is one of the most commonly found stains at a crime scene. Blood circulation is a transport mechanism in animals which has multiple functions which include delivery of oxygen and nutrients to the cells and taking metabolic wastes and carbon dioxide away from those same cells. Blood can be divided into two main components; plasma and cellular components. Plasma makes up 55% of the total blood volume [189] and contains mostly water with dissolved proteins, glucose, clotting factors and mineral ions. The cellular component makes up the rest of the blood volume and consists of red blood cells (erythrocytes), platelets and white blood cells which can be grouped into neutrophils, eosinophils, basophils and lymphocytes [189, 190]. In blood, only the white blood cells contain nuclei (Figure 4.1), and thus contain nuclear DNA. It is possible to obtain around 20000 ng to 40000 ng of DNA from every millilitre of liquid blood and 250 ng to 500 ng of DNA from every centimetre square of bloodstain [160], depending on the white blood cell count of the donor [191].



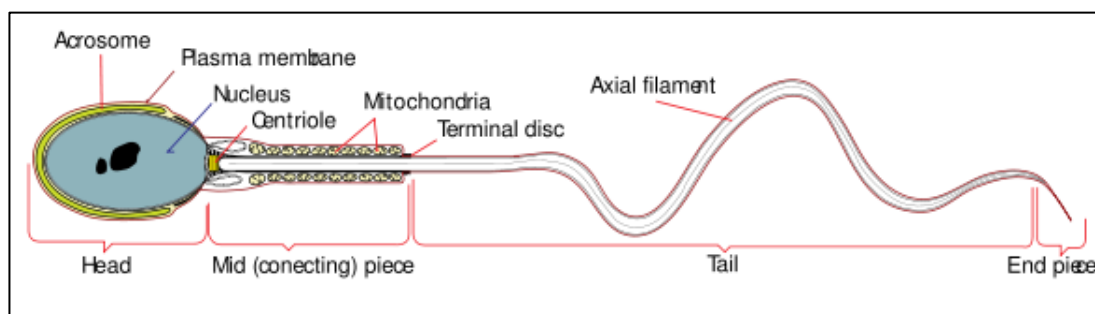
**Figure 4.1.** A light microscopy image showing a smear of blood on a microscopy slide [192] a: Erythrocytes; b: Neutrophil; c: Eosinophil; d: Lymphocyte. Reprinted under free GNU licence.

Red blood cells contain haemoglobin which carries out the oxygen transportation in red blood cells. Haemoglobin is made up of two components, the haem group (iron) and the globin group (protein). When blood is used for amplification, excess haem in the reaction reduces the efficiency or inhibits the action of the polymerase and can cause the amplification reaction to fail [193]. Besides haem, blood also contains various other compounds such as metal ions ( $\text{Ca}^{2+}$ ,  $\text{Na}^+$ ,  $\text{K}^+$ ,  $\text{Mg}^{2+}$ ), proteins and anticoagulants (taken as medication) which can act as inhibitors to PCR [84, 138].

Another commonly found body fluid at crime scenes are seminal fluid. Seminal fluid or semen is an ejaculate from the male reproductive system. The volume of a typical ejaculate is roughly around 3 mL [194]. It consists of two major fractions; the cellular fraction and the acellular fraction [194]. The acellular component of semen accounts for most of the volume of the seminal fluid. It is comprised of a wide range of proteins such as prostate specific antigens (PSA) and prostatic acid phosphatase (AP), and other compounds such as fructose, prostaglandins, zinc and citric acid [194].

Spermatozoa or sperms are the main component of the cellular fraction. It is the male reproductive cell which carries the male genomic material [195]. Sperm cells are comprised of a head, mid piece and a tail as shown in Figure 4.2 below. The head of the sperm contains the nucleus where packed genetic material in the form of DNA is kept [194]. Contrary to red blood cells, the heads of the sperm cells are resistant to DNA extraction procedures [83, 196]. Moreover, the DNA contained in the sperm heads are tightly associated with a group of proteins called protamines, which make the sperm DNA highly condensed [82, 83]. This highly condensed state of sperm chromatin makes it necessary to modify some extraction techniques to enable DNA to be extracted from sperm cells [83]. These morphological structures of sperm can prove to be a challenge when sperm cells are subjected to direct PCR.

Semen is most commonly encountered in sexual assault cases where it could be found as dried stains on garments, or obtained from the victim as vaginal swabs [197]. Liquid semen can contain 150,000 ng/mL to 300,000 ng/mL of DNA whereas a vaginal swab can contain up to 3000 ng of DNA per swab [160].



**Figure 4.2. Diagram of a human spermatozoa. Adapted in full with permission from [198].**

The current practice in most forensic laboratories is to extract the DNA using one of the many extraction methods available and quantify the amount of DNA present (refer Chapter 1). The extraction process breaks the cells to release the DNA and purifies the DNA from proteins and inhibitors. When using direct PCR these proteins and inhibitors will co-exist in the amplification reaction and may reduce the amplification efficiency of the polymerase. There have been reports claiming that

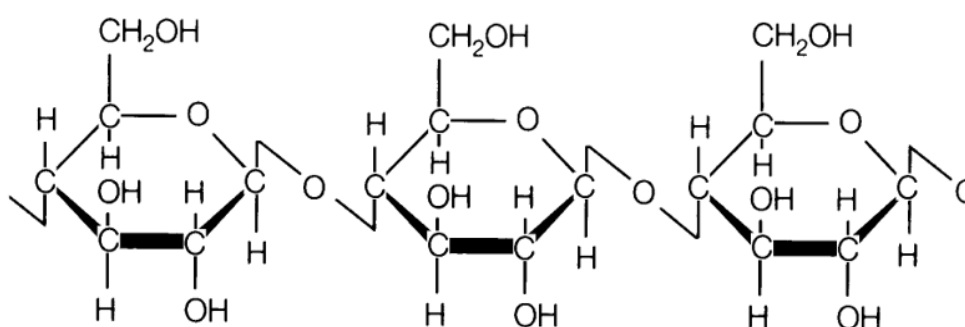
bloodstained fabrics were amplified without DNA extraction using the common STR multiplexes, but upon close reading, these methods usually involve some form of purification to neutralise the inhibitors prior to amplification [79, 199, 200]. Specialised kits have been developed by various companies that claim to be specially validated to be used for direct PCR to amplify body fluids [95, 201].

#### 4.1.2 Textile fibres

Cotton, nylon and denim were chosen in this study to represent the types of fabrics commonly sent to a forensic laboratory for DNA analysis. The physical property of these fabrics affects the way DNA interacts with the fibres and hence affects the quality of the DNA profile obtained. The physical properties of the chosen fabrics are further discussed below.

##### 4.1.2.1 Cotton

Cotton is a natural fibre harvested from the cotton plant. It is one of the most commonly used natural fibres with applications ranging from textiles to explosives and medical and the cosmetic industry. The major composition of cotton is cellulose, which is made up of the repeating subunit, glucose. The molecular structure of the glucose subunit which makes up the cotton polymer is shown in Figure 4.3.



**Figure 4.3. Molecular structure of the subunit of cellulose, glucose. Image obtained from [202].**



The most important chemical groupings on the cotton polymer are the hydroxyl groups (-OH) [203]. The -OH groups are also present as hydroxymethyl groups (CH<sub>2</sub>OH) [203]. Hydrogen bonds occur between OH groups of adjacent cotton polymers because of their polarity [203, 204]. Due to the presence of the polar -OH groups in the cotton polymer, cotton is very absorbent and attracts water molecules which are also polar [203, 204]. This hygroscopic nature of cotton also prevents it from developing electrostatic electricity. Cotton degradation is attributed to oxidation, hydrolysis and exposure to visible and ultraviolet light, especially at high temperatures around 250°C~397°C and humidity [205, 206].

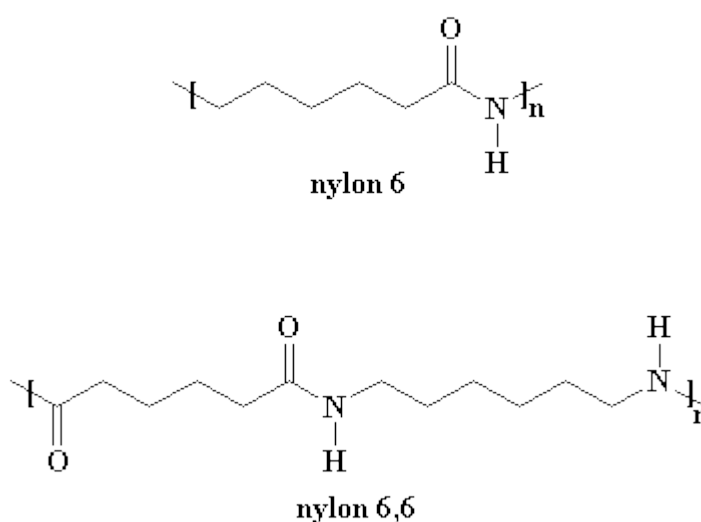
Cotton is commonly used as swabs to retrieve cells and DNA from crime scene to be processed in the laboratory [184]. Besides, cotton is also used extensively in the textile industry to make undergarments and clothing. Therefore, it is very likely that some of the clothing items sent to the laboratory for forensic DNA testing would be made of cotton. DNA can form strong hydrogen bonds with cotton molecules due to the presence of -OH groups [200]. Cotton garments are also commonly coloured using various dyes to enhance its aesthetic qualities. These various dyes, if present in the sample, can inhibit the amplification reaction and cause 'false negative' DNA profiles.

#### **4.1.2.2 Nylon**

Nylon is a generic designation for a family of synthetic polymers known as polyamides. Nylon is a light weight, thermoplastic, silky material used most famously for making women's stockings. It is also used in many other applications such as toothbrushes, fabrics, carpets, musical strings and because of its good strength and durability is used to make ropes and seatbelts. The two most commonly used polyamides are Nylon 6,6 and Nylon 6, the molecular structures shown in Figure 4.4.

Under the microscope, modified nylon has a tri-lobal cross-section with longitudinal striations [207]. The purpose of developing such a cross-section for the textile

industry was to provide a fibre surface which will have less contact with the skin during wear, thus making it more comfortable when used in clothing [207]. The most important chemical group in the nylon polymer are the polar amide groups (-CO-NH-) and the terminal amino groups (-NH<sub>2</sub>) [207]. The polarity of the amide group is caused by the slightly negative charge on the oxygen atom and the slightly positive charge of the hydrogen atom. These chemical groups are the ones that form the hydrogen bonds in the nylon polymer system. Nylon materials do not readily absorb water molecules and as such will develop static electricity readily.



**Figure 4.4. The molecular structure of the most commonly used forms of nylon, Nylon 6 and Nylon 6,6. Image obtained from [208].**

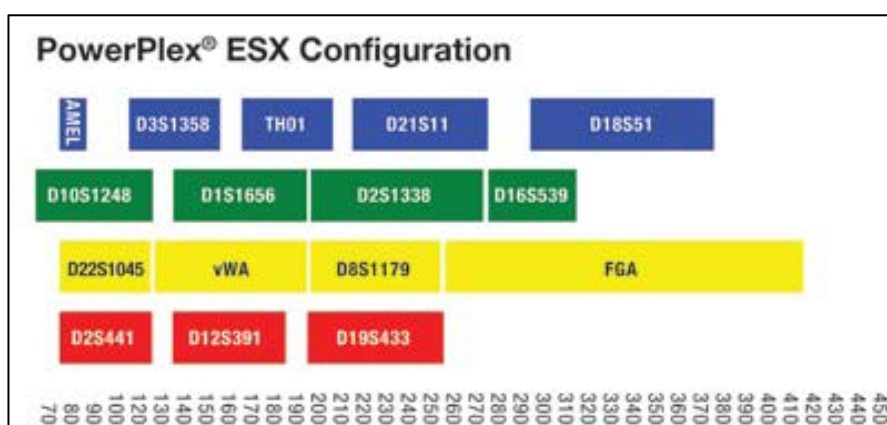
Nylon is used in molecular biology applications such as nylon membranes for DNA hybridization due to its properties. Nylon membranes have a high affinity to nucleic acids, are able to bind with smaller oligonucleotides and also bind with double stranded as well as single stranded DNA [209]. Nylon flocked swabs have also been tested and found to retrieve and release cells more easily than standard cotton swabs [155].

#### **4.1.2.3 Denim**

Most denim are made up of 100% cotton, however, there are denim textiles that are cotton blended with polyester or lycra. Denim is a twill fabric, which is a woven textile in which the filling threads pass over one then under at least two warp threads, giving the appearance of having diagonal lines. When denim is dyed, the colour sits on the surface of the thread, which is why the fabric's colour fades over time. "Blue jeans" denim fabrics are dyed with indigo dye, a dark blue crystalline powder that is insoluble in water, alcohol or ether but soluble in DMSO, chloroform, nitrobenzene and concentrated sulphuric acid. The presence of indigo dyes or its derivatives can often cause inhibition to the amplification reaction [88, 89].

#### **4.1.3 PowerPlex ESX kit**

There are many amplification kits available in the market today which are sensitive to detect low levels of DNA and sufficiently robust to tolerate the presence of common PCR inhibitor. The PowerPlex ESX 16 kit is a five colour fluorescent detection system which co-amplifies fifteen STR loci and amelogenin (Figure 4.5). Half of the loci in this kit are detected below the 200 bp range which makes this kit suitable for degraded DNA analysis [210]. According to validation study conducted by Tucker *et al.*, more than 50% of the DNA profile can still be detected for DNA concentrations as low as 62.5 pg [211]. As for the effects of inhibition, it has been demonstrated that this kit is able to withstand up to 600  $\mu$ M of haematin [211] rendering this kit suitable for direct PCR with blood and semen stains [212].



**Figure 4.5.** Configuration of the PowerPlex ESX 16 kit utilising the five dye detection system. Adapted in full with permission from [210].

#### 4.1.4 Aims and objectives

The aims of this work were:

1. To evaluate the use of direct PCR from various bloodstained fabrics to obtain DNA profiles. Blood contains many PCR inhibitors which are usually washed away during extraction. Since extraction is not carried out when using direct PCR, these inhibitors could potentially inhibit PCR.
2. To evaluate the use of direct PCR to obtain DNA profiles from various semen stained fabrics. It is usually difficult to obtain DNA from sperm heads due to their structure and morphology. Extensive extraction steps are usually required to break the sperm cell and release the DNA. In direct PCR, the heat during the hot start cycle is relied upon to denature the cells and release the DNA to act as template for amplification.
3. To compare the effects of different types of touched fabric and their dyes on the generation of DNA profiles using direct PCR.

## 4.2 Materials and methods

### 4.2.1 Direct PCR on touched fabric

Four types of fabrics were used in this research; white cotton T-shirt, brown cotton trousers, brown nylon stockings and light blue denim; which are detailed in Table 4.1Table 4.6. The fabrics were cut into 1 cm<sup>2</sup> squares and UV irradiated for about 30 min to destroy any exogenous DNA. Two volunteers were asked to rub the fabric with their forefinger and thumb for 10 sec. A 2 mm<sup>2</sup> piece of fabric was cut and placed in a 0.2 mL PCR tube as sample, whilst a 2 mm<sup>2</sup> piece of fabric was cut from an untouched area for substrate negative control. The experiment was repeated four times for each volunteer.

**Table 4.1. Garment and type of fabric used in this study.**

<b>Garment</b>	<b>Fabric type</b>
<b>Blue jeans</b>	denim
<b>Brown pants</b>	cotton
<b>White T-shirt</b>	cotton
<b>Skin coloured stockings</b>	nylon

The samples were amplified using the SGM Plus™ (Life Technologies, UK) amplification kit in a 25 µL reaction volume at 28 cycles following the manufacturer's recommended protocol [48]. Amplification were carried out in a 2720 thermal cycler (Life Technologies, UK). All batches of amplification were performed together with negative and positive controls. The results for the batch of amplification were accepted only when no peaks were observed in the extract blanks and negative controls and the positive controls showed the expected DNA profile. The PCR master mix components and volumes for each component used are stated in Table 4.2 whilst the PCR thermal cycler conditions are shown in Table 4.3. Electrophoresis was performed using the 310 Genetic analyser (Life Technologies, UK). The formamide:Rox-500 ratio used was 16:0.5 per 2 µL of PCR sample. The electrophoresis parameters used for all the samples is described in Table 4.4.

**Table 4.2. Reaction volumes for each component of the AmpFISTR SGMPlus used in each amplification reaction. Multi mix was prepared for  $n + 1$  for  $n$  number of samples where 25  $\mu$ L of the multimix was then aliquoted into each PCR tube.**

Master mix component	Volume in multimix for each sample ( $\mu$ L)
	Direct PCR
Reaction mix	10
Primer set	5
Ampli <i>Taq</i> Gold DNA polymerase	0.75
dH <sub>2</sub> O	10
DNA template	-

**Table 4.3. Amplification protocol using AmpFISTR SGMPlus with 2720 thermal cycler.**

1 cycle	28 cycles			1 cycle
95°C	94°C	59°C	72°C	60°C
11 min	60 sec	60 sec	60 sec	45 min

**Table 4.4. Electrophoresis parameters used to run samples amplified with AmpFISTR SGMPlus.**

Injection time	5 sec
Oven temperature	60°C
Injection Voltage	1.5 kv
Run time	28 min

## **4.2.2 Analysis of body fluids on fabric using direct PCR**

### **4.2.2.1 Sample Collection and preparation**

The fabrics used for this research were white cotton t-shirt, brown cotton trousers, brown nylon stockings and light blue denim as described in Table 4.1. Approximately 1 cm<sup>2</sup> square pieces were cut and UV cross-linked in a cross linker to degrade any DNA that may be present prior to the experiment. The body fluids used in this experiment were blood and semen.

For the semen sample, 10 µL was pipette onto each fabric tested in duplicates. The stain was then air dried overnight in a safety cabinet to avoid contamination.

The blood samples were obtained from volunteers using the finger prick method and spotted onto each fabric in duplicates. These stains were air dried overnight in a safety cabinet to avoid contamination.

Both the semen and blood samples were provided by the volunteers after obtaining ethics approval and gaining consent from all the volunteers concerned. The experiments for blood and semen were conducted on different days to prevent cross contamination between samples.

### **4.2.2.2 Direct PCR and electrophoresis**

For the bloodstained fabrics, three strands of fibres each measuring around 2 mm to 3 mm in length were initially used but was later changed to one strand for reasons described in 4.3.2.2. For the semen stained fabrics, three strands of fibres were used for amplification. The blue and white fibres from the light blue denim fabric were amplified separately to compare the effects of indigo dye on amplification.

Preliminary amplification was carried out using AmpF/STR SGMPlus using the reaction components and protocol described in Table 4.2, Table 4.3, and Table 4.4. Later the SGMPlus kit was substituted with the PowerPlex ESX 16 kit (Promega Corp.) to amplify the blood and semen stained fabrics. The components of the PCR

multi mix are shown in Table 4.5 and the PCR thermal cycler protocol for the 2720 thermal cycler (Applied Biosystems, UK) is shown in Table 4.6. Each batch of amplification reaction was carried out with a negative and positive control. The results were accepted only when the negative controls did not show any peaks.

**Table 4.5. Components of the PowerPlex ESX 16 Multi Mix used for direct PCR of stained fabric.**

<b>Components</b>	<b>Volume per sample (µL)</b>
<b>Master Mix</b>	5
<b>Primer Mix</b>	2.5
<b>Distilled water</b>	17.5

**Table 4.6. Amplification protocol for Powerplex ESX 16 using 2720 thermal cycler.**

<b>1 cycle</b>	<b>30 cycles</b>			<b>1 cycle</b>
96°C	94°C	59°C	72°C	60°C
2 min	30 sec	2 min	90 sec	45 min

Capillary electrophoresis was carried out on a 3130 genetic Analyser (Life Technologies, UK). A mixture of HIDI-Formamide : CC5-600 following a ratio of 15:1 was prepared and 10 µL of this mixture was added to 2 µL of the amplified product in a 96 well plate. Control samples and allelic ladder were run for each set of samples. Parameters (injection time, voltage, run time) were set according to the manufacturer's protocol [213].



### 4.2.3 Data analysis

The electropherograms (EPGs) obtained were analysed using the GeneMapper v3.2.1 software and the peak height data were transferred into Microsoft Excel for further data manipulation. Statistical analysis was carried out using Microsoft Excel and Minitab 16 softwares.

Total peak height (TPH) was calculated by summing all the peak heights for all the alleles in the EPG. Percentage profile ( $\%P$ ) was obtained by dividing the number of observed alleles with the number of expected alleles and multiplying the number obtained with 100. The mean peak height (PH) was obtained by averaging the TPH with the number of loci in the multiplex. The mean PH is a representation of the average peak height of a homozygous peak in a locus.

The nonparametric test Kruskal-Wallis one way analysis of variance was used to analyse some of the data obtained [214]. The Kruskal-Wallis is used to test if the samples originate from the same distribution. It is used to compare more than two samples that are independent and are not related. No assumption is made about the normality of the sample distribution.

To test the effects of inhibition, a regression line was plotted onto a scatter plot. The slope of the regression line, indicated by  $m$  in the equation  $y = mx + c$  in the graphs, depicts the degree of slant of the regression line. A higher  $m$  indicates a steeper slope, and thus a higher effect of inhibition.

### 4.3 Results and discussion

#### 4.3.1 Direct PCR on touched fabric

Out of the four fabrics analysed, only two of the fabrics yielded profiles from both the volunteers. No DNA profiles were obtained from two out of the four fabrics tested. White cotton and light blue denim, failed to give any DNA profiles from both volunteers. The results obtained from the other two fabrics, however, gave EPGs from none to full profiles from both volunteers. The results are tabulated in Table 4.7.

**Table 4.7. TPH and %P obtained from volunteer 1 (VA) and volunteer 2 (VB) for 4 replicates.**

Volunteer	Nylon		Brown cotton	
	TPH	%P	TPH	%P
VA1	4529	100	6428	100
VA2	2586	85	397	20
VA3	1093	55	0	0
VA4	3433	85	4697	100
VB1	18320	95	0	0
VB2	18355	95	1742	71
VB3	8015	100	0	0
VB4	16866	100	259	14

Almost all the profiles obtained from nylon showed a %P of above 85%. High %P was obtained from nylon from both volunteers. The DNA profiles from the brown cotton were observed to give variable results, ranging from full to no profiles from both volunteers. TPH obtained from brown cotton were generally lower than those obtained from nylon. It was interesting to observe that the TPH and %P from

volunteer VB obtained from nylon were much higher than those obtained from volunteer VA but volunteer VA gave better TPH and %P with the brown cotton. It was also observed that the amount of DNA (indicated by TPH) donated by volunteer VA was quite consistent between nylon and brown cotton as opposed to volunteer VB.

Between the two types of fabric that results were obtained, nylon seemed to generate better DNA profiles as per the results in Table 4.7, but the Kruskal-Wallis test carried out on the TPH and %P data indicated that there was no statistical difference in %P for nylon and the brown cotton (p-value = 0.054) but there was a significant difference in TPH between the two fabrics (p-value = 0.015). This means that significantly better peak heights were obtained from nylon than from the brown cotton.

No DNA profiles were obtained from the white cotton and light blue denim. There could be two possibilities on why these two fabrics failed to give DNA profiles. The first possibility is that there was insufficient template DNA deposited on the fabrics by the volunteers. The shedder statuses of the volunteers were not tested in this experiment to mimic real crime scene scenarios where the shedder status of the DNA donor is usually not known. However, Lowe *et al.* and Phipps *et al.* agreed that an individual does not deposit a consistent amount of DNA over time [172, 178]. Even though volunteers VA and VB were observed to have deposited sufficient DNA to obtain full DNA profiles on nylon and cotton trousers, as the experiments were conducted on different days, the volunteers could have been shedding less during the experiments involving the white cotton and denim.

The second possibility on why no DNA profiles were obtained could be due to the presence of inhibitors in the reaction. Both the volunteers could have deposited sufficient DNA but the amplification reaction may have been inhibited by inhibitors, possibly from the fabric itself. Cotton fabrics undergo extensive treatment before it can be used to make garments. Processes such as bleaching, dyeing and mercerisation are carried out on the cotton fabric to improve the softness, durability

and aesthetic properties [215]. Any of the chemicals used in these processes could have been carried over and have an inhibitory effect on PCR. Besides, blue denim is usually dyed using an indigo dye, a common known inhibitor of PCR [88].

From literature, it is known that nylon can better capture and release DNA [155, 209] which is confirmed by the findings described here. This property of nylon could be the reason why better TPH and %P was observed with nylon compared to the other fabrics. As for the various cotton fibres, other experiments conducted found that the efficiency of retrieving cells from cotton increased as the number of cells deposited increased [216, 217]. They also found that almost no DNA profiles were obtained when very low amount of cells were deposited on cotton fabrics, which they attributed to the nature of the cotton fibre itself [216, 217].

### **4.3.2 Analysis of body fluids on fabrics using direct PCR**

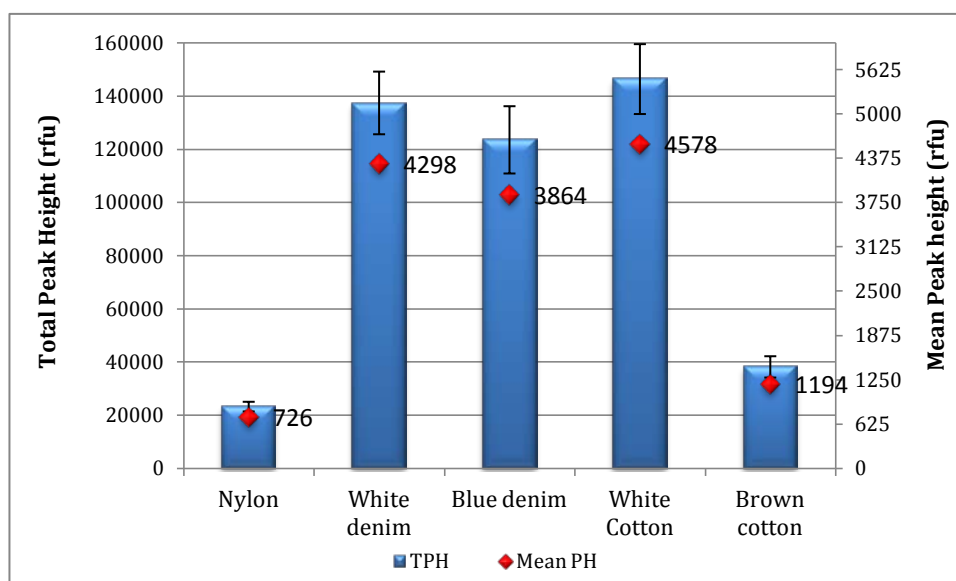
#### **4.3.2.1 Preliminary amplification**

Preliminary amplification using SGMPlus kit resulted in no DNA profiles obtained from all the bloodstained fabric tested. When the amplification kit was substituted with PowerPlex ESX 16, full DNA profiles were obtained from all the bloodstained fabric used. This was attributed to the *AmpliTaq* Gold DNA polymerase that is used with the SGMPlus kit, which is known to be susceptible to haem and other blood components [151, 193, 218]. Haem acts by blocking the active site of the *AmpliTaq* Gold DNA polymerase and affects its processivity (rate of extension) during primer extension [193, 219]. This action of haem is reversible by the addition of certain compounds like Bovine Serum Albumin (BSA) [193]. *AmpliTaq* Gold DNA polymerase is also more susceptible to the  $\text{Ca}^{2+}$  ion, which is present in blood, compared to other metallic ions [218]. Newer kits like the PowerPlex ESX 16 uses improved polymerase-buffer systems which are more tolerant to inhibitors [220] probably due to the addition of compounds such as BSA that reverse or inhibit the action of inhibitors on the polymerase. This makes these new kits more suitable to be used for direct PCR.

#### 4.3.2.2 Blood

At the start of the experiments, three strands of fibres from each fabric were used in the amplification reaction, but this resulted in overloaded EPGs. The EPGs that were obtained had peaks above 8000 rfu with pull-ups and split peaks which made data interpretation impossible. Subsequently, only one strand of bloodstained fibre measuring around 2 mm to 3 mm each was used in each amplification reaction.

The average total peak height and mean peak height from each loci obtained from two replicates for the different types of fibres tested are shown in Figure 4.6.



**Figure 4.6. Bar and line graph showing the total peak heights and mean allele peak height obtained from the five fibres tested TPH: Total peak height; PH: Peak height.**

Nylon was observed to yield the lowest total peak height followed by the brown cotton. The white cotton was observed to give the highest TPH and mean PH followed by both the denim fibres. The DNA profiles of the two replicates obtained from the white cotton was observed to give peaks with the smallest peak recorded at around 2000 rfu and the largest peak at around 9000 rfu. The peaks of the DNA profile obtained from nylon on the other hand was observed to give yield to a

maximum peak height of 1500 rfu and lowest of 300 rfu. No artefacts associated with overloaded EPGs were observed in the DNA profiles obtained from the white cotton.

Both the denim fibres and the white cotton fibre were observed to give the highest peak heights. One of the possible explanations for this could be the physical properties of the fibres tested. Denim is predominantly made up of cotton fibres. The polar groups on the cotton polymer make cotton absorbent and attract water molecules [205]. Blood, which is mainly made up of water, is readily absorbed and saturates the fibres. Nylon, however, is hydrophobic and does not readily absorb water or blood into the fibres. These differences in the ability to store watery solutions leads to the hypothesis that in each 2 mm fibre used for amplification, there would be more blood (and DNA) in the denim and cotton fibres than on nylon, thus better DNA profiles from the denim and white cotton fibres were obtained. Increasing the number of nylon fibres in the amplification reaction may have increased the peak heights of the alleles obtained.

In the presence of haem and other inhibitors, the larger sized amplicons would be more affected compared to the smaller sized amplicons making them more susceptible to decrease in peak heights or drop outs [219, 221]. A slight to moderate inhibition would cause a reduction in peak height or a loss of peaks at the higher molecular weight markers, while a severe inhibition would cause all alleles to drop out [138, 222]. The peak heights of the alleles obtained from bloodstained fabrics were plotted in Figure 4.7 according to the marker dye colour to observe if there was any inhibition in the reaction. The peak heights obtained from the different fibres tested were compared to allele peak heights obtained from positive controls where no inhibition should be present and the amplification efficiency should be at its maximum.

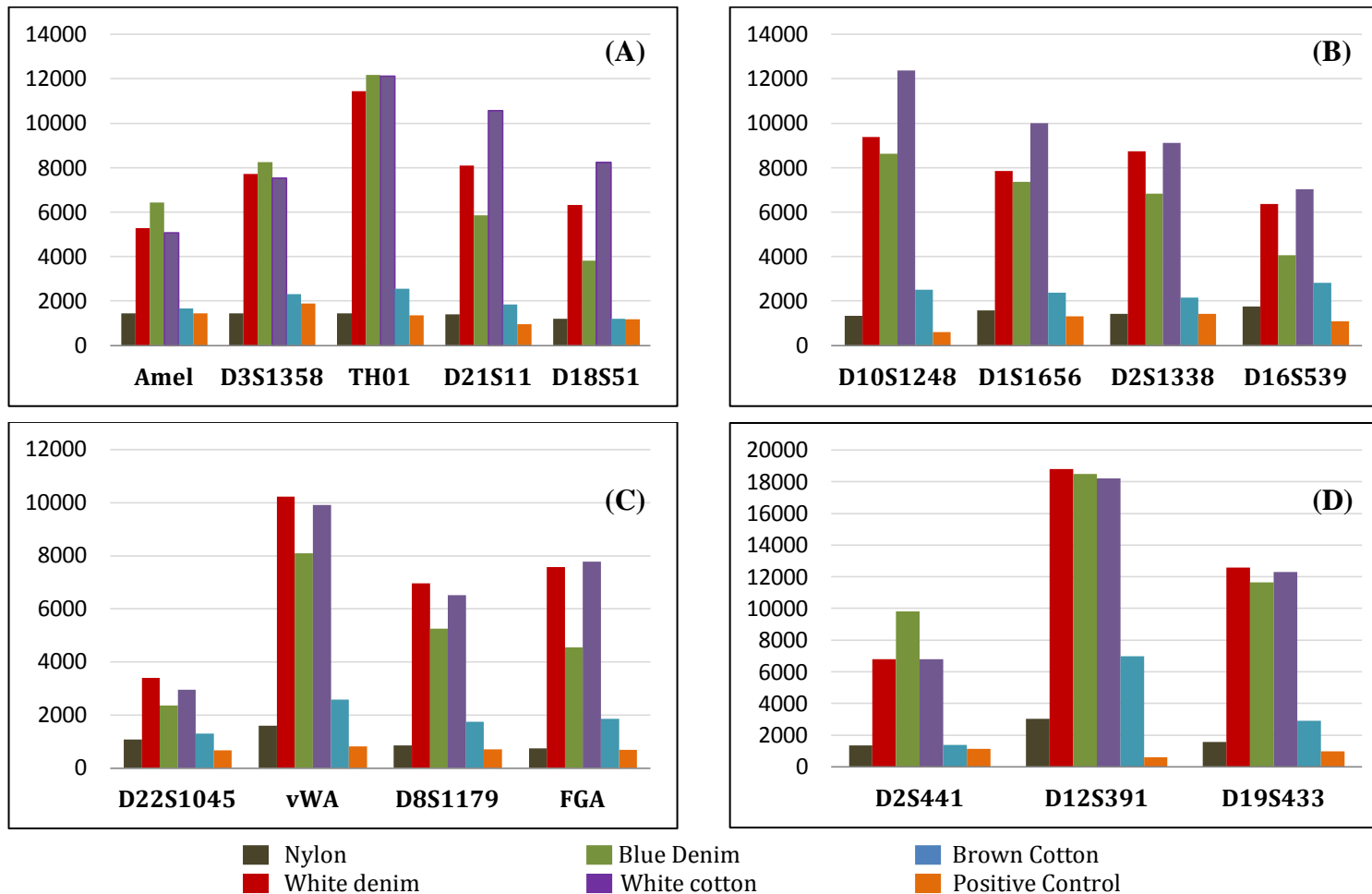


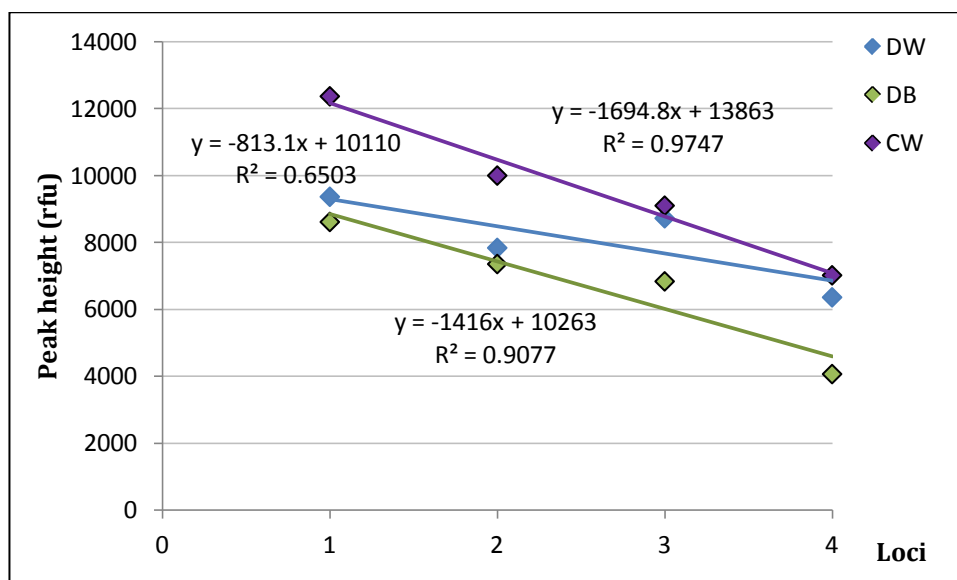
Figure 4.7. Peak heights (rfu) from bloodstained fabric arranged according to marker size and dyes; A: Blue; B: Green; C: Yellow; D: Red.

There was no reduction in peak heights at the larger size amplicons in most of the results obtained. The positive control peaks demonstrated peak heights that were consistent throughout all the loci in all the dye channels, indicating there were no inhibition or decrease in polymerase efficiency. For the bloodstained brown cotton and nylon, the peak heights obtained between the smallest size amplicons and the largest size amplicons in almost all the dye channels were similar indicating that there was no inhibition present in the amplification reactions.

As for the white cotton and the blue and white denim fibres, there was no decrease in peak heights at the blue, yellow and red channels. A sudden increase in peak heights at some loci was observed, for example at TH01, vWA and D12S391, which indicates increase in amplification efficiency at these loci. It was also observed that two loci, D22S1045 and D2S441, showed a decrease in peak heights compared to all the other loci in the multiplex. It may be possible that these particular loci are more susceptible to the presence of inhibitors compared to the other loci.

The peak heights at the green channel were observed to decrease for the white cotton, and blue and white denim fibres as the marker size increased, probably indicating there might be minor inhibition to the reaction affecting these loci. The peak heights for both the denim fibres and white cotton were plotted in a scatter plot and a regression line was fitted into the data as shown in Figure 4.8. Based on the results in Figure 4.8, the white cotton fibre and the blue denim fibre were observed to have similarly high gradient of the regression line, followed by the white denim fibre, indicating the possibility of an inhibitory substance in the amplification reaction. It was interesting to note that the three fibres demonstrating the highest peak heights were also the fibres that demonstrated minor inhibition.

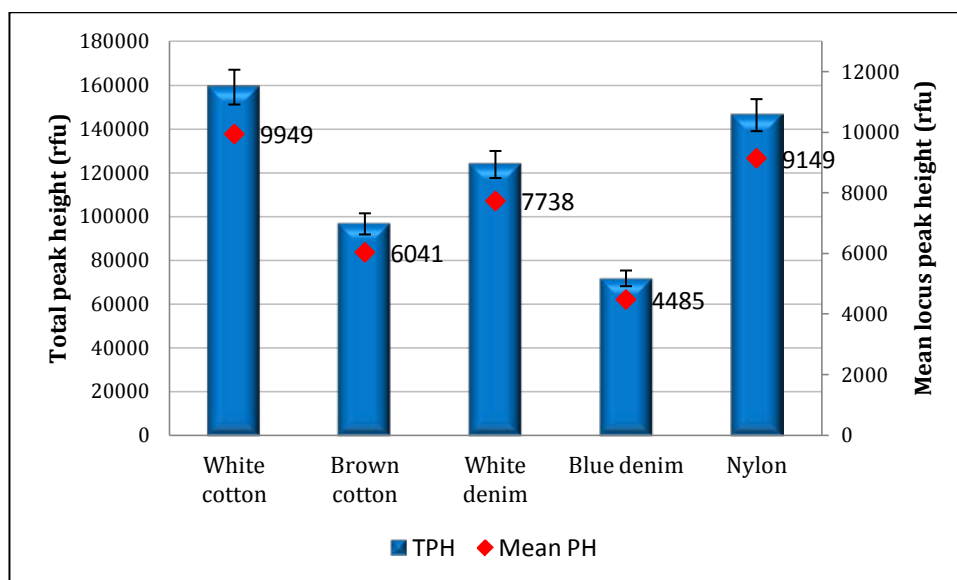




**Figure 4.8. Regression line indicating a decrease in peak height at the larger molecular weight loci obtained from bloodstained fabrics. 1: D10S1248, 2: D1S1656, 3: D2S1338 and 4: D16S539; DW: White denim, DB: Blue denim, CW: White cotton.**

#### 4.3.2.3 Semen

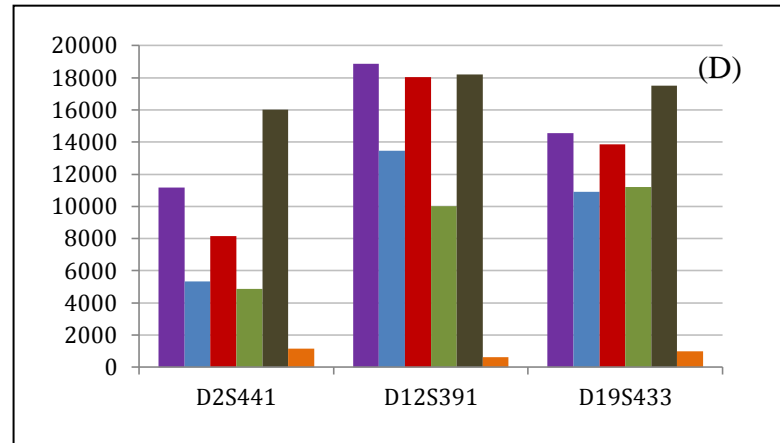
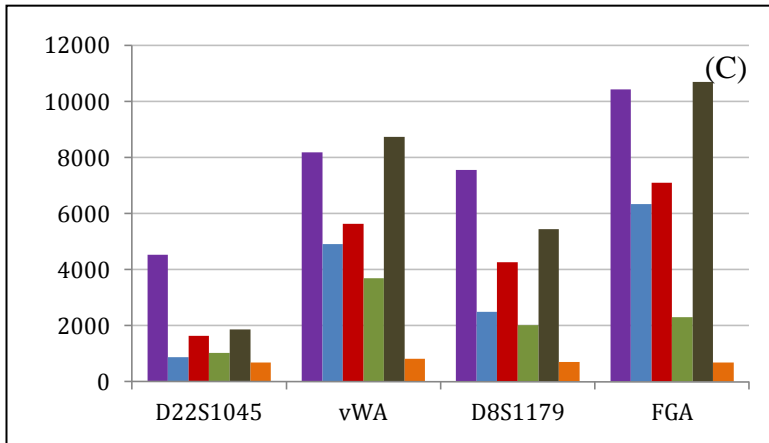
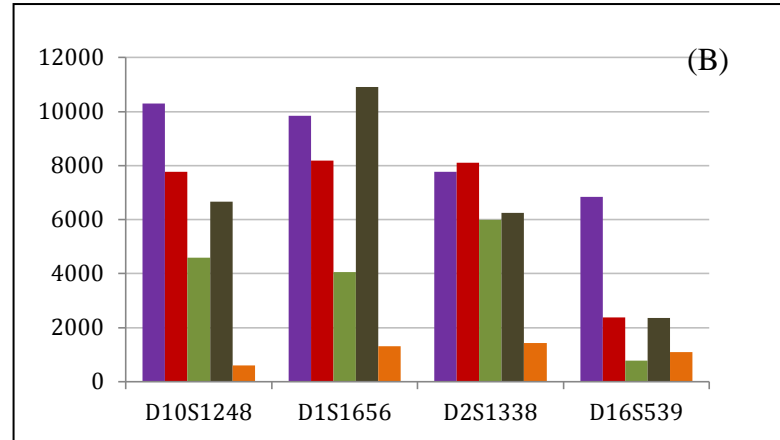
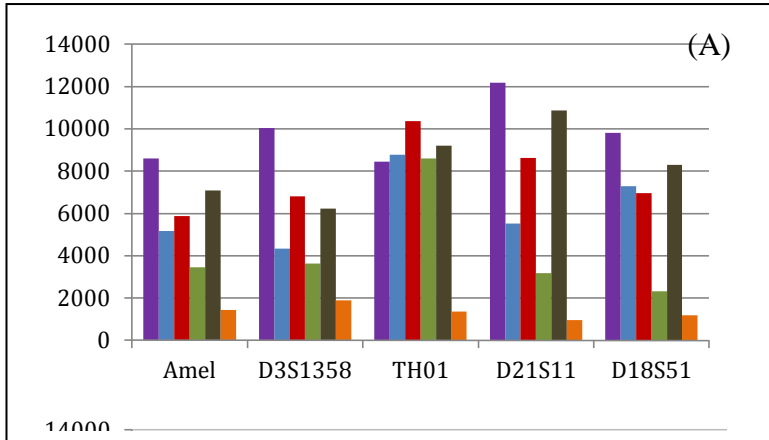
All the semen stains on fabric resulted in full DNA profiles indicating that direct PCR can be used to amplify sperm cells and semen stains on fabric. The average TPH and locus PH obtained from the two replicates for all the different types of fibres tested are shown in Figure 4.9. The results obtained showed that the white cotton fibre gave the highest TPH and PH for analysis of semen stains followed by nylon. Semen stains on blue denim was observed to give the lowest TPH and PH. The maximum peak height observed for semen stains on white cotton was around 18000 rfu while the minimum was around 4500 rfu. For the semen stains on blue denim fibres on the other hand, the maximum peak height observed was around 11000 rfu while the minimum was around 700 rfu.



**Figure 4.9. Average total peak height and average locus peak height obtained from semen stains on five different fibres tested.**

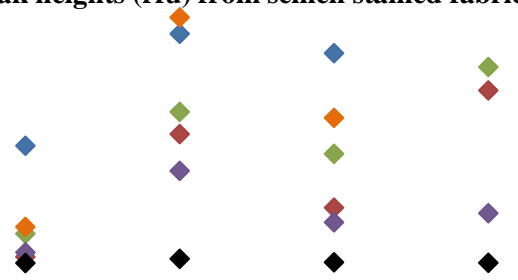
To observe if there was any inhibition to the samples amplified, the data were arranged according to the marker size and colour and plotted in Figure 4.10. The positive control data was also included for comparison. The positive control peak heights were constant at all the loci indicating no reduction in the amplification reaction efficiency. No apparent reductions in peak height at the higher molecular weight markers were observed in the blue, yellow and red dye channels. The green channel indicated peak height decrease at the higher molecular weight markers and a sharp decrease at D16S539. Besides, there was also a sharp decrease in peak height at D22S1045. As all the fabrics recorded this sudden decrease in peak heights at these two loci, it could be attributed to a decrease in PCR efficiency due to the presence of an inhibiting substance. A few loci were observed to have an increase in amplification efficiency, such as TH01, vWA and D12S391, indicated by the sudden increase in peak height at these loci.

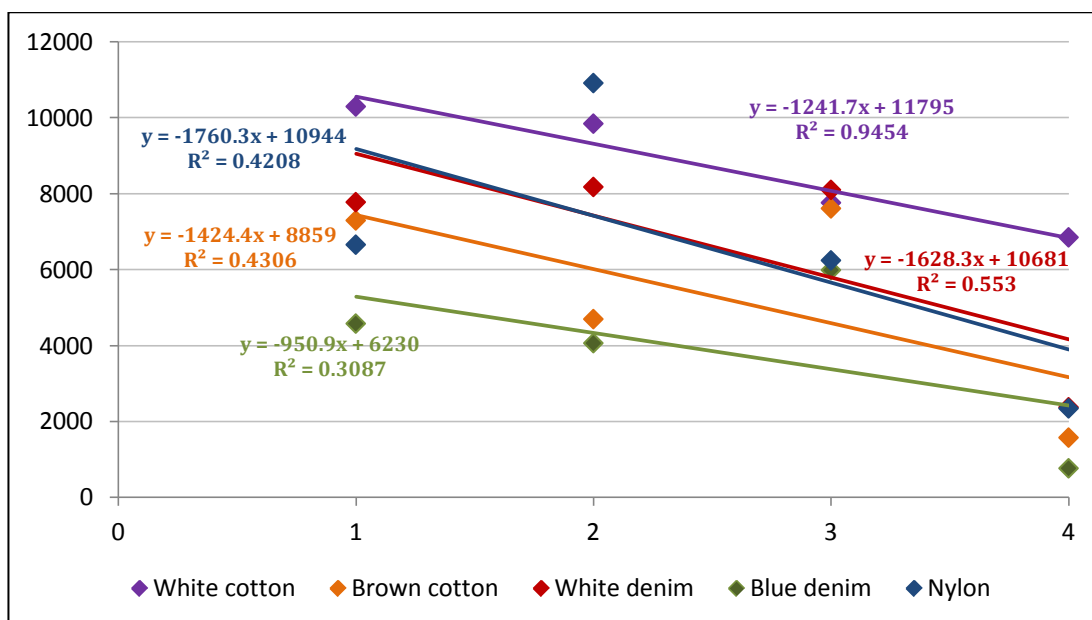
The data obtained from the green channel were re-plotted and a best fit line was obtained. The slope of the best fit line would indicate the degree of inhibition. The graph is shown in Figure 4.11.



■ White Cotton      ■ Denim white      ■ Nylon  
■ Brown Cotton      ■ Denim blue      ■ Positive Control

Figure 4.10. Peak heights (rfu) from semen stained fabric arranged according to marker size and dye. A: Blue; B: green; C: Yellow; D: Red.





**Figure 4.11. Regression line indicating a decrease in peak height at the larger molecular weight loci for peak heights obtained from semen stained fabrics. 1: D10S1248, 2: D1S1656, 3: D2S1338, and 4: D16S539**

Based on the gradient of the regression line in Figure 4.11 it can be surmised that all the fibres tested was observed to have similar gradients of the regression line indicating very minor inhibition to the reaction. The gradient could also be influenced by the presence of extreme peak heights (either very high or very low) in the green channel.

#### 4.4 Conclusion

In this chapter, direct PCR has been used successfully to amplify touch DNA, blood and semen stains on fabric using commonly used STR multiplexes. The type of fabric may influence the quality of the DNA profile obtained, due to their chemical and physical properties, as previously reported by Seah *et al.* [200]. The un-dyed cotton fabrics were a good source of DNA for the body fluids but not for touch DNA. Nylon on the other hand was a good source for obtaining DNA profiles from touch DNA and semen stains. Overall, the un-dyed cotton fabrics performed better than the dyed cotton fabrics, indicating that the dyes present on the fabrics can act as inhibitors to the amplification reaction.

The two amplification kits used in this experiment also differed in their abilities to generate DNA profiles. The SMPlus kit was validated in 2000 [18] and therefore lack the benefits of improved buffer-polymerase systems utilised in many of the recent kits. This could explain the inability of the SGMPlus kit to amplify DNA in the presence of inhibitors. The PowerPlex ESX 16 kit on the other hand was able to overcome the inhibitors present in blood, semen and fabric dyes to give full DNA profiles from all the fabrics.

## **5 Multiplex development and validation for the use of direct PCR**

### **5.1 Introduction**

This chapter describes the development of a direct PCR multiplex that contains the new ESS loci, overcomes the current limitations of sex determination and reveals information about the presence of inhibitors.

#### **5.1.1 Multiplex PCR**

The first use of multiplex PCR was demonstrated by Chamberlain *et al.* in 1988 by simultaneous amplification of multiple loci in the human dystrophin gene [223]. Since then multiplex PCR has been established as a general technique and is widely used in forensic DNA testing. Multiplex involves amplification of two or more regions of DNA simultaneously [21], by adding more than one primer pair to the reaction mix [224]. Any PCR mixture, including multiplex PCR, will include a set of components and parameters that are critical for the reaction to work optimally. These include primers, dNTPs, MgCl<sub>2</sub>, polymerase, thermal cycling conditions and amount of template DNA [224, 225]. Each of these components and parameters can affect PCR individually or collectively [225]. The various components and their typical optimal concentrations are listed in Chapter 1 Introduction. These values are generally used as a guide to optimise individual multiplex reactions.

Primers are generally required in pairs; the forward primer binds to the 3' end of one strand, and the reverse primer binds to the 3' end of the other strand. There are two considerations when selecting primers; efficiency and specificity [226]. Efficiency is the amount of increase in PCR product at every cycle of amplification. An ideal PCR efficiency of 100% results in a duplication of the target sequence per cycle, this means, an amplification rate of 2 [227]. Primers are specific when they only bind to the specified target, and there is no chance of non-specific PCR product forming. In many cases however, factors that promote one will adversely affect the other [226], therefore, a balance between efficiency and specificity must be achieved. Generally, shorter primers are said to be less specific but may result in more efficient PCR

because primer annealing to the target sequence is facilitated in short sequences, whereas longer primers are more specific but less efficient [225].

All the primers in a multiplex should have less than 5°C difference in their melting temperatures ( $T_m$ ) [225]. The  $T_m$  is the temperature at which half the primers are annealed to the target region [228]. Primers with mis-matched  $T_m$  cause problems because the primers with higher  $T_m$  might mis-prime at lower temperatures, while primers with lower  $T_m$  may not anneal at all at higher temperatures [229]. Primers which have  $T_m$  higher than 50°C will generally be more specific and efficient during amplification than those having  $T_m$  less than 50°C [225]. Primers with high GC content (optimally around 40% to 60%) also increases specificity as these primers will have higher  $T_m$  [225].

Concentration of dNTP can affect the yield, specificity and fidelity of an amplification reaction. If the concentration of the dNTP is too high, the fidelity and specificity of the process will be adversely affected by driving the DNA polymerase to misincorporate at a higher rate [225, 228]. In fact, too high concentrations of dNTP has shown to inhibit the action of *Taq* DNA polymerase [230]. Reducing the concentration of dNTP below 200  $\mu$ M is not recommended when proofreading polymerases are being used. Proofreading polymerases have 3'  $\rightarrow$  5' exonuclease activity that will degrade single stranded DNA molecules such as primers, which increases as dNTP concentration decreases [228].

Magnesium concentration is a critical component in PCR as it can affect primer specificity, primer annealing, DNA polymerase activity and fidelity, DNA denaturation temperatures, primer-dimer formation and efficiency of the reaction [225, 228]. Magnesium ions ( $Mg^{2+}$ ) from magnesium chloride ( $MgCl_2$ ), forms complexes with dNTPs and can also act as a cofactor for polymerases [32]. Excess  $Mg^{2+}$  results in accumulation in non-specific amplification products due to the increase in error rate of the DNA polymerase [225, 228].

PCR employs an *in vitro* DNA replication system that mimics processes found in nature [231]. There are many types of polymerases available on the market depending on the type of activity required. *Taq* DNA polymerases have two catalytic activities; a 5'→3' DNA polymerase activity with a processivity of 50 to 60 nucleotides, and a 5'→3' exonuclease activity [228]. *Taq* DNA polymerase produces an A overhang at the 3' end, which makes the PCR products 1 bp longer. AmpliTaq Gold<sup>®</sup> DNA polymerase is a modified form of *Taq* DNA polymerase which is used in many commercial PCR kits [48, 232]. It has been shown that AmpliTaq Gold<sup>®</sup> is susceptible to common inhibitors found in many crime scene samples [151], and therefore might not be suitable for direct PCR.

Phusion<sup>®</sup> Hot Start II High Fidelity DNA polymerase (referred to as Phusion DNA polymerase from hence forward) by Finnzymes exhibits 5'→3' polymerase activity and a 3'→5' exonuclease 'proofreading' activity which increases the fidelity of the polymerase [228]. The proofreading ability is due to the capacity of the enzyme to differentiate whether or not the nucleotide at the 3'-OH of an extending strand is correctly paired with the template strand [228]. In addition to higher fidelity, the proofreading enzymes are more tolerant to variations in buffer conditions and are more thermostable, making these enzymes easier to optimise in a multiplex PCR [228]. In Phusion DNA polymerase, a double-stranded DNA domain is fused to a *pyrococcus* like proofreading polymerase [233], enhancing its processivity and hence requiring less enzyme in a reaction [234]. Phusion DNA polymerase also enables shorter denaturation, annealing and extension steps, thus reducing the overall amplification time [231]. The Phusion DNA polymerase uses the Affibody<sup>®</sup>-based activation method, whereby high temperatures are used to activate the enzyme [235]. Affibody<sup>®</sup> is a group of engineered proteins designed to mimic monoclonal antibodies in function but are significantly smaller in size [236, 237], have high melting temperature and reversible and rapid folding [238], which makes these molecules suitable for PCR. It has been reported recently that this polymerase is able to tolerate higher levels of common inhibitors, thus making it suitable for direct PCR [81].



### 5.1.2 The new European Standard Set (ESS) loci

In 2000, an ENFSI report by Gill *et al.* recommended the European Union (EU) countries incorporate 7 core loci as European standards into their DNA profiling system [239]. This was to enable STR loci to be compared between European laboratories [239]. These core STR loci are TH01, vWA, FGA, D21S11, D8S1179, D18S51 and D3S1358 [239]. Many laboratories utilise a multiplex such as AmpF/STR SGMPlus which incorporates the Interpol core STR loci as part of their routine DNA testing [240]. Nevertheless, in an ENFSI/EDNAP guideline published in 2006, Gill *et al.* recommended that new multiplexes with additional core STR loci in the form of miniSTRs were designed to be incorporated into the existing database [240]. This was to enhance the power of discrimination as the existing core loci was insufficient to accommodate the potential number of comparisons that may be made due to an increase in chance for random matches [240]. The new STR loci which were recommended were D10S1248, D22S1045, D14S1434, D12S391 and D1S1656 [240]. Locus D14S1434 was later re-evaluated based on a paper published by Coble *et al.* which indicated that this locus had a relatively low heterozygosity rate and did not follow the Hardy-Weinberg (HW) equilibrium [241]. D14S1434 was then replaced by D2S441 as the ENFSI recommended loci, which had a better power of discrimination [242].

The recommendation by Gill *et al.* [240] was based on the newly signed Prüm Treaty by Belgium, Germany, Spain, France, Luxembourg, Netherlands and Austria in a convention held in Prüm, Germany in 2005 [243]. The Prüm Convention was held to discuss the “*stepping up of cross-border cooperation, particularly in combating terrorism, cross-border crime and illegal migration*” [243]. This was to be achieved by agreeing to mutual exchange of information, among other things, DNA profiles and reference data [243]. If DNA profiles were to be compared between laboratories, a new standard set of markers with higher power of discrimination were needed in order to overcome problems with random matches.

In the course of implementing the new loci, ENFSI and EDNAP groups developed detailed guidelines to follow. Part of the recommendation was that miniSTR loci be adopted to increase both the robustness and sensitivity of the analysis [240]. The sensitivity for the widely used AmpF/STR SGMPlus kit is about 250 pg [244] and with the latest kits like NGM, the sensitivity has increased to 100 pg of DNA [245]. Therefore, any newly developed kit which is able to detect at least 100 pg of pristine DNA would be following the recommendations. Based on these requirements and guidelines, a novel, robust and sensitive multiplex that contains the new ESS markers was developed.

### **5.1.3 Amelogenin Y null**

The amelogenin system is by far the most popular sex identification system as it can be performed together with STR analysis [21]. Amelogenin is a gene that codes for proteins found in tooth enamel [21]. The primers for the part of the amelogenin gene routinely analysed in forensic genetics, which were first described by Sullivan *et al.*, flank a 6 bp deletion within intron 1 of the amelogenin gene on the X homologue [246]. Amplification with these primers result in a 106 bp and a 112 bp product representing the X- and Y- chromosomal locus, respectively [246]. The presence of both the 106 bp and 112 bp peaks indicate a male genotype, while the presence of only the 106 bp peak would indicate a female genotype. In some cases, a deletion or a mutation in the amelogenin gene on the Y chromosome can cause the 112 bp product to be absent, causing the sample to be falsely typed as female [247, 248]. Many names are given for this phenomenon such as ‘deleted amelogenin males’ [249], amelogenin negative males and amelogenin null males [250]. For the purpose of this report, the absence of the 112 bp product of the amelogenin gene will be called amelogenin Y null.

The occurrence of amelogenin Y null has been reported in several populations worldwide. The amelogenin Y null was observed to be highest in the Sri Lankan population at about 8% [247] and about 1.85% in the Indian population [249]. The frequency of amelogenin Y null in Caucasian samples is relatively low at around

0.02% [251], and no incidences of amelogenin Y null has been reported in the Chinese population so far [252]. In almost all cases of reported amelogenin Y null, amplification using Y-chromosomal markers was successful in proving the samples to be of male origin, indicating that either a deletion or a primer binding site mutation in the amelogenin-related region of the Y chromosome was causing the amelogenin Y null phenomenon [251]. Chang *et al.* also reported an absence in the DYS458 locus and Y-specific minisatellite MSY1 locus, both of which are located on the same Y<sub>p</sub>11.2 band as the amelogenin Y locus, in amelogenin Y null males associated with amelogenin Y allele deletion mutation [250].

In cases of amelogenin Y null, the samples can be mis-typed as female unless additional Y-STR testing is done to confirm the sex of the sample. A simultaneous analysis of STR and Y-STR markers in a single multiplex, would act as a fail safe way to correctly type the sex of the sample, even if the sample is amelogenin Y null.

#### **5.1.4 Y chromosome Short tandem repeats**

The Y-chromosomal markers are passed down through paternal lineages without changing (except for mutational events) [21]. The Y chromosome is only found in males and can be used in forensic cases where a male is involved as the perpetrator. The Y chromosome is divided into two portions. The non-recombining region (NRY) is 95% of the total Y chromosome length and was thought to have no X-Y cross over [253]. Skaletsky *et al.* later renamed the NRY as the male specific region (MSY) after finding evidence that there was abundant recombination with the X chromosome in this region [253]. The MSY is flanked on both sides by the pseudo-autosomal regions (PAR), where X-Y crossing over is a normal and frequent event in male meiosis [253]. The MSY is further divided into two distinctive regions; the euchromatic region which is 23 Mb in length and the heterochromatic region which is about 40 Mb in length [253]. The heterochromatic region is an unreported and unsequenced portion of the Y chromosome that is not transcribed and is composed of highly repetitive sequences, which are impossible to sequence with current technology [253]. The euchromatic region contains 156 transcriptional units, half of

which code for proteins [254]. The majority of the Y-STR loci are located on the euchromatic region of the Y chromosome [255]. Figure 5.1 illustrates the general structure of the Y chromosome and the positions of some of the Y-STRs commonly used in forensic casework.

There are currently more than 400 Y-STR markers which are available for potential forensic use [255]. A core set of Y-STR loci were selected in 1997 that continue to serve as ‘minimal haplotype’ loci [256]. The minimal haplotype loci consist of DYS19, DYS389I, DYS389II, DYS390, DYS391, DYS392, DYS393 and DYS385a/b [256, 257]. In 2003, the U.S. Scientific Working Group on DNA Analysis Methods (SWGDM) recommended use of the minimal haplotype loci plus two additional Y-STRs, DYS438 and DYS439 [258]. Most of the commercial Y-STR kits available in the market today enable co-amplification of the minimal haplotype loci and the SWGDAM recommended loci.

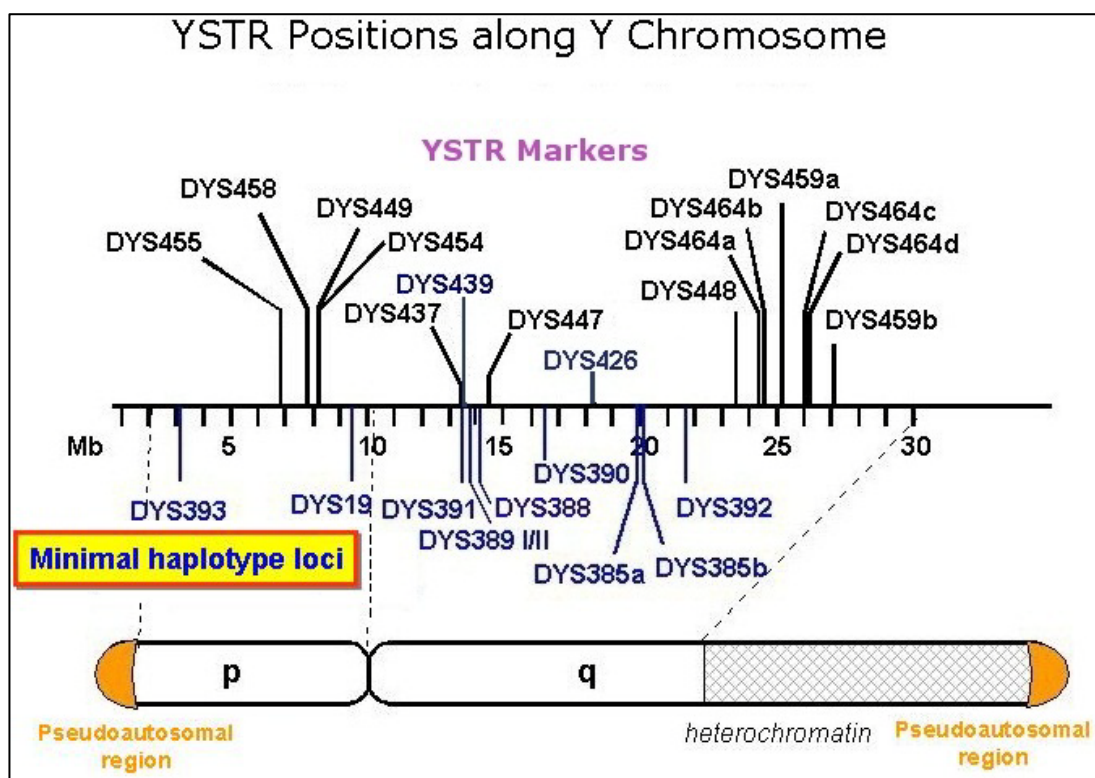


Figure 5.1. The schematic of Y chromosome and positions of Y-STR. Image obtained with permission from [259, 260].

### 5.1.5 Internal PCR Control

PCR is a very sensitive technique that enables the detection of very small quantities of DNA, at the same time is prone to contamination and susceptible to inhibitors. It has been recommended that positive and negative controls be amplified with each batch of amplification [261]. These controls are meant to detect either contamination or failure in PCR efficiency in the batch that is being amplified, but they do not address the issues of inhibition and decrease or failure in PCR efficiency within each sample. In order to differentiate negative results caused by absence of target DNA (true negatives) and inability to amplify due to failure in PCR efficiency (false negatives) internal positive/PCR controls (IPC) have been used widely in clinical samples [262, 263]. Earlier versions of singleplex IPC reactions utilised the same primers as the target DNA to amplify a sequence of control DNA from the same species which have been length modified and inserted into plasmids [262, 263]. Later IPC fragments from modified anthrax DNA were included in a multiplex reaction for the detection of anthrax virus in samples [264]. IPC fragments have been widely used in quantitative Real time PCR to assess degradation of DNA and to detect the presence of PCR inhibitors [265-267]. If direct PCR is to be used, it is essential that the STR amplification kit is incorporated with IPC to distinguish no template profiles from no profiles caused by inhibition. The first incorporation of an IPC into a multiplex PCR for forensic genotyping was reported by Biotype Diagnostics in their kit Mentype<sup>®</sup> Nonaplex<sup>OS</sup> [268] which is no longer available in the market. The IPC, which they called the Quality sensor (QS), was a 72 bp peak labelled with 6FAM [268]. Having a single, small sized peak as an IPC would fail to detect the presence of mild to moderate levels of inhibition, where the larger markers would first be affected [138]. A more recent attempt by Zahra *et al.* made use of the IPC labelled with ROX which was prepared separately and incorporated into the AmpF/STR SGMplus kit [91].

### **5.1.6 Touchdown protocol**

When there are more than one set of primers in the reaction with annealing temperatures more than 5°C from each other, the touchdown protocol can be utilised. Touchdown PCR was first described by Don *et al.* to solve the appearance of spurious alleles due to mispriming [269]. Touchdown PCR uses a temperature cycling protocol that is performed at decreasing annealing temperatures which begins at or above the expected annealing temperature of the primers [269]. This ensures that the primer-template hybridisation involves only those sequences with the highest specificity [225]. The annealing temperature is decreased by 1°C every other cycle to about 55°C for the first 20 cycles [270]. The reaction should then be completed by another 10 to 20 cycles at 55°C annealing temperature to increase the sensitivity and the quantity of the target DNA [270].

### **5.1.7 Multiplex developmental validation**

There is no one set of optimal reaction conditions for any PCR and therefore optimisation is required for every set of primer/template pair chosen [225], which can often be tedious and time consuming. Lack of optimisation can cause problems such as failure to obtain a product, low efficiency in amplification, presence of non-specific products and formation of primer-dimers (product of primer extension on itself or on another primer) which compete with target strands [225, 228]. The aim of optimising a multiplex reaction is to obtain well balanced peaks with each PCR product having similar yields [21]. According to Grunenwald [225], it is particularly important to optimise PCR which would be used for repetitive diagnostics or procedures where optimal amplification is required, such as in the forensic analysis of low template or low quality DNA samples.

The autosomal STR primers to be incorporated into the multiplex were selected based on a few factors. Firstly, published primers that generated amplicons less than 200 bp long were listed. Studies suggest that these mini and midi STR primers are able to amplify degraded DNA samples more successfully compared to normal STR

primers [42, 43]. Secondly, only the ENFSI recommended loci were to be incorporated in the multiplex [240, 271]. Gill *et al.* recommended that new loci are added to the database without compromising the existing STR loci to ensure that the database is able to evolve with current techniques, and recommended a set of new STR loci that recorded high heterozygosity [240]. Finally, the primers for the loci were selected according to compatibility with the other primers to work in a multiplex reaction. For the Y-STR loci, markers which do not have any reported connection to the deletion in the amelogenin gene were listed and two of those listed which fit into the sizing criteria were chosen.

### **5.1.8 Aims and objectives**

A multiplex reaction which is able to simultaneously amplify STR and Y-STR loci, with two Internal PCR control fragments will be developed and optimised for the use with extracted and direct PCR samples. This new multiplex would be suitable to be used as a screening method where it would be possible to obtain minimal information in cases where existing commercial multiplex kits fail to produce DNA profiles due to low DNA quality and quantity. Besides, this new multiplex can also be used to provide additional STR information in cases where commercial kits without the new ESS loci are used in routine DNA analysis.

Five STR loci and two Y-STR loci will be chosen to be included in the multiplex together with two IPC fragments which flank the smallest and the largest loci amplified. The five autosomal STR loci were selected based on the ENFSI/EDNAP recommendations while the two Y-STR loci were chosen to overcome the amelogenin Y null problem. Allelic ladder suitable for this multiplex will also be developed to aid in allele detection using the 3130 genetic analyser. The multiplex sensitivity, Y-STR sensitivity in male-female mixtures and allele concordance testing will be carried out on the multiplex using reference samples obtained from volunteers. Once the multiplex is optimised and validated using control and reference samples, it will be tested with mock crime scene samples to observe the suitability of applying this multiplex in forensic testing. If successful, this multiplex will prove to

be a cheap and useful way to type both STR and Y-STR loci simultaneously and have the ability to indicate if a negative DNA profile is caused by no DNA template or the presence of inhibitors in the sample.



## 5.2 Materials and methods

### 5.2.1 Multiplex development

#### 5.2.1.1 Primer selection

Five autosomal STRs and two Y-chromosomal STRs were selected to be included in the multiplex. The autosomal STRs were selected based on the recommendation by ENFSI/EDNAP while the Y-STR loci were chosen based on their size. The reduced size STR loci chosen were D12S391, D1S1656, D10S1248, D2S441 and D22S1045. The two Y-chromosomal STRs initially chosen were DYS439 and DYS438. Later, DYS438 was omitted and replaced by DYS437. The details of the selected loci are tabulated in Table 5.1. The conservative heterozygosity or haplotype diversity for all the loci reported in the table were obtained from various population studies.

Primers were tested for any complimentary binding (primer dimer formation) using the FastPCR software [272]. All forward primers were synthesised and HPLC purified by Applied Biosystems (Life Technologies) and tagged with fluorescent dyes at the 5' end for detection with the genetic analyser (Life Technologies, NY). The labels 6-FAM (blue), VIC<sup>®</sup> (green), NED<sup>®</sup> (yellow) and PET<sup>®</sup> (red) were used to tag the primers to enable the use of Genescan<sup>®</sup> 500 LIZ as the internal size standard with the G5 dye set. The reverse primers were ordered from Sigma Aldrich. Primer sequence and their corresponding  $T_m$  for the loci selected are tabulated in Table 5.2.

All primers arrived lyophilised and were mixed with DNA storage buffer (1.0 mM pH 8.5) [273] to a concentration of 200  $\mu$ M. Tobe [273] discovered that TE buffer, which stands for Tris-Ethylenediaminetetraacetic acid (EDTA), was inhibiting the PCR reactions which was drastically improved when TE was substituted with water or DNA storage buffer. A few batches of 10  $\mu$ M of 100  $\mu$ L working solution were prepared with sterile dH<sub>2</sub>O for all the primers. The batch being used was stored at 4°C to avoid repeated freeze-thaw cycles. All other batches were stored at -20°C until further use.

**Table 5.1. A list of the autosomal STR and Y-STR loci selected for inclusion in the multiplex and their properties. Heterozygosity is reported for autosomal STR, while haplotype diversity is reported for Y-STR.**

<b>Loci</b>	<b>Chromosome location</b>	<b>Repeat Motif</b>	<b>Expected product size (bp)</b>	<b>Heterozygosity/Haplotype diversity</b>	<b>Power of discrimination</b>	<b>Reference</b>
<b>D12S391</b>	12p13.2	[AGAT] <sub>7-17</sub> [AGAC] <sub>6-10</sub> [AGAT] <sub>0-1</sub>	125-173	0.86-0.91	0.97-0.98	[274-279]
<b>D1S1656</b>	1q42.2	[TAGA] <sub>4</sub> [TGA] <sub>0-1</sub> [TAGA] <sub>6-16</sub> [TAGG] <sub>0-1</sub> [TG] <sub>5</sub>	121-169	0.86-0.91	0.97-0.98	[276, 277, 280, 281]
<b>D10S1248</b>	10q26.3	[GGAA] <sub>8-19</sub>	79-123	0.71-0.82	0.89-0.91	[241, 282-284]
<b>D2S441</b>	2p14	[TCTA] <sub>8-17</sub>	78-114	0.77-0.78	0.89-0.91	[241, 283, 284]
<b>D22S1045</b>	22q12.3	[ATT] <sub>5-17</sub> ACT[ATT] <sub>2</sub>	79-115	0.73-0.74	0.87-0.88	[275, 283-286]
<b>DYS439</b>	Y 13.826 Mb	[GATA] <sub>9-14</sub>	116-136	0.61-0.72	NA	[285, 287-290]
<b>DYS438</b>	Y 14.25 Mb	[TTTTC] <sub>6-14</sub>	133-173	0.62-0.63	NA	[285, 287-289]
<b>DYS437</b>	Y 13.778 Mb	[TCTA] <sub>13-17</sub> [TCTG] <sub>2</sub> [TCTA] <sub>4</sub>	186-198	0.55-0.61	NA	[285, 287-290]

**Table 5.2. Primer sequence for the selected STR and Y-STR loci, the tagged fluorescent dyes and the melting temperatures ( $T_m$ ).**

<b>Loci</b>	<b>Primer Sequence (5'-3')</b>	<b><math>T_m</math> (<math>^{\circ}</math>C)</b>	<b>Reference</b>
<b>D12S391</b>	Forward: <b>VIC</b> <sup>®</sup> -AACAGGATCAATGGATGCAT	64.73	[278]
	Reverse: AGCCTCCATATCACTTGAGC	60.90	
<b>D1S1656</b>	Forward: <b>6FAM</b> -GTGTTGCTCAAGGGTCAACT	61.94	[281]
	Reverse: GAGAAATAGAATCACTAGGGAACC	59.90	
<b>D10S1248</b>	Forward: <b>NED</b> <sup>®</sup> -TTAATGAATTGAACAAATGAGTGAG	60.74	[241]
	Reverse: GCAACTCTGGTTGTATTGTCCTTCAT	64.10	
<b>D2S441</b>	Forward: <b>VIC</b> <sup>®</sup> -CTGTGGCTCATCTATGAAAACCT	63.74	[241]
	Reverse: GAAGTGGCTGTGGTGTTATGAT	62.70	
<b>D22S1045</b>	Forward: <b>6FAM</b> -ATTTTCCCGATGATAGTAGTCT	60.79	[241]
	Reverse: GCGAATGTATGATTGGCAATATTTTT	66.10	
<b>DYS439</b>	Forward: <b>PET</b> <sup>®</sup> -ACATAGGTGGAGACAGATAGATGAT	60.65	[287]
	Reverse: GCCTGGCTTGGAATTCTTTT	64.2	
<b>DYS438</b>	Forward: <b>NED</b> <sup>®</sup> -TGGGGAATAGTTGAACGGTAA	62.88	[287]
	Reverse: GGAGGTTGTGGTGAGTCGAG	64.80	
<b>DYS437</b>	Forward: <b>NED</b> <sup>®</sup> -GACTATGGGCGTGAGTGCAT	60.1	[287]
	Reverse: GAGACCCTGTCATTCACAGATGA	59.6	

### 5.2.1.2 Internal PCR Control

Two Internal PCR Control (IPC) fragments were included in the multiplex for the detection of inhibition or failure in amplification. It was planned for one IPC fragment to be placed before the smallest PCR product (IPCI) and another fragment to be placed after the largest PCR product (IPCII). A random artificial gene was created with the help of FastPCR [272] and was called the IPC gene. The IPC gene was then compared to DNA sequences on the GenBank database using the Standard Nucleotide Basic Local Alignment Search Tool (BLAST) [291] <http://blast.ncbi.nlm.nih.gov>. The IPC gene was ordered from GeneArt® (Life Technologies, NY) and the sequence of the gene can be seen in Appendix 1.

The IPC gene sequence that was submitted was assembled synthetically and was cloned into a pMA-T vector by GeneArt. The plasmid DNA was then purified from the transformed bacteria. The final constructs of the plasmid DNA was verified by sequencing. The details of the vector can be seen in Appendix 2.

The plasmid (containing the IPC gene) was received as a 5 µg lyophilised powder. The plasmid was then dissolved in 50 µL of DNA storage buffer. A stock solution was prepared by diluting the plasmid further with dH<sub>2</sub>O into 100 µL of 1 ng/µL solutions for further use. All stock solutions were stored at 4°C when frequently used and at -20°C for long term storage.

The sequence of the artificially created IPC gene was then uploaded into the FastPCR software [272] to develop potential primer sequences for the gene. A list of potential primer pairs was determined by the software and is shown in Table 5.3. The smallest PCR product theoretically would be 78 bp whilst the largest would be 173 bp (refer Table 5.3). This would make primer pair 1F2\_1\_31-50/1R4\_1\_64-85 which produces a 55 bp product and 1F2\_1\_31-50/1R1\_1\_208-227 which produces a 197 bp product ideal according to the initial plan. However, primer pair 1F1\_1\_1-23/1R4\_1\_64-85 was chosen which produces a 85 bp fragment to avoid masking of the IPC peak by the so-called primer flair peak during electrophoresis. Primer pair

1F1\_1\_1-23/1R2\_1\_192-215 was chosen to enable the use of a second IPC fragment of 215 bp.

The forward primer 1F1\_1\_1-23 was ordered from Applied Biosystems and was tagged with the fluorescent dye PET<sup>®</sup> while reverse primers 1R2\_1\_192-215 and 1R4\_1\_64-85 were ordered from Sigma Aldrich. All the primers arrived lyophilised and were reconstituted in DNA storage buffer to 200  $\mu$ M. A few batches of 10  $\mu$ M working solution were prepared with ddH<sub>2</sub>O and stored in -20°C until use.

**Table 5.3. A list of primer pairs generated using FastPCR based on the artificial IPC gene. The primers highlighted were subsequently used in the multiplex.**

<b>For. PrimerID</b>	<b>Sequence(5'-3')</b>	<b>Tm(°C)</b>	<b>Rev. PrimerID</b>	<b>Sequence(5'-3')</b>	<b>Tm(°C)</b>	<b>Fragment Size(bp)</b>	<b>Topt (°C)</b>
<b>1F1_1_1-23</b>	gtcagttgctgcttaccatgt	58.1	<b>1R1_1_208-227</b>	acgacgtacgatggagacct	57.2	227	62
<b>1F1_1_1-23</b>	gtcagttgctgcttaccatgt	58.1	<b>1R2_1_192-215</b>	ggagacctagtagtatccgagg	57.3	215	62
<b>1F1_1_1-23</b>	gtcagttgctgcttaccatgt	58.1	<b>1R3_1_132-155</b>	cggatggattgatcgacttgcca	58.7	155	63
<b>1F1_1_1-23</b>	gtcagttgctgcttaccatgt	58.1	<b>1R4_1_64-85</b>	ggtacgacgtagcttgcatcga	58.8	85	62
<b>1F1_1_1-23</b>	gtcagttgctgcttaccatgt	58.1	<b>1R5_1_32-52</b>	ttcaggcatcgttcgttggga	58.6	52	62
<b>1F2_1_31-50</b>	atccaacgaacgatgcctcg	57.8	<b>1R1_1_208-227</b>	acgacgtacgatggagacct	57.2	197	62
<b>1F2_1_31-50</b>	atccaacgaacgatgcctcg	57.8	<b>1R3_1_132-155</b>	cggatggattgatcgacttgcca	58.7	125	62
<b>1F2_1_31-50</b>	atccaacgaacgatgcctcg	57.8	<b>1R4_1_64-85</b>	ggtacgacgtagcttgcatcga	58.8	55	61
<b>1F3_1_61-81</b>	cgatcgatgcaagctacgtcg	58.3	<b>1R2_1_192-215</b>	ggagacctagtagtatccgagg	57.3	155	62
<b>1F3_1_61-81</b>	cgatcgatgcaagctacgtcg	58.3	<b>1R3_1_132-155</b>	cggatggattgatcgacttgcca	58.7	95	62
<b>1F4_1_127-150</b>	cgatgtggacaagtcgatcaatcc	57.9	<b>1R1_1_208-227</b>	acgacgtacgatggagacct	57.2	101	61
<b>1F4_1_127-150</b>	cgatgtggacaagtcgatcaatcc	57.9	<b>1R2_1_192-215</b>	ggagacctagtagtatccgagg	57.3	89	61

### 5.2.1.3 Testing of Primers and IPC gene

All amplification reactions were carried out in a sterile hood using sterile pipettes and filtered tips. This was ensured by the positive airflow created by the hood which would prevent any contamination from entering the hood during PCR setup. The pipettes were regularly sterilised by cross-linking in a UV cross-linker (UVP, LLC, CA) for approximately 30 min each time. The hood was sterilised using UV light after each use for approximately 30 min to ensure that any DNA present will be destroyed. Only nuclease free water (Promega corp., WI) were used for the PCR setup. A negative control was analysed with each batch of amplification to ensure that all equipments and reagents used were contaminant free. If the negative control was found to be contaminated, that batch of amplification was repeated. If contamination was still present, all reagents were discarded, the equipments were cleaned with Trigene (Medichem Int., UK) and if possible cross-linked in the cross-linker, and the entire PCR area was thoroughly wiped down with Trigene. New reagents and dilutions were then prepared.

PCRs were performed using Phusion<sup>®</sup> Hot Start II High Fidelity DNA Polymerase (Finnzymes, Finland) system, obtained from Thermo Fisher Scientific (Madison, US). The polymerase was used with its complimentary buffer, the 5x Phusion HF buffer (7.5 mM MgCl<sub>2</sub>). The polymerase package also came with DMSO and 50 mM MgCl<sub>2</sub>. Reactions were performed with the concentrations recommended by the manufacturer. All reactions were performed in a total reaction volume of 20 µL. Initial reaction conditions for the testing of primers can be seen in Table 5.4. All primer sets were first amplified individually following the singleplex protocol in Table 5.4. For the IPC, the IPC gene acted as the DNA template for the reaction. Amplification was carried out on the Veriti<sup>®</sup> thermal Cyclor using the 96-well, 0.1 ml Veriflex<sup>™</sup> Block format (Life Technologies). The thermal cycling protocol used for the initial reactions is shown in Table 5.5.

**Table 5.4. Initial PCR mixtures for singleplex reactions ( $\mu\text{L}$ ).**

	<b>Singleplex</b>	<b>IPC</b>
<b>Buffer (5x)</b>	4	4
<b>dNTPs (10 mM)</b>	0.4	0.4
<b>Polymerase</b>	0.3	0.3
<b>Forward Primer (10 <math>\mu\text{M}</math>)</b>	0.5	0.5
<b>Reverse Primer (10 <math>\mu\text{M}</math>)</b>	0.5	0.5
<b>Amplification Grade ddH<sub>2</sub>O</b>	13.3	13.3
<b>DNA template (1 ng/<math>\mu\text{L}</math>)</b>	1	-
<b>IPC gene (1ng/ <math>\mu\text{L}</math>)</b>	-	1
<b>Total volume (<math>\mu\text{L}</math>)</b>	<b>20</b>	<b>20</b>

**Table 5.5. PCR protocol used for the initial singleplex reactions. The protocol of 28 cycles was used for all reactions.**

<b>Initial denaturation</b>	<b>Denaturation</b>	<b>Annealing</b>	<b>Extension</b>	<b>Final Extension</b>
98°C	98°C	62°C	72°C	72°C
1 min	10 sec	20 sec	20 sec	5 min

The protocol used was classified as a fast protocol as the amplification only took 45 min to be completed. A standard annealing temperature of 62°C was used for testing all the primers. The IPC fragments were amplified separately at first to test the primers individually. Subsequently, 0.25  $\mu\text{M}$  of the forward primer and 0.25  $\mu\text{M}$  each of both the reverse primers were amplified in a same reaction to determine if both the IPC fragments could be amplified using the same forward primer. Then the IPC primers were tested with Intact Human Placental DNA (Cambio) to observe if there are cross reactivity of the primers with human DNA.



## **5.2.2 Multiplex optimisation**

### **5.2.2.1 Initial Multiplex Optimisation**

During the initial multiplex optimisation step, non specific peaks were detected in the blue channel. To test the primers for cross-reactivity, the forward primers tagged with 6FAM were first amplified in singleplex reactions with all the reverse primers in the multiplex, including the IPC reverse primers. Then, 2 male and 2 female DNA samples were amplified with the primer pair to observe if there was a sex specific nature for the non-specific peaks. The cross reacting primers were omitted and the multiplex was tested again. The primers were re-evaluated and the DYS438 primer pair was replaced.

### **5.2.2.2 Primer concentration optimisation**

Following the successful amplification of the individual primer pairs, all primers except IPC primers and gene were then multiplexed together into one reaction. This was done by adding 0.2  $\mu\text{M}$  of all primers into the reaction and then increasing or decreasing the primer concentration according to the peak heights of the alleles obtained. The DNA amount used throughout the optimisation was set at 1  $\text{ng}/\mu\text{L}$  so the peak heights obtained when the primer concentrations were adjusted could be compared. Firstly, the IPC fragments were optimised. This was achieved by altering the IPC gene concentration gradually whilst keeping the forward primer, IPCI and IPCII reverse primer concentrations constant. Then the reverse primer concentration of IPCI was reduced while at the same time increasing the IPCII reverse primer concentration until a balanced peak height was obtained.

The primer concentrations for the STR and Y-STR loci were adjusted starting from 0.2  $\mu\text{M}$ . As the concentration of the primers was increased, another artefact was observed in D22S1045 which will be discussed further in Results and discussion. New D22S1045 forward and reverse primers with the same sequence were re-ordered and substituted with the old primers in the multiplex. Next  $\text{MgCl}_2$ , dNTPs and polymerase were re-titrated. Finally the forward and reverse primer

concentrations for D22S1045 were re-determined by amplifying singleplex reactions. The concentration of the reverse and forward primers were readjusted based on the results obtained (refer Results and discussion). The final concentration of the multiplex components after optimisation can be seen in Table 5.6 below. Primer mix was prepared for 100 reactions and stored at -20°C when not in use. The master mix, composed of buffer, dNTP, MgCl<sub>2</sub>, polymerase, IPC gene and primer mix, was prepared when samples were to be amplified.

**Table 5.6. Concentration of various components in the multiplex after optimisation.**

<b>Multiplex components</b>	<b>Vol/reaction (<math>\mu\text{L}</math>) (40 <math>\mu\text{M}</math> primer concentration)</b>	<b>Vol/reaction (<math>\mu\text{L}</math>) (200 <math>\mu\text{M}</math> primer concentration)</b>	<b>Concentration in multiplex (<math>\mu\text{M}</math>)</b>
5x Phusion buffer	4.00	4.00	1x
25 mM dNTPs	0.16	0.16	200
50 mM $\text{MgCl}_2$	0.60	0.60	1.5 mM
<b>Primers:</b>			
D12S391-F	0.30	0.0600	0.6
D12S391-R	0.20	0.0400	0.4
D1S1656-F	0.50	0.1000	1.0
D1S1656-R	0.40	0.0800	0.8
D10S1248-F	0.40	0.0800	0.8
D10S1248-R	0.30	0.0600	0.6
D2S441-F	0.15	0.0300	0.30
D2S441-R	0.08	0.0160	0.16
D22S1045-F	1.00	0.2000	2.0
D22S1045-R	0.06	0.0120	0.12
DYS439-F	0.19	0.0380	0.38
DYS439-R	0.19	0.0380	0.38
DYS437-F	0.19	0.0380	0.38
DYS437-R	0.19	0.0380	0.38
IPC-F	0.30	0.0600	0.6
IPCII-R	1.00	0.2000	2.0
IPCI-R	0.01	0.0025	0.025
IPC gene (0.1 pg/ $\mu\text{L}$ )	0.03	0.03	0.00015 pg
Template DNA	Up to 8.98	Up to 13.78	-
Phusion polymerase (2 U/ $\mu\text{l}$ )	0.30	0.3	-
dH2O	Up to 8.98	Up to 13.78	-
<b>Total reaction volume</b>	<b>20 <math>\mu\text{L}</math></b>	<b>20 <math>\mu\text{L}</math></b>	<b>-</b>

### **5.2.2.3 Concentration of dNTP and MgCl<sub>2</sub>**

The concentrations of different components of the multiplex like MgCl<sub>2</sub>, and dNTPs were titrated to find the optimum working solution which gave the best peak heights with low base line. Multiplex reactions were prepared with 1.5 mM, 2.0 mM, 2.5 mM, 3.0 mM and 3.5 mM of MgCl<sub>2</sub> while keeping all other concentrations constant. Optimal dNTP concentration was tested by using 0.1 mM, 0.2 mM, 0.3 mM and 0.4 mM in the multiplex reactions.

### **5.2.2.4 Thermal Cycling protocol**

The singleplex reactions were carried out using the PCR protocol in Table 5.5 using the Veriti<sup>®</sup> thermal Cycler. First the multiplex reaction was amplified using standard 3 cycle PCR protocol with annealing temperatures ranging from 57°C to 68°C. When the profile obtained was not as expected (refer Results and discussion), a 4 stage touchdown PCR protocol was created that covered the range of temperatures optimum for primer annealing. The final protocol optimised for this multiplex reaction can be seen in Table 5.11 in the Results and discussion.

### **5.2.2.5 Allelic ladder development**

The STR markers included in this multiplex are D12S391, D1S1656, D10S1248, and D2S441, and the Y-STR markers are DYS439 and DYS437. The template for the development of allelic ladder markers was obtained by amplifying the allelic ladder of the PowerPlex ESI kit (Promega Corp.) for the STR markers and the PowerPlex Y kit (Promega Corp.) for the Y-STR markers.

The allelic ladders from both the kits were first diluted to 1 in 1,000, and 1 µL was used as template, as recommended by Butler *et al.*[292]. The ladders were then diluted further to 1 in 10,000, 1 in 100,000 and finally 1 in 1,000,000. The ladder dilutions were amplified using singleplex and multiplex reactions to observe if there was a difference in the ladder profile obtained. Once the optimum concentration of ladder template was obtained, 1 µL of the 1 in 1,000,000 STR and Y-STR template

were amplified separately using the multiplex reaction. Ten batches of STR and Y-STR allelic ladder products were amplified and stored at -20°C until further use.

Since all the amplifications using the multiplex reaction amplified both the IPC fragments, these were not amplified separately. One STR and one Y-STR PCR product were then combined during purification using the MinElute PCR Purification kit (Qiagen, UK). In the end, a total of 10 batches of complete allelic ladders were obtained that was subsequently used when samples were subjected to Capillary Electrophoresis (CE).

#### **5.2.2.6 Capillary electrophoresis**

All samples were subjected to CE using the 3130 genetic analyser (Life Technologies). First a matrix standard sample for G5 dye set was run to create a spectral image. The G5 dye set detects LIZ-500 (orange) as the internal size standard and 6FAM (blue), VIC<sup>®</sup> (green), NED<sup>®</sup> (yellow) and PET<sup>®</sup> (red) for sample detection. A HIDI Formamide (Life Technologies) and LIZ600 (Life Technologies) mixture was prepared in a 1.5 ml microcentrifuge tube with a 0.5:12 ratio. Formamide:LIZ mix and samples were dispensed into a 96 well plate (Applied Biosystems) in a volume of 10 µl and 2 µl respectively. The plate was denatured for 3 min and immediately snap cooled for 3 min to ensure that the DNA stays in a single stranded form. All samples were run using performance optimised polymer 7 (POP7) (Life Technologies) as the polymer in a 36 cm array. The run protocol is shown in Table 5.7.

**Table 5.7. Run module used for samples amplified with the multiplex.**

<b>Name</b>	<b>Value</b>
<b>Oven temperature</b>	60 °C
<b>Injection Voltage</b>	1.2 kV
<b>Injection time</b>	16 sec
<b>Run Voltage</b>	15.0 kV
<b>Run time</b>	700 sec

### **5.2.2.7 Panel and bin set creation**

To aid the designation of a peak in a sample, a panel and bin set was created with the GeneMapper 3.1 software (Life Technologies). This was carried out by first amplifying the 10 batches of allelic ladder samples prepared in 5.2.2.5 to run 10 times each on the Genetic Analyser to observe the variation in the runs. The sizes of all the alleles in the multiplex were compiled and the mean ( $\bar{X}$ ), standard deviation ( $\sigma$ ),  $\bar{X} + 3SD$  and  $\bar{X} - 3SD$  values for each allele were calculated using Microsoft<sup>®</sup> Excel (Microsoft Corp.).

### **5.2.3 Multiplex validation**

#### **5.2.3.1 Sample collection**

Buccal swabs from 10 volunteers were extracted using the QIAcube automated samples preparation system (Qiagen, UK) with the QiaAmp DNA Micro kit (Qiagen, UK). Samples were eluted in 100  $\mu$ L of TE buffer. All volunteers were requested to read and sign an ethics and participant information sheet before they agreed to participate. The extracted samples were then quantified using the Investigator Quantiplex kit (Qiagen, UK) to determine the concentration of DNA in the extracts. Based on the quantification results obtained, the samples were diluted to 0.5 ng/ $\mu$ L using dH<sub>2</sub>O. The extracts were stored at -20°C to avoid evaporation and the diluted samples were used for the validation of the multiplex.

#### **5.2.3.2 Sensitivity study**

Optimal DNA amount for the multiplex was tested using 2 male and 2 female samples. Amplification reactions were prepared with 1.0 ng/ $\mu$ L, 0.75 ng/ $\mu$ L, 0.5 ng/ $\mu$ L, 0.25 ng/ $\mu$ L and 0.1 ng/ $\mu$ L of DNA for each sample. The lower limit of the multiplex was evaluated by amplifying 100 pg, 75 pg, 50 pg, 25 pg and 10 pg of DNA. A negative control was amplified with each batch of amplifications. The samples were run on the CE to obtain DNA profiles.

#### **5.2.3.3 Y-STR sensitivity for mixtures**

The ability of the Y-STR loci to detect the male component in the presence of high female DNA was tested. Two sets of female-male mixtures were prepared. The female DNA was fixed at 1 ng while the male DNA amount was reduced from 1.00 ng to 0.75 ng, 0.50 ng, 0.25 ng and 0.10 ng. Samples were then subjected to CE to obtain DNA profiles.

#### **5.2.3.4 Allele Concordance**

The alleles obtained from ten references, two controls and one commercially available DNA sample were amplified using the multiplex, PowerPlex ESX 16 and PowerPlex ESI 16 (Promega Corp.). The control samples used were the control DNA 007 (Applied Biosystems) and 9947A (Promega Corp.) while the commercial DNA used was the Human Placental DNA (Cambio). The multi mix for the multiplex was prepared as in Table 5.6. The multi mix preparation for PowerPlex ESI and ESX kits can be seen in Table 5.8.

**Table 5.8. Multi mix preparation for PowerPlex ESI and SX 16 kits.**

<b>Component</b>	<b>PowerPlex ESI (25 µL)</b>	<b>PowerPlex ESX (25 µL)</b>
<b>Master Mix</b>	5.0	5.0
<b>Primer pair</b>	2.5	2.5
<b>Template DNA (0.5 ng)</b>	1.0	1.0
<b>dH<sub>2</sub>O</b>	16.5	16.5

#### **5.2.3.5 Mock crime scene samples**

Mock crime scene samples were obtained from proficiency testing samples which had been sent to the laboratory and obtained from volunteers. Samples F1 to F12 were obtained from Collaborative Testing Services (CTS) from 2005 to 2008. Samples C1 to C20 were obtained from the German DNA Profiling Group (GEDNAP) blind trial exercise from year 2010 and 2011 while sample C21 was obtained from a volunteer. A brief description of the samples used in this study is shown in Table 5.9.

At first, the FTA samples were prepared by cutting a 1 mm x 1 mm piece and placed directly into 0.2 mL amplification tubes for direct PCR. This did not produce any results (see section 5.3.5 in Results and discussion). Subsequently, the FTA samples were soaked in dH<sub>2</sub>O for 30 min at 56°C prior to amplification. For all the other samples, the same amount was cut and placed in 0.2 mL amplification tubes for direct PCR. All samples were subjected to CE to obtain DNA profiles.



**Table 5.9. Description of mock crime scene samples obtained from two proficiency tests and volunteers.**

Proficiency test	Sample ID	Description
Collaborative Testing Services	F1	Bloodstained FTA Item 1 (CTS 06-575)
	F2	Bloodstained FTA Item 2 (CTS 06-575)
	F3	Bloodstained FTA Item 1 (CTS 06-576)
	F4	Bloodstained FTA Item 2 (CTS 06-576)
	F5	Bloodstained FTA Item 1 (CTS 07-573)
	F6	Bloodstained FTA Item 2 (CTS 07-573)
	F7	Bloodstained FTA Item 1 (CTS 05-575)
	F8	Bloodstained FTA Item 2 (CTS 05-575)
	F9	Bloodstained FTA Item 1 (CTS 07-576)
	F10	Bloodstained FTA Item 2 (CTS 07-576)
	F11	Bloodstained FTA Item 1 (CTS 08-573)
	F12	Bloodstained FTA Item 2 (CTS 08-573)
GEDNAP 40	C1	Bloodstained tissue (Person A)
	C2	Bloodstained swab (Person B)
	C3	Bloodstained tissue (Person C)
	C4	Semen stained tissue (Stain 2)
	C5	Bloodstained tissue (Stain 3)
GEDNAP 41	C6	Bloodstained swab (Person A)
	C7	Bloodstained tissue (Person B)
	C8	Bloodstained swab (Person C)
	C9	Bloodstained tissue (Stain 1)
	C10	Semen stained swab (Stain 2)
GEDNAP 42	C12	Bloodstained tissue (Stain 1)
	C13	Bloodstain cloth (Stain 2)
	C14	Bloodstained dishwasher tablet (Stain 3)
	C15	Unknown stained swab (Stain 5)
GEDNAP 43	C16	Bloodstained denim (Stain 1)

	C18	Blood and semen stained tissue (Stain 4)
	C19	Saliva swab (Stain 5)
CTS	C20	Bloodstained Tartan (Item 3 07-576)
Volunteer	C21	Cigarette butt

### 5.2.3.6 Data analysis

Raw data were analysed with the GeneMapper ID v.3.2.1 software (Life Technologies). In order to genotype the alleles correctly, bins and panels had to be created. This was carried out by obtaining mean ( $\bar{X}$ ) and standard deviation ( $\sigma$ ) of the size of each possible allele for 100 ( $n$ ) runs on the 3130 Genetic analyser using allelic ladders amplified with the multiplex. The run data was exported to Microsoft Excel (Microsoft Corp.) for statistical calculations.  $\bar{X}$  was calculated by the sum of all the size variations in the allele divided by the total number of runs.  $\sigma$  was calculated using the following formula:

$$\sigma = \sqrt{\frac{\sum X - \bar{X}}{n - 1}} \quad \text{Equation 5.1}$$

The maximum and minimum run variation was calculated by taking  $\pm 3\sigma$  from the mean value.

Once the panels and bin sets were created, samples were analysed and genotyped using these panels and bins. The allele detection threshold was set at 50 rfu for all dyes. Information such as peak height, allele designation and allele size were imported to Excel for further manipulation. Statistical tests were carried out using Minitab 16 and SPSS Statistics 19. The alleles were then used to calculate the total peak height (TPH), mean TPH, peak height ratio (PHR), heterozygous balance (Hbx), percentage profile (%P) and stutter ratio.

TPH was calculated by taking the sum of peak heights of all the STR alleles. This did not include the peak heights of the Y-STR alleles and IPC fragments. Mean TPH was obtained by dividing the TPH with the number of STR alleles, which were five for this multiplex. PHR was obtained by dividing the peak height of IPCI with IPCII, regardless of which peak had the higher peak height. The value of less than one indicated that IPCI had lower peak height while a value more than one indicate that IPCII had a lower peak height. A value close to one would indicate similar peak height between the two IPC fragments. Hbx was obtained by dividing the smaller peak height by the larger peak height of a heterozygous peak within the same loci. Hbx is the ratio of balance between two alleles of a heterozygous locus. The resulting value obtained from Hbx is always equal to or less than 1. The reason PHR was used instead of Hbx for the IPC fragments was because the IPC fragments were not part of a heterozygous peak and were in fact two separate peaks amplified with different primers. Stutter is an artefact which is 4 bp less than the actual peak. Stutter ratio was calculated by dividing the peak height of the stutter with the peak height of the actual peak. %P was calculated based on the number of alleles observed compared to the maximum number of alleles expected in a full profile. A 100% profile would indicate that all the expected alleles were observed for that given DNA profile. A homozygous locus with peak height above 150 rfu was counted as two alleles, below 150 rfu, a homozygous locus was counted as a single allele and with possible allele dropout.

## **5.3 Results and discussion**

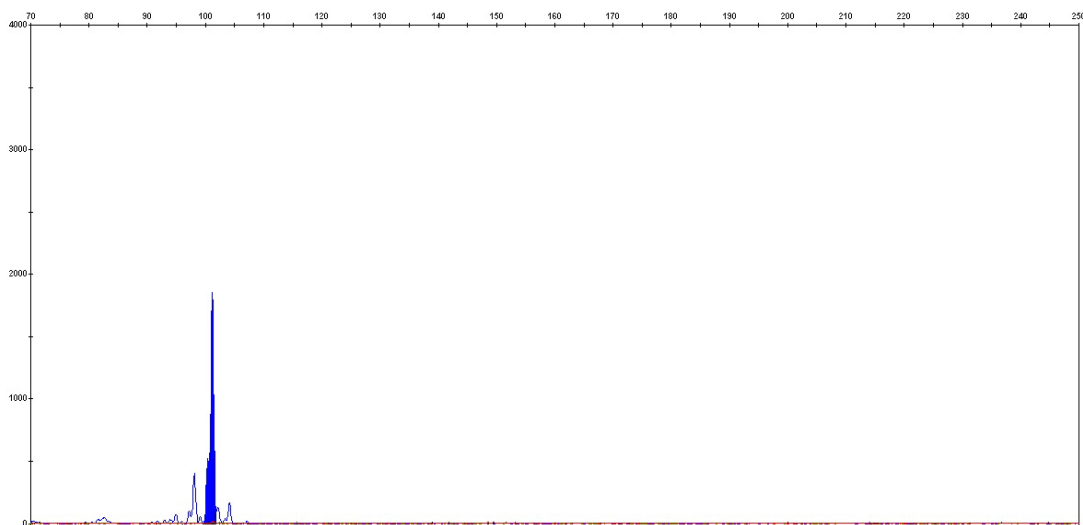
### **5.3.1 Primer selection and testing**

The five autosomal STR loci chosen to be included in the multiplex are D12S391, D1S1656, D10S1248, D2S441 and D22S1045. These loci were chosen because they represent the new ESS loci which were recommended by EDNAP/ENFSI to aid exchange of data within EU countries [240, 242]. Besides, these loci are situated on different chromosomes which ensures independent segregation during meiosis and thus preserves the HW assumption [21]. The autosomal loci chosen here represent loci that have heterozygosity rates of more than 70% which ensures substantial information content [280]. Besides autosomal STRs, two Y chromosomal STR markers instead of amelogenin were also included in the multiplex. DYS439 and DYS437 were eventually chosen for having the right size to be incorporated into the multiplex, and both these loci have no reported connection to the deletion in the amelogenin gene. The occurrences of amelogenin Y negative males due to primer binding site mutation has prompted the exclusion of the amelogenin loci and the inclusion of two Y-STR markers in this multiplex reaction [250].

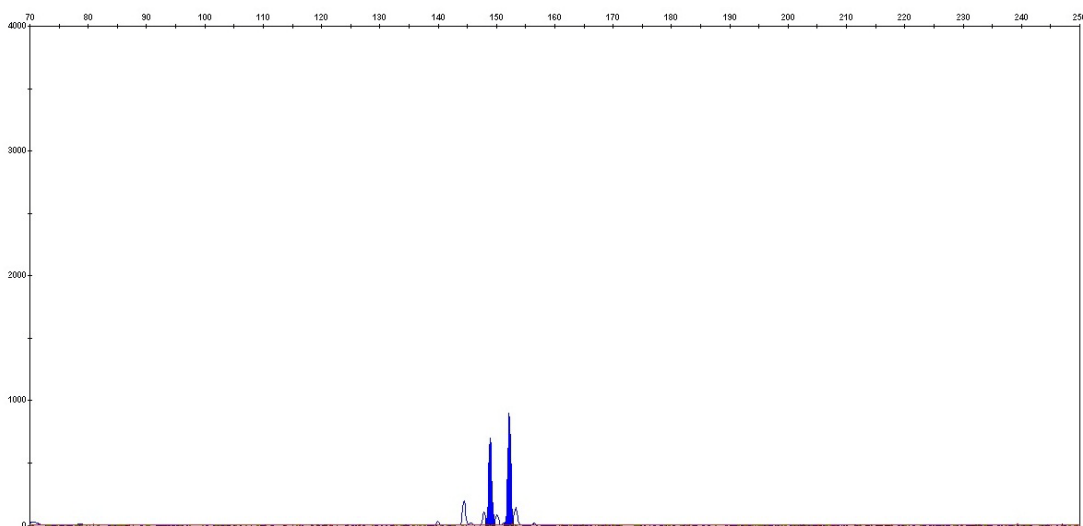
When the primers were tested using FastPCR [272], the interactions between primers were indicated to be minimal and no binding between primers should occur at the primer annealing temperature during PCR. Since the primers have all been previously tested for specificity and cross reactivity, the primer sequences were not compared to the DNA sequences on GenBank.

Initial testing using singleplex reactions were carried out to ensure the primers were working correctly. Results for each primer pair amplified using singleplex reactions can be seen in Figure 5.2 through to Figure 5.11. No cross reactions were observed with IPC primers and human DNA. It was observed that the peak heights obtained varied with each primer pair used, but this was anticipated as the annealing temperature used was not the optimal annealing temperature for most of the primers. Using the optimal annealing temperature at this stage was not essential as this test

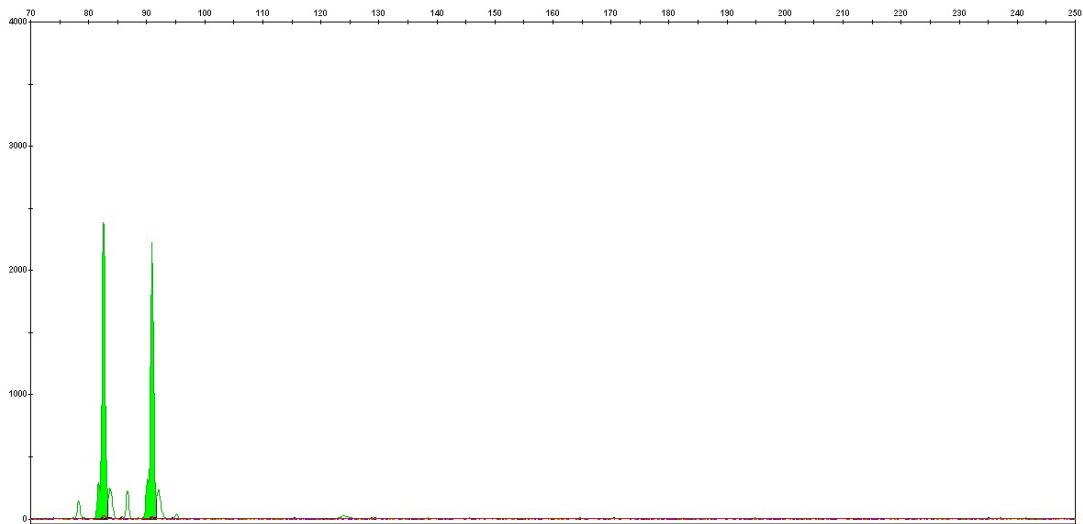
was carried out to observe if the primer pairs used were synthesised correctly when ordered and amplifying only specific products.



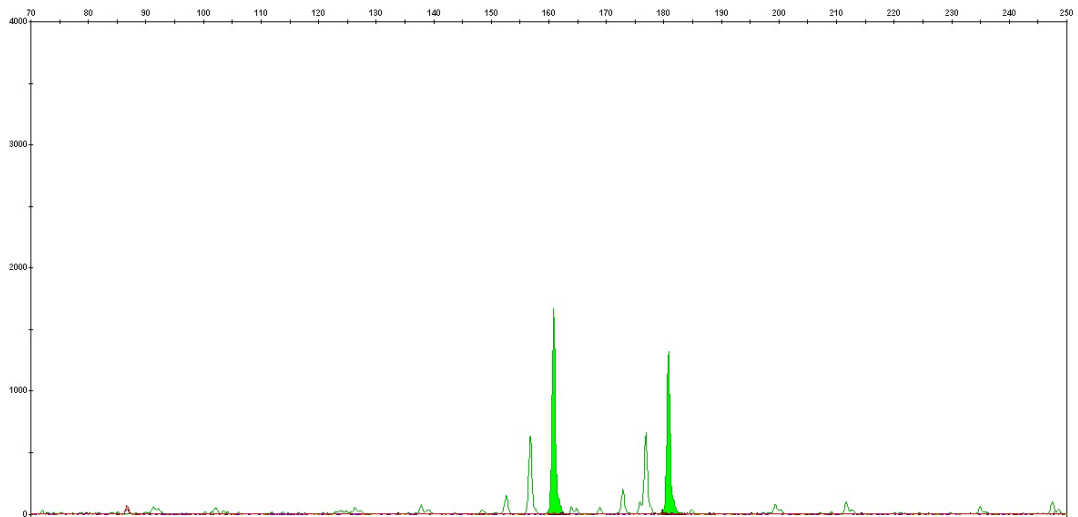
**Figure 5.2. Singleplex amplification using D22S1045 primer pairs tagged with 6FAM. Scale of Y-axis was set at 4000 rfu.**



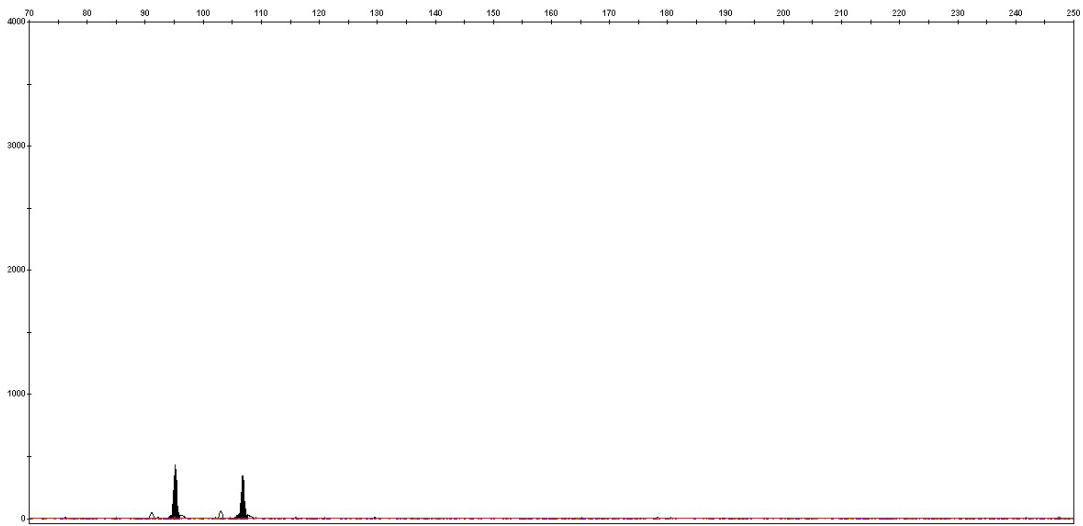
**Figure 5.3. Singleplex amplification using D1S1656 primer pairs tagged with 6FAM. Scale of Y-axis was set at 4000 rfu.**



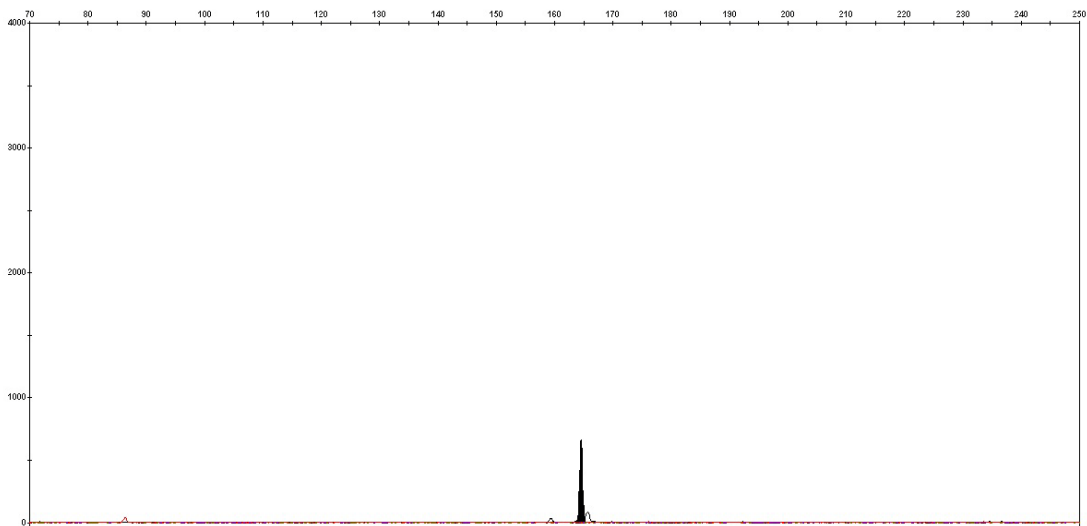
**Figure 5.4. Singleplex amplification using D2S441 primer pairs tagged with VIC®. Scale of Y-axis was set at 4000 rfu.**



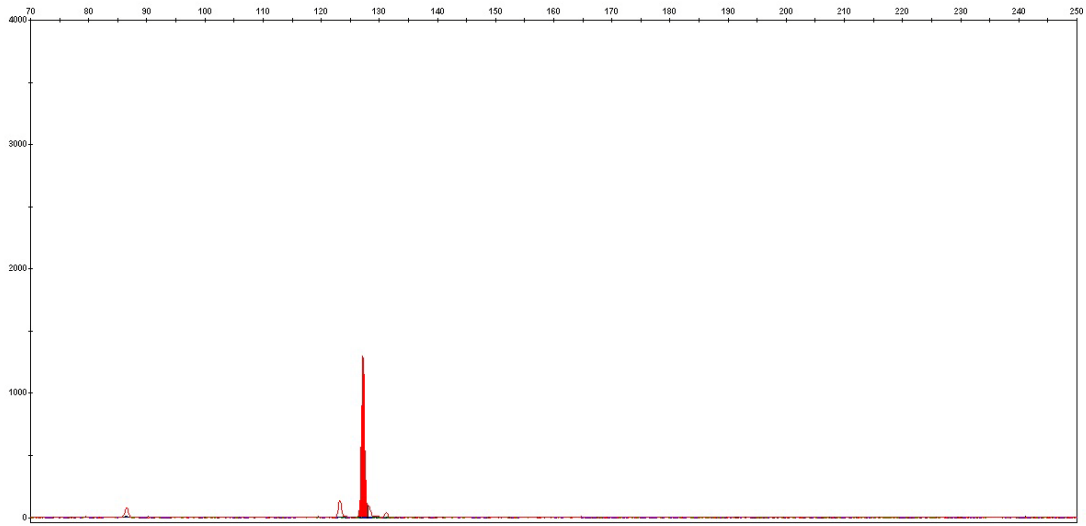
**Figure 5.5. Singleplex amplification using D12S391 primer pairs tagged with VIC®. Scale of Y-axis was set at 4000 rfu.**



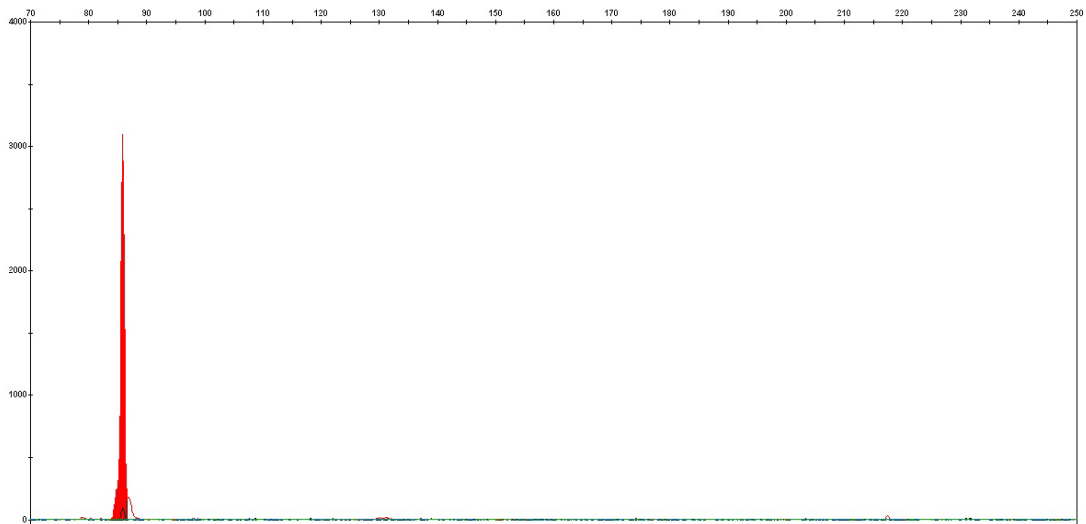
**Figure 5.6. Singleplex amplification using D10S1248 primer pairs tagged with NED<sup>®</sup>. Scale of Y-axis was set at 4000 rfu.**



**Figure 5.7. Singleplex amplification using DYS437 primer pairs tagged with NED<sup>®</sup>. Scale of Y-axis was set at 4000 rfu.**

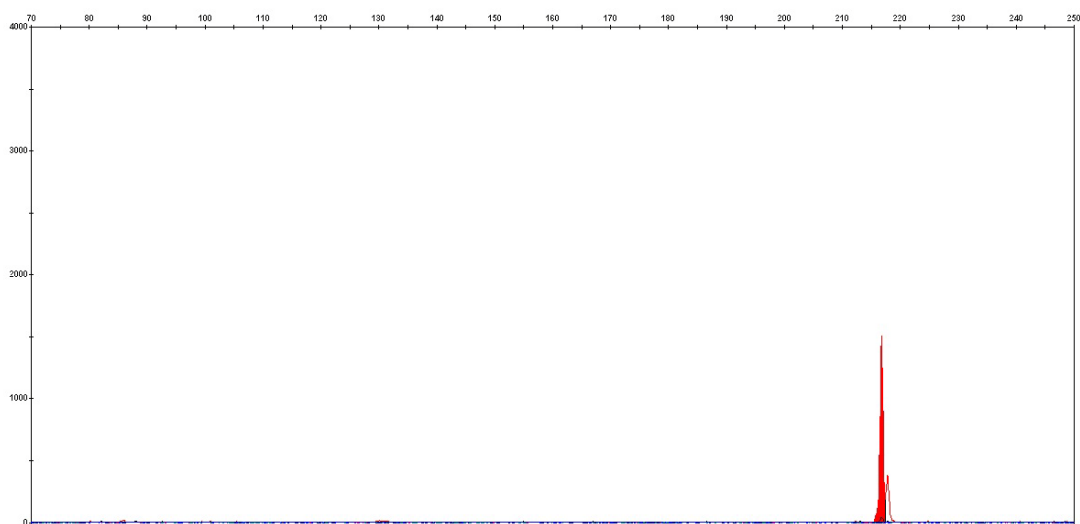


**Figure 5.8. Singleplex amplification using DYS439 primer pairs tagged with PET<sup>®</sup>. Scale of Y-axis was set at 4000 rfu.**

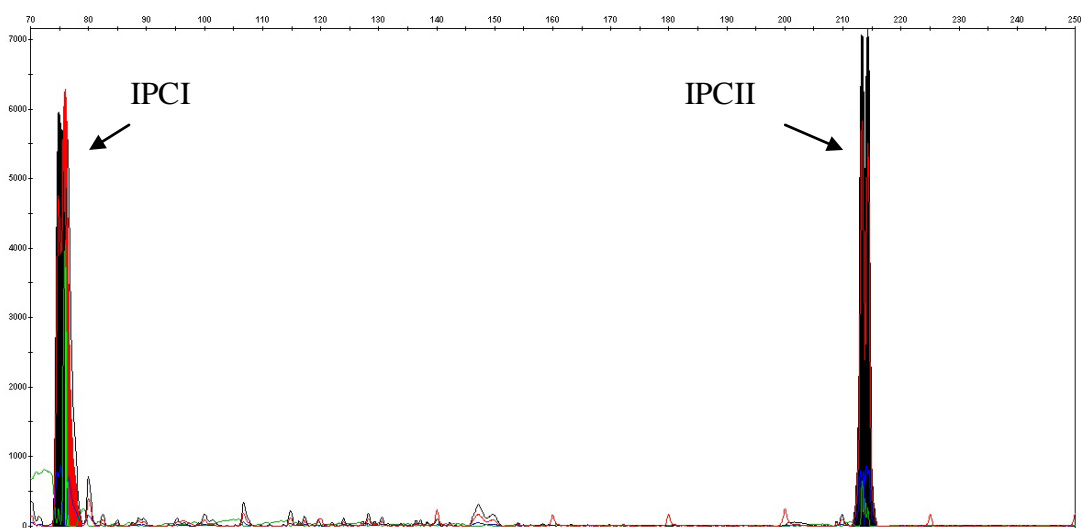


**Figure 5.9. Singleplex amplification using 1F1\_1\_1-23/1R4\_1\_64-85 (IPCI) primer pairs tagged with PET<sup>®</sup>. Scale of Y-axis was set at 4000 rfu**





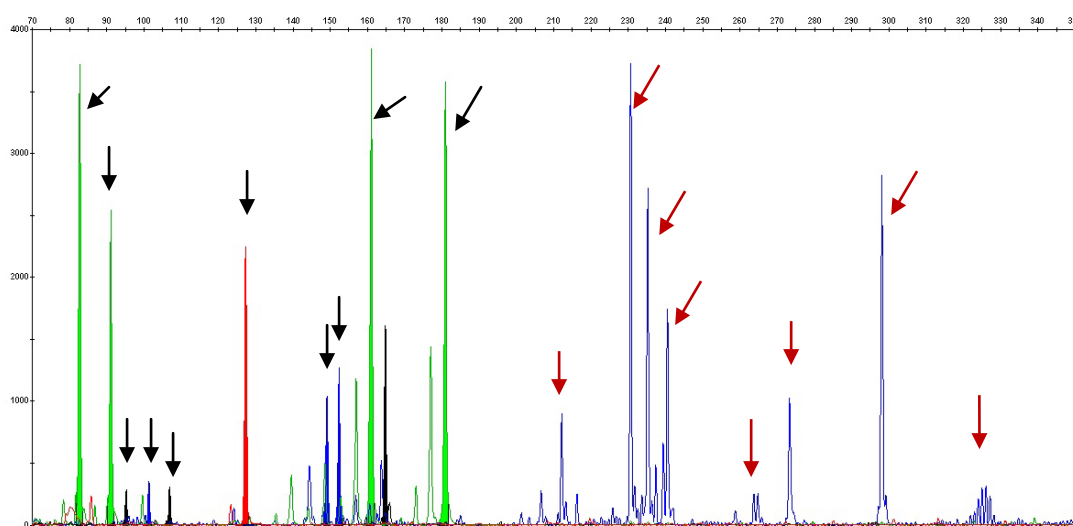
**Figure 5.10. Singlex amplification using 1F1\_1\_1-23/1R2\_1\_192-215 (IPCII) primer pairs tagged with PET<sup>®</sup>. Scale of Y-axis was set at 4000 rfu.**



**Figure 5.11. Amplification of IPCI and IPCII in one reaction using a shared forward primer. Scale of Y-axis was set at 7000 rfu.**

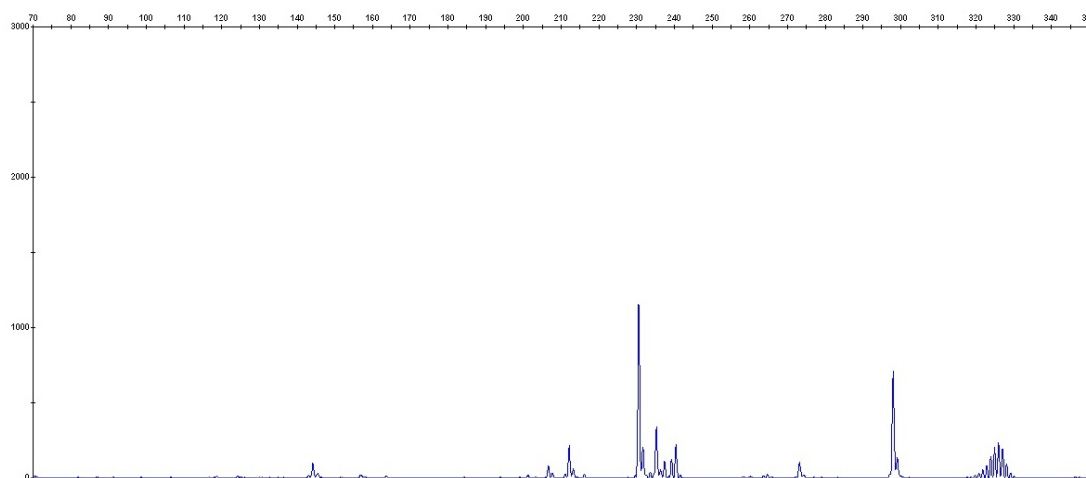
### 5.3.2 Primer cross-reactivity

Singleplex reactions of these primer pairs yielded only specific peaks, but when the primers were combined in the initial optimisation stage, non specific peaks were observed in the blue channel of the DNA profile. The profile obtained from the initial multiplex amplification can be seen in Figure 5.12. There are two possible explanations for this. Firstly, it could be that either the D22S1045 or D1S1656 primers were priming at other target sites and was not specific to their corresponding loci. If this was the case, then non specific peaks would also have been observed when singleplex amplifications were carried out but this was not observed. The second possibility then is that one or both of the forward primers tagged with 6FAM were pairing with one or more of the reverse primers to synthesise non-specific products. The peaks indicated by the black arrows are the expected peaks while those indicated by the red arrows in the 200 bp to 350 bp region are the non-specific peaks observed in the EPG. Some of the non-specific peaks observed had much higher peak heights compared to the expected peaks in the blue channel indicating the possibility that the non-specific peaks were being preferentially amplified.



**Figure 5.12. Electropherogram obtained from initial multiplex amplification indicating expected and non specific peaks due to primer cross-reactivity. Expected peaks are indicated by black arrows while non specific peaks are indicated by red arrows.**

The forward primers of D1S1656 and D22S1045 were amplified with all reverse primers in the multiplex in turn. Since these primer combinations were random and primers are theoretically located on different chromosomes, no PCR products should have been generated. No peaks were observed in any of the reactions except in the D1S1656<sub>forward</sub>-DYS438<sub>reverse</sub> primer combination, shown in Figure 5.13, indicating that these two primers were pairing up to produce non-specific PCR products. This primer combination was then used to amplify 2 male and 2 female samples. The results obtained indicated that the non-specific peaks were only observed in male samples and were not present in the female samples. This was thought to be caused by another priming site situated on the Y chromosome which was complementary to the forward and reverse primers used, and therefore was male specific.



**Figure 5.13. Non-specific peaks observed in the amplification reaction with forward primer of D1S1656 and reverse primer of DYS438.**

The Y-STR primer pair for DYS438 was then omitted and other Y-chromosomal STR primers were evaluated. One of the requirements of the new Y-STR was that the locus had to be within the range of 130 bp to 200 bp so it can be included in the multiplex. A few loci were short listed which fulfilled this requirement, namely YCA IIa/b, DYS388, DYS456, DYS437 and DYS460. From literature, it was determined that DYS437 was the most polymorphic [293], and thus it was decided that this locus should be included in the multiplex instead of DYS438. All the primers were again combined and this time, no non-specific peaks were observed.

### **5.3.3 Multiplex optimisation**

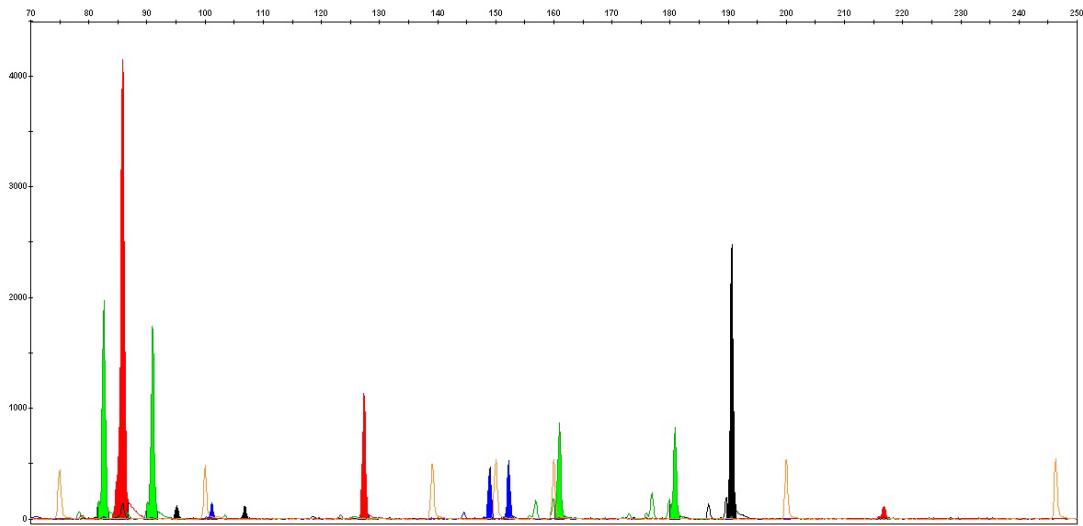
#### **5.3.3.1 Primer concentration**

The multiplex was initiated by adding 0.2  $\mu\text{M}$  of all primers and IPC gene concentration was reduced to 0.001 pg. The resulting profile obtained (Figure 5.14) showed that some of the peaks like IPCI and DYS437 were preferentially amplified while others like IPCII, D22S1045 and D2S1248 almost dropped out. The steps taken to optimise primer concentrations and the resulting profile obtained are explained further in table Table 5.10. The loci in the table have been abbreviated for easier tabulation as follows; D12S391 (D12), D1S1656 (D1), D10S1248 (D10), D2S441 (D2), D22S1045 (D22), DYS438 (438) and DYS437 (437). The corresponding EPGs obtained can be seen from Figure 5.15 to Figure 5.19. The arrows in the EPG indicate the changes in the peaks after altering the primer concentration. The final primer concentration in the multiplex is shown in Table 5.6.

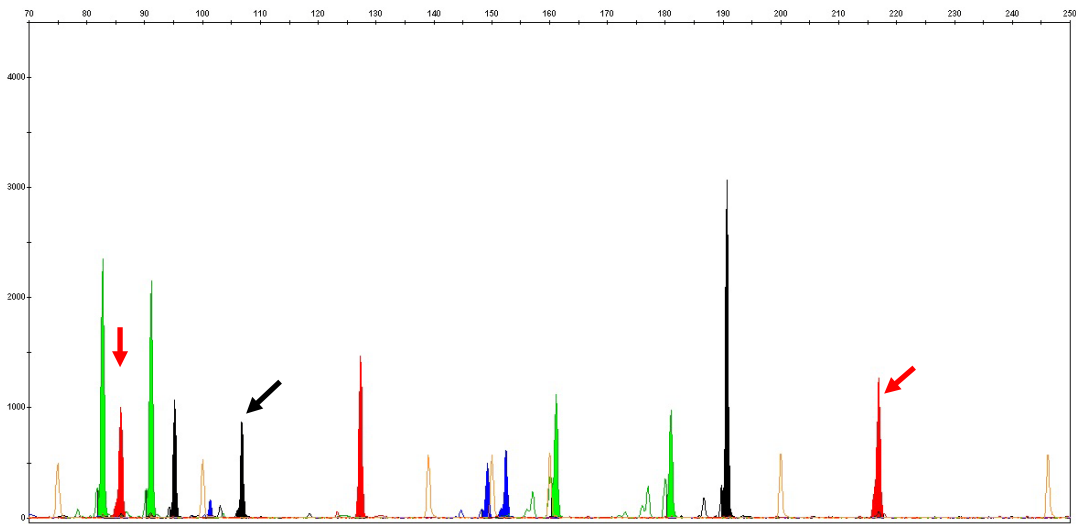
**Table 5.10. Steps taken to optimise the primer concentration in the multiplex, observations and corresponding EPG obtained.**

<b>Primer/IPC gene</b>	<b>Action</b>	<b>Observation</b>
<b>IPCI Rev</b>	↓ Conc. to 0.025 µM	<ul style="list-style-type: none"> <li>• Decrease in IPCI and increase in IPCII peak heights to 1000 rfu</li> <li>• Increase in D10 peak height to 1000 rfu</li> <li>• Refer Figure 5.15</li> </ul>
<b>IPCII Rev</b>	↑ Conc. to 0.60 µM	
<b>D10 For and Rev</b>	↑ Conc. to 0.60 µM	
<b>For and Rev of D12, D1, D2, D22, 439 and 437</b>	↑ Conc. to 0.40 µM for all primers stated	<ul style="list-style-type: none"> <li>• Increase in peak height for D12, D1, D2, D22, 439 and 437</li> <li>• Refer Figure 5.16</li> </ul>
<b>For and Rev D22 and D10</b>	↑ Conc. to 0.80 µM	<ul style="list-style-type: none"> <li>• Increase in peak height for D10 and D1</li> </ul>
<b>For and Rev D1 and D12</b>	↑ Con. To 0.60 µM	<ul style="list-style-type: none"> <li>• Increase in 437 peak height</li> <li>• Decrease in IPCII peak height</li> <li>• Split peak in D22 (refer section)</li> <li>• No change in peak height for D12</li> <li>• Refer Figure 5.17</li> </ul>
<b>D22 For</b>	↑ Conc. to 2.0 µM	<ul style="list-style-type: none"> <li>• Increase in D22 peak height</li> <li>• Reduced peak heights for IPCI and IPCII fragments</li> <li>• Refer Figure 5.18</li> </ul>
<b>D22 Rev</b>	↓ Con. to 0.2 µM	
<b>Rev primers D12, D1, D10, D2 and D22</b>	↓ Conc. by 20-30% of initial conc.	<ul style="list-style-type: none"> <li>• No reduction in peak heights for D12, D1, D10, D2 and D22</li> <li>• Slight increase in peak height of IPC fragments</li> </ul>
<b>IPC gene</b>	↑ Conc. to 0.03 pg	<ul style="list-style-type: none"> <li>• Increase in peaks height of both IPC fragments</li> <li>• Refer final primer concentration table (Table 5.6) and corresponding EPG (Figure 5.19)</li> </ul>
<b>Rev IPCII</b>	↑ Conc. to 2.0 µM	

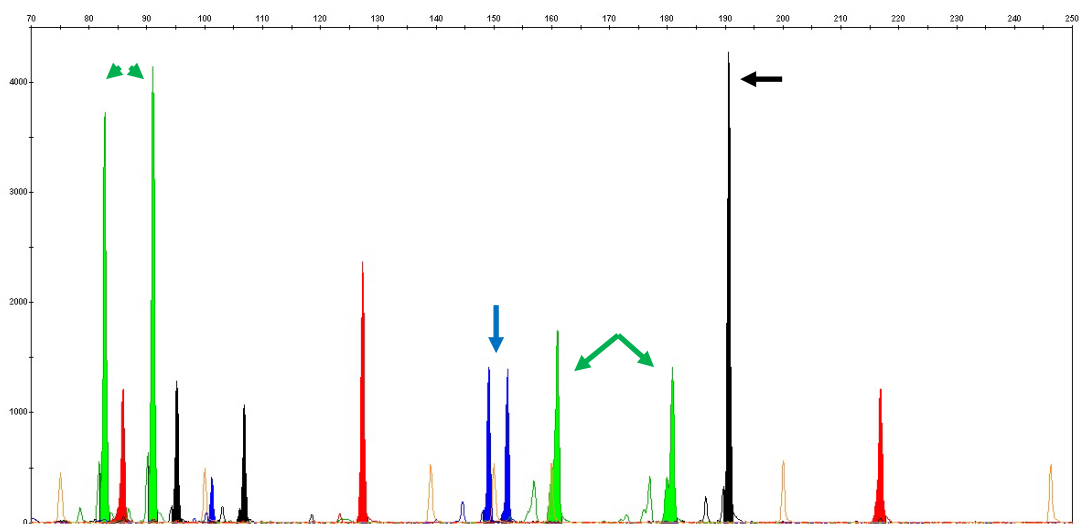
↓ Indicates decrease in concentration  
 ↑ Indicates increase in concentration  
**For:** Abbreviation for Forward primer  
**Rev:** Abbreviation for Reverse Primer  
**Conc.:** Abbreviation for Concentration



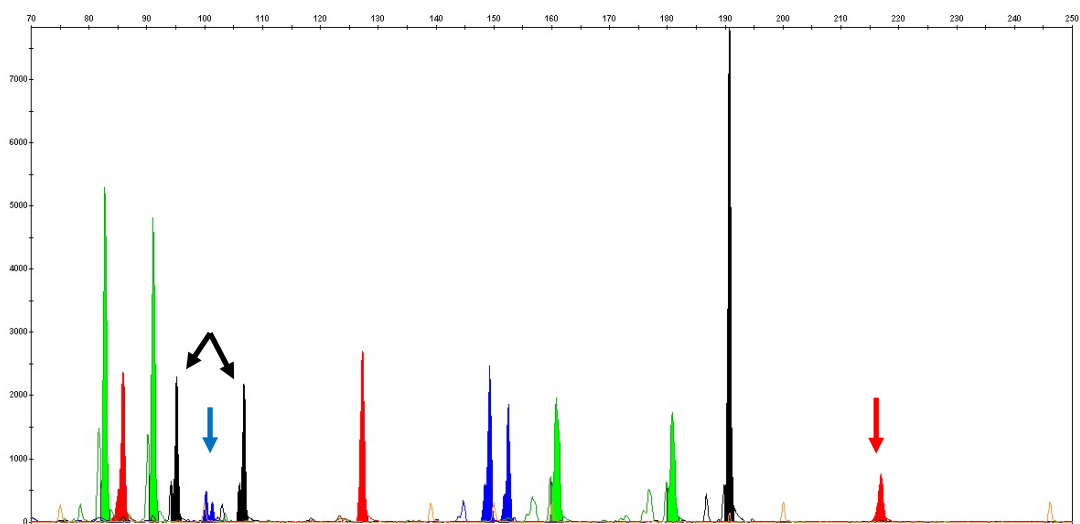
**Figure 5.14. EPG obtained when 0.2  $\mu$ M of all primers were added to the multiplex.**



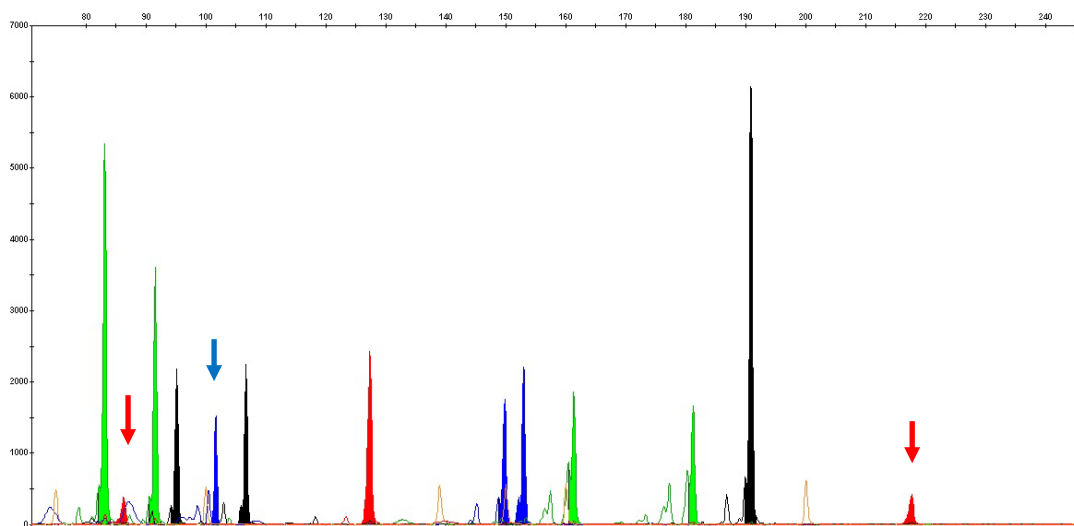
**Figure 5.15. EPG obtained when reverse primer of IPCI was decreased, reverse primer of IPCII was increased and forward and reverse primers of D10 was increased.**



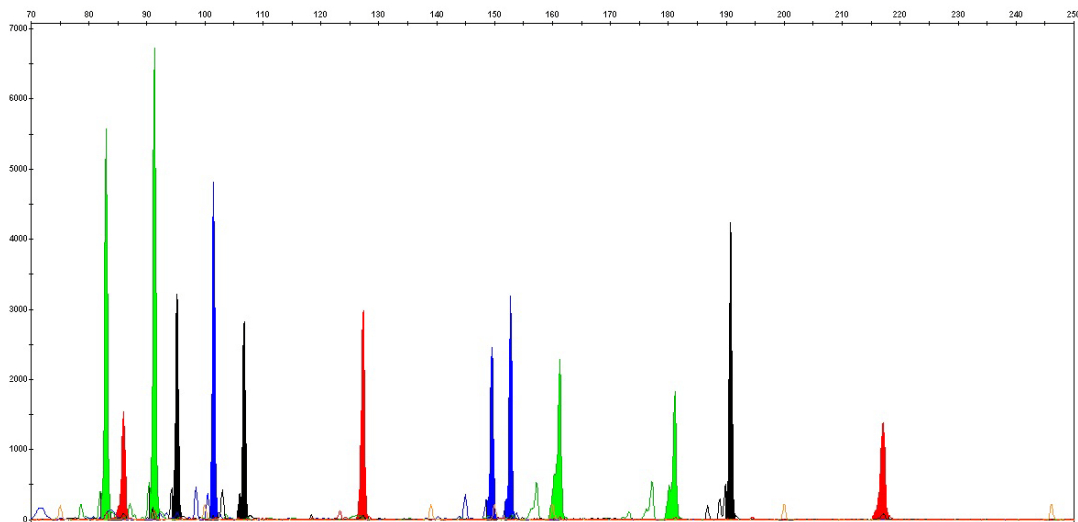
**Figure 5.16. EPG obtained when forward and reverse primers of D1, D12, D2 and D22 were increased.**



**Figure 5.17. EPG obtained when forward and reverse primers of D22, D1, D10 and D12 were increased.**



**Figure 5.18. EPG obtained when D22 primers were altered.**



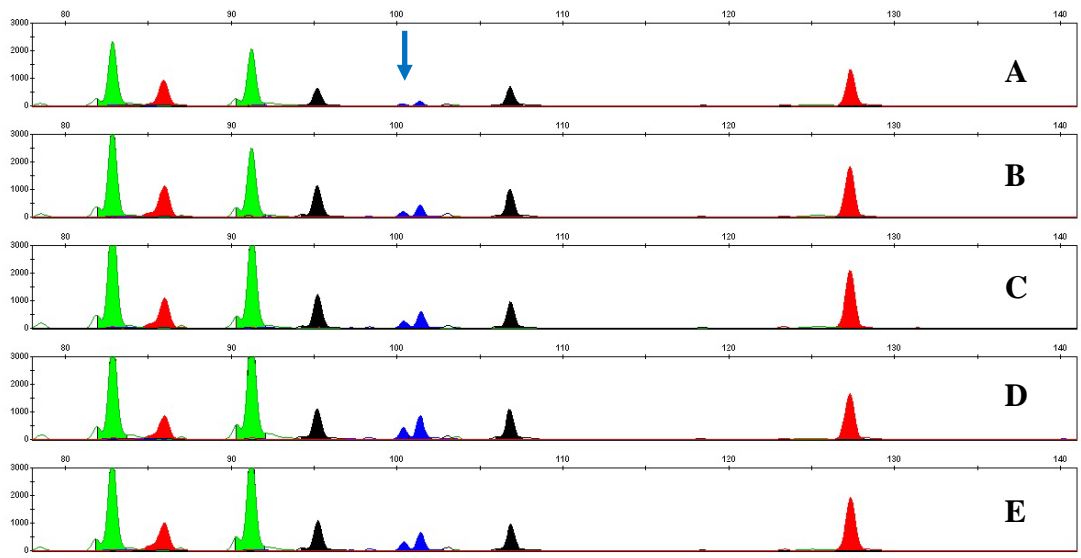
**Figure 5.19. EPG obtained using the final primer concentration.**



The target for the IPC fragments was to obtain peaks that were above 1000 rfu when the PCR efficiency is at 100%, no inhibitors are present in the reaction and when pristine DNA is used. For this reason commercially available DNA was used during optimisation to adjust the peak height of the IPC fragments. When the IPC fragment fell below 1000 rfu, it would indicate that the PCR efficiency was not at 100% or inhibitors were present in the reaction. Therefore, the role of the negative control with this multiplex is not only to detect contamination, but also acts as an indicator if there was a decrease in PCR efficiency.

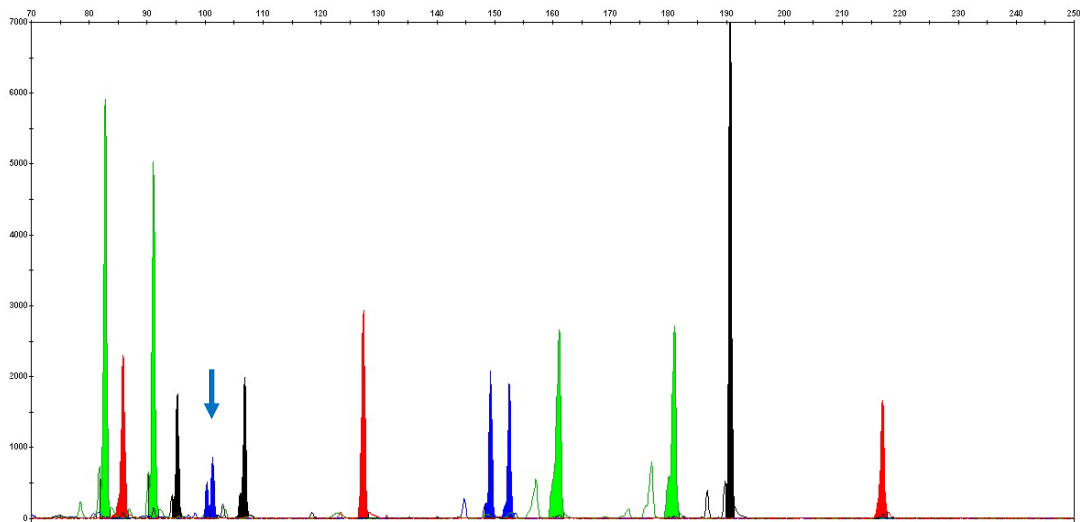
### **5.3.3.2 D22S1045 Split peak**

As the primer concentrations of both the forward and reverse primers were increased, the peak height of the D22S1045 locus increased with an increase in a n-1 peak (split peak). Different DNA sources were tested to rule out that the split peak was caused by the presence of a rare allele. All the DNA sources tested showed split peaks, even at heterozygous alleles. At first it was thought that there might have been a failure in synthesis for one of the primers which caused an increase in n-1 primer sequence [294]. Erroneous primer synthesis has been reported before by Gill *et al.* [295], so this was a possibility. Both the reverse and forward primers were re-ordered and tested but the split peaks were still observed. The second idea was that the polymerase was somehow adding an extra nucleotide, possibly by adenylation. The polymerase used in this study was a proofreading enzyme with 5' to 3' polymerase activity and 3' to 5' exonuclease activity, which produces blunt ends [296], therefore it was not possible for the polymerase to add an adenine residue. Nevertheless, an enzyme titration experiment was carried out to observe if there was a change in the split peak occurrences when the concentration of the polymerase was changed. The results observed in Figure 5.20 indicated that there was a general increase in peak heights in the profile when the polymerase concentration was increased, but there was no change in the split peak occurrence in D22S1045 (indicated by blue arrow).



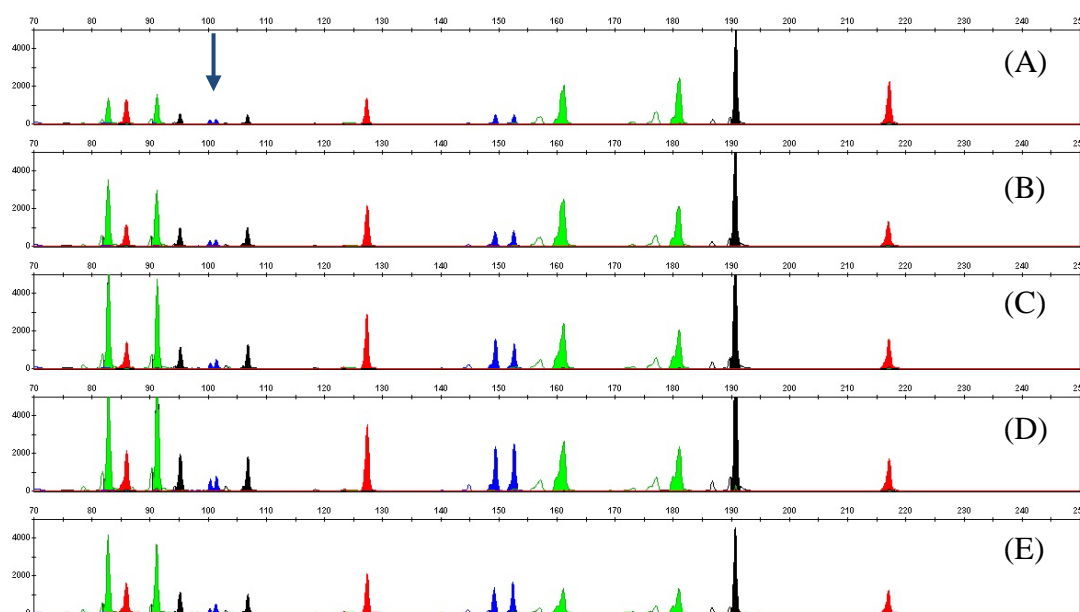
**Figure 5.20.** A close up of the EPG obtained from polymerase titration experiment; A: 0.2  $\mu\text{L}$ , B: 0.3  $\mu\text{L}$ , C: 0.4  $\mu\text{L}$ , D: 0.5  $\mu\text{L}$ , E: 0.6  $\mu\text{L}$ .

When the enzyme titration did not resolve the issue, two different enzymes that produce an A overhang in the PCR products were substituted for Phusion DNA polymerase. The two polymerases used were *AmpliTaq* Gold and Bio-X-Act Short. No peaks were detected in the *AmpliTaq* Gold reaction. The resulting EPG obtained using Bio-X-Act Short can be seen in Figure 5.21. It was observed that the split peak was still present but because the polymerase adds an adenine residue in the PCR product, the resulting peaks were shifted by 1 bp compared to the peaks obtained using Phusion DNA polymerase. From the results obtained here, it was deduced that the polymerase used in the multiplex was not causing the split peaks observed at the D22S1045 locus.



**Figure 5.21. Split peak was still observed when tested using Bio-X-Act Short.**

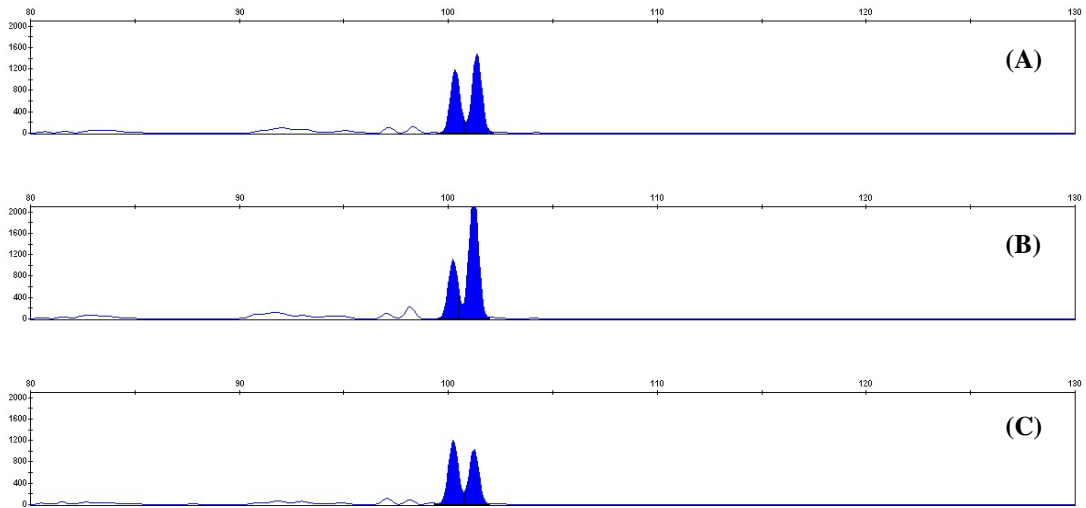
Next the  $\text{MgCl}_2$  and dNTP titration was carried out to observe if the problem can be solved by adjusting the concentration of both the dNTP and  $\text{MgCl}_2$ . There was no change in the overall peak heights of the peaks in the EPG when dNTP titration was carried out, indicating that  $0.2 \mu\text{M}$  of dNTP was the optimal amount to be used in the multiplex. When  $\text{MgCl}_2$  titration was carried out, the EPGs obtained showed an increase in peak height of the peaks when  $\text{MgCl}_2$  concentration was increased from 1.5 mM to 3.0 mM but the peak heights decreased when  $\text{MgCl}_2$  concentration was increased further to 3.5 mM. However, changing the  $\text{MgCl}_2$  concentration did not affect the split peak occurrences in D22S1045, indicated by the blue arrow in Figure 5.22.



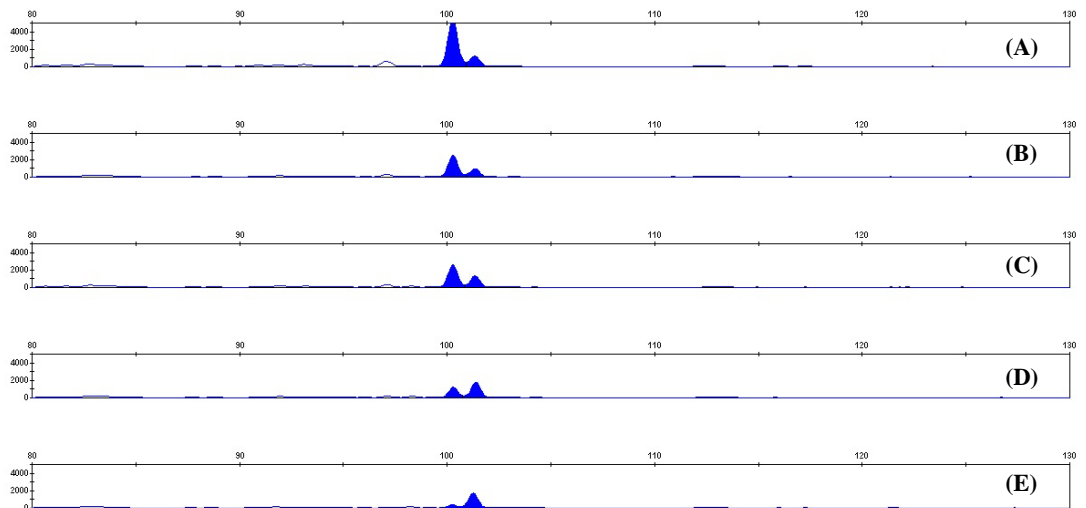
**Figure 5.22.  $\text{MgCl}_2$  titration A: 1.5 mM, B: 2.0 mM, C: 2.5 mM, D: 3.0 mM and E: 3.5 mM.**

Finally the primer concentrations were re-evaluated. Initial experiments when forward primer concentration was increased while decreasing the reverse primer had shown a decrease in the  $n-1$  peak, but when forward primer concentration was decreased while increasing the reverse primer concentration showed a decrease in peak height but not the  $n-1$  peak (Figure 5.23). Singleplex reactions were prepared where the forward primer concentration was kept at 2.0  $\mu\text{M}$  while decreasing the reverse primer concentration by 0.4  $\mu\text{M}$  decrements starting from 2.0  $\mu\text{M}$ . The resulting EPGs are shown in Figure 5.24.

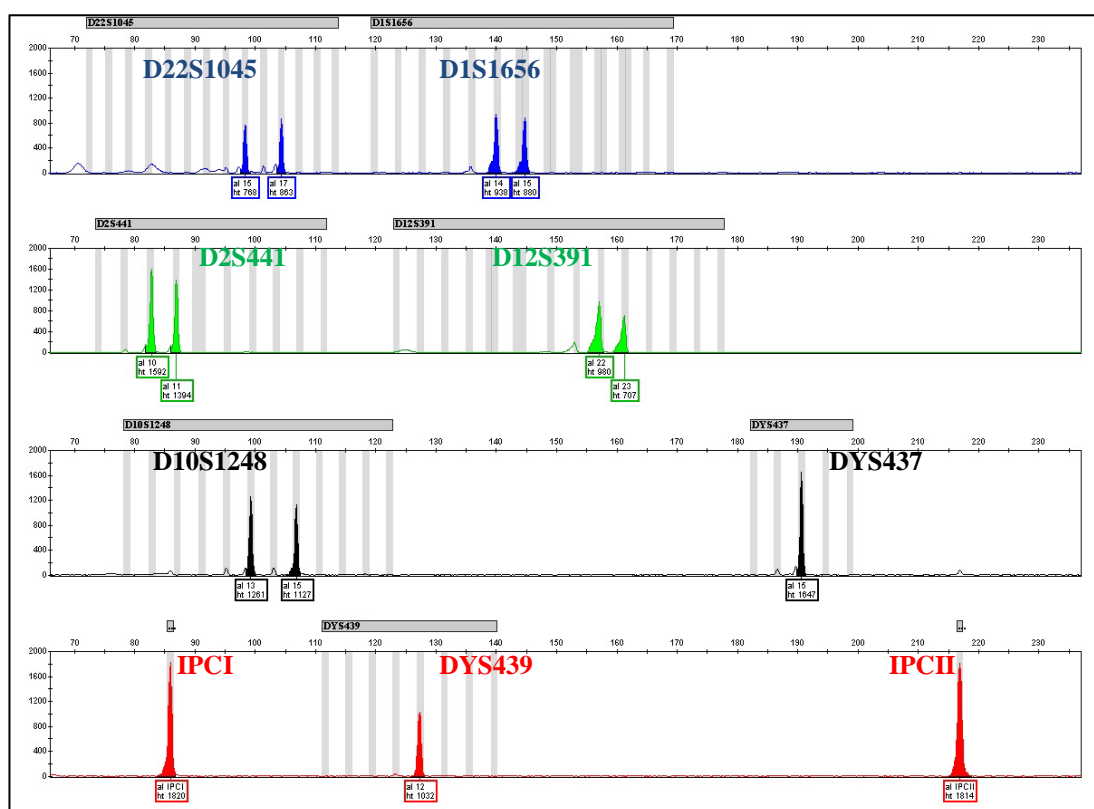
The reason for the split peak was thought to be caused by slippage of the primer on the template [228]. The reverse primer sequence of D22S1045 is 5'-GCGAATGTATGATTGGCAATATTTTT-3'. A string of 5 thymine residues at the 3' end of the primer, which are highlighted, is thought to cause the slippage which produced fragments 1 bp shorter than the actual product [297]. Reduction of the reverse primer concentration to less than 10% of the forward primer seemed to have solved the issue. Increasing the forward primer concentration while maintaining the reverse-forward primer ratio of 1:10 increased the overall peak height of the allele while keeping the split peak affect at a minimum. The final electropherogram upon completion of the primer concentration optimisation is shown in Figure 5.25. No unexpected peaks and full PCR efficiency as indicated by the IPC fragments were observed.



**Figure 5.23. D22S1045 initial primer titration with forward primer to reverse primer ratio; A: 1:1, B: 1:0.5, C: 0.5:1.**



**Figure 5.24. D22S1045 reverse primer titration with 2  $\mu$ M forward primer with decreasing amount of reverse primer; A: 2  $\mu$ M , B: 1.6  $\mu$ M , C: 1.2  $\mu$ M , D: 0.8  $\mu$ M , E: 0.4  $\mu$ M.**



**Figure 5.25.** An image of an electropherogram obtained using the optimised multiplex with 0.3 ng of DNA sample. PCR efficiency is at 100% indicated by the IPC fragments.

### 5.3.3.3 Thermal cycling protocol

The  $T_m$  of the primers used in the multiplex was in the range of 57°C to 66°C, which is a wide range of temperatures to cover in one reaction. Initial testing using standard 3 step cycle protocol with annealing temperatures from 58°C to 68°C indicated that using a single annealing temperature did not yield results as expected. No peaks were detected at 68°C which indicated that the annealing temperature was too high to yield any peaks, while annealing temperatures below 62°C were observed to give spurious peaks and very noisy baseline, indicating that the low temperatures was causing non-specific priming [226]. All singleplex reactions resulted in varied peak heights but that was to be expected as the  $T_m$  for the primers used varied from 57°C to 66°C (refer Table 5.2 and Table 5.3). In order to cover the wide range of optimal annealing temperatures of the primers, a 4 stage touchdown PCR was tested with the multiplex.

Stage 1 of the PCR protocol was the hot start cycle to activate the polymerase. The Phusion Hot Start II DNA polymerase is attached with an Affibody<sup>®</sup> molecule and uses the Affibody<sup>®</sup>-based inactivation method, whereby high temperatures activate the enzyme [235]. In stage 2, an auto delta step was implemented on the Veriti thermal cycler that decreases the annealing temperature 1°C per cycle for 10 cycles starting from 68°C. This temperature was chosen as the starting of the auto delta step because at this high temperature, there is an increase in specificity of the primers annealing to the target [226]. After the initial high temperature cycles, there should be sufficient specific products in the reaction to act as templates, so when the annealing temperature was decreased to 55°C at stage 3, the specific products should have a geometric head start to out compete the non-specific products for the remaining resources and produce specific yields [298]. During stage 3 of the protocol, the sensitivity of the reaction is increased to improve the peak heights of the alleles detected. Stage 4 is the final elongation to allow the polymerase to complete extending the strands. The final protocol optimised for this multiplex reaction can be seen in Table 5.11.

**Table 5.11. Multiplex touchdown PCR protocol using the Veriti Thermal cycler.**

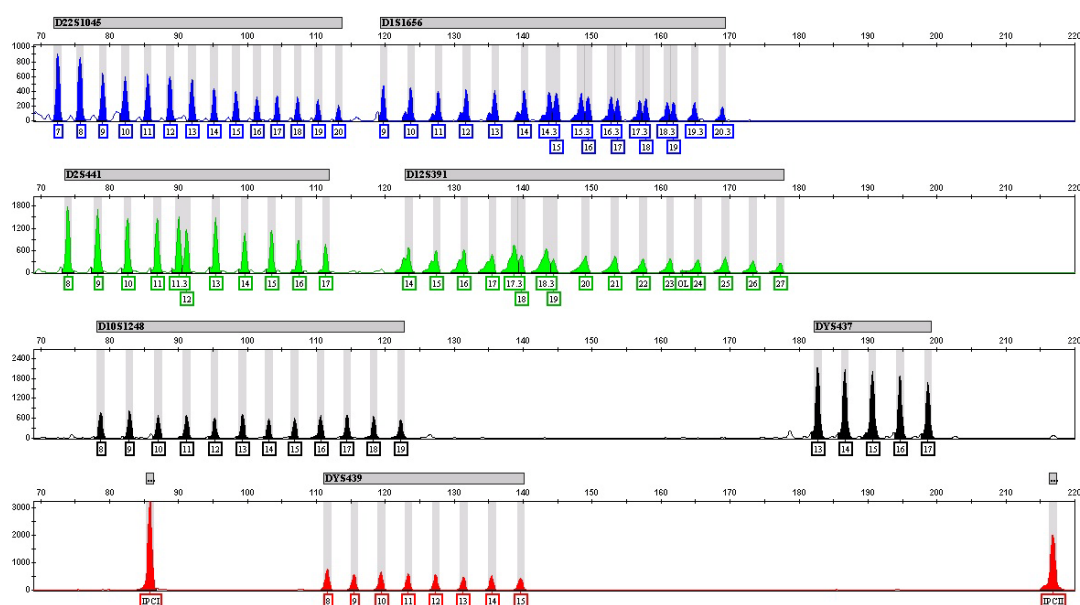
Stage 1	Stage 2			Stage 3			Stage 4	
1 cycle	10 cycles			20 cycles			1 cycle	
98°C	98°C	68°C <sup>A</sup>	68°C	95°C	55°C	65°C	60°C	4°C
2 min	5 sec	5 sec	20 sec	5 sec	5 sec	20 sec	5 min	10 min

<sup>A</sup>: The auto delta step which starts at 68°C and decreases the temperature by 1°C/cycle for 10 cycles.



### 5.3.3.4 Allelic Ladder development

The template for the development of the allelic ladder was obtained from the PowerPlex ESI 16 and PowerPlex Y kits. These two allelic ladders were chosen because the template sizes of the ladders were bigger than the product sizes obtained from the multiplex, and therefore, the primer binding sites would fall within the template. Both the autosomal STR and Y-STR ladder templates which were diluted to 1 in 1,000,000 produced peaks which were between 300 to 3000 rfu. All the other ladder dilutions produced peaks which were above the 8000 rfu threshold, and resulted in pull ups, split peaks and also 'slope effect' where the smaller alleles were amplified preferentially while the bigger alleles were either reduced in peak height or dropped out. Reducing the amount of template reduced the peak height ratio between the smallest and the largest allele within the loci, but did not solve the problem altogether. The allelic ladder obtained using the multiplex can be seen in Figure 5.26. The observed product size range for each STR locus obtained with the allelic ladder was then compared to the expected product size range obtained from literature in Table 5.12.



**Figure 5.26. Allelic ladder created for the use during runs with samples amplified with the multiplex.**

**Table 5.12. Comparison between the expected and observed product size in all the loci.**

<b>Loci</b>	<b>Expected size (bp)</b>	<b>Observed size (bp)</b>
<b>D22S1045</b>	79-115	72-113
<b>D1S1656</b>	121-169	120-169
<b>D2S441</b>	78-110	74-111
<b>D12S391</b>	125-173	123-177
<b>D10S1248</b>	79-123	79-122
<b>DYS437</b>	181-197	183-199
<b>DYS439</b>	116-136	112-140

D22S1045 was observed to be 5 bp more than the expected size. There was an additional repeat in the allelic ladder, allele 7, that was not present in the original literature where the primers were obtained [285] but was present in the allelic ladder of PowerPlex ESI 16. This accounts for the additional 3 bp and a slight migration shift in the <16 repeats accounts for the additional 2 bp difference between the observed and the expected product sizes. D2S441 had an additional allele 8 in the allelic ladder, that was present in the PowerPlex ESI 16 ladder which accounts for the difference between the observed and expected sizes. Allele 8 was not observed by Coble *et al.* when validating their primers [241]. D12S391 was observed to have an increase of 6 bp in the observed product size, and this was accounted for by the presence of two extra repeats in the allelic ladder, the alleles 14 and 27 which were not present in the literature where the expected size data were obtained [299]. As D12S391 is a tetrameric repeat, an 8 bp difference should have been observed because of the 2 additional repeats but this was not the case. DYS439 observed product size was more than the expected size because of the inclusion of 2 extra alleles 8 and 15 which accounts for the additional 8 bp in observed size.

Some of the differences between the observed and expected product sizes could be caused by the difference in DNA polymerase and in the fluorescent dyes used between the multiplex and literature. AmpliTaq gold DNA polymerase, that was most reported in literature [241, 281, 299], adds an adenine residue and causes the

PCR product to be 1 bp longer than the calculated product size. As Phusion DNA polymerase creates blunt end products, the PCR products obtained using Phusion DNA polymerase is expected to be 1 bp less than the expected product sizes obtained using *AmpliTaq Gold*. The fluorescent dyes attached to the primers have different shapes, sizes and molecular weights and therefore impacts the DNA molecule's electrophoretic mobility [21]. This is because the physical size and shape of the dye changes the overall size of the dye-DNA conjugate [21]. The ionic charge of the dye also alters the charge to size ratio of the dye-DNA conjugate [21]. To overcome this problem, genotyping is always carried out relative to allelic ladders that have been amplified with the same DNA polymerase and are labelled with the same fluorescent dyes as the DNA template to be analysed so that the differences in dye mobility do not impact allele calls [21].

#### **5.3.3.5 Panel and bin set creation**

The sizes (bp) of each allele obtained in every locus in the allelic ladder for 100 runs were exported to Excel. The minimum, maximum, mean ( $\bar{X}$ ), standard deviation ( $\sigma$ ),  $\bar{X}+3\sigma$  and  $\bar{X}-3\sigma$  were calculated and tabulated in Table 5.13. The minimum and maximum values indicate the smallest and largest recorded size in base pairs for an allele at a particular locus. The  $\bar{X}$  value indicates the average size in base pairs of an allele for that particular locus.  $\sigma$  indicates the deviation of the allele from the population mean, and a low  $\sigma$  indicates that the data points are very close to the population mean.

When a sample is run on the genetic analyser, the allele that is obtained should be  $\pm 0.5$  bp of same allele on the allelic ladder [40]. When the allele is outside this range, then the allele call is deemed inconclusive and the sample needs to be reanalysed [40]. The  $\bar{X}+3\sigma$  and  $\bar{X}-3\sigma$  was calculated to determine the confidence limit of the data. It was observed that all the data were within  $\pm 0.5$  bp at 99.73% confidence interval, and therefore,  $\pm 0.5$  bp range was used to set the limit for each allele. The

panel created for the use with the GeneMapper ID v3.2.1 software is shown in Appendix 3.

**Table 5.13. Results for the run variation used to create the bins and panels.**

	Min (bp)	Max (bp)	$\bar{X}$ (bp)	$\sigma$	$\bar{X} + 3\sigma$ (bp)	$\bar{X} - 3\sigma$ (bp)
<b>D22S1045</b>						
<b>7</b>	72.36	72.59	72.48	0.05	72.64	72.33
<b>8</b>	75.64	75.86	75.72	0.05	75.88	75.56
<b>9</b>	78.89	79.10	79.00	0.05	79.15	78.86
<b>10</b>	82.16	82.39	82.27	0.05	82.43	82.11
<b>11</b>	85.43	85.64	85.53	0.06	85.69	85.36
<b>12</b>	88.66	88.88	88.76	0.05	88.91	88.60
<b>13</b>	91.84	92.10	91.96	0.06	92.15	91.77
<b>14</b>	95.04	95.30	95.15	0.06	95.34	94.97
<b>15</b>	98.24	98.47	98.32	0.06	98.51	98.14
<b>16</b>	101.24	101.51	101.38	0.05	101.54	101.22
<b>17</b>	104.18	104.46	104.32	0.05	104.48	104.16
<b>18</b>	107.14	107.41	107.28	0.05	107.44	107.12
<b>19</b>	110.12	110.38	110.26	0.05	110.41	110.10
<b>20</b>	113.10	113.38	113.24	0.06	113.41	113.08
<b>D1S1656</b>						
<b>9</b>	119.65	119.88	119.76	0.05	119.91	119.62
<b>10</b>	123.59	123.86	123.72	0.05	123.88	123.56
<b>11</b>	127.56	127.85	127.72	0.05	127.87	127.57
<b>12</b>	131.65	131.87	131.77	0.05	131.93	131.62
<b>13</b>	135.82	135.99	135.92	0.05	136.06	135.78
<b>14</b>	140.05	140.27	140.18	0.05	140.34	140.03
<b>14.3</b>	143.68	143.93	143.77	0.07	143.97	143.58
<b>15</b>	144.70	144.95	144.81	0.07	145.02	144.61
<b>15.3</b>	148.20	148.55	148.38	0.06	148.56	148.19
<b>16</b>	149.32	149.55	149.40	0.07	149.62	149.18
<b>16.3</b>	152.59	152.88	152.71	0.06	152.90	152.52
<b>17</b>	153.54	153.79	153.65	0.06	153.85	153.46

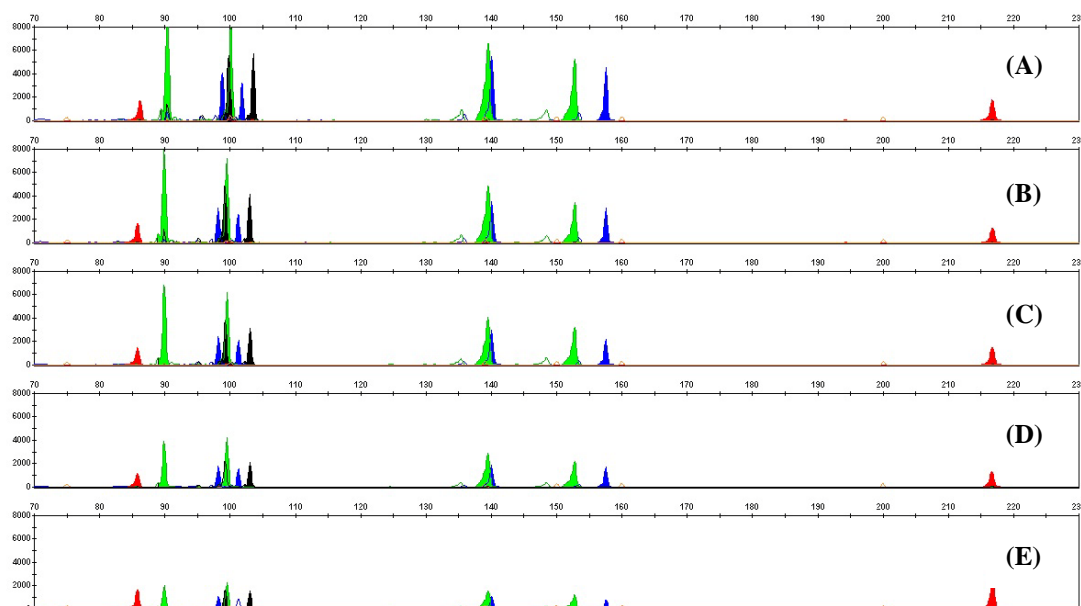
<b>17.3</b>	156.74	156.98	156.84	0.06	157.00	156.67
<b>18</b>	157.64	157.87	157.75	0.05	157.91	157.60
<b>18.3</b>	160.78	160.97	160.86	0.05	161.01	160.70
<b>19</b>	161.67	161.87	161.77	0.05	161.93	161.61
<b>19.3</b>	164.71	164.95	164.85	0.05	165.00	164.69
<b>20.3</b>	168.72	168.98	168.85	0.05	169.00	168.69
<b>D2S441</b>						
<b>8</b>	73.83	74.06	73.96	0.05	74.13	73.80
<b>9</b>	78.22	78.43	78.29	0.05	78.44	78.14
<b>10</b>	82.52	82.71	82.61	0.05	82.76	82.46
<b>11</b>	86.81	87.04	86.91	0.06	87.08	86.73
<b>11.3</b>	89.92	90.19	90.04	0.05	90.20	89.88
<b>12</b>	91.07	91.33	91.18	0.05	91.33	91.02
<b>13</b>	95.33	95.50	95.41	0.06	95.57	95.24
<b>14</b>	99.48	99.69	99.60	0.06	99.79	99.40
<b>15</b>	103.42	103.63	103.51	0.06	103.68	103.35
<b>16</b>	107.28	107.56	107.42	0.05	107.58	107.26
<b>17</b>	111.25	111.50	111.37	0.05	111.53	111.21
<b>D12S391</b>						
<b>14</b>	123.29	123.54	123.42	0.05	123.57	123.28
<b>15</b>	127.31	127.56	127.42	0.05	127.57	127.27
<b>16</b>	131.35	131.57	131.46	0.05	131.61	131.31
<b>17</b>	135.42	135.67	135.54	0.04	135.66	135.41
<b>17.3</b>	138.69	138.80	138.73	0.05	138.89	138.57
<b>18</b>	139.68	139.82	139.75	0.06	139.92	139.58
<b>18.3</b>	143.23	143.47	143.35	0.05	143.50	143.19
<b>19</b>	144.25	144.49	144.40	0.05	144.56	144.23
<b>20</b>	148.88	149.11	149.00	0.07	149.22	148.78
<b>21</b>	153.20	153.39	153.29	0.06	153.46	153.11
<b>22</b>	157.24	157.47	157.36	0.05	157.52	157.20
<b>23</b>	161.18	161.38	161.31	0.05	161.46	161.16
<b>24</b>	165.19	165.44	165.32	0.05	165.47	165.16
<b>25</b>	169.19	169.39	169.30	0.05	169.45	169.16

<b>26</b>	173.19	173.43	173.30	0.05	173.45	173.15
<b>27</b>	177.16	177.38	177.28	0.05	177.43	177.13
<b>D10S1248</b>						
<b>8</b>	78.57	78.78	78.70	0.04	78.83	78.57
<b>9</b>	82.77	82.95	82.87	0.04	82.99	82.76
<b>10</b>	86.92	87.10	87.03	0.04	87.16	86.91
<b>11</b>	91.04	91.23	91.14	0.05	91.28	91.00
<b>12</b>	95.12	95.30	95.23	0.05	95.38	95.07
<b>13</b>	99.17	99.39	99.28	0.04	99.39	99.17
<b>14</b>	102.97	103.17	103.08	0.04	103.22	102.95
<b>15</b>	106.73	106.95	106.84	0.05	106.98	106.70
<b>16</b>	110.51	110.74	110.62	0.05	110.77	110.48
<b>17</b>	114.36	114.57	114.45	0.05	114.59	114.31
<b>18</b>	118.23	118.44	118.32	0.05	118.46	118.18
<b>19</b>	122.11	122.39	122.25	0.05	122.39	122.10
<b>DYS437</b>						
<b>13</b>	182.61	182.79	182.70	0.04	182.81	182.58
<b>14</b>	186.54	186.72	186.62	0.04	186.75	186.50
<b>15</b>	190.55	190.71	190.63	0.04	190.75	190.50
<b>16</b>	194.53	194.70	194.64	0.04	194.76	194.52
<b>17</b>	198.59	198.79	198.69	0.04	198.82	198.57
<b>DYS439</b>						
<b>8</b>	111.54	111.76	111.62	0.05	111.76	111.49
<b>9</b>	115.40	115.59	115.50	0.05	115.64	115.36
<b>10</b>	119.25	119.50	119.41	0.05	119.55	119.26
<b>11</b>	123.25	123.47	123.35	0.05	123.49	123.21
<b>12</b>	127.25	127.46	127.34	0.04	127.47	127.21
<b>13</b>	131.27	131.47	131.38	0.05	131.53	131.22
<b>14</b>	135.38	135.57	135.45	0.03	135.55	135.35
<b>15</b>	139.57	139.70	139.65	0.05	139.81	139.48
<b>PosCtrl</b>						
<b>IPCI</b>	85.77	85.99	85.87	0.04	86.00	85.74
<b>IPCII</b>	216.74	217.01	216.85	0.07	217.05	216.64

### 5.3.4 Multiplex validation

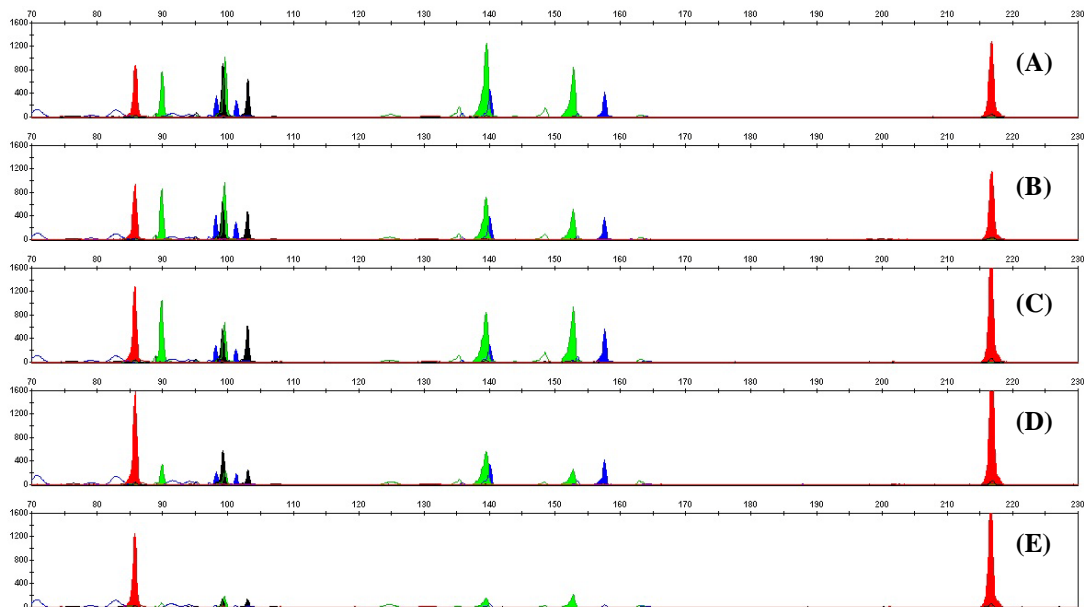
#### 5.3.4.1 Evaluation of sensitivity and optimal DNA input

Optimal DNA amount in the amplification reaction was evaluated. Too much DNA will result in split or off-scale peaks while too little DNA may result in allele dropout and peak imbalances (see data interpretation in Chapter 1) [21]. Optimal amount of DNA in a reaction is critical to ensure an artefact free DNA profile to make interpretation accurate. Based on the EPGs obtained, all samples with 1.0 ng of DNA were observed to have pull ups due to overloading of template DNA in the amplification reaction. In samples with excess DNA, the peak height of IPCII was below 1000 rfu, probably from the excess DNA acting as inhibitors to the reaction. Full profiles were obtained up to 0.1 ng of DNA for all four samples tested. At 0.1 ng to 0.5 ng of DNA, both the IPC fragments had very similar peak height of around 1500 to 2000 rfu. Thus, the optimal DNA for the multiplex was set at 0.1 ng to 0.5 ng. The results obtained from the optimal DNA input are shown in Figure 5.27.



**Figure 5.27. Testing the optimal DNA input for the multiplex using A: 1.0 ng, B: 0.75 ng, C: 0.5 ng, D: 0.25 ng, and E: 0.1 ng.**

Sensitivity of the multiplex reaction was evaluated to determine the lower limit of the multiplex system. According to Gill *et al.* new multiplexes should be equivalent in sensitivity to the existing multiplexes and are capable of detecting full profiles at 250 pg [300]. In this study, human placental DNA was amplified from 100 pg to 10 pg, to observe the resulting DNA profiles obtained. Full profiles were obtained up till 25 pg of DNA in all four DNA sources tested. Partial profiles were obtained with 10 pg which is equivalent to about 1.5 cells [1]. The EPG obtained from one of the DNA sources with 100 pg to 10 pg of DNA is shown in Figure 5.28. This multiplex reaction was determined to be more sensitive than other commercially available multiplexes which can give full DNA profiles with 100 pg of DNA [145, 245]. Therefore, there could be an increased chance of obtaining DNA profiles from touch DNA when using this multiplex.



**Figure 5.28. Sensitivity testing for the multiplex using A: 100 pg, B: 75 pg, C: 50 pg, D: 25 pg and E: 10 pg.**



#### **5.3.4.2 Y-STR sensitivity in mixtures**

Two sets of male and female DNA was amplified with the multiplex and the Y-STR allele's peak heights and the average PHR between female (F) and male (M) are tabulated in Table 5.14. The average PHR is rounded up to the closest 2<sup>nd</sup> decimal point. In both sets, the male contributed alleles were still observed when the male DNA was 10 times less than the female DNA.

In both sets, when the concentration ratio of female to male DNA was 1, the female contributed alleles were lower in peak height compared to the male contributed alleles giving the average F:M ratio less than 1. As male DNA was decreased in the reaction, the average PHR gradually increased but did not reflect the concentration ratio of the mixture. For example, a 1:1 mixture would mean that there is equal contribution of female and male DNA and therefore both the female and male contributed peaks would be equal or similar in peak heights. One of the possibilities for this observation is an error in the quantification results. Since the dilutions for the mixtures were prepared using the quantification results any errors in those results would affect the mixture ratio.

If mixture samples which involve several males and a female from crime scenes are obtained, this multiplex would be able to detect the presence of male DNA even in the presence of 10 times the amount of female DNA. Moreover, the number of male contributors in the mixture sample can also be identified in the presence of high concentrations of female DNA, which is not possible with other multiplex kits that use amelogenin as the sex determining marker.

**Table 5.14. Peak height of Y-STR alleles obtained with excess female DNA.**

	Female:Male	Peak height (rfu)		Average STR
	DNA ratio	DYS437	DYS439	PHR (F : M)
<b>Set 1</b>	1 : 1	4986	3897	0.54±0.06
	4 : 3	3689	2820	0.72±0.05
	2 : 1	3771	3011	1.11±0.11
	4 : 1	2240	1961	2.25±0.13
	10 : 1	1020	630	5.24±1.05
<b>Set 2</b>	1 : 1	3340	2629	0.83±0.16
	4 : 3	2679	2120	1.12±0.25
	2 : 1	1069	735	1.73±0.47
	4 : 1	1110	806	3.22±0.93
	10 : 1	442	330	7.85±3.70

**5.3.4.3 Allele concordance**

Alleles obtained using the multiplex were compared with PowerPlex ESX and ESI 16 for concordance. The results obtained are tabulated in Table 5.15. All alleles amplified from the ten reference samples, two controls and one commercial DNA using the multiplex was in concordance with both PowerPlex ESI and ESX 16.

Sample Reference 7 demonstrated the presence of a rare allele 8 in D1S1656 which was not present in the allelic ladder of PowerPlex ESI 16 (ESI). This allele was not found to be reported in other populations as well [274, 276, 277, 280, 281, 286, 300]. Since the allelic ladder from the ESI was the starting template used to develop the allelic ladder for the multiplex, this rare allele was not present in the allelic ladder of the multiplex. However, the bin sets created by Promega for ESI kit included the rare allele 8 and therefore, this allele was labelled when amplified with the ESI kit. In the multiplex, this allele was out of the D1S1656 panel range and was labelled as OL (Off-Ladder) with a size of 115.78 bp. Allele 9 of D1S1656 was about 119.81 bp,

which indicates that the OL peak in Reference 7 was an allele 8. Figure 5.29 illustrates the rare allele in D1S1656 further.

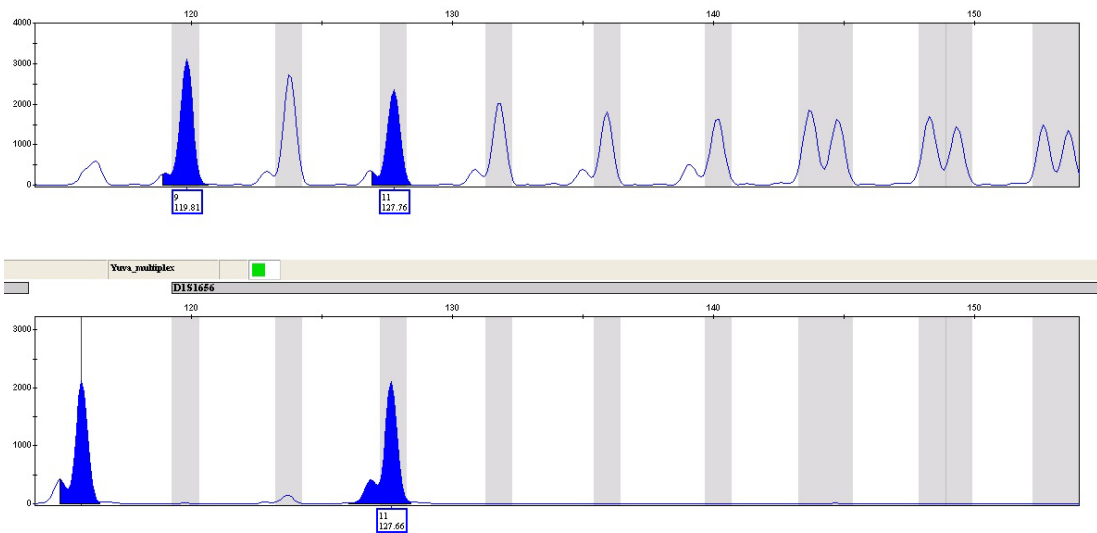
The human placental DNA demonstrated a rare allele at D12S391 which was present in all three kits tested. The allele was outside the D12S391 panel range for all three kits. The allele was recorded to be around 181.09 bp in the multiplex, 345.32 bp in ESI and 191.01 bp in ESX. Upon comparing the size of the allele with the allelic ladders for each kit, the rare allele was calculated to be allele 28. Figure 5.30, Figure 5.31 and Figure 5.32 illustrate the rare allele in D12S391.

**Table 5.15. Allele concordance between developed multiplex, PowerPlex ESX 16 (ESX) and PowerPlex ESI 16 (ESI).**

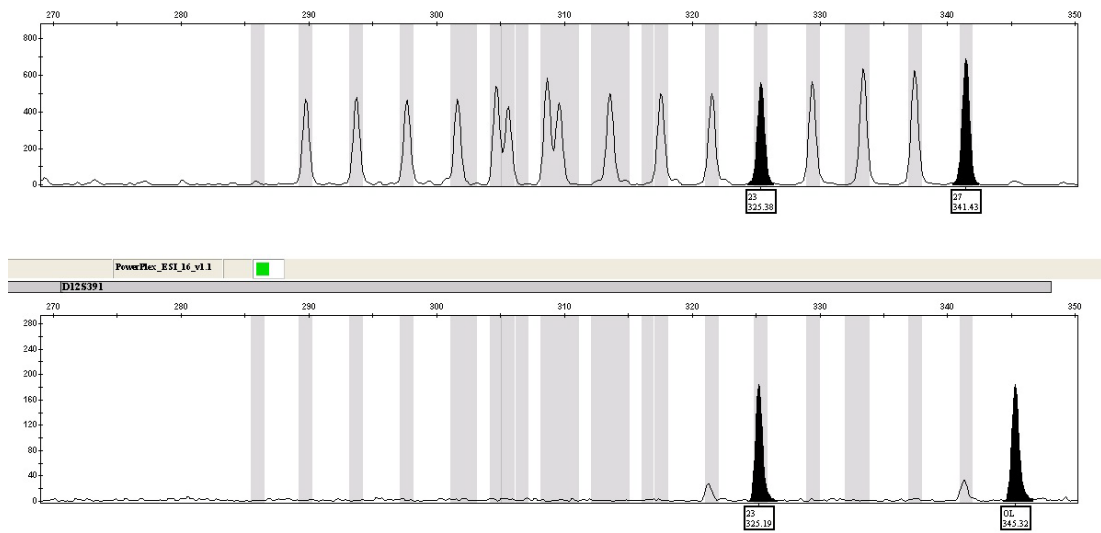
Sample ID	STR kit	D22S1045	D1S1656	D2S441	D12S391	D10S1248					
Reference 1	Multiplex	16	16	18.3	18.3	14	14	18	25	13	16
	ESX	16	16	18.3	18.3	14	14	18	25	13	16
	ESI	16	16	18.3	18.3	14	14	18	25	13	16
Reference 2	Multiplex	11	15	12	15	11	14	17	17	13	14
	ESX	11	15	12	15	11	14	17	17	13	14
	ESI	11	15	12	15	11	14	17	17	13	14
Reference 3	Multiplex	11	15	11	18.3	10	11	22	23	13	14
	ESX	11	15	11	18.3	10	11	22	23	13	14
	ESI	11	15	11	18.3	10	11	22	23	13	14
Reference 4	Multiplex	13	15	17	18.3	11	14	22	22	13	17
	ESX	13	15	17	18.3	11	14	22	22	13	17
	ESI	13	15	17	18.3	11	14	22	22	13	17
Reference 5	Multiplex	15	16	14	18	11.3	14	18	21	13	14
	ESX	15	16	14	18	11.3	14	18	21	13	14
	ESI	15	16	14	18	11.3	14	18	21	13	14
Reference 6	Multiplex	11	16	12	16.3	11	14	17	21	13	14
	ESX	11	16	12	16.3	11	14	17	21	13	14
	ESI	11	16	12	16.3	11	14	17	21	13	14
Reference 7	Multiplex	15	16	8*	11	10	11.3	18	19	15	17
	ESX	15	16	8	11	10	11.3	18	19	15	17
	ESI	15	16	8	11	10	11.3	18	19	15	17
Reference 8	Multiplex	15	16	15	17	12	14	19	21	13	14
	ESX	15	16	15	17	12	14	19	21	13	14
	ESI	15	16	15	17	12	14	19	21	13	14

Reference 9	Multiplex	17	18	14	17	11	12	22	22	13	13
	ESX	17	18	14	17	11	12	22	22	13	13
	ESI	17	18	14	17	11	12	22	22	13	13
Reference 10	Multiplex	15	17	14	15	10	11	22	23	13	15
	ESX	15	17	14	15	10	11	22	23	13	15
	ESI	15	17	14	15	10	11	22	23	13	15
Control 9947A	Multiplex	11	14	18.3	18.3	10	14	18	20	13	15
	ESX	11	14	18.3	18.3	10	14	18	20	13	15
	ESI	11	14	18.3	18.3	10	14	18	20	13	15
Control 007	Multiplex	11	16	13	16	14	15	18	19	12	15
	ESX	11	16	13	16	14	15	18	19	12	15
	ESI	11	16	13	16	14	15	18	19	12	15
Human placental DNA	Multiplex	16	16	16	16.3	10	12	23	28*	12	15
	ESX	16	16	16	16.3	10	12	23	28*	12	15
	ESI	16	16	16	16.3	10	12	23	28*	12	15

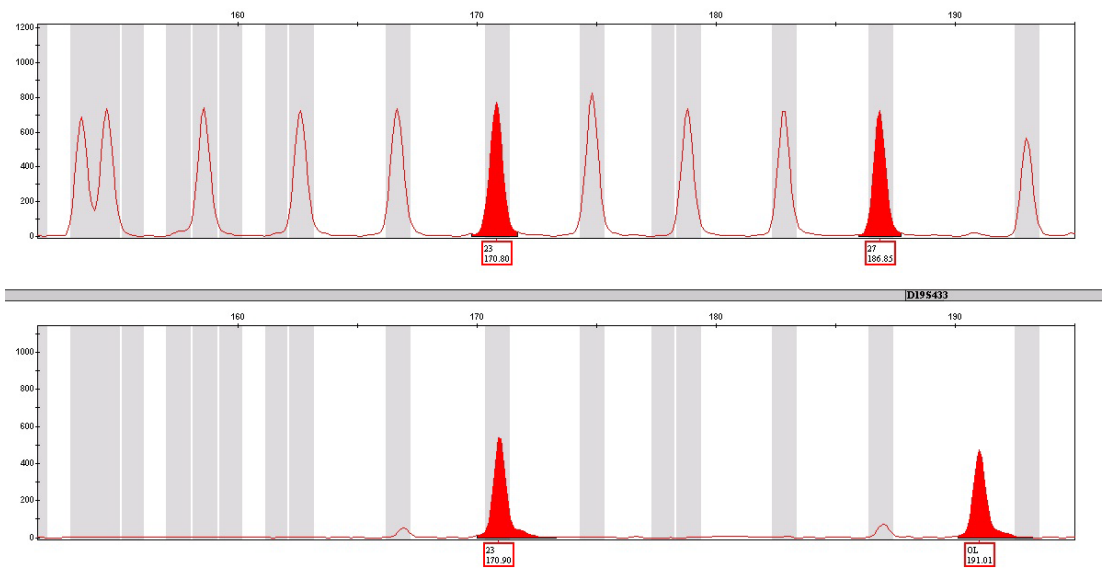
\*: Numbers in red represent alleles that were out of the allele panel range and were designated based on their size according to the allelic ladder



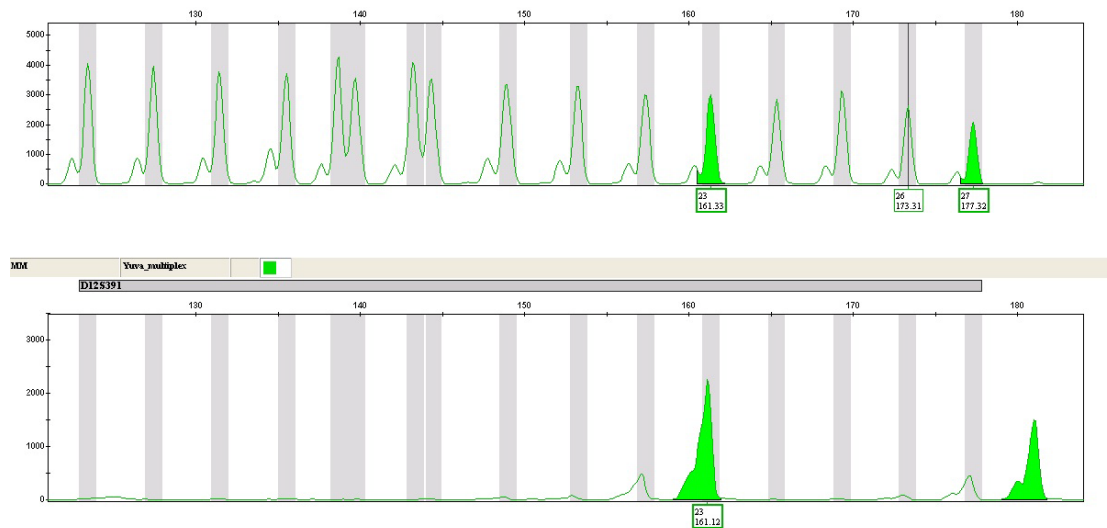
**Figure 5.29. OL allele for Reference 7 at D1S1656 which was recorded at 115.78 bp**



**Figure 5.30. OL allele of Human placental DNA at D12S391 of PowerPlex ESI 16 kit recorded at 345.32 bp**



**Figure 5.31. OL allele of Human placental DNA at D12S391 of PowerPlex ESX 16 recorded at 191.01 bp.**



**Figure 5.32. OL allele of Human placental DNA at D12S391 of Multiplex recorded at 181.09 bp.**

### 5.3.4.4 Peak heights

Peak heights were analysed separately according to loci and amount of DNA template in the reaction. Peak heights for heterozygous peaks were cumulated to obtain a single peak height value for each locus. Cumulative peak heights according to locus are illustrated in Figure 5.33. Peak heights decreased across the loci as the DNA template was reduced. It was observed that peaks obtained at locus D2S441 was higher than the peaks obtained at the other STR loci in the multiplex at 1.0 ng up to 500 pg of DNA template. As the DNA template decreased, better balance in peak heights between loci were observed. Allelic dropout at D22S1045 was observed in three out of four of the DNA samples analysed while 50% of the samples showed allelic dropout at D1S1656 at 10 pg of DNA template. Full DNA profiles were obtained up to 25 pg of DNA template.

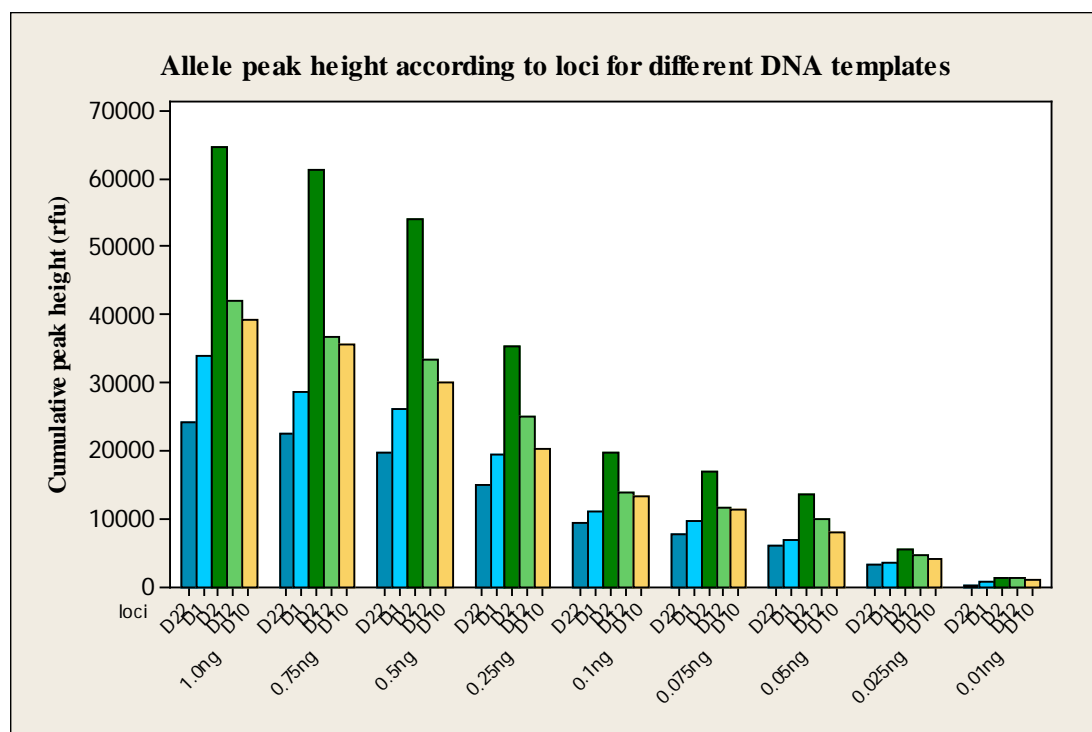
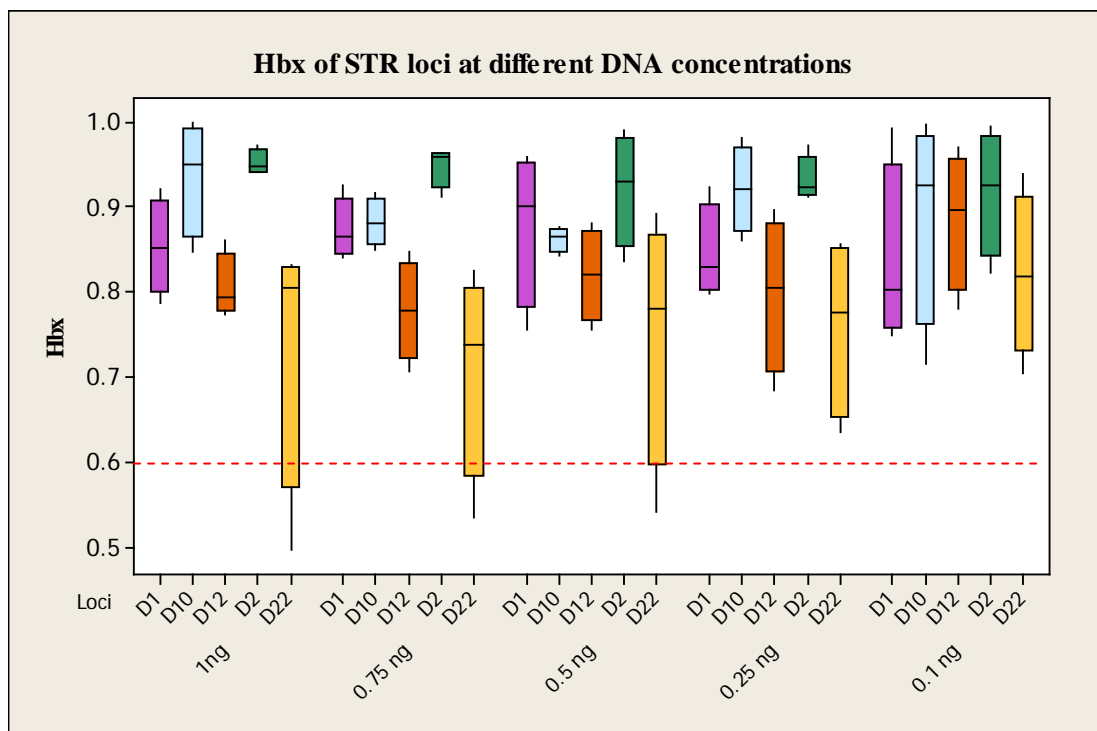


Figure 5.33. Cumulative peak height according to locus.



### 5.3.4.5 Heterozygous peak balance

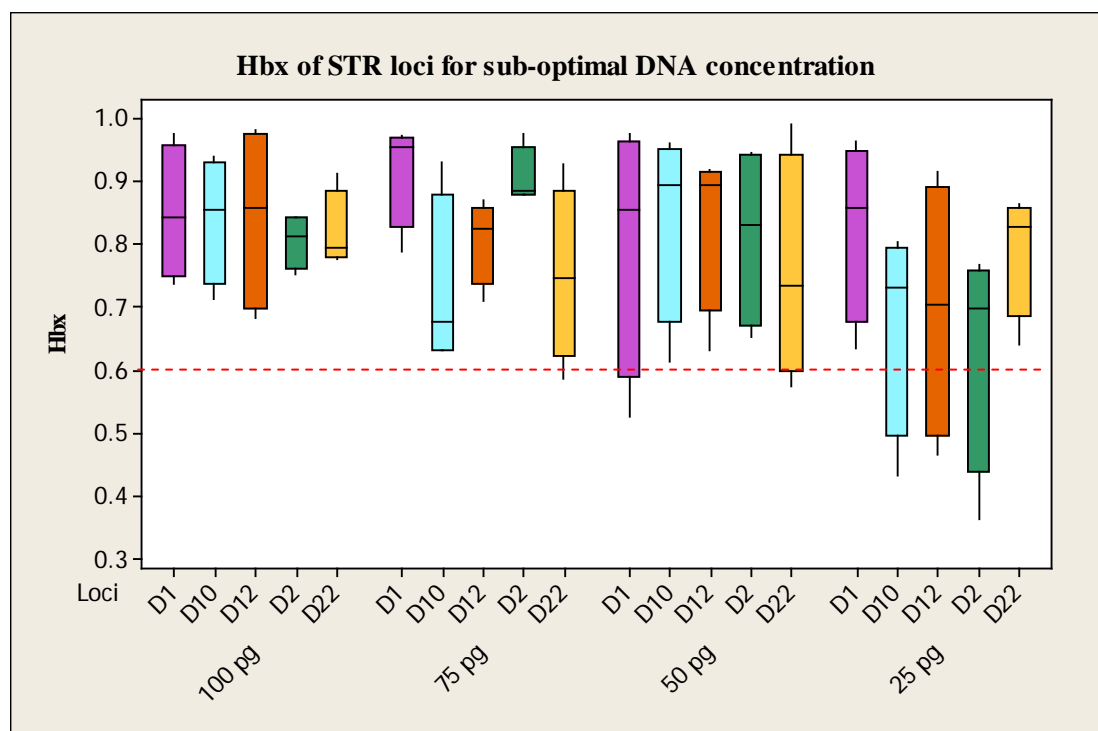
Heterozygous peak balance (Hbx) was calculated by dividing the higher peak height by the lower peak height. Value of 1 indicates that both heterozygous peaks are identical in peak height. Gill *et al.* recommended that peaks at heterozygous loci should be 0.6 or greater of each other [40]. Figure 5.34 illustrates the Hbx of the five STR loci in the multiplex at five DNA amounts of 1.0 ng to 0.1 ng. Median Hbx for all loci at DNA concentrations 1.0 ng to 0.1 ng was above 0.7, which is above the optimal Hbx recommended for a multiplex [40]. Good Hbx (above 0.6) was obtained at DNA concentration of 0.25 ng and 0.1 ng for all loci which supports the ascertained previously optimal DNA input range for this multiplex of 0.1 ng to 0.5 ng. All loci were observed to have Hbx above 0.7 for DNA concentrations up to 0.1 ng except D22S1045. D22S1045 gave the widest range of Hbx which improved as the concentration of DNA was reduced. Majority of the Hbx data was observed to be above the 0.6 threshold.



**Figure 5.34. Heterozygous peak balance of five STR loci at five different DNA concentrations. Boxplots are colour coded according to loci.**

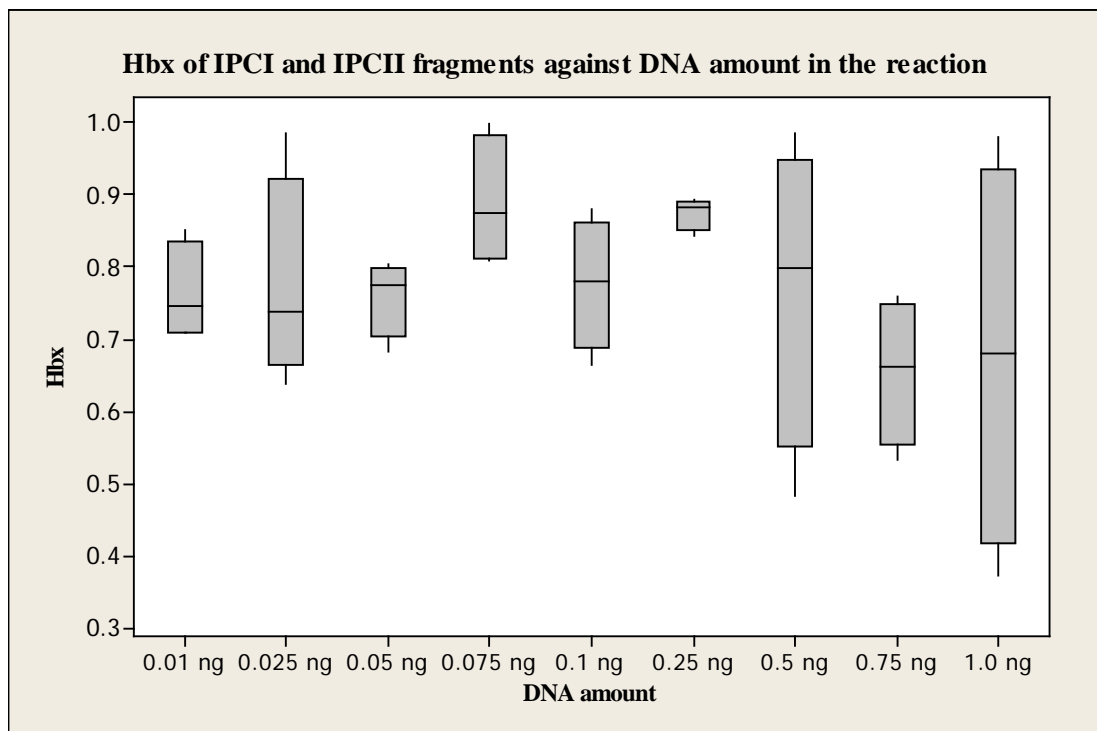
Hbx for DNA amounts 100 pg to 25 pg is shown in Figure 5.35. Data for 10 pg of DNA was omitted from Hbx calculations because of allelic dropouts from some of the loci. Hbx was observed to be above 0.6 for all loci at DNA amounts of 100 pg to 75 pg. When DNA amount in the reaction was reduced to 50 pg and 25 pg, the Hbx of alleles started to drop below the recommended optimal value of 0.6, but a majority of the data were still above the recommended 0.6 threshold. Contrary to what Gill *et al.* observed using AmpFISTR SGMPlus, no severe peak imbalances were observed for DNA templates as low as 50 pg [45]. Even at 25 pg of template DNA, more than half the Hbx data were observed to be above the recommended threshold.

The null hypothesis ‘*The distribution of Hbx is the same across categories of Loci*’ (Kruskal-Wallis independent samples test; p- value 0.003) and the null hypothesis ‘*the medians of Hbx are the same across categories of loci*’ (Independent Samples median test; p-value 0.00) were rejected. This indicated that there was a significant difference in the Hbx of different loci in the multiplex.



**Figure 5.35. Heterozygous peak balance for 5 STR loci with sub-optimal amounts of DNA. Boxplots are colour coded according to loci.**

The IPC fragments in the multiplex were designed to indicate if there were inhibitors present in the sample, or if there was a reduction in amplification efficiency for the particular sample. Theoretically, at optimal DNA concentrations and quality, IPC fragments should have similar peak heights and therefore a Hbx value close to 1. The Hbx for the IPC fragments were calculated and plotted in box plots as illustrated in Figure 5.36. Based on the results obtained, Hbx for the IPC fragments were above 0.6 when the DNA template was less than 0.5 ng. Hbx ranged from 1.0 to 0.4 at 1.0 ng of DNA template. Median Hbx was between 0.7 to 0.9 at 0.25 ng to 0.01 ng of template DNA, which indicates that the optimal DNA range should be 0.25 ng and below.



**Figure 5.36. Heterozygous balance between IPCI and IPCII using 0.01 ng up to 1.0 ng of DNA in the reaction.**

### 5.3.4.6 Stutter ratio

Stutter ratio was calculated by taking the peak height of the  $n-4$  peak divided by the peak height of the parent peak. The number of peaks analysed for each loci were D22S1045 ( $n = 19$ ), D1S1656 ( $n = 21$ ), D2S441 ( $n = 25$ ), D12S391 ( $n = 25$ ), D10S1248 ( $n = 21$ ), DYS437 ( $n = 10$ ) and DYS439 ( $n = 10$ ). The dataset, shown in Figure 5.37, comprised of samples which were amplified with 1.0 ng up to 0.1 ng of template DNA. No stutters were observed with both the IPC fragments as they were not repetitive sequences and therefore they were not included in the stutter calculations. Alleles at both the Y-STR loci were observed to give stutter peaks which were less than 5% of the parent peak. Stutters at D2S441 were less than 7% while stutters at D10S1248 and D22S1045 were less than 15%, regardless of the peak heights of the parent peaks. The stutters at D1S1656 were at a maximum of 16%. Only D12S391 exhibited high stutter percentage with around 20% with an outlier at 30% of the parent peak height.

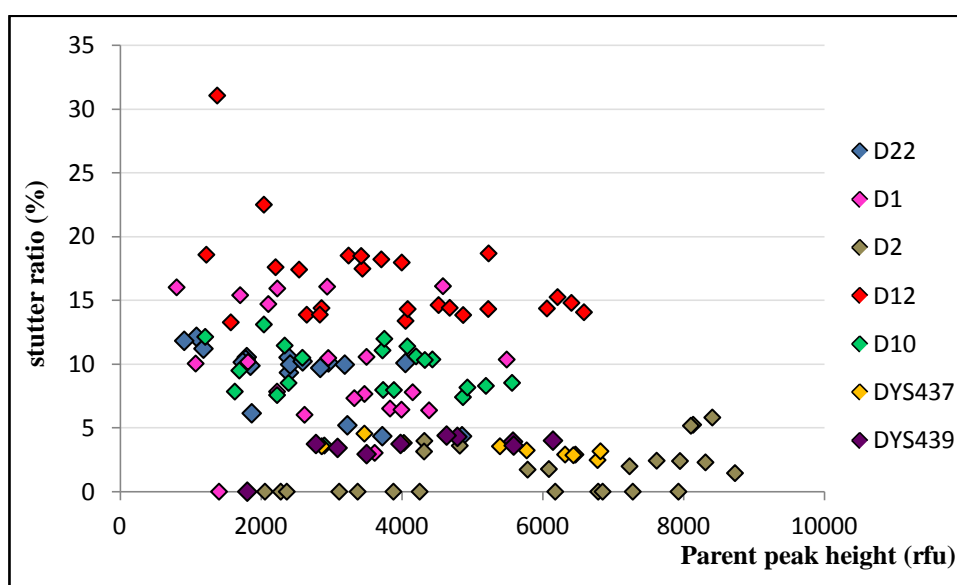


Figure 5.37. Stutter peak height ratio for five autosomal STR and two Y-STR loci.

### 5.3.5 Mock crime scene samples-direct PCR

Samples F1 to F12 were bloodstained FTA cards obtained from CTS from 2006 to 2008. The FTA samples were first amplified in a direct PCR approach but this did not yield any results. The FTA samples which were incubated with 200  $\mu$ L of sterile distilled water at 56°C for 30 min yield full profiles for all FTA samples tested. TPH and PHR were calculated for all the FTA samples. TPH was calculated by cumulating peak heights for the five STR loci in the multiplex, while IPC PHR was calculated by taking a ratio of IPCII over IPCI. TPH and IPC PHR for all the FTA samples tested are shown in Table 5.16.

**Table 5.16. Percentage Profile (%P), Total peak height (TPH) and IPC peak height ratio (IPC PHR) for FTA samples.**

Sample ID	% P	TPH (rfu)	IPC PHR
F1	100	25164	0.37
F2	100	19354	0.36
F3	100	27147	0.27
F4	100	20391	0.31
F5	100	15256	1.02
F6	100	15784	0.87
F7	100	25875	1.07
F8	100	16096	0.64
F9	100	20657	0.69
F10	100	15216	1.16
F11	100	30224	0.55
F12	100	38345	0.21

No peaks, including the IPC fragments, were detected in the DNA profiles when the FTA cards were amplified prior to washing. This would suggest the presence of inhibitors in the sample rather than failure in amplification as the positive control gave a full profile while the IPC fragments were present in the negative control. At

first it was thought that heme from the FTA cards were acting as inhibitors to PCR. During soaking of the FTA cards with dH<sub>2</sub>O, it was observed that the haem was not washed off and the water was still clear at the end of the incubation time. The FTA samples were still a reddish brown 'rusty colour' indicating the presence of haem on the samples. Upon amplification of these washed FTA cards, full DNA profiles were obtained from all the samples tested. This indicated that the inhibition to PCR prior to washing was not due to the haem, but other preservatives such as cell lyses agents, protein denaturants, and chemicals that protect DNA from nuclease and UV action, that are present on the FTA cards. Any one of these chemicals could have inhibited the amplification reaction.

Human blood consists of many components such as plasma, red blood cells and white blood cells, all of which have been found to inhibit PCR, both separately and collectively [84]. Besides the different components of blood, anticoagulants such as EDTA and heparin [301, 302] added as blood preservatives, and chemicals added to the FTA paper to preserve and lyses the cells [1] act as inhibitor to PCR. During the soaking of FTA paper in water, all the different chemicals present on the FTA paper would have solubilised in the water and thus freeing the sample of most of the inhibitors.

All the washed FTA cards tested gave 100% profile. The peak heights of the alleles between the samples varied but this was to be expected as there was no prior knowledge on the volume and amount of DNA on the FTA cards. FTA paper is known to produce consistent results without the need for quantification [1]. No off-scale alleles were observed in the DNA profiles and all alleles were above 500 rfu.

The IPC PHR varied between 0.2 to about 1.1. There was a negative non-linear correlation between TPH and IPC (Pearson's  $r$  -0.572;  $p$ -value 0.052) indicating that when one of the values is high the other is low. Despite that, the correlation doesn't indicate which value is affecting the drop or increase in the other.

In all, 19 mock crime scene samples were tested which were from unknown stains, bloodstains, semen stains, saliva on a variety of substrates and cigarette butt. Out of the 19 stains tested, 5 were mixtures and were not included in the results for the single source DNA profiles tabulated in Table 5.17.

Half of the single source DNA profiles produced full DNA profiles ranging from 9600 to 31100 rfu in TPH. Two samples, C2 and C14, were observed to have one allele dropped out, which was the IPCII fragment while sample C21 only had one observed allele, which was the IPCI fragment. No alleles were observed with samples C4 and C10.

There was a positive correlation between %P and TPH (Pearson's  $r = 0.75$  p-value 0.002), when %P is high, TPH is also high. This was as expected as the %P is dependent on the peak heights of the alleles. With Pearson's correlation, it cannot be concluded that there was no correlation between IPC PHR with %P and TPH.

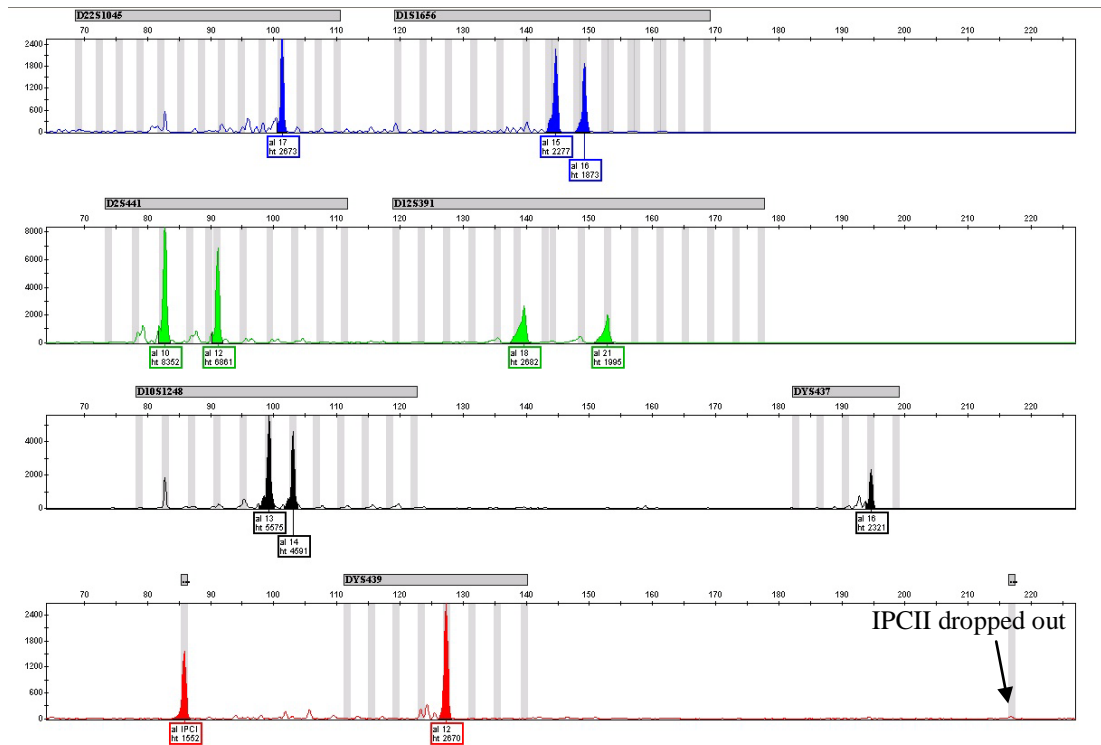
**Table 5.17. Percentage profile (%P), Total peak height (TPH) and peak height ratio of IPC fragments (IPC PHR) obtained from mock crime scene samples.**

<b>Sample ID</b>	<b>% P</b>	<b>TPH (rfu)</b>	<b>IPC PHR</b>
<b>C1</b>	100	16445	0.12
<b>C2</b>	92	36979	0
<b>C3</b>	100	17519	0.19
<b>C4</b>	0	0	0.46
<b>C6</b>	100	22458	0.26
<b>C7</b>	100	24715	0.19
<b>C8</b>	100	31124	0.11
<b>C10</b>	0	0	0
<b>C13</b>	100	17453	0.19
<b>C14</b>	92	20300	0
<b>C15</b>	100	9603	0.94
<b>C19</b>	75	2238	1.57
<b>C20</b>	75	15136	0
<b>C21</b>	8	0	0

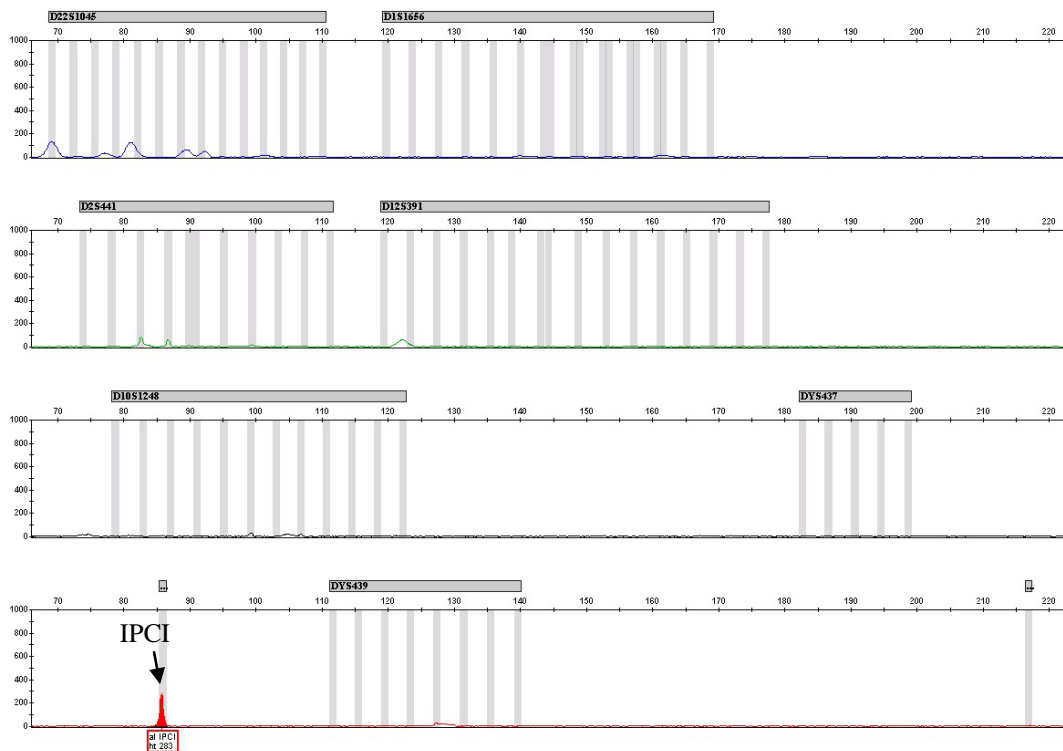
From the data obtained, it was observed that the first peak to drop out in mock crime scene samples was the IPCII fragment. All samples except C15 and C19 had IPC PHR of 0.46 and below. The reason for this imbalance was the reduction in peak height of the IPCII fragment which could be due to the presence of inhibitors in the sample. Since the IPCII fragment was the largest fragment in the multiplex, this fragment was thought to be most susceptible to the presence of inhibitors. This theory was collaborated by the findings of Zahra *et al.* [91]. In some samples like C2, the IPCII fragment dropped out but all the other alleles were detected above 2000 rfu, indicating that the inhibitors were not affecting the amplification efficiency of the other primers (Figure 5.38). The IPCI fragment demonstrated to be the last peak to drop out, as was observed with sample C21. C21 is a cigarette butt sample which has compounds that causes inhibitions during amplification. This proves that



the IPC fragments in the multiplex are able to identify the presence of inhibitors in the sample and differentiate between a 'no profile' obtained due to insufficient template DNA and those obtained due to the effects of inhibition.



**Figure 5.38. Electropherogram obtained from sample C2, showing a dropout of the IPCII fragment indicating the presence of inhibitors. Other alleles in the profile were not affected.**



**Figure 5.39. Electropherogram obtained from sample C21 showing that the last peak to drop out in a inhibited profile is the IPCI fragment.**

No TPH was recorded for samples C4 and C10 because no alleles were detected in both these DNA profiles. However, C4 was observed to have both the IPC fragments which were not present in C10. It is very likely that the no profile in C4 was caused by a combination of very low levels of DNA and possibly the presence of low levels of inhibitors which was observed by the IPC PHR of 0.46. In contrast to C4, the absence in DNA profile in C10 is most likely due to the presence of high levels of inhibitors because of the drop outs in both the IPC fragments. Without the inclusion of the IPC fragments in this multiplex, the absence of peaks in the DNA profile from both these samples could not have been distinguished.

Once it has been determined that the no profile is caused by inhibitors rather than low levels of target DNA by observing the peak heights of the IPC fragments, the next step of action to process the samples correctly can be taken. In cases of no profile where IPC fragments are present, it can be said that the no profile is the result of insufficient levels of target DNA and no further steps to obtain DNA profile needs

to be carried out. In cases where all peaks including the IPC fragments are not observed in the DNA profiles, the sample can be extracted or purified prior to amplification to wash away the inhibitors.

The mock crime scene samples from more than one DNA donor were analysed separately to observe the ability of the multiplex to identify mixtures. The minimum number of contributors, the number of Y-STR alleles observed and the IPC peak height ratio (IPC PHR) are shown in Table 5.18. The minimum number of contributors was determined by the number of maximum alleles that are present at a locus. For example, if there were a maximum of 4 alleles in any locus, the minimum possible contributors to the DNA profile would be 2.

**Table 5.18. The minimum number of contributors, the number of Y-STR alleles observed and the IPC PHR for samples with mixtures.**

<b>Sample ID</b>	<b>Min. Contributors</b>	<b>Y-STR alleles</b>	<b>IPC PHR</b>
<b>C5</b>	2	1	0.15
<b>C9</b>	2	1	0.11
<b>C12</b>	2	0	0.25
<b>C16</b>	2	1	0.15
<b>C18</b>	2	2	0.24

The results obtained from the mixture stains are tabulated in Table 5.18. The number of Y-STR alleles in a mixture can help determine the number of female and male contributors. In samples C5, C9 and C16, the possible number of contributors to the DNA profile was 2 and there was only one Y-STR allele observed in the profile. This could either mean that there were one male and one female contributor, or there were 2 male contributors who were from the same paternal lineage. In sample C12, there were two possible contributors but there were no Y-STR alleles observed, which means that there were two female contributors to the DNA profile. In sample C18,

from 2 possible contributors, both the contributors are identified as males as there were 2 Y-STR alleles detected at each locus. By having simultaneous amplification of STR and Y-STR loci, the number of male-female contributors could easily be identified.

#### **5.4 Conclusion**

No reports have been found so far on the development of a multiplex kit which has been designed and validated with a combination of autosomal STRs, Y-STRs and two fragments of IPCs which is suitable to be used with direct PCR. This multiplex has shown excellent sensitivity, down to 25 pg of DNA, which is four times more sensitive than other commercially available multiplexes in the market. This multiplex is also sufficiently robust, being able to amplify blood and semen stains that have not been extracted and purified of inhibitors.

Seeing the benefits of this multiplex, it could be a cheaper alternative to amplify crime scene samples that have failed to provide a DNA profile from other validated multiplex kits. Being able to amplify samples without having to prior extract and quantify would be an added benefit as a screening step, whereby the multiplex can be used to amplify 'fast track' samples. Fast tracking in forensic DNA profiling is used when information is needed urgently for investigative purposes. By using direct PCR with this multiplex, amplification and electrophoresis can be completed within 2 hr. This enables information regarding the DNA profile to be shared with crime investigators faster than using standard DNA profiling protocol. In addition, this multiplex can be used for obtaining additional information such as number of male-female contributors in a mixture and to screen the Y-STR allele designations. A non-match at the two Y-STR loci between an unknown and a known profile could be quickly identified, while a match at the two loci could be investigated further by amplifying the sample with other commercially available kits. This multiplex should also be able to amplify degraded DNA better than other multiplexes like SGMPlus due to the miniSTR primers used. Therefore, it can be used as an alternative to other Mini-STR kits like MiniFiler which are expensive. Finally it can also be used as a

cheaper alternative to provide supplementary allele information for laboratories where SGMPlus or PowerPlex 16 is used routinely for crime scene or processing database samples. The additional allele information obtained from this multiplex could be used for exchange of information as agreed upon during the Prüm convention between EU countries.

However, there are a couple of limitations to this multiplex. It was not able to amplify FTA samples without a prior washing step with water. Although this extra step would involve increasing the total time of obtaining a DNA profile by 30 min, the addition of a washing step did improve the quality of the DNA profile obtained and did not involve any expensive chemicals. It is still an advantage over other multiplex kits where FTA purification needs to be carried out involving chemicals and purification kits.

Another limitation of this multiplex is the number of loci incorporated. Only five autosomal STR loci could be included in the multiplex due to size restrictions. As all the loci in the multiplex are less than 200 bp, only a limited number of primer could be incorporated without the use mobility modifiers, where the use is restricted due to patents. Therefore, the multiplex does not have a high power of discrimination such as the likes of other kits which amplify 15 autosomal STRs simultaneously.

More work can be carried out with this multiplex to further evaluate its performance. Crime scene samples of various nature, such as soiled garments, swabs of touch DNA from various handled items, and degraded samples from bones and environmental exposed samples could be subjected to amplification with this multiplex to further evaluate its performance capabilities.

## 6 General discussion and conclusion

Direct PCR has been used in microbiology since 1989, where it was more commonly known as colony PCR [69]. Since then, direct PCR has been widely used in many other applications such as medical genetics and molecular biology for rapid diagnosis of infection or screening for the success of ligation for genes of interest in plasmids. The use of direct PCR has been proven successful in these applications as rapid diagnosis is often crucial for the determination of treatments.

After about 20 years being used in other fields, report of using direct PCR for database samples was first published in December 2009 [77]. Since then, the sudden explosion of commercial kits available in the market for direct PCR in recent years goes to show that there has been a significant demand for rapid analysis of forensic samples. It also indicates that direct PCR as a technique has the potential for further application and development in the field of forensic science.

The primary question that needs addressing is '*why is there a need for direct PCR in forensic DNA analysis?*' The ever growing number of samples being submitted for DNA analysis coupled with the current economic climate has generated a dire need for '*faster, cheaper and better*' forensic science which can be accomplished with direct PCR. The advantages of using direct PCR are as follows:

- *Faster*- The omission of the extraction and quantification steps reduces the overall time it takes to generate a DNA profile
- *Cheaper*- The costs involved in purchasing expensive extraction and quantification kits can be reduced when using direct PCR
- *Better*- Better DNA profiles could be obtained by using direct PCR because there is no loss of DNA associated with extraction protocols.

The second question asked which was addressed in this study was ‘*how does direct PCR compare to standard DNA profiling protocols?*’ DNA profiles obtained using direct PCR consistently better than those obtained via standard DNA profiling protocols. Significant loss of DNA was observed with extracted samples, which was attributed to DNA being washed away during sample purification or DNA adhering to the walls of the many polypropylene tubes used or a combination of both these factors. There was also an instance where it was thought that metallic ions swabbed off with recovered DNA from stainless steel may have caused loss of DNA by interrupting the adsorption of DNA to the silica membrane, thereby increasing the amount of DNA washed away during extraction. This further emphasises the benefits of using direct PCR for samples rather than standard DNA profiling protocols.

Successful amplification was carried out with genomic DNA, buccal cells, bloodstains, semen stains, fingerprints and touch DNA using direct PCR, regardless of the type of substrate the DNA was deposited on. However, the success of direct PCR did depend on the type of amplification kit used, whereby SGMPlus which lacks the benefits of improved polymerase-buffer systems, did not perform as well as newer kits like PowerPlex 16 HS.

It was also observed that the type of substrate DNA is deposited on affects the recovery of DNA but not the amplification efficiency. The recovery of DNA from substrates is dependent on the physical characteristics of the substrate (hydrophobic or hydrophilic), affinity of DNA to recovery medium (cotton swab or nylon flocked swab), ionic strength (low or high ionic strength) and pH (acidic or basic) of the recovery solution. Altering the ionic strength or pH of the solution, for example, could affect the interaction between DNA and surface of the substrate, thus would determine if DNA could be easily lifted from the substrate surface. Although a small number of substrates were used in this study, the information obtained was sufficient to conclude that the recovery method and medium used is substrate dependent but more studies needs to be carried out to evaluate which recovery method is best suited for a given substrate.

The development and validation of a novel multiplex in this study addresses the issues encountered with other multiplex kits when used with direct PCR. This new multiplex was more sensitive, robust and was able to provide information regarding the inhibitor status of the sample, which was not possible with other commercial multiplex kits. Such a kit was ideal to be used with direct PCR samples as it could distinguish between 'no profile' caused by insufficient DNA template and those caused by the presence of inhibitors.

One of the disadvantages of using direct PCR is that the amount of DNA present in a sample is not known, therefore could suffer from artefacts associated with increased sample concentration. This may not be such an issue with low template DNA where the amount of DNA is very low, but with biological stains, this could be a problem if too much DNA is amplified. As observed in this study, only a very small amount of material is required (1 strand of bloodstained fibre) for successful amplification with direct PCR, therefore, by limiting the amount of sample, the problem of over amplification was solved. The issue of insufficient addition of sample with body fluids was not encountered throughout this study.

Another limitation of implementing direct PCR for forensic casework is that every time there is a need for reanalyses of a particular sample, the evidence material or the original sample has to be retrieved for a portion of it to be cut out for PCR. In addition, chain of custody forms has to be filled out every time the evidence materials are taken out of storage, especially if different people are involved with the analyses. This could introduce added time into the entire process. For large items like garments, the exact area which has come in contact with the victim or perpetrator could be difficult to identify and therefore the area where the fibres should be recovered for PCR could prove to be difficult. In circumstances such as these, it would be recommended that the garment is swabbed and a portion of the swab be subjected to direct PCR for a better chance of obtaining a DNA profile.



The use of the direct PCR multiplex developed in this study also has limitations in its application in forensic case work. It has to be emphasised that the development of this multiplex was not to substitute the use of commercial multiplexes which have undergone extensive validation, but rather to provide supplementary information on the five new ESS loci, Y-STR allele designation and inhibitor status of the samples, that current commercial multiplex systems are unable to provide in a single amplification. The five autosomal STR markers in the multiplex would not provide sufficient discriminatory power on its own, but in combination with other 9 and 15 STR multiplex systems, it could provide sufficient power of discrimination for paternity and criminal cases where added loci information is required.

### **6.1 Recommendations for future work**

A number of issues have been identified throughout the duration of carrying out the work described in this thesis which paves the way for more studies and experimentation.

One such study involves the interaction of DNA with various substrates. Although some literature acknowledges the fact that there is interaction at the molecular level between DNA and various substrates [176, 303], not many have come up with how the interaction happens. Determining the mechanism of interaction may be essential in finding out what is the best method to recover DNA from a given substrate. In forensic DNA profiling, efficient recovery of DNA from substrates is a key determining factor for the success rate of obtaining DNA profiles, therefore, more studies should be carried out in terms of the recovery medium and the type of moisturiser used to recover DNA which is dependent on the substrate the DNA is deposited on.

With the development of the new multiplex incorporating the new ESS loci, existing population databases can be expanded to include the new ESS loci and to determine allele frequencies of these loci in the population. Currently, existing population databases around the South East Asian region are compiled using older multiplex kits

such as SGMPlus, Identifiler and PowerPlex 16. This new multiplex system could offer a cheaper alternative to commercially available multiplex kits to further expand the population databases to include the new ESS loci.

## 7 References

1. J.M. Butler, ed. *Fundamentals of Forensic DNA typing*. 2010, Academic Press: MA.
2. S. Aldridge, *DNA is life's blueprint*, in *The thread of life: the story of genes and genetic engineering*. 1996, Cambridge University Press: Cambridge, UK.
3. S. Rollié, M. Mangold, and K. Sundmacher, *Designing biological systems: Systems Engineering meets Synthetic Biology*. Chemical Engineering Science, 2012. **69**(1): p. 1-29.
4. E. Chargaff, *Chemical specificity of nucleic acids and mechanism of their enzymatic degradation*. Cellular and Molecular Life Sciences, 1950. **6**(6): p. 201-209.
5. A.J. Jeffreys, V. Wilson, and S.L. Thein, *Individual-specific 'fingerprints' of human DNA*. Nature, 1985. **316**(6023): p. 76-79.
6. A. Edwards, H.A. Hammond, L. Jin, *et al.*, *Genetic variation at five trimeric and tetrameric tandem repeat loci in four human population groups*. Genomics, 1992. **12**(2): p. 241-253.
7. A. Edwards, A. Civitello, H.A. Hammond, *et al.*, *DNA Typing and Genetic-Mapping with Trimeric and Tetrameric tandem repeats*. American Journal of Human Genetics, 1991. **49**(4): p. 746-756.
8. J.D. Wren, E. Forgacs, J.W. Fondon Iii, *et al.*, *Repeat Polymorphisms within Gene Regions: Phenotypic and Evolutionary Implications*. The American Journal of Human Genetics, 2000. **67**(2): p. 345-356.
9. H. Ellegren, *Microsatellites: simple sequences with complex evolution*. Nat Rev Genet, 2004. **5**(6): p. 435-445.
10. A. Urquhart, C.P. Kimpton, T.J. Downes, *et al.*, *Variation in Short Tandem Repeat sequences —a survey of twelve microsatellite loci for use as forensic identification markers*. International Journal of Legal Medicine, 1994. **107**(1): p. 13-20.
11. N. Morral and X. Estivill, *Multiplex PCR Amplification of 3 Microsatellites within the CFTR Gene*. Genomics, 1992. **13**(4): p. 1362-1364.

12. J.E. Lygo, P.E. Johnson, D.J. Holdaway, *et al.*, *The Validation of Short Tandem Repeat (STR) Loci for use in Forensic Casework*. International Journal of Legal Medicine, 1994. **107**(2): p. 77-89.
13. Sullivan K.M., Pope S., Gill P., *et al.*, *Automated DNA profiling by fluorescent labelling of PCR products*. PCR Methods Application, 1992. **2**: p. 34-40.
14. J.S. Ziegle, Y. Su, K.P. Corcoran, *et al.*, *Application of a Automated DNA Sizing Technology for Genotyping Microsatellite Loci*. Genomics, 1992. **14**(4): p. 1026-1031.
15. C.J. Fregeau and R.M. Fourney, *DNA Typing with Fluorescently Tagged Short Tandem Repeats- A Sensitive and Accurate Approach to Human Identification*. BioTechniques, 1993. **15**(1): p. 100-119.
16. R. Sparkes, C. Kimpton, S. Watson, *et al.*, *The validation of a 7-locus multiplex STR test for use in forensic casework .1. Mixtures, ageing, degradation and species studies*. International Journal of Legal Medicine, 1996. **109**(4): p. 186-194.
17. R. Sparkes, C. Kimpton, S. Gilbard, *et al.*, *The validation of a 7-locus multiplex STR test for use in forensic casework .2. Artefacts, casework studies and success rates*. International Journal of Legal Medicine, 1996. **109**(4): p. 195-204.
18. E.A. Cotton, R.F. Allsop, J.L. Guest, *et al.*, *Validation of the AMPFISTR® SGM Plus™ system for use in Forensic casework*. Forensic Science International, 2000. **112**: p. 151-161.
19. Technical Working Group on DNA Analysis Methods, *Guidelines for a quality assurance program for DNA analysis*. Crime Lab. Digest., 1995. **22**: p. 21-43.
20. Applied Biosystems, *AmpFISTR SGM Plus™ PCR Amplification Kit User's Manual*. . 1999: Applied Biosystems.
21. J.M. Butler, *Forensic DNA Typing*. 2005: Academic Press.
22. E.K. Hanson and J. Ballantyne, *A highly discriminating 21 locus Y-STR "megaplex" system designed to augment the minimal haplotype loci for forensic casework*. Journal of Forensic Sciences, 2004. **49**(1): p. 40-51.

23. R.A. Wickenheiser, *Trace DNA: A Review, Discussion of Theory, and Application of the Transfer of Trace Quantities of DNA Through Skin Contact*. Journal of Forensic Science, 2002. **47**(3): p. 442-450.
24. M. Benecke, *Forensic DNA samples-Collection and Handling*, in *Encyclopedia of Medical Genomics and Proteomics*, J. Fuchs and M. Podda, Editors. 2005, Marcel Dekker, Inc.: New York. p. 4.
25. L. Smith and L. Burgoyne, *Collecting, archiving and processing DNA from wildlife samples using FTA(R) databasing paper*. BMC Ecology, 2004. **4**(1): p. 4.
26. P.S. Walsh, D.A. Metzger, and R. Higuchi, *Chelex-100 as a Medium for Simple Extraction of DNA for PCR-Based Typing from Forensic Material*. BioTechniques, 1991. **10**(4): p. 506-513.
27. L. Cler, D. Bu, C. Lewis, *et al.*, *A comparison of five methods for extracting DNA from paucicellular clinical samples*. Molecular and Cellular Probes, 2006. **20**: p. 191-196.
28. A. Barbaro, N. Staiti, P. Cormaci, *et al.*, *DNA profiling by different extraction methods*. International Congress Series, 2004. **1261**: p. 562-564.
29. K. Mullis, F. Faloona, S. Scharf, *et al.*, *Specific enzymatic amplification of DNA in vitro: the polymerase chain reaction*. Cold Spring Harb Symp Quant Biol, 1986. **51 Pt 1**: p. 263-73.
30. K.B. Mullis and F.A. Faloona, *Specific synthesis of DNA in vitro via a polymerase-catalyzed chain reaction*. Methods Enzymol, 1987. **155**: p. 335-50.
31. R.K. Saiki, D.H. Gelfand, S. Stoffel, *et al.*, *Primer-Directed Enzymatic Amplification of DNA with a thermostable DNA-polymerase*. Science, 1988. **239**(4839): p. 487-491.
32. P. Frame. *Ten things that can kill your PCR*. 2010 [cited 11 March 2012]; Available from: <http://www.biosyn.com/tew.aspx?qid=219>.
33. D.E. Birch, L. Kolmodin, W.J. Laird, *et al.*, *Simplified hot start PCR*. Nature, 1996. **381**(6581): p. 445-446.

34. W. Goodwin, A. Linacre, and S. Hadi, *An Introduction to Forensic Genetics*. 2007, West Sussex, England: John Wiley & Sons, Ltd. 151.
35. C.P. Kimpton, N.J. Oldroyd, S.K. Watson, *et al.*, *Validation of highly discriminating multiplex short tandem repeat amplification systems for individual identification*. *Electrophoresis*, 1996. **17**(8): p. 1283-1293.
36. Life Technologies. *DNA sequencing & fragment analysis by capillary electrophoresis*. Applications & technologies 2011 [cited 28th March 2012]; Available from: <http://www.appliedbiosystems.com/absite/us/en/home/applications-technologies/dna-sequencing-fragment-analysis.html>.
37. P.S. Walsh, N.J. Fildes, and R. Reynolds, *Sequence analysis and characterization of stutter products at the tetranucleotide repeat locus vWA*. *Nucleic Acids Research*, 1996. **24**(14): p. 2807-2812.
38. X.Y. Hauge and M. Litt, *A Study Of the Origin of shadow bands seen when typing Dinucleotide Repeat Polymorphisms by the PCR*. *Human Molecular Genetics*, 1993. **2**(4): p. 411-415.
39. C. Schlotterer and D. Tautz, *Slippage synthesis of simple sequence DNA*. *Nucleic Acids Research*, 1992. **20**(2): p. 211-215.
40. P. Gill, R. Sparkes, and C. Kimpton, *Development of guidelines to designate alleles using an STR multiplex system*. *Forensic Science International*, 1997. **89**(3): p. 185-197.
41. J.M. Clark, *Novel Non-Templated Nucleotide Addition-Reactions Catalyzed by Procaryotic and Eukaryotic DNA-Polymerases*. *Nucleic Acids Research*, 1988. **16**(20): p. 9677-9686.
42. K. Tsukada, K. Takayanagi, H. Asamura, *et al.*, *Multiplex short tandem repeat typing in degraded samples using newly designed primers for the TH01, TPOX, CSF1PO, and vWA loci*. *Legal Medicine*, 2002. **4**(4): p. 239-245.
43. P. Wiegand and M. Kleiber, *Less is more – length reduction of STR amplicons using redesigned primers*. *International Journal of Legal Medicine*, 2001. **114**(4): p. 285-287.

44. Thanakiatkrai P., *Effects of increased PCR cycles and varying injection times on STR profile quality*, in *Pure and Applied Chemistry*. 2007, University of Strathclyde: Glasgow, Scotland.
45. P. Gill, J. Whitaker, C. Flaxman, *et al.*, *An investigation of the rigor of interpretation rules for STRs derived from less than 100 pg of DNA*. *Forensic Science International*, 2000. **112**: p. 17-40.
46. J. Buckleton, *Validation issues around DNA typing of low level DNA*. *Forensic Science International: Genetics*, 2009. **3**(4): p. 255-260.
47. P. Gill, *Application of Low Copy Number DNA Profiling*. *Croatian Medical Journal*, 2001. **42**: p. 229-232.
48. Applied Biosystems (2010) *AmpFISTR SGM Plus PCR Amplification kit User's manual*.
49. C.M. Strom and S. Rechitsky, *Use of Nested PCR to Identify Charred Human Remains and Minute Amounts of Blood*. *Journal of Forensic Science*, 1998. **43**(3): p. 696-700.
50. E.K. Hanson and J. Ballantyne, *Whole genome amplification strategy for forensic genetic analysis using single or few cell equivalents of genomic DNA*. *Analytical Biochemistry*, 2005. **346**: p. 246-257.
51. M. Prinz, L. Schiffner, J.A. Sebestyen, *et al.*, *Maximization of STR DNA typing success for touched objects*. *International Congress Series*, 2006. **1288**: p. 651-653.
52. L. Forster, J. Thomson, and S. Kutranov, *Direct comparison of post-28-cycle PCR purification and modified capillary electrophoresis methods with the 34-cycle "low copy number" (LCN) method for analysis of trace forensic DNA samples*. *Forensic Science International-Genetics*, 2008. **2**(4): p. 318-328.
53. C. Strom, S. Rechitsky, G. Wolf, *et al.*, *Reliability of polymerase chain reaction (PCR) analysis of single cells for preimplantation genetic diagnosis*. *Journal of Assisted Reproduction and Genetics*, 1994. **11**(2): p. 55-62.
54. A. Olmos, O. Esteban, E. Bertolini, *et al.*, *Nested RT-PCR in a single closed tube*, in *PCR Protocols: Methods in Molecular Biology*, J.M.S. Bartlett and D. Stirling, Editors. 2003, Humana Press: Totowa, New Jersey. p. 151-159.

55. P. Gill, P.L. Ivanov, C. Kimpton, *et al.*, *Identification of the remains of the Romanov family by DNA analysis*. *Nat Genet*, 1994. **6**(2): p. 130-135.
56. R.K. Farnen, R. Jaghø, P. Cortez, *et al.*, *Assessment of individual shedder status and implication for secondary DNA transfer*. *Forensic Science International: Genetics Supplement Series*, 2008. **1**(1): p. 415-417.
57. A. Barbaro, P. Cormaci, C. Binns, *et al.*, *Hair typing in a cold case*. *Forensic Science International: Genetics Supplement Series*, 2008. **1**(1): p. 396-397.
58. S. Petricevic, J. Whitaker, J. Buckleton, *et al.*, *Validation and development of interpretation guidelines for low copy number (LCN) DNA profiling in New Zealand using the AmpFlSTR® SGM Plus™ multiplex*. *Forensic Science International: Genetics*, 2010. **4**(5): p. 305-310.
59. P. Gill, R. Sparkes, R. Pinchin, *et al.*, *Interpreting simple STR mixtures using allele peak areas*. *Forensic Science International*, 1998. **91**(1): p. 41-53.
60. K.N. Ballantyne, R.A.H.v. Oorschot, and R.J. Mitchell, *Comparison of two whole genome amplification methods for STR genotyping of LCN and degraded DNA samples*. *Forensic Science International*, 2007. **166**: p. 35-41.
61. P.J. Smith and J. Ballantyne, *Simplified Low-Copy-Number DNA Analysis by Post-PCR Purification*. *Journal of Forensic Science*, 2007. **52**(4): p. 820-829.
62. P. Gill and J. Buckleton, *A universal strategy to interpret DNA profiles that does not require a definition of low-copy-number*. *Forensic Science International: Genetics*, 2010. **4**(4): p. 221-227.
63. BBC News. *DNA test halted after Omagh case*. 2007 [cited 31st March 2012]; Available from: <http://news.bbc.co.uk/1/hi/uk/7156051.stm>.
64. B. Budowle, A.J. Eisenberg, and A. van Daal, *Validity of Low Copy Number Typing and Applications to Forensic Science*. *Croatian Medical Journal*, 2009. **50**(3): p. 207-217.
65. B. Budowle, A.J. Eisenberg, and A. van Daal, *Low copy number typing has yet to achieve "general acceptance"*. *Forensic Science International: Genetics Supplement Series*, 2009. **2**(1): p. 551-552.
66. B. Budowle and A. van Daal, *Reply to Comments by Buckleton and Gill on "Low copy number typing has yet to achieve 'general acceptance'"* by



- Budowle, B., et al., 2009. *Forensic Sci. Int.: Genet. Suppl. Series 2*, 551–552. *Forensic Science International: Genetics*, 2011. **5**(1): p. 12-14.
67. S. Cowen, P. Debenham, A. Dixon, et al., *An investigation of the robustness of the consensus method of interpreting low-template DNA profiles*. *Forensic Science International: Genetics*, 2011. **5**(5): p. 400-406.
68. J. Buckleton and P. Gill, *Further Comment on “Low copy number typing has yet to achieve “general acceptance””, by Budowle, B., et al, 2009. Forensic Sci. Int. Genetics: Supplement Series 2, 551–552*. *Forensic Science International: Genetics*, 2011. **5**(1): p. 7-11.
69. L.I. Zon, D.M. Dorfman, and S.H. Orkin, *The polymerase chain reaction colony miniprep*. *Biotechniques*, 1989. **7**(7): p. 696-698.
70. I. Maciver. *Colony PCR: Another use for toothpicks*. 2010 [cited 2nd April 2012]; Available from: <http://promega.wordpress.com/2010/07/26/colony-pcr-another-use-for-toothpicks/>.
71. P.E.J. Saris, L.G. Paulin, and M. Uhlén, *Direct amplification of DNA from colonies of Bacillus subtilis and Escherichia coli by the polymerase chain reaction*. *Journal of Microbiological Methods*, 1990. **11**(2): p. 121-126.
72. J.H. Tjhie, F.J.v. Kuppeveld, R. Roosendaal, et al., *Direct PCR enables detection of Mycoplasma pneumoniae in patients with respiratory tract infections*. *J clin Microbiol.*, 1994. **32**(1): p. 11-16.
73. A.J. van den Brule, C.J. Meijer, V. Bakels, et al., *Rapid detection of human papillomavirus in cervical scrapes by combined general primer-mediated and type-specific polymerase chain reaction*. *Journal of Clinical Microbiology*, 1990. **28**(12): p. 2739-2743.
74. M. Kuwayama, N. Shigemoto, S. Oohara, et al., *Simultaneous detection of virulence factors from a colony in diarrheagenic Escherichia coli by a multiplex PCR assay with Alexa Fluor-labeled primers*. *Journal of Microbiological Methods*, 2011. **86**(1): p. 119-120.
75. R. Sharma, V. Kumar, T. Mohapatra, et al., *A Simple and Non-destructive Method of Direct-PCR for Plant Systems*. *Journal of Plant Biology*, 2012. **55**(2): p. 114-122.

76. H.J. Rogers and H.C. Parkes, *Direct PCR amplification from leaf discs*. Plant Science, 1999. **143**(2): p. 183-186.
77. D.Y. Wang, C.-W. Chang, N.J. Oldroyd, *et al.*, *Direct amplification of STRs from blood or buccal cell samples*. Forensic Science International: Genetics Supplement Series, 2009. **2**(1): p. 113-114.
78. D. Wieczorek and B.E. Krenke. *Direct Amplification from Buccal and Blood Samples Preserved on Cards Using the PowerPlex<sup>®</sup> 16 HS System*. 2009 [cited 2nd April 2012]; Available from: <http://www.promega.com/resources/articles/profiles-in-dna/2009/direct-amplification-from-buccal-and-blood-samples-preserved-on-cards-using-powerplex-16-hs/>.
79. R. Roy. *STR Typing from Bloodstained Fabric without DNA Extraction*. in *Proceedings of the 11th International Symposium on Human Identification*. 2000. Biloxi, Mississippi.
80. Y.G. Yang, J.Y. Kim, Y.-H. Song, *et al.*, *A novel buffer system, AnyDirect, can improve polymerase chain reaction from whole blood without DNA isolation*. Clinica Chimica Acta, 2007. **380**(1-2): p. 112-117.
81. S. Verheij, J. Harteveld, and T. Sijen, *A protocol for direct and rapid multiplex PCR amplification on forensically relevant samples*. Forensic Sci Int Genet, 2011. **In Press**.
82. A.M. Hossain, B. Rizk, A. Behzadian, *et al.*, *Modified guanidinium thiocyanate method for human sperm DNA isolation*. Molecular Human Reproduction, 1997. **3**(11): p. 953-956.
83. M.L. Meistrich, B.O. Reid, and W.J. Barcellona, *Meiotic DNA synthesis during mouse spermatogenesis*. The Journal of Cell Biology, 1975. **64**(1): p. 211-222.
84. W.A. Al-Soud, L.J. Jonsson, and P. Radstrom, *Identification and Characterization of Immunoglobulin G in Blood as a Major Inhibitor of Diagnostic PCR*. J. Clin. Microbiol., 2000. **38**(1): p. 345-350.
85. W.A. Al-Soud and P. Radstrom, *Purification and Characterization of PCR-Inhibitory Components in Blood Cells*. J. Clin. Microbiol., 2001. **39**(2): p. 485-493.

86. Y.L. Tsai and B.H. Olson, *Rapid method for separation of bacterial DNA from humic substances in sediments for polymerase chain reaction*. Applied and Environmental Microbiology, 1992. **58**(7): p. 2292-2295.
87. R.J. Watson and B. Blackwell, *Purification and characterization of a common soil component which inhibits the polymerase chain reaction*. Canadian Journal of Microbiology, 2000. **46**(7): p. 633-642.
88. G.G. Shutler, P. Gagnon, G. Verret, *et al.*, *Removal of a PCR Inhibitor and Resolution from a Five Year Old Case DNA STR Types in Mixed Human-Canine Stains*. Journal of Forensic Science, 1999. **44**(3): p. 623-626.
89. A. Larkin and S.A. Harbison, *An improved method for STR analysis of bloodstained denim*. International Journal of Legal Medicine, 1999. **112**(6): p. 388-390.
90. J. Hedman, A. Nordgaard, C. Dufva, *et al.*, *Synergy between DNA polymerases increases polymerase chain reaction inhibitor tolerance in forensic DNA analysis*. Analytical Biochemistry, 2010. **405**: p. 192-200.
91. N. Zahra, S. Hadi, J.A. Smith, *et al.*, *Development of internal amplification controls for DNA profiling with the AmpFISTR SGMPlus kit*. Electrophoresis, 2011. **32**: p. 1371-1378.
92. Promega Corporation, *Technical Manual #TMD022 PowerPlex® 16 HS System*. 2009, Promega Corporation: 2800 Woods Hollow Road, Madison, WI.
93. D.Y. Wang, C.-W. Chang, R.E. Lagacé, *et al.*, *Development and Validation of the AmpFLSTR® Identifiler® Direct PCR Amplification Kit: A Multiplex Assay for the Direct Amplification of Single-Source Samples\**, †. Journal of Forensic Sciences, 2011. **56**(4): p. 835-845.
94. R. Weispenning, K. Oostdik, M. Ensenberger, *et al.*, *Doing more with less: Implementing direct amplification with the PowerPlex® 18D System*. Forensic Science International: Genetics Supplement Series, 2011. **3**(1): p. e409-e410.
95. Thermo Scientific, *Phusion blood Direct PCR kit*, in [http://www.finnzymes.com/pdf/f547\\_phusion\\_blood\\_direct\\_pcr\\_kit\\_proinfo\\_low.pdf](http://www.finnzymes.com/pdf/f547_phusion_blood_direct_pcr_kit_proinfo_low.pdf), Thermo Scientific, Editor. 2011, Thermo Scientific,.

96. L. Burgoyne. (1996). *Solid Medium and method for DNA storage*. U.S. Patent 5496562
97. L. Burgoyne, J. Kijas, P. Hallsworth, *et al.* *Safe collection, storage and analysis of DNA from blood*. in *Fifth International Symposium on Human Identification*. 1994. Scottsdale, Arizona.
98. P. Brito, V. Lopes, V. Bogas, *et al.*, *Amplification of non-FTA samples with AmpFlSTR® Identifiler® Direct PCR Amplification Kit*. Forensic Science International: Genetics Supplement Series, 2011. **3**(1): p. e371-e372.
99. Home Office Science Policy Unit, *Police Science Technology Strategy 2004-2009*. 2004, Home Office,.
100. J. Mennell and I. Shaw, *The Future of Forensic and Crime Scene Science: Part I. A UK forensic science user and provider perspective*. Forensic Science International, 2006. **157**, **Supplement**: p. S7-S12.
101. L.A. Schiffner, E.J. Bajda, M. Prinz, *et al.*, *Optimization of a Simple, Automatable Extraction Method to Recover Sufficient DNA from Low Copy Number DNA Samples for Generation of Short Tandem Repeat Profiles*. Croatian Medical Journal, 2005. **46**(4): p. 578-586.
102. J.J. Raymond, R.A.H. van Oorschot, P.R. Gunn, *et al.*, *Trace DNA success rates relating to volume crime offences*. Forensic Science International: Genetics Supplement Series, 2009. **2**(1): p. 136-137.
103. A. Linacre, V. Pekarek, Y.C. Swaran, *et al.*, *Generation of DNA profiles from fabrics without DNA extraction*. Forensic Science International: Genetics, 2010. **4**(2): p. 137-141.
104. C. Gaillard and F. Strauss, *Avoiding adsorption of DNA to polypropylene tubes and denaturation of short DNA fragments*. Technical Tips Online, 1998. **3**(1): p. 63-65.
105. N. Vandenberg, R.A.H. vanOorschot, and R.J. Mitchell. *An evaluation of selected DNA extraction strategies for short tandem repeat typing*. in *3rd International DNA Fingerprinting Conference*. 1996. Melbourne, Australia: Vch Publishers Inc.
106. US Department of Justice (2008) *Increasing Efficiency in Crime Laboratories* [www.ojp.usdoj.gov/nij](http://www.ojp.usdoj.gov/nij) 3.

107. Home Office. *DNA Expansion Program 2000-2005: reporting Achievement*. 2005 [cited 13th June 2012; Available from: <http://www.homeoffice.gov.uk/documents/DNAExpansion.pdf>]
108. J.K. Roman, S. Reid, J. Reid, *et al.*, *The DNA Field Experiment: Cost-Effectiveness analysis of the use of DNA in the investigation of high-volume crimes*. 2008, Urban Institute Justice Policy Center.
109. M. Nelson, *Making sense of DNA backlogs, 2010-Myths vs. reality*, in *NIJ Special Report*, J.H. Laub, Editor. 2011, U.S. Department of Justice: Washington, DC.
110. N. Tilley and A. Ford, *Forensic science and crime investigation*, in *Crime Detection and Prevention Series Paper 73*. 1996, Home Office: London.
111. B. Webb, C. Smith, A. Brock, *et al.*, *DNA fast-tracking*, in *Crime Science: New approaches to preventing and detecting crime*, M.J. Smith and N. Tilley, Editors. 2005, Willan Publishing: GB.
112. J.W. Bond and C. Hammond, *The Value of DNA Material Recovered from Crime Scenes*. *Journal of Forensic Science*, 2008. **53**(4): p. 797-801.
113. S. Chidzoy and P. Byrne. *Police cuts reduce forensic analysis, scientist claim*. 2011 [cited 13th June 2012; Available from: <http://www.bbc.co.uk/news/uk-england-12711273>].
114. Life Technologies. *PrepFiler Forensic DNA Extraction kit (100 extractions)*. [cited 13th June 2012]; Available from: <https://products.invitrogen.com/ivgn/product/4392353?ICID=search-product>.
115. Qiagen. *QIAamp DNA Micro Kit*. [cited 13th June 2012]; Available from: <http://www.qiagen.com/Products/GenomicDnaStabilizationPurification/QIAampSystem/QIAampDNAMicroKit.aspx?r=1392>.
116. Promega Corporation. *Plexor HY System*. [cited 13th June 2012]; Available from: <http://www.promega.com/products/genetic-identity/dna-quantitation-for-genetic-identity/plexor-hy-system/>.
117. Life Technologies. *Quantifiler Human DNA Quantification Kit*. [cited 13th June 2012]; Available from: <https://products.invitrogen.com/ivgn/product/4343895?ICID=search-product>.

118. Qiagen. *Investigator Quantiplex kit*. [cited 13th June 2012]; Available from: <http://www.qiagen.com/products/investigatorquantiplexkit.aspx>.
119. O. Hansson, M. Finnebraaten, I.K. Heitmann, *et al.*, *Trace DNA collection-- Performance of minitape and three different swabs*. Forensic Science International: Genetics Supplement Series, 2009. **2**(1): p. 189-190.
120. D. Sweet, J.A. Lorente, A. Valenzuela, *et al.*, *PCR-based DNA typing of saliva stains recovered from human skin*. Journal of Forensic Sciences, 1997. **42**(3): p. 447-451.
121. D. Sweet, M. Lorente, J.A. Lorente, *et al.*, *An improved method to recover saliva from human skin: The double swab technique*. Journal of Forensic Sciences, 1997. **42**(2): p. 320-322.
122. K.G. de Bruin, S.M. Verheij, M. Veenhoven, *et al.*, *Comparison of stubbing and the double swab method for collecting offender epithelial material from a victim's skin*. Forensic Science International: Genetics, Article in press. **10.1016/j.fsigen.2011.04.019**.
123. B.C.M. Pang and B.K.K. Cheung, *Double swab technique for collecting touched evidence* Legal Medicine, 2007. **9**: p. 181-184.
124. G.J. Copley, *New developments in glasses*. Materials Science and Engineering, 1971. **8**(1): p. 1-31.
125. B. Vogelstein and D. Gillespie, *Preparative and analytical purification of DNA from agarose*. Proceedings of the National Academy of Sciences, 1979. **76**(2): p. 615-619.
126. A. Carré, V. Lacarrière, and W. Birch, *Molecular interactions between DNA and an aminated glass substrate*. Journal of Colloid and Interface Science, 2003. **260**(1): p. 49-55.
127. O.Z. Nanassy, P.V. Haydock, and M.W. Reed, *Capture of genomic DNA on glass microscope slides*. Analytical Biochemistry, 2007. **365**(2): p. 240-245.
128. L.N. Daniel, Y. Mao, A.O. Williams, *et al.*, *Direct interaction between crystalline silica and DNA-a proposed model for silica carcinogenesis*. Scandinavian Journal of Work, Environment & Health, 1995. **21**(suppl 2): p. 22-26.

129. R.A. Van Wagenen, J.D. Andrade, and J.J.B. Hibbs, *Streaming Potential Measurements of Biosurfaces*. Journal of The Electrochemical Society, 1976. **123**(10): p. 1438-1444.
130. T.H. Nguyen, K.L. Chen, and M. Elimelech, *Adsorption kinetics and reversibility of linear plasmid DNA on silica surfaces: Influence of alkaline earth and transition metal ions*. Biomacromolecules, 2010. **11**: p. 1225-1230.
131. American Chemistry Council. *Lifecycle of a plastic product*. Plastic 101 2012 [cited 2012 22 January]; Available from: <http://plastics.americanchemistry.com/Life-Cycle>.
132. Y. Liu and C.B. Rauch, *DNA probe attachment on plastic surfaces and microfluidic hybridization array channel devices with sample oscillation*. Analytical Biochemistry, 2003. **317**(1): p. 76-84.
133. B.P. Belotserkovskii and B.H. Johnston, *Denaturation and Association of DNA Sequences by Certain Polypropylene Surfaces*. Analytical Biochemistry, 1997. **251**(2): p. 251-262.
134. B.P. Belotserkovskii, B.H. Johnston, C. Gaillard, *et al.*, *Polypropylene tube surfaces may induce denaturation and multimerization of DNA*. Science, 1996. **271**(5246): p. 222.
135. Ceramic Tile Institute of America. *Ceramic*. Glossary 2003 [cited 2012 11th February]; Available from: <http://www.ctioa.org>.
136. R.H. Doremus, *Alumina*, in *Ceramic and glass materials: Structure, properties and processing*, J.F. Shackelford and R.H. Doremus, Editors. 2008, Springer: New York, US. p. 1-26.
137. National Bureau of Standards, *Tarnishing of stainless steels*. Journal of the Franklin Institute, 1940. **229**(5): p. 646-647.
138. R. Alaeddini, *Forensic implications of PCR inhibition-A review*. Forensic Science International-Genetics, 2012. **6**(3): p. 297-305.
139. Qiagen, *QIAamp<sup>®</sup> DNA Micro Handbook*. 2003, Crawley, UK: Qiagen.
140. A.M.F. Tereba, WI), Bitner, Rex M. (Cedarburg, WI), Koller, Susan C. (Verona, WI), Smith, Craig E. (Oregon, WI), Kephart, Daniel D. (Cottage Grove, WI), Ekenberg, Steven J. (Mount Horeo, WI). (2004). *Simultaneous*

*isolation and quantitation of DNA*. Promega Corporation (Madison, WI). United States

141. N.J. Oldroyd, A.J. Urquhart, C.P. Kimpton, *et al.*, *A highly discriminating octoplex short tandem repeat polymerase chain reaction system suitable for human individual identification*. *Electrophoresis*, 1995. **16**(1): p. 334-337.
142. T.M. Clayton, S.M. Hill, L.A. Denton, *et al.*, *Primer binding site mutations affecting the typing of STR loci contained within the AMPF<sub>STR</sub><sup>®</sup> SGM Plus<sup>™</sup> kit*. *Forensic Science International*, 2004. **139**(2-3): p. 255-259.
143. L.A. Foreman and I.W. Evett, *Statistical analyses to support forensic interpretation for a new ten-locus STR profiling system*. *International Journal of Legal Medicine*, 2001. **114**(3): p. 147-155.
144. The National Institute for Standards and Technology (NIST). *Commercially available STR Multiplex kits*. STRBase 2012 [cited 22 January 2012]; Available from: <http://www.cstl.nist.gov/strbase/>.
145. M.G. Ensenberger, J. Thompson, B. Hill, *et al.*, *Developmental validation of the PowerPlex<sup>®</sup> 16 HS System: An improved 16-locus fluorescent STR multiplex*. *Forensic Science International: Genetics*, 2010. **4**(4): p. 257-264.
146. Promega Corporation, *Technical Manual PowerPlex 16<sup>®</sup> System*. 2008, Promega Corporation: 2800 Woods Hollow Road Madison, WI.
147. Applied Biosystems, *AmpFISTR SGM Plus PCR Amplification Kit User's Manual*. 2011, Applied Biosystems,: Foster City, CA.
148. T. Engländer, D. Wiegel, L. Naji, *et al.*, *Dehydration of Glass Surfaces Studied by Contact Angle Measurements*. *Journal of Colloid and Interface Science*, 1996. **179**(2): p. 635-636.
149. A.B.D. Cassie, *Contact angles*. *Discussions of the Faraday Society*, 1948. **3**: p. 11-16.
150. R.A.H. van Oorschot, D.G. Phelan, S. Furlong, *et al.*, *Are you collecting all the available DNA from touched objects?* *International Congress Series*, 2003. **1239**: p. 803-807.



151. J. Hedman, A. Nordgaard, B. Rasmusson, *et al.*, *Improved forensic DNA analysis through the use of alternative DNA polymerases and statistical modeling of DNA profiles*. *BioTechniques*, 2009. **47**(5): p. 951-958.
152. M.A. Loyo, G. Caraballo, K. Sánchez, *et al.*, *PowerPlex® 16 HS: Internal validation of a new tool for genetic analysis of forensic and parentage testing*. *Forensic Science International: Genetics Supplement Series*, 2009. **2**(1): p. 33-35.
153. P. Gill, J. Curran, and K. Elliot, *A graphical simulation model of the entire DNA process associated with the analysis of short tandem repeat loci*. *Nucleic Acids Res*, 2005. **33**(2): p. 632-643.
154. J.P. Whitaker, E.A. Cotton, and P. Gill, *A comparison of the Characteristics of profiles produced with the AMPFISTR® SGM Plus™ multiplex System for both standard and Low Copy Number (LCN) STR DNA analysis*. *Forensic Science International*, 2001. **123**: p. 215-223.
155. C.C.G. Benschop, D.C. Wiebosch, A.D. Kloosterman, *et al.*, *Post-coital vaginal sampling with nylon flocked swabs improves DNA typing*. *Forensic Science International: Genetics*, 2010. **4**(2): p. 115-121.
156. J. Mo, Y. Xia, T.J. Wade, *et al.*, *Chronic Arsenic Exposure and Oxidative Stress: OGG1 Expression and Arsenic Exposure, Nail Selenium, and Skin Hyperkeratosis in Inner Mongolia*. *Environ Health Perspect*, 2006. **114**(6).
157. J. Eisinger, R.G. Shulman, and B.M. Szymanski, *Transition metal binding in DNA solutions*. *Journal of Chemical Physics*, 1962. **36**(7): p. 1721-1729.
158. K. Furusawa, N. Narazaki, N. Tomita, *et al.*, *Effect of pH on anisotropic gelation of DNA induced by aluminium cations*. *Journal of Physical Chemistry*, 2010. **114**: p. 13923-13932.
159. B. Richards, J. Skoletsky, A.P. Shuber, *et al.*, *Multiplex PCR amplification from the CFTR gene using DNA prepared from buccal brushes/swabs*. *Human Molecular Genetics*, 1993. **2**(2): p. 159-163.
160. H.C. Lee and C. Ladd, *Preservation and collection of biological evidence*. *Croatian Medical Journal*, 2001. **42**(3): p. 225-228.
161. Raven P.H. and Johnson G.B., *Biology*. 1986, St. Louis: Times Mirror/Mosby College Publishing. 1198.

162. T. Kita, H. Yamaguchi, M. Yokoyama, *et al.*, *Morphological study of fragmented DNA on touched objects*. *Forensic Science International: Genetics*, 2008. **3**: p. 32-36.
163. J.F.R. Kerr, A.H. Wyllie, and A.R. Currie, *Apoptosis- Basic Biological Phenomenon with Wide-Ranging Implications in Tissue Kinetics*. *British Journal of Cancer*, 1972. **26**(4): p. 239.
164. A. Gandarillas, L.A. Goldsmith, S. Gschmeissner, *et al.*, *Evidence that apoptosis and terminal differentiation of epidermal keratinocytes are distinct processes*. *Experimental Dermatology*, 1999. **8**: p. 71-79.
165. E. Locard, *Analysis of dust traces-Part 1*. *American Journal of Police Science*, 1929. **1**: p. 176-249.
166. D. Sweet, M. Lorente, J.A. Lorente, *et al.*, *An Improved Method to Recover Saliva from Human Skin: The Double Swab Technique*. *Journal of Forensic Science*, 1997. **42**(2): p. 320-322.
167. Tuhin, *Dr Tuhin Dev Skin Care Blog*, in *Skin Facts*. 2009, <http://blog.drduhindev.co.uk>.
168. J.-A. Bright and S.F. Petricevic, *Recovery of trace DNA and its application to DNA profiling of shoe insoles*. *Forensic Science International*, 2004. **145**: p. 7-12.
169. K.J. Esslinger, J.A. Siegel, H. Spillane, *et al.*, *Using STR Analysis to Detect Human DNA from Exploded Pipe Bomb Devices*. *Journal of Forensic Science*, 2004. **49**(3): p. 1-4.
170. K.M. Horsman-Hall, Y. Orihuela, S.L. Karczynski, *et al.*, *Development of STR profiles from firearms and fired cartridge cases*. *Forensic Science International: Genetics*, 2009. **3**(4): p. 242-250.
171. R.A.H. van Oorschot and M.K. Jones, *DNA Fingerprints from fingerprints* *Nature*, 1997. **387**: p. 767.
172. M. Phipps and S. Petricevic, *The tendency of individuals to transfer DNA to handled items*. *Forensic Science International*, 2007. **168**: p. 162-168.
173. J.J. Raymond, S.J. Walsh, R.A.H.v. Oorschot, *et al.*, *Assessing trace DNA evidence from a residential burglary: Abundance, transfer and persistence*.

- Forensic Science International: Genetics Supplement Series, 2008. **1**: p. 442-443.
174. P. Wiegand and M. Kleiber, *DNA Typing of epithelial cells after strangulation*. International Journal of Legal Medicine, 1997. **110**: p. 181-183.
  175. C. Nussbaumer and W. Denk. *DNA-Typing of Epithelial Cells after Physical Contact of Different Strength*. in *Proceedings of the 11th International Symposium on Human Identification*. 2000. Biloxi, Mississippi.
  176. D.J. Daly, C. Murphy, and S.D. McDermott, *The transfer of touch DNA from hands to glass, fabric and wood*. Forensic Science International: Genetics, 2012. **6**(1): p. 41-46.
  177. F. Alessandrini, M. Cecati, M. Pesaresi, *et al.*, *Fingerprints as Evidence for a Genetic Profile: Morphological Study on Fingerprints and Analysis of Exogenous and Individual Factors Affecting DNA Typing*. Journal of Forensic Science, 2003. **48**(3): p. 1-7.
  178. A. Lowe, C. Murray, J. Whitaker, *et al.*, *The propensity of individuals to deposit DNA and secondary transfer of low level DNA from individuals to inert surfaces*. Forensic Science International, 2002. **129**(1): p. 25-34.
  179. R.W. Allen, J. Pogemiller, J. Joslin, *et al.*, *Identification through Typing of DNA Recovered from Touch Transfer Evidence: Parameters Affecting Yield of Recovered Human DNA*. Journal of Forensic Identification, 2008. **58**(1): p. 33-41.
  180. San Diego Miramar College. *Compound Light microscope*. [cited 8th April 2012]; Available from: <http://faculty.sdmiramar.edu/dtrubovitz/microscope/>.
  181. B. Wheeler and L. Wilson, *Practical forensic microscopy: a laboratory manual*. 2008, GB: John Wiley & Sons Ltd.
  182. G. Avwioro, *Histochemical uses of haematoxylin - A review*. Journal of Pharmacy and Clinical Sciences, 2011. **1**: p. 24-34.
  183. G.W. Gill, *H&E Staining: Oversight and Insights*. Connection, 2010. **14**: p. 104-114.

184. M.K. Balogh, J. Burger, K. Bender, *et al.*, *Fingerprints from fingerprints*. International Congress Series, 2003. **1239**: p. 953-957.
185. A.J. Dominick, L.A. Welch, N.N. Daeid, *et al.*, *Is there a relationship between fingerprint donation and DNA shedding?* Journal of Forensic Identification, 2009. **59**(2): p. 133-143.
186. A.J. Dominick, *An evaluation of the mechanisms of recovery of DNA and fingerprints from fire scenes*, in *Department of Pure and Applied Chemistry*. 2010, University of Strathclyde: Glasgow. p. 241.
187. V. Castella and P. Mangin, *DNA profiling success and relevance of 1739 contact stains from caseworks*. Forensic Science International: Genetics Supplement Series, 2008. **1**: p. 405-407.
188. C. McCartney, *LCN DNA: proof beyond reasonable doubt?* Nat Rev Genet, 2008. **9**(5): p. 325.
189. A.R.W. Jackson and J.M. Jackson, *Forensic Science*. 2011, GB: Pearson Education.
190. D.S. Minors, *Physiology of red and white blood cells*. Anaesthesia and Intensive Care Medicine, 2004. **5**(5): p. 174-178.
191. H. Herdersen and T. Thorbjørnsen. *Efficient purification of high-quality DNA from blood samples with a range of white cell counts using the BioRobot EZ1 system*. QIAGEN News e21 2003 [cited 20th June 2012]; Available from: <http://www.qiagen.com/literature/qiagennews/weeklyarticle/jun03/e21/default.aspx?PrinterFriendly=true>.
192. J.U.M.C. Department of Histology, *Blood smear*, in *Department of Histology, Jagiellonian University Medical College*, <http://www.histologia.cm-uj.krakow.pl/index.html>, Editor. 2006, Wikipedia: Krakow.
193. A. Akane, K. Matsubara, H. Nakamura, *et al.*, *Identification of the heme compound copurified with deoxyribonucleic-acid (DNA) from bloodstains, a major inhibitor of polymerase chain-reaction (PCR) amplification*. Journal of Forensic Sciences, 1994. **39**(2): p. 362-372.

194. B. Solomon and M.W. Duncan, *Proteomics of Seminal Fluid*, in *Proteomics of Human Body Fluids: Principles, methods and applications*, V. Thongboonkerd, Editor. 2007, Humana Press: Totowa, NJ.
195. R.S. Jeyendran, *Introduction: Sperm Collection and Processing Methods*. 2003: Cambridge University Press.
196. B.R. Bahnak, Q.Y. Wu, L. Coulombel, *et al.*, *A simple and efficient method for isolating high molecular weight DNA from mammalian sperm*. *Nucleic Acids Research*, 1988. **16**(3): p. 1208.
197. K. Elliott, D.S. Hill, C. Lambert, *et al.*, *Use of laser microdissection greatly improves the recovery of DNA from sperm on microscope slides*. *Forensic Science International*, 2003. **137**: p. 28-36.
198. M.R. Villarreal, *Human Spermatozoa*, in <http://commons.wikimedia.org>. 2007, Wikimedia Commons.
199. R. Roy, D.L. Steffens, B. Gartside, *et al.*, *Producing STR locus Patterns from bloodstains and other forensic samples using an infrared fluorescent automated DNA sequencer*. *Journal of Forensic Sciences*, 1996. **41**(3): p. 418-424.
200. L.H. Seah, M.I. Othman, P. Jaya, *et al.*, *DNA profiling on fabrics: an in-situ method*. *International Congress Series*, 2004. **1261**: p. 565– 567.
201. Applied Biosystems. *AmpFISTR Identifiler Direct PCR Amplification kit*. 04 Oct 2011]; Available from: [http://marketing.appliedbiosystems.com/mk/get/IDENTIFILER\\_DIRECT\\_LANDING?CID=FL-86541\\_godirect](http://marketing.appliedbiosystems.com/mk/get/IDENTIFILER_DIRECT_LANDING?CID=FL-86541_godirect).
202. M. Colebrook. *Life Chemistry*. [cited 6th April 2012]; Available from: <http://www.greenspirit.org.uk/resources/LifeChemistry.shtml>.
203. E.P.G. Gohl and L.D. Vilensky, *Introduction to fibre polymers and fibre properties*, in *Textile science: An explanation of fibre properties*. 1983, Longman Cheshire: Melbourne, Australia. p. 1-40.
204. E.P.G. Gohl and L.D. Vilensky, *The cellulosic fibres*, in *Textile Science: An explanation of fibre properties*. 1983, Longman, Cheshire: Melbourne, Australia. p. 41-59.

205. R.R. Hegde, A. Dahiya, and M.G. Kamath. *Cotton Fibers*. Textiles 2004 6th April 2012; Available from: <http://www.engr.utk.edu/mse/Textiles/Cotton%20fibers.htm>.
206. J. Brandrup and E.H. Immergut, *Polymer Handbook*. 1989.
207. E.P.G. Gohl and L.D. Vilensky, *The Synthetic fibers*, in *Textile Science: An explanation of Fiber properties*. 1983, Longman Cheshire: Melbourne, Australia.
208. Polymer Science Learning Centre. *Nylon*. 2005 [cited 7th April 2012]; Available from: <http://pslc.ws/macrog/nylon.htm>.
209. K.C. Reed and D.A. Mann, *Rapid transfer of DNA from agarose gels to nylon membranes*. *Nucleic Acids Research*, 1985. **13**(20): p. 7207-7221.
210. Promega Corporation. *PowerPlex ESX and ESI systems: A real choice in STR analysis*. 2012 [cited 22nd May 2012]; Available from: <http://www.promega.com/products/pm/genetic-identity/powerplex-esx-and-esi/>.
211. V.C. Tucker, A.J. Hopwood, C.J. Sprecher, *et al.*, *Developmental validation of the PowerPlex® ESX 16 and PowerPlex® ESX 17 Systems*. *Forensic Science International: Genetics*, 2012. **6**(1): p. 124-131.
212. E. Suzanne, S. Jullien, M. Hernandez, *et al.* *Direct amplification from saliva and blood samples preserved on cards using the PowerPlex ESX 16 system*. 2010 [cited 22nd May 2012]; Available from: <http://www.promega.com/resources/articles/profiles-in-dna/direct-amplification-of-saliva-and-blood-samples-using-powerplex-esx-16/>.
213. Promega Corporation, *PowerPlex ESX 16 System Technical Manual*. 2009, Promega Corporation: 2800 Woods Hollow Road, Madison, WI.
214. W.H. Kruskal and W.A. Wallis, *Use of ranks in one-criterion variance analysis*. *Journal of the American Statistical Association*, 1952. **47**(260): p. 583-621.
215. P. Bel-Berger, T. Von Hoven, G.N. Ramaswamy, *et al.*, *Textile Technology Cotton/Kenaf fabrics: a viable natural fabric*. *The Journal of Cotton Science*, 1999. **3**: p. 60-70.

216. A. Guelorget, *Investigation of DNA transfer resulting from the contact between different donor surfaces and recipient fabrics*, in *Department of Pure and Applied Chemistry*. 2007, University of Strathclyde: Glasgow.
217. V. Pekarek, *Cellular transfer- A study on possible mechanisms*, in *Department of Pure and Applied Chemistry*. 2009, University of Strathclyde: Glasgow.
218. W.A. Al-Soud and P. Radstrom, *Capacity of nine thermostable DNA polymerases to mediate DNA amplification in the presence of PCR-inhibiting samples*. *Applied and Environmental Microbiology*, 1998. **64**(10): p. 3748-3753.
219. K.L. Opel, D. Chung, and B.R. McCord, *A Study of PCR Inhibition Mechanisms Using Real Time PCR*. *Journal of Forensic Sciences*, 2010. **55**(1): p. 25-33.
220. J. Hedman, L. Albinsson, L. Norén, *et al.*, *Evaluation of three new forensic DNA profiling kits on PCR-inhibitory crime scene samples*. *Forensic Science International: Genetics Supplement Series*, 2011. **3**(1): p. e457-e458.
221. C.L. Holt, M. Buoncristiani, J.M. Wallin, *et al.*, *TWGDAM validation of AmpFISTR (TM) PCR amplification kits for forensic DNA casework*. *Journal of Forensic Sciences*, 2002. **47**(1): p. 66-96.
222. J.M. Butler, ed. *Advanced topics in Forensic DNA typing: Methodology*. 2012, Academy Press: Oxford.
223. J.S. Chamberlain, R.A. Gibbs, J.E. Rainer, *et al.*, *Deletion screening of the Duchenne muscular dystrophy locus via multiplex DNA amplification*. *Nucleic Acids Research*, 1988. **16**(23): p. 11141-11156.
224. M.C. Edwards and R.A. Gibbs, *Multiplex PCR: advantages, development, and applications*. *PCR methods and applications*, 1994. **3**(4): p. S65-75.
225. H. Grunenwald, *Optimisation of polymerase chain reactions*, in *PCR Protocols*, J.M.S. Bartlett and D. Stirling, Editors. 2003, Humana Press: London. p. 89-99.
226. D.L. Hyndman and M. Mitsuhashi, *PCR Primer design*, in *PCR Protocols*, J.M.S. Bartlett and D. Stirling, Editors. 2003, Humana Press: London. p. 81-88.

227. J.M. Ruijter, C. Ramakers, W.M.H. Hoogaars, *et al.*, *Amplification efficiency: linking baseline and bias in the analysis of quantitative PCR data*. *Nucleic Acids Research*, 2009. **37**(6): p. e45.
228. M. McPherson and S. Moller, *Reagents and Instrumentation*. 2nd ed. PCR, ed. E. Owen. 2006, New York: Taylor and Francis Group.
229. T. Weissensteiner, *Optimising PCR with the aid of experimental design*, in *PCR Technology: Current innovations*, T. Weissensteiner, H.G. Griffin, and A. Griffin, Editors. 2003, CRC Press: Florida. p. 65-75.
230. D.H. Gelfand, *Taq DNA Polymerase*, in *PCR Technology: Principles and Applications for DNA amplification*, H.A. Erlich, Editor. 1989, Stockton Press: New York. p. 17-22.
231. C. Andre, *New developments in PCR*. *BioTechniques Special Issue*, 2009. **46**(5): p. 375-376.
232. Applied Biosystems, *AmpFISTR Identifiler PCR Amplification kit User's manual*. 2012, Applied Biosystems, : Foster City, CA.
233. Thermo Fisher Scientific Inc. *Phusion DNA Polymerase products*. Finnzymes PCR and qPCR products 2011 [cited 11 March 2012]; Available from: [http://www.finnzymes.fi/pcr/phusion\\_products.html](http://www.finnzymes.fi/pcr/phusion_products.html).
234. Y. Wang, D.E. Prosen, L. Mei, *et al.*, *A novel strategy to engineer DNA polymerases for enhanced processivity and improved performance in vitro*. *Nucleic Acids Research*, 2004. **32**(3): p. 1197-1207.
235. Thermo Scientific, *Thermo Scientific Advanced PCR enzymes*, in [http://www.finnzymes.fi/pdf/phusion\\_and\\_phire\\_brochure\\_thermo\\_low.pdf](http://www.finnzymes.fi/pdf/phusion_and_phire_brochure_thermo_low.pdf), T.F.S. Inc., Editor. 2010, Thermo Fisher Scientific Inc.
236. K. Nord, J. Nilsson, B. Nilsson, *et al.*, *A combinatorial library of an  $\alpha$ -helical bacterial receptor domain*. *Protein Engineering*, 1995. **8**(6): p. 601-608.
237. J. Rönmark, M. Hansson, T. Nguyen, *et al.*, *Construction and characterization of affibody-Fc chimeras produced in Escherichia coli*. *Journal of Immunological Methods*, 2002. **261**(1-2): p. 199-211.



238. J. Feldwisch, V. Tolmachev, C. Lendel, *et al.*, *Design of an Optimized Scaffold for Affibody Molecules*. *Journal of Molecular Biology*, 2010. **398**(2): p. 232-247.
239. P. Gill, R. Sparkes, L. Fereday, *et al.*, *Report of the European Network of Forensic Science Institutes (ENFSI): formulation and testing of principles to evaluate STR multiplexes*. *Forensic Science International*, 2000. **108**(1): p. 1-29.
240. P. Gill, L. Fereday, N. Morling, *et al.*, *The evolution of DNA databases—Recommendations for new European STR loci*. *Forensic Science International*, 2006. **156**(2–3): p. 242-244.
241. M.D. Coble and J.M. Butler, *Characterization of new MiniSTR loci to aid analysis of degraded DNA*. *Journal of Forensic Science*, 2005. **50**(1): p. 43-53.
242. P. Gill, L. Fereday, N. Morling, *et al.*, *New multiplexes for Europe—Amendments and clarification of strategic development*. *Forensic Science International*, 2006. **163**(1–2): p. 155-157.
243. Council of The European Union, *Prum Convention*. 2005: <http://register.consilium.europa.eu/pdf/en/05/st10/st10900.en05.pdf>.
244. P. Gill, *Role of Short Tandem Repeat DNA in forensic Casework in the UK—Past, present and future perspectives*. *BioTechniques*, 2002. **32**: p. 366-385.
245. C. Gehrig, S. Vuichard, A. Teyssier, *et al.*, *Validation of the NGM SElect™ kit*. *Forensic Science International: Genetics Supplement Series*, 2011. **3**(1): p. e453-e454.
246. K.M. Sullivan, A. Mannucci, C.P. Kimpton, *et al.*, *A rapid and quantitative DNA sex test: fluorescence-based PCR analysis of X-Y homologous gene amelogenin*. *BioTechniques*, 1993. **15**(4): p. 636-8, 640-1.
247. F.R. Santos, A. Pandya, and C. Tyler-Smith, *Reliability of DNA-based sex tests*. *Nature Genetics*, 1998. **18**(2): p. 103-103.
248. V. Kashyap, S. Sahoo, T. Sitalaximi, *et al.*, *Deletions in the Y-derived amelogenin gene fragment in the Indian population*. *BMC medical genetics*, 2006. **7**(1): p. 37.

249. K. Thangaraj, A.G. Reddy, and L. Singh, *Is the amelogenin gene reliable for gender identification in forensic casework and prenatal diagnosis?* International Journal of Legal Medicine, 2002. **116**(2): p. 121-123.
250. Y.M. Chang, R. Perumal, P.Y. Keat, *et al.*, *A distinct Y-STR haplotype for Amelogenin negative males characterized by a large Yp11.2 (DYS458-MSY1-AMEL-Y) deletion.* Forensic Science International, 2007. **166**(2-3): p. 115-120.
251. M. Steinlechner, B. Berger, H. Niederstätter, *et al.*, *Rare failures in the amelogenin sex test.* International Journal of Legal Medicine, 2002. **116**(2): p. 117-120.
252. R. Yong, L. Gan, Y. Chang, *et al.*, *Molecular characterization of a polymorphic 3-Mb deletion at chromosome Yp11.2 containing the AMELY locus in Singapore and Malaysia populations.* Human Genetics, 2007. **122**(3): p. 237-249.
253. H. Skaletsky, T. Kuroda-Kawaguchi, P.J. Minx, *et al.*, *The male-specific region of the human Y chromosome is a mosaic of discrete sequence classes.* Nature, 2003. **423**(6942): p. 825-837.
254. N.P. Singh, S.R. Madabhushi, S. Srivastava, *et al.*, *Epigenetic profile of the euchromatic region of human Y chromosome.* Nucleic Acids Research, 2011. **39**(9): p. 3594-3606.
255. E.K. Hanson and J. Ballantyne, *Comprehensive annotated STR physical map of the human Y chromosome: Forensic implications.* Legal Medicine, 2006. **8**(2): p. 110-120.
256. M. Kayser, A. Caglià, D. Corach, *et al.*, *Evaluation of Y-chromosomal STRs: a multicenter study.* International Journal of Legal Medicine, 1997. **110**(3): p. 125-133.
257. P. de Knijff, M. Kayser, A. Caglià, *et al.*, *Chromosome Y microsatellites: population genetic and evolutionary aspects.* International Journal of Legal Medicine, 1997. **110**(3): p. 134-140.
258. Q. Ayub, A. Mohyuddin, R. Qamar, *et al.*, *Identification and characterisation of novel human Y-chromosomal microsatellites from sequence database information.* Nucleic Acids Research, 2000. **28**(2): p. e8.

259. A. Perdomo and G. Perdomo. *Genetic Memory Update V. Etz Yoseph* 2012 [cited 18th March 2012]; Available from: <http://etzyoseph.org/>.
260. The National Institute for Standards and Technology (NIST). *Y STR Positions along Y chromosome*. STRBase 2012 [cited 18th March 2012]; Available from: <http://www.cstl.nist.gov/strbase/ystrpos1.htm>.
261. S. Kwok and R. Higuchi, *Avoiding false positives with PCR*. *Nature*, 1989. **339**(6221): p. 237-238.
262. J.-P. Ursi, D. Ursi, M. Ieven, *et al.*, *Utility of an internal control for the polymerase chain reaction*. *APMIS*, 1992. **100**(7-12): p. 635-639.
263. R.W. Cone, A.C. Hobson, and M.L. Huang, *Coamplified positive control detects inhibition of polymerase chain reactions*. *Journal of Clinical Microbiology*, 1992. **30**(12): p. 3185-3189.
264. M.F. Raoufi, F. Eini, F. Azarifard, *et al.*, *Development of a multiplex PCR system with application of IPC (internal positive control) for detecting Bacillus anthracis from environmental samples*. *International Journal of Infectious Diseases*, 2010. **14**, **Supplement 1**(0): p. e363.
265. K.L. Swango, M.D. Timken, M.D. Chong, *et al.*, *A quantitative PCR assay for the assessment of DNA degradation in forensic samples*. *Forensic Science International*, 2006. **158**(1): p. 14-26.
266. K.L. Swango, W.R. Hudlow, M.D. Timken, *et al.*, *Developmental validation of a multiplex qPCR assay for assessing the quantity and quality of nuclear DNA in forensic samples*. *Forensic Science International*, 2007. **170**(1): p. 35-45.
267. R.L. Green, I.C. Roinestad, C. Boland, *et al.*, *Developmental validation of the quantifiler real-time PCR kits for the quantification of human nuclear DNA samples*. *J Forensic Sci.*, 2005. **50**(4): p. 809-25.
268. Biotype Diagnostics GmbH, *Biotype's Twin Principle: The commercial answer to primer binding site mutation at STR loci*, in [http://www.biotype.de/fileadmin/user/Flyer/TWIN\\_Principle.pdf](http://www.biotype.de/fileadmin/user/Flyer/TWIN_Principle.pdf), B.D. GmbH, Editor. 2010.

269. R.H. Don, P.T. Cox, B.J. Wainwright, *et al.*, 'Touchdown' PCR to circumvent spurious priming during gene amplification. *Nucleic Acids Research*, 1991. **19**(14): p. 4008.
270. M. McPherson and S. Moller, *Optimization of PCR*. 2nd ed. PCR, ed. E. Owen. 2006, Abingdon: Taylor & Francis Group.
271. P. Gill, L. Fereday, N. Morling, *et al.*, *New multiplexes for Europe--Amendments and clarification of strategic development*. *Forensic Science International*, 2006. **163**(1-2): p. 155-157.
272. R. Kalendar, D. Lee, and A. Schulman. *FastPCR Software for PCR primer and probe design and repeat search*. *Genes, Genomes and Genomics* 2009 [cited 21 September 2011]; 1-14]. Available from: <http://primerdigital.com/fastpcr.html>.
273. S.S. Tobe, *A test to identify Mammalian species present in Forensic trace samples and mixtures using the mitochondrial Cytochrome b gene.*, in *Department of Pure and Applied Chemistry*. 2008, University of Strathclyde: Glasgow, UK. p. 247.
274. D. De Leo, S. Turrina, M. Marigo, *et al.*, *Italian population data for DIS1656, D3S1358, D8S1132, D10S2325, VWA, FES/FPS, and F13A01*. *Forensic Science International*, 2001. **123**(1): p. 71-73.
275. S. Dognaux, M.H.D. Larmuseau, L. Jansen, *et al.*, *Allele frequencies for the new European Standard Set (ESS) loci and DIS1677 in the Belgian population*. *Forensic Science International: Genetics*, 2012. **6**(2): p. e75-e77.
276. M.a.-J. Farfán, P. Sanz, M.a.-V. Lareu, *et al.*, *Population data on the DIS1656 and D12S391 STR loci in Andalusia (South Spain) and the Maghreb (North Africa)*. *Forensic Science International*, 1999. **104**(1): p. 33-36.
277. Z. Grubic, K. Štingl, and A. Kastelan, *Genetic analysis of the short tandem repeat loci DIS1656, D12S391, D18S535 and D22S683 in the Croatian population*. *International Congress Series*, 2003. **1239**(0): p. 171-173.
278. U. Ricci, M.L. Giovannucci Uzielli, and M. Klintschar, *Modified primers for D12S391 and a modified silver staining technique*. *International Journal of Legal Medicine*, 1999. **112**(5): p. 342-344.

279. L. Albinsson, L. Norén, R. Hedell, *et al.*, *Swedish population data and concordance for the kits PowerPlex® ESX 16 System, PowerPlex® ESI 16 System, AmpFlSTR® NGM™, AmpFlSTR® SGM Plus™ and Investigator ESSplex*. *Forensic Science International: Genetics*, 2011. **5**(3): p. e89-e92.
280. P. Wiegand, M.V. Lareu, M. Schürenkamp, *et al.*, *D18S535, DIS1656 and D10S2325: three efficient short tandem repeats for forensic genetics*. *International Journal of Legal Medicine*, 1999. **112**(6): p. 360-363.
281. M.V. Lareu, S. Barral, A. Salas, *et al.*, *Sequence variation of a hypervariable short tandem repeat at the DIS1656 locus*. *International Journal of Legal Medicine*, 1998. **111**(5): p. 244-247.
282. V. Onofri, I. Giacomini, F. Alessandrini, *et al.*, *Population data for D10S1248, D14S1434, and D22S1045 miniSTRs loci from the Marches region (Central Italy)*. *Forensic Science International: Genetics Supplement Series*, 2008. **1**(1): p. 353-355.
283. P. Martín, O. García, C. Albarrán, *et al.*, *Allele frequencies of six miniSTR loci (D10S1248, D14S1434, D22S1045, D4S2364, D2S441 and DIS1677) in a Spanish population*. *Forensic Science International*, 2007. **169**(2-3): p. 252-254.
284. M. Reichert and R. Pawłowski, *Population genetics of six miniSTR loci (DIS1677, D2S441, D4S2364, D10S1248, D14S1434, D22S1045) in a Polish population*. *Legal Medicine*, 2009. **11**(3): p. 147-148.
285. The National Institute for Standards and Technology (NIST). *STR Fact Sheets (observed alleles and PCR product sizes)*. STRBase 2012 [cited 20 February 2012]; Available from: [http://www.cstl.nist.gov/strbase/str\\_fact.htm](http://www.cstl.nist.gov/strbase/str_fact.htm).
286. T. Seider, R. Fimmers, P. Betz, *et al.*, *Allele frequencies of the five miniSTR loci DIS1656, D2S441, D10S1248, D12S391 and D22S1045 in a German population sample*. *Forensic Science International: Genetics*, 2010. **4**(5): p. e159-e160.
287. C.M. Ruitberg and J.M. Butler, *New primer sets for Y chromosome and CODIS STR loci*, in *Poster presented at the Eleventh International Symposium on Human Identification, Biloxi, MS*. 2000.
288. B. Quintans, S. Belezá, M. Brion, *et al.*, *Population data of Galicia (NW Spain) on the new Y-STRs DYS437, DYS438, DYS439, GATA A10, GATA*

- A7.1, GATA A7.2, GATA C4 and GATA H4. *Forensic Science International*, 2003. **131**(2–3): p. 220-224.
289. L. Gusmão, P. Sánchez-Diz, C.n. Alves, *et al.*, *Results of the GEP-ISFG collaborative study on the Y chromosome STRs GATA A10, GATA C4, GATA H4, DYS437, DYS438, DYS439, DYS460 and DYS461: population data.* *Forensic Science International*, 2003. **135**(2): p. 150-157.
290. J.M. Butler, A.E. Decker, M.C. Kline, *et al.*, *Chromosomal duplications along the Y-chromosome and their potential impact on Y-STR interpretation.* *Journal of Forensic Sciences*, 2005. **50**(4): p. 853.
291. S.F. Altschul, W. Gish, W. Miller, *et al.*, *Basic local alignment search tool.* *Journal of Molecular Biology*, 1990. **215**(3): p. 403-410.
292. J.M. Butler, Y. Shen, and B.R. McCord, *The Development of Reduced Size STR Amplicons as Tools for Analysis of Degraded DNA.* *Journal of Forensic Science*, 2003. **48**(5): p. 1054-1064.
293. J.M. Butler, R. Schoske, P.M. Vallone, *et al.*, *A novel multiplex for simultaneous amplification of 20 Y chromosome STR markers.* *Forensic Science International*, 2002. **129**(1): p. 10-24.
294. J.M. Butler, J.M. Devaney, M.A. Marino, *et al.*, *Quality control of PCR primers used in multiplex STR amplification reactions.* *Forensic Science International*, 2001. **119**(1): p. 87-96.
295. P. Gill, E. d'Aloja, B. Dupuy, *et al.*, *Report of the European DNA profiling group (EDNAP)-an investigation of the hypervariable STR loci ACTBP2, APOAII and D11S554 and the compound loci D12S391 and DIS1656.* *Forensic Science International*, 1998. **98**(3): p. 193-200.
296. Finnzymes, *Phusion Hot Start II High-Fidelity DNA Polymerase.* Thermo Fisher Scientific, 2010. **Version 1.2.**
297. J.M.S. Bartlett and D. Stirling, *PCR Protocols.* *Methods in Molecular Biology*, ed. J.M. Walker. Vol. 226. 2003, New Jersey: Humana Press.
298. K.H. Hecker and K.H. Roux, *High and low annealing temperatures increase both specificity and yield in touchdown and stepdown PCR.* *BioTechniques*, 1996. **20**(3): p. 478-485.

299. M.V. Lareu, C. Pestoni, A. Carracedo, *et al.*, *A highly variable STR at the D12S391 locus*. International Journal of Legal Medicine, 1996. **109**(3): p. 134-138.
300. J.-J. Builes, C. Salazar, M.-J. Bravo, *et al.*, *Data analysis of D1S1656, D12S391 and D18S535 loci in two Colombian populations: Antioquia and Chocó*. International Congress Series, 2004. **1261**: p. 154-156.
301. J. Satsangi, D.P. Jewell, K. Welsh, *et al.*, *Effect of heparin on polymerase chain reaction*. The Lancet, 1994. **343**(8911): p. 1509-1510.
302. J.T. Wang, T.H. Wang, J.C. Sheu, *et al.*, *Effects of anticoagulants and storage of blood samples on efficacy of the polymerase chain reaction assay for hepatitis C virus*. Journal of Clinical Microbiology, 1992. **30**(3): p. 750-753.
303. Y.C. Swaran and L. Welch, *A comparison between direct PCR and extraction to generate DNA profiles from samples retrieved from various substrates*. Forensic Science International: Genetics, 2012. **6**: p. 407-412.

## Appendix 1: Sequence of the Internal Positive Control (IPC) Gene

The sequence in red is the random artificial gene sequence.

The sequence in blue is the sequenced gene.

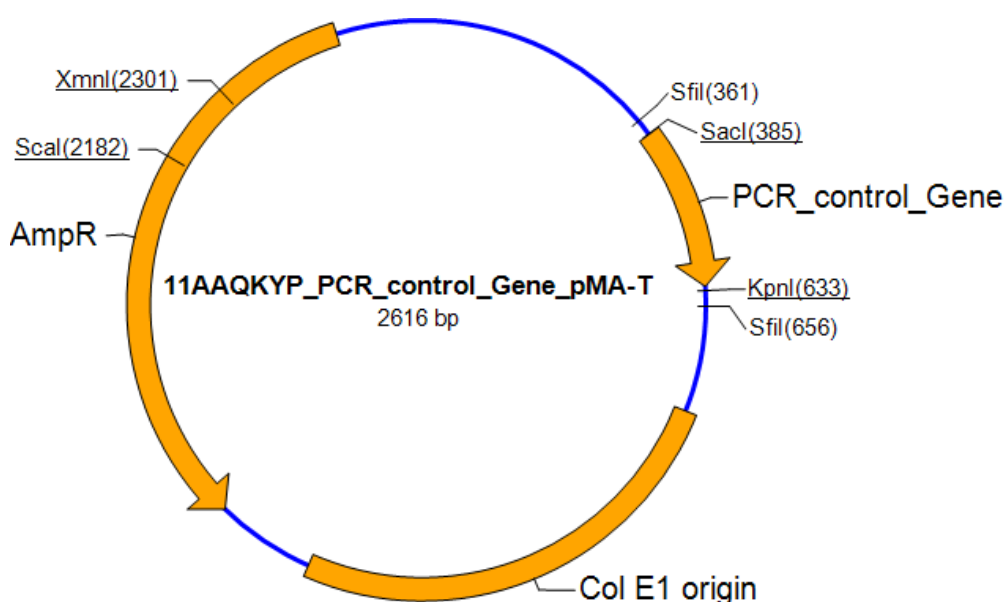
```

                                                                 TCTTCAAGTATTCA
                                                                 |||
1      CGAATTGGCGGAAGGCCGTCAAGGCCACGTGTCTTGTCCAGAGCTCTCTTCAAGTATTCA
                                                                 |||
                                                                 ...
GCTCAGTTGCTGCTTACCAATGTGTATTGTATCCAACGAACGATGCCTCGAACGATCTCT
|||
61     GCTCAGTTGCTGCTTACCAATGTGTATTGTATCCAACGAACGATGCCTCGAACGATCTCT
|||
CGATCGATGCAAGCTACGTCGTACCTATCTAGCTTACTGGATCGATCGTTCCATCAATCT
|||
121    CGATCGATGCAAGCTACGTCGTACCTATCTAGCTTACTGGATCGATCGTTCCATCAATCT
|||
CTACATCGATGTGGACAAGTCGATCAATCCATCCGAGGATCGATCGATCAACTGCTATTA
|||
181    CTACATCGATGTGGACAAGTCGATCAATCCATCCGAGGATCGATCGATCAACTGCTATTA
|||
TACTACAGAATCCTCGGATATCGTACTAGGTCTCCATCGTACGTCGTT
|||
241    TACTACAGAATCCTCGGATATCGTACTAGGTCTCCATCGTACGTCGTTGGTACCTGGAGC
|||
301    ACAAGACTGGCCTCATGGGCCTTCCGCTCACTGC
```



## Appendix 2: Plasmid DNA Quality Assurance documentation

The synthetic gene IPC gene was assembled from synthetic oligonucleotide and/or PCR products. The fragment was cloned into pMA-T using SfiI and SfiI cloning sites. The plasmid DNA was purified from transformed bacteria and concentration determined by UV spectroscopy. The final construct was verified by sequencing. The sequencing congruence within the used restriction sites was 100%. 5 µg of the plasmid preparation were lyophilised for shipping.



### Quality Assurance:

Designation	: E.coli K12 (dam+ dcm+)
Gene name	: IPC gene
Gene size	: 242 bp
Vector backbone	: pMA-T
Cloning Sites	: SfiI/SfiI
Quantity	: ~5 µg Plasmid DNA
Note	: Please dissolve lyophilised DNA in 50 µl distilled water or 10 mM Tris-HCL (pH 8.0)

### Appendix 3: Bin set for Multiplex

#GeneMapper ID v3.1 Last edited 071403

#GMv3.0 for import into GeneMapper ID v3.1

Version GMv3.0

Chemistry Kit Yuva\_Multiplex

BinSet Name Yuva\_Multiplex\_bins

Panel Name Yuva\_multiplex

Marker Name D22S1045

7	72.48	0.5	0.5
8	75.72	0.5	0.5
9	79.00	0.5	0.5
10	82.27	0.5	0.5
11	85.53	0.5	0.5
12	88.76	0.5	0.5
13	91.96	0.5	0.5
14	95.15	0.5	0.5
15	98.32	0.5	0.5
16	101.38	0.5	0.5
17	104.32	0.5	0.5
18	107.28	0.5	0.5
19	110.26	0.5	0.5
20	113.24	0.5	0.5

Marker Name D1S1656

9	119.76	0.5	0.5
10	123.72	0.5	0.5
11	127.72	0.5	0.5
12	131.77	0.5	0.5
13	135.92	0.5	0.5

14	140.18	0.5	0.5
14.3	143.77	0.5	0.5
15	144.81	0.5	0.5
15.3	148.38	0.5	0.5
16	149.40	0.5	0.5
16.3	152.71	0.5	0.5
17	153.65	0.4	0.5
17.3	156.84	0.5	0.5
18	157.75	0.4	0.5
18.3	160.86	0.5	0.5
19	161.77	0.4	0.5
19.3	164.85	0.5	0.5
20.3	168.85	0.5	0.5

Marker Name D2S441

8	73.96	0.5	0.5
9	78.29	0.5	0.5
10	82.61	0.5	0.5
11	86.91	0.5	0.5
11.3	90.04	0.5	0.5
12	91.18	0.5	0.5
13	95.41	0.5	0.5
14	99.60	0.5	0.5
15	103.51	0.5	0.5
16	107.42	0.5	0.5
17	111.37	0.5	0.5

Marker Name D12S391

14	123.42	0.5	0.5
15	127.42	0.5	0.5

16	131.46	0.5	0.5
17	135.54	0.5	0.5
17.3	138.73	0.5	0.5
18	139.75	0.5	0.5
18.3	143.35	0.5	0.5
19	144.40	0.4	0.5
20	149.00	0.5	0.5
21	153.29	0.5	0.5
22	157.36	0.5	0.5
23	161.31	0.5	0.5
24	165.32	0.5	0.5
25	169.30	0.5	0.5
26	173.30	0.5	0.5
27	177.28	0.5	0.5

Marker Name D10S1248

8	78.70	0.5	0.5
9	82.87	0.5	0.5
10	87.03	0.5	0.5
11	91.14	0.5	0.5
12	95.23	0.5	0.5
13	99.28	0.5	0.5
14	103.08	0.5	0.5
15	106.84	0.5	0.5
16	110.62	0.5	0.5
17	114.45	0.5	0.5
18	118.32	0.5	0.5
19	122.25	0.5	0.5

Marker Name DYS437

13	182.70	0.5	0.5
14	186.62	0.5	0.5
15	190.64	0.5	0.5
16	194.64	0.5	0.5
17	198.69	0.5	0.5

Marker Name IPC1

IPCI	85.87	0.5	0.5
------	-------	-----	-----

Marker Name DYS439

8	111.62	0.5	0.5
9	115.50	0.5	0.5
10	119.41	0.5	0.5
11	123.35	0.5	0.5
12	127.34	0.5	0.5
13	131.38	0.5	0.5
14	135.45	0.5	0.5
15	139.65	0.5	0.5

Marker Name IPC2

IPCII	216.85	0.5	0.5
-------	--------	-----	-----

## Appendix 4: Publications

Forensic Science International: Genetics 6 (2012) 407–412



Contents lists available at SciVerse ScienceDirect

Forensic Science International: Genetics

journal homepage: [www.elsevier.com/locate/fsig](http://www.elsevier.com/locate/fsig)



### A comparison between direct PCR and extraction to generate DNA profiles from samples retrieved from various substrates

Yuvaneswari Chandramoulee Swaran\*, Lindsey Welch\*\*

Centre for Forensic Science, University of Strathclyde, Department of Pure and Applied Chemistry, Royal College Building, 204 George Street, G1 1XW Glasgow, UK

#### ARTICLE INFO

##### Article history:

Received 16 May 2011  
Received in revised form 27 July 2011  
Accepted 22 August 2011

##### Keywords:

Direct PCR  
QiaGen extraction  
Substrates

#### ABSTRACT

Direct PCR generates DNA profiles from samples without using the extraction process. During sample extraction, DNA may be lost due to the methods used, which can affect the quality of the DNA profile obtained. This is not the case with direct PCR, where the sample is transferred directly into the PCR tube. Here, we report on the ability of direct PCR to generate DNA profiles from low amounts of control DNA retrieved from various surfaces using PowerPlex 16 HS. A comparison is made with samples undergoing a preliminary extraction stage using QiaAmp DNA Micro kits. Samples subjected to direct PCR generated DNA profiles with higher peak heights and lower allele dropout on all the different substrates tested when compared to the samples subjected to extraction. The amount of DNA retrieved from each substrate also varied even though the same amount of starting material was deposited, proving that the type of substrate can affect the retrieval of DNA.

© 2011 Elsevier Ireland Ltd. All rights reserved.

#### 1. Introduction

Direct PCR has been widely used in microbiology since the early 1990s, where it is more commonly known as Colony PCR. Colonies of bacteria or yeast are directly amplified using specific primers as a rapid test to determine the success of cloning, or for the rapid detection of infections [1–3]. During the hotstart cycle, the cell walls are disrupted, releasing DNA for amplification. The next 28–32 cycles involve the melting, annealing and elongation phases of PCR to amplify the DNA. Once PCR is complete, the product can then be separated or detected using one of the many methods available.

It is common practice to swab items at a crime scene which are thought to have come in contact with either a victim or a suspect. DNA is extracted from these swabs and the eluted DNA is subjected to PCR and electrophoresis. Most extraction methods contribute to significant loss of DNA depending on the number of tube transfers [4–6]. This can have a significant effect on the quality of the DNA profile generated. Direct PCR reduces loss of DNA because it does not involve sample transfer or sample purification. Since direct PCR involves less handling, introduction of errors and contamination can be reduced.

Previously, we reported that it was possible to obtain DNA profiles from touched fabric using direct PCR [7]. In this study, we

report the ability of direct PCR to generate DNA profiles from samples that have been deposited on various surfaces. Control DNA was diluted to a minimum of 0.01 ng/μL and 10 μL of each diluted DNA sample was deposited on four different substrates: glass, plastic, ceramic and stainless steel. Different substrates have different effects on the generation of DNA profiles because the physical properties of the substrates can effect retention of the DNA strands [8]. The DNA profiles obtained from samples subjected to direct PCR were then compared to the ones obtained from samples subjected to QiaAmp DNA Micro extraction.

In order to mimic touch DNA the samples used in this study were derived from commercially available DNA in solution. It has been documented that the amount of DNA recovered from a fingerprint is variable, depending on the individual [9,10]. Microscopically, the majority of epithelial cells in a fingerprint consist of nuclei free corneocytes, with very few, if any, nucleated cells present [6]. The findings of Kita et al. [11] demonstrates the presence of unbound single stranded DNA that has been sloughed off from the cornified layers of the skin. This, in our opinion, is the main source of DNA present in touched samples.

#### 2. Materials and methods

Glass microscope slides (microscope glass slides; untreated soda lime), plastic (laboratory polypropylene plasticware), ceramic (glazed porcelain tiles) and stainless steel (stainless steel kitchen tiles), were cleaned with Trigene, followed by 96% ethanol and sterilisation using a UV cross linker. Human male Placental DNA (Cambio Ltd.) was diluted to five different

\* Corresponding author. Tel.: +44 141 5484519.

\*\* Corresponding author. Tel.: +44 141 5482500.

E-mail addresses: [yuvaneswari.chandramoulee-swaran@strath.ac.uk](mailto:yuvaneswari.chandramoulee-swaran@strath.ac.uk), [yuvanes25@yahoo.co.uk](mailto:yuvanes25@yahoo.co.uk) (Y.C. Swaran), [linzwelch@googlemail.com](mailto:linzwelch@googlemail.com) (L. Welch).

concentrations: 0.1 ng/ $\mu$ L, 0.075 ng/ $\mu$ L, 0.05 ng/ $\mu$ L, 0.025 ng/ $\mu$ L and 0.01 ng/ $\mu$ L. Amplification was carried out with 1.0 ng of Human male Placental DNA using PowerPlex<sup>®</sup> 16 HS (see below) and the peak heights were compared, and shown to be consistent, with peak heights obtained from amplification of 1.0 ng of 9947A control DNA (data not shown). The experimental samples were then prepared in triplicate by smearing 10  $\mu$ L of each diluted DNA sample onto the four different substrates. These were left to air dry at room temperature overnight.

A cotton swab moistened with 40  $\mu$ L of sterile deionised water (SDW) was used to swab the surface smeared with DNA. An extract negative was taken by swabbing an area of the substrate not smeared with DNA. One set of swabs was subjected to direct PCR and another set was subjected to QiaAmp DNA Micro swab extraction (simply referred to as extraction from here on). For direct PCR, a 2 mm<sup>2</sup> portion of the swab was cut and placed directly into a 0.2 mL amplification tube. For extraction, the entire swab was cut and placed in a 1.5 mL tube and extracted following the QiaAmp DNA Micro swab protocol. Extracted DNA samples were eluted in 20  $\mu$ L SDW. A positive control sample (buccal swab) was extracted with each batch.

PCR amplification was set up in accordance with PowerPlex<sup>®</sup> 16 HS (PP16-HS) (Promega, UK) manufacturer's recommended protocol in a final volume of 25  $\mu$ L [12]. Positive and negative controls were amplified with each batch of samples. Once thermal cycling was complete, samples were stored at 4 °C until use. Capillary electrophoresis was carried out on a 310 Genetic Analyser (Applied Biosystems, UK) following the manufacturer's recommended protocol for Powerplex<sup>®</sup> 16. A PP16-HS allelic ladder was run with each batch.

DNA profiles were analysed using the GeneMapper ID v3.2 software (Applied Biosystems, UK). A threshold of 50 rfu was used to set the limit of detection. DNA profile data were exported to Excel for further manipulation. Total peak height and percentage profile was calculated for each profile obtained ( $n = 120$ ) and Minitab<sup>®</sup> (Minitab Inc.) was used for all statistical calculations.

### 3. Results and discussion

#### 3.1. Replicates

Three replicates were carried out for each dilution on each substrate using direct PCR and extraction ( $n = 120$ ). Only peak heights of 50 rfu and above were used in the statistical calculations. A test of normality using the Anderson–Darling normality test was carried out on the peak height data. Results indicated that the data were not normally distributed; therefore, Johnson Transformation was used to transform the peak height data to a normally distributed set of data. One-way ANOVA was carried out on peak height transformed data (TD) versus replicate data and allelic dropout versus replicate data to see if there was a significant difference between the three replicates.  $P$ -values of 0.374 and 0.232, respectively, indicated that there was no significant difference in the mean values of the three replicates. An average value of total peak height (TPH) and dropout of each set of replicates was used for subsequent statistical analyses.

#### 3.2. Direct PCR versus QiaAmp DNA Micro extraction

Percentage profile (%P) was calculated and shown (Fig. 1) for each sample using the following equation:

$$\frac{\text{Total number of expected alleles} - \text{total number of dropped out alleles}}{\text{Total number of expected alleles}} \times 100$$

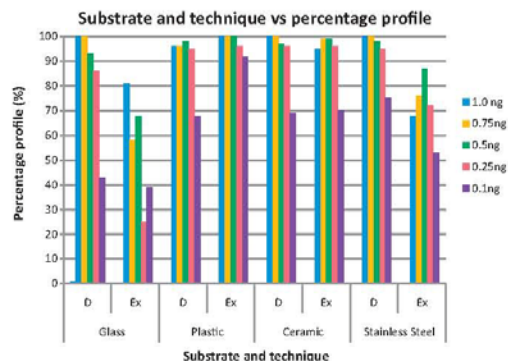


Fig. 1. Average percentage profile obtained from direct PCR (D) and extraction (Ex) for four different substrates.

Dropped out alleles were classified as being those below the 50 rfu threshold. Results indicated that extracted samples gave a lower %P compared to samples subjected to direct PCR. Direct PCR gave full profiles in almost all the substrates tested with 1.0 ng and 0.75 ng of total DNA. Only samples retrieved from plastic gave higher %P with extraction when compared to direct PCR.

Total peak height (TPH) obtained from samples subjected to direct PCR saw a gradual decrease as the amount of starting DNA template decreased. This consistency was observed in all the repetitions with direct PCR. The results obtained from extraction, however, were less reliable and did not follow the same pattern (Fig. 2). It was also noted that the results for extraction was less reproducible when repeated (data not shown).

A General Linear Model (GLM) with TD versus technique was calculated. A  $p$ -value of 0.037 indicated that the different techniques employed, i.e.; direct PCR and extraction, had a significant effect on the peak heights obtained. When the mean TD values of direct PCR were compared with extraction, direct PCR had a higher mean value indicating that the samples subjected to direct PCR gave higher peak heights than the samples subjected to extraction (Fig. 3). The DNA profiles obtained from both direct PCR and extraction exhibited heterozygous imbalance at some of the loci, particularly at Penta E, CSF1PO, D8S1179 and FGA, which was not unexpected due to the low amounts of template DNA present.

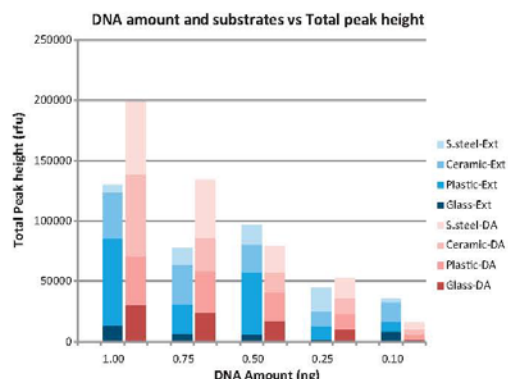


Fig. 2. Average total peak height for electropherograms obtained from 1.0 ng to 0.1 ng of DNA from glass, plastic, ceramic and stainless steel using extraction (Ext) and direct PCR (DA).

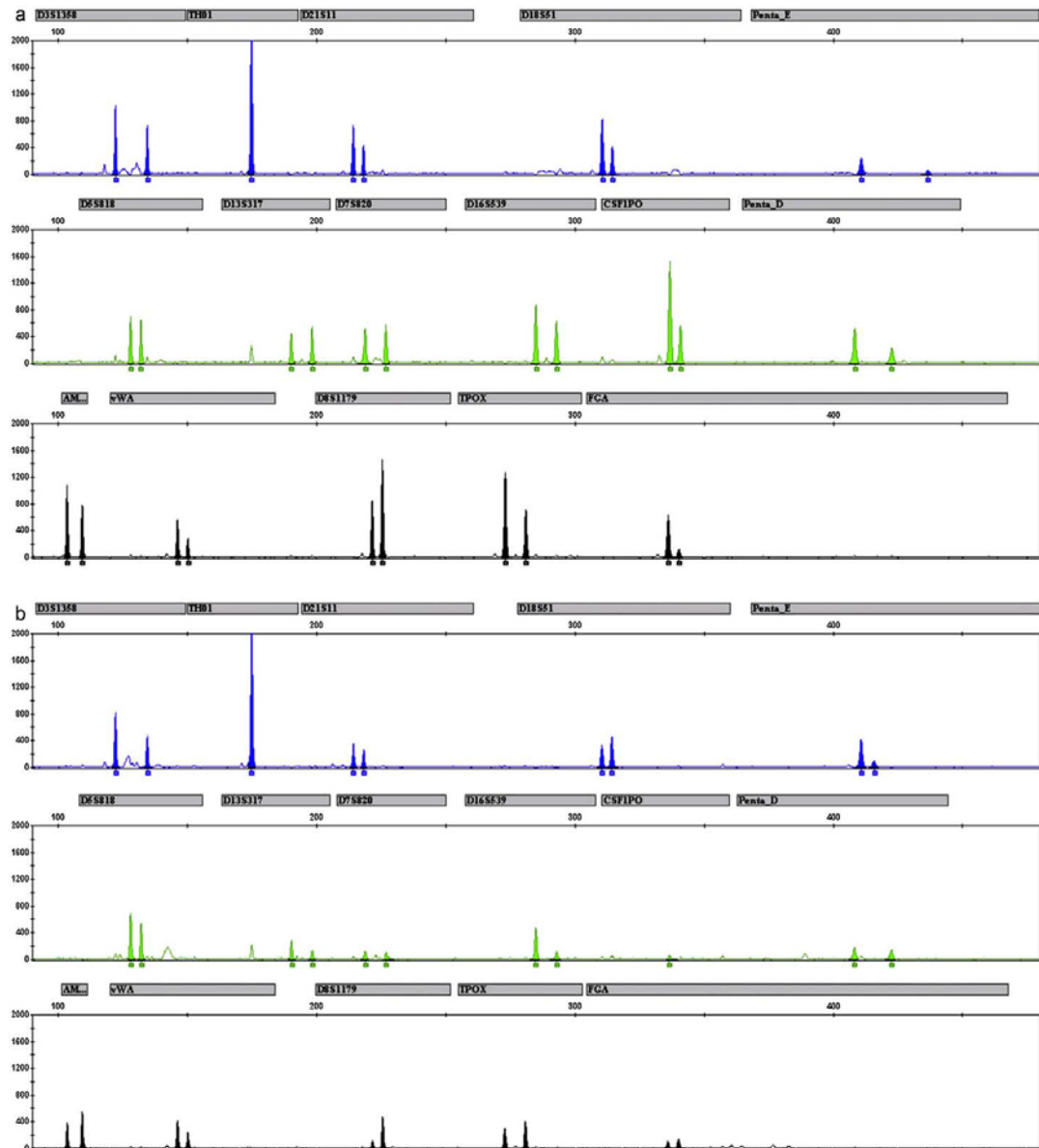


Fig. 3. A comparison of electropherograms at 2000 rfu. (a) DNA profile obtained from 0.5 ng of total starting DNA subjected to Direct PCR (TPH = 21,382) and (b) DNA profile obtained from 0.5 ng of total starting DNA subjected to extraction (TPH = 3445).

3.3. Analysis of substrates

Overall, direct PCR gave better DNA profiles for all four substrates tested when compared to extraction (Fig. 1); the only exception being plastic, where the %P was significantly higher (92%) than direct PCR (68%). In both techniques, glass gave the lowest %P (40% direct PCR; 20% extraction).

Statistical analysis on TD of direct PCR versus substrate using GLM gave a significant *p*-value of 0.01, indicating that different

substrates affect the peak height of the DNA profiles generated. When the mean TD obtained from direct PCR was compared between substrates, samples retrieved from glass gave the lowest mean TD, followed by stainless steel and ceramic, while the highest peak height was obtained from samples retrieved from plastic. Fig. 4 shows an example of electropherograms obtained when 1.0 ng of DNA was retrieved from glass, plastic, ceramic and stainless steel and amplified using direct PCR. The TPH for samples retrieved from ceramic was highest for 1.0 ng total DNA, but when



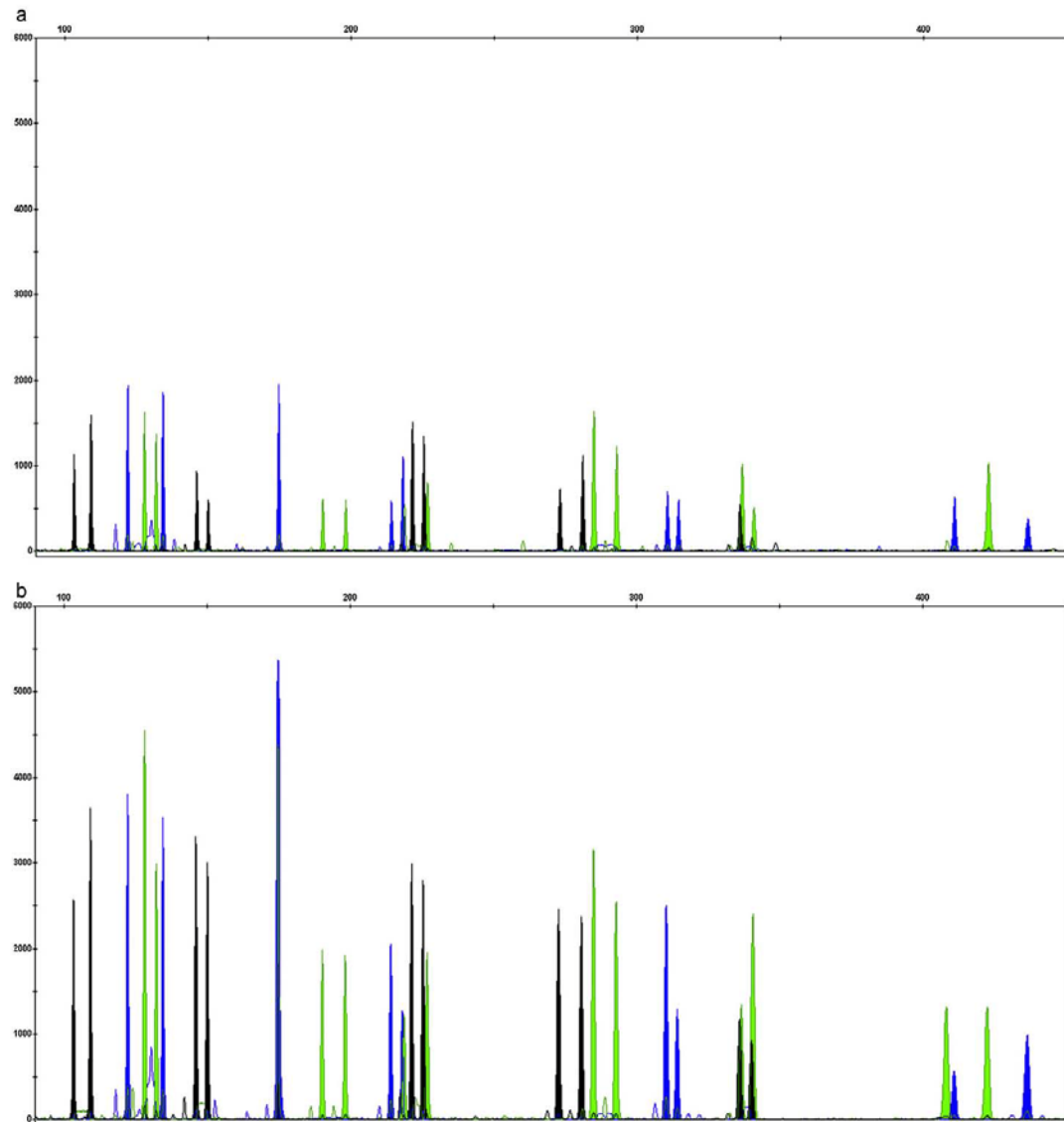


Fig. 4. Electropherograms obtained using Direct PCR from 1.0 ng total DNA retrieved from (a) glass (TPH = 30,547), (b) plastic (TPH = 73,339), (c) ceramic (TPH = 81,391) and (d) stainless steel (TPH = 55,335).

an average value was taken for all the different amounts of DNA, samples retrieved from ceramic had a lower mean TD than plastic.

Glass or silica has been used to purify DNA in certain extraction methods, for example the QiaAmp DNA Micro kit. Nanassy et al. [13] demonstrated that glass microscope slides have the ability to capture DNA in the presence of chaotropic salts. Since glass has an affinity to DNA at the molecular level, it is possible that small amounts of DNA bind to glass even without chaotropic salts present. When dealing with a low amount of starting material, this small amount of binding may make a difference to DNA recovery and subsequently affect the generation of DNA profiles.

Some types of plastic, especially polypropylene, is known to cause denaturation and adsorption of DNA to the polypropylene material [14,15]. Since the plastic material that was used in this study was polypropylene based, loss of DNA similar to glass was anticipated, but this was not observed. Samples retrieved from plastic gave one of the highest peak heights and percentage profiles compared to the other substrates tested.

DNA–metal and DNA–ceramic interaction is not widely published. Our results indicate that direct PCR worked much better than extraction on samples retrieved from stainless steel, therefore metal ions which are common PCR inhibitors could not

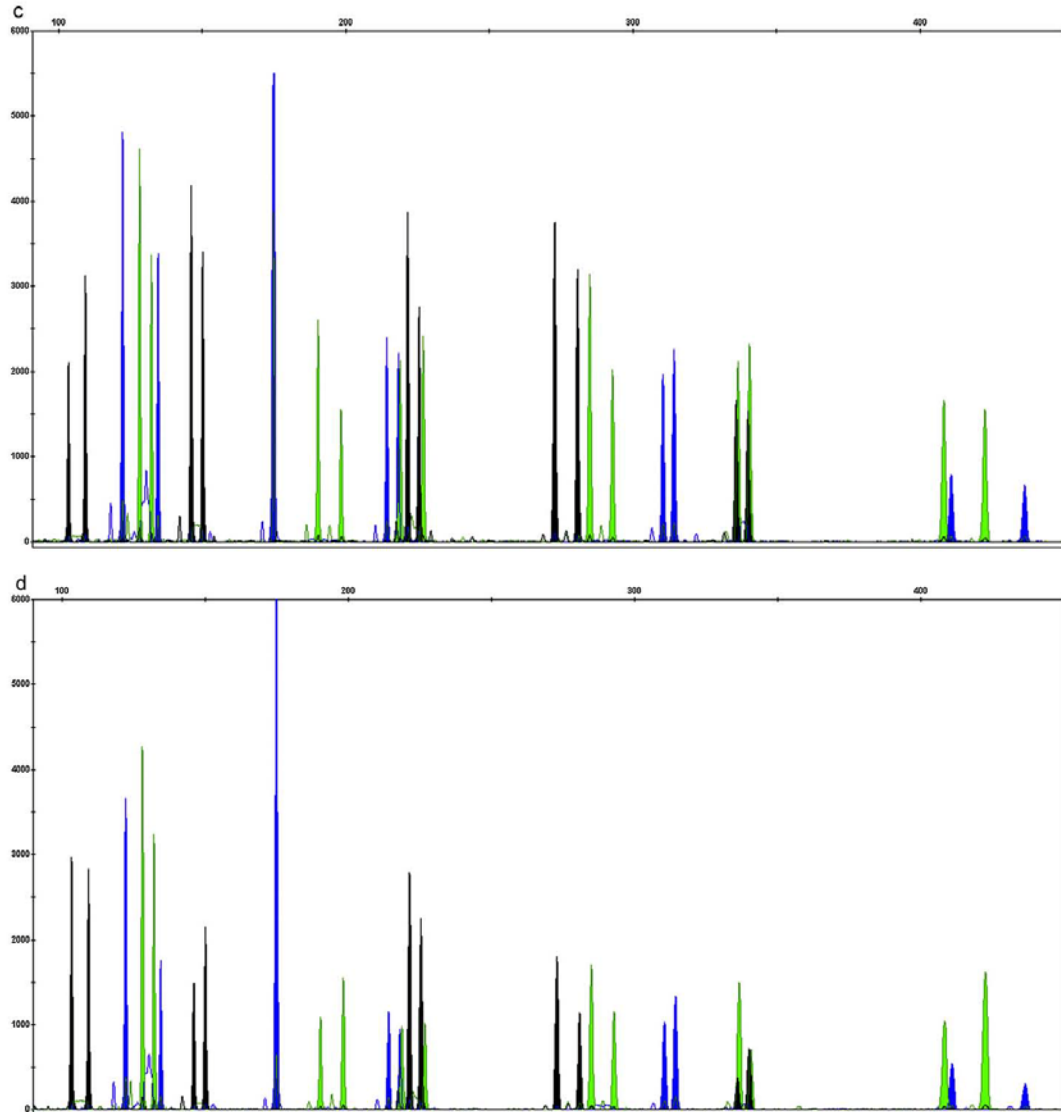


Fig. 4. (Continued).

be the cause of the low peak heights obtained from the extracted samples. One proposed assumption is that the metallic ions which were swabbed during sample retrieval interacted with the silica membrane of the Qiaagen extraction kit and affected the capture of DNA onto the silica membrane. The samples retrieved from ceramic showed low numbers of allelic dropout and high total peak heights compared to samples retrieved from glass or stainless steel. The reason for this difference could be due to the physical properties of the silica glazed ceramic tile used in this study.

#### 4. Conclusion

The different techniques employed, i.e. direct PCR and extraction, influenced the DNA profile generated by altering the amount of DNA lost between the retrieval and amplification steps. Direct PCR continuously gave better DNA profiles with better TPH and higher %P compared to extraction. The substrate on which DNA is deposited also affects the generation of DNA profiles. We can conclude that the physical and chemical properties of the substrates and how they interact with the DNA strands plays a

crucial role in the quality and the quantity of DNA that is retrieved, and subsequently affects the generation of DNA profile.

#### Acknowledgements

The authors would like to thank the Government of Malaysia for their continuous financial support and Promega for providing the necessary kits to make these experiments a success.

#### References

- [1] A. Aufauvre-Brown, C.M. Tang, D.W. Holden, Detection of gene-disruption events in aspergillus transformants by polymerase chain reaction direct from conidiospores, *Curr. Genet.* 24 (1993) 177–178.
- [2] J.H. Tjhie, F.J.v. Kuppeveld, R. Roosendaal, W.J. Melchers, R. Gordijn, D.M. MacLaren, J.M. Walboomers, C.J. Meijer, A.J.v.d. Brule, Direct PCR enables detection of *Mycoplasma pneumoniae* in patients with respiratory tract infections, *J. Clin. Microbiol.* 32 (1994) 11–16.
- [3] P.E.J. Saris, L.G. Paulin, M. Uhlén, Direct amplification of DNA from colonies of *Bacillus subtilis* and *Escherichia coli* by the polymerase chain reaction, *J. Microbiol. Methods* 11 (1990) 121–126.
- [4] N. Vandenberg, R.A.H. vanOorschot, R.J. Mitchell, An evaluation of selected DNA extraction strategies for short tandem repeat typing, in: Presented at 3rd International DNA Fingerprinting Conference, Melbourne, Australia, December 02–07, 1996.
- [5] A. Barbaro, N. Staiti, P. Cormaci, L. Saravo, DNA profiling by different extraction methods, *Int. Congr. Ser.* 1261 (2004) 562–564.
- [6] M.K. Balogh, J. Burger, K. Bender, P.M. Schneider, K.W. Alt, Fingerprints from fingerprints, *Int. Congr. Ser.* 1239 (2003) 953–957.
- [7] A. Linacre, V. Pekarek, Y.C. Swaran, S.S. Tobe, Generation of DNA profiles from fabrics without DNA extraction, *Forensic Sci. Int. Genet.* 4 (2010) 137–141.
- [8] R.W. Allen, J. Pogemiller, J. Joslin, M. Gulick, J. Pritchard, Identification through typing of DNA recovered from touch transfer evidence: parameters affecting yield of recovered human DNA, *J. Forensic Ident.* 58 (2008) 33–41.
- [9] R.A.H.v. Oorschot, M.K. Jones, DNA Fingerprints from fingerprints, *Nature* 387 (1997) 767.
- [10] A. Lowe, C. Murray, J. Whitaker, G. Tully, P. Gill, The propensity of individuals to deposit DNA and secondary transfer of low level DNA from individuals to inert surfaces, *Forensic Sci. Int.* 129 (2002) 25–34.
- [11] T. Kita, H. Yamaguchi, M. Yokoyama, T. Tanaka, N. Tanaka, Morphological study of fragmented DNA on touched objects, *Forensic Sci. Int. Genet.* 3 (2008) 32–36.
- [12] Promega Corporation Technical Manual #TMD022 PowerPlex® 16 HS System Promega Corporation 2800 Woods Hollow Road, Madison, WI.
- [13] O.Z. Nanassy, F.V. Haydock, M.W. Reed, Capture of genomic DNA on glass microscope slides, *Anal. Biochem.* 365 (2007) 240–245.
- [14] B.P. Belotserkovskii, B.H. Johnston, Denaturation and association of DNA sequences by certain polypropylene surfaces, *Anal. Biochem.* 251 (1997) 251–262.
- [15] B.P. Belotserkovskii, B.H. Johnston, C. Gaillard, F. Strauss, Polypropylene tube surfaces may induce denaturation and multimerization of DNA, *Science* 271 (1996) 222.



Contents lists available at ScienceDirect

## Forensic Science International: Genetics

journal homepage: [www.elsevier.com/locate/fsig](http://www.elsevier.com/locate/fsig)

## Generation of DNA profiles from fabrics without DNA extraction

Adrian Linacre\*, Vera Pekarek, Yuvanawari Chandramoulee Swaran, Shanan S. Tobe

Centre for Forensic Science, WestChem, University of Strathclyde, 204 George Street, Glasgow G1 1XW, UK

## ARTICLE INFO

## Article history:

Received 11 May 2009

Received in revised form 8 July 2009

Accepted 22 July 2009

## Keywords:

DNA extraction

Direct PCR

STR

Nylon

Cotton

Polyester

## ABSTRACT

DNA profiles can be obtained from fabrics where a person has made direct contact with clothing. A standard approach is to cut out a section of the fabric and then use a commercially available method to extract and isolate the DNA. Alternative methods to isolate DNA include the use of adhesive tape to remove traces of cellular material from the fabric prior to extraction. We report on a process to obtain full DNA profiles using direct amplification from a range of fabrics. The absence of an extraction step both reduces the opportunity for contamination and reduces the loss of DNA during the extraction process, increasing the sensitivity of the process of generating a DNA profile. The process does not require the use of commercially available extraction kits thus reducing the cost of generating a DNA profile from trace amounts of starting material. The results are in part dependent upon the nature of the fabric used to which the DNA has been transferred.

© 2009 Elsevier Ireland Ltd. All rights reserved.

## 1. Introduction

Cellular material, and in particular DNA, is transferred to fabrics when a person makes direct contact. It is assumed that the amount of cellular material and associated DNA that will be transferred increases with increasing time and pressure applied to the garment. In such transfer events there is no indication of where on the fabric the cellular material may have been deposited, unless there is distortion to the fabric. It is standard practice to remove the cellular material by either cutting the fabric and placing the section of fabric in a sterile tube [1], pressing adhesive tape onto the fabric and then cutting the tape into a sterile tube [2], or using a sterile cotton swab and rubbing over the surface of the fabric before cutting the tip of the swab into a sterile tube [3]. The DNA within the fabric, tape or swab is then extracted from the cell debris and other components present by using one of an array of methods. These include Chelex [4], solid phase extractions [5], and organic solvents [6]. With all these processes of DNA extraction there is an associated loss of DNA as none are 100% efficient at extracting DNA from the cellular material. During the extraction process there are tube changes thus introducing the opportunity for contamination and error. Further there are associated costs in purchasing commercially available extraction kits.

When the amount of DNA thought to be present is well below 1 ng then either a partial DNA profile may be produced or the number of cycles in the amplification process may be increased in

an attempt to increase the number of alleles obtained. Low template amplification has been performed successfully on a large number of occasions [7–9], but there is a requirement that the laboratory undertaking this type of procedure has access to appropriate facilities and that the process has been fully validated prior to its introduction. The amplification kits used in forensic science have been validated previously using either 28 cycles for SGM Plus or 30 cycles using Powerplex 16.

Previous experiments have looked at transfer of trace amounts of DNA by direct contact [10,11]. In these cases 34 cycles were used to obtain near full profiles and the number of alleles appeared to increase dependent upon the person tested. Based upon these previous experiments, inference is made about methods of cell transfer. Transfer experiments in our laboratory followed by microscopy (data not shown) indicated that few cells were transferred but given that a DNA profile can be obtained we hypothesized that either free DNA is present or DNA from cell debris was obtained. If this DNA is free from the cell structure then it would be a template for direct amplification by PCR. The only previous research on *in situ* amplification was using dried bloodstains on a range of different fabrics [12] rather than using touch DNA, where there is no visible transfer of cellular material.

We report on the generation of DNA profiles directly from fibers taken from fabrics or swabs, without the need to extract the DNA prior to amplification. The process assumes that DNA has been transferred onto the fabric and is available as template in the PCR process. The process of amplifying directly from the fabric increases the amount of DNA available for amplification as there is no loss of DNA during the extraction process. The removal of tube changes also further reduces the opportunity for contamination or

\* Corresponding author. Tel.: +44 141 548 4377; fax: +44 141 548 2532.  
E-mail address: [a.m.l.inacre@strath.ac.uk](mailto:a.m.l.inacre@strath.ac.uk) (A. Linacre).

errors in the extraction process. The success rate of the direct amplification was compared to two standard extraction methods most commonly used in most forensic laboratories.

## 2. Materials and methods

### 2.1. Fabrics and swabs

A variety of fabrics were obtained from clothing. Any cellular material on the sections of the fabric, approximately 5 cm<sup>2</sup>, was removed by sterilising the fabric with ultra violet light for at least 10 min. The fabrics chosen were white cotton, colored polyester, nylon and denim (light and dark colored). Pre-sterilised wood stick cotton swabs (Technical Services Consultants Ltd.) were used. These materials are shown in Table 1.

### 2.2. Volunteers

Three volunteers were used in the experiments (2 males and 1 female). The apparent 'shedder' status of these three people had been tested and found to be variable but all were poor shedders based on the methodology of Lowe et al. [10].

### 2.3. Transfer to fabric procedure

Volunteers washed their hands with hot water and soap to remove any extraneous cellular material and did not wear laboratory gloves for 60 min prior to testing. The volunteers then rubbed the fabric for approximately 5 s between their thumb and first finger. Approximately 2 mm<sup>2</sup> of the fabric was cut and placed directly into a 0.2 mL sterile thin walled PCR tube. Five replicates were performed on each occasion. A section of similar size was removed from the fabric at an area that had not been touched and used as a substrate negative control.

### 2.4. Transfer to glass procedure

Volunteers washed their hands with water and soap to remove any foreign cellular material and did not wear gloves for at least 60 min prior to testing. The volunteers then placed a thumb print on a glass microscope slide. The print was then swabbed with a wet cotton swab. Approximately 2 mm<sup>2</sup> of the swab was cut and placed directly into a 0.2 mL sterile thin walled PCR tube. A section of similar size was removed from the swab prior to swabbing and used as a substrate control.

### 2.5. Amplification by PCR

Amplification was performed using Powerplex 16 (Promega, WA, USA) or SGM Plus<sup>®</sup> (Applied Biosystems, CA, USA). The amplifications were performed following the manufacturer's recommended protocol. In the case of samples amplified by Powerplex 16 the volume of the reaction was 25 µL and the number of cycles was 30. A total of 28 cycles were used when amplifying using SGM Plus<sup>®</sup> and the volume was 25 µL. Amplifications were performed using a 2720 PCR machine

(Applied Biosystems, CA, USA) and the standard cycling conditions were used. From the PCR products, 2 µL was removed and separated on a PRISM 310 Genetic Analyser (Applied Biosystems, CA, USA) and the data analysed using Genemapper 2.1 (Applied Biosystems, CA, USA). A threshold of 75 rfu and 150 rfu was used to designate an allele as either being a heterozygote or a homozygote allele respectively.

### 2.6. DNA extraction

Extraction of DNA was performed using the QIAGEN Microkit (QIAGEN, Crawley, UK.) Approximately 2 mm<sup>2</sup> of fabric, or the whole swab tip, was placed into a 1.5 mL sterile tube. The manufacturer's procedure was followed for the isolation of DNA from forensic samples. At the final step 30 µL of warmed elution buffer was added to the column. A total of 9 µL of the elution solution was used in the amplification. The volume of extract used in the amplifications is the largest volume possible and the reaction set up is that used in many forensic laboratories when using samples of DNA below the threshold for quantification. This represents a third of the total sample compared to the total amount used in the direct PCR. To account for the amount of template used with direct PCR, three 2 mm<sup>2</sup> portions of fabric were cut and placed into one 1.5 mL sterile tube and processed as above and processed using the microkit.

Extraction of DNA using Chelex<sup>®</sup> was performed using a suspension of 5% Chelex in sterile H<sub>2</sub>O. Three 2 mm<sup>2</sup> portions of the fabric were cut and placed into a 1.5 mL sterile tube and incubated with 750 µL of sterile H<sub>2</sub>O at 37 °C for 30 min. The sample was then vortexed and centrifuged to pellet the cells. The supernatant was discarded leaving approximately 50 µL of solution. Chelex<sup>®</sup> (100 µL) was added and sample incubated at 56 °C for 30 min. The sample was vortexed and briefly centrifuged before being boiled for 5 min. The sample was concentrated to a final volume of 30 µL in warm TE buffer using a Microcon<sup>®</sup> Ultracel YM-100 following the manufacturer's recommended protocol.

## 3. Results

### 3.1. Direct PCR

Complete and partial DNA profiles were obtained from the fabrics and swabs. The results are summarized in Table 2. Comment on the partial nature of the profiles should reflect the fact that Powerplex 16 amplifies 15 STR loci whereas 10 are amplified by SGM plus.

Full profiles could be obtained from the swabs, cotton, nylon and polyester using SGM plus. An example of the data obtained from these three fabrics from two of the volunteers is shown in Fig. 1. Near complete profiles were obtained using Powerplex 16 from swabs, nylon, cotton and polyester. Fewer alleles were obtained from denim although near 50% of the alleles were obtained routinely from this fabric when using Powerplex 16. Reproducibility was tested by repeating the procedure with the three different volunteers 5 times each using both Powerplex 16 and SGM plus. No alleles were obtained in any test that were not

**Table 1**

The fabric types used in the experiment, the composition of the material, its color, the parent material from which it was obtained and the type of weave.

Material type	Color	Garment type	Morphology
Polyester	White, un-dyed	Fabric sample	Smooth, tight weave
Cotton	White, un-dyed light brown	T-shirt, Trousers	Smooth to textured, tight weave tight weaved
Nylon	Flesh color, dyed	Hosiery	Smooth, medium weave
Denim	Dark indigo, dyed	Jeans	Smooth, tight weave
Cotton swab	Un-dyed	–	–

**Table 2a**  
Powerplex 16 results of volunteer 1 indicating the number of alleles observed.

Substrate/trial number	Polyester	Cotton	Swab	Nylon	Denim
1	27	28	32	31	24
2	28	25	31	32	23
3	28	17	32	32	11
4	26	29	32	29	16
5	27	10	26	30	6
Average	28	24	31	31	16
Percentage	87	73	96	96	49

The number of alleles obtained from the fabrics and swabs tested using both Powerplex 16 (15 STR loci and amelogenin) and SGM Plus (10 STR loci plus amelogenin). The average number of alleles is recorded as well as the percentage (%) of the profile for either the 32 alleles of Powerplex 16 or the 20 alleles of SGM Plus.

present in the DNA profile of the volunteers. These data are tabulated in Table 2. Two other volunteers were tested in the same way with only marginal differences in the profiles obtained indicating that the donor is not the dependent factor on generating a profile.

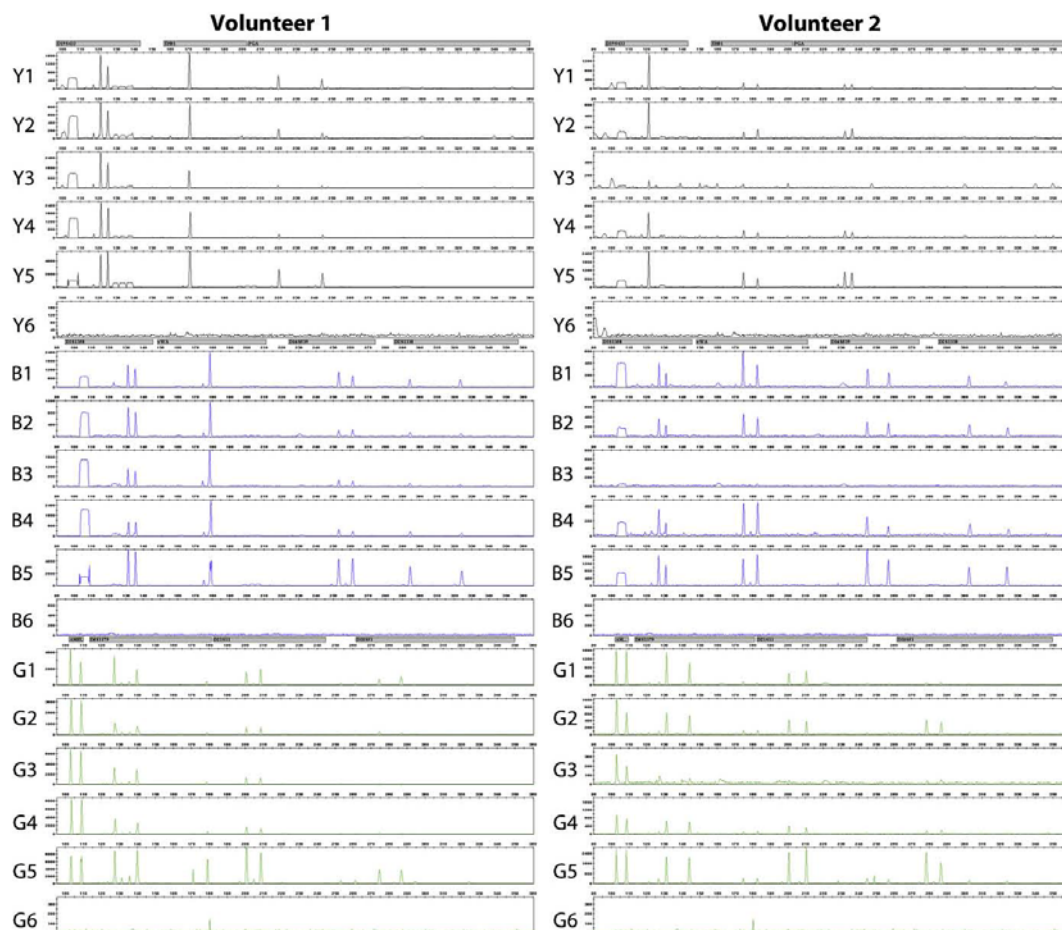
**Table 2b**  
SGM plus results of volunteer 1 indicating the number of alleles observed.

Substrate/trial number	Polyester	Cotton	Swab	Nylon
1	20	20	20	20
2	20	20	20	20
3	20	20	20	20
4	20	20	20	20
5	20	20	20	20
Average	20	20	20	20
Percentage	100	100	100	100

The number of alleles obtained from the fabrics and swabs tested using both Powerplex 16 (15 STR loci and amelogenin) and SGM Plus (10 STR loci plus amelogenin). The average number of alleles is recorded as well as the percentage (%) of the profile for either the 32 alleles of Powerplex 16 or the 20 alleles of SGM Plus.

### 3.2. Comparison with extraction

A comparison of the profile obtained when isolating the DNA using a commercially obtained solid phase extraction kit was performed. From the same area of sample (fabric or swab) that had



**Fig. 1.** The electropherograms obtained by direct amplification for volunteers 1 and 2 from (1) nylon, (2) cotton swab, (3) cotton, (4) polyester, (5) substrate positive and (6) negative. The different dyes are separated using Y for yellow (D19, TH01, FGA); B for blue (D3, vWA, D16, D2) and G for green (amelogenin, D8, D21, D18). SGM Plus was used to amplify DNA using 28 cycles and standard amplification conditions before separation on an ABI 310 Genetic Analyser.

alleles were obtained. The reduction in the number of alleles obtained may be due to the presence of indigo dye inhibiting the PCR as reported previously [13].

#### 4. Discussion

Full DNA profiles using SGM Plus and near complete profiles using Powerplex 16 were obtained from swabs and a range of fabrics onto which DNA had been transferred after 5 s of contact. The same result was obtained using three different people, whose shedder status was found previously to be poor. The omission of the extraction process increased the number of alleles obtained. The presence of free DNA is hypothesized as the substrate for the amplification, although the initial heating to 95 °C for 11 min in the amplification step may play a part in the degradation of the nuclear envelope of corneocytes as well as keratinocytes, making the DNA available for amplification if any cells are present besides the suspected free DNA.

The quality of the DNA profiles depended on the nature of the material, which corresponds with previous findings [12] where DNA profiles were compared from bloodstains on various fabrics *in situ*. Our report details DNA profiles obtained from touch DNA where there is no indication of any cellular material present. A possible explanation for the qualitative differences among the tested fabrics is their chemical structure. Fibers contain functional groups that permit the formation of various bonding types between cells or DNA and fabric fibers. For example, the O–H groups of cotton and the N–H groups of nylons are capable of forming strong hydrogen bonds with the nucleic acids of DNA or the hydrophobic cellular membrane. Polyesters contain carbonyl and cyano groups, which allow weaker dipole–dipole attractions between nucleic acids and the cell membrane [14]. The difference in the bonding strength is one plausible explanation for the varying intensity of the profiles as well as for the variations in recovery rates.

#### 5. Conclusion

We report on the generation of DNA profiles from a range of fabrics and swabs without the need for extraction of the DNA. The

omission of the extraction process has a number of positive implications. The time required to generate a DNA profile is reduced by up to 2 h. There are no tube changes during the process, thus reducing the chance of inadvertent transfer of DNA into the solution and requirements to witness the tube changes. There is a reduction in the cost of the process as there is no requirement to purchase commercial extraction kits. Most importantly there is an increase in the sensitivity of the test while not requiring an increase in the amplification cycles.

#### References

- [1] B. Budowle, et al., Simple protocols for typing forensic biological evidence: chemiluminescent detection for human DNA quantitation and restriction fragment length polymorphism (RFLP) analyses and manual typing of polymerase chain reaction (PCR) amplified polymorphisms, *Electrophoresis* 16 (1) (1995) 1559–1567.
- [2] D. Hall, M. Fairley, A single approach to the recovery of DNA and firearm discharge residue evidence, *Science & Justice* 44 (1) (2004) 15–19.
- [3] R.A.H. van Oorschot, et al., Are you collecting all the available DNA from touched objects? *International Congress Series* 1239 (2003) 803–807.
- [4] P.S. Walsh, D.A. Metzger, R. Higuchi, Chelex-100 as a medium for the simple extraction of DNA for PCR-based typing of forensic materials, *Biotechniques* 10 (1990) 506.
- [5] S. Aljanabi, I. Martinez, Universal and rapid salt-extraction of high quality genomic DNA for PCR-based techniques, *Nucleic Acids Research* 25 (22) (1997) 4692–4693.
- [6] J. Sambrook, D.W. Russell, *Molecular Cloning: A Laboratory Manual*, Cold Spring Harbor Laboratory Press, NY, 2001.
- [7] A.D. Kloosterman, P. Kersbergen, Efficacy and limits of genotyping low copy number DNA samples by multiplex PCR of STR loci, *International Congress Series* 1239 (2003) 795–798.
- [8] R.A.H. van Oorschot, M.K. Jones, DNA fingerprints from fingerprints, *Nature* 387 (6635) (1997) 767–767.
- [9] P. Gill, Application of low copy number DNA profiling, *Croatian Medical Journal* 42 (2001) 229.
- [10] A. Lowe, et al., The propensity of individuals to deposit DNA and secondary transfer of low level DNA from individuals to inert surfaces, *Forensic Science International* 129 (1) (2002) 25–34.
- [11] M. Phipps, S. Petricevic, The tendency of individuals to transfer DNA to handled items, *Forensic Science International* 168 (2–3) (2007) 162–168.
- [12] L.H. Seah, et al., DNA profiling on fabrics: an in-situ method, *International Congress Series* 1261 (2004) 565–567.
- [13] G.G. Shutler, et al., Removal of a PCR inhibitor and resolution from a five year old case DNA STR types in mixed human-canine stains, *Journal of Forensic Science* 44 (3) (1999) 623–626.
- [14] A. Larkin, S. Harbison, An improved method for STR analysis of bloodstained denim, *International Journal of Legal Medicine* 112 (6) (1999) 388–390.