

#15173863

UNIVERSITY OF STRATHCLYDE

WINDOW OPTIMISATION FOR IRAQI HOUSES

MIQDAD HAYDAR AL-JAWADI, BSc.

A THESIS SUBMITTED TO  
THE DEPARTMENT OF  
ARCHITECTURE AND BUILDING SCIENCE  
FOR THE DEGREE OF  
DOCTOR OF PHILOSOPHY

VOLUME 2

JUNE 1986

## TABLE OF CONTENTS

Acknowledgments	i
Abstract	iii
Contents	vi
Volume 1	
Introduction	1
1- Housing and house and window design in Iraq	3
2- Climate	67
3- The design model	119
4- Sunlight	166
5- Windows for daylighting	206
6- Natural ventilation	249
7- Optimisation and recommendations	290
Conclusion	323
References	328
Appendix 1	363
Volume 2	
Appendix 2	377
Volume 3	
Appendix 3	896
Appendix 4	1168
Volume 4	
Appendix 5	1270



**APPENDIX 2**



## APPENDIX 2

## WINDOW PERFORMANCE FOR DIRECT SUNLIGHT CONTROL

This appendix contains graphs for the degree of efficiency for 77 different windows which vary from 0.5m to 2.0m in height and 0.5m to 2.0m in width and increase at increments of 0.25m in width and height.

Each graph consists of six curves which represent six different locations on one of the external walls of the house. They are as follows:

Curve 1: Represents the left part of the ground floor wall

Curve 2: Represents the right part of the ground floor wall

Curve 3: Represents the middle part of the ground floor wall

Curve 4: Represents the left part of the first floor wall

Curve 5: Represents the right part of the first floor wall

Curve 6: Represents the middle part of the first floor wall

These curves represent either yearly or summer efficiency as appropriate. If the graph of the yearly efficiency consists of at least one curve, where the highest value is less than one, a graph for summer efficiency is also presented to replace the lack of usable information contained in the yearly efficiency graph. This means that summer efficiency graphs are only found in this set when the yearly efficiency graphs do not satisfy the requirements.

The windows represented in graphs are for three wall thicknesses, 120mm, 240mm and 360mm, and for sixteen room orientations.



Each graph represents a single inter-house WD (the distance between the house which contains the window being studied and the wall opposite, HD1 (the distance between the house and the neighbouring house on the left hand side) and HD2 (the distance between the house and the neighbouring house on the right hand side).

### The Graphs

I : Sample No.1 (the Yearly Efficiency)

1- WD, HD1, HD2 represent the distances between the window wall and the opposite and neighbouring houses, as shown on the first page of each group of graphs.

2- Y. Efficiency represents yearly efficiency .

3- W. Thickness represents wall thickness.

4- W. Orientation : represents the wall orientation.

5- Due to the high values of the numbers, a Log system has been used in the graphs for the Y-axis.

The efficient windows are those whose yearly efficiency is greater than one. The most efficient window is the one with the highest yearly efficiency value.

6- The X-axis has been divided into two sections, upper and lower.

A- The lower line represents the window heights, starting from the left with a window height of 0.5m, the second 0.75m up to a height of 2.0m. Therefore the distance between each of the floor divisions is always at a fixed height (see sample 1).



Sample No. 1

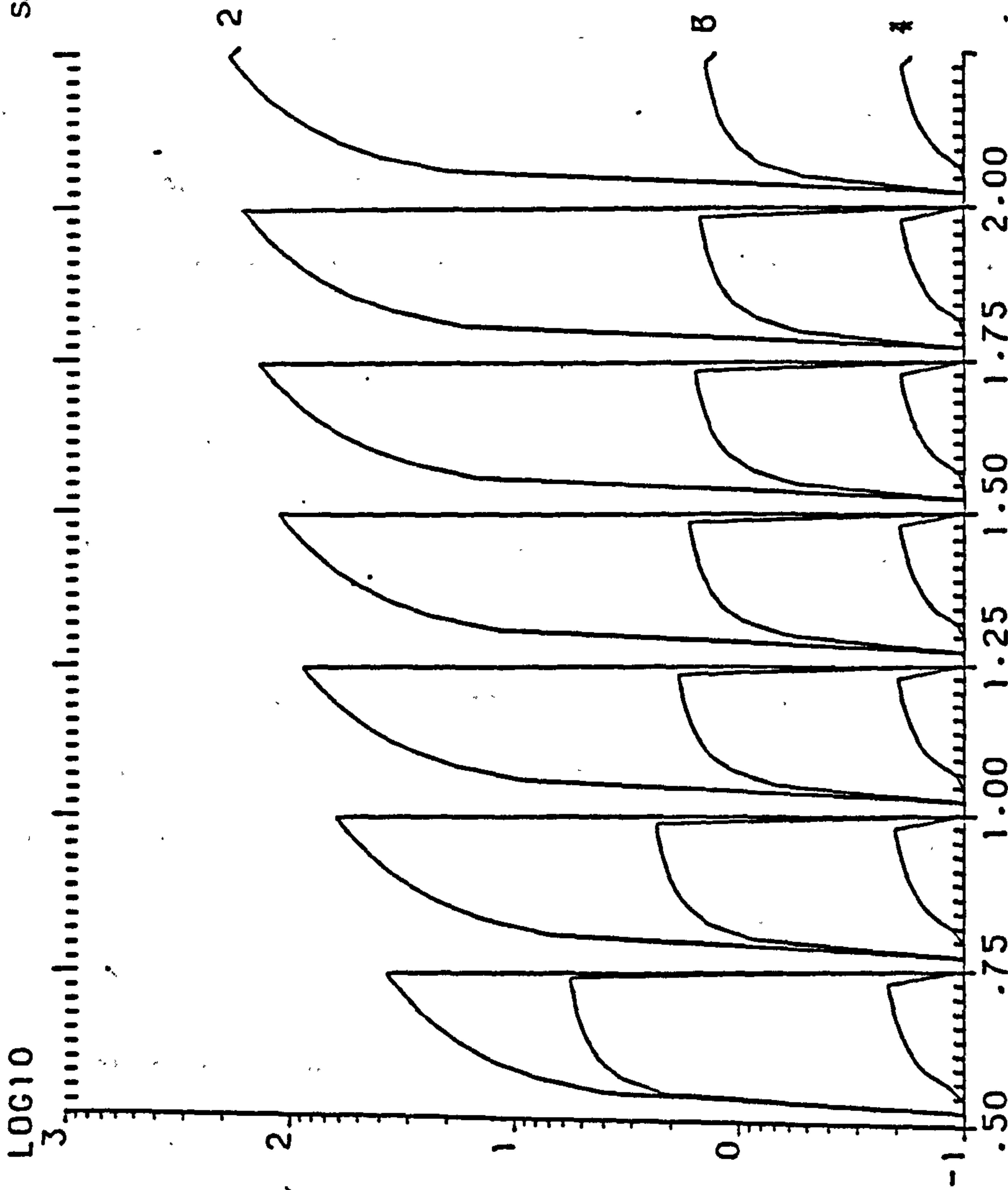

Y. EFFICIENCY W. THICKNESS= .12M W. ORIENTATION= 45.00

WD= 1M HD1= 22M HD2= 6M HOUSE T.=1.5 ST.



B- The upper line represents the window widths for the corresponding fixed window height. There are eleven divisions representing window widths from 0.5m to 3.0m which increase at increments of 0.25m. It was decided not to draw the lines on the graph but to construct an overlay containing all the vertical and the horizontal lines for the 77 windows grouped according to window height. Sample No.2 and No.3 represent the two overlays to be used with the yearly efficiency graphs.

7- Not all the graphs in the yearly efficiency group have been provided in this Appendix. The ones whose curves do not have a value of one or more have been excluded and replaced with summer efficiency graphs.

#### II : Sample No.4 (Summer Efficiency)

1- The summer efficiency graph is similar in style to the yearly efficiency graph except that, the Y-axis reads differently as indicated by the arrows on the side. The best window is at which allows the least possible amount of summer sun to enter. So the window lying on the bottom of the curve is the most efficient window and the one lying on the upper part of the graph is the least efficient. It will be recognized that some of the summer efficiency graphs are blank and here all the six curves lie on the X-axis. This means that none of the windows on the X-axis allow any sun at all to enter the room in summer and they are considered as equally fulfilling the criterion for most efficient windows.



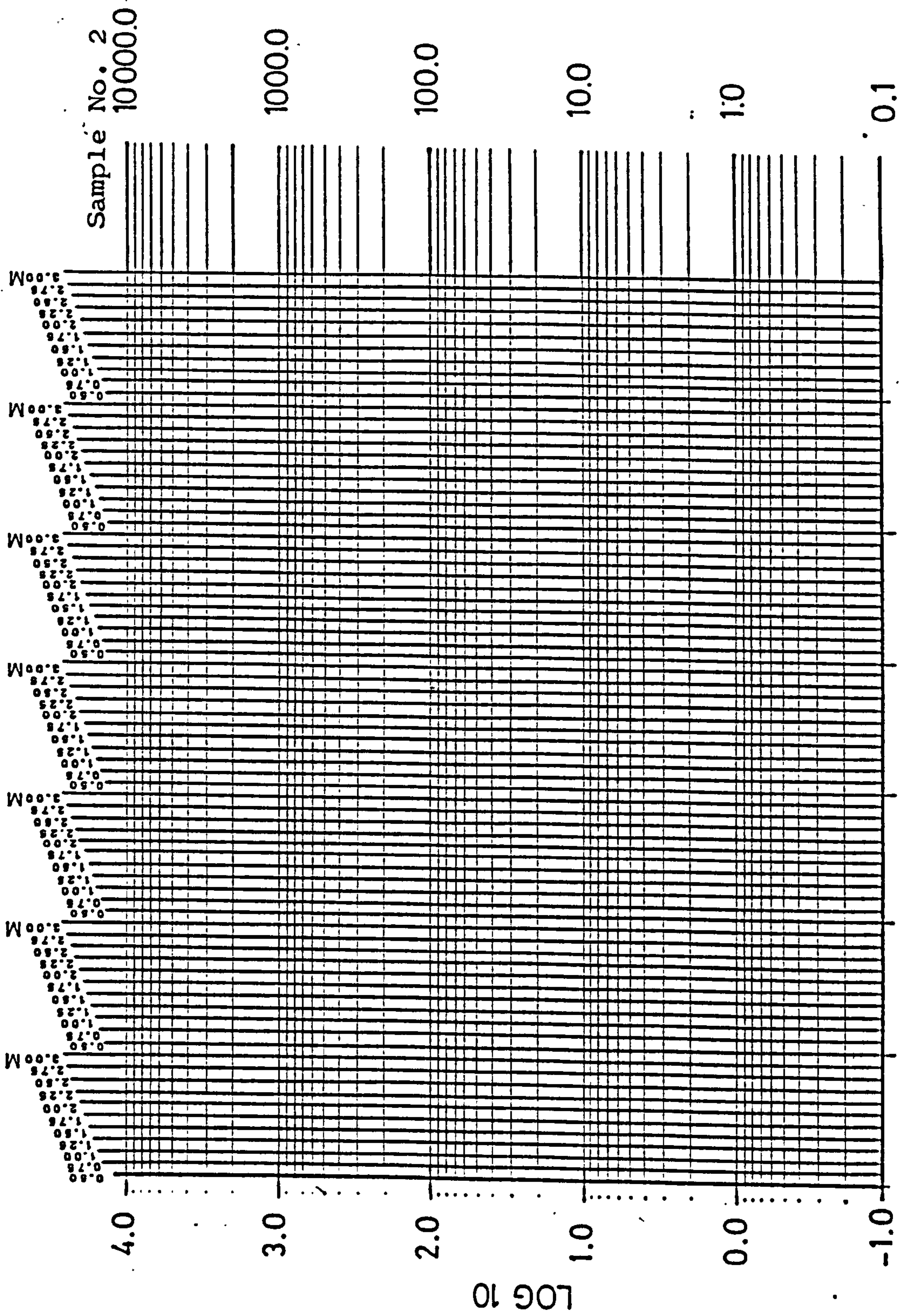

Y. EFFICIENCY W. THICKNESS = .36M W. ORIENTATION = 180.00

WD = 12M HD1 = 3M HD2 = 3M HOUSE T. = 2.0 ST.



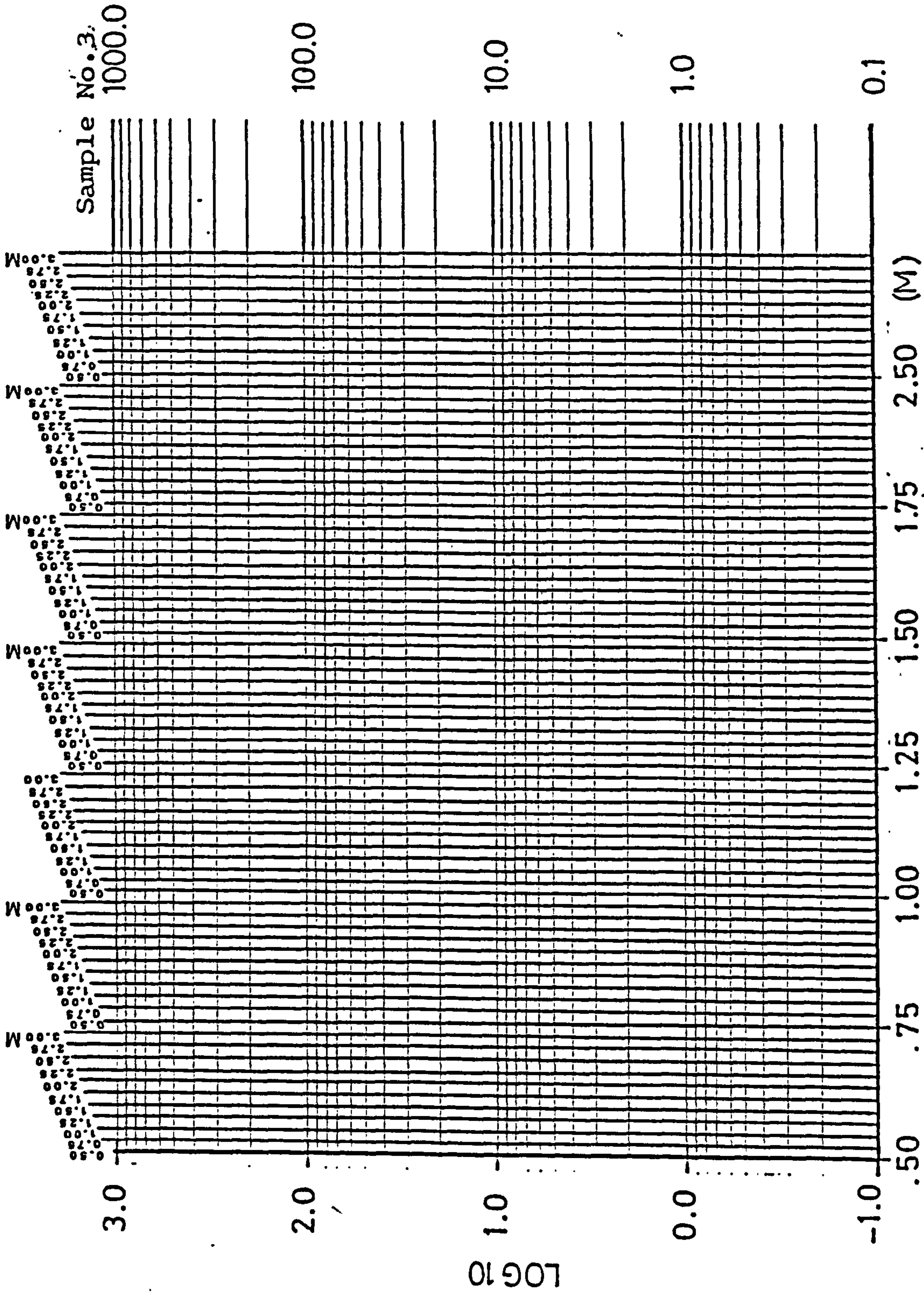

Sample No. 3:  
1000.0

100.0

10.0

1.0

0.1

Y. EFFICIENCY W. THICKNESS = M W. ORIENTATION =  
 WD = M HD1 = M HD2 = M HOUSE T. = ST.

LOG 10

3.0

2.0

1.0

0.0

-1.0

.50 .75 1.00 1.25 1.50 1.75 2.50 (M)

M 3.00  
2.75  
2.50  
2.25  
2.00  
1.75  
1.50  
1.25  
1.00  
0.75  
0.50

Sample No. 4

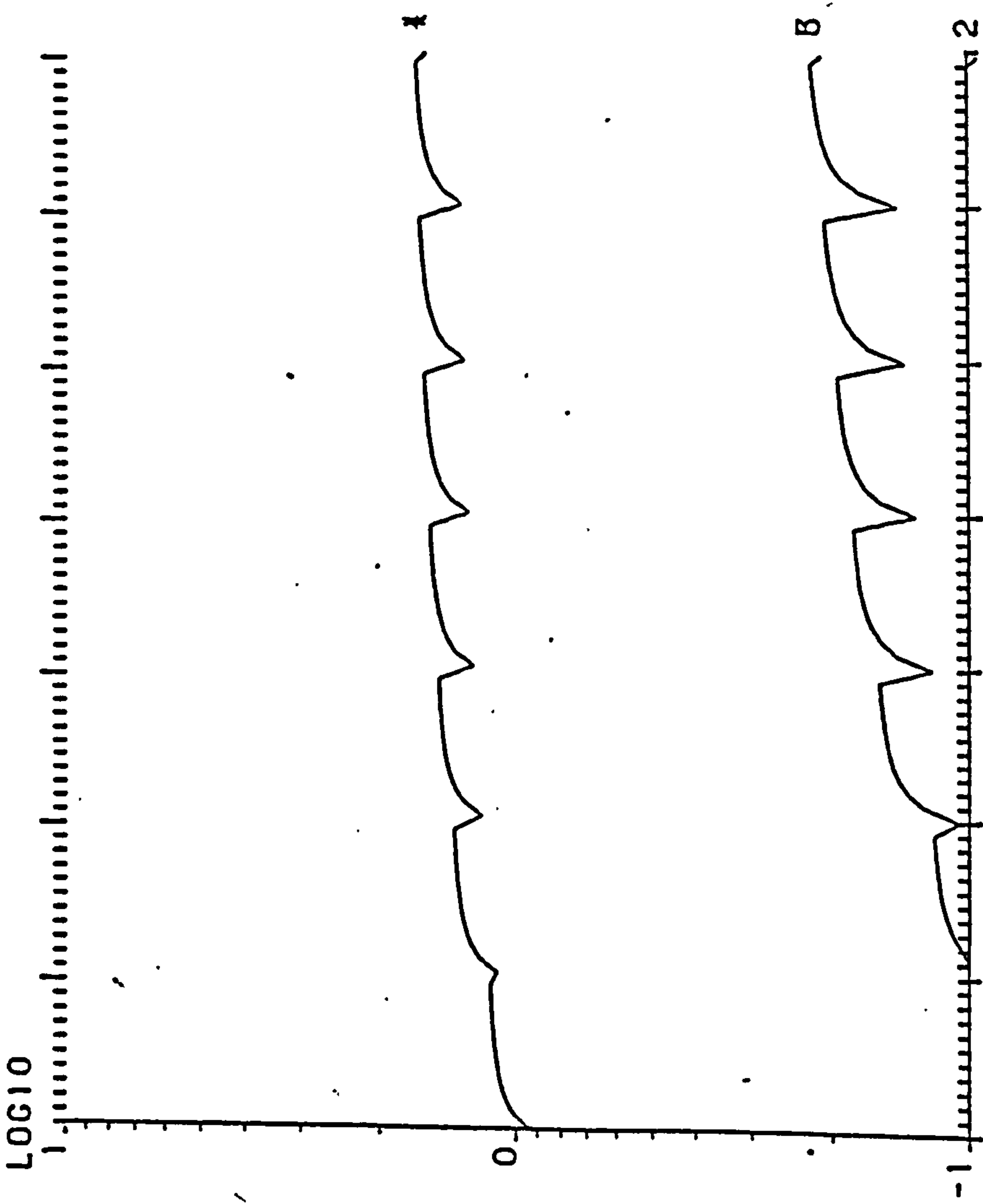

S. EFFICIENCY W. THICKNESS = .12M W. ORIENTATION = 45.00

WD = 1M HD1 = 22M HD2 = 6M HOUSE T = 1.5 ST.



2- Not all the summer efficiency graphs are provided in this Appendix. The summer efficiency graph only appears if the graph of the yearly efficiency consists of at least one curve where the highest value is less than one, to replace the lack of usable information contained in the yearly efficiency graph.

3- An overlay has been provided for ease of use of the graphs (see sample No.5).

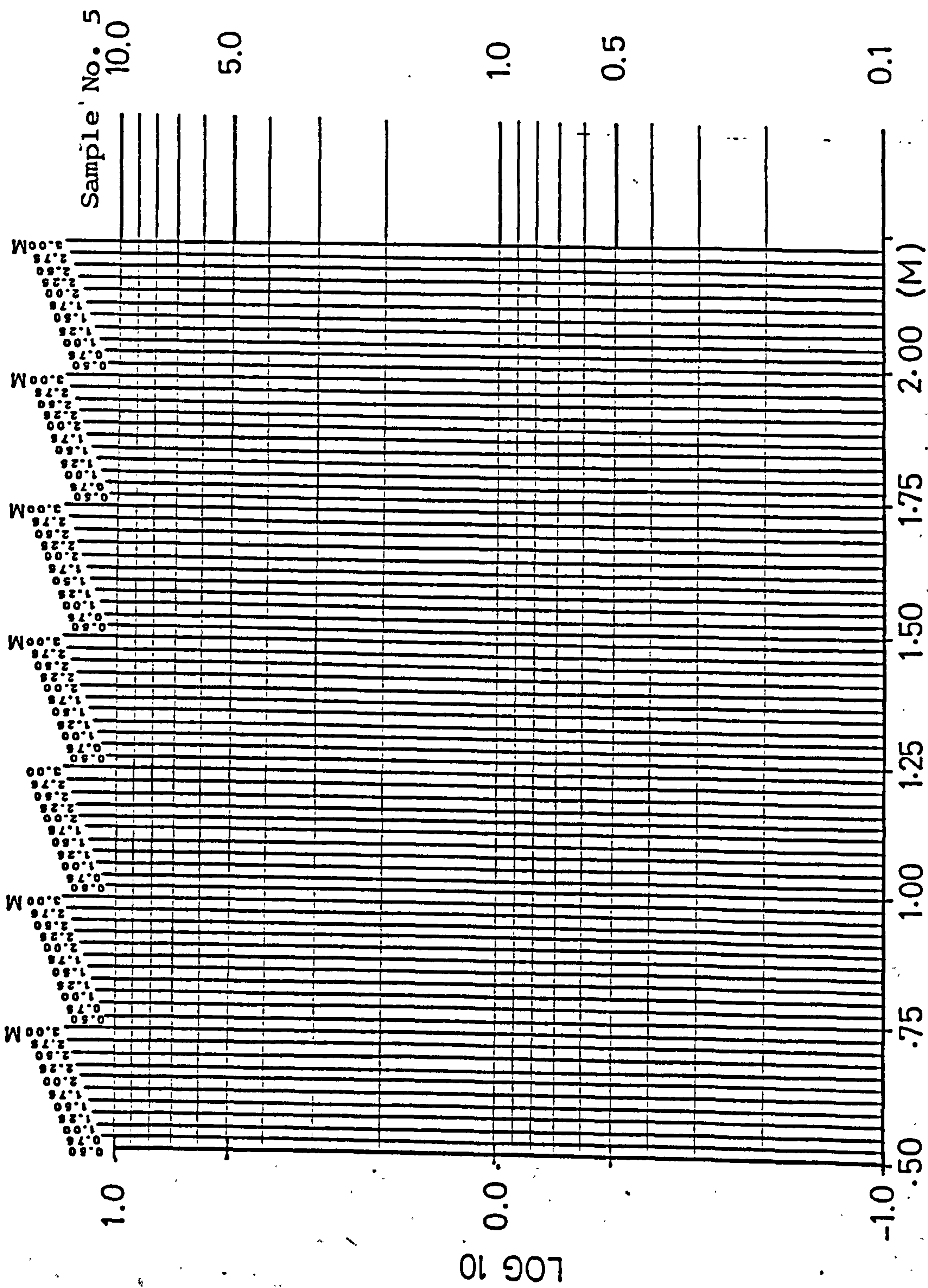

S. EFFICIENCY. W. THICKNESS = M W. ORIENTATION =

WD = M HD1 = M HD2 = M HOUSE T. =



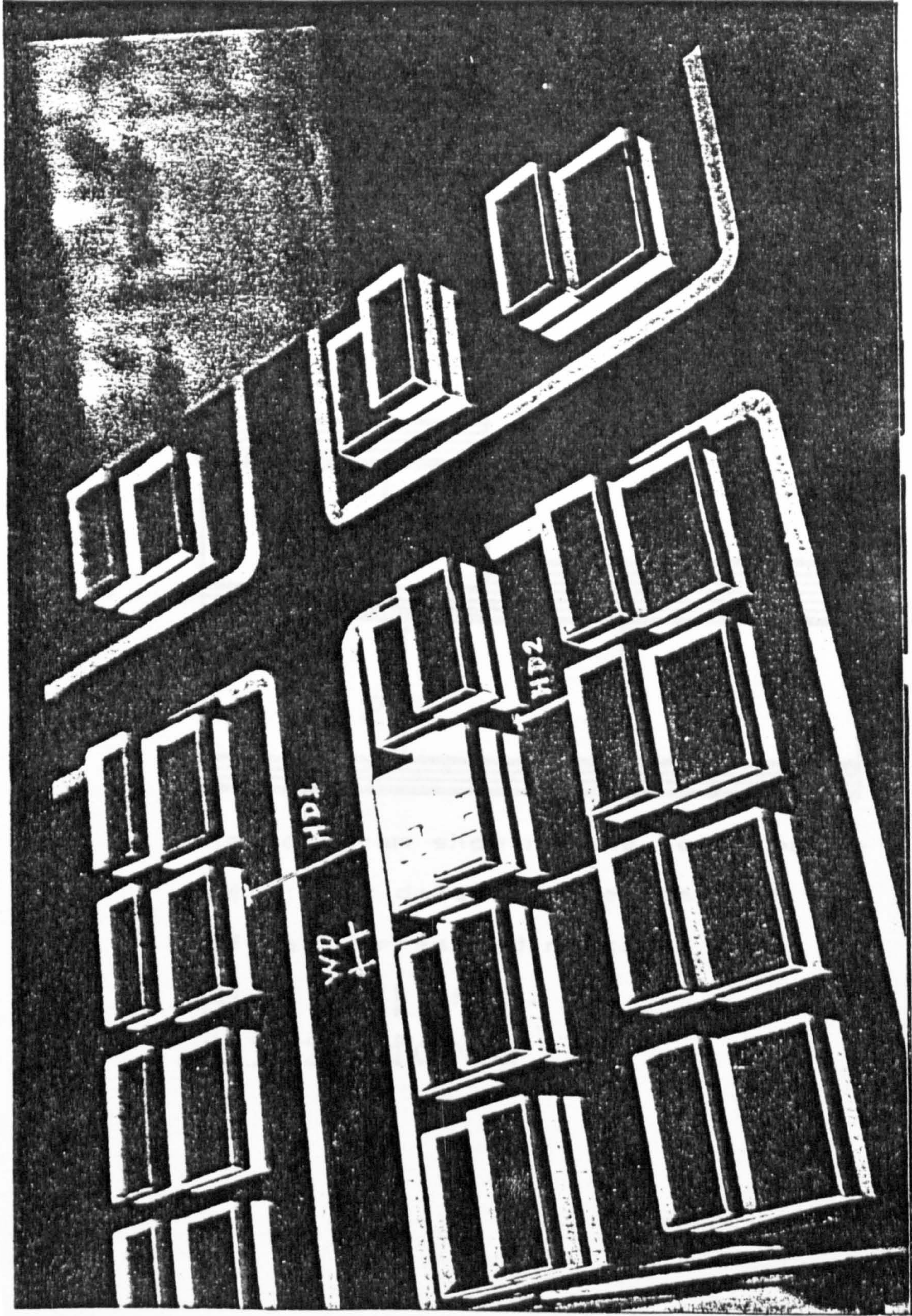

Model showing interhouse distances



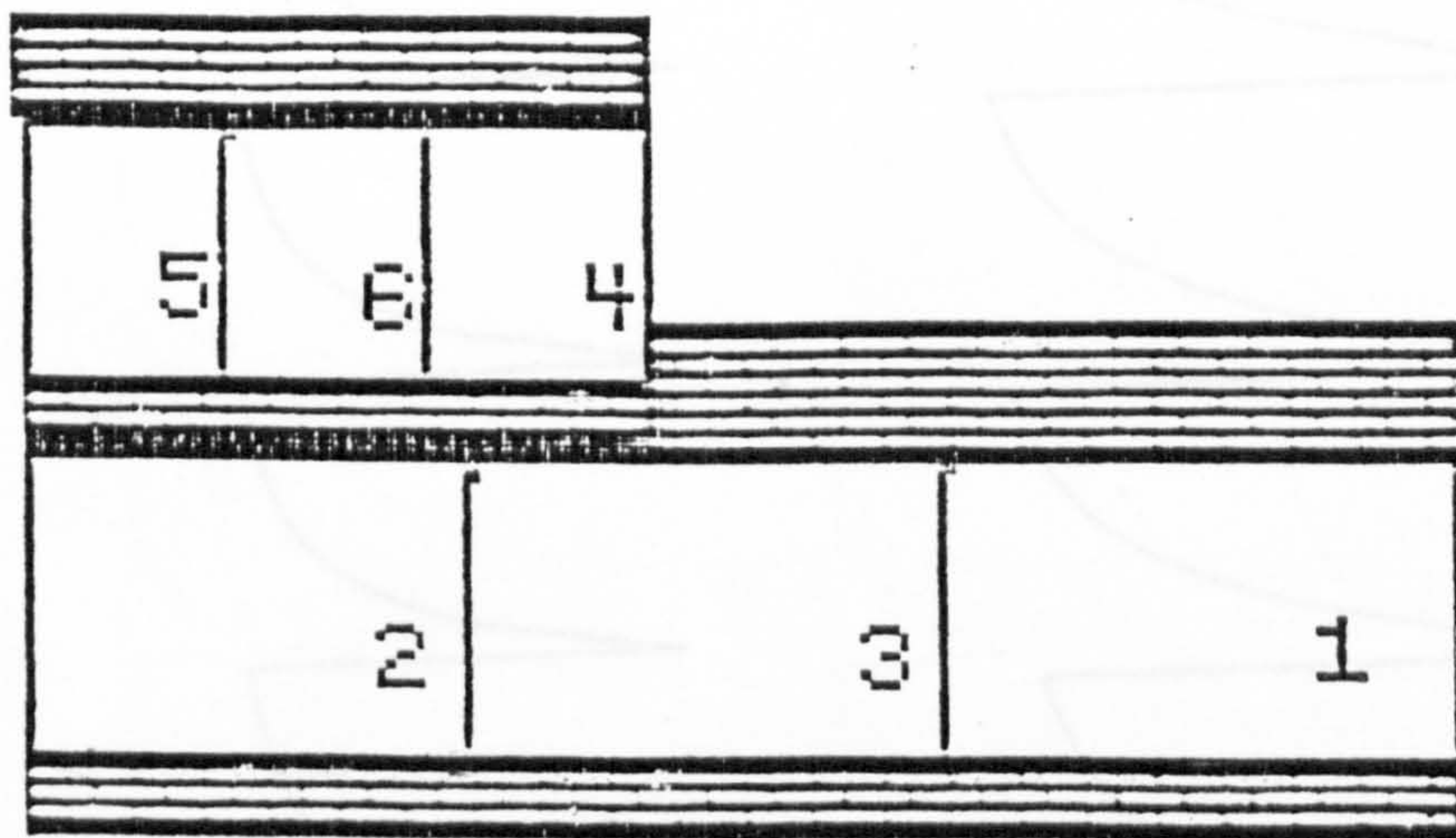

Key diagram showing the location  
of window data and the position  
of the corresponding curve

Side Wall No. 2  
1 1/2 Storey



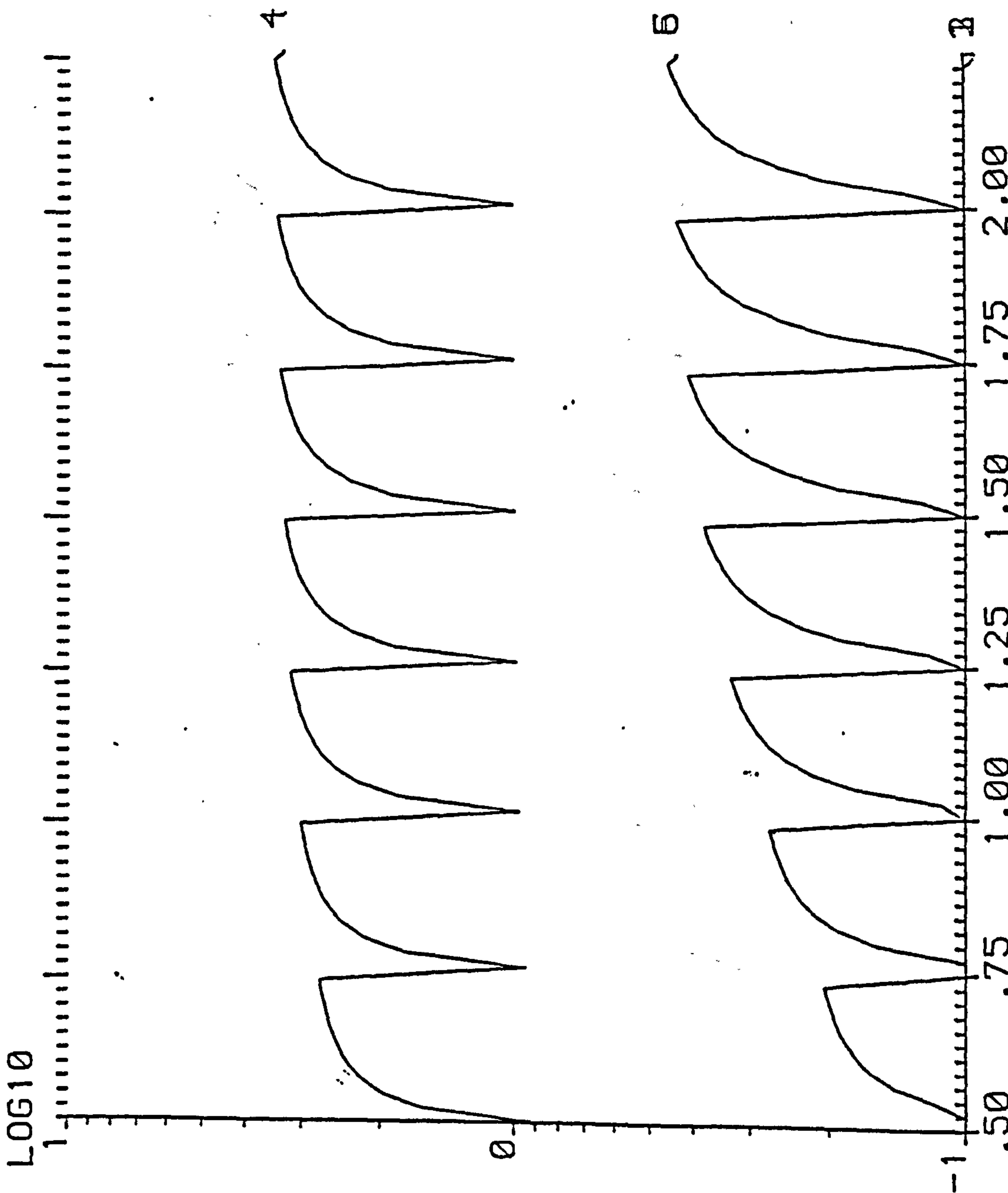

S. EFFICIENCY W. THICKNESS= .12M W. ORIENTATION= .00

WD= 1M HD1= 22M HD2= 6M HOUSE T.=1.5 ST.

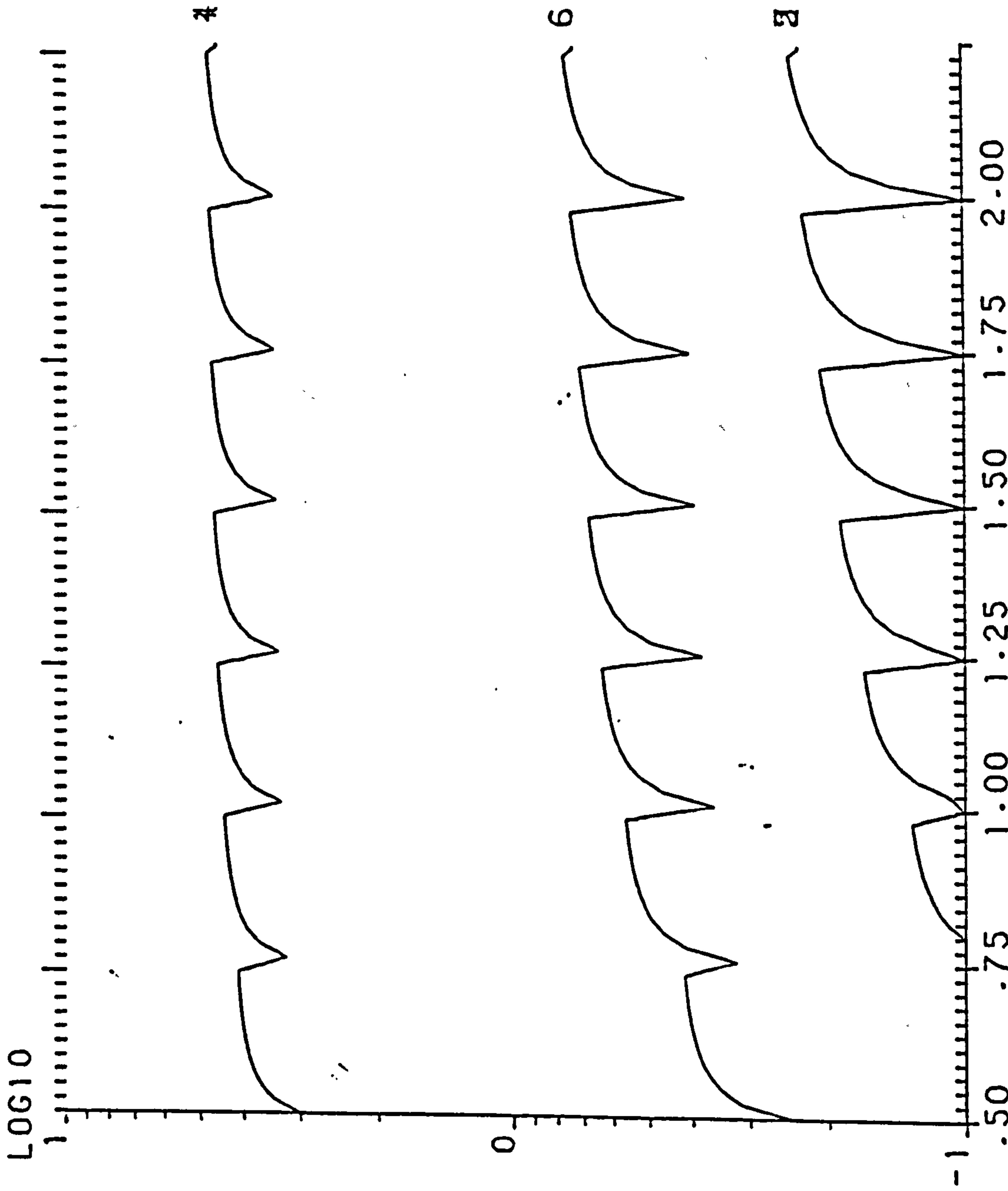

S. EFFICIENCY W. THICKNESS = .12M W. ORIENTATION = 22.50

WD = 1M HD1 = 22M HD2 = 6M HOUSE T = 1.5 ST.





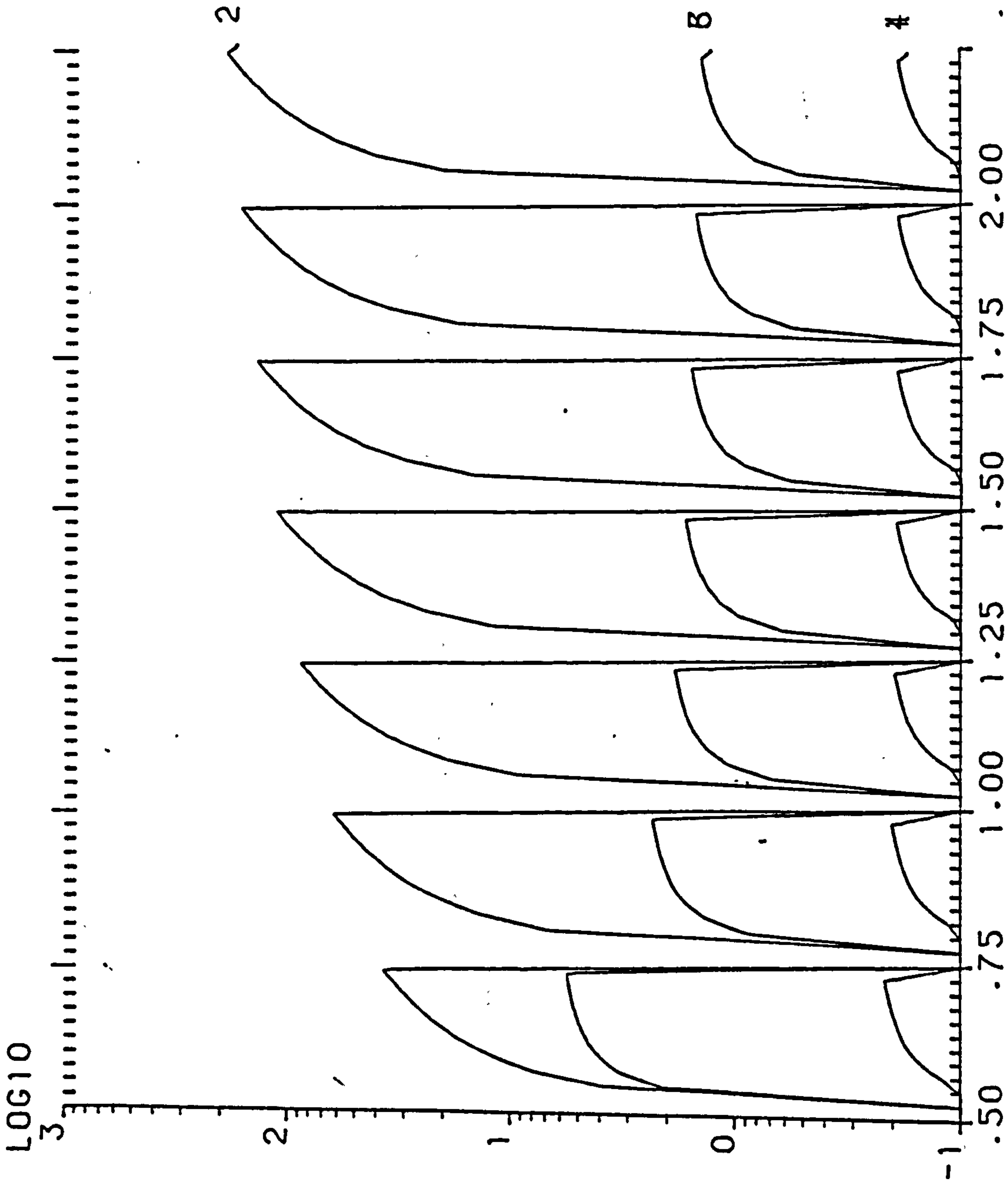

Y. EFFICIENCY W. THICKNESS= .12M W. ORIENTATION= 45.00

WD= 1M HD1= 22M HD2= 6M HOUSE T.=1.5 ST.

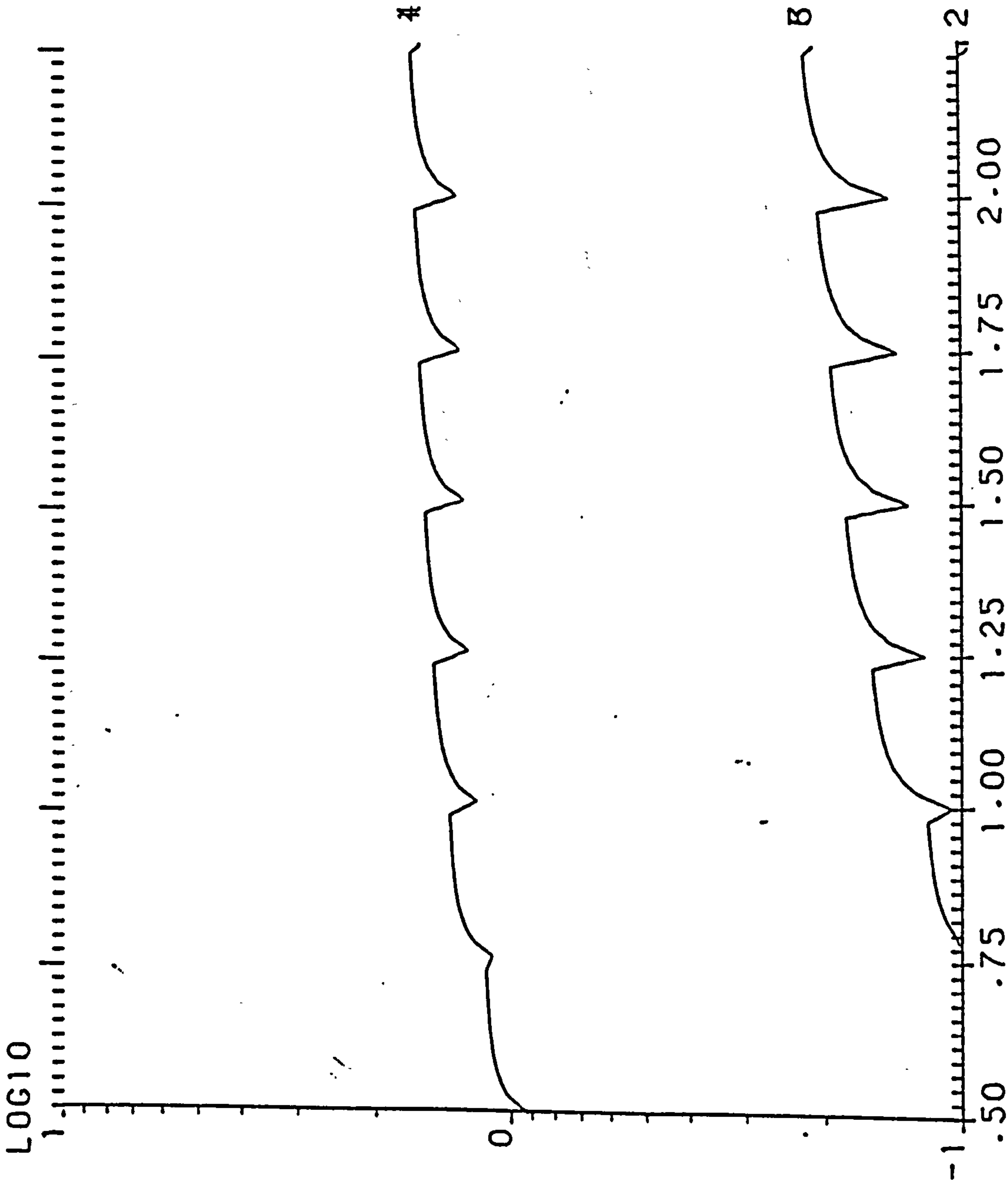

S. EFFICIENCY W. THICKNESS= .12M W. ORIENTATION= 45.00

WD= 1M HD1= 22M HD2= 6M HOUSE T.=1.5 ST.



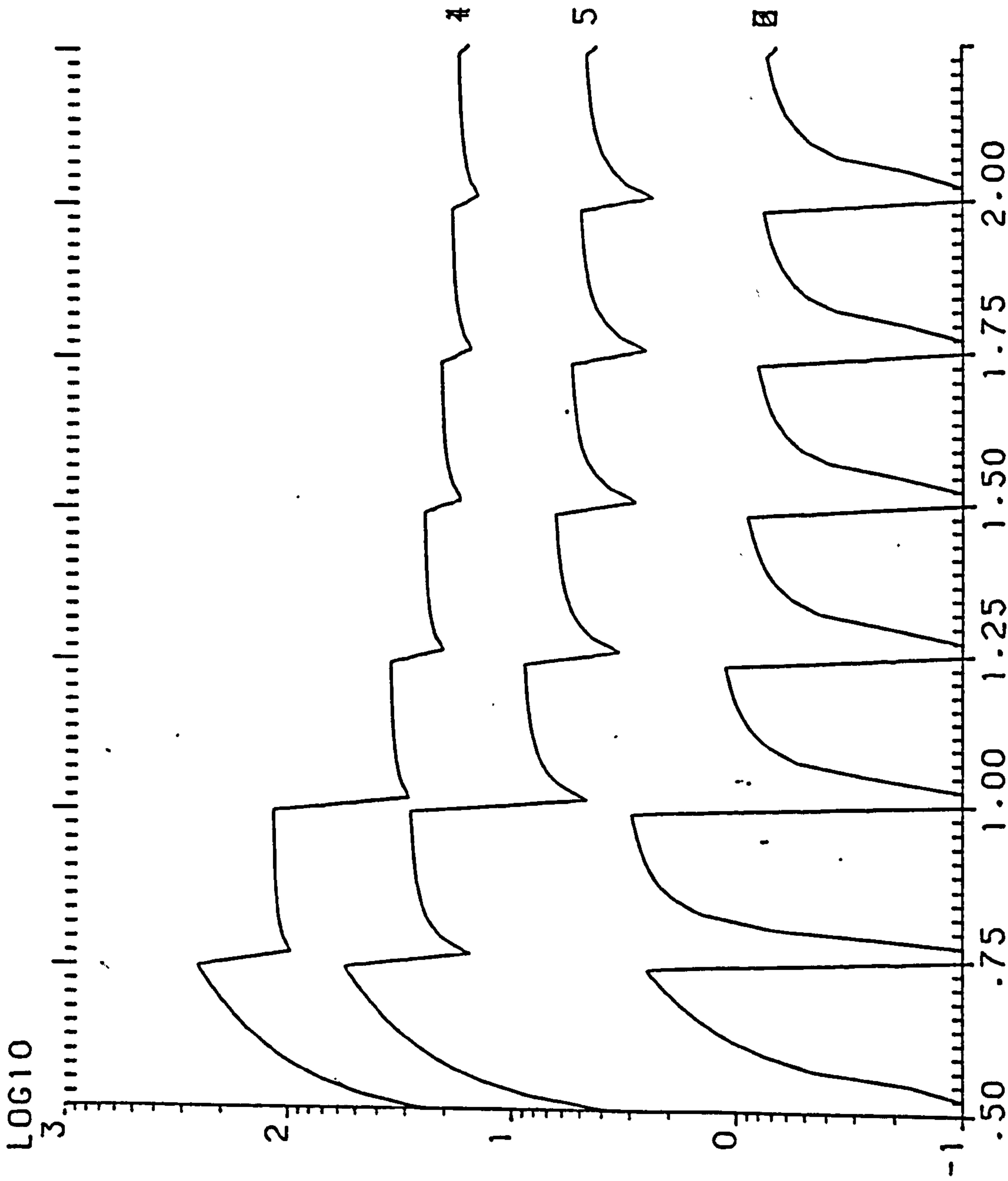

Y. EFFICIENCY W. THICKNESS= .12M W. ORIENTATION= 67.50

WD= 1M HD1= 22M HD2= 6M HOUSE T.=1.5 ST.

LOG10  
3  
2  
1  
0  
-1

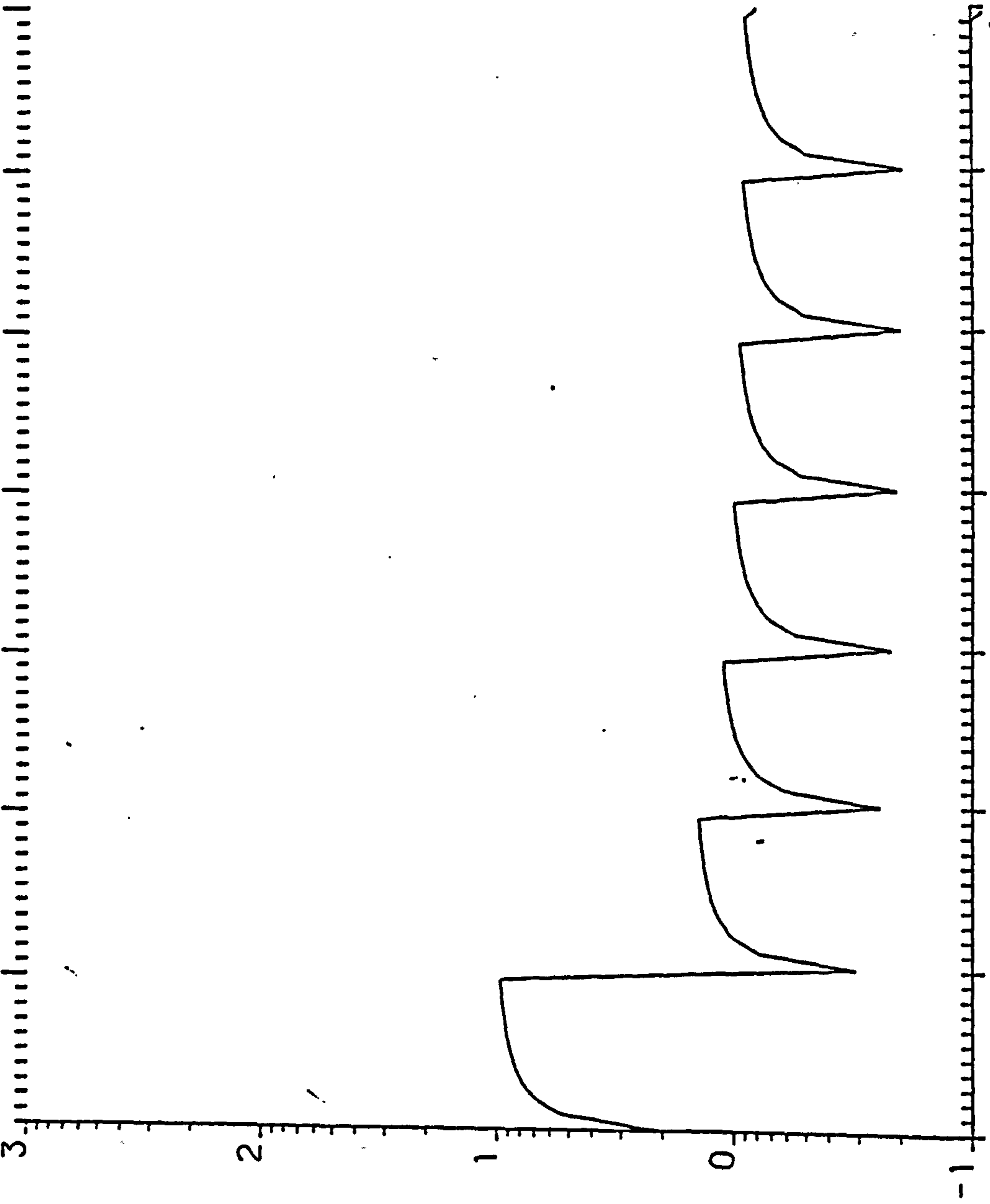

Y. EFFICIENCY W. THICKNESS= .12M W. ORIENTATION= 90.00

WD= 1M HD1= 22M HD2= 6M HOUSE T.=1.5 ST.

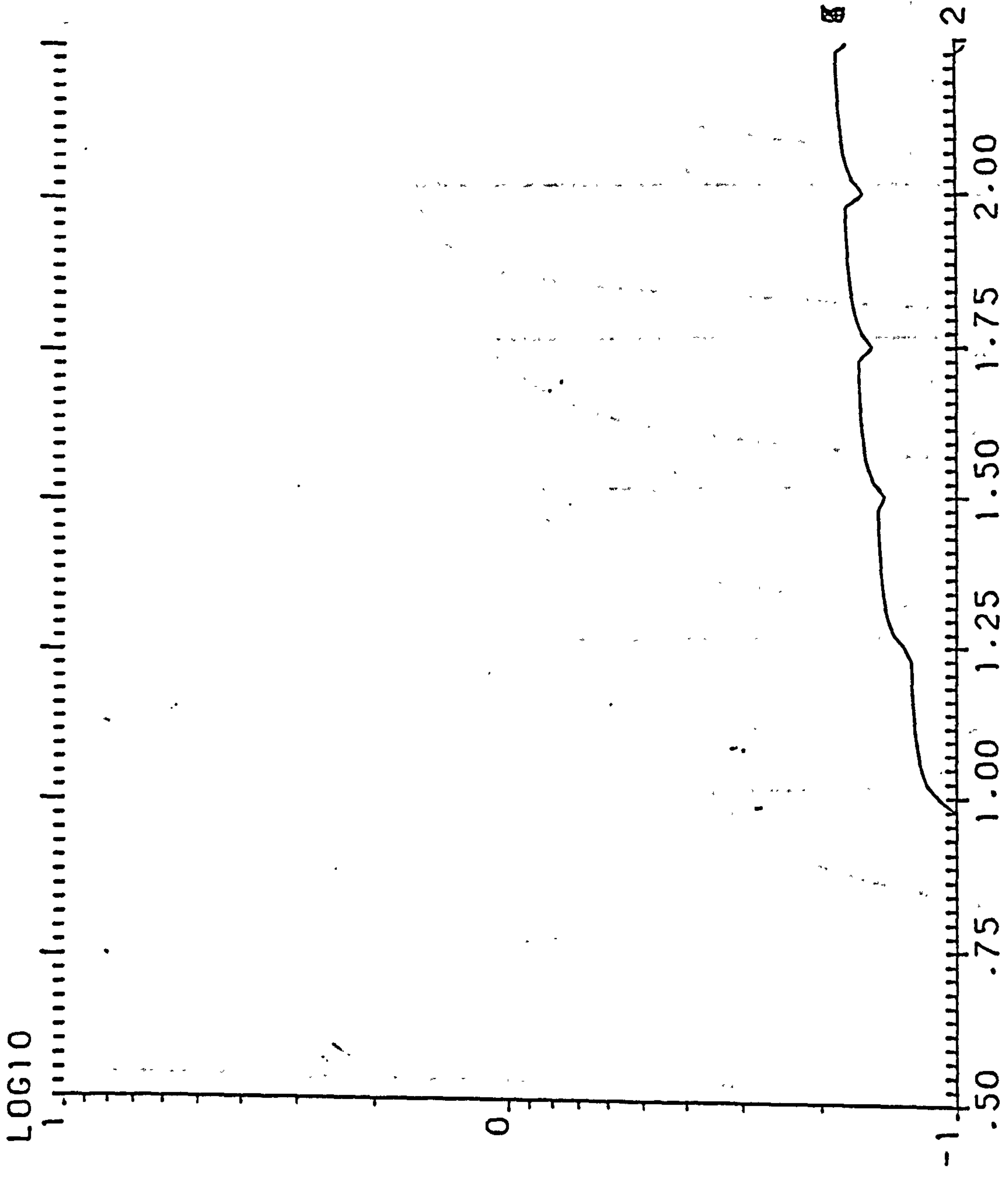

S. EFFICIENCY W. THICKNESS= .12M W. ORIENTATION= 90.00

WD= 1M HD1= 22M HD2= 6M HOUSE T.=1.5 ST.





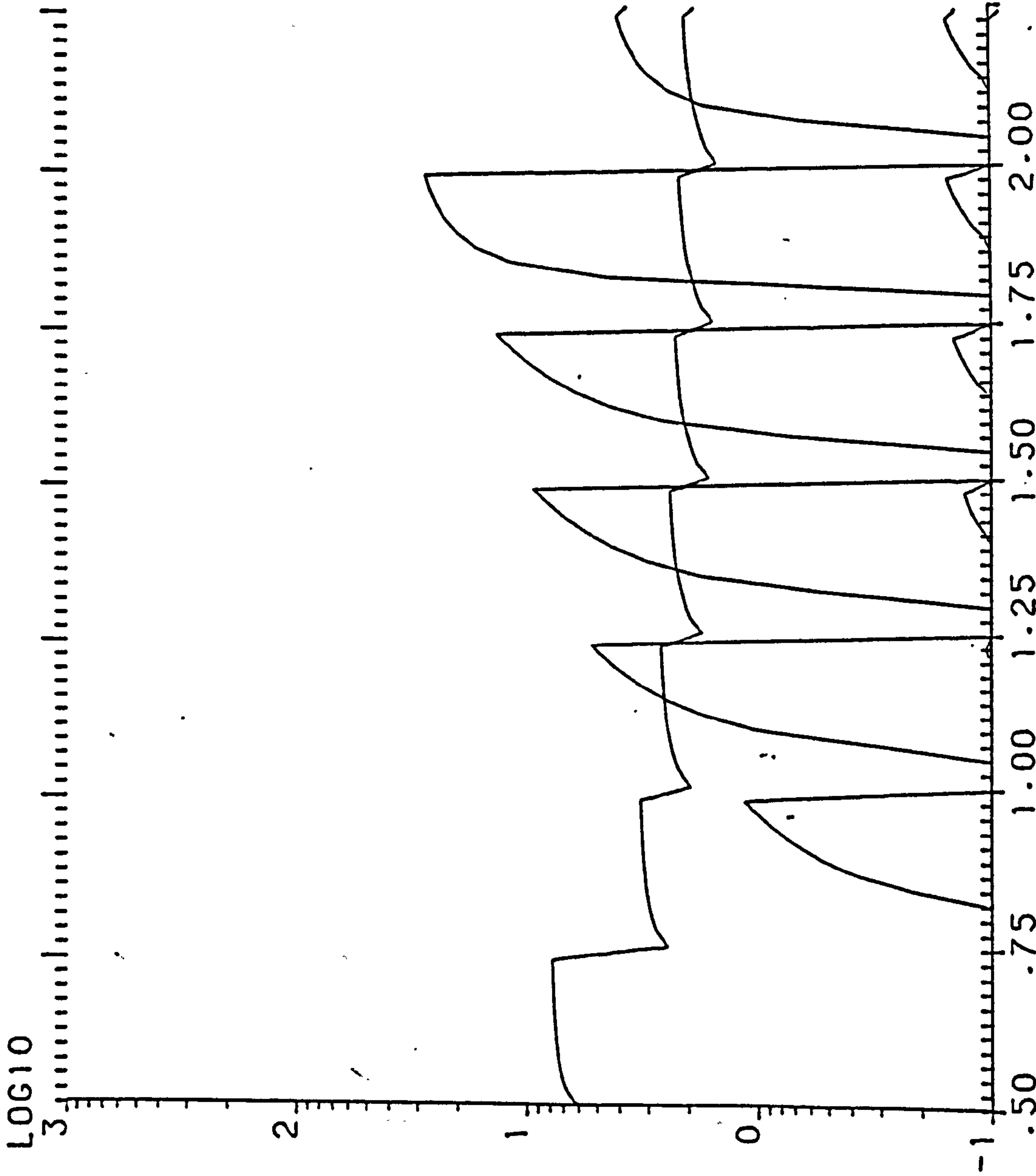

Y. EFFICIENCY W. THICKNESS= .12M W. ORIENTATION=112.50

WD= 1M HD1= 22M HD2= 6M HOUSE T.=1.5 ST.

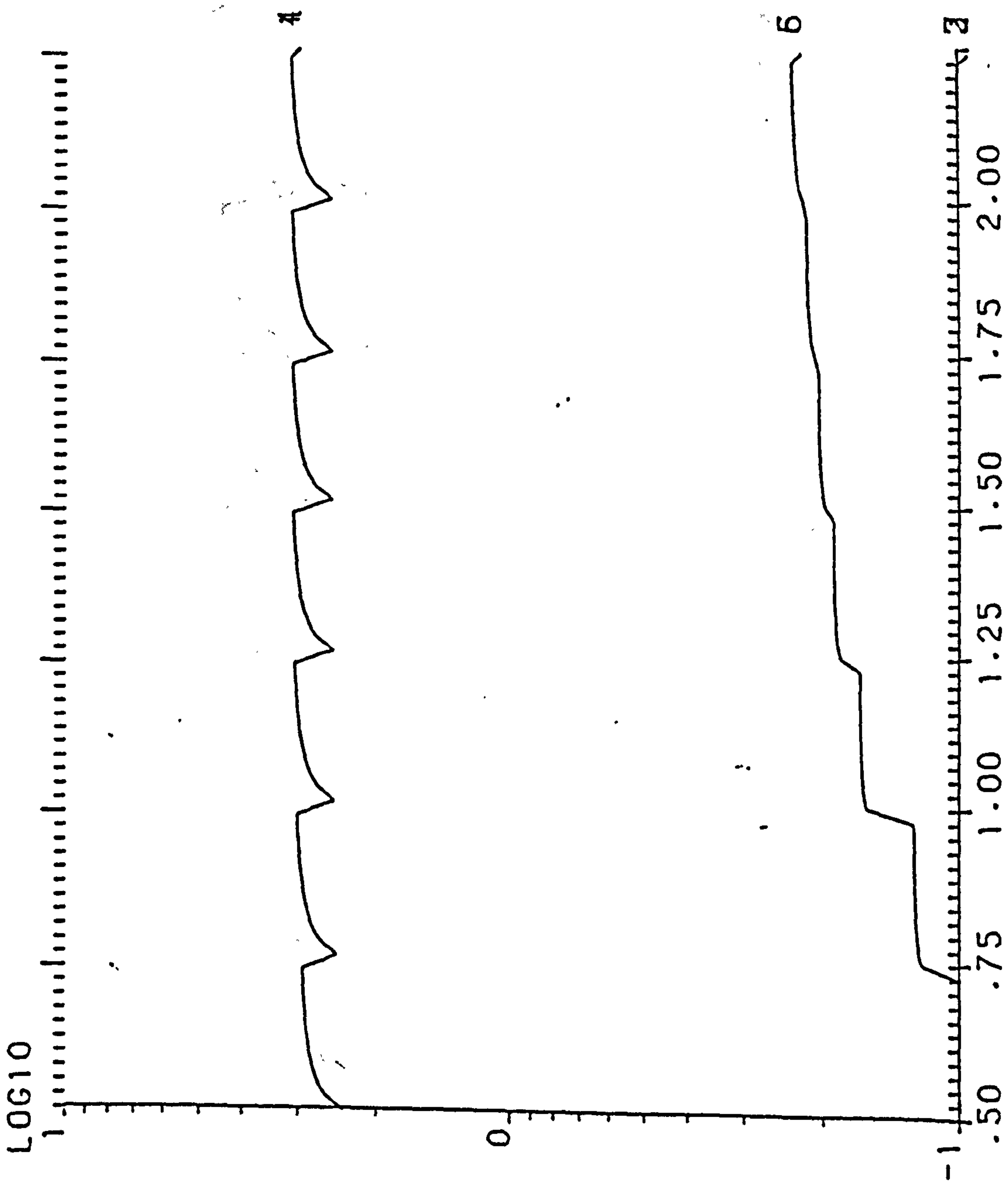

S. EFFICIENCY W. THICKNESS= .12M W. ORIENTATION=112.50  
 WD= 1M HD1= 22M HD2= 6M HOUSE T.=1.5 ST.



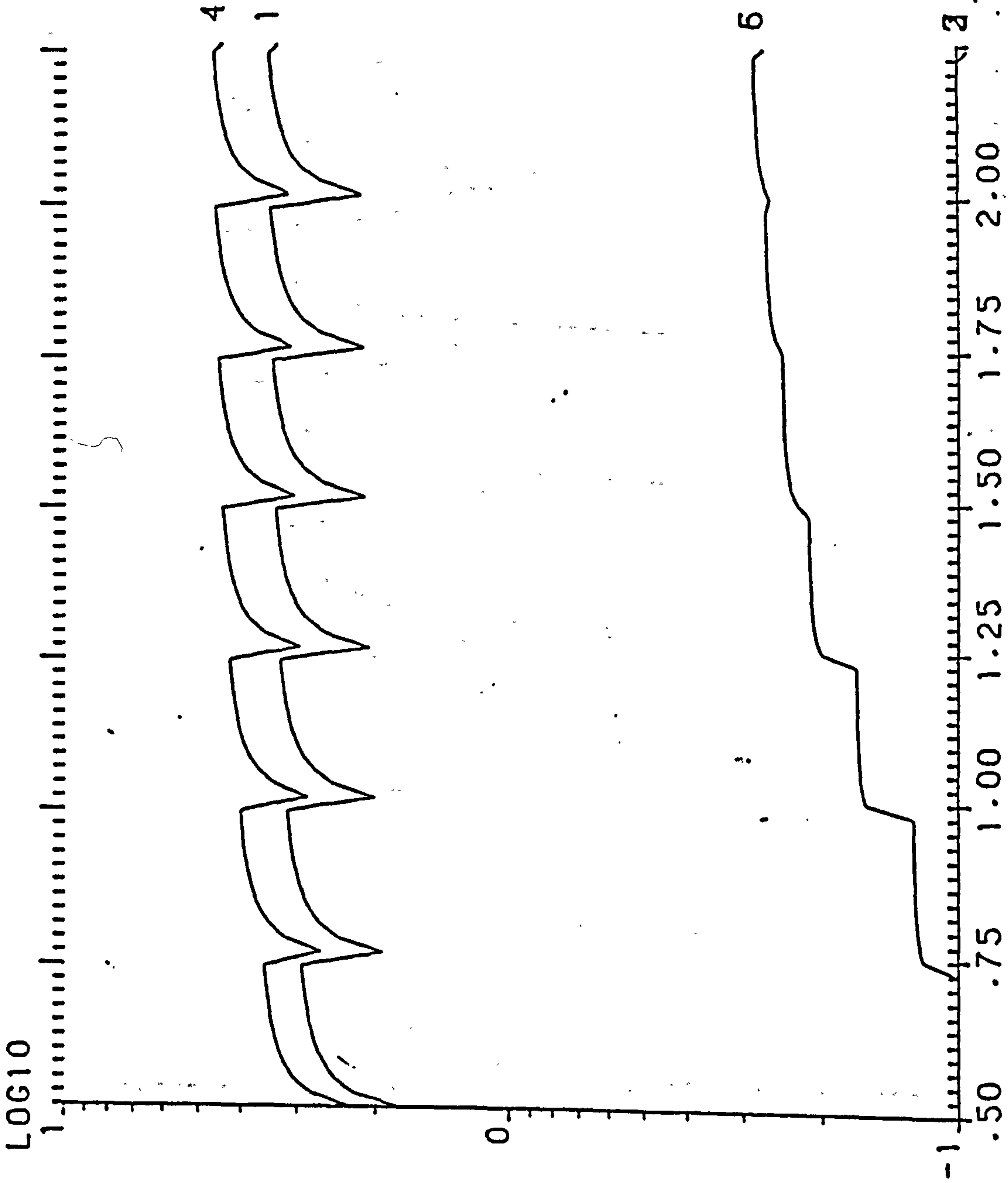

S. EFFICIENCY W. THICKNESS = .12M W. ORIENTATION=135.00

WD= 1M HD1= 22M HD2= 6M HOUSE T.=1.5 ST.



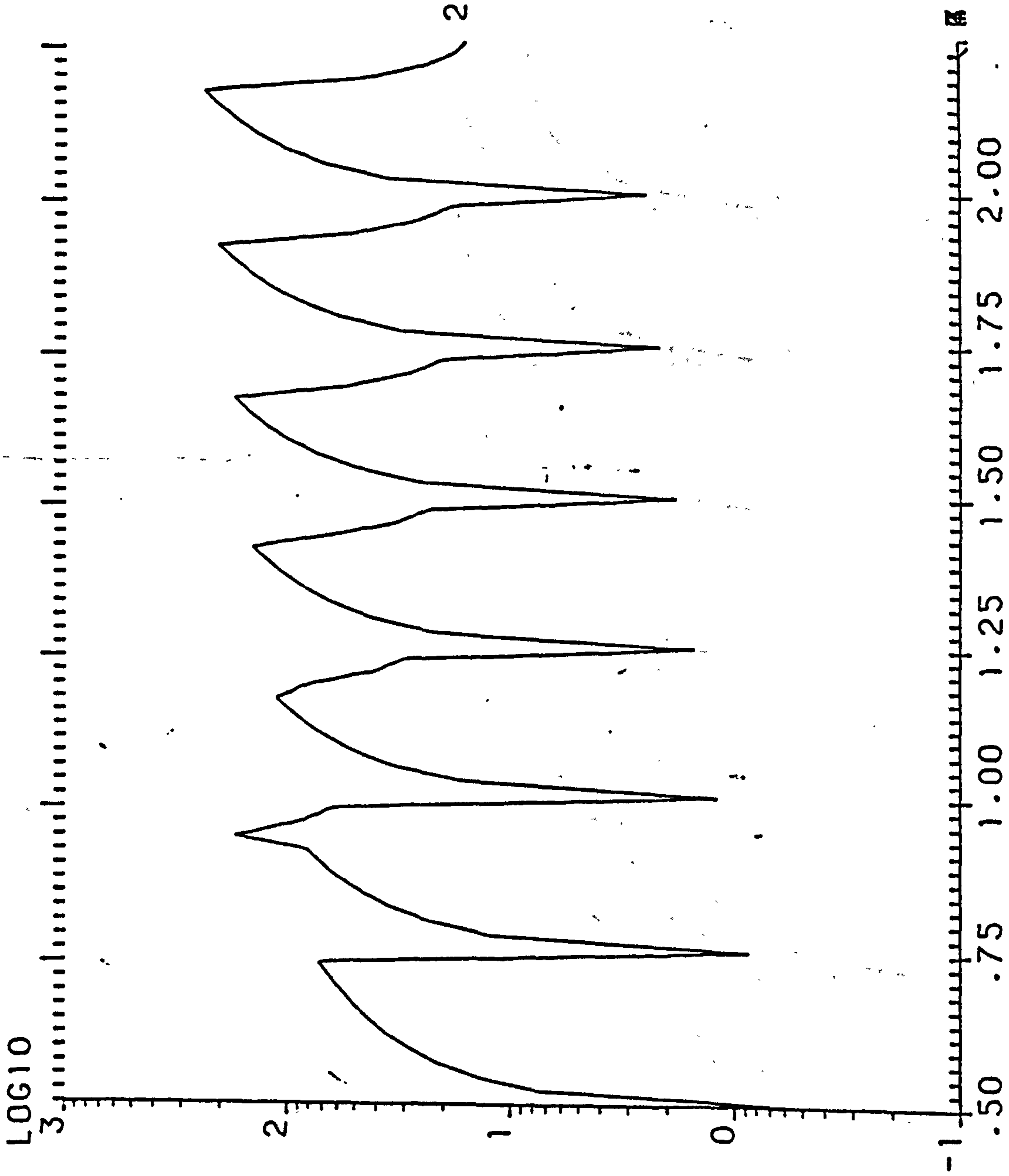

Y. EFFICIENCY W. THICKNESS= .12M W. ORIENTATION=157.50  
WD= 1M HD1= 22M HD2= 6M HOUSE T.=1.5 ST.

LOG10

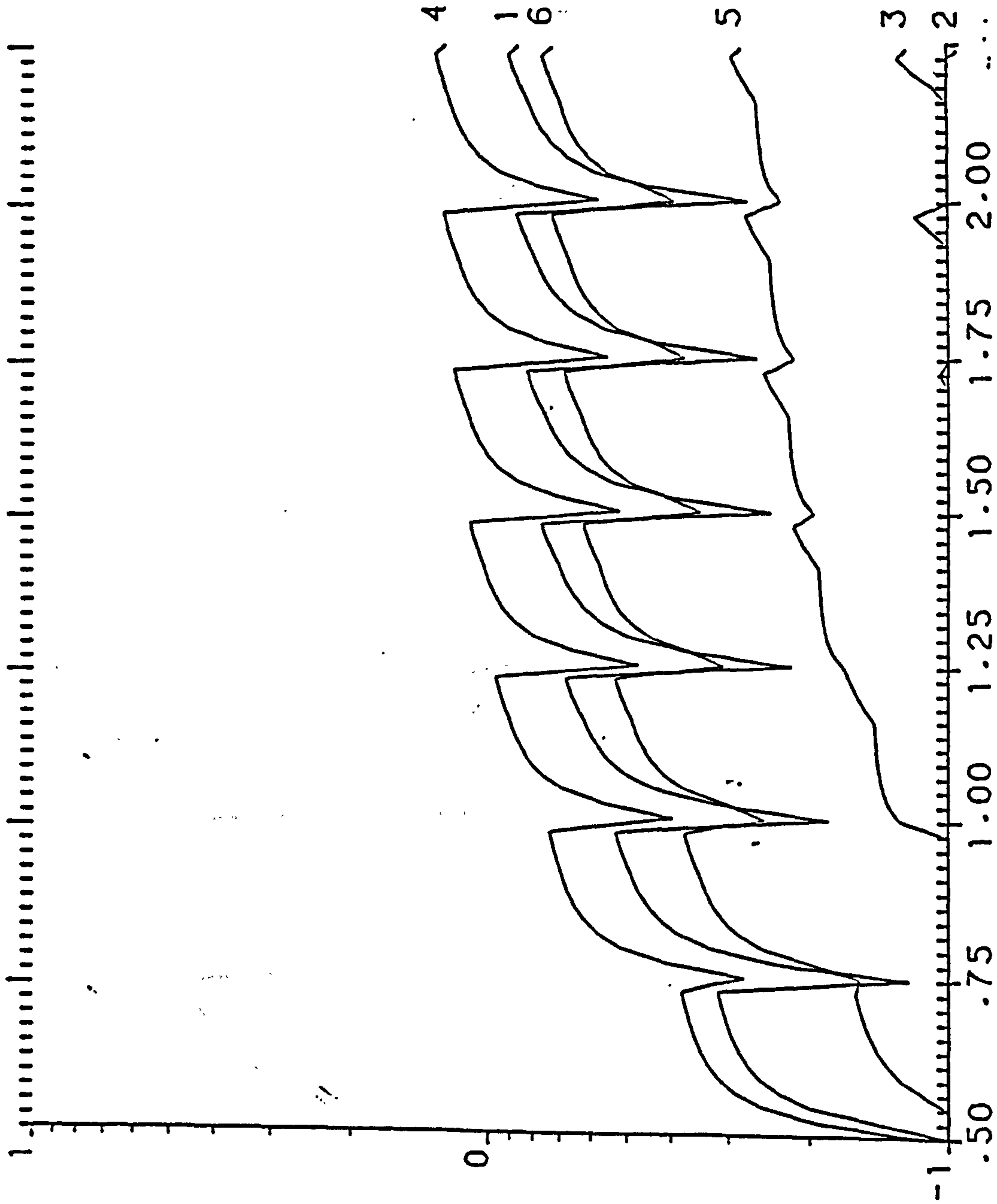

S. EFFICIENCY W. THICKNESS= .12M W. ORIENTATION=157.50

WD= 1M HD1= 22M HD2= 6M HOUSE T.=1.5 ST.



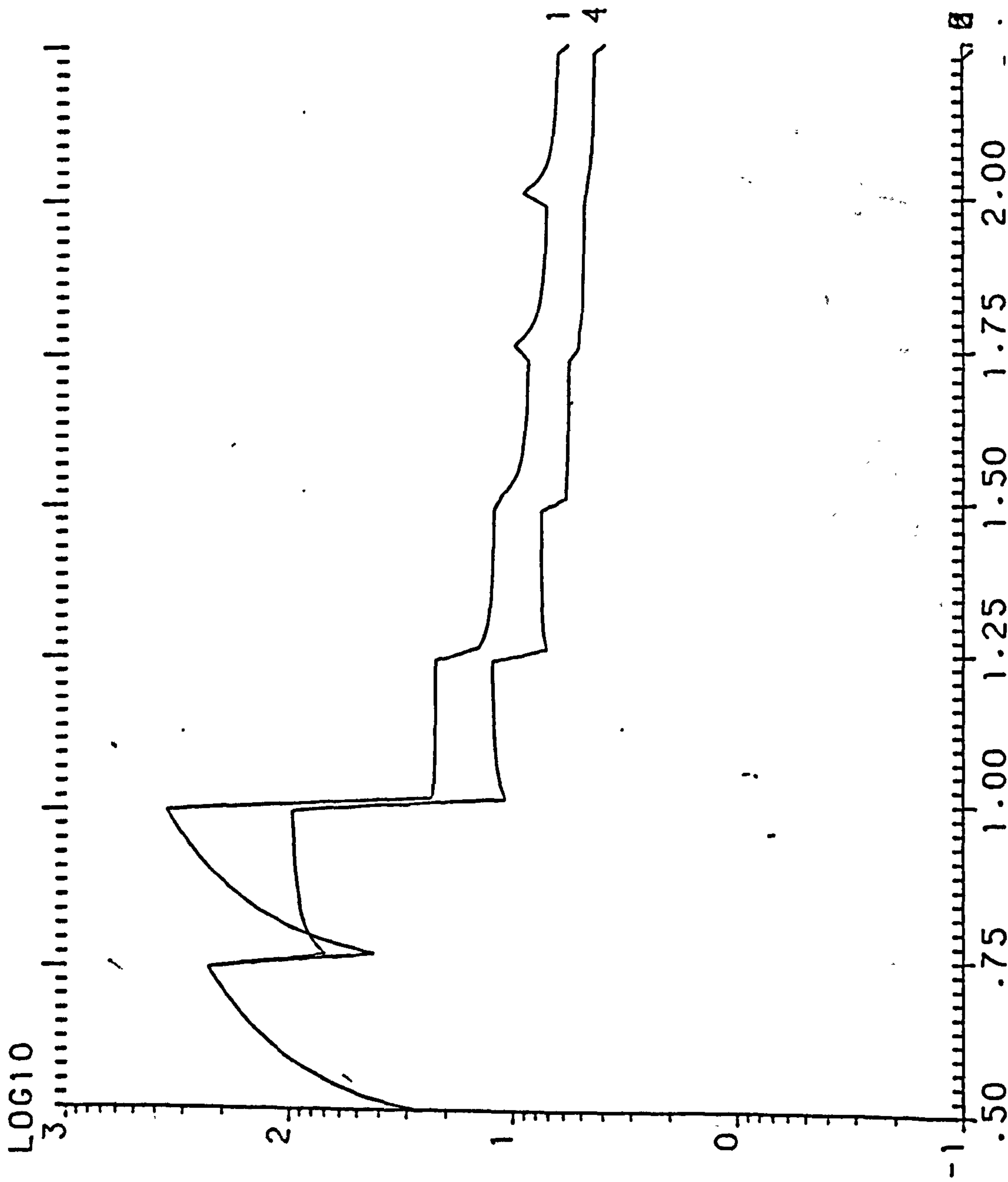

Y. EFFICIENCY W. THICKNESS= .12M W. ORIENTATION=180.00

WD= 1M HD1= 22M HD2= 6M HOUSE T.=1.5 ST.

LOG10  
1  
0  
-1

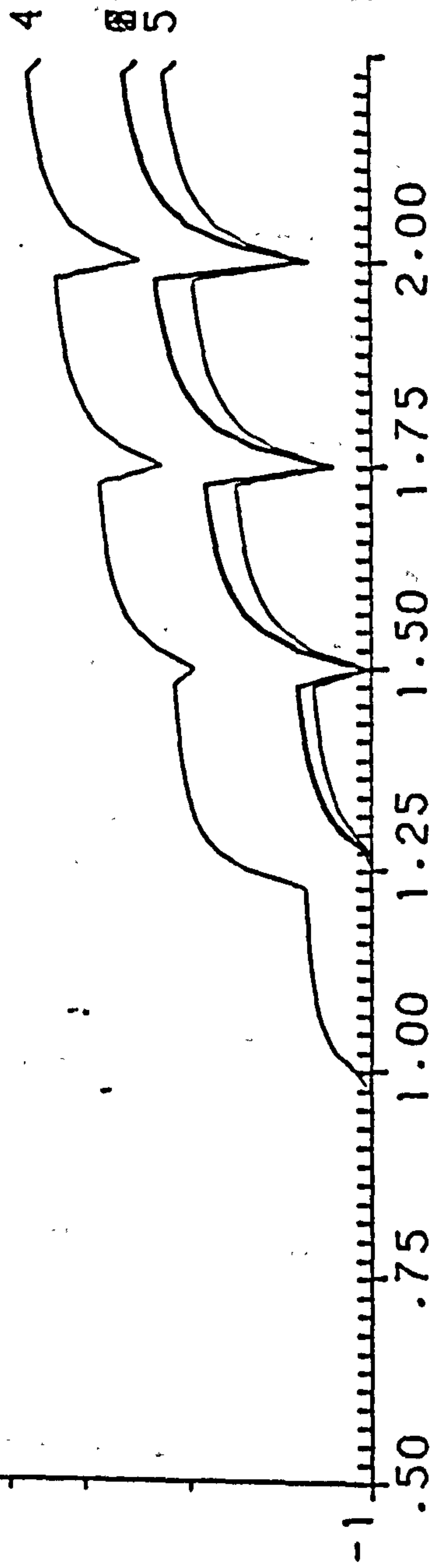

S. EFFICIENCY W. THICKNESS= .12M W. ORIENTATION=180.00

WD= 1M HD1= 22M HD2= 6M HOUSE T.=1.5 ST.



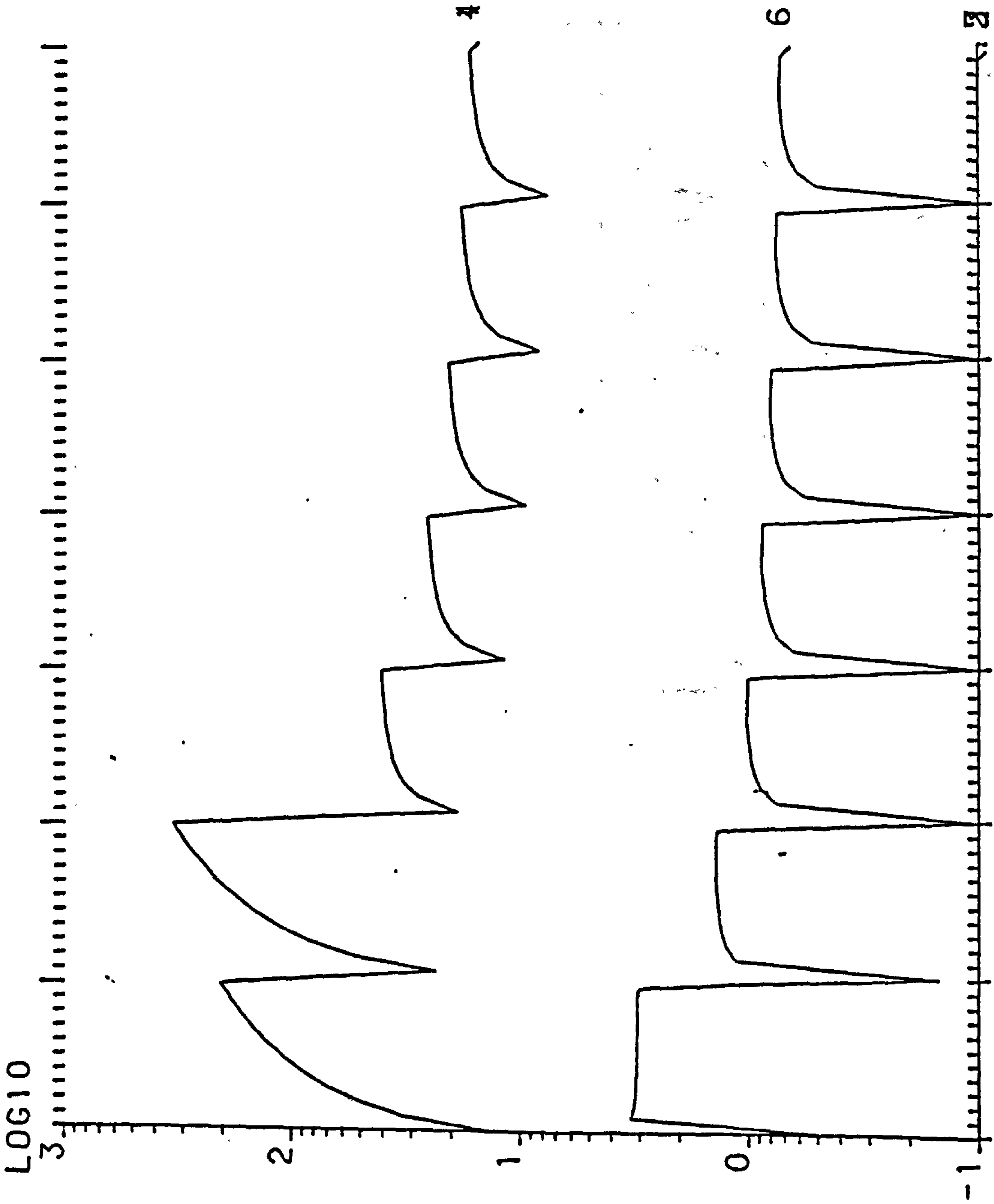

Y. EFFICIENCY W. THICKNESS= .12M W. ORIENTATION=202.50

WD= 1M HD1= 22M HD2= 6M HOUSE T.=1.5 ST.

LOG10  
1  
0  
-1

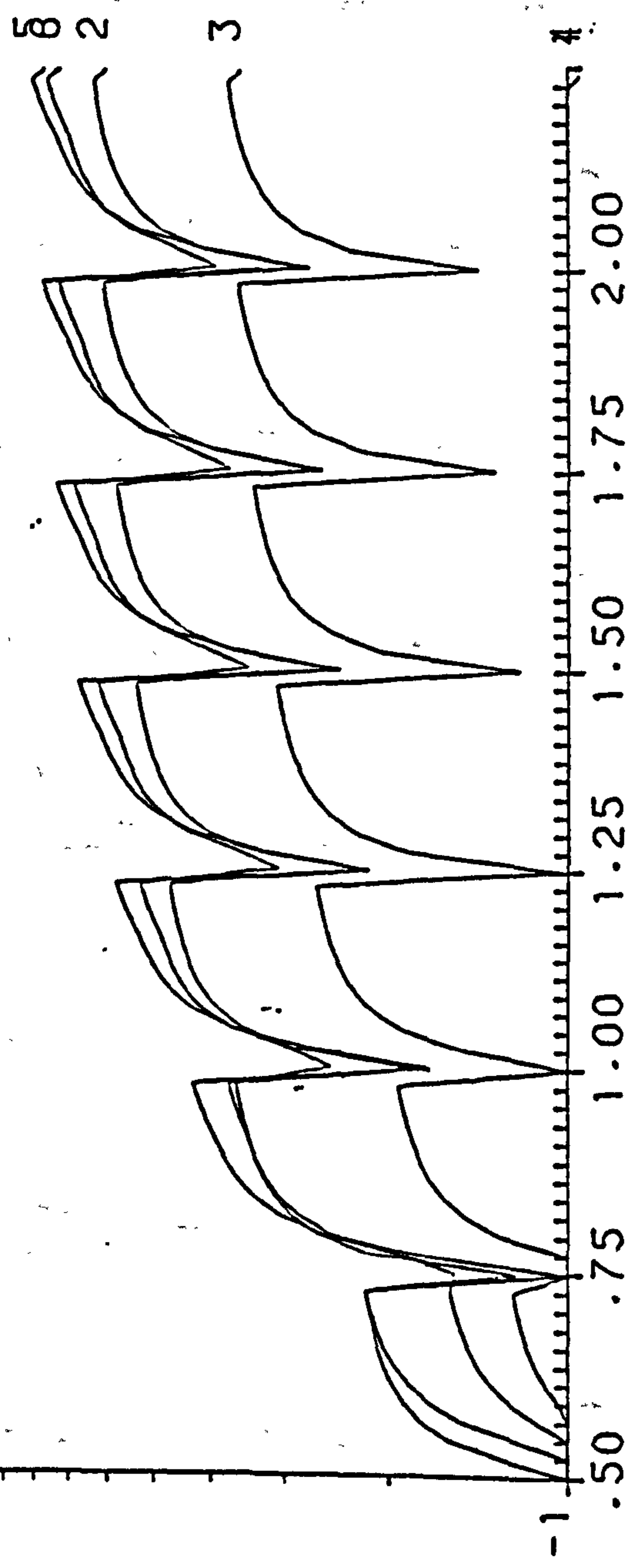

S. EFFICIENCY W. THICKNESS = .12M W. ORIENTATION = 202.50

WD = 1M HD1 = 22M HD2 = 6M HOUSE T. = 1.5 ST.



LOG10  
3

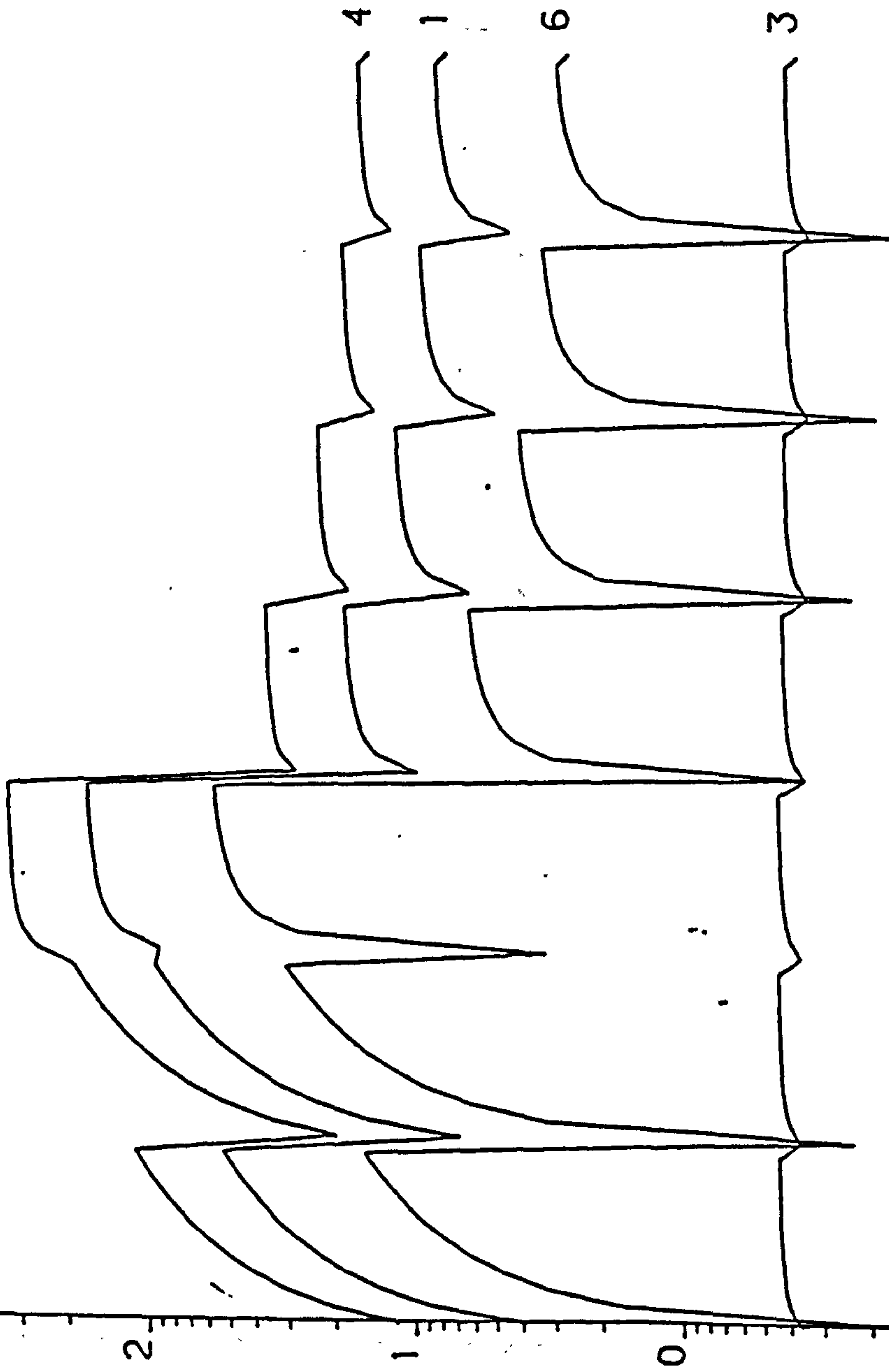

-1  
 .50 .75 1.00 1.25 1.50 1.75 2.00  
 Y. EFFICIENCY W. THICKNESS= .12M W. ORIENTATION=225.00  
 WD= 1M HD1= 22M HD2= 6M HOUSE T.=1.5 ST.

LOG10  
1

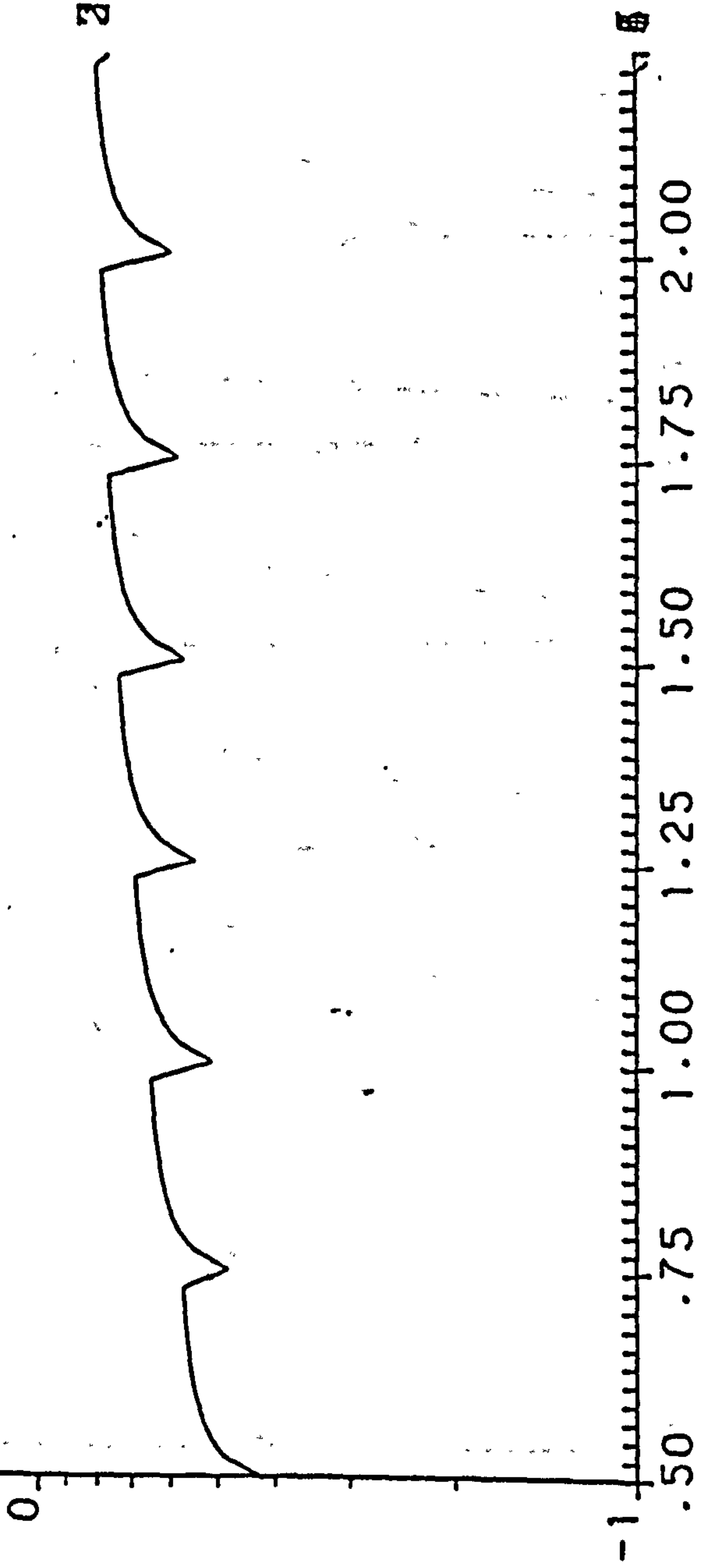

S. EFFICIENCY W. THICKNESS= .12M W. ORIENTATION=225.00

WD= 1M HD1= 22M HD2= 6M HOUSE T.=1.5 ST.



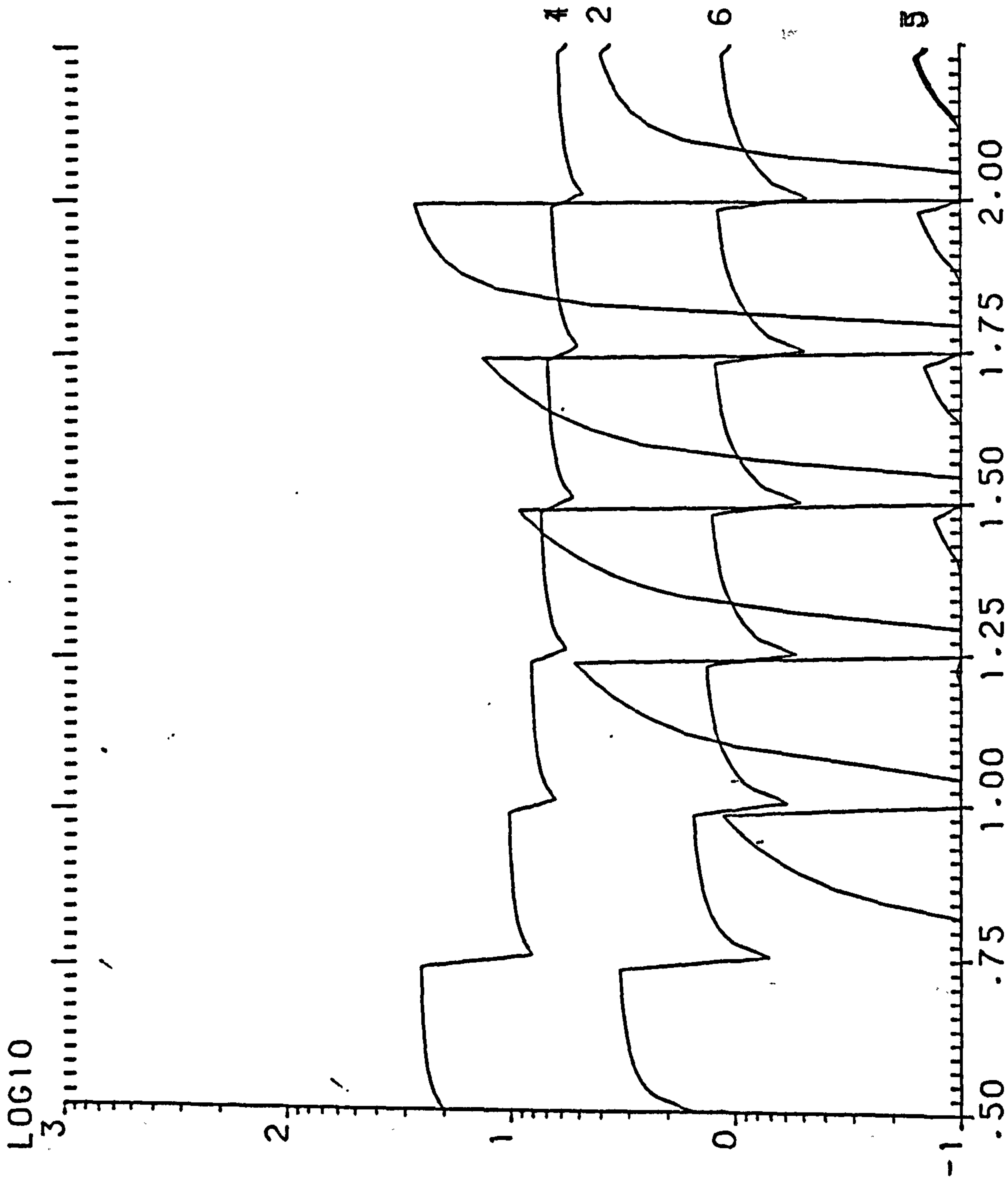

Y. EFFICIENCY W. THICKNESS= .12M W. ORIENTATION=247.50

WD= 1M HD1= 22M HD2= 6M HOUSE T.=1.5 ST.

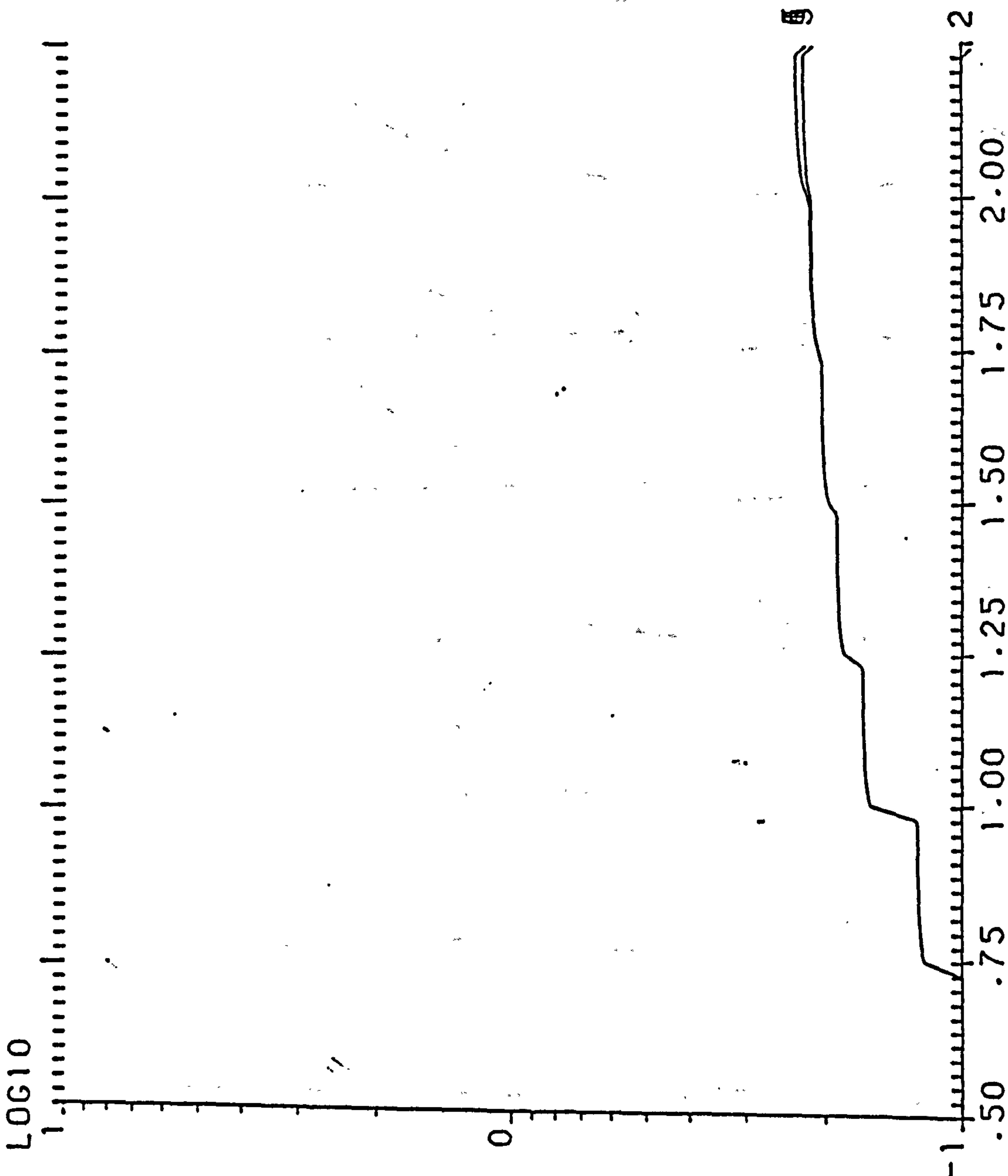

S. EFFICIENCY W: THICKNESS= .12M: W. ORIENTATION=247.50

WD= 1M HD1= 22M HD2= 6M HOUSE T.=1.5 ST.

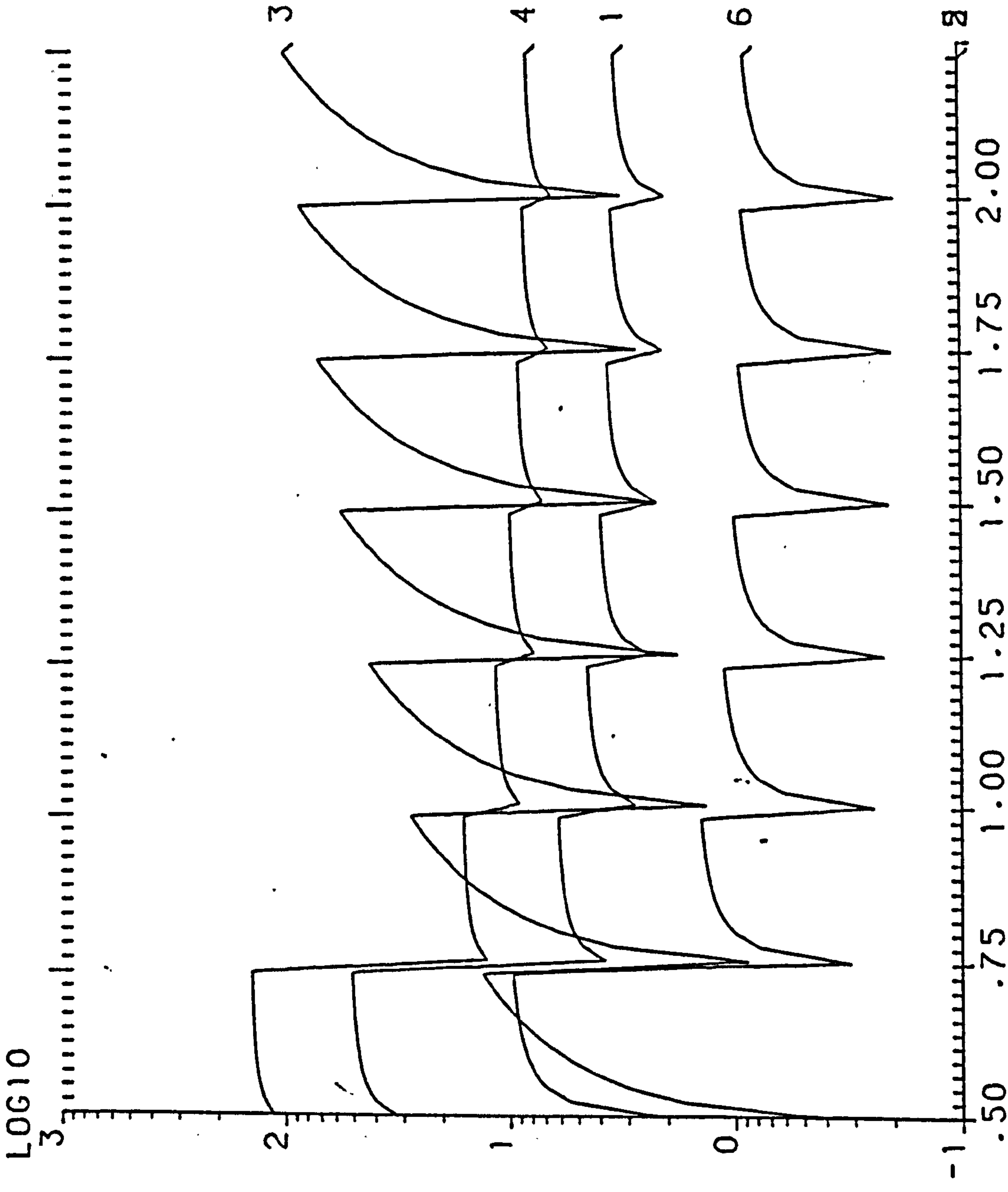

Y. EFFICIENCY W. THICKNESS= .12M W. ORIENTATION=270.00

WD= 1M HD1= 22M HD2= 6M HOUSE T.=1.5 ST.



LOG10  
1

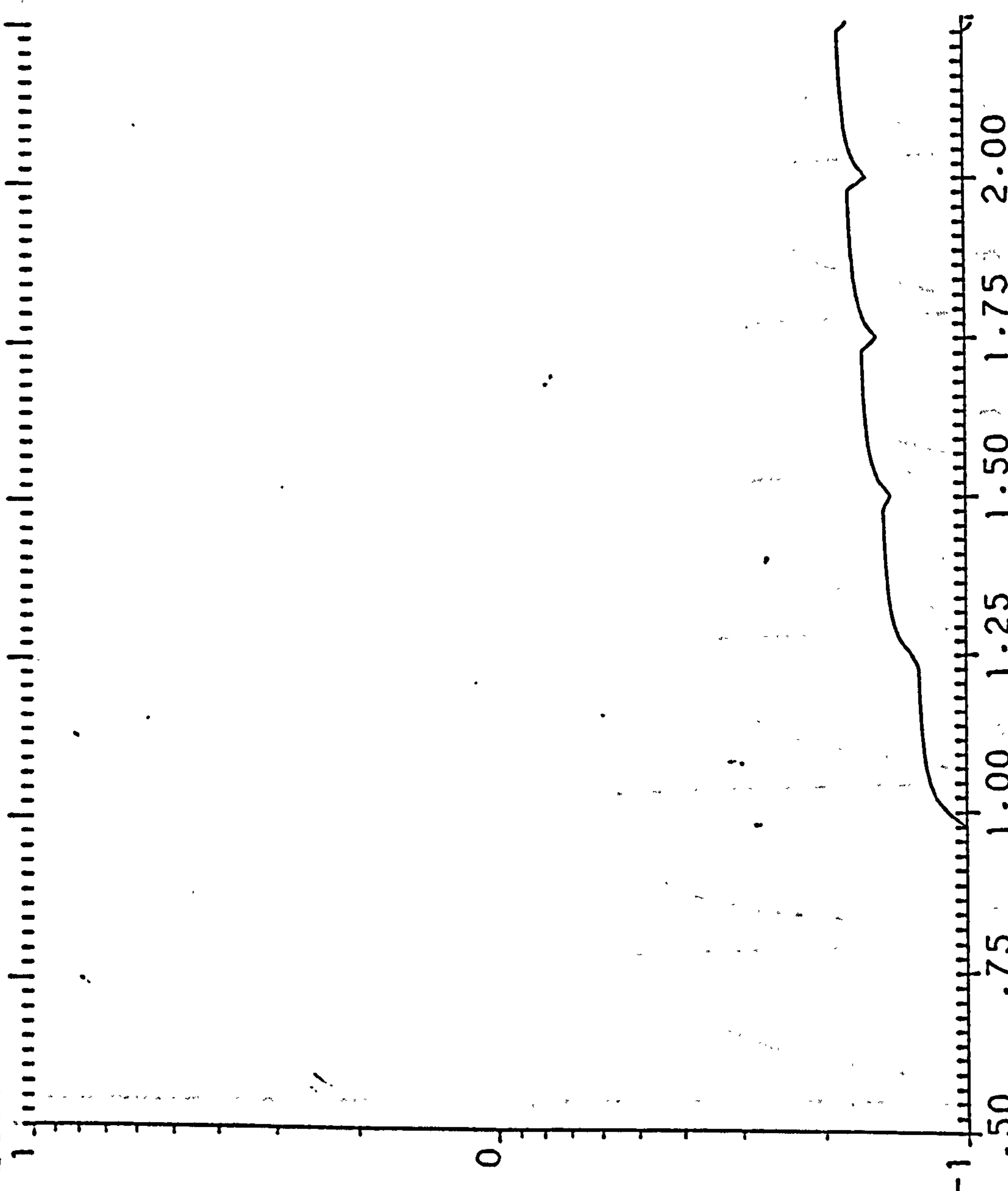

S. EFFICIENCY W. THICKNESS= .12M W. ORIENTATION=270.00

WD= 1M HD1= 22M HD2= 6M HOUSE T.=1.5 ST.



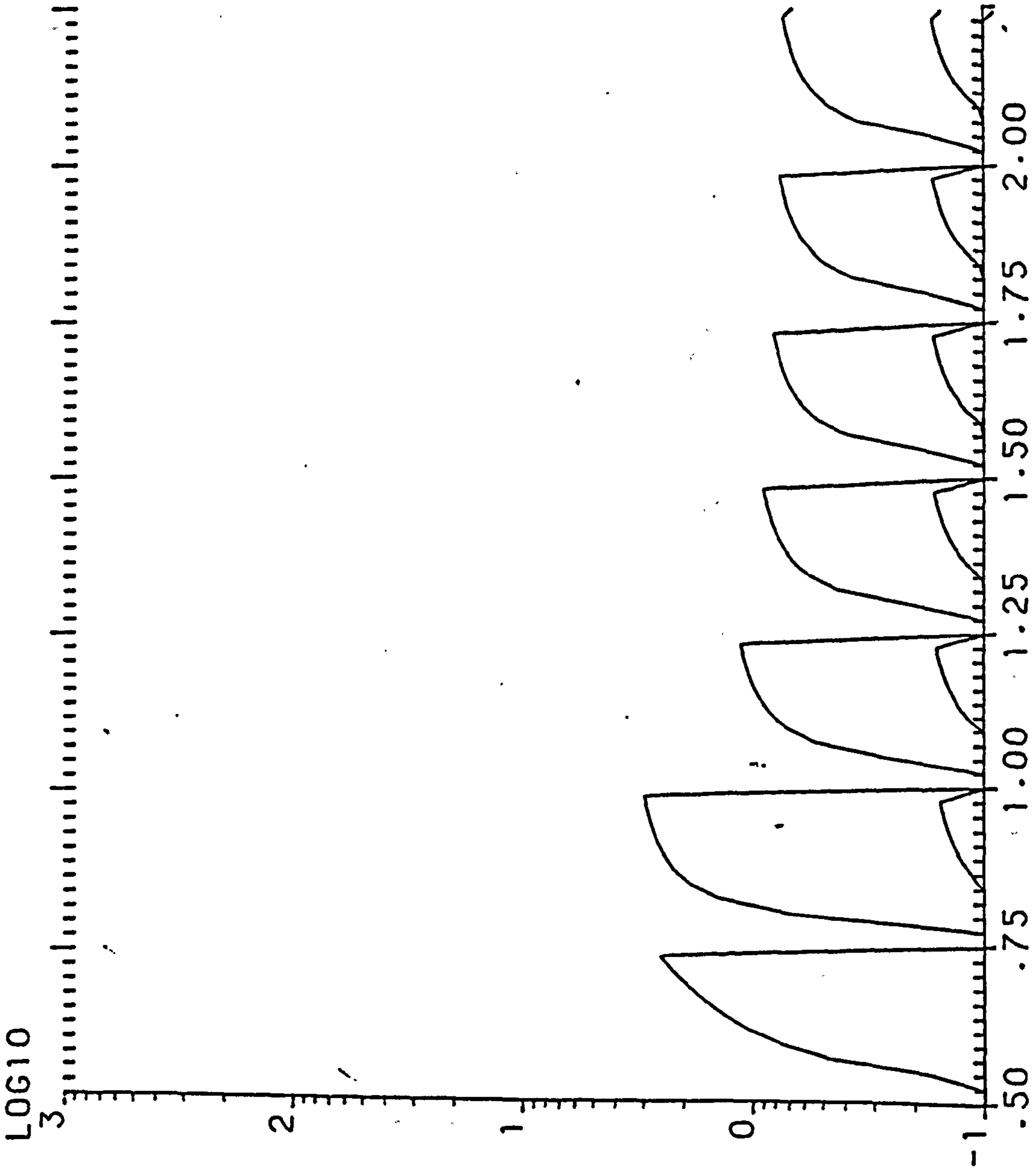

Y. EFFICIENCY W. THICKNESS= .12M W. ORIENTATION=292.50

WD= 1M HD1= 22M HD2= 6M HOUSE T.=1.5 ST.

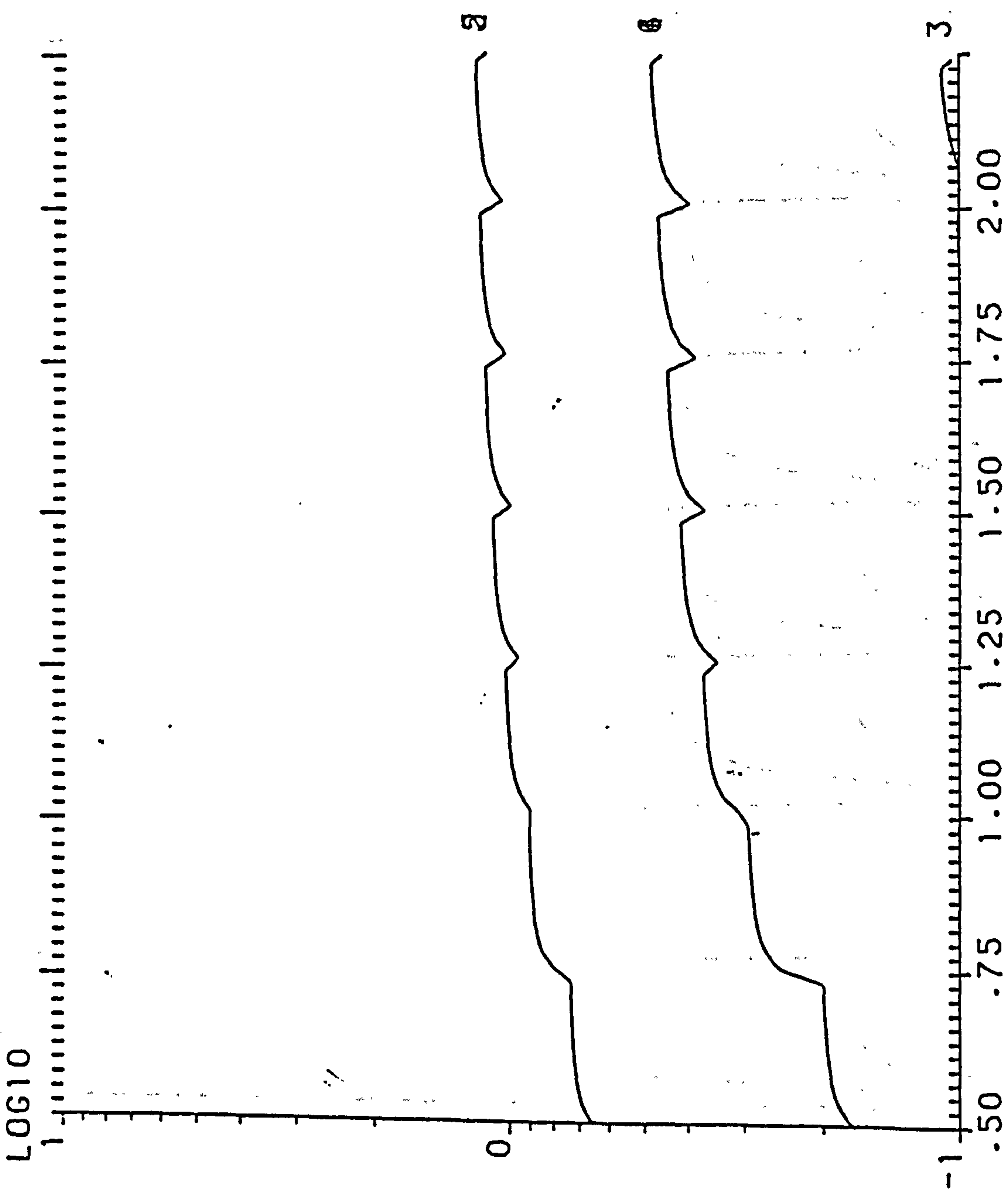

S. EFFICIENCY W. THICKNESS= .12M W. ORIENTATION=292.50

WD= 1M HD1= 22M HD2= 6M HOUSE T.=1.5 ST.





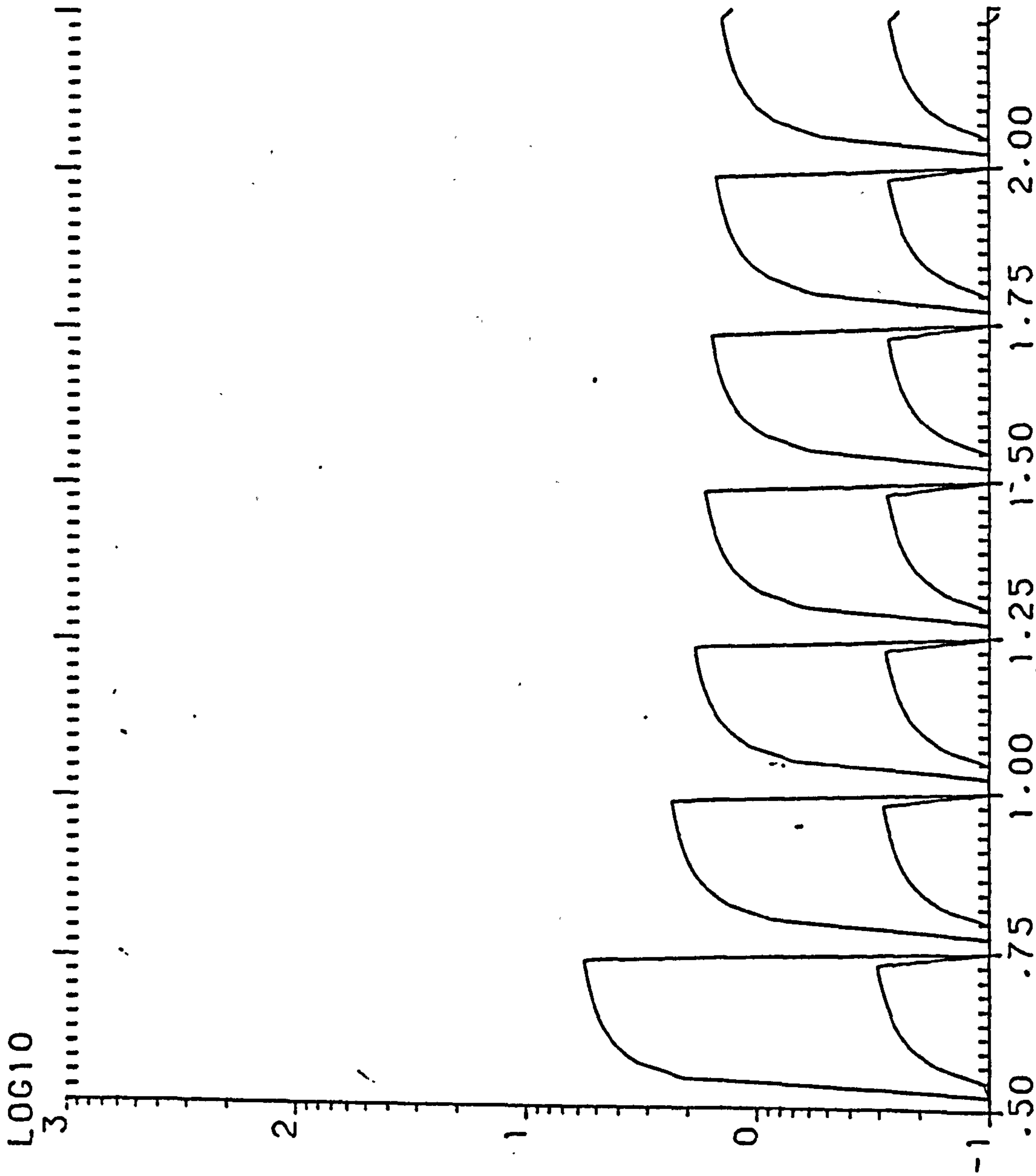

Y. EFFICIENCY W. THICKNESS= .12M W. ORIENTATION=315.00

WD= 1M HD1= 22M HD2= 6M HOUSE T.=1.5 ST.

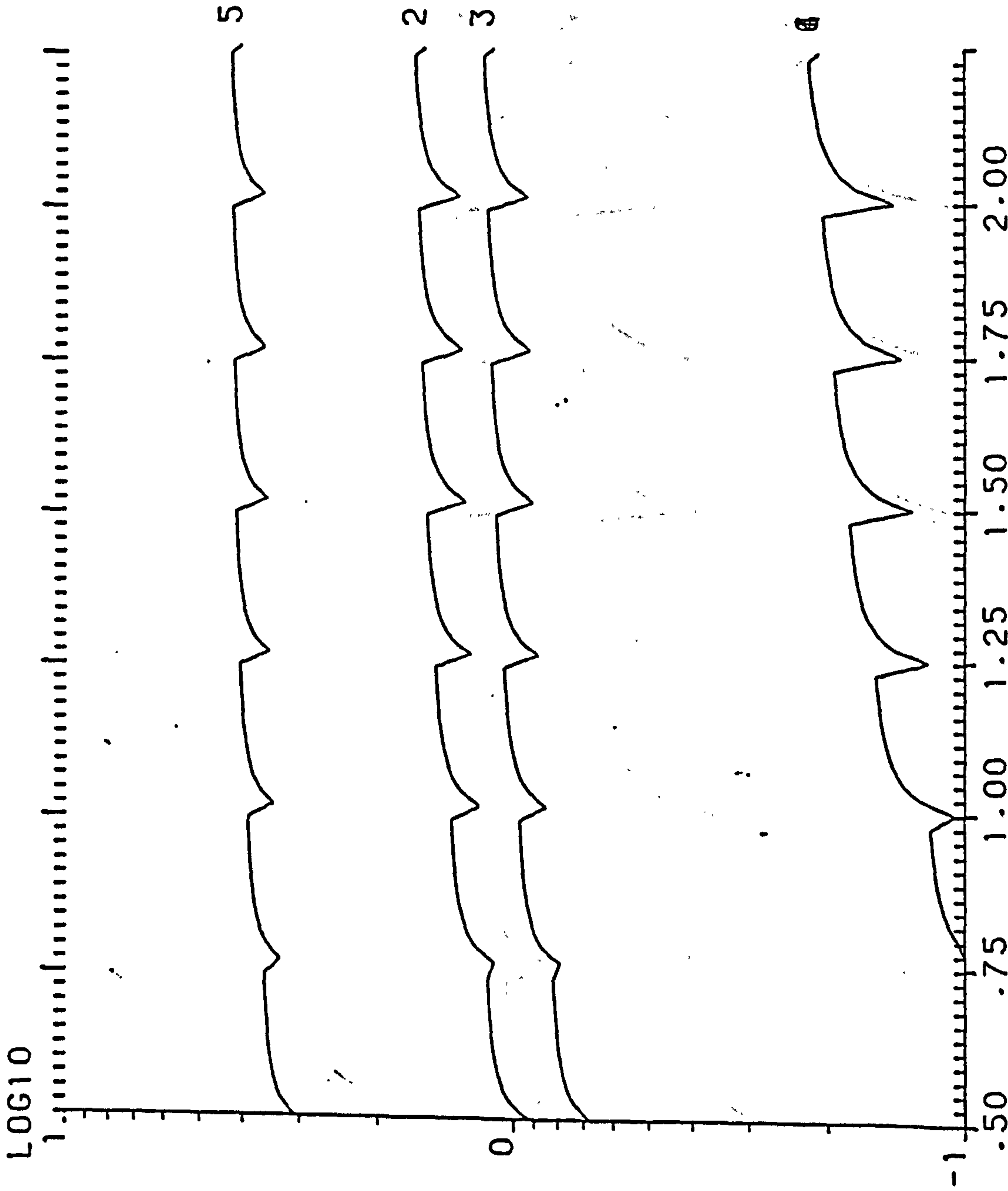

S. EFFICIENCY W. THICKNESS= .12M W. ORIENTATION=315.00

WD= 1M HD1= 22M HD2= 6M HOUSE T.=1.5 ST.

LOG10

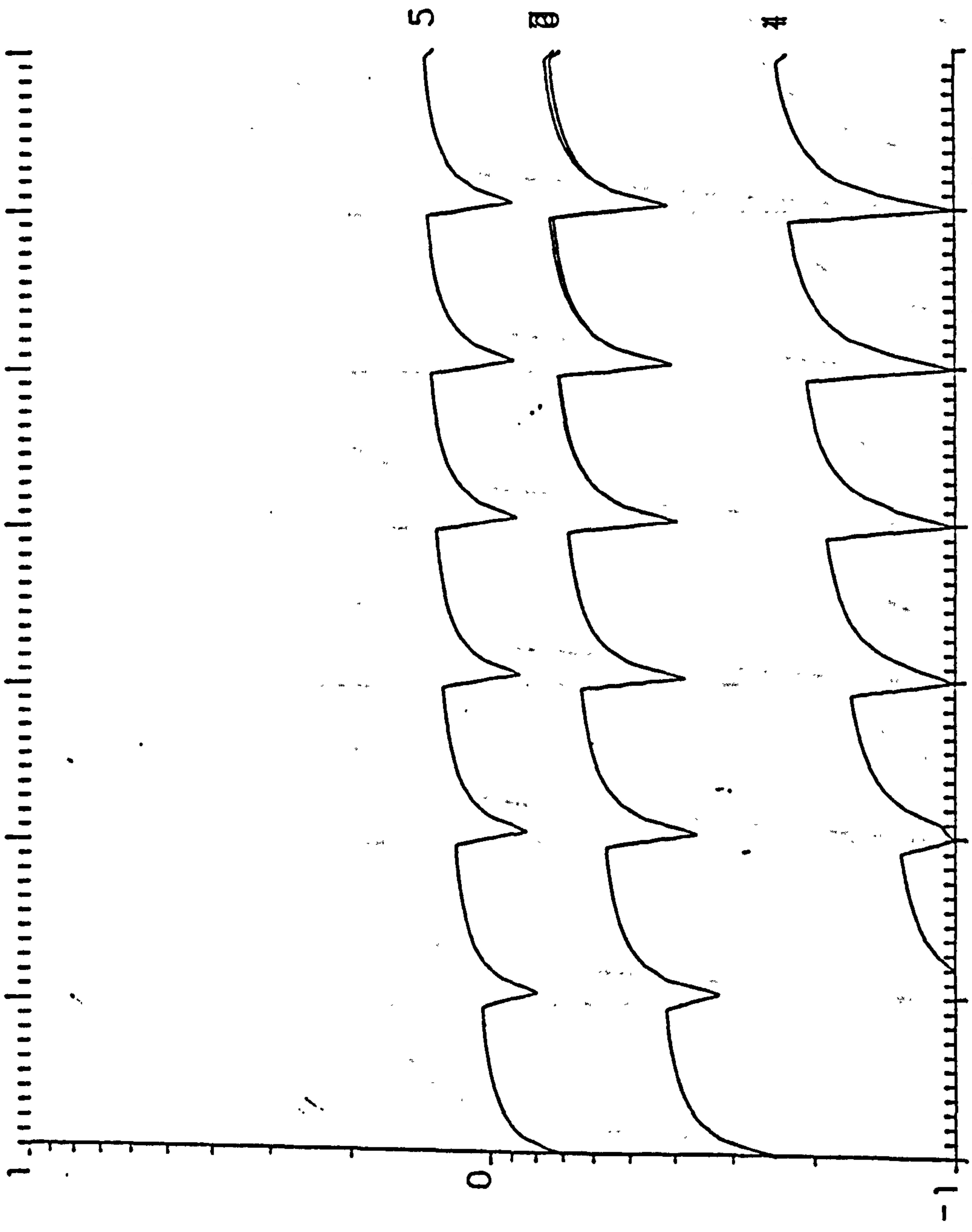

S. EFFICIENCY W. THICKNESS= .12M W. ORIENTATION=337.50

WD= 1M HD1= 22M HD2= 6M HOUSE T.=1.5 ST.

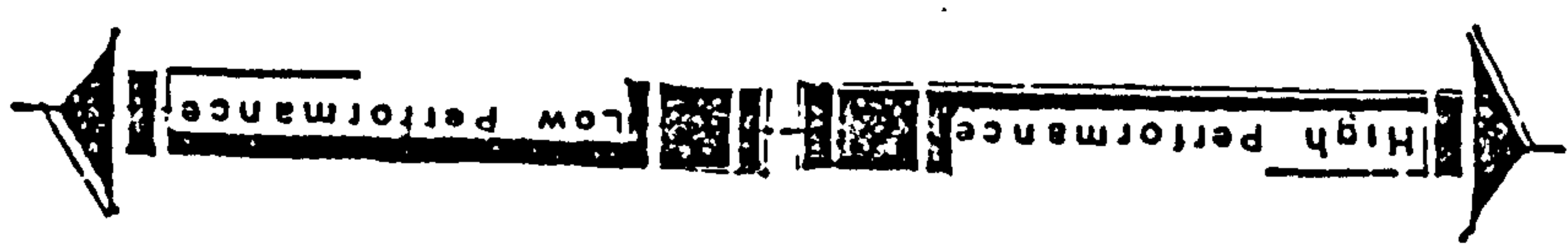



LOG10

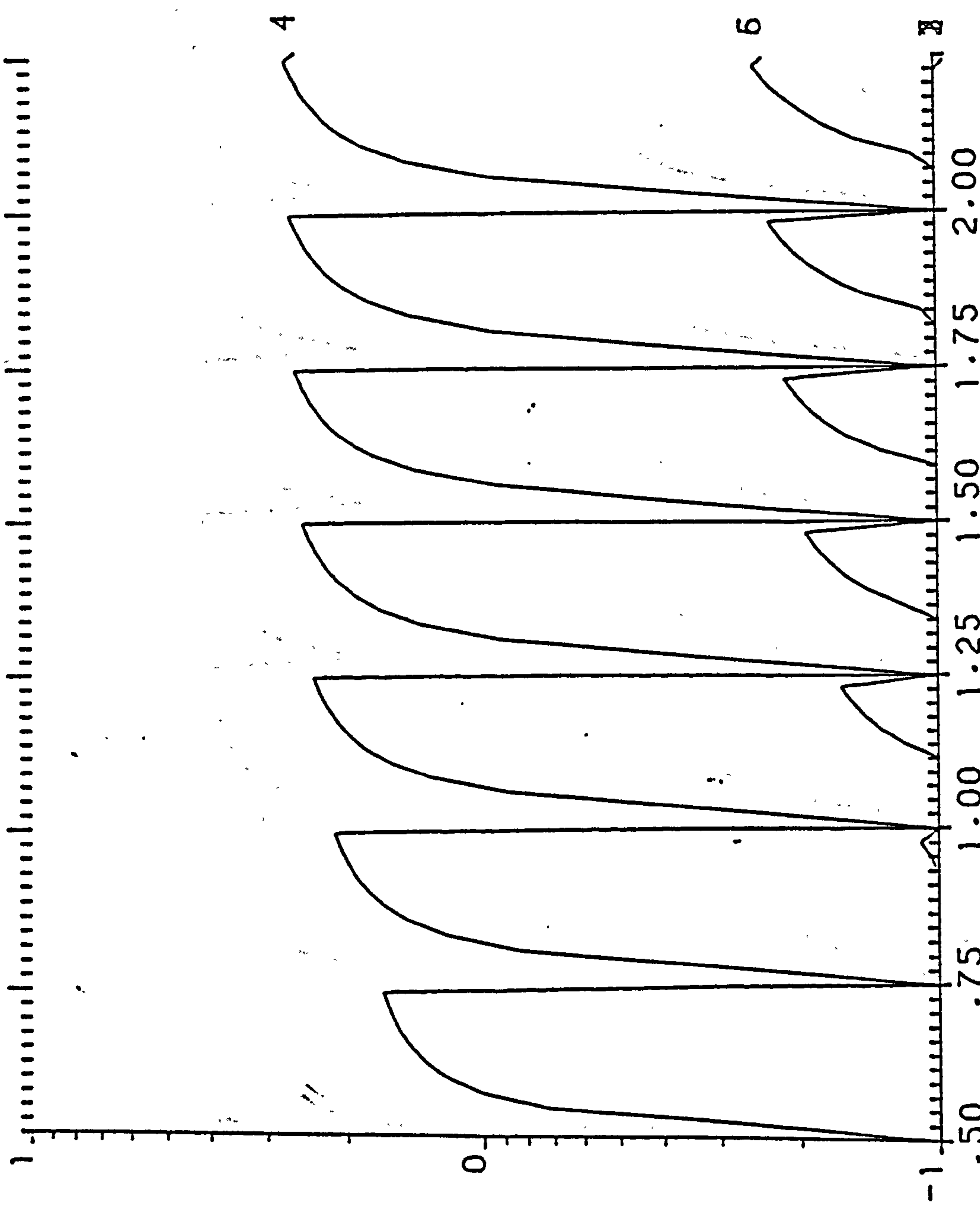

S. EFFICIENCY    W. THICKNESS=    .24M    W. ORIENTATION=    .00

WD= 1M    HD1= 22M    HD2= 6M    HOUSE T.=1.5 ST.

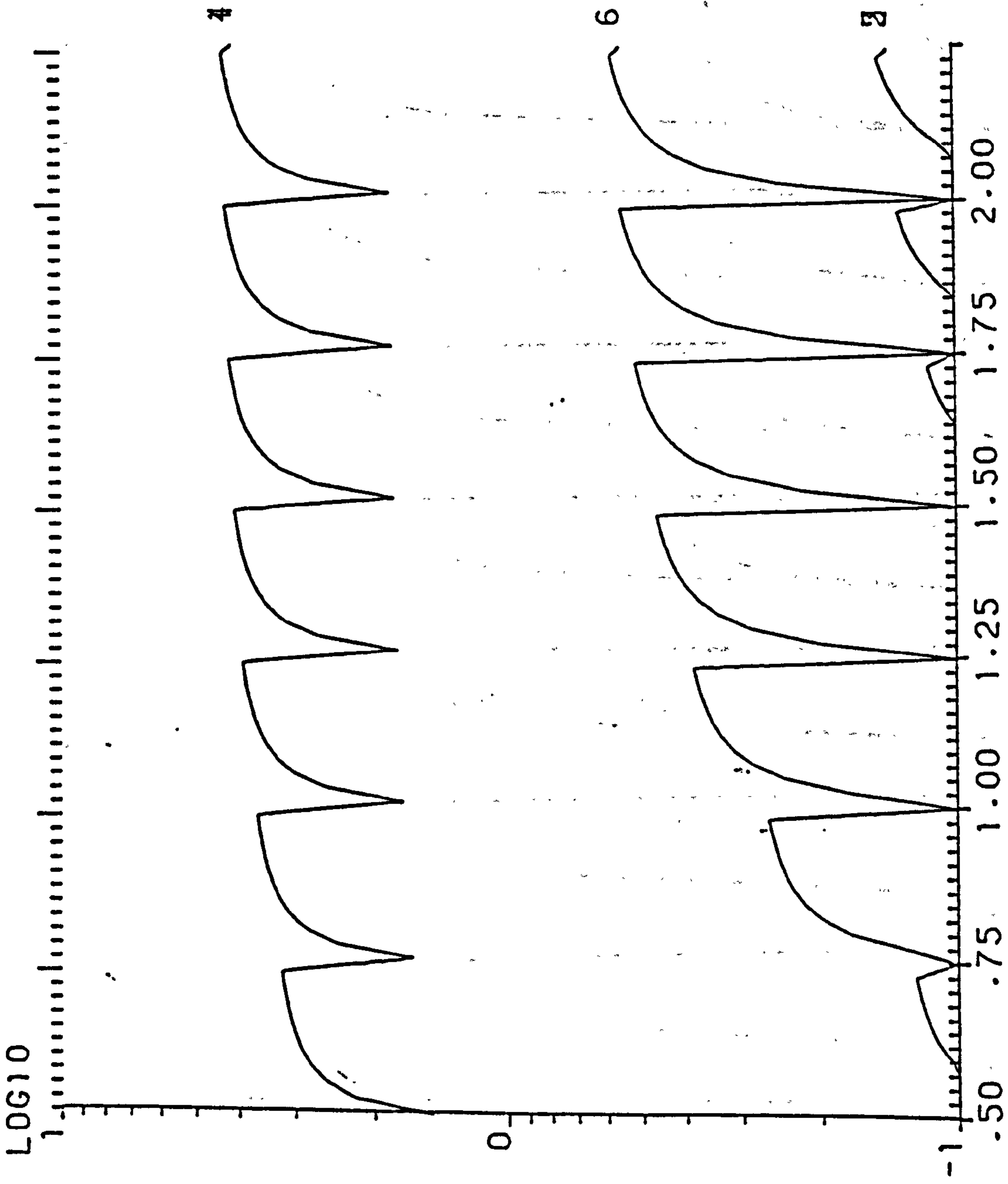

S. EFFICIENCY W. THICKNESS= .24M W. ORIENTATION= 22.50

WD= 1M HD1= 22M HD2= 6M HOUSE T.=1.5 ST.

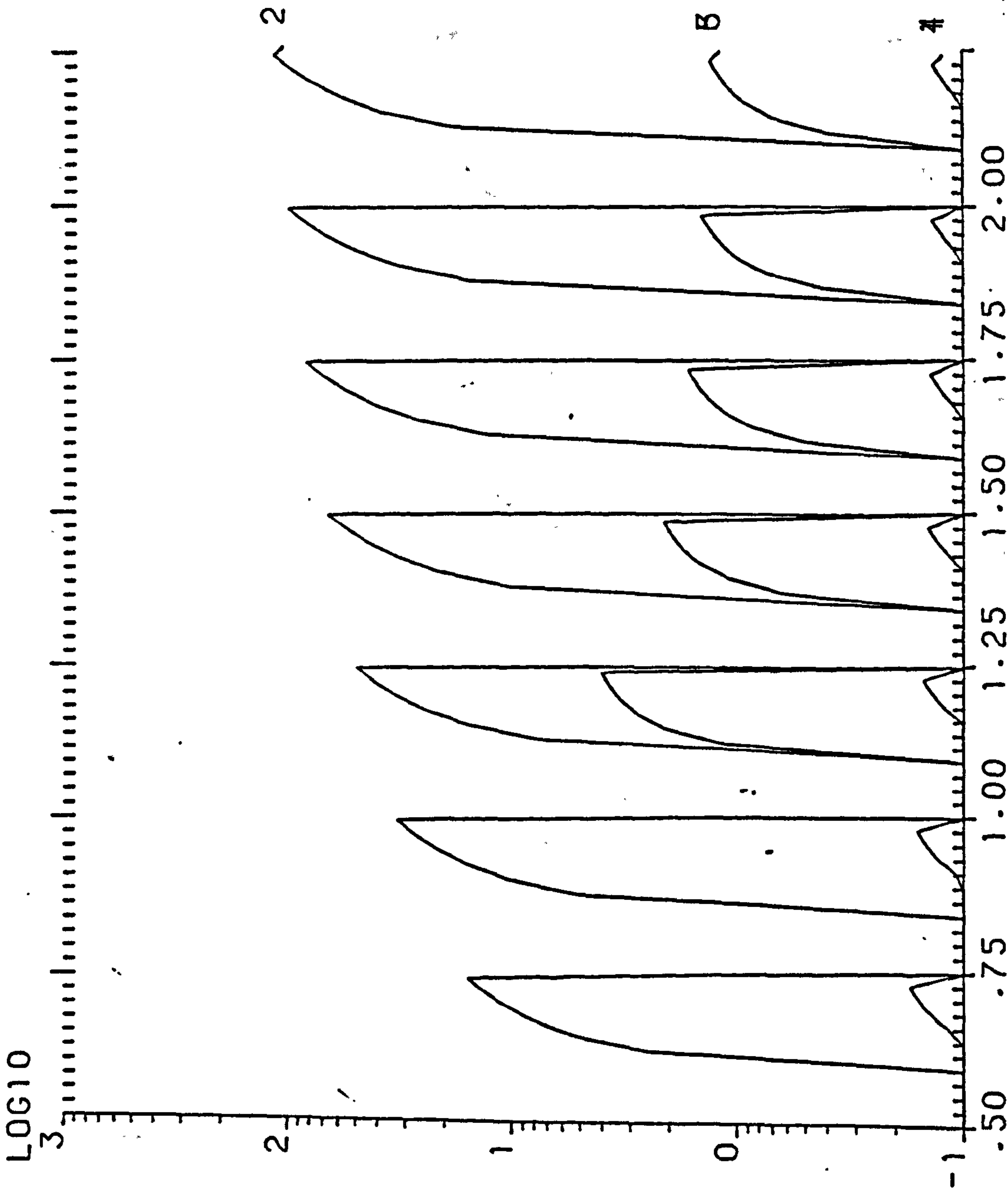

Y. EFFICIENCY W. THICKNESS= .24M W. ORIENTATION= 45.00

WD= 1M HD1= 22M HD2= 6M HOUSE T.=1.5 ST.



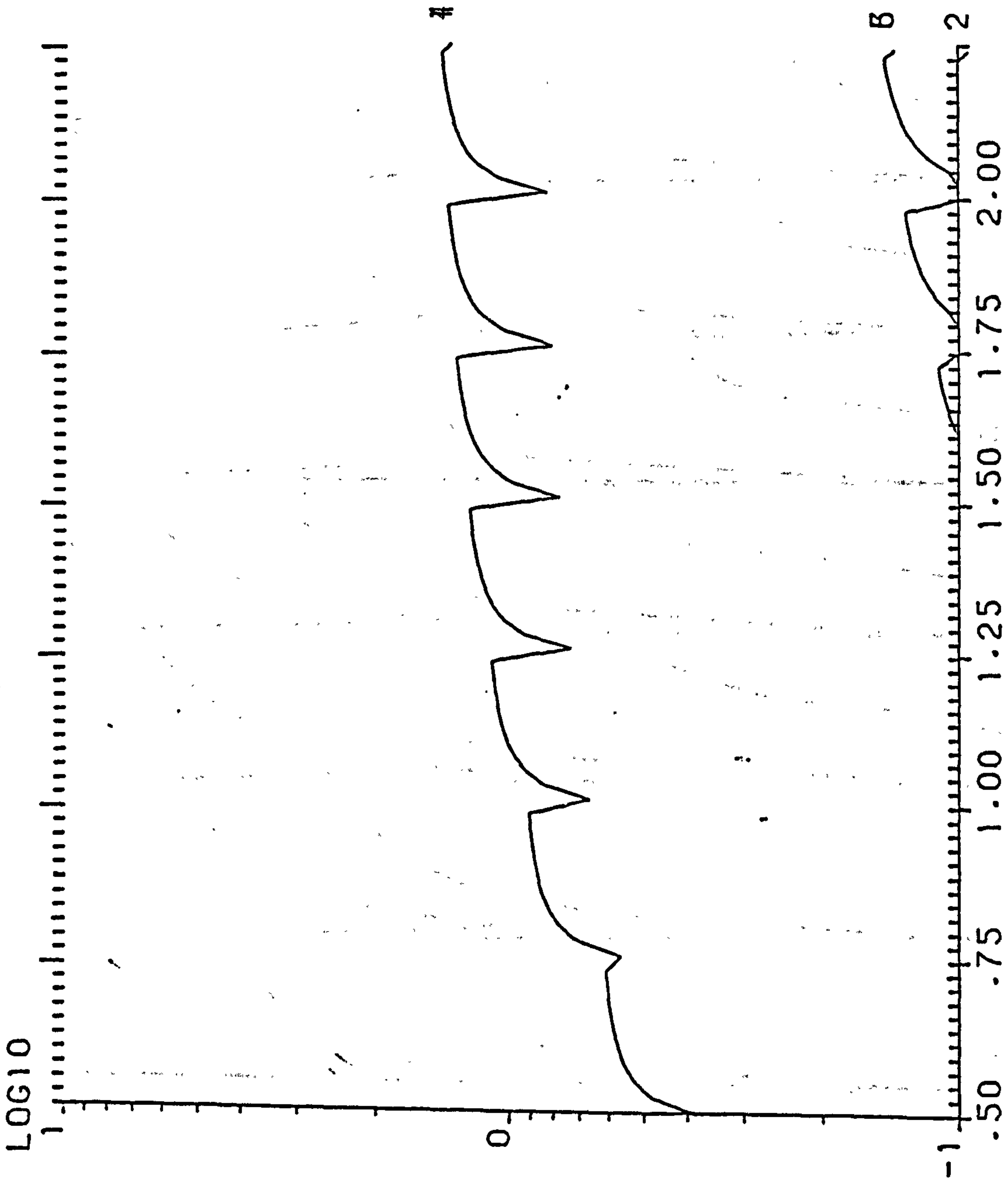

S. EFFICIENCY W. THICKNESS= .24M W. ORIENTATION= 45.00

WD= 1M HD1= 22M HD2= 6M HOUSE T.=1.5 ST.

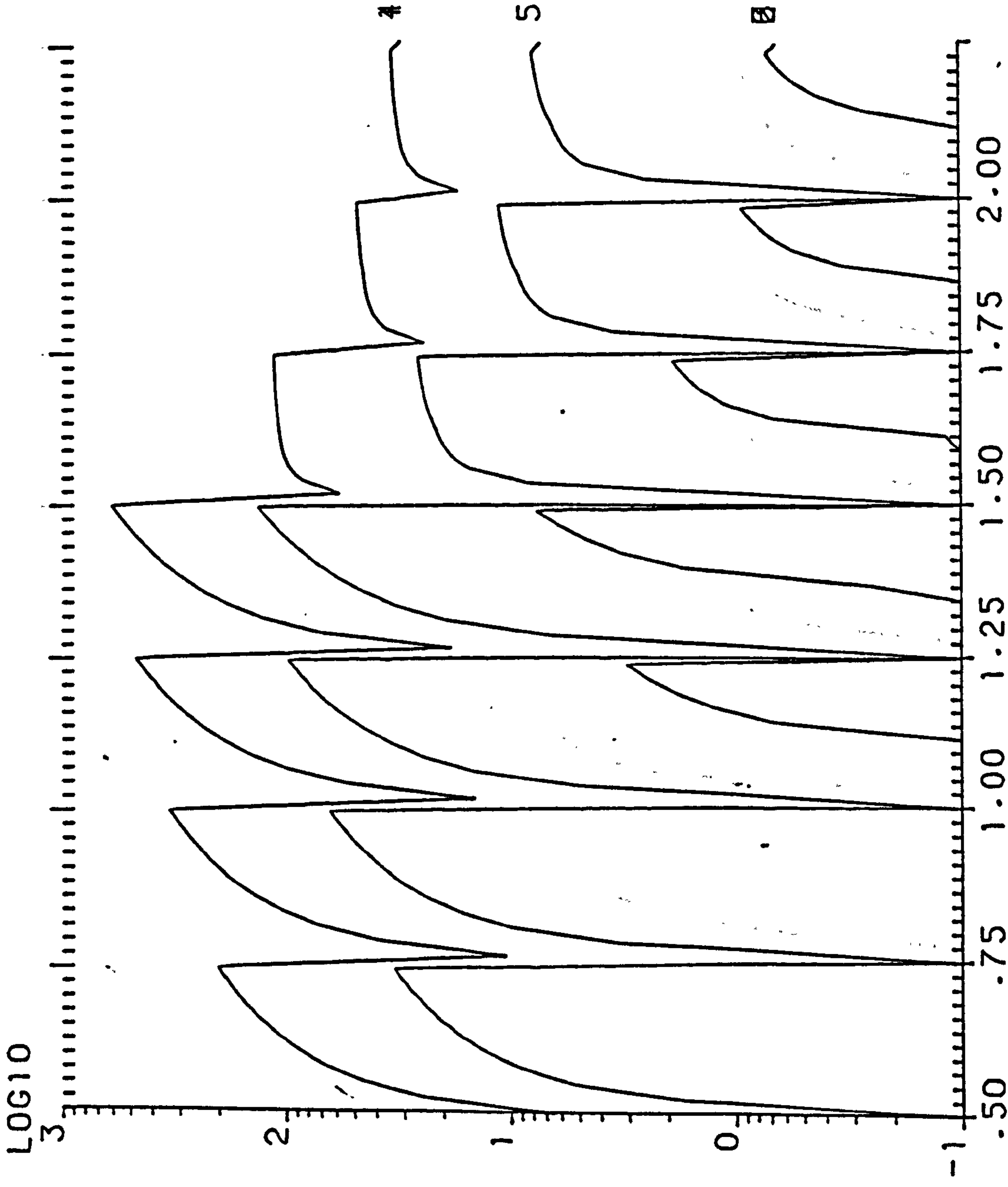

Y. EFFICIENCY W. THICKNESS= .24M W. ORIENTATION= 67.50

WD= 1M HD1= 22M HD2= 6M HOUSE T.=1.5 ST.

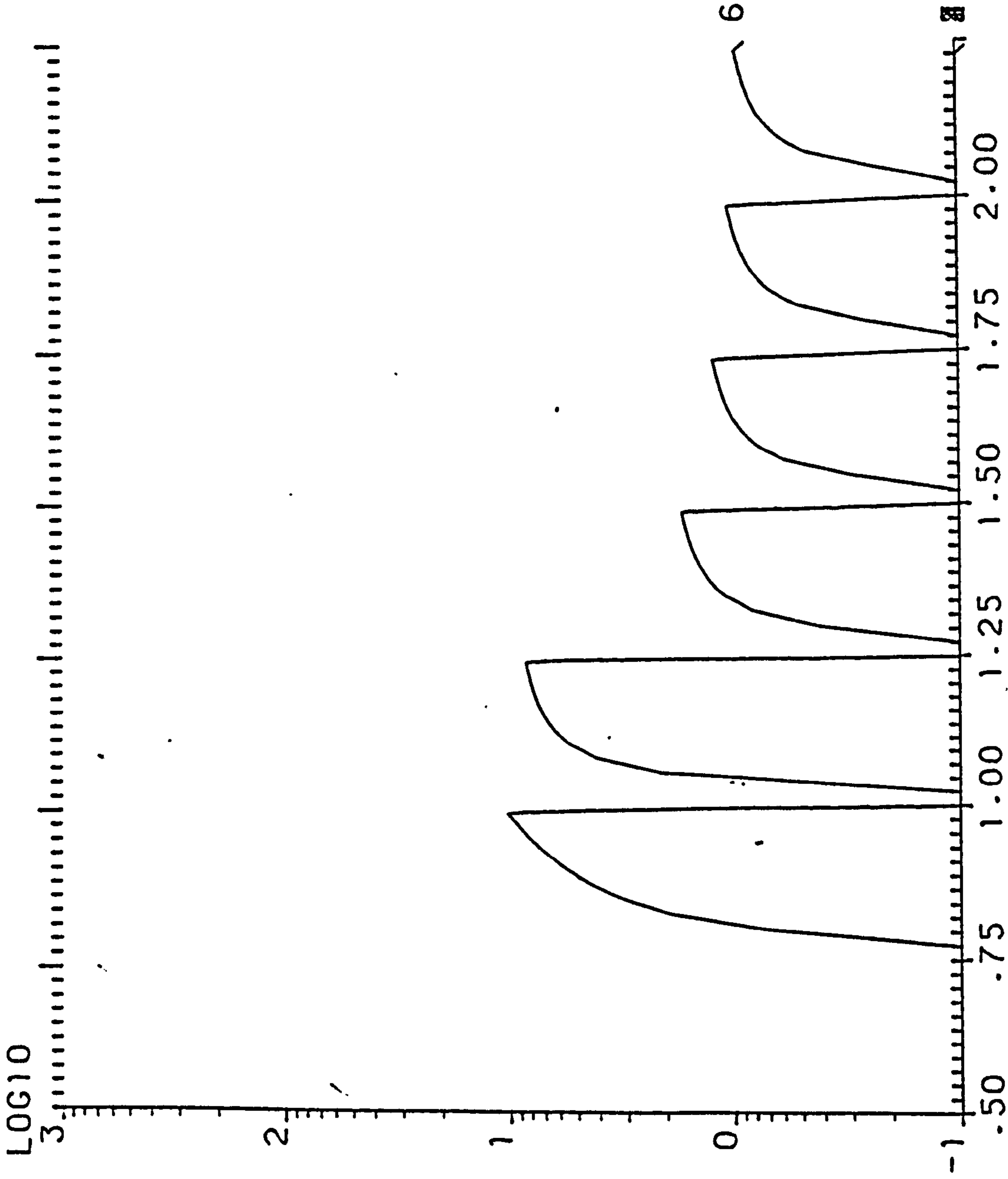

Y. EFFICIENCY W. THICKNESS= .24M W. ORIENTATION= 90.00

WD= 1M HD1= 22M HD2= 6M HOUSE T.=1.5 ST.



LOG10  
1  
0  
-1

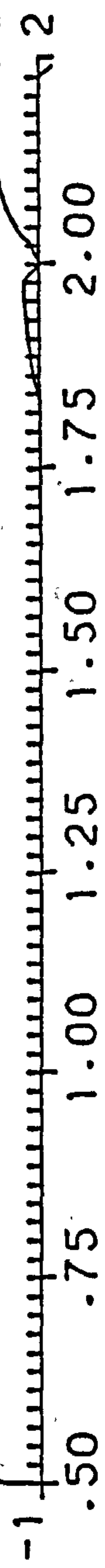

S. EFFICIENCY W. THICKNESS= .24M W. ORIENTATION= 90.00

WD= 1M HD1= 22M HD2= 6M HOUSE T.=1.5 ST.

LOG10  
3

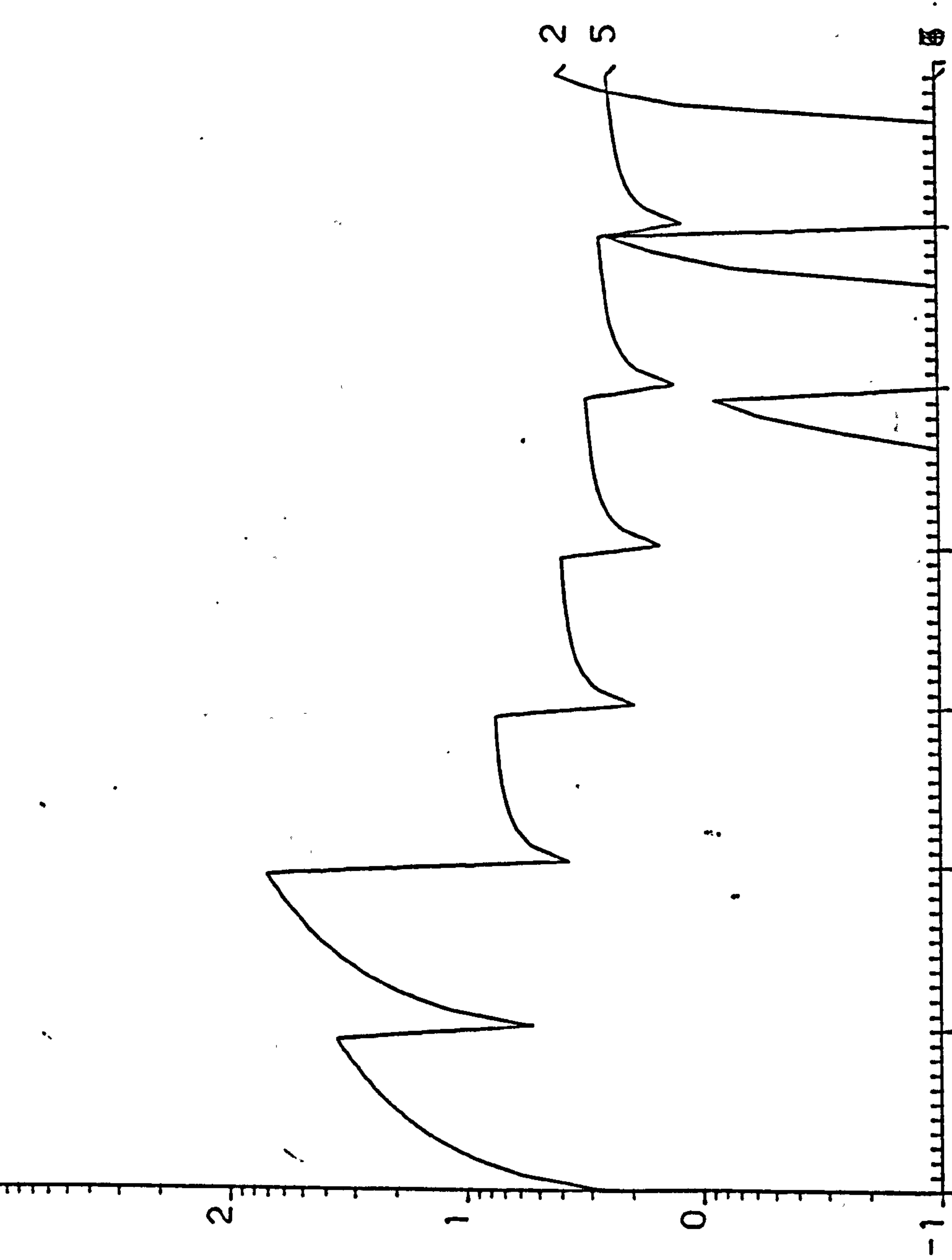

Y. EFFICIENCY W. THICKNESS= .24M W. ORIENTATION=112.50

WD= 1M HD1= 22M HD2= 6M HOUSE T.=1.5 ST.

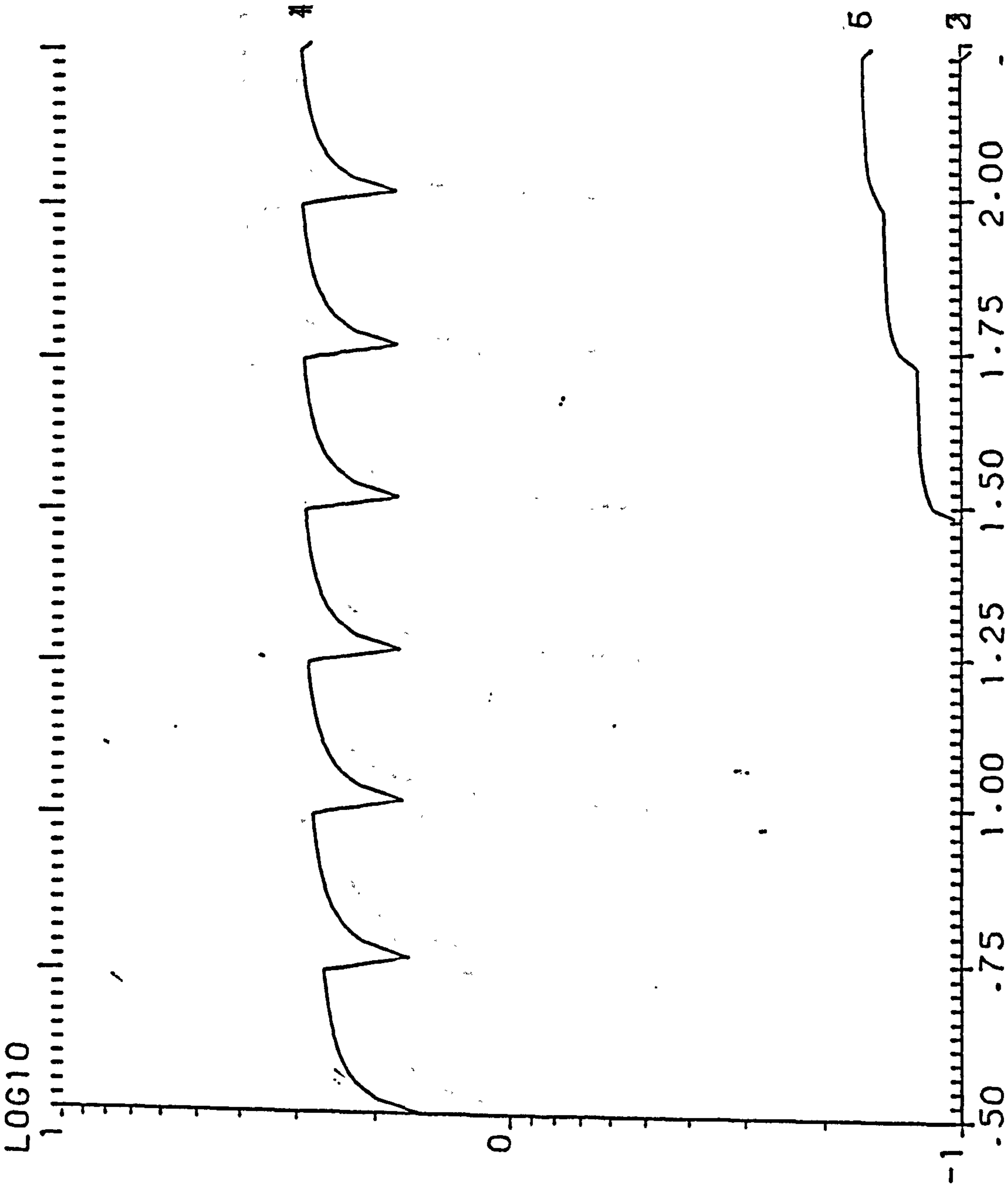

S: EFFICIENCY W. THICKNESS= .24M W. ORIENTATION=112.50

WD= 1M HD1= 22M HD2= 6M HOUSE T.=1.5 ST.

LOG10

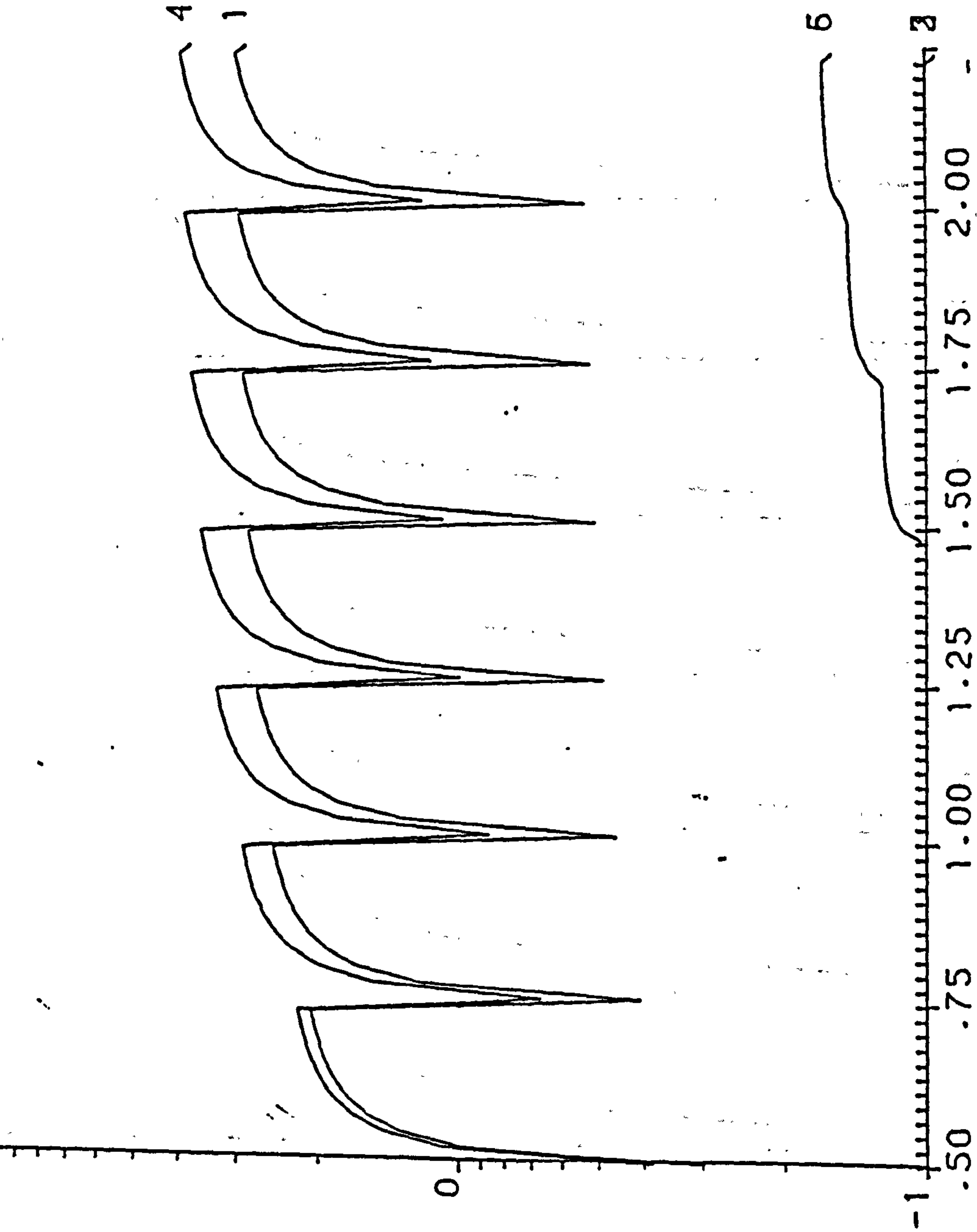

S. EFFICIENCY W. THICKNESS= .24M W. ORIENTATION=135.00

WD= 1M HD1= 22M HD2= 6M HOUSE T.=1.5 ST.



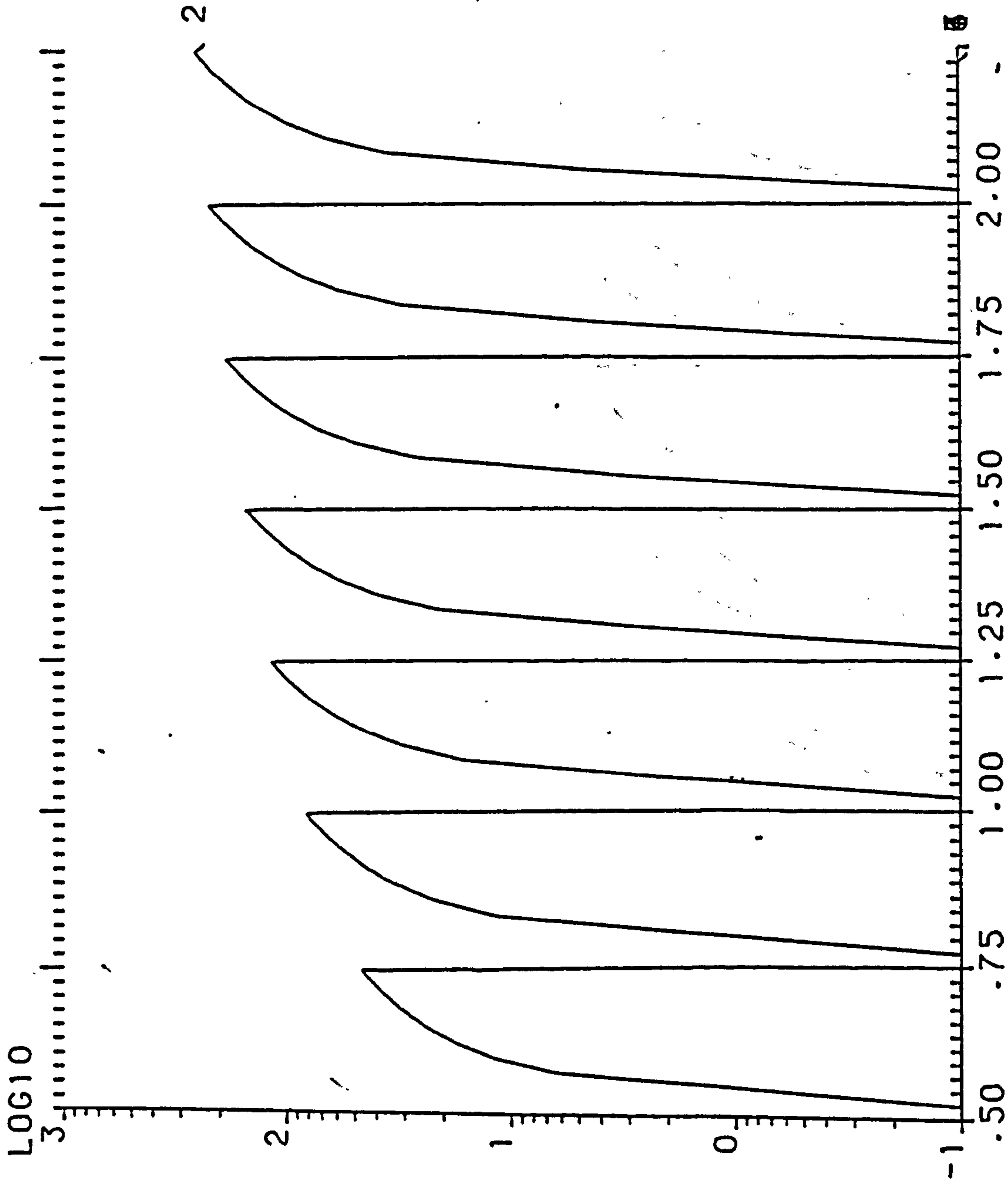

Y. EFFICIENCY W. THICKNESS= .24M W. ORIENTATION=157.50

WD= 1M HD1= 22M HD2= 6M HOUSE T.=1.5 ST.

LOG10

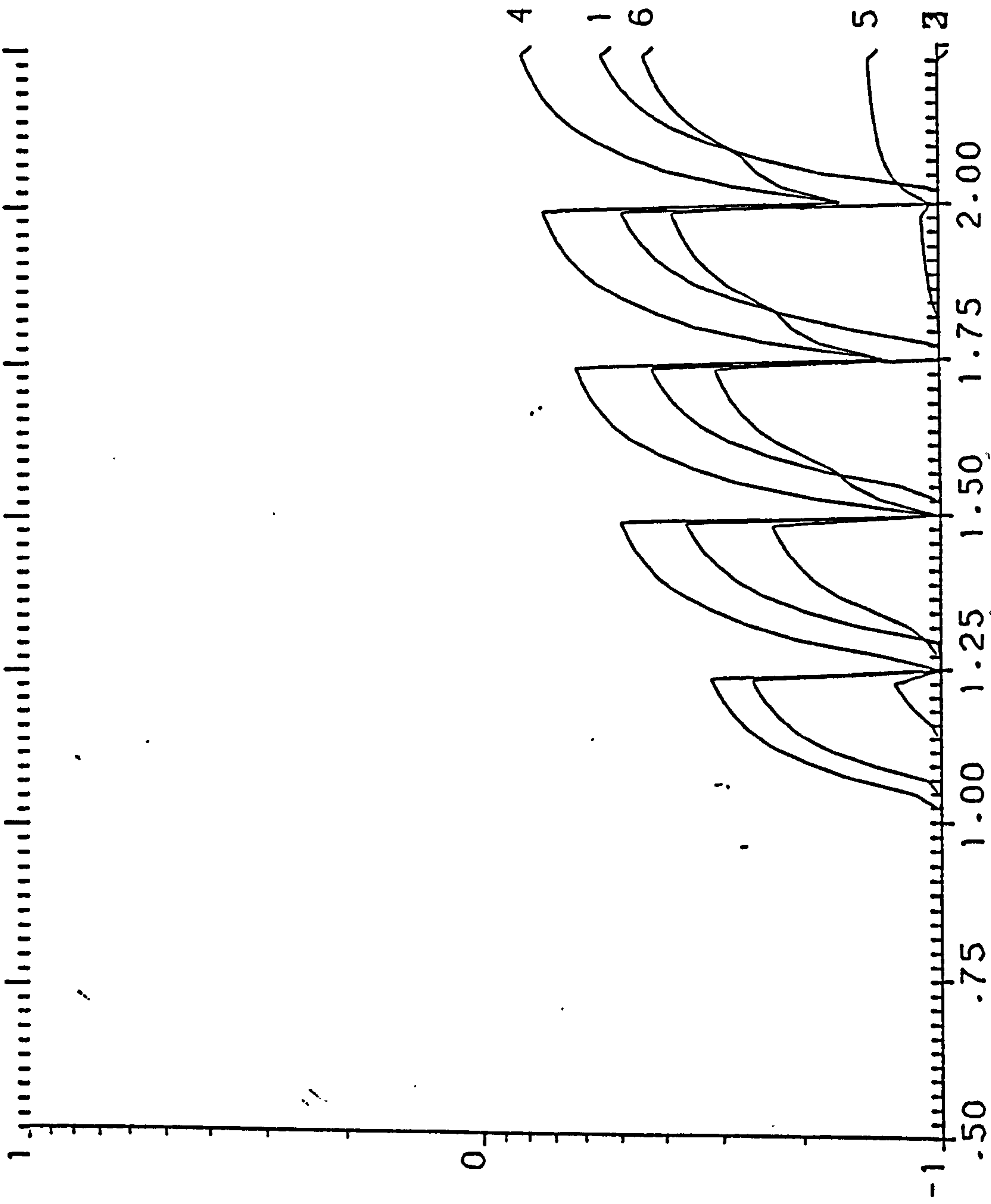

S. EFFICIENCY W. THICKNESS= .24M W. ORIENTATION=157.50

WD= 1M HD1= 22M HD2= 6M HOUSE T.=1.5 ST.



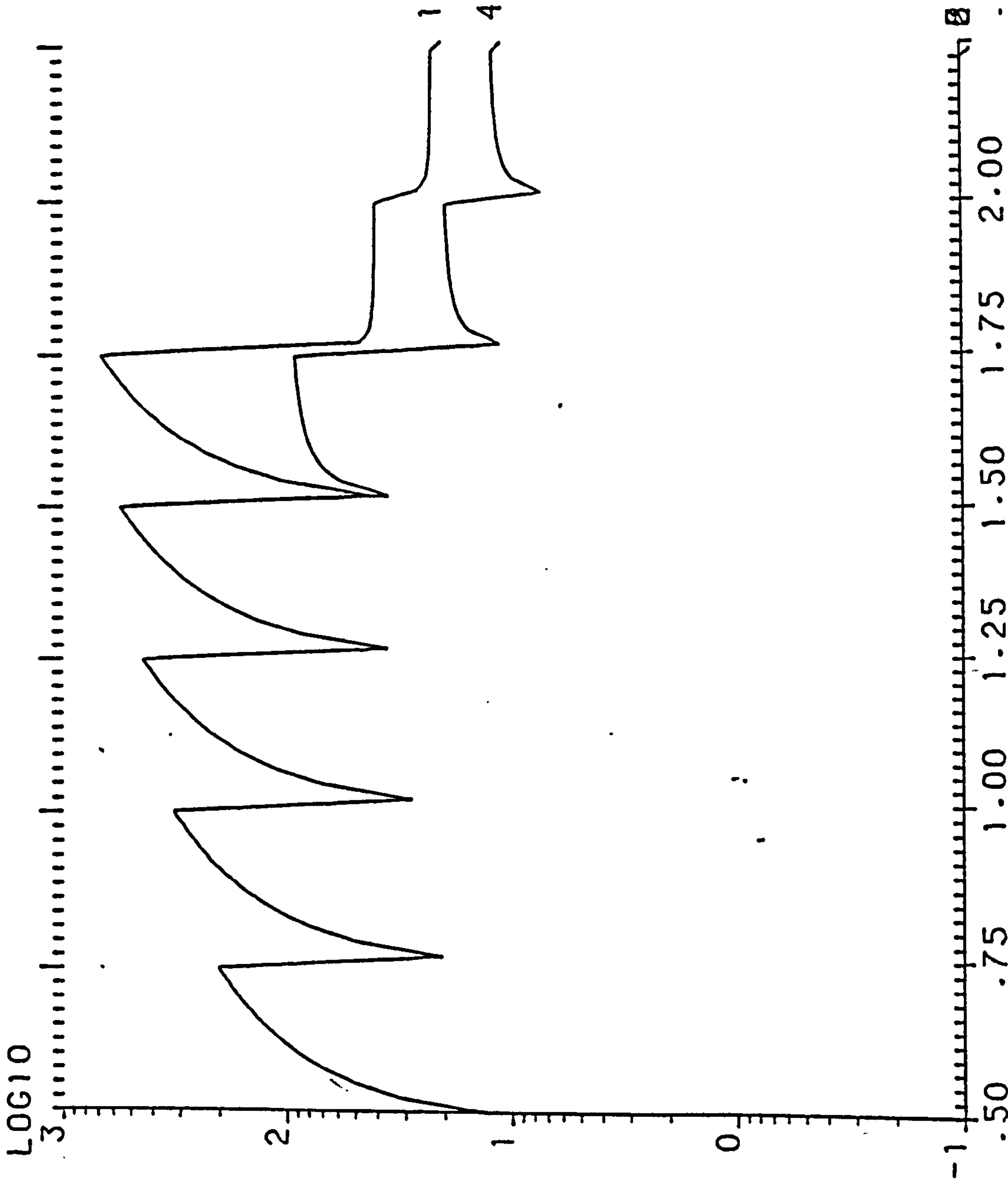

Y. EFFICIENCY W. THICKNESS= .24M W. ORIENTATION=180.00

WD= 1M HD1= 22M HD2= 6M HOUSE T.=1.5 ST.

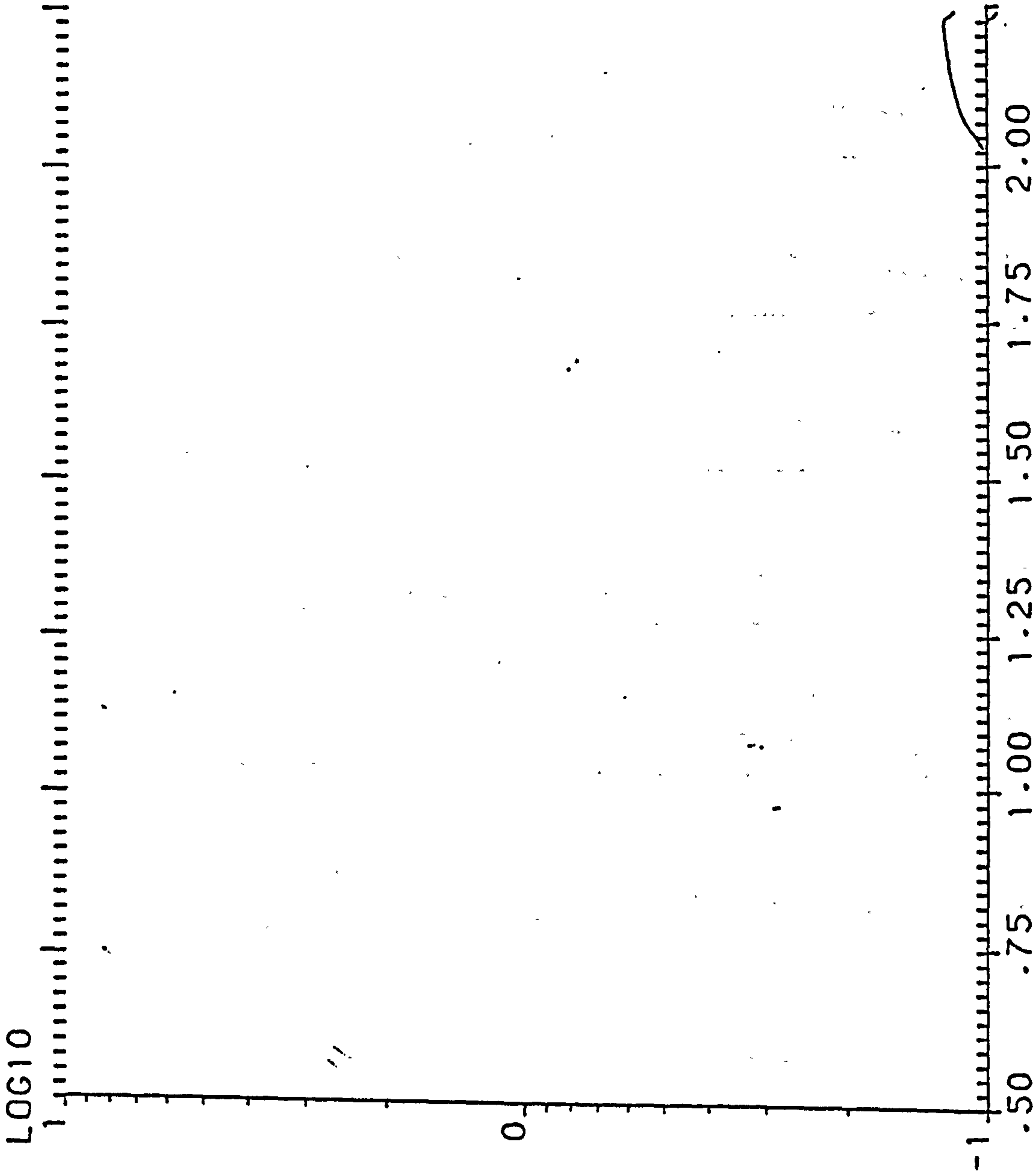

S. EFFICIENCY W. THICKNESS= .24M W. ORIENTATION=180.00

WD= 1M HD1= 22M HD2= 6M HOUSE T.=1.5 ST.



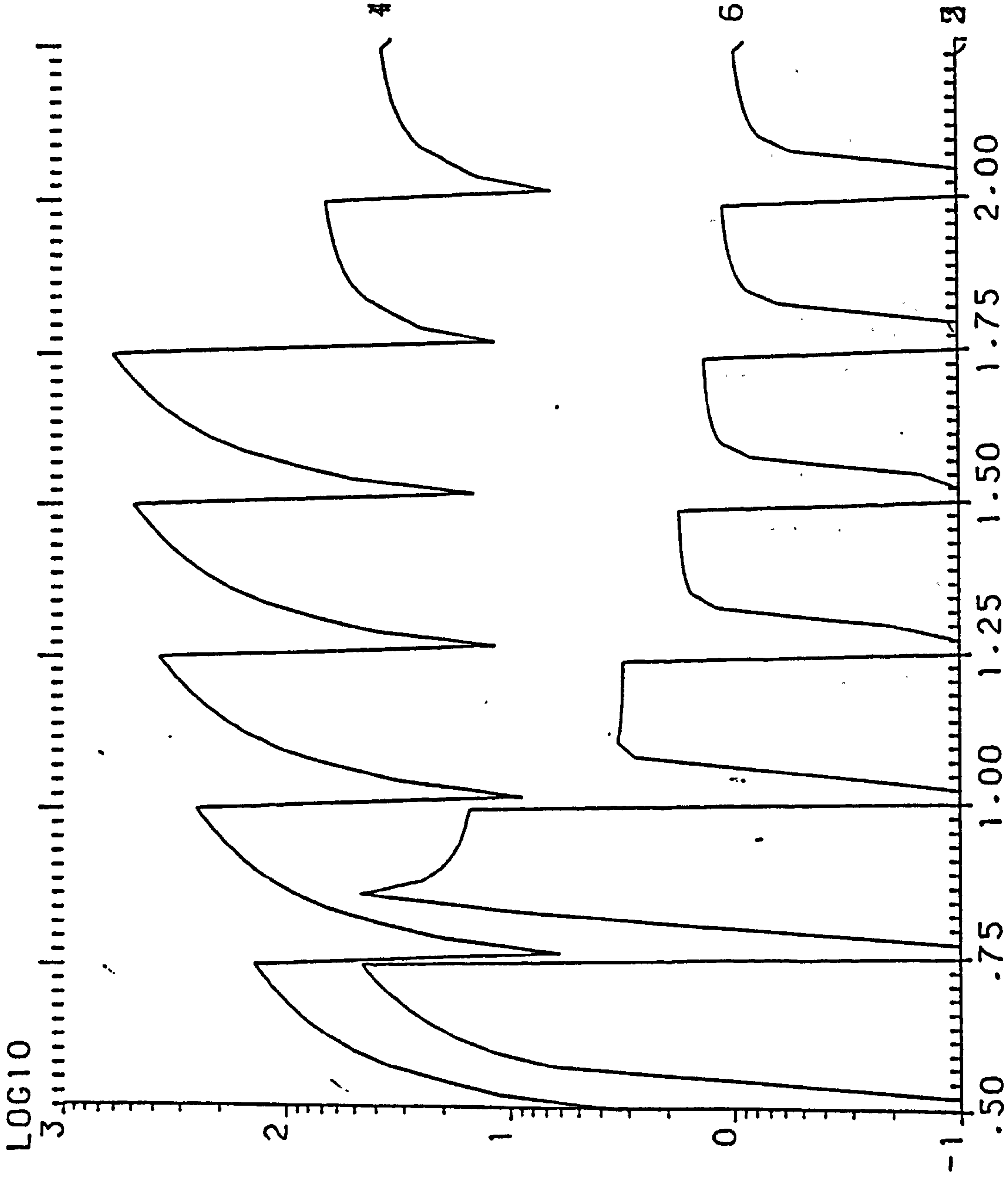

Y. EFFICIENCY W. THICKNESS= .24M W. ORIENTATION=202.50

WD= 1M HD1= 22M HD2= 6M HOUSE T.=1.5 ST.

LOG10  
1  
0  
-1

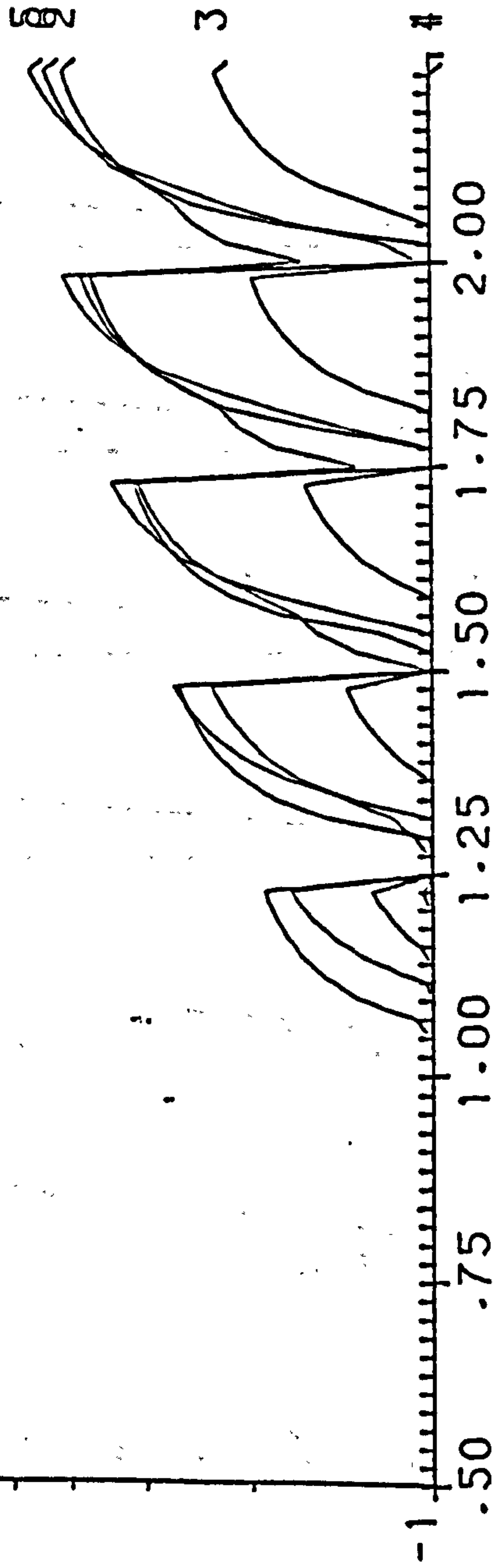

S. EFFICIENCY W. THICKNESS = .24M W. ORIENTATION = 202.50

WD = 1M HD1 = 22M HD2 = 6M HOUSE T. = 1.5 ST.

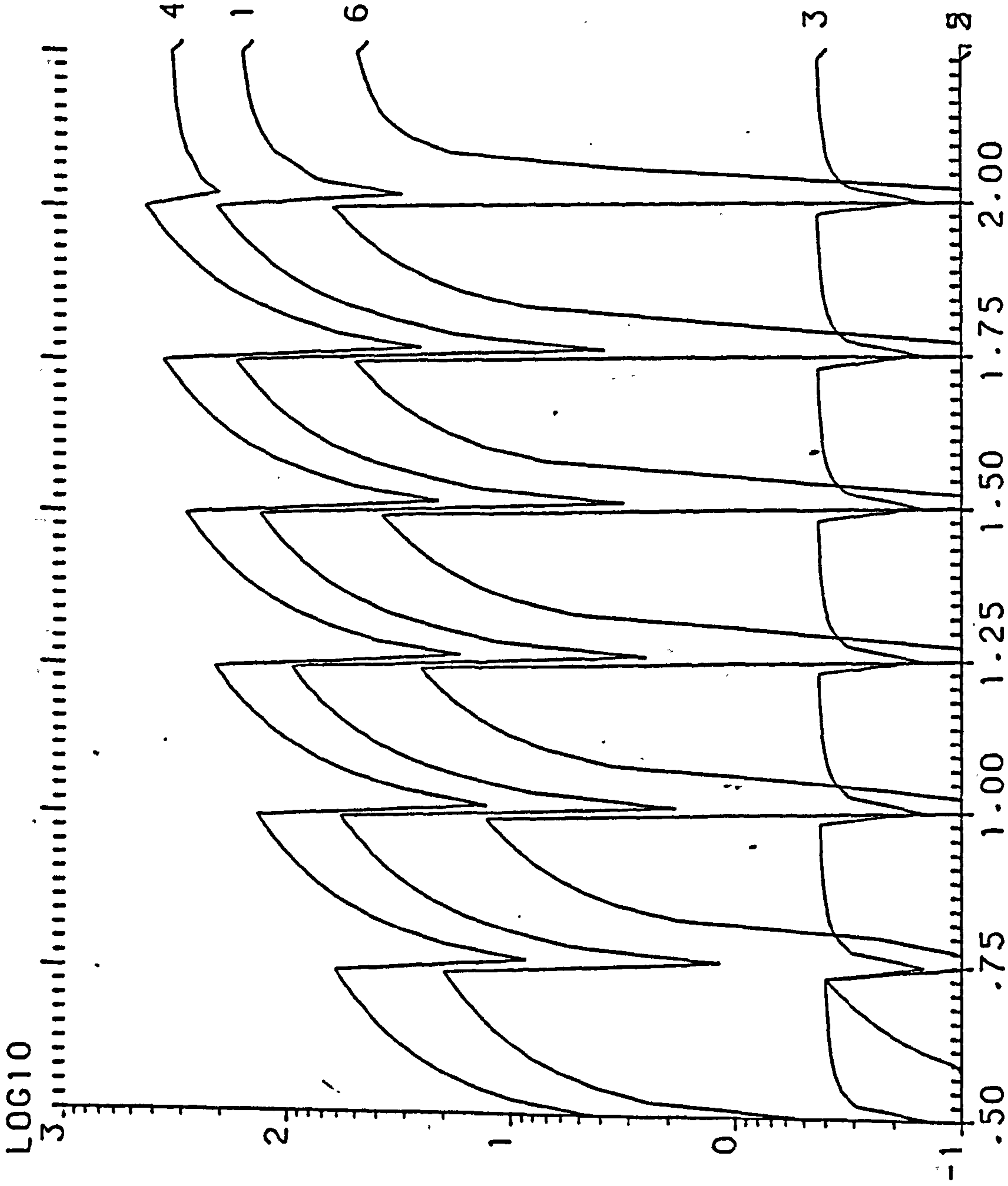

Y. EFFICIENCY W. THICKNESS= .24M W. ORIENTATION=225.00

WD= 1M HD1= 22M HD2= 6M HOUSE T.=1.5 ST.

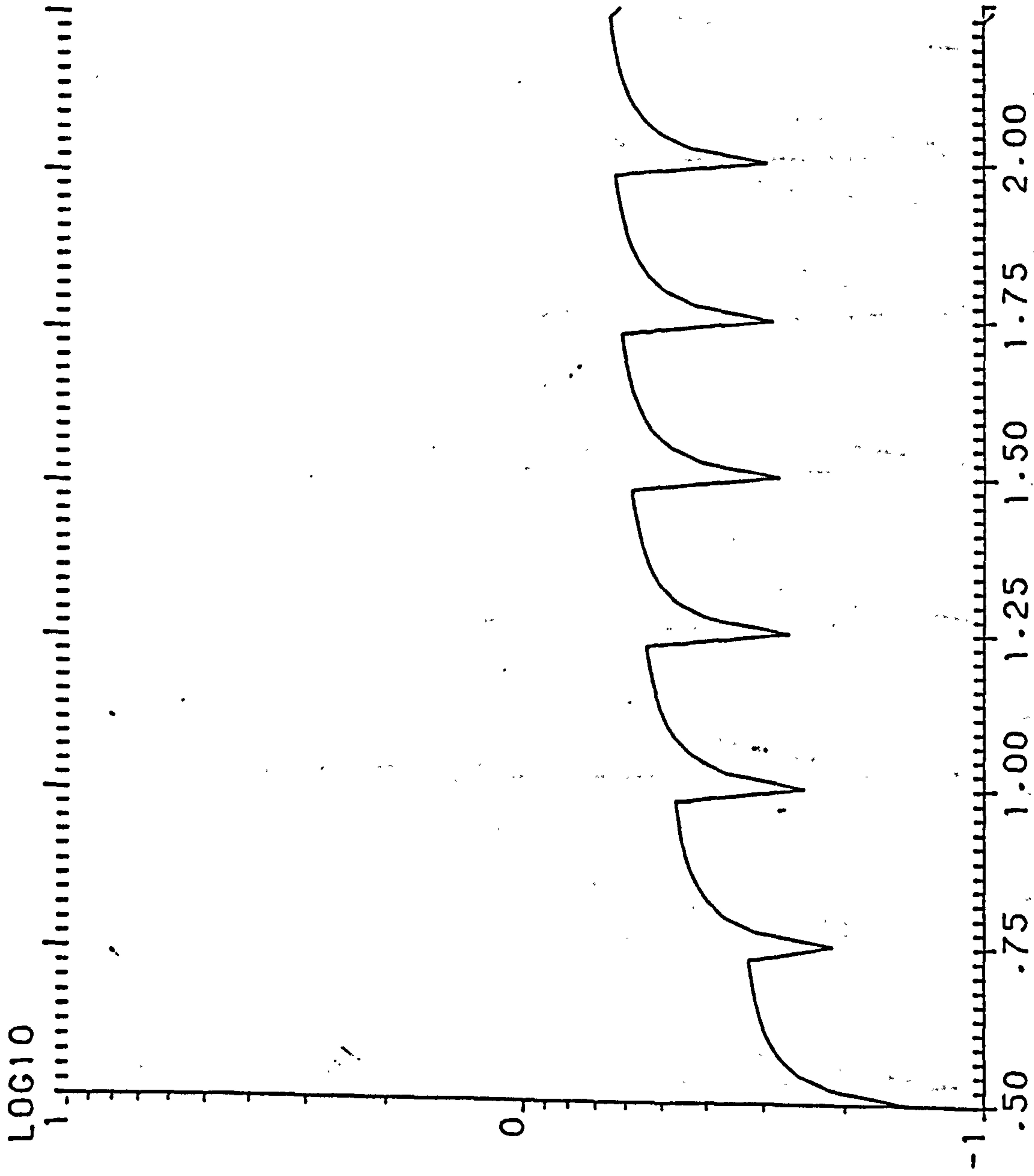

S. EFFICIENCY W. THICKNESS= .24M, W. ORIENTATION=225.00

WD= 1M, HD1= 22M HD2= 6M HOUSE T.=1.5 ST.





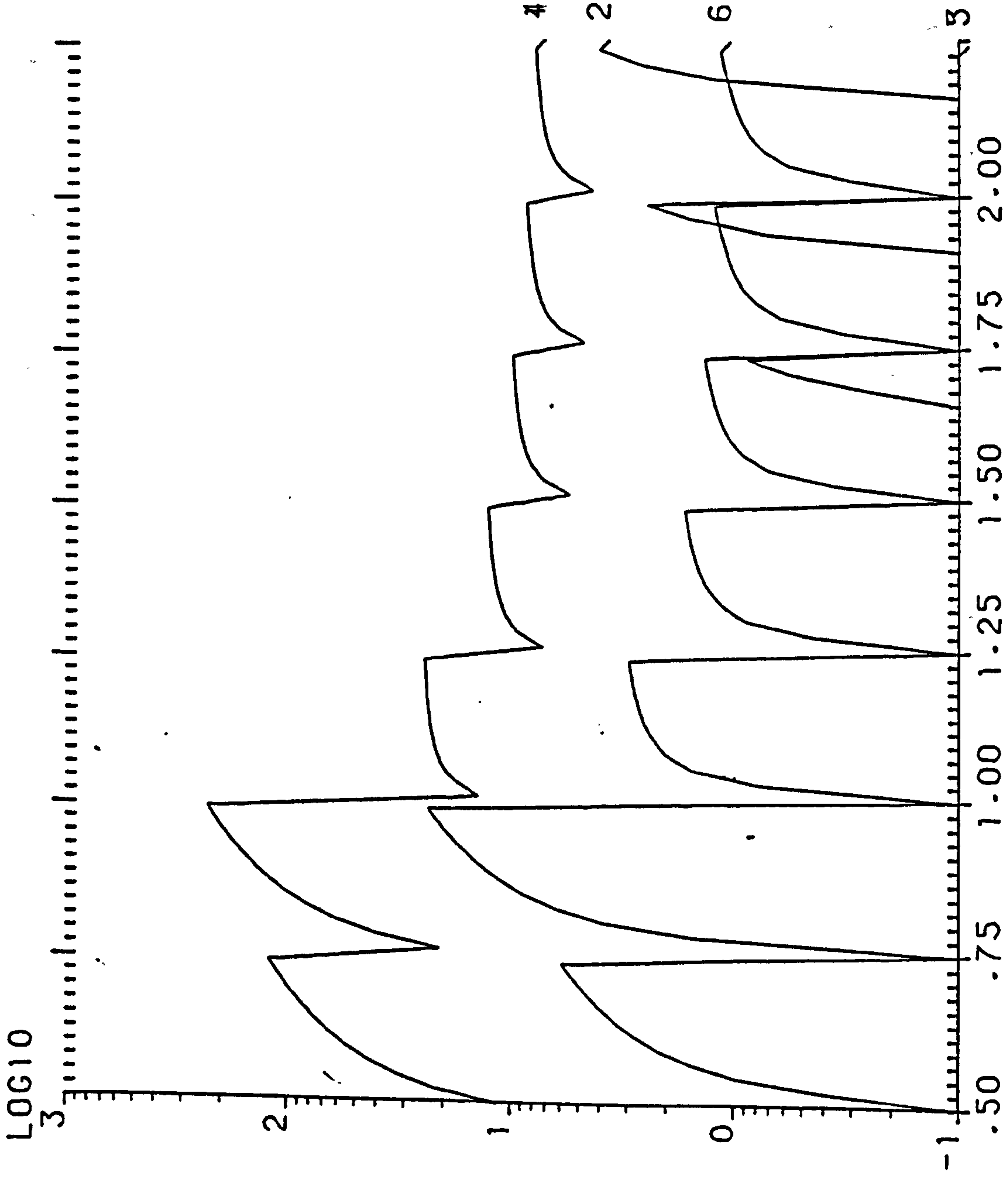

Y. EFFICIENCY W. THICKNESS= .24M W. ORIENTATION=247.50

WD= 1M HD1= 22M HD2= 6M HOUSE T.=1.5 ST.

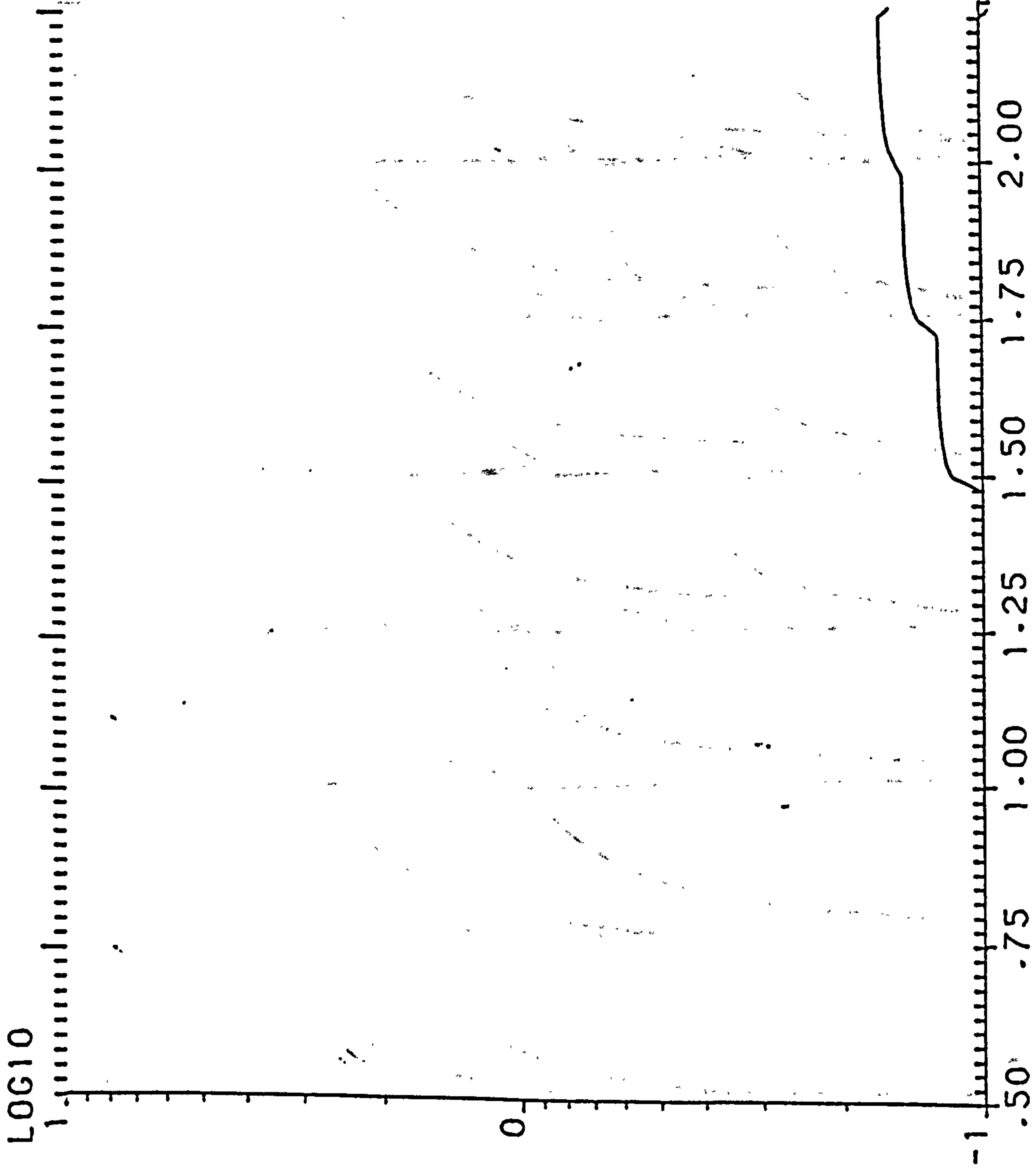

S. EFFICIENCY W. THICKNESS = .24M W. ORIENTATION = 247.50

WD = 1M HD1 = 22M HD2 = 6M HOUSE T. = 1.5 ST.



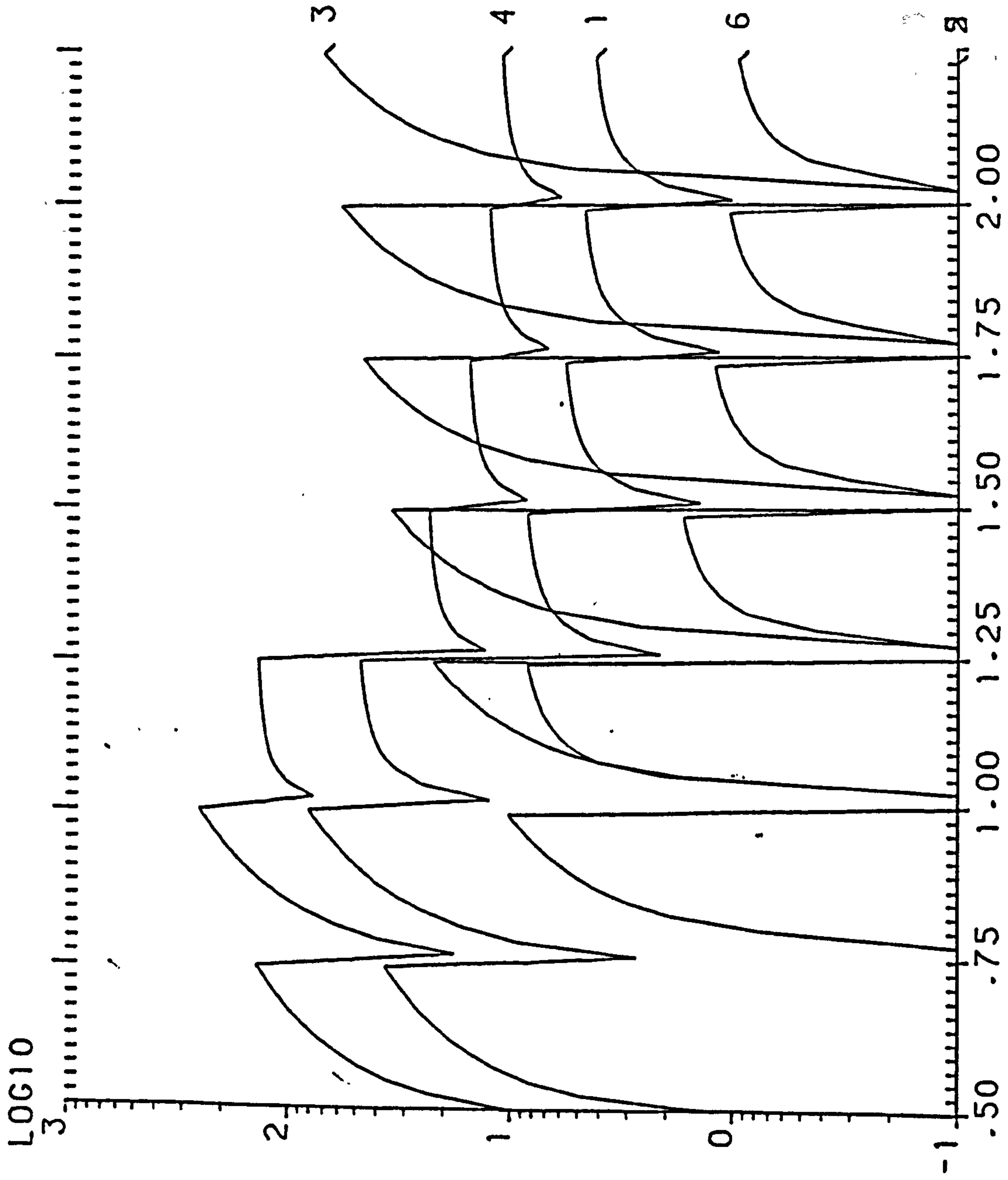

Y. EFFICIENCY W. THICKNESS= .24M W. ORIENTATION=270.00

WD= 1M HD1= 22M HD2= 6M HOUSE T.=1.5 ST.

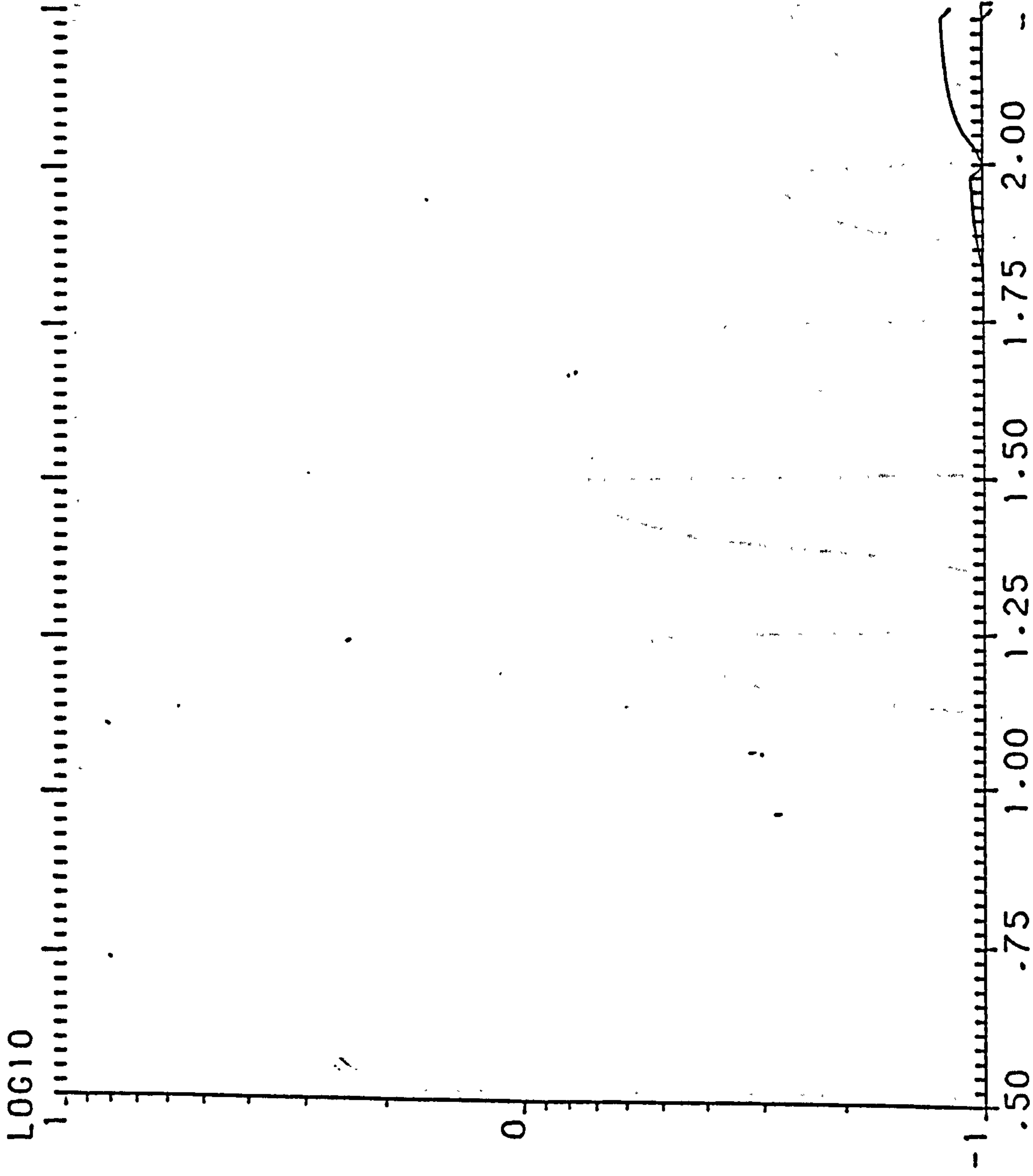

S. EFFICIENCY W. THICKNESS= .24M HD2= 6M HOUSE T.=1.5 ST.

WD= 1M HD1= 22M





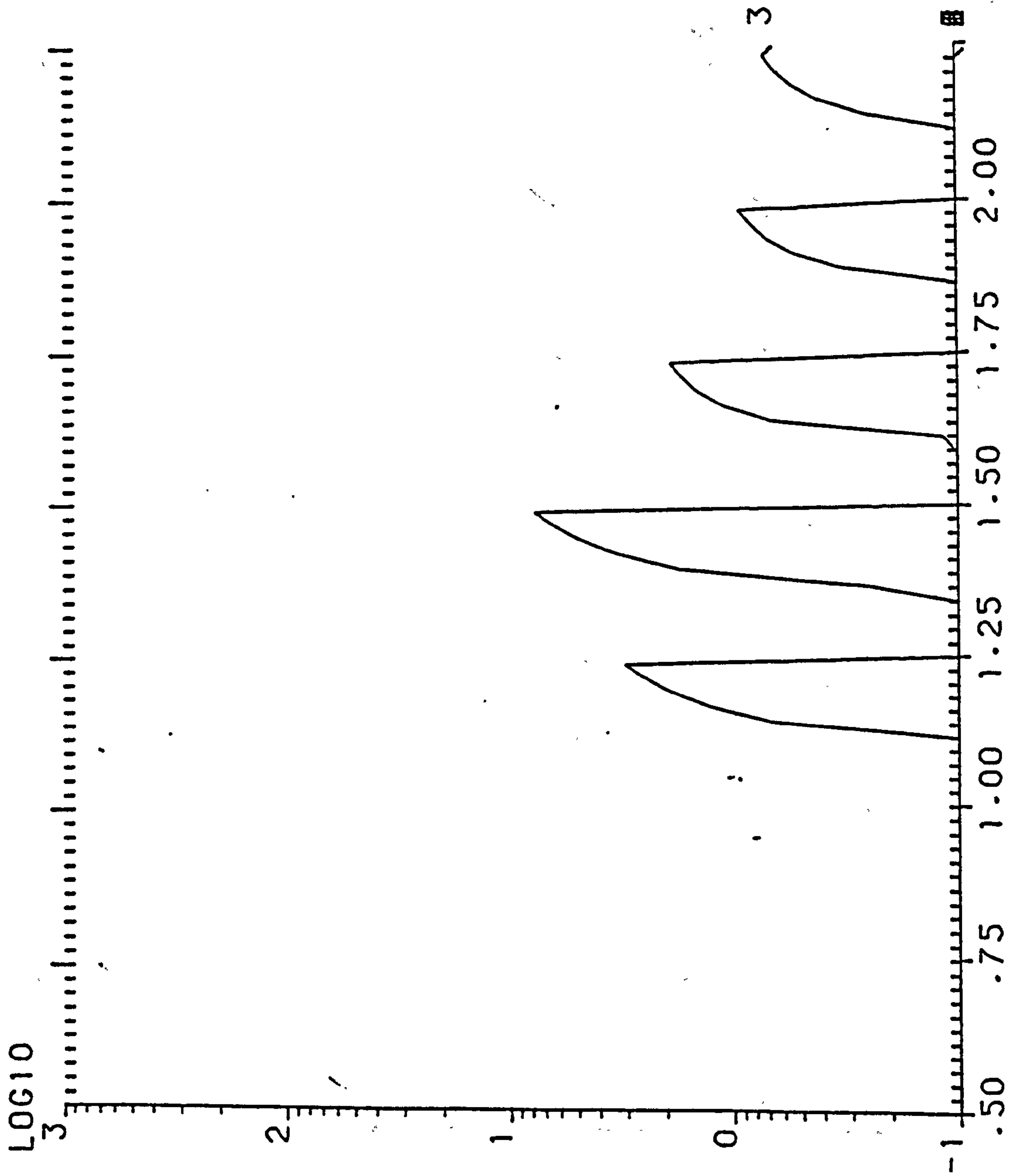

Y. EFFICIENCY W. THICKNESS= .24M W. ORIENTATION=292.50

WD= 1M HD1= 22M HD2= 6M HOUSE T.=1.5 ST.

LOG10  
1

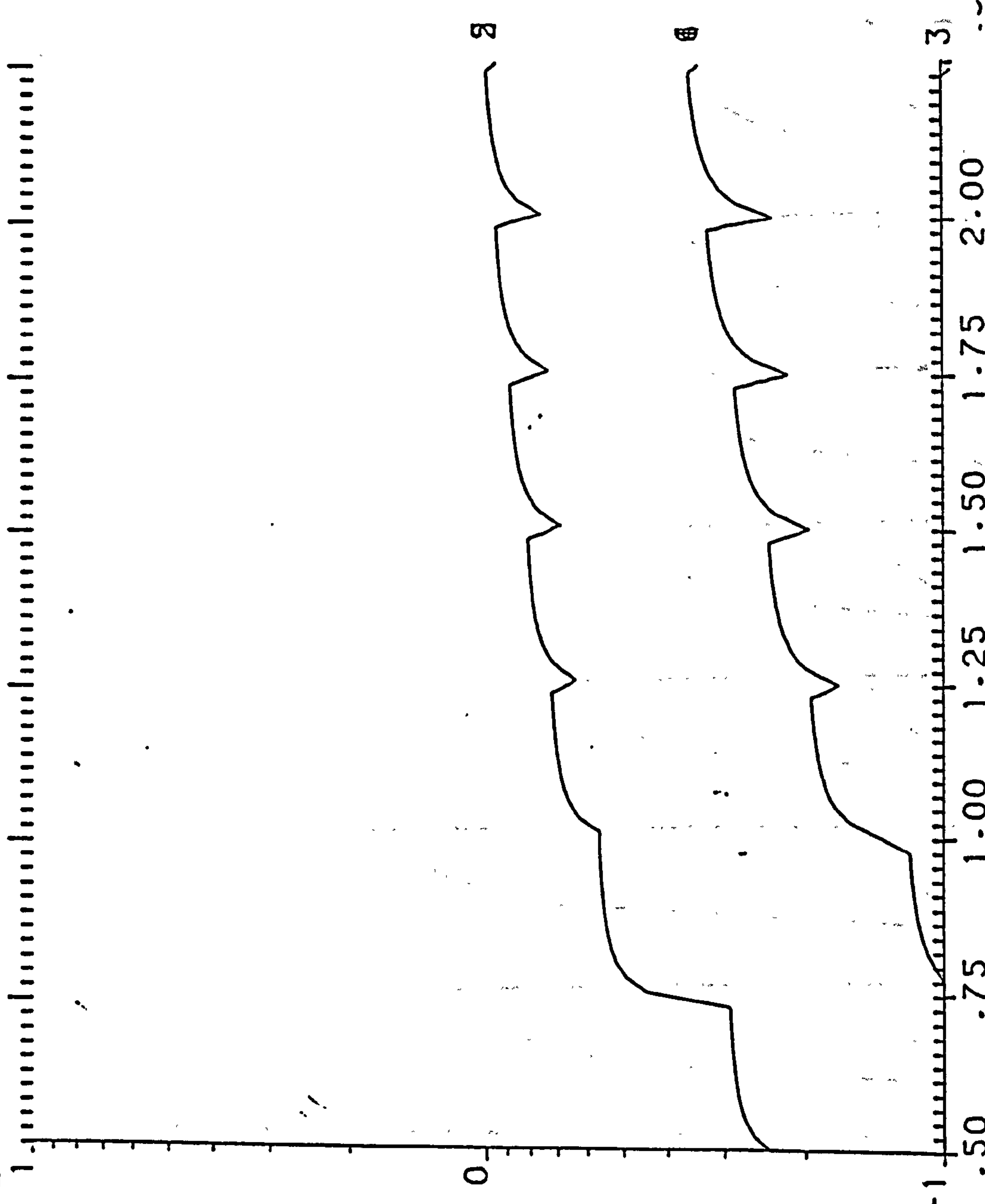

S. EFFICIENCY W. THICKNESS= .24M W. ORIENTATION=292.50

WD= 1M HD1= 22M HD2= 6M HOUSE T.=1.5 ST.



LOG10  
3  
2  
1  
0  
-1

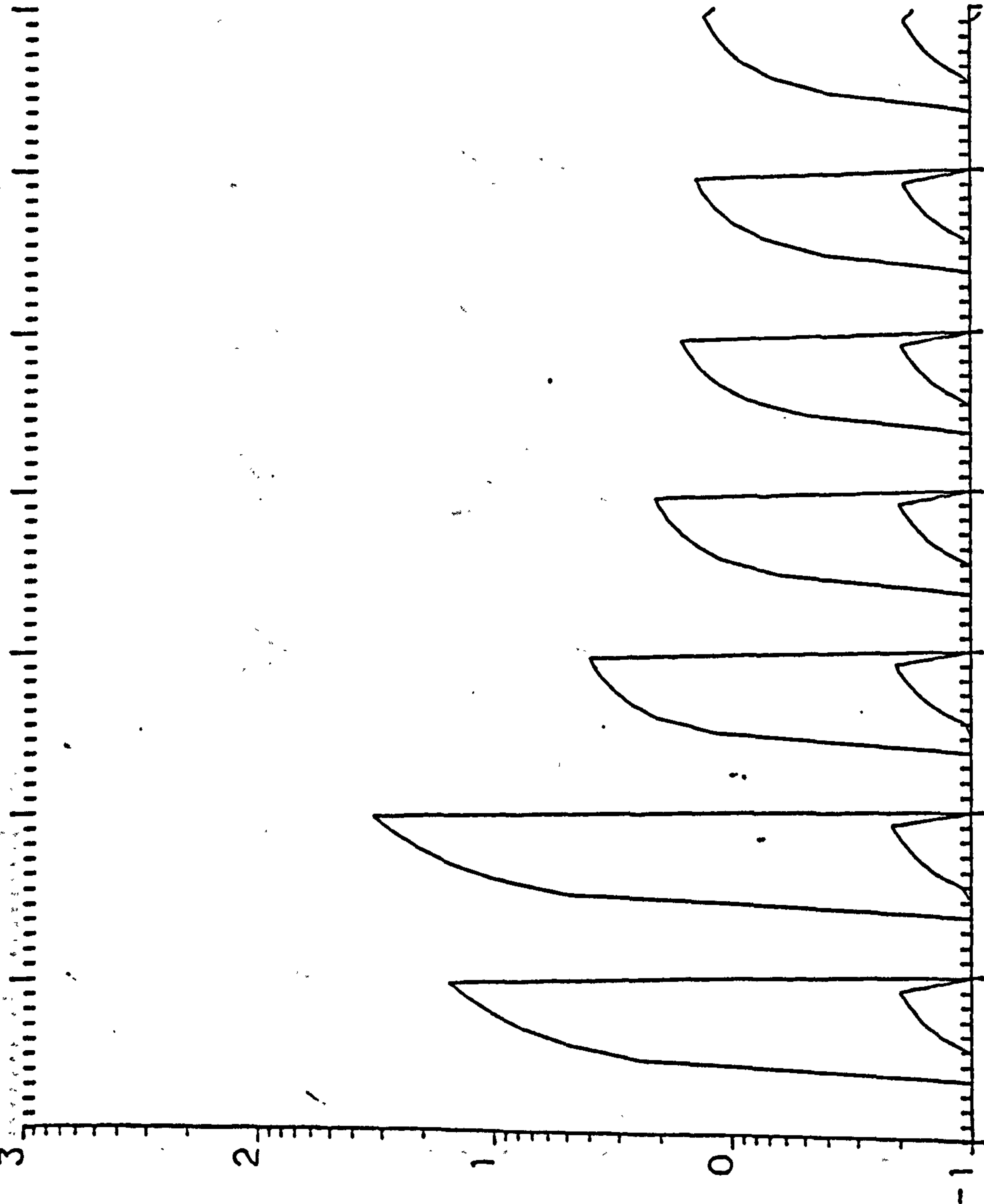

Y. EFFICIENCY W. THICKNESS= .24M W. ORIENTATION=315.00

WD= 1M HD1= 22M HD2= 6M HOUSE T.=1.5 ST.

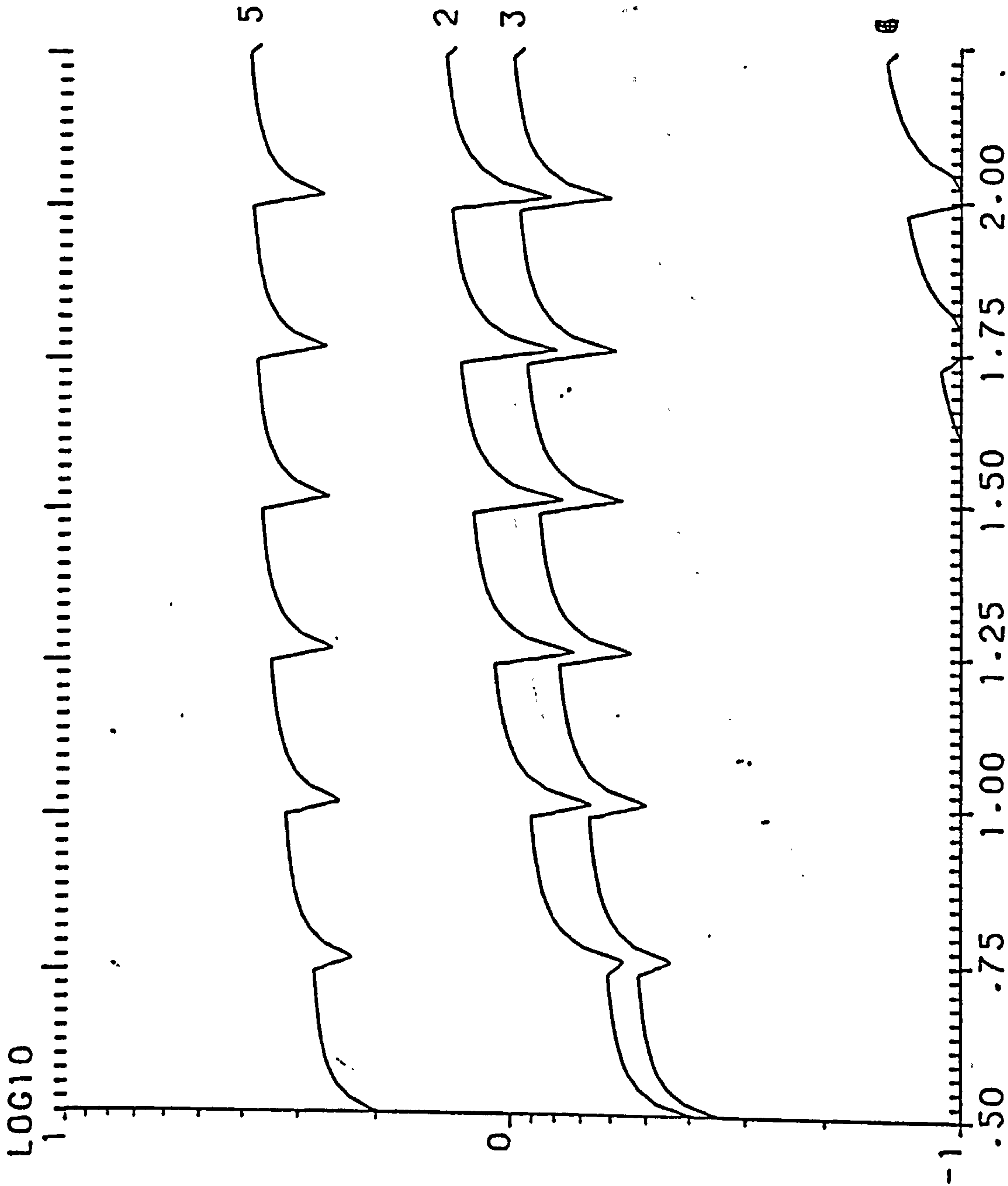

S. EFFICIENCY W. THICKNESS= .24M W. ORIENTATION=315.00

WD= 1M HD1= 22M HD2= 6M HOUSE T.=1.5 ST.





LOG10  
1  
0  
-1

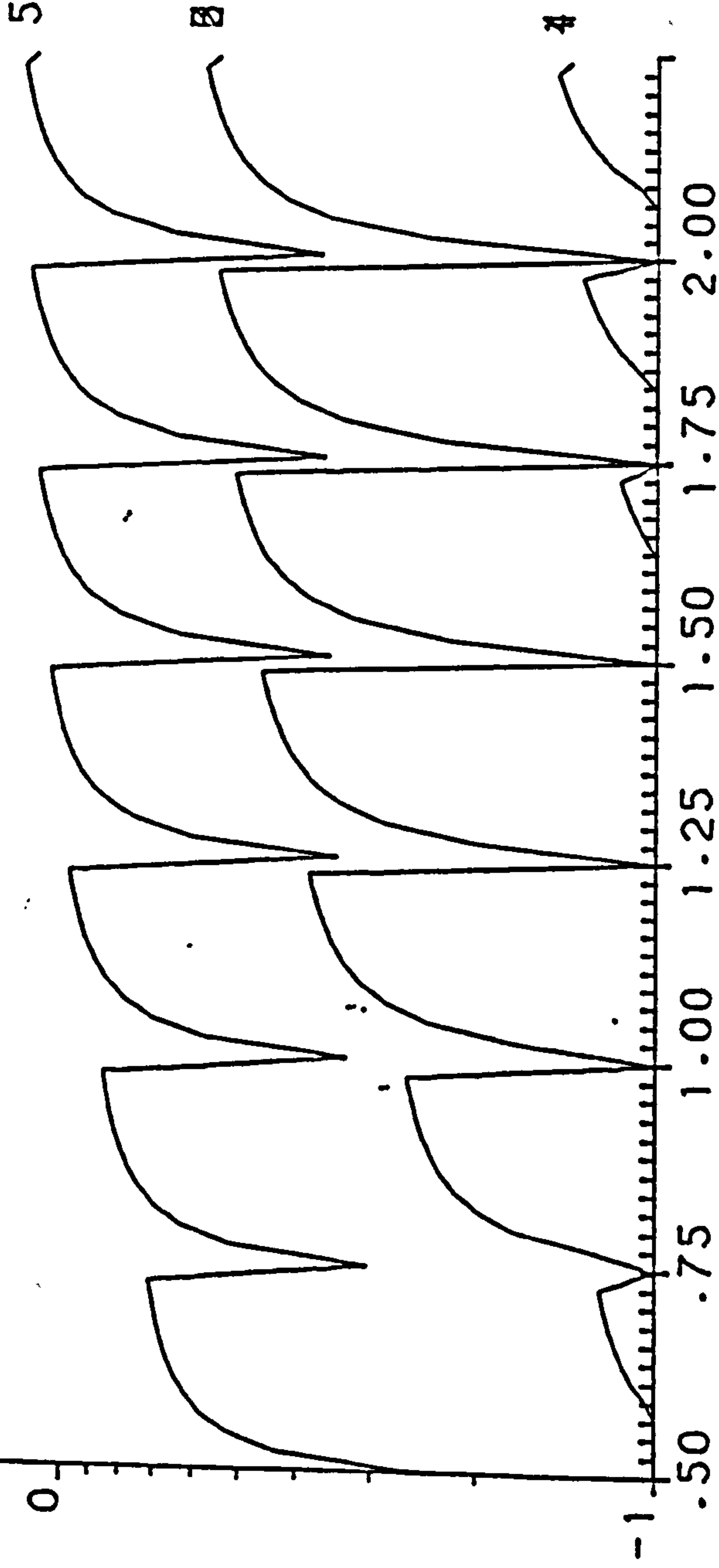

S. EFFICIENCY W. THICKNESS = .24M W. ORIENTATION=337.50

WD= 1M HD1= 22M HD2= 6M HOUSE T.=1.5 ST.

LOG10  
1  
0  
-1

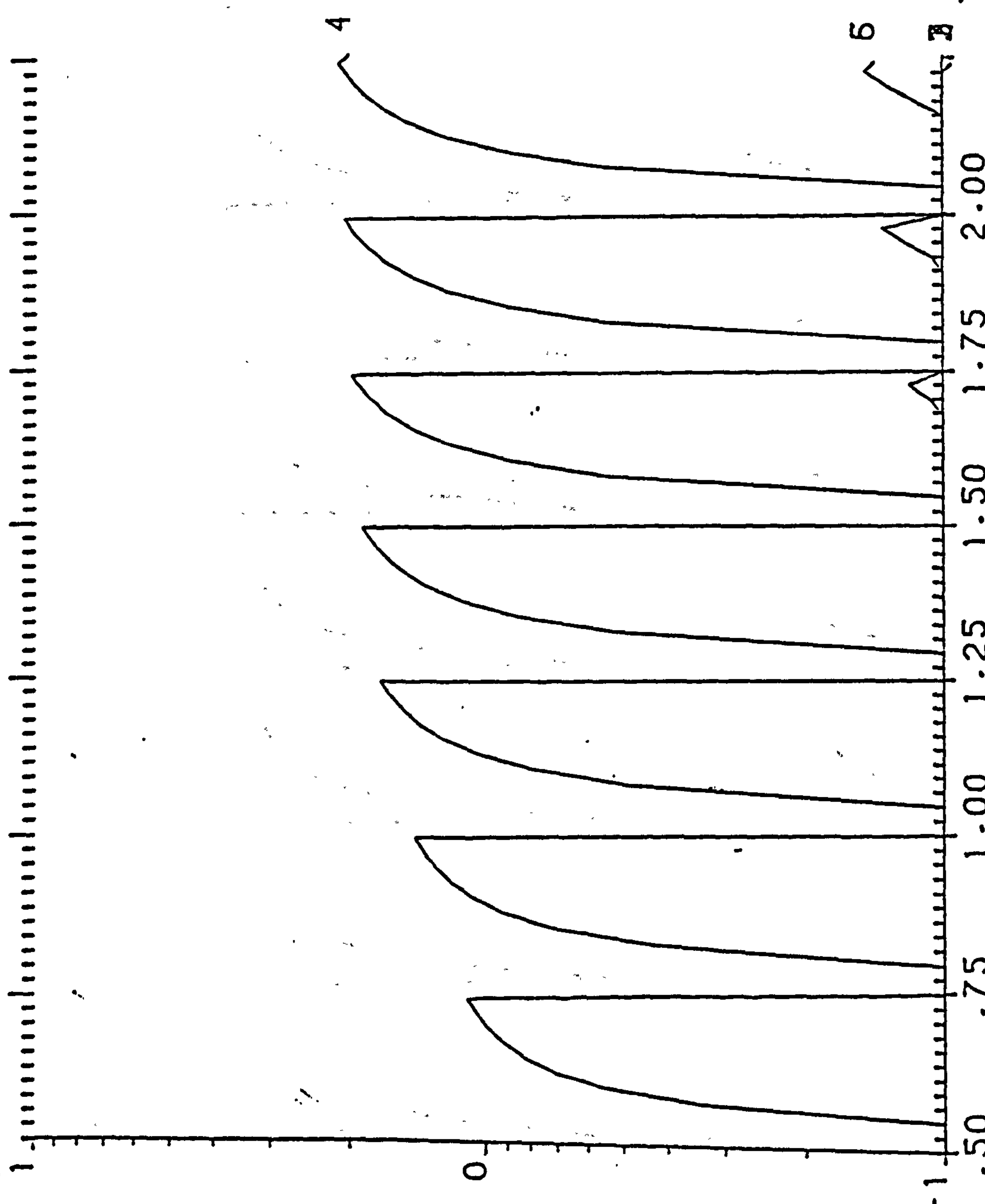

S. EFFICIENCY W. THICKNESS= .36M W. ORIENTATION= .00

WD= 1M HD1= 22M HD2= 6M HOUSE T.=1.5 ST.



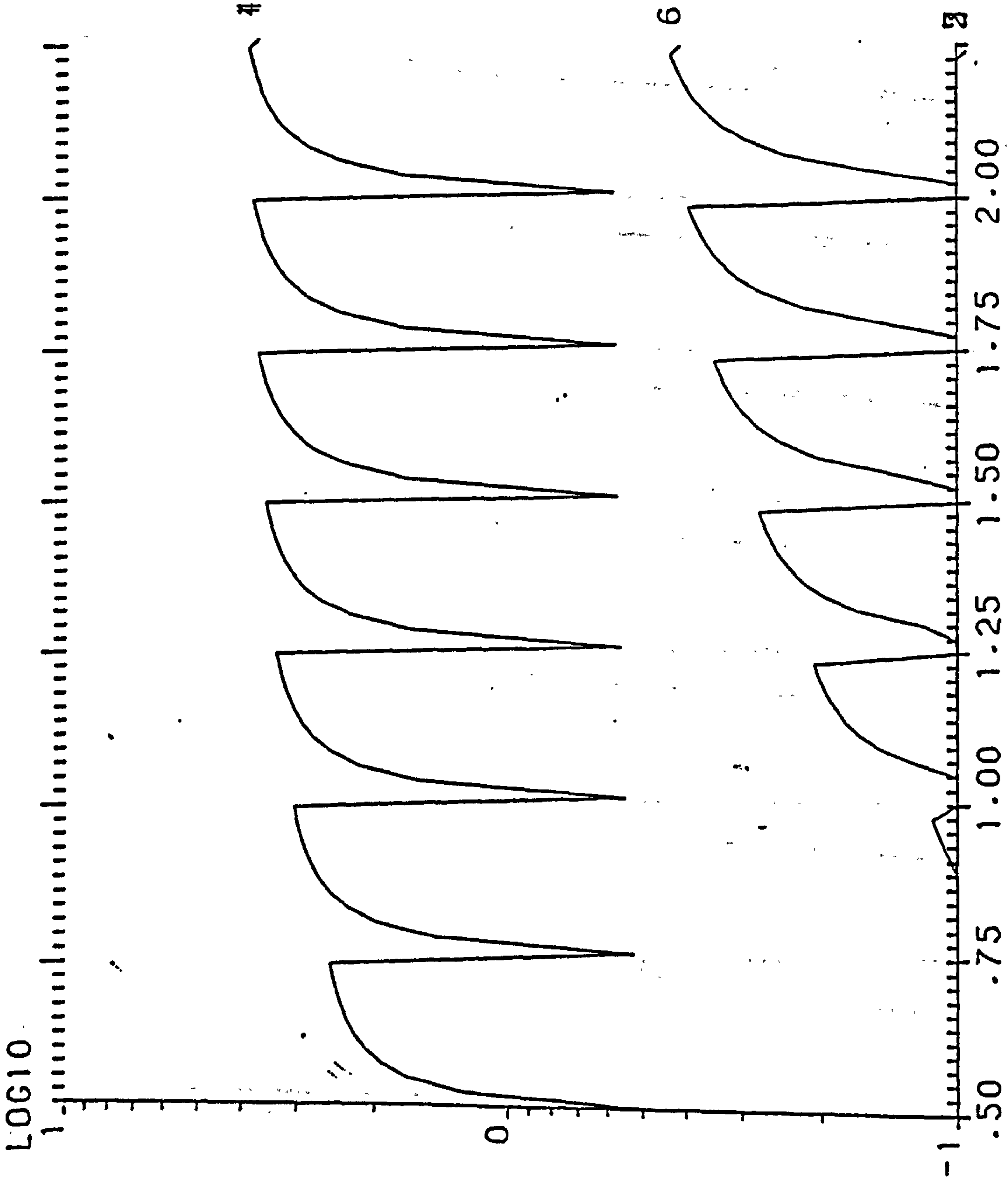

S. EFFICIENCY W. THICKNESS = .36M W. ORIENTATION = 22.50

WD = 1M HD1 = 22M HD2 = 6M HOUSE T. = 1.5 ST.



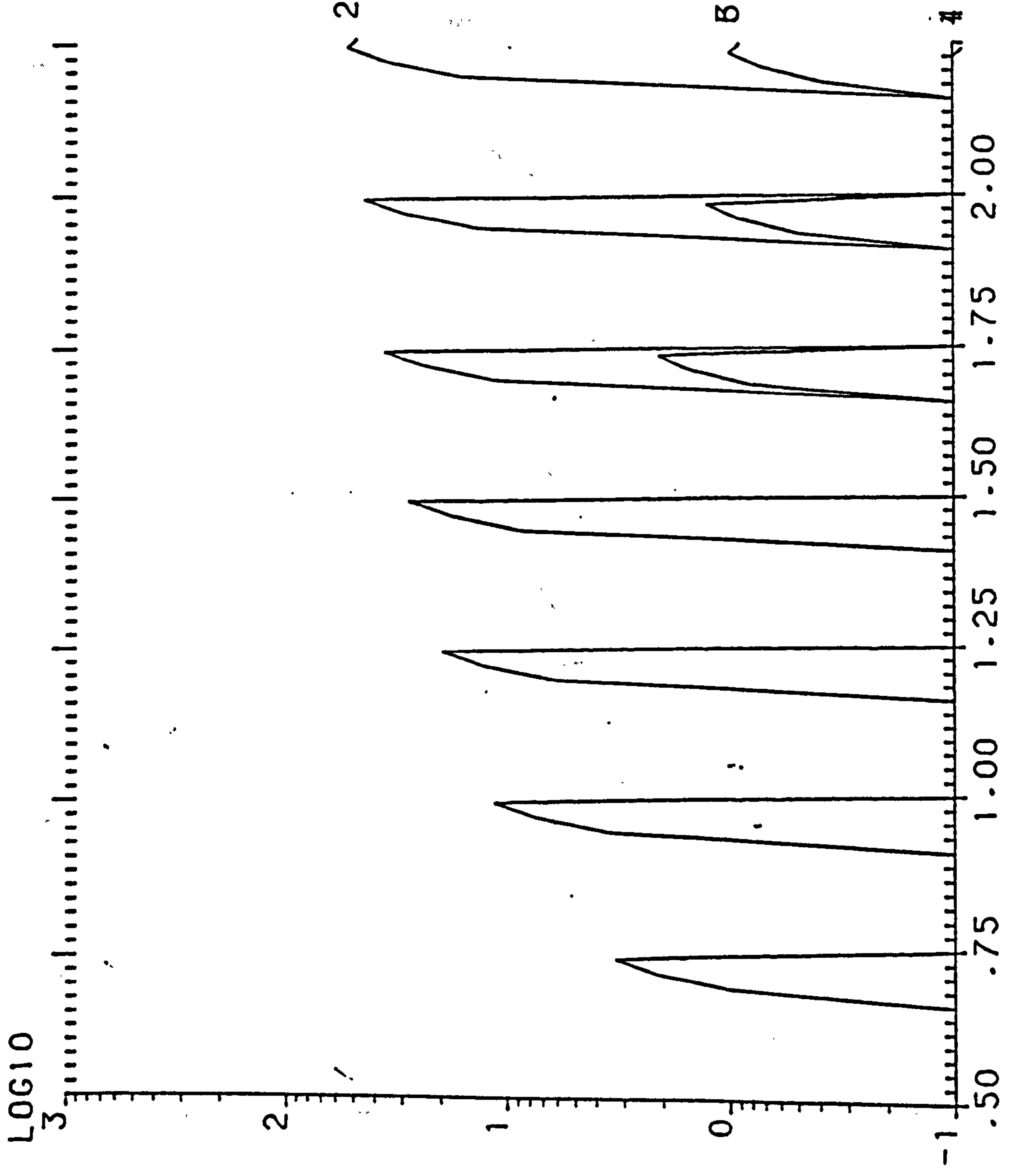

Y. EFFICIENCY    W. THICKNESS= .36M    W. ORIENTATION= 45.00

WD= 1M    HD1= 22M    HD2= 6M    HOUSE T.=1.5 ST.



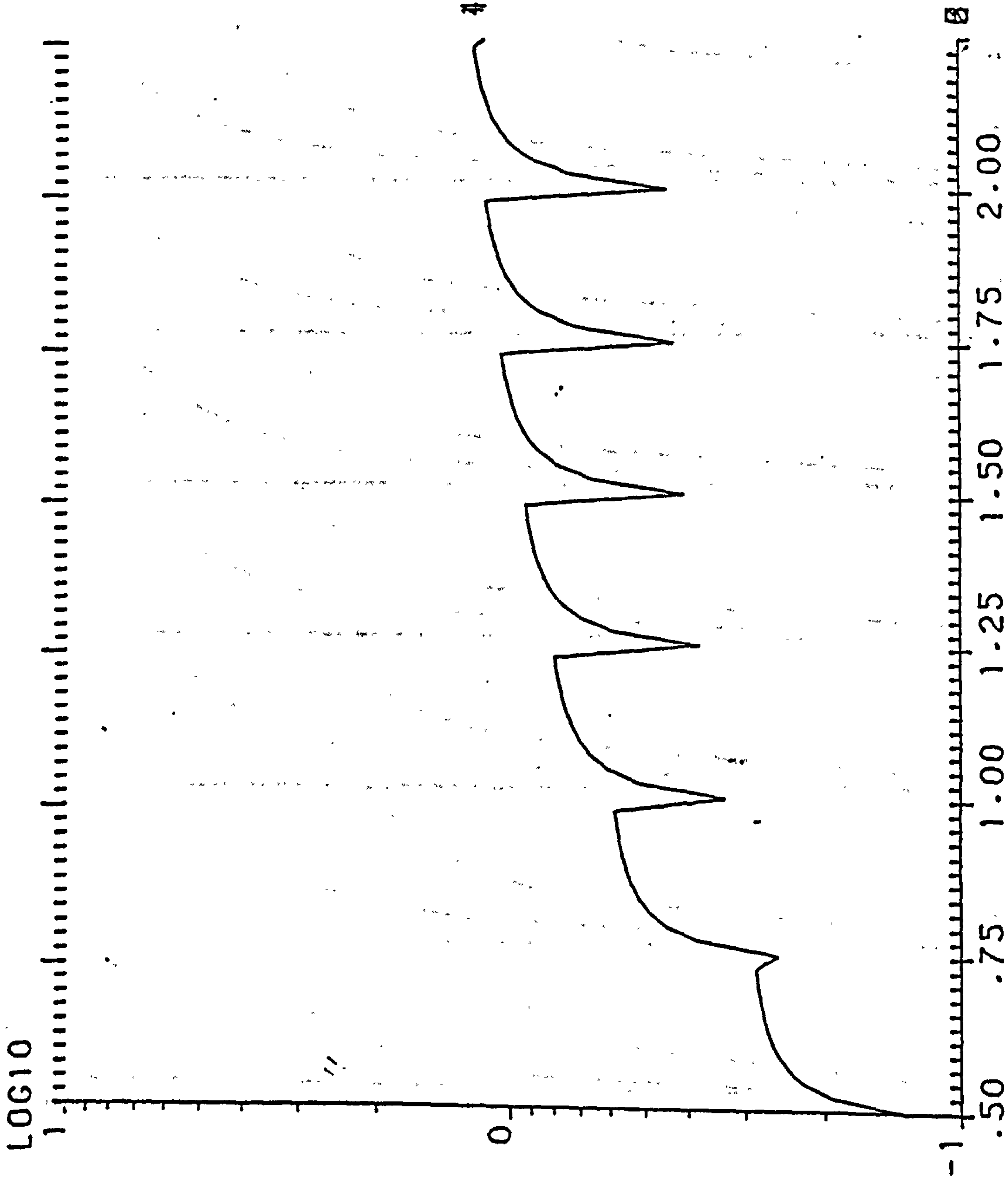

S. EFFICIENCY W. THICKNESS= .36M W. ORIENTATION= 45.00

WD= 1M HD1= 22M HD2= 6M HOUSE T.=1.5 ST.

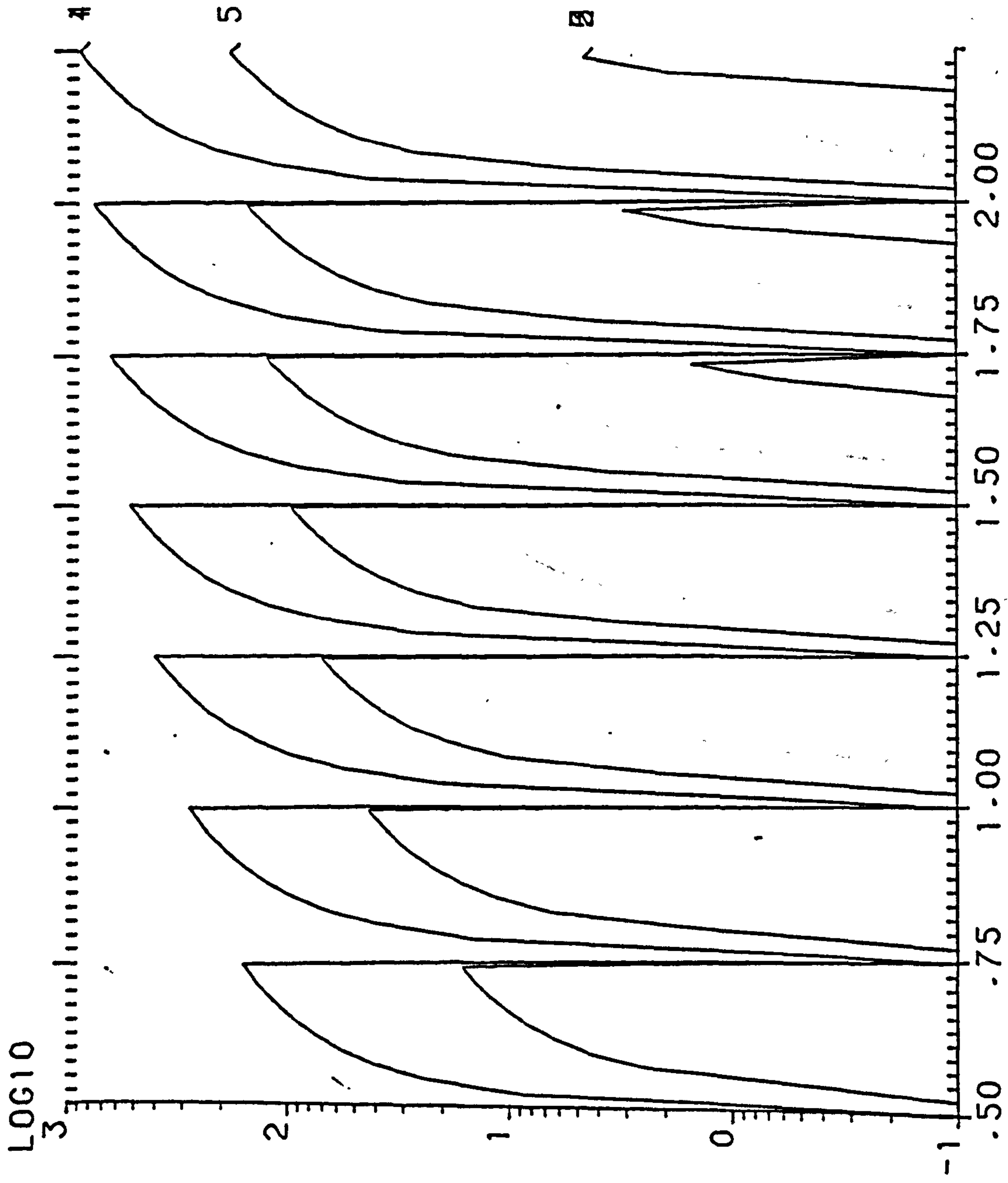

Y. EFFICIENCY W. THICKNESS= .36M W. ORIENTATION= 67.50

WD= 1M HD1= 22M HD2= 6M HOUSE T.=1.5 ST.

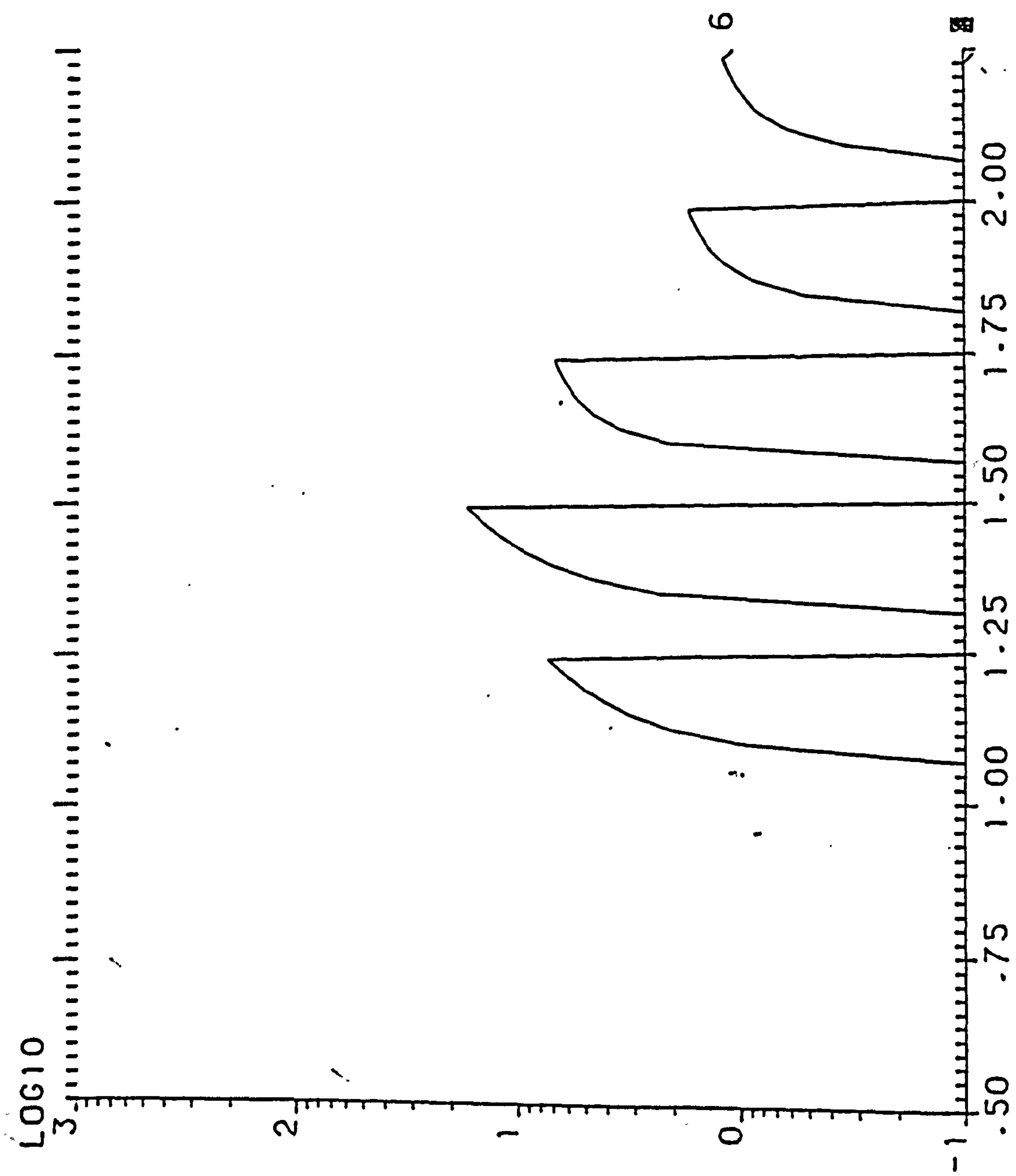

Y. EFFICIENCY W. THICKNESS= .36M W. ORIENTATION= 90.00

WD= 1M HD1= 22M HD2= 6M HOUSE T.=1.5 ST.

LOG10

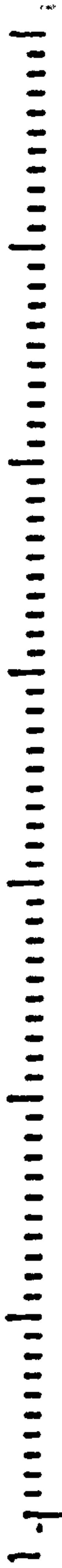

.50 .75 1.00 1.25 1.50 1.75 2.00

S. EFFICIENCY W. THICKNESS = .36M W. ORIENTATION = 90.00

WD = 1M HD1 = 22M HD2 = 6M HOUSE T. = 1.5 ST.

LOG10  
3

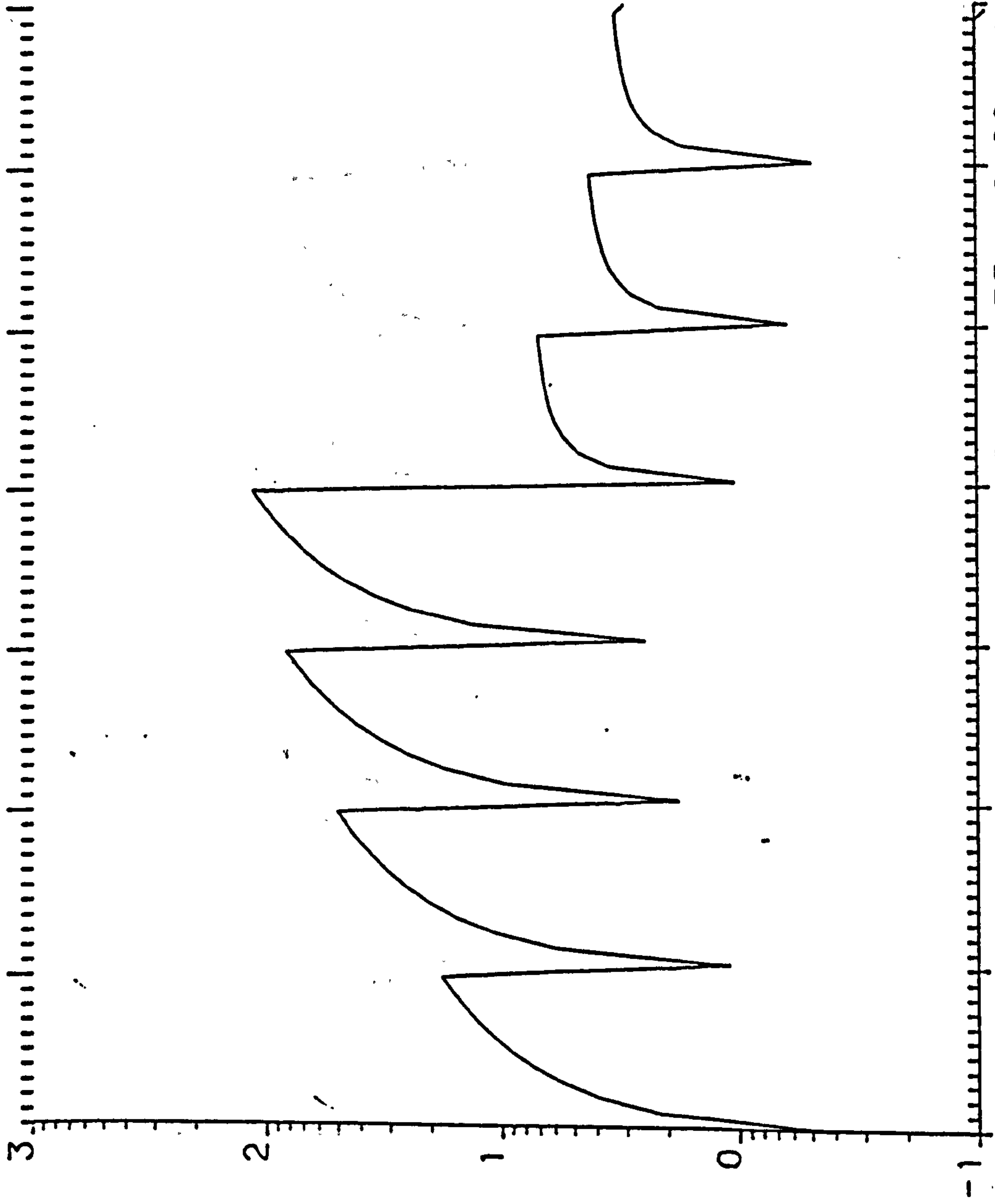

-1  
0.50 0.75 1.00 1.25 1.50 1.75 2.00

Y. EFFICIENCY W. THICKNESS= .36M W. ORIENTATION=112.50

WD= 1M HD1= 22M HD2= 6M HOUSE T.=1.5 ST.



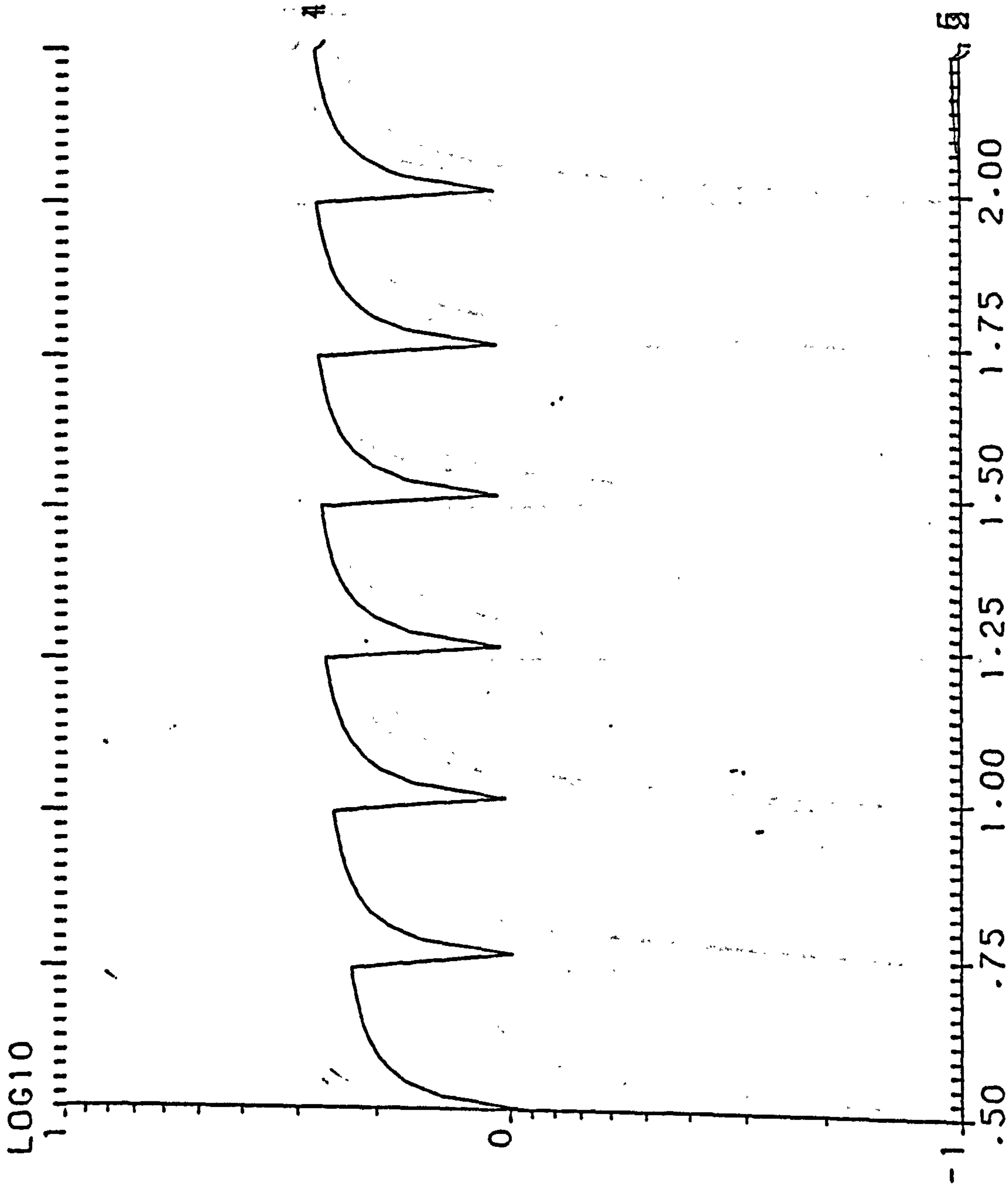

S. EFFICIENCY W. THICKNESS = .36M W. ORIENTATION=112.50

WD= 1M HD1= 22M HD2= 6M HOUSE T.=1.5 ST.



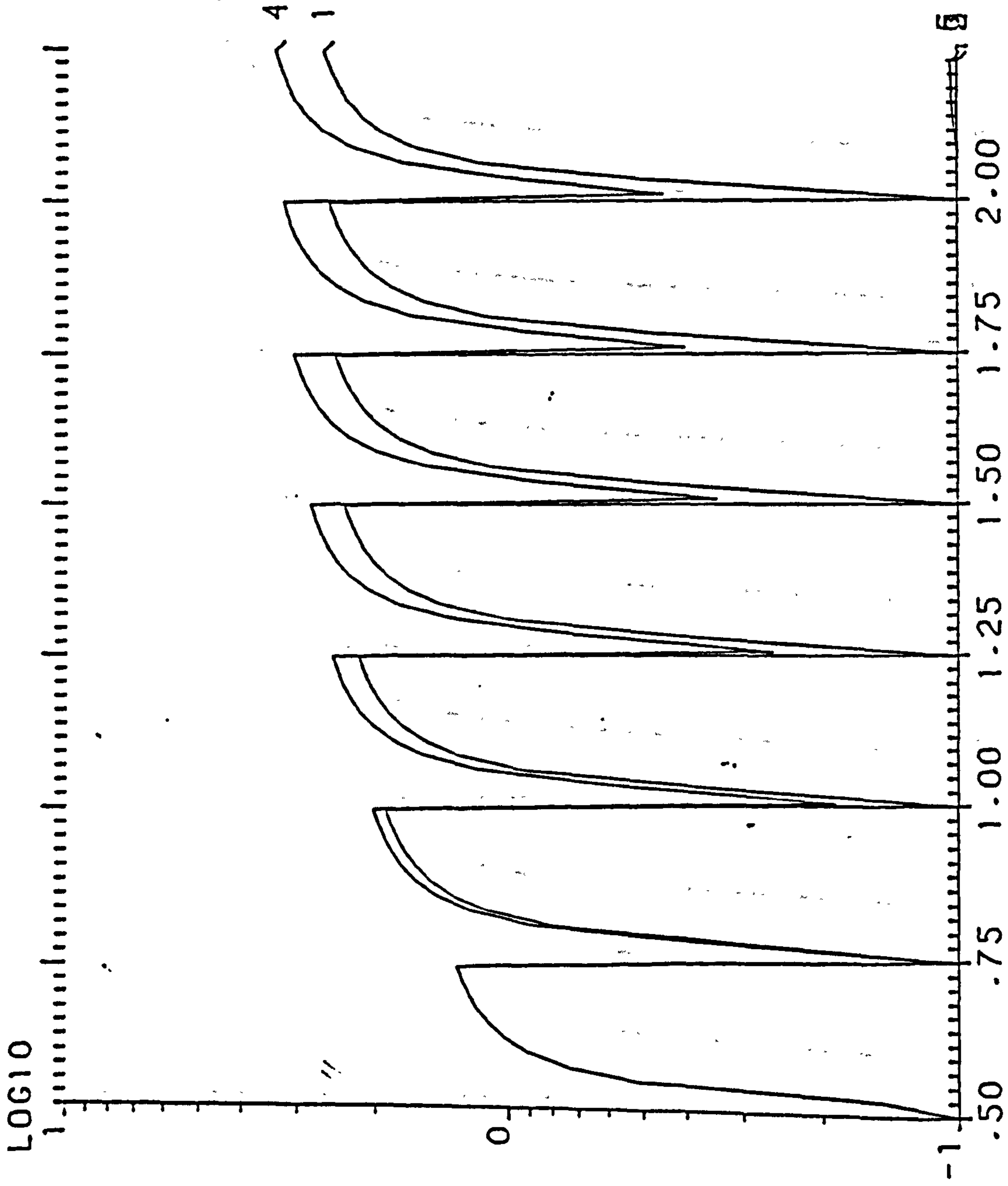

S. EFFICIENCY W. THICKNESS= .36M W. ORIENTATION=135.00

WD= 1M HD1= 22M HD2= 6M HOUSE T.=1.5 ST.



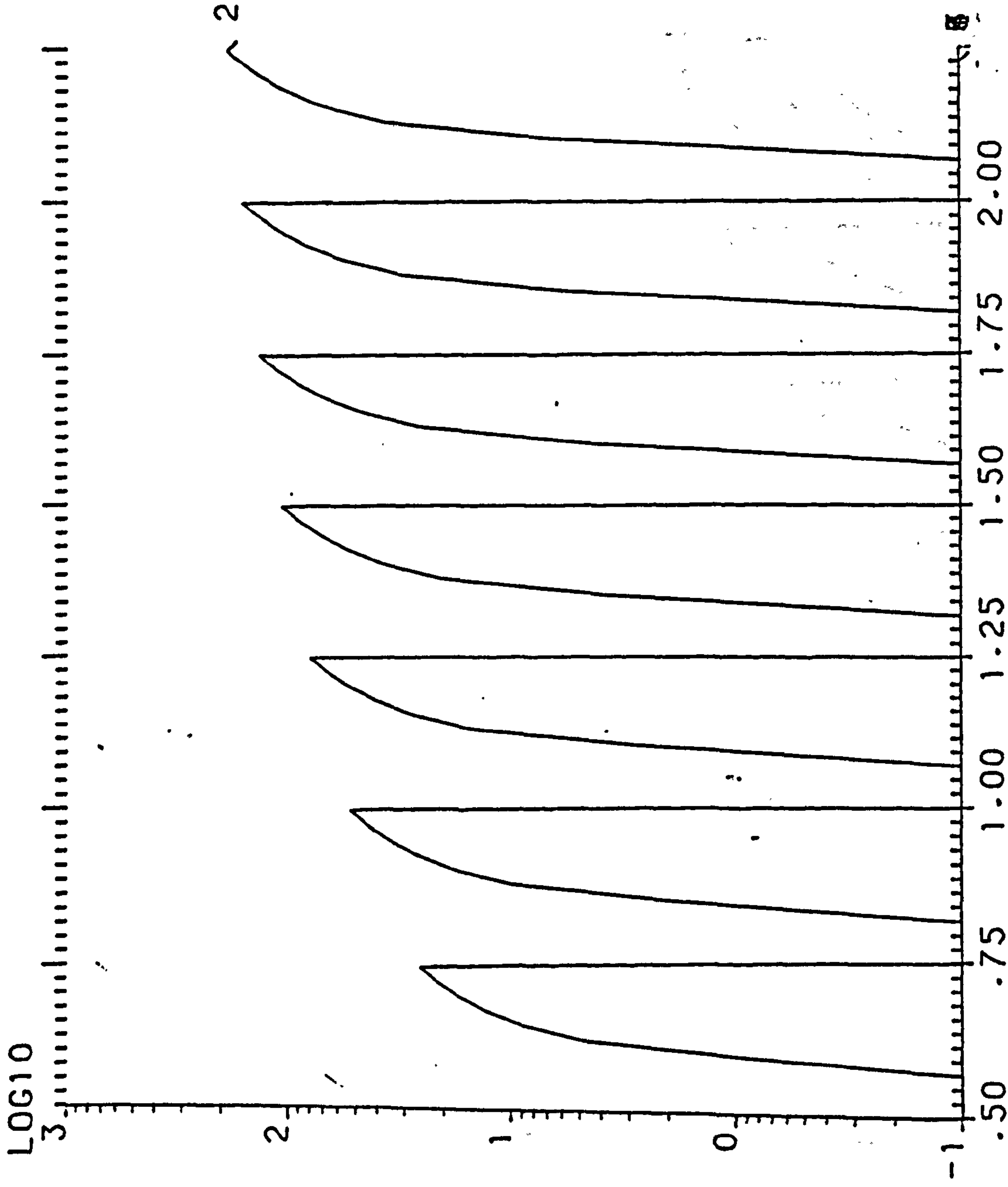

Y. EFFICIENCY W. THICKNESS = .36M W. ORIENTATION=157.50

WD= 1M HD1= 22M HD2= 6M HOUSE T.=1.5 ST.

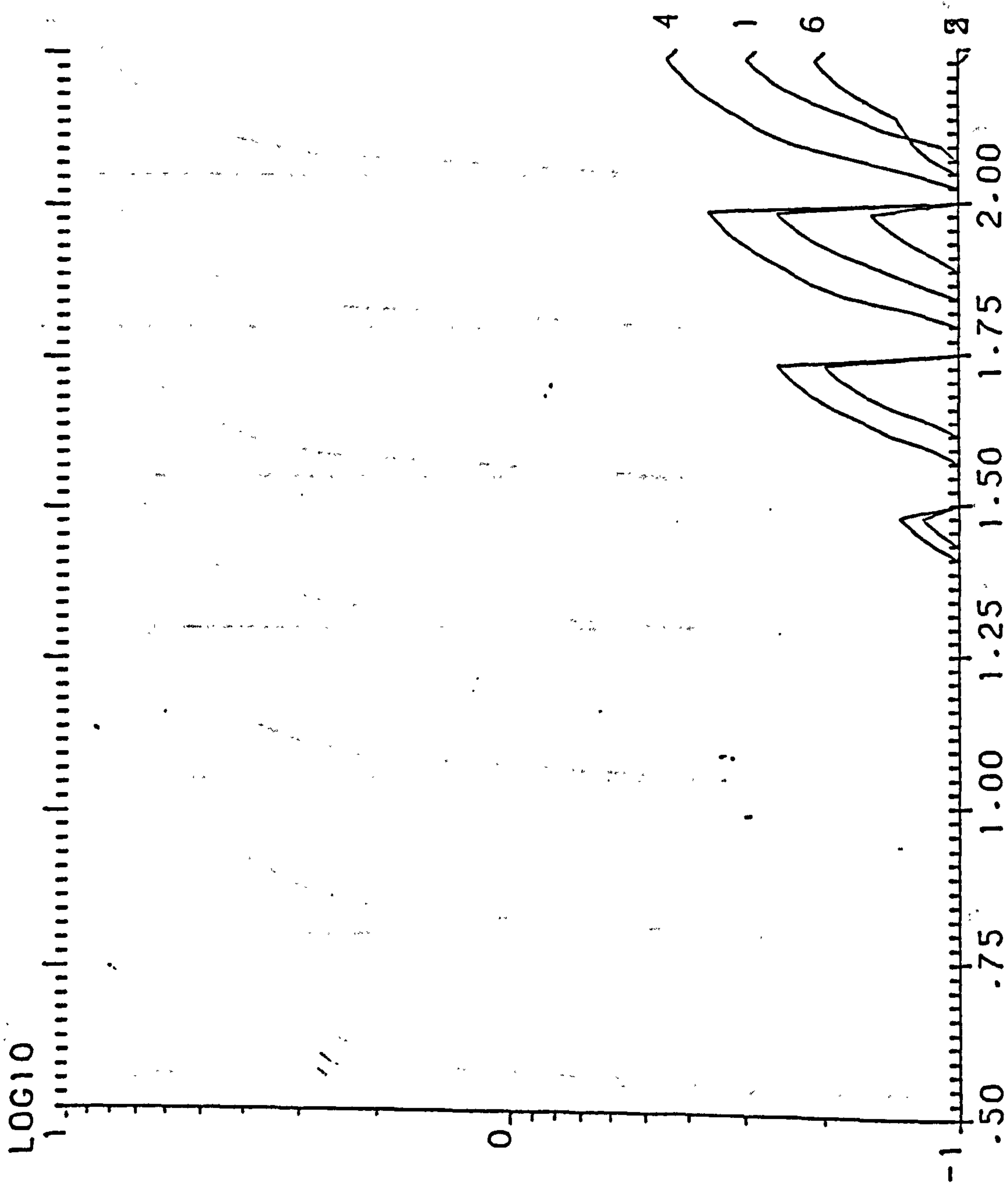

S. EFFICIENCY W. THICKNESS = .36M W. ORIENTATION = 157.50

WD = 1M HD1 = 22M HD2 = 6M HOUSE T. = 1.5 ST.

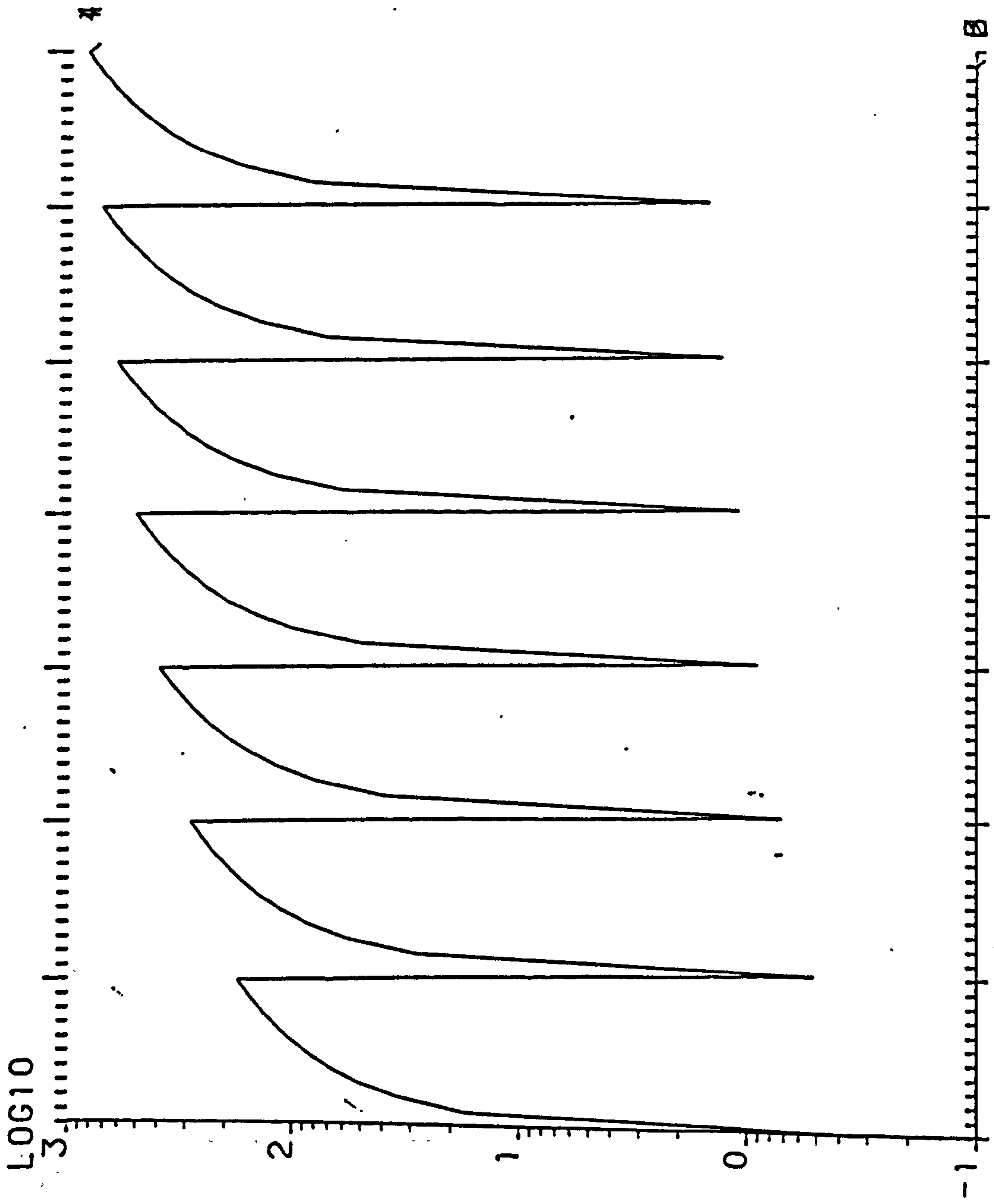

Y. EFFICIENCY W. THICKNESS= .36M W. ORIENTATION=180.00

WD= 1M HD1= 22M HD2= 6M HOUSE T.=1.5 ST.



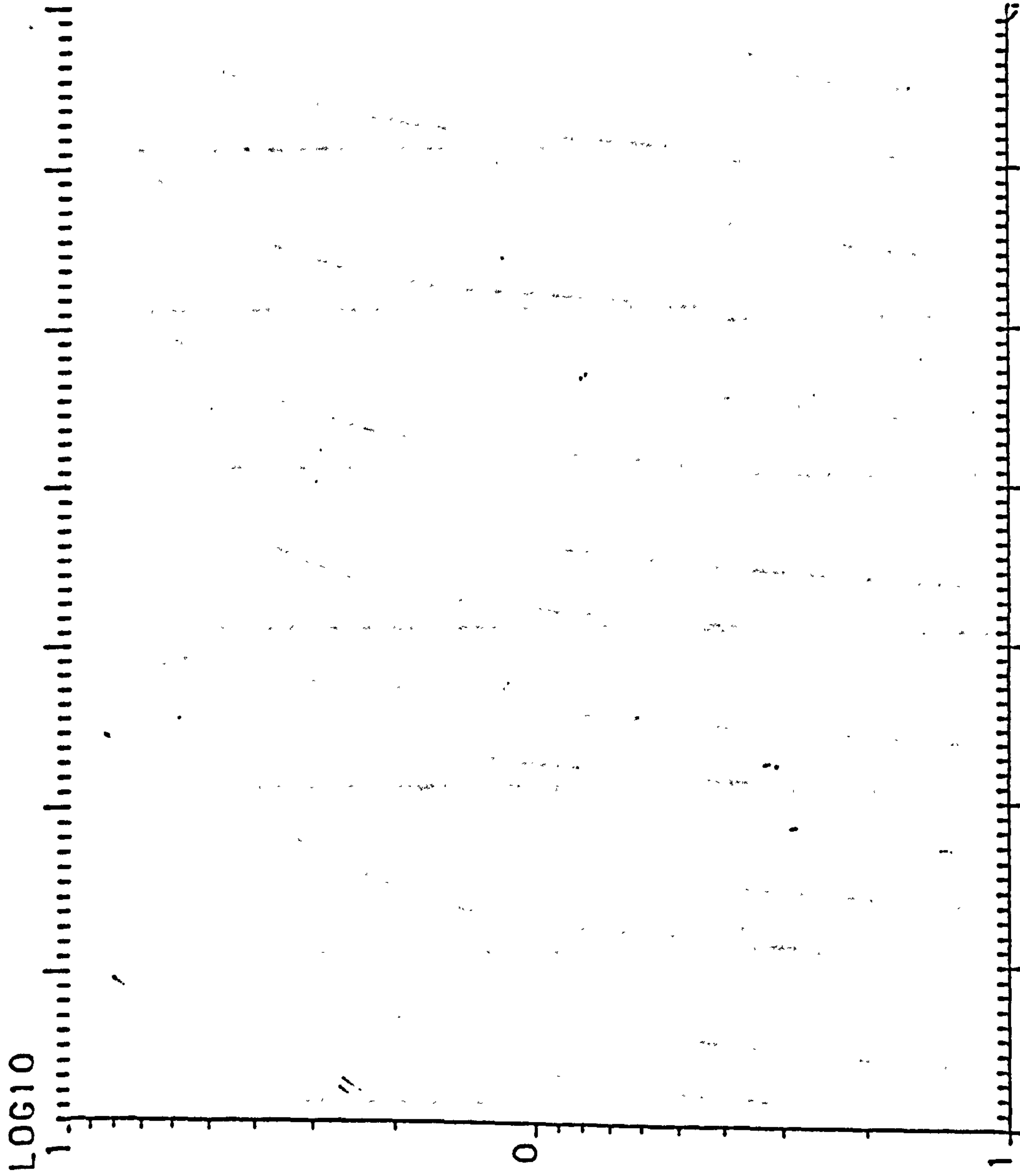

S. EFFICIENCY W. THICKNESS= .36M W. ORIENTATION=180.00

WD= 1M HD1= 22M HD2= 6M HOUSE T.=1.5 ST.

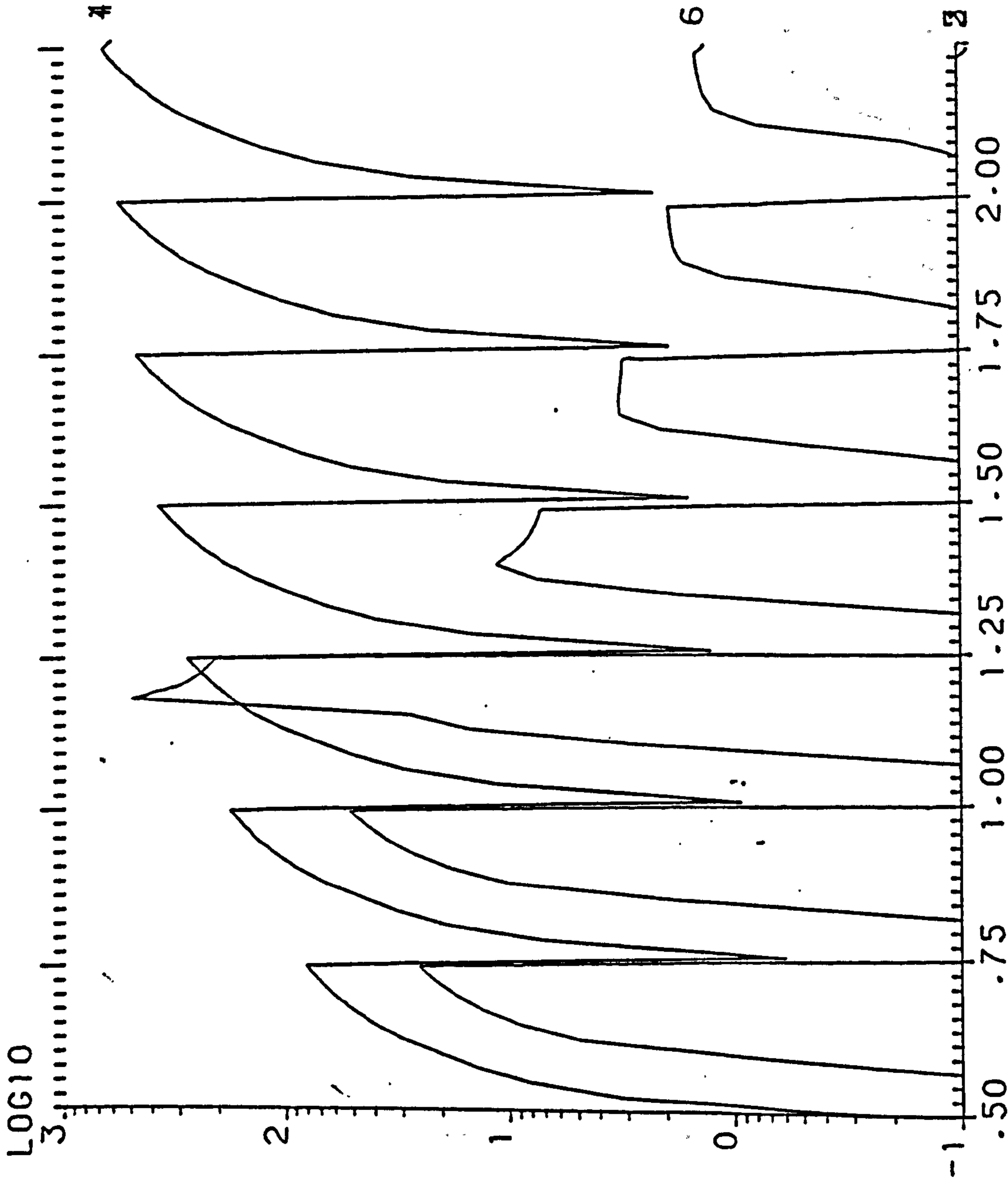

Y. EFFICIENCY W. THICKNESS= .36M W. ORIENTATION=202.50

WD= 1M HD1= 22M HD2= 6M HOUSE T.=1.5 ST.

LOG10

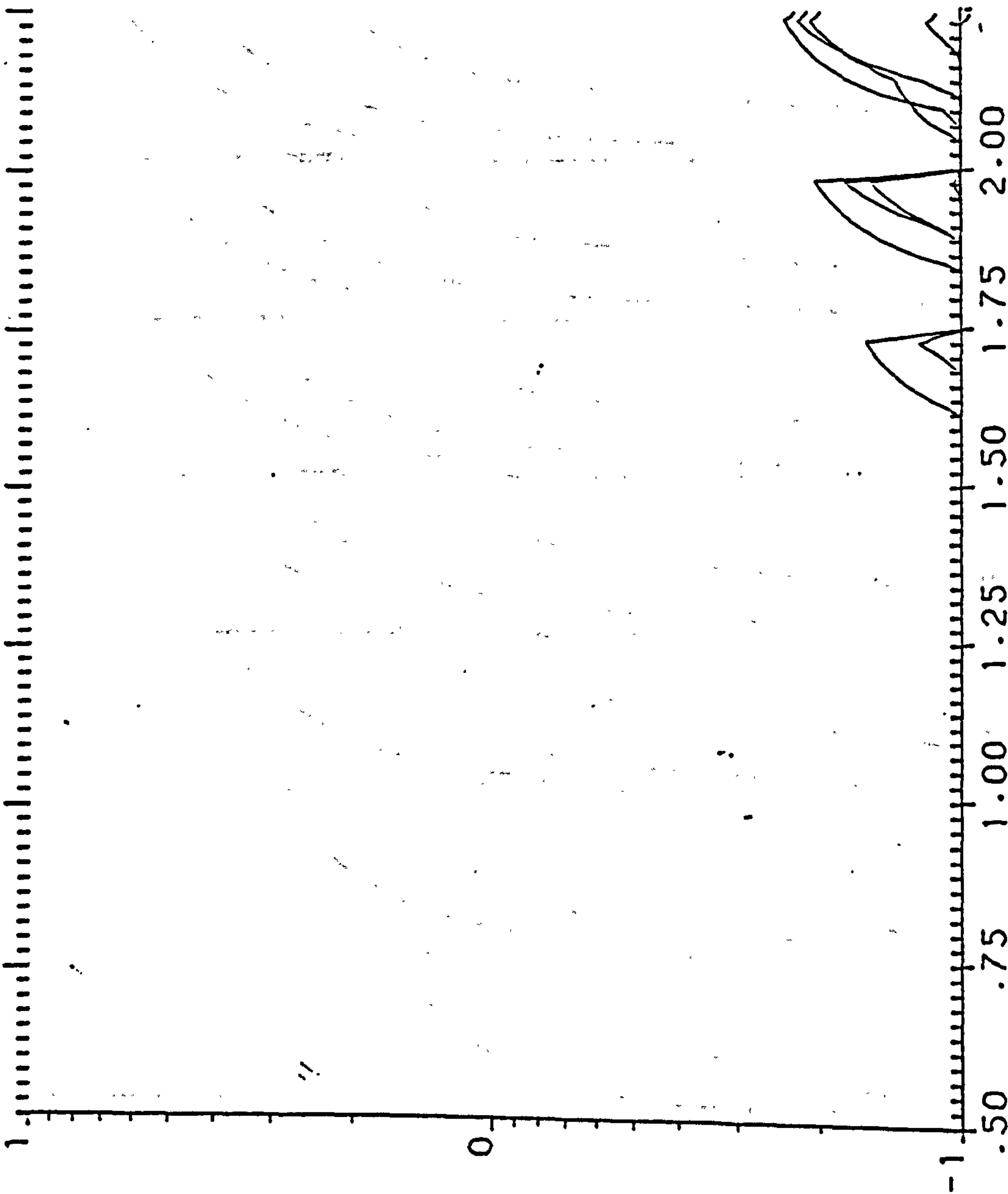

S. EFFICIENCY W. THICKNESS= .36M W. ORIENTATION=202.50

WD= 1M HD1= 22M HD2= 6M HOUSE T.=1.5 ST.



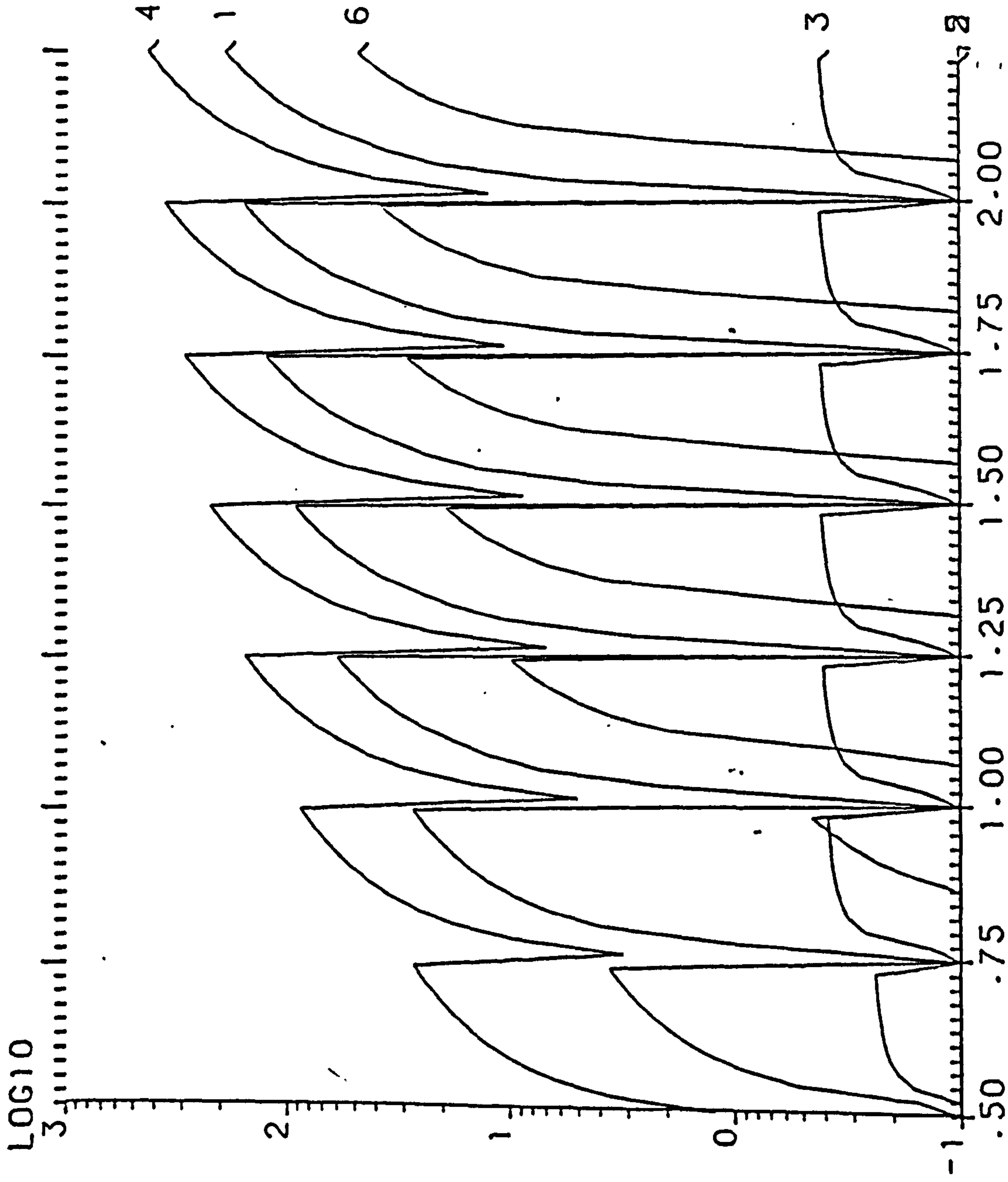

Y. EFFICIENCY W. THICKNESS= .36M W. ORIENTATION=225.00

WD= 1M HD1= 22M HD2= 6M HOUSE T.=1.5 ST.

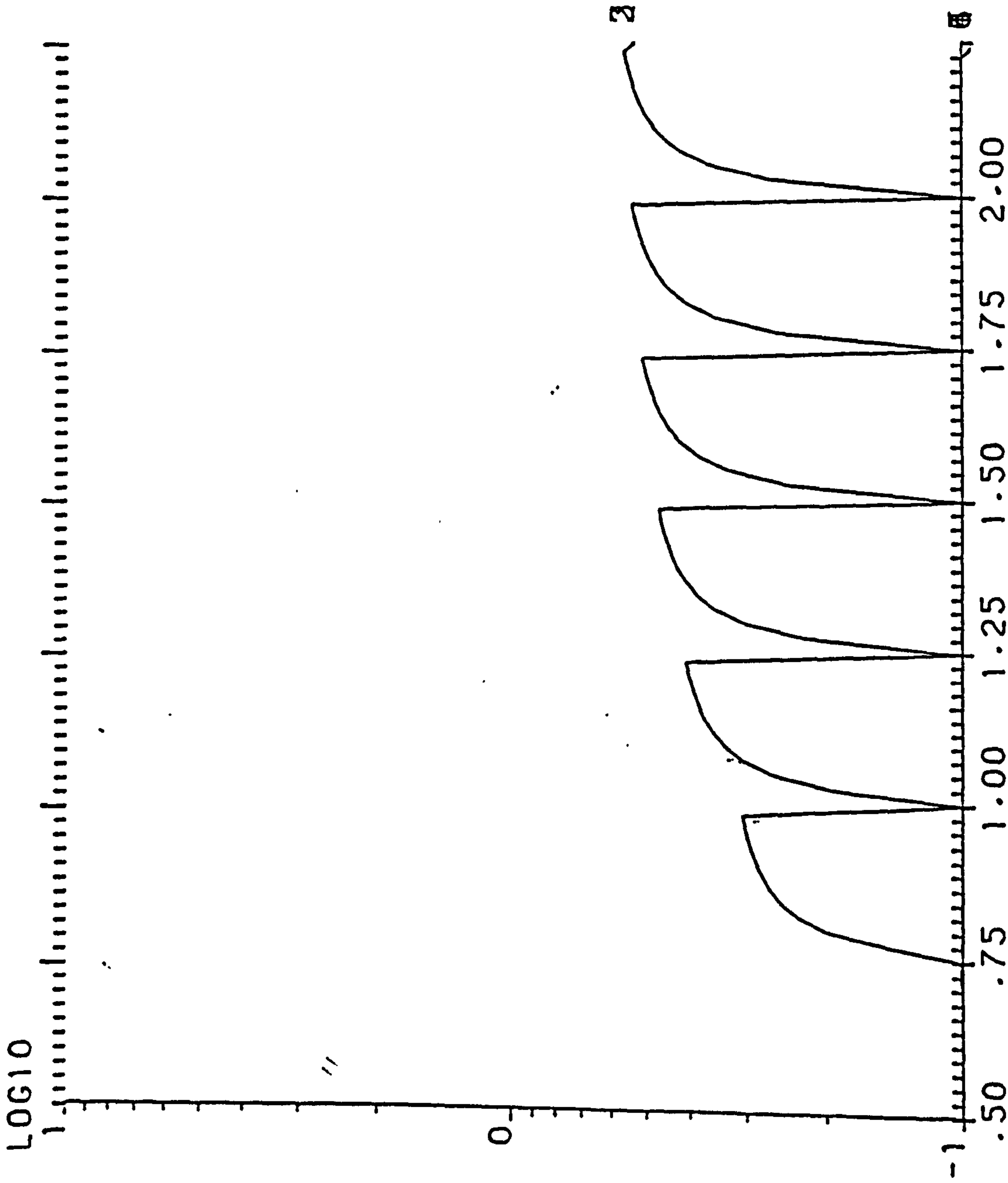

S. EFFICIENCY W. THICKNESS= .36M W. ORIENTATION=225.00

WD= 1M HD1= 22M HD2= 6M HOUSE T.=1.5 ST.



LOG10

1

0

-1

.50

.75

1.00

1.25

1.50

1.75

2.00

2



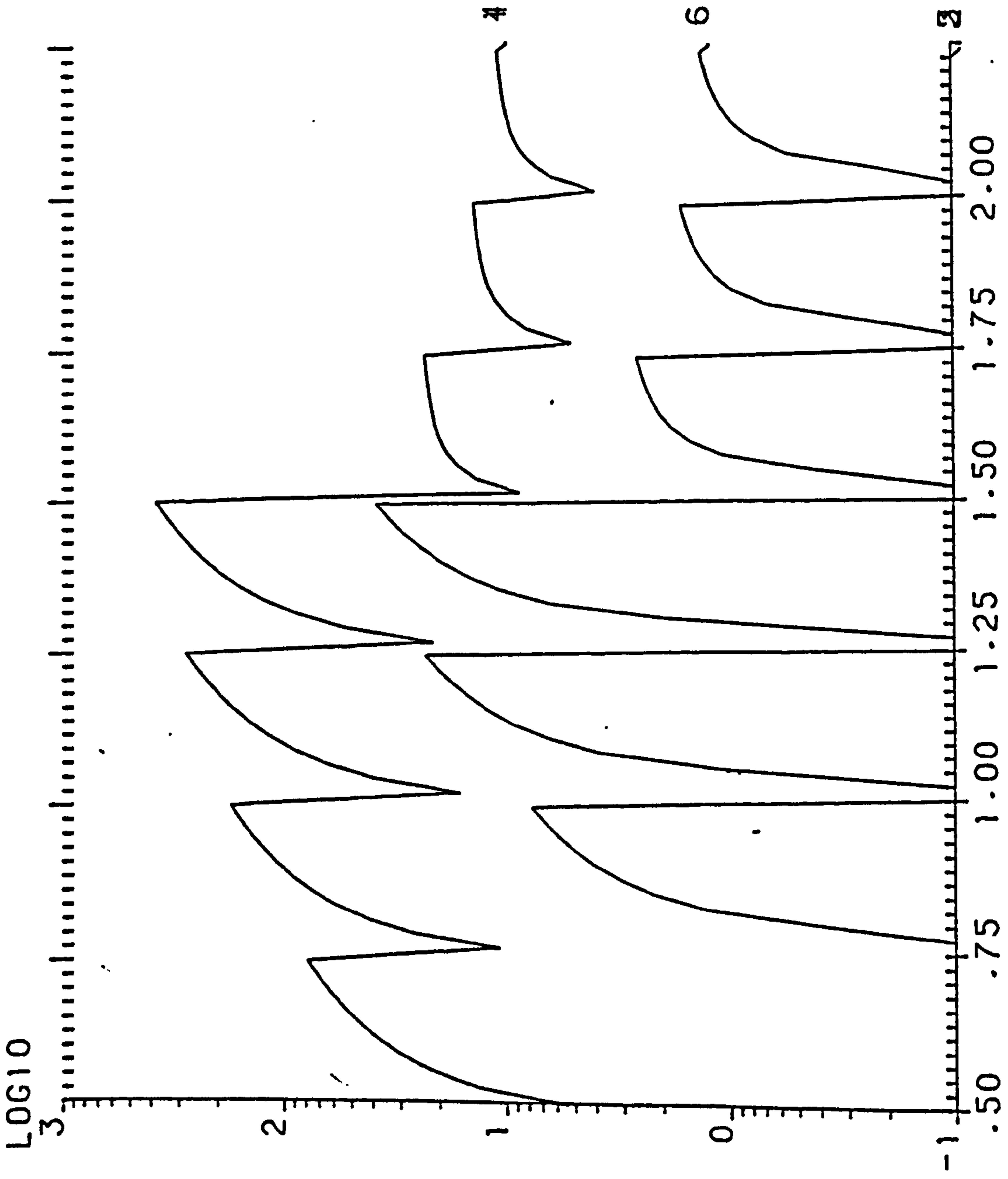

Y. EFFICIENCY W. THICKNESS= .36M W. ORIENTATION=247.50

WD= 1M HD1= 22M HD2= 6M HOUSE T.=1.5 ST.

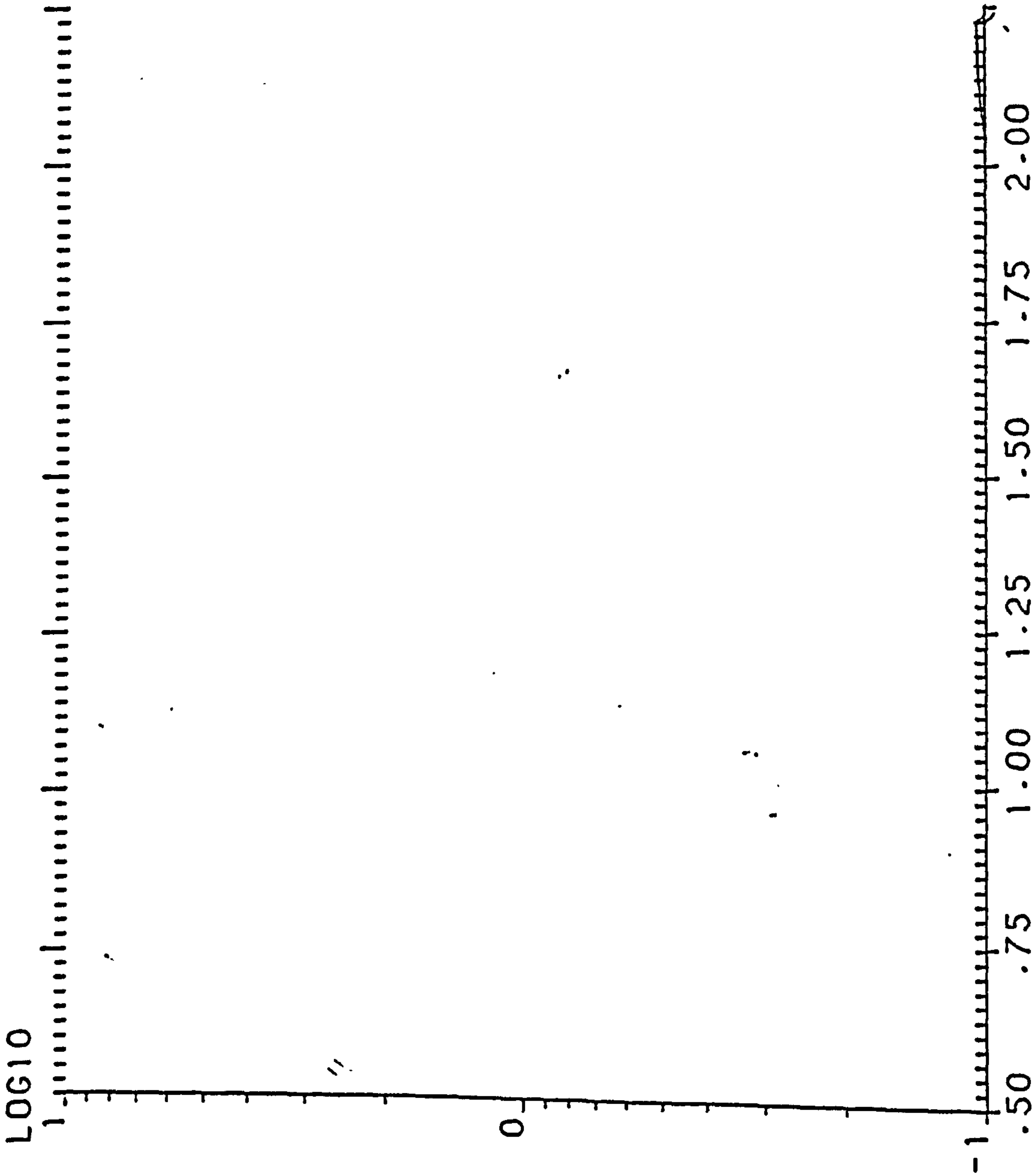

S. EFFICIENCY W. THICKNESS = .36M W. ORIENTATION = 247.50

WD = 1M HD1 = 22M HD2 = 6M HOUSE T = 1.5 ST.



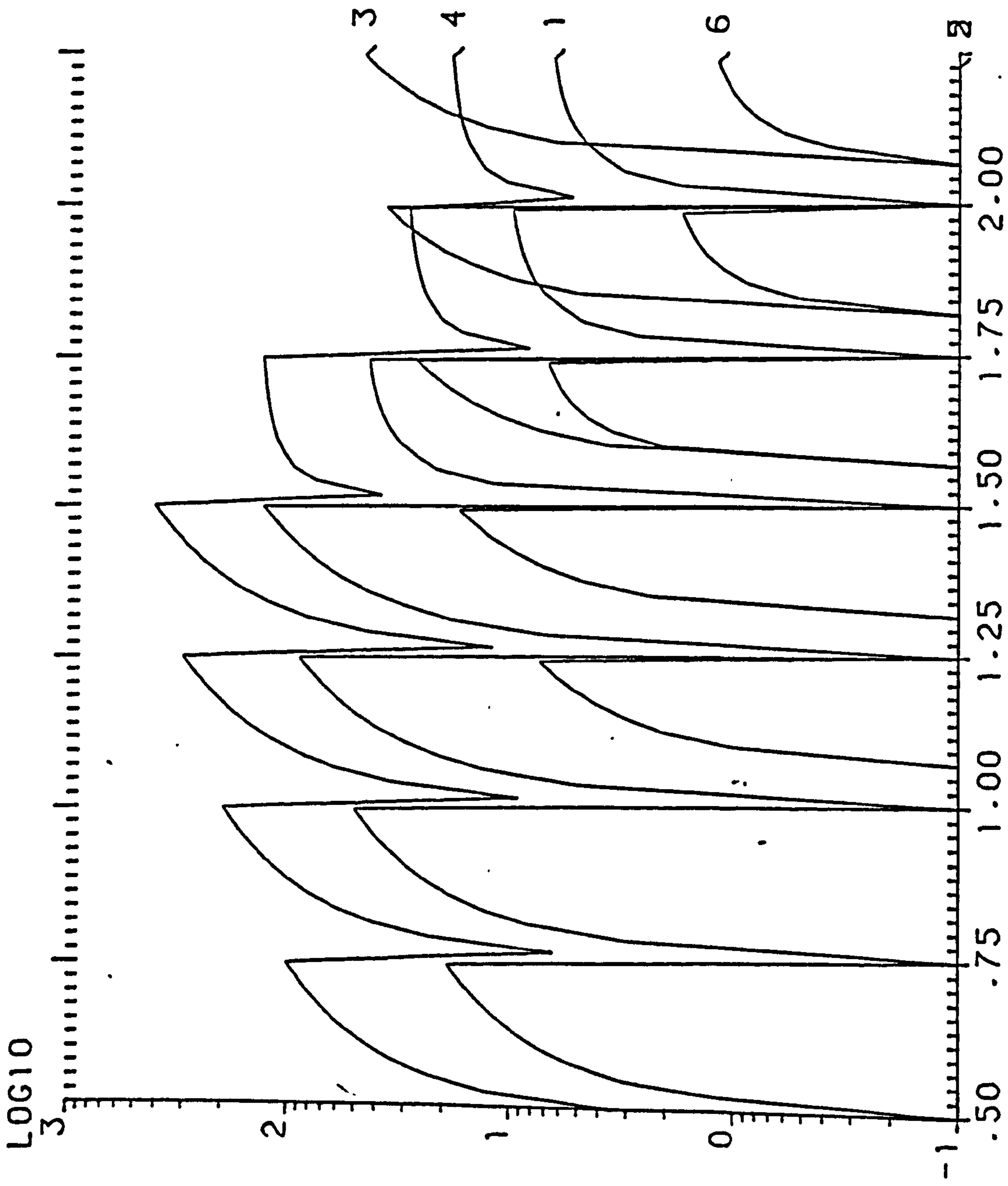

Y. EFFICIENCY    W. THICKNESS=    .36M    W. ORIENTATION=270.00  
WD= 1M    HD1= 22M    HD2= 6M    HOUSE T.=1.5 ST.

LOG10  
1

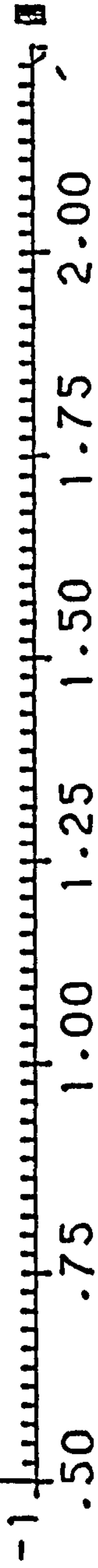

S. EFFICIENCY    W. THICKNESS=    .36M    W. ORIENTATION=270.00

WD= 1M    HD1= 22M    HD2= 6M    HOUSE T.=1.5 ST.

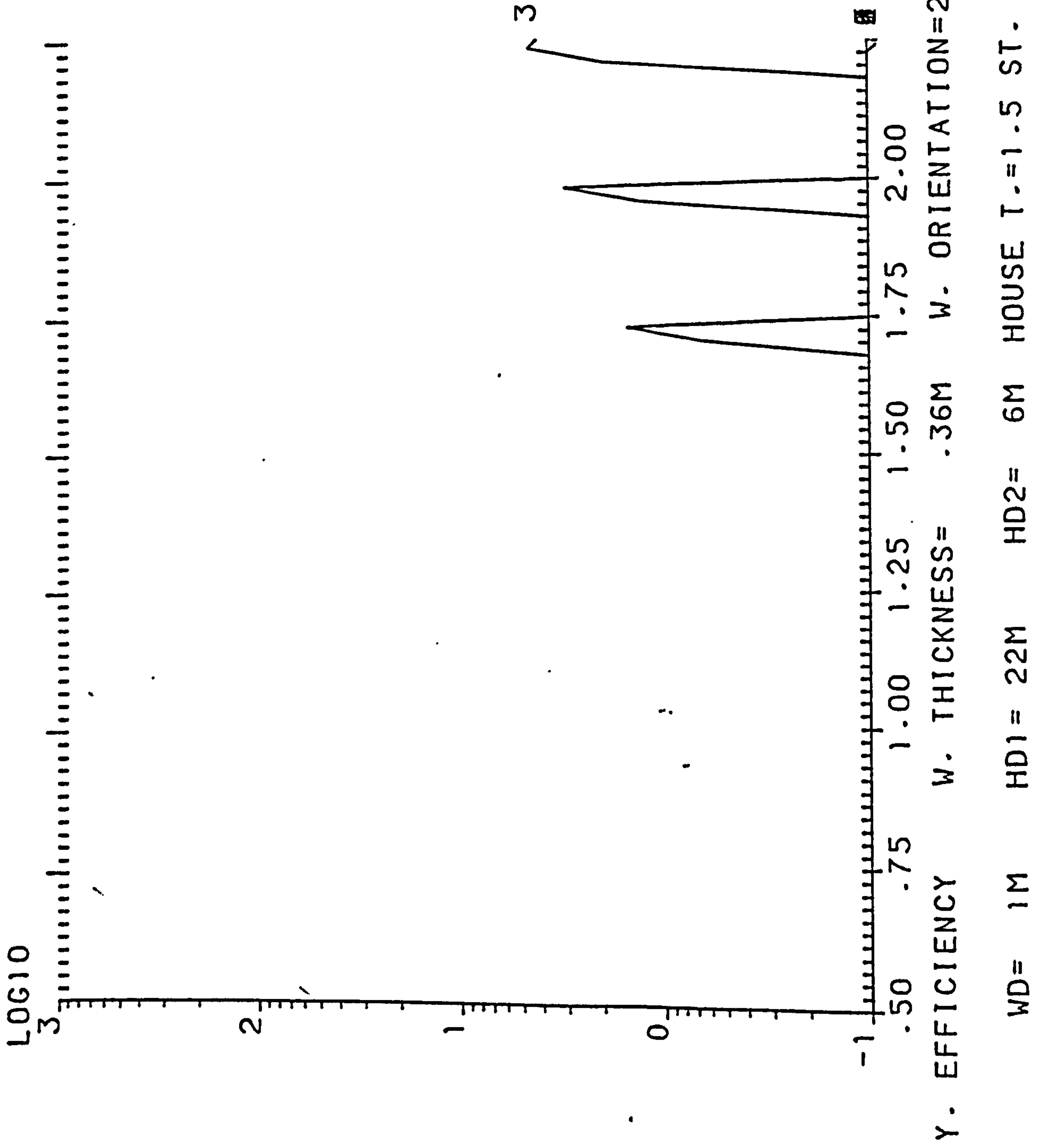



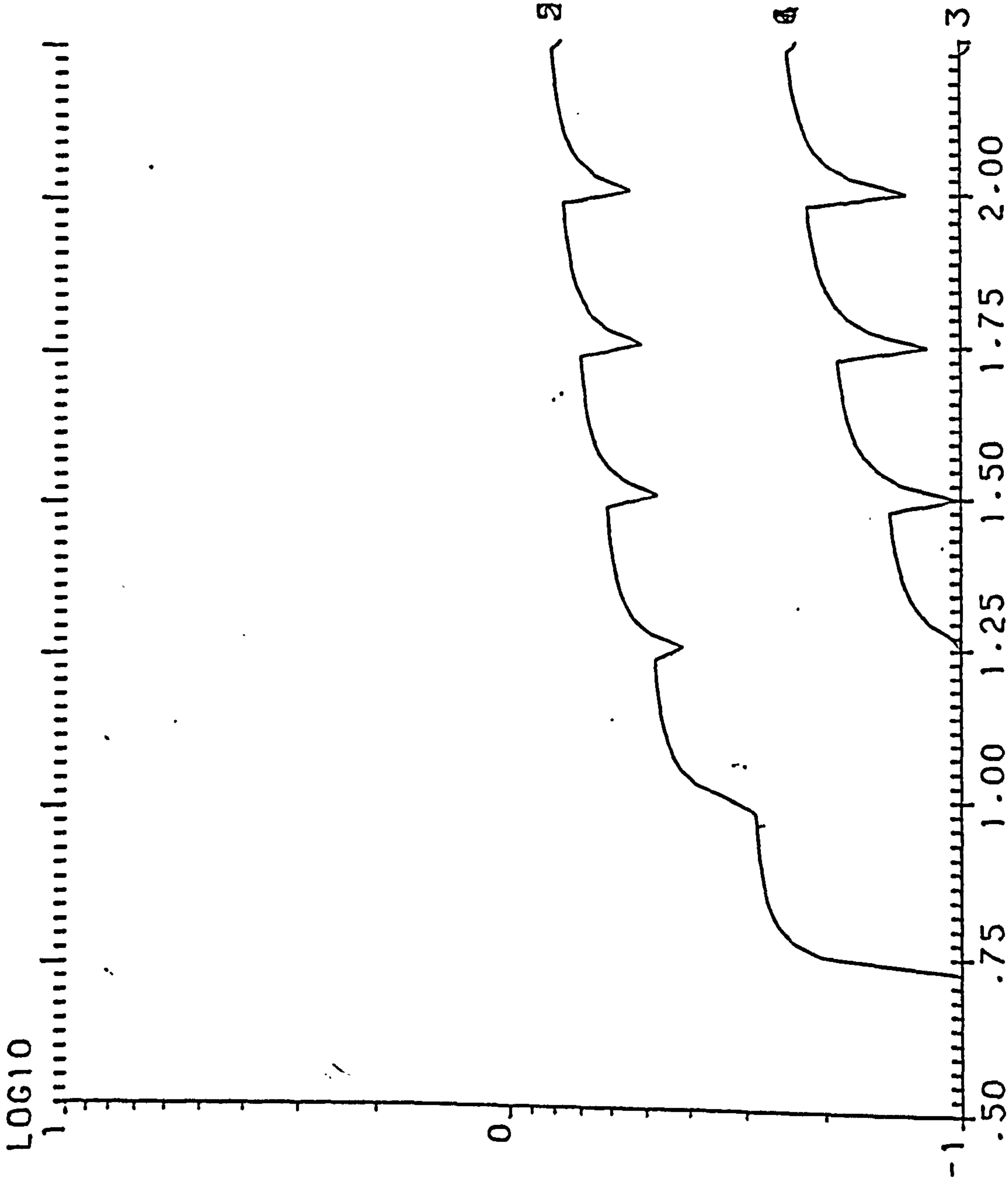

S. EFFICIENCY W. THICKNESS = .36M W. ORIENTATION=292.50

WD= 1M HD1= 22M HD2= 6M HOUSE T.=1.5 ST.



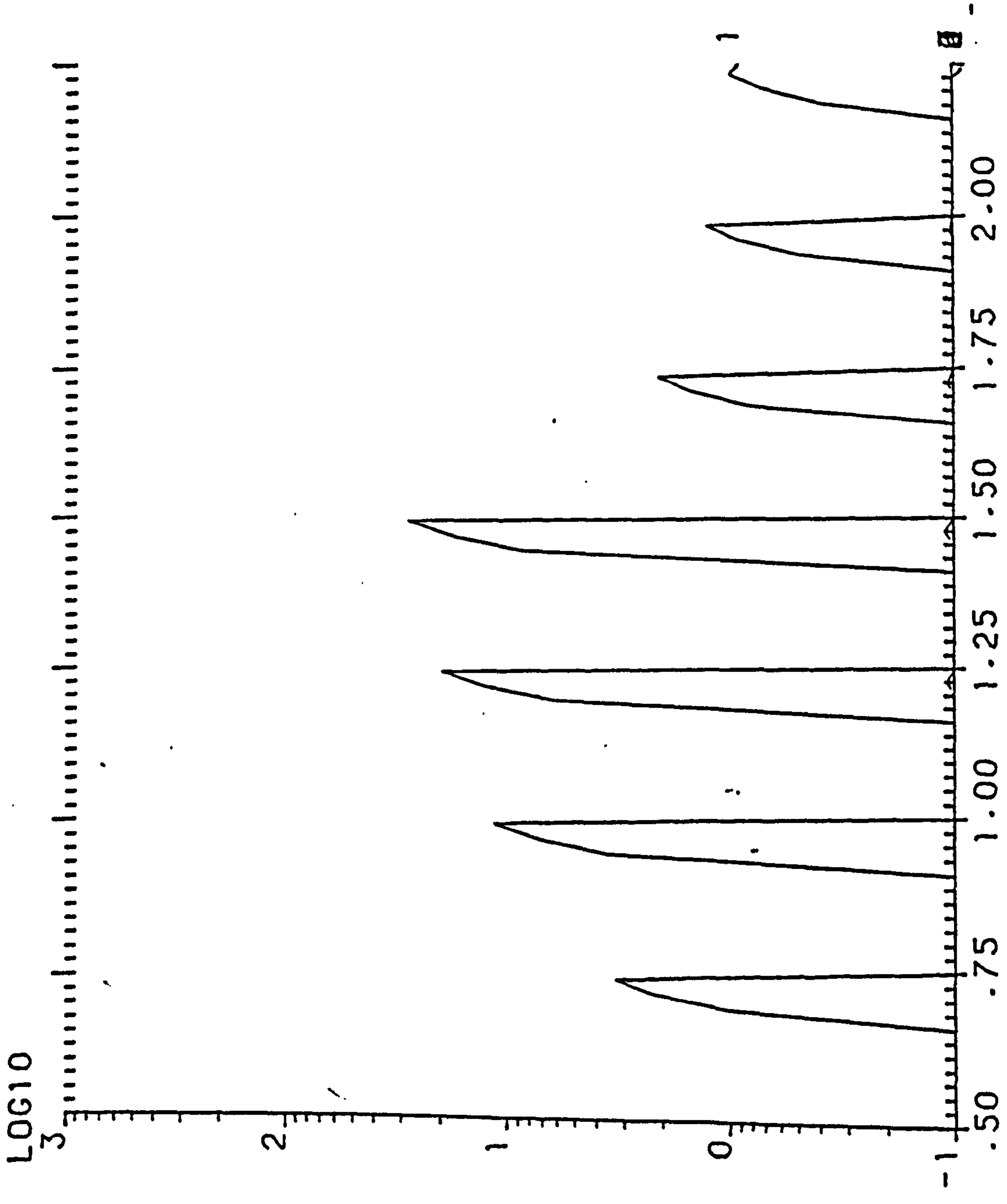

Y. EFFICIENCY W. THICKNESS = .36M W. ORIENTATION=315.00  
WD= 1M HD1= 22M HD2= 6M HOUSE T.=1.5 ST.

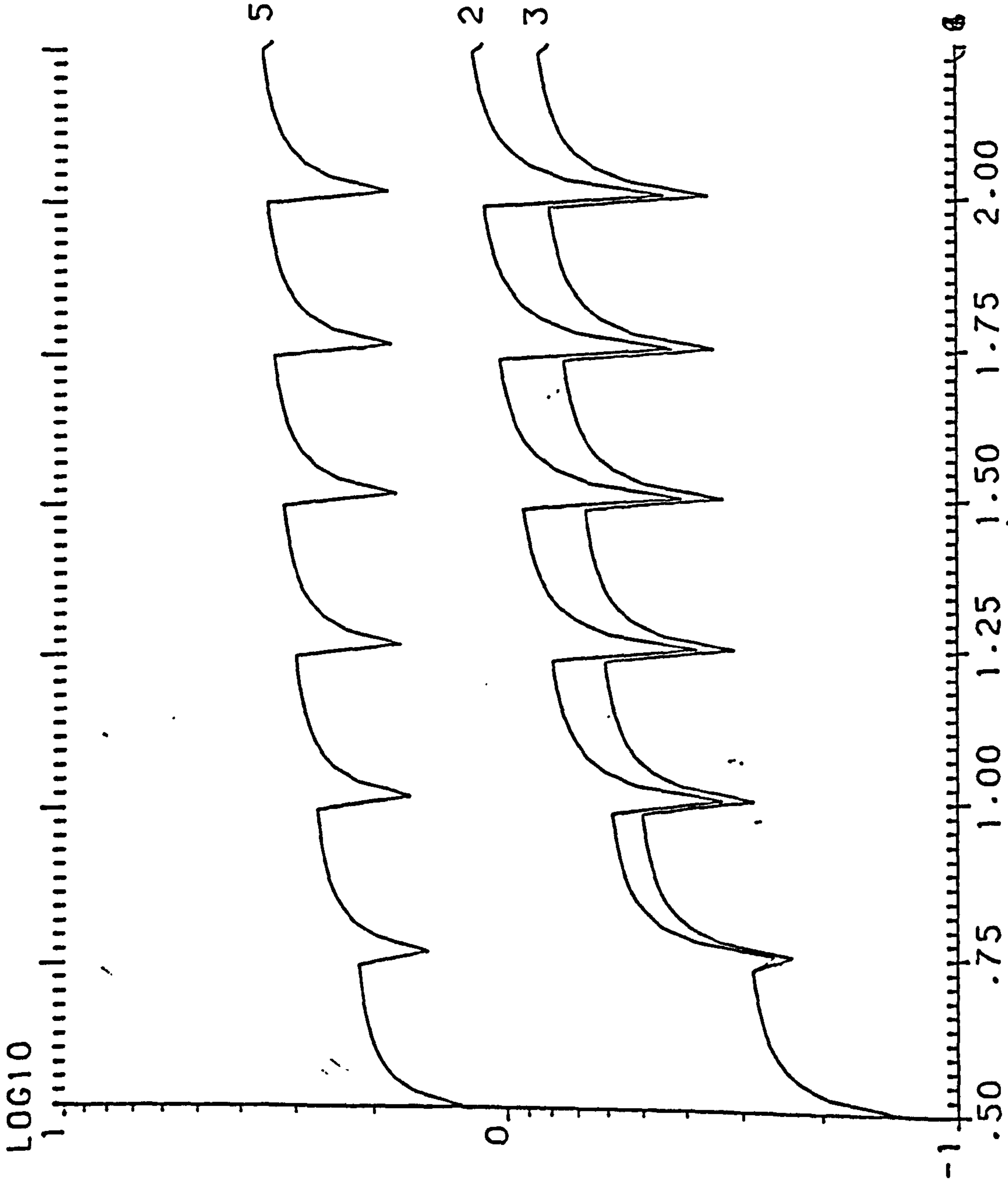

S. EFFICIENCY W. THICKNESS= .36M W. ORIENTATION=315.00

WD= 1M HD1= 22M HD2= 6M HOUSE T.=1.5 ST.



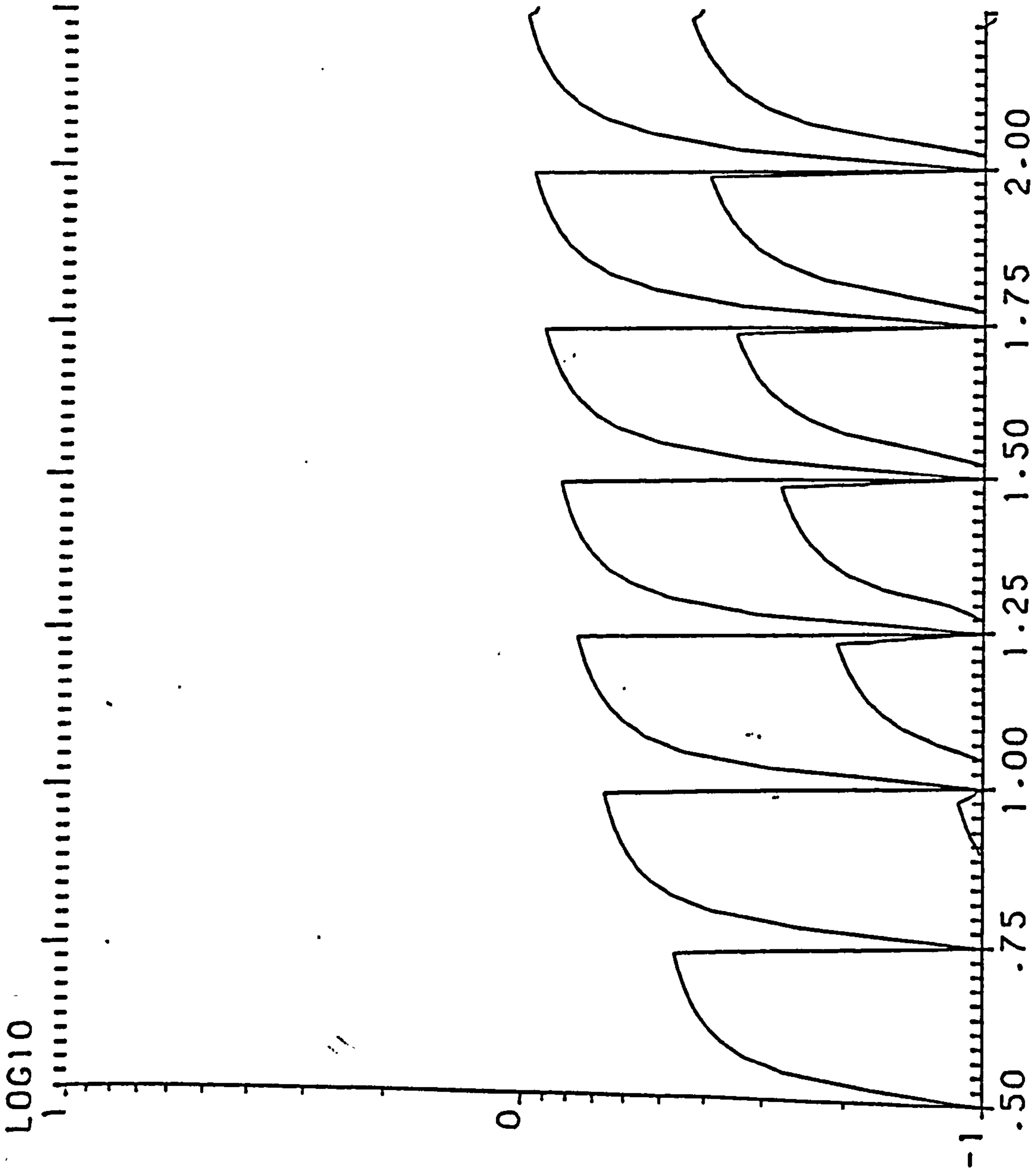

S. EFFICIENCY W. THICKNESS= .36M W. ORIENTATION=337.50

WD= 1M HD1= 22M HD2= 6M HOUSE T.=1.5 ST.



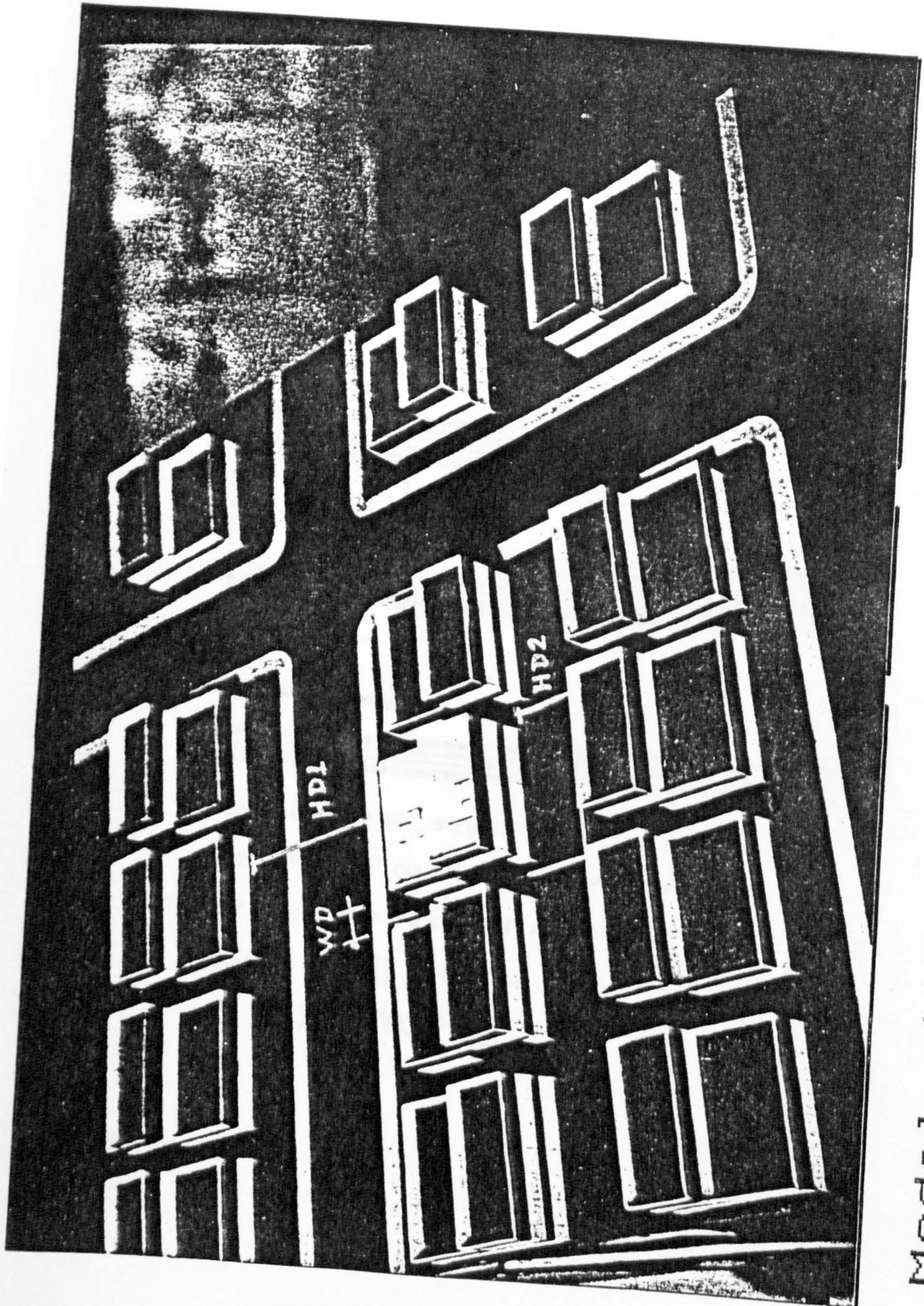

Mode 1 showing interhouse distances





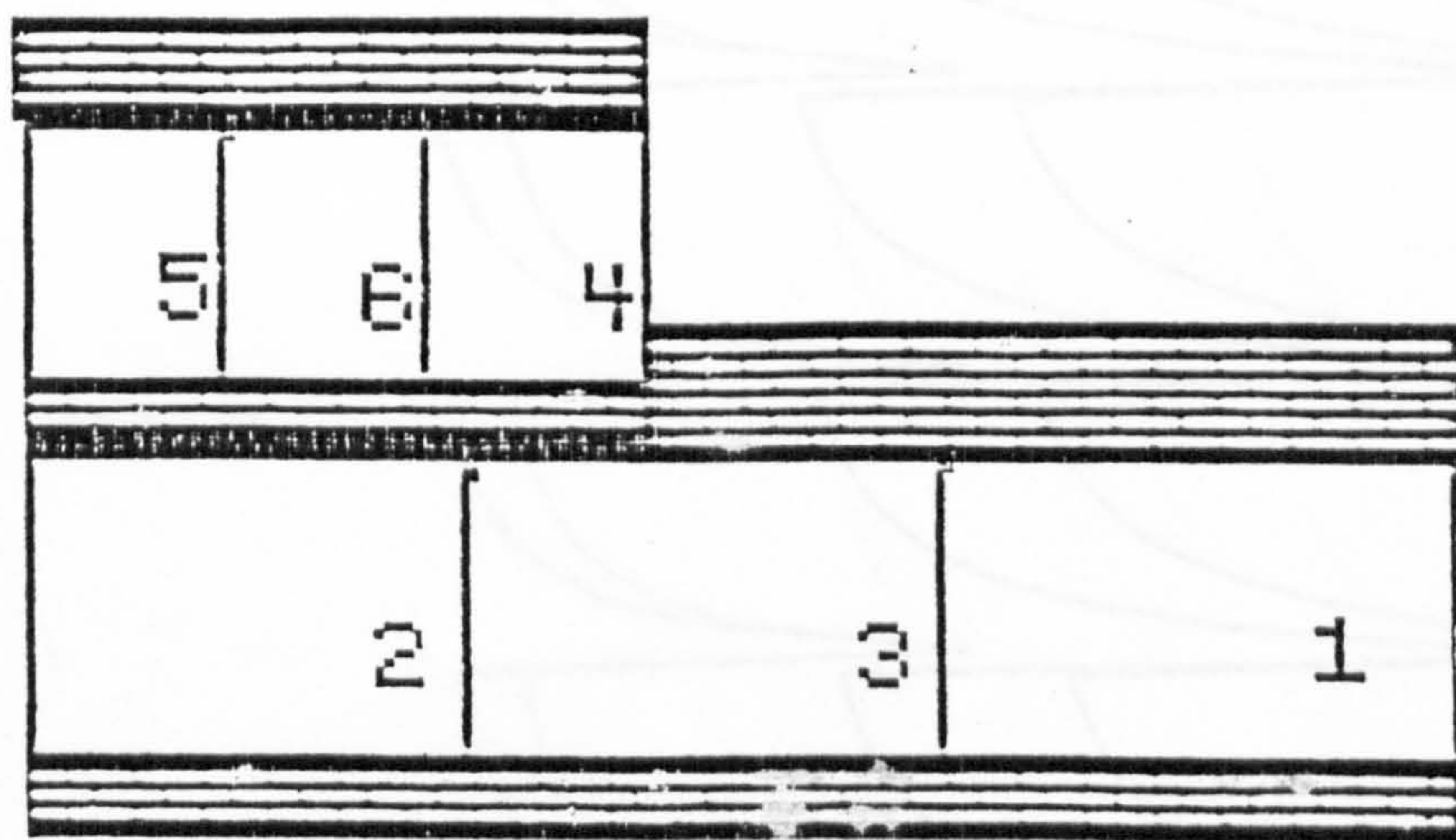

Key diagram showing the location  
of window data and the position  
of the corresponding curve

Side Wall No. 2  
1 1/2 Storey

LOG10  
1  
0  
-1

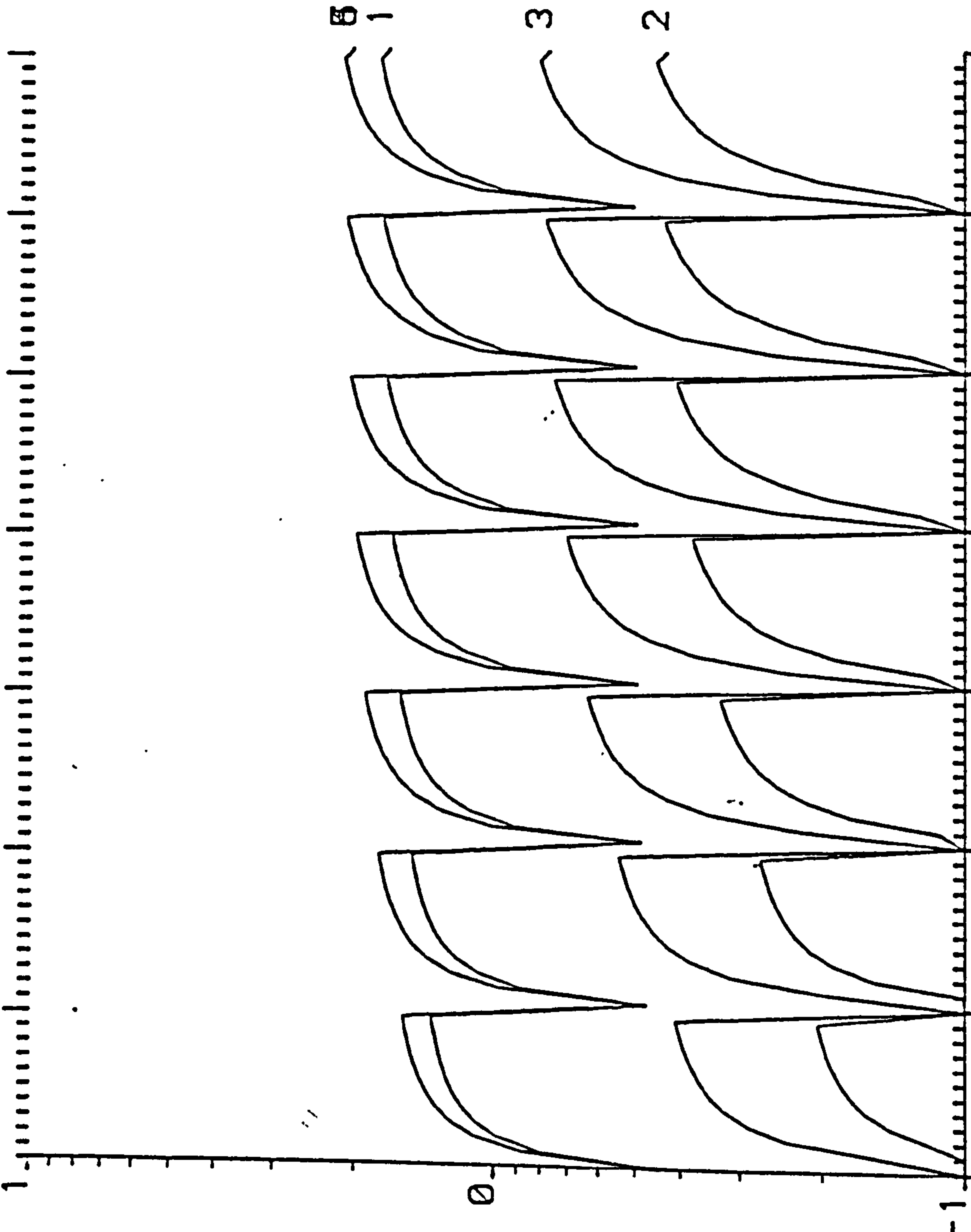

S. EFFICIENCY W. THICKNESS= .12M W. ORIENTATION= .00  
 WD= 2M HD1= 22M HD2= 8M HOUSE T.=1.5 ST.

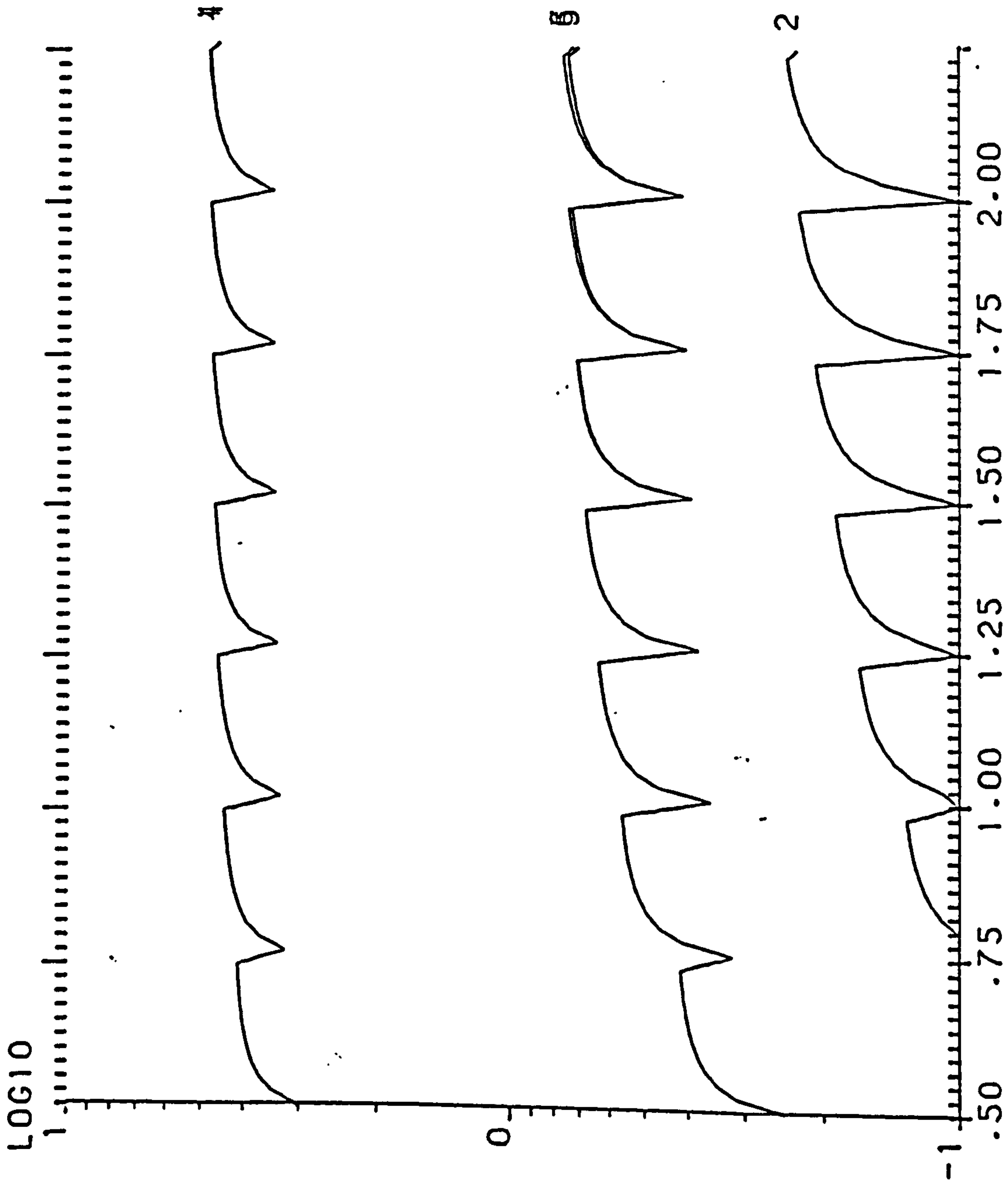

S. EFFICIENCY    W. THICKNESS= .12M    W. ORIENTATION= 22.50  
 WD= 2M    HD1= 22M    HD2= 8M    HOUSE T.=1.5 ST.



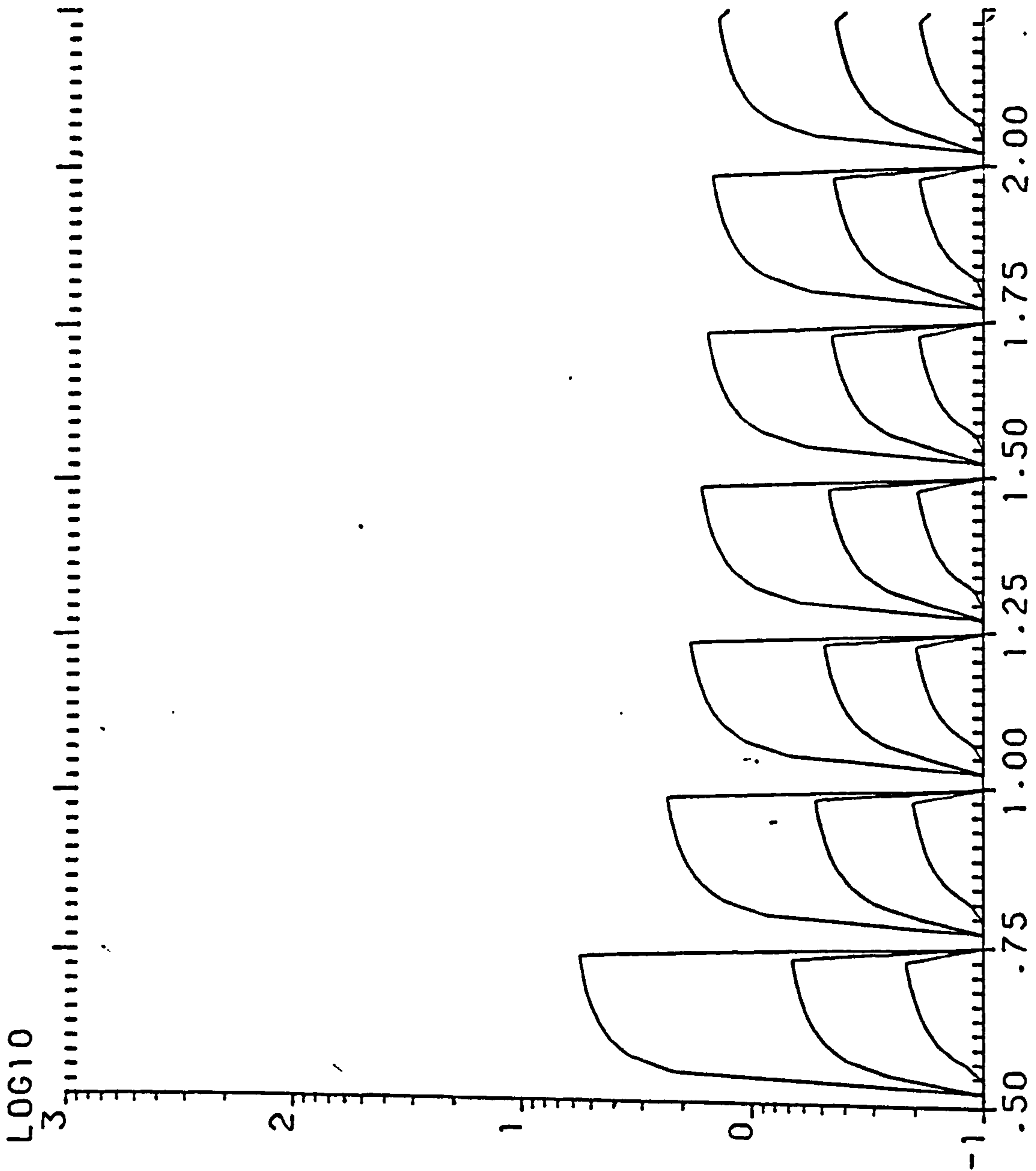

Y. EFFICIENCY W. THICKNESS= .12M W. ORIENTATION= 45.00

WD= 2M HD1= 22M HD2= 8M HOUSE T.=1.5 ST.

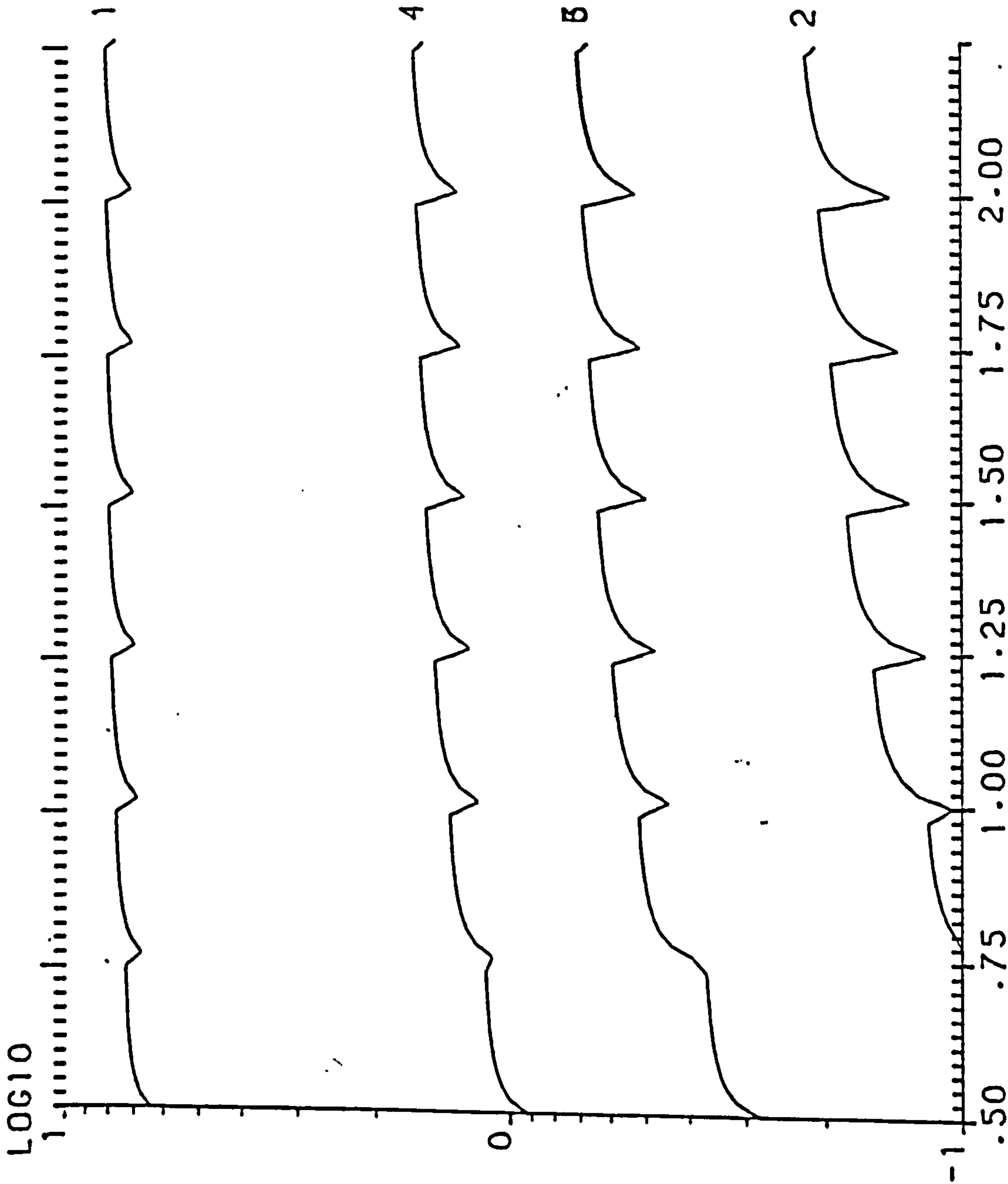

S. EFFICIENCY W. THICKNESS= .12M W. ORIENTATION= 45.00

WD= 2M HD1= 22M HD2= 8M HOUSE T.=1.5 ST.

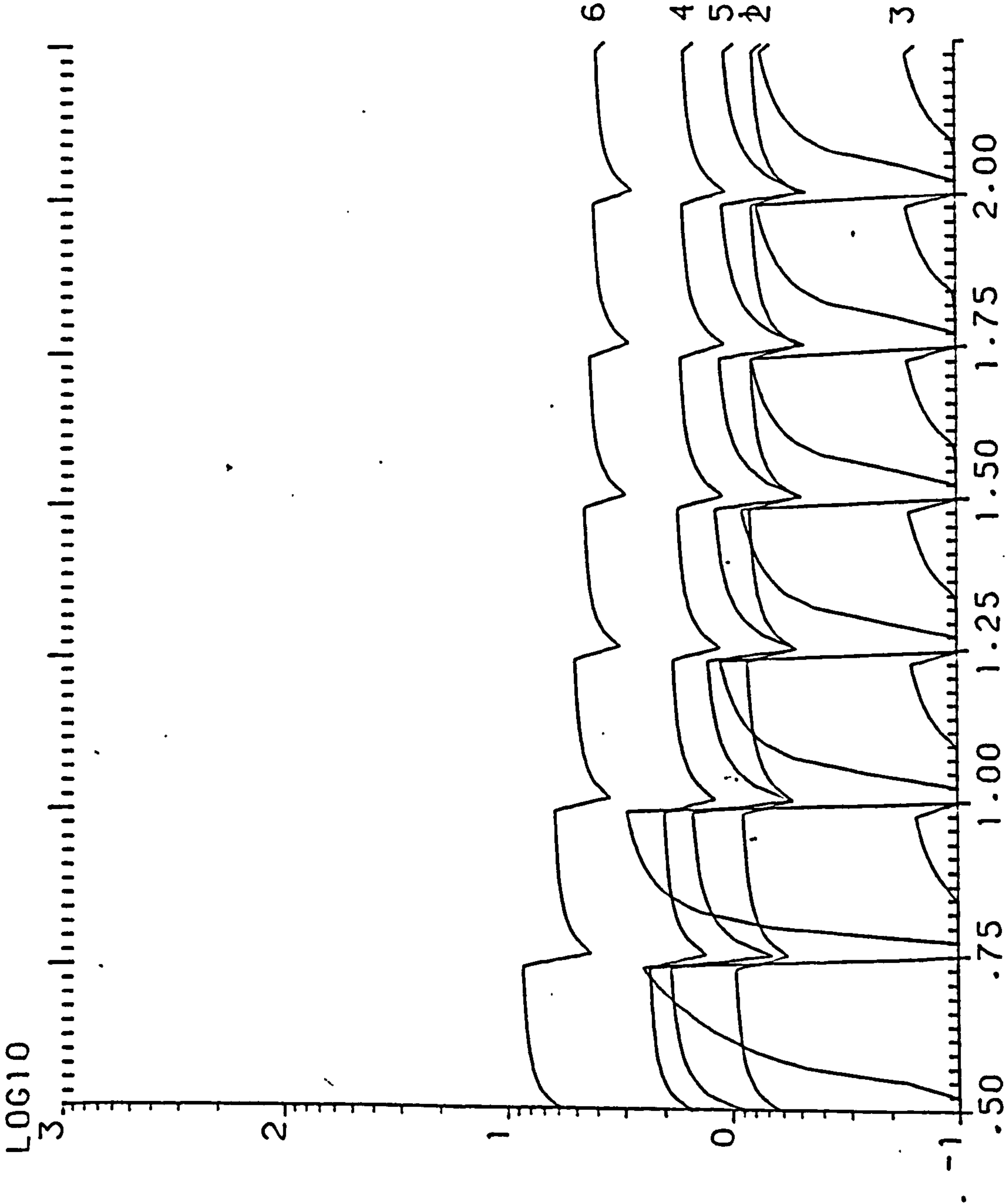

Y. EFFICIENCY W. THICKNESS= .12M W. ORIENTATION= 67.50

WD= 2M HD1= 22M HD2= 8M HOUSE T.=1.5 ST.

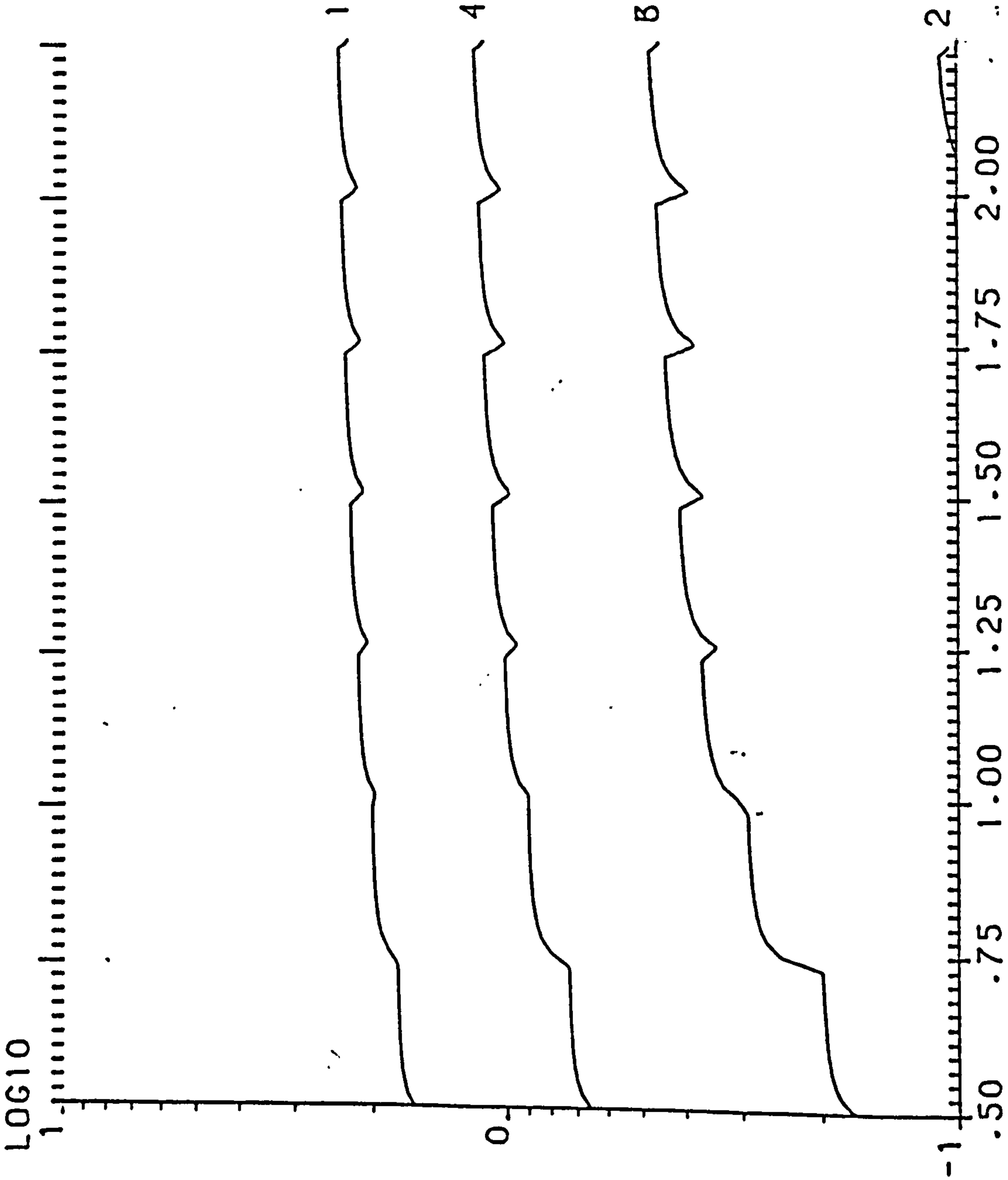

S. EFFICIENCY W. THICKNESS= .12M W. ORIENTATION= 67.50

WD= 2M HD1= 22M HD2= 8M HOUSE T.=1.5 ST.



LOG10  
3  
2  
1  
0  
-1

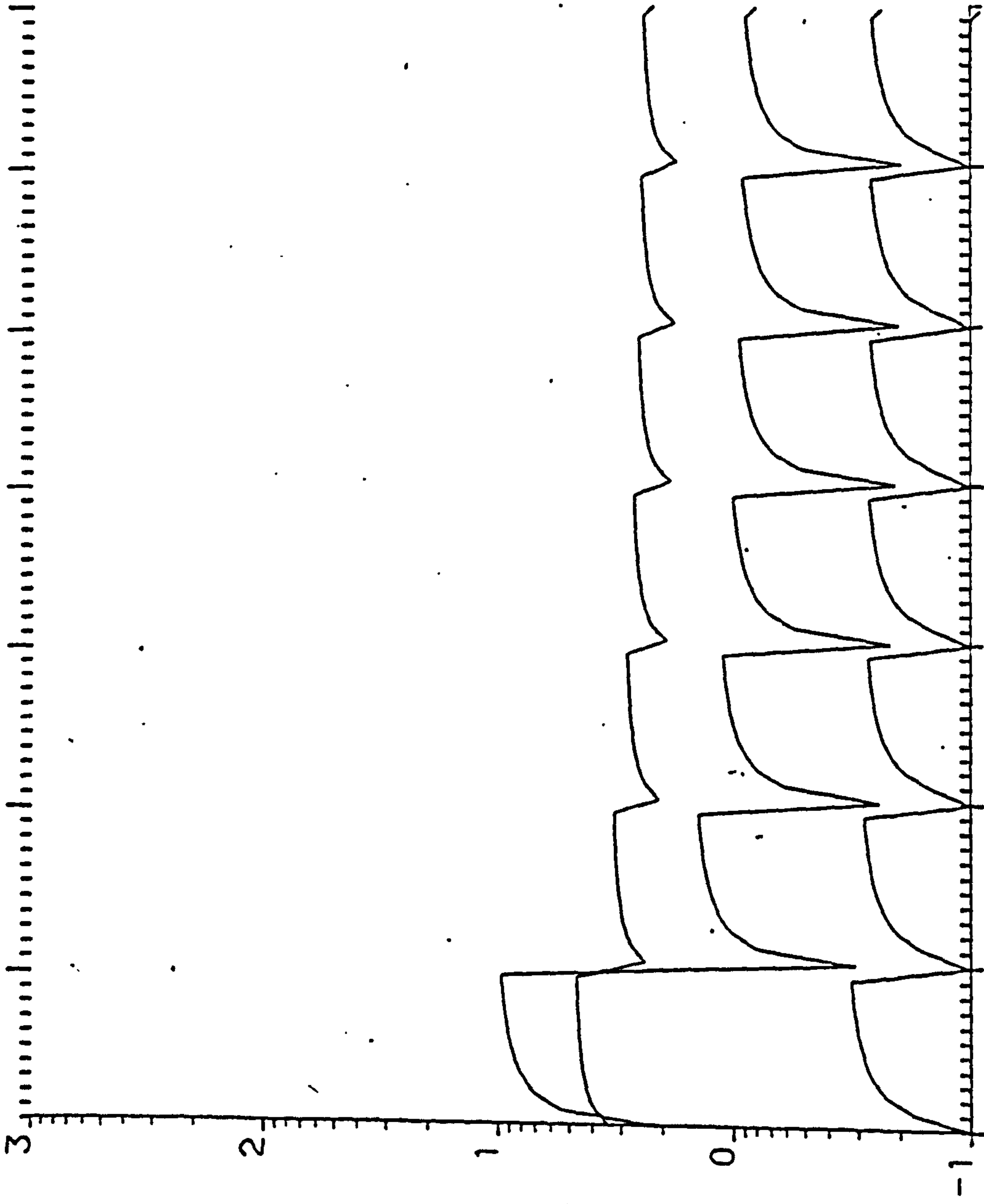

Y. EFFICIENCY W. THICKNESS= .12M W. ORIENTATION= 90.00

WD= 2M HD1= 22M HD2= 8M HOUSE T.=1.5 ST.

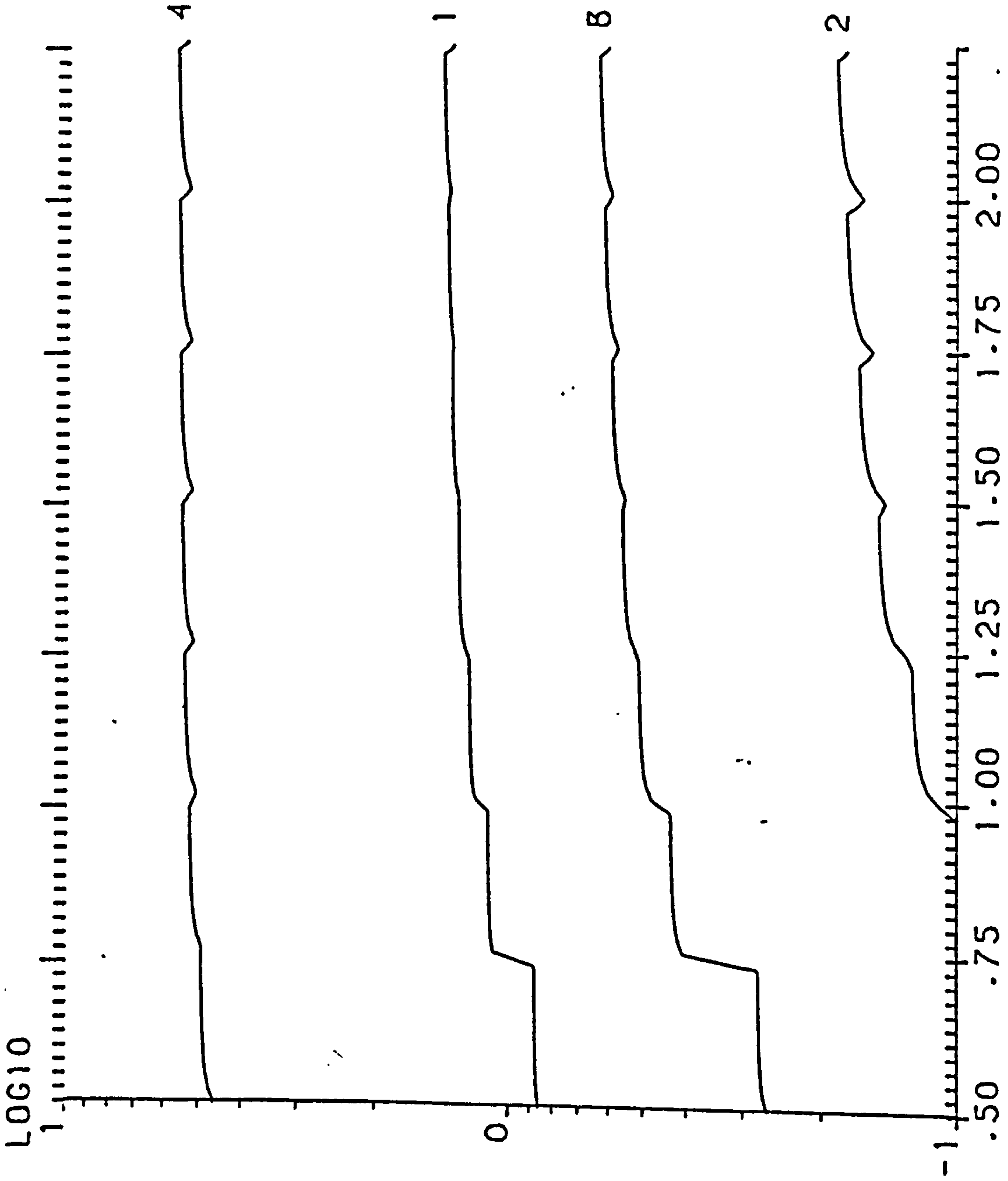

S. EFFICIENCY W. THICKNESS= .12M W. ORIENTATION= 90.00

WD= 2M HD1= 22M HD2= 8M HOUSE T.=1.5 ST.

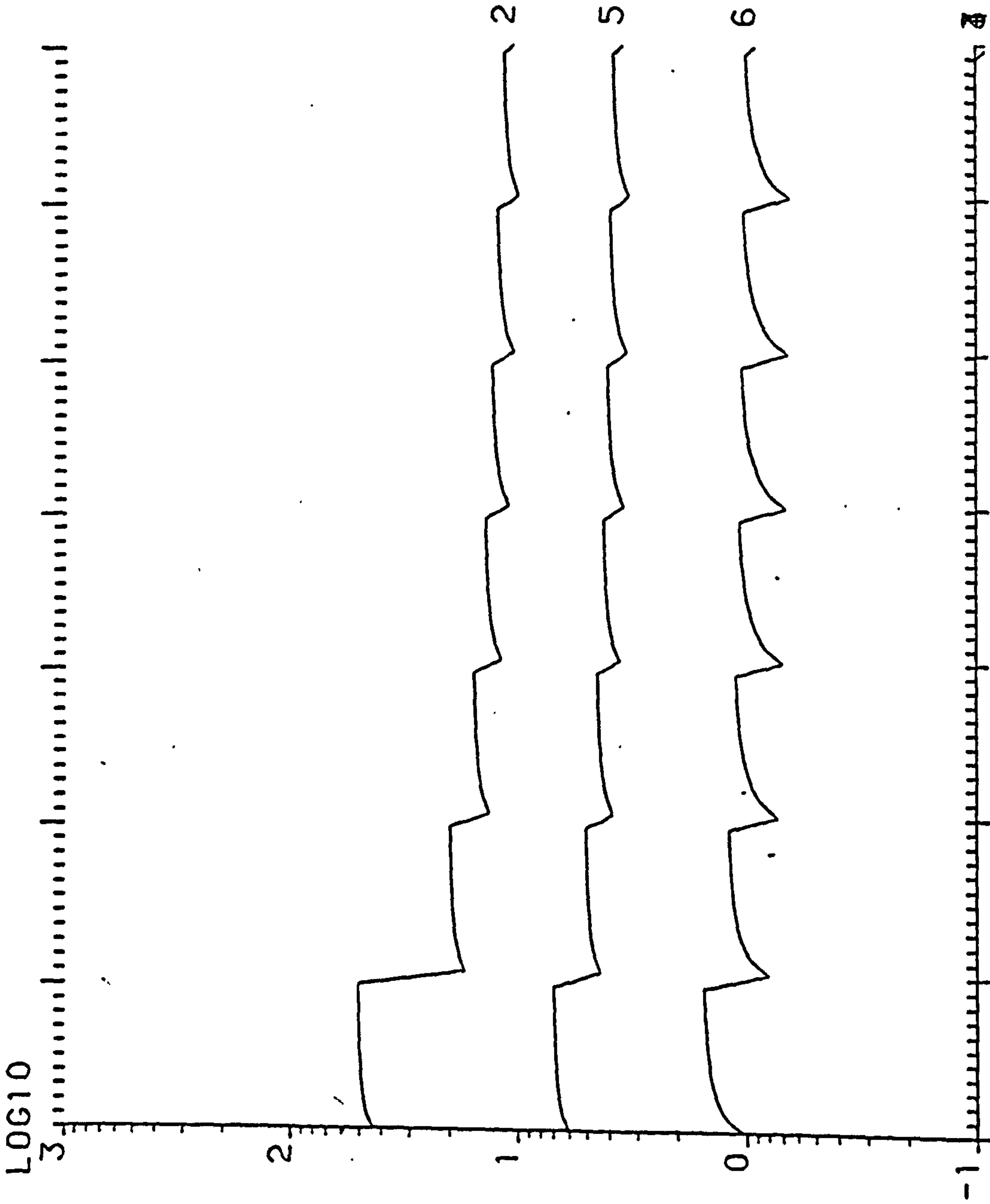

Y. EFFICIENCY W. THICKNESS= .12M W. ORIENTATION=112.50

WD= 2M HD1= 22M HD2= 8M HOUSE T.=1.5 ST.

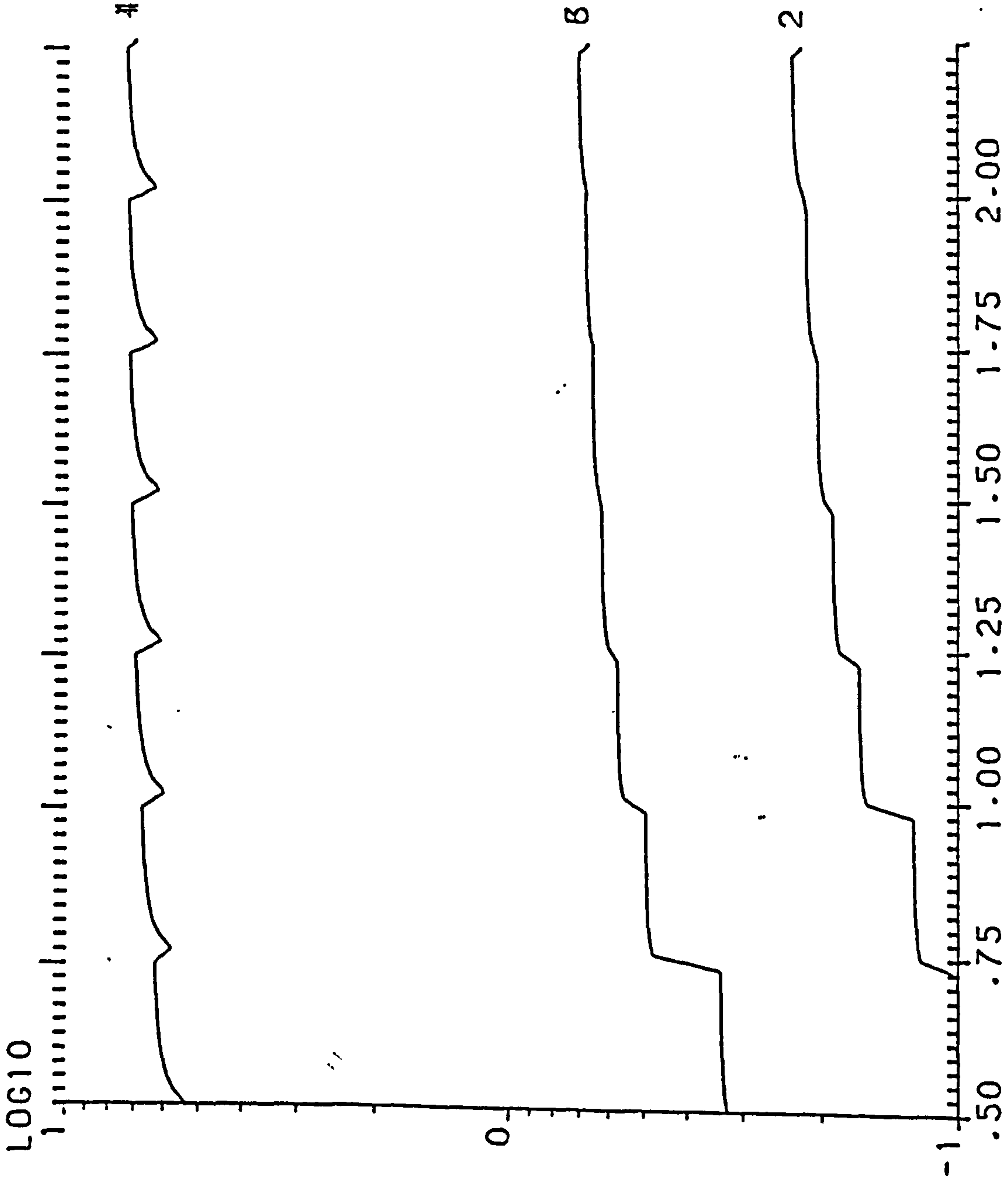

S. EFFICIENCY W. THICKNESS= .12M W. ORIENTATION=112.50

WD= 2M HD1= 22M HD2= 8M HOUSE T.=1.5 ST.



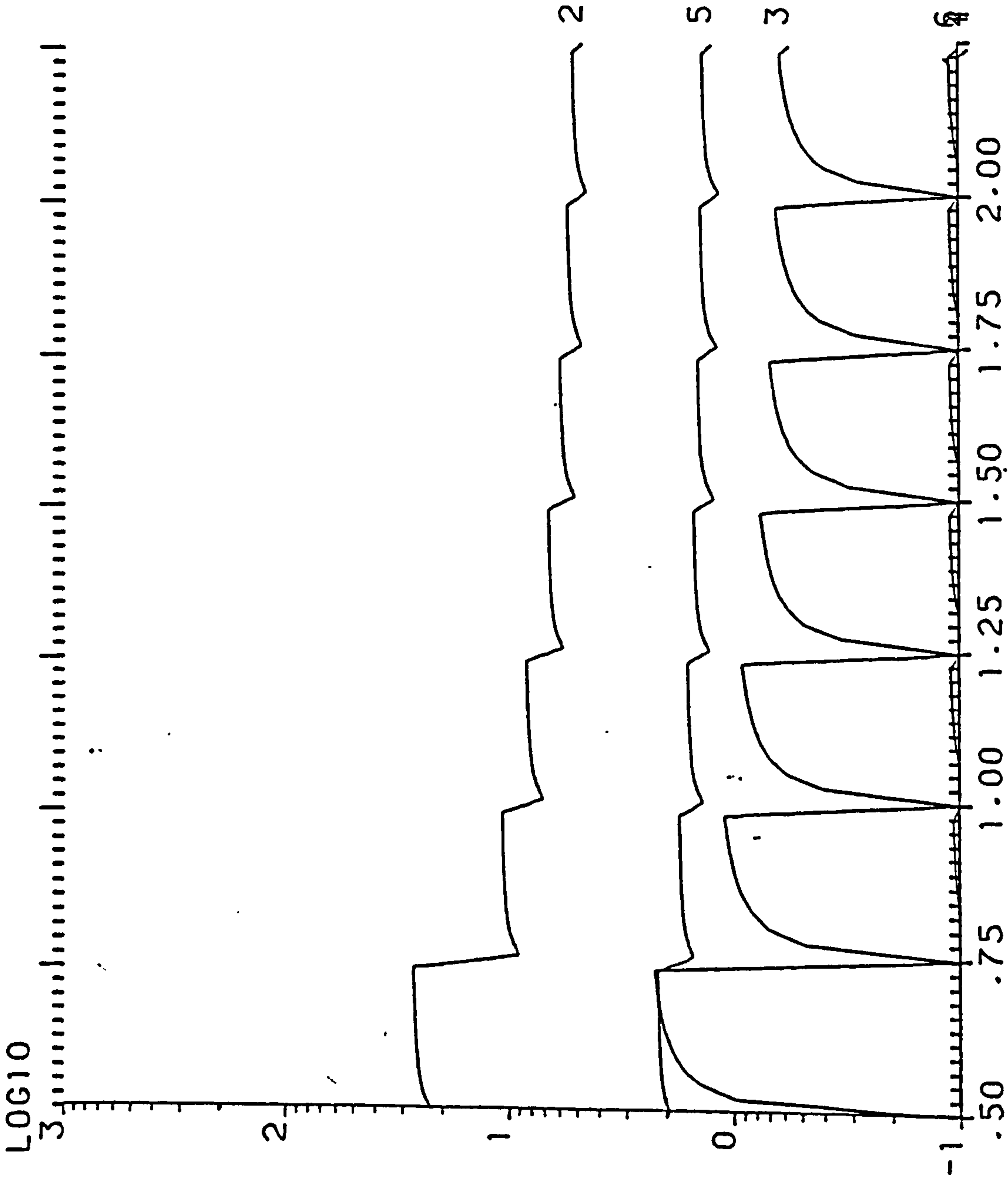

Y. EFFICIENCY W. THICKNESS= .12M W. ORIENTATION=135.00

WD= 2M HD1= 22M HD2= 8M HOUSE T.=1.5 ST.

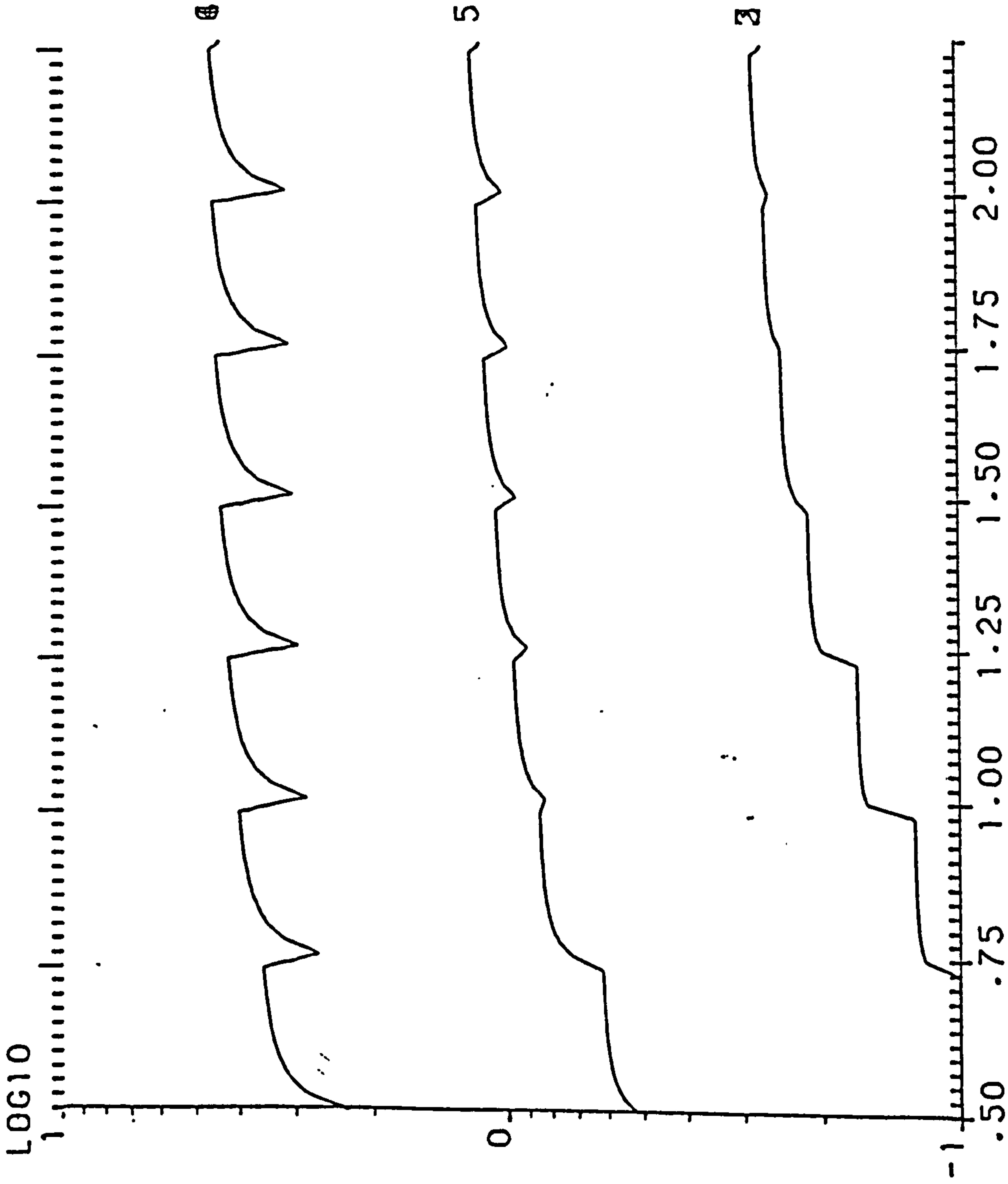

S. EFFICIENCY W. THICKNESS= .12M HD2= 8M HOUSE T.=1.5 ST.  
 W. ORIENTATION=135.00

WD= 2M HD1= 22M

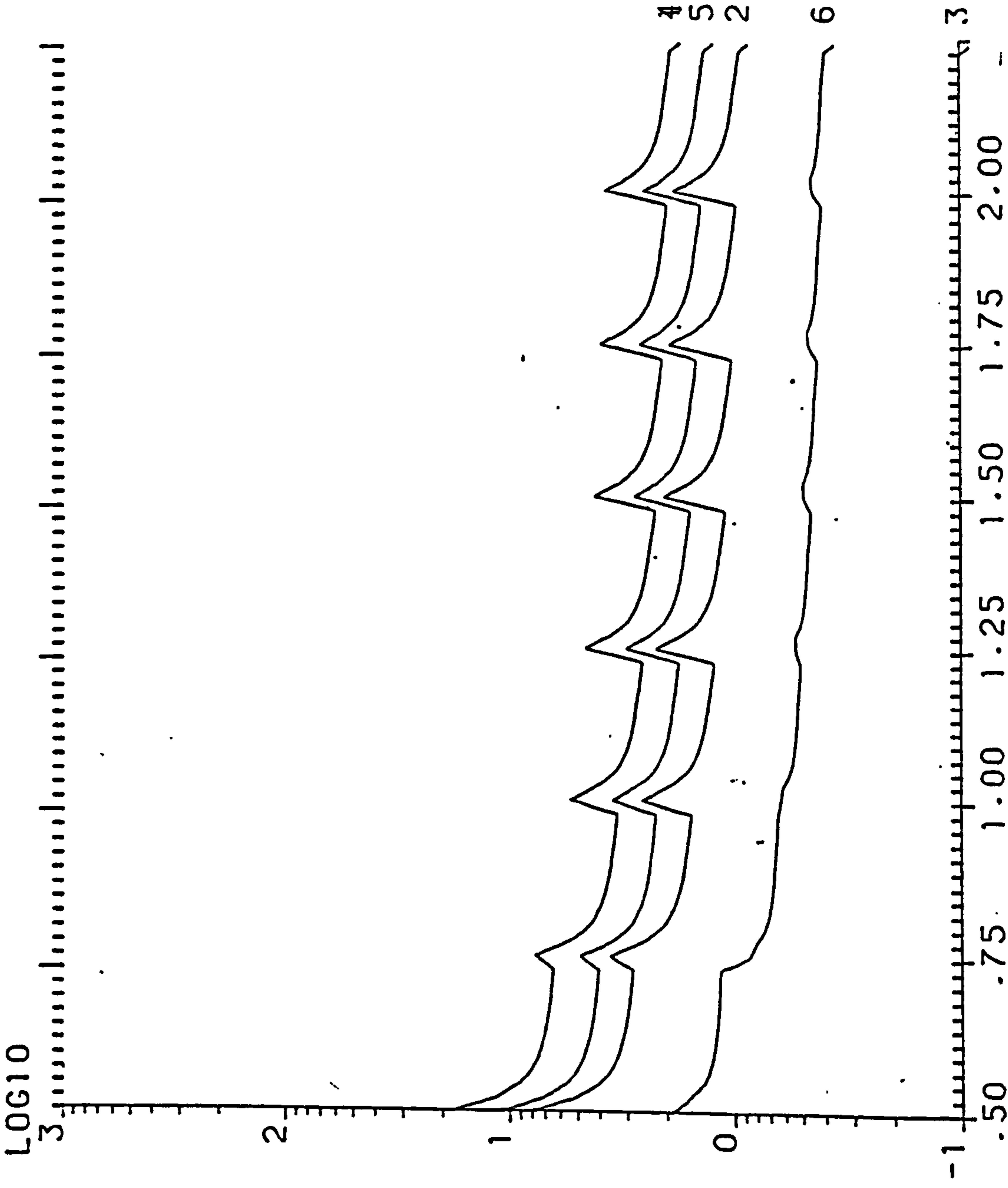

Y. EFFICIENCY W. THICKNESS= .12M W. ORIENTATION=157.50  
WD= 2M HD1= 22M HD2= 8M HOUSE T.=1.5 ST.

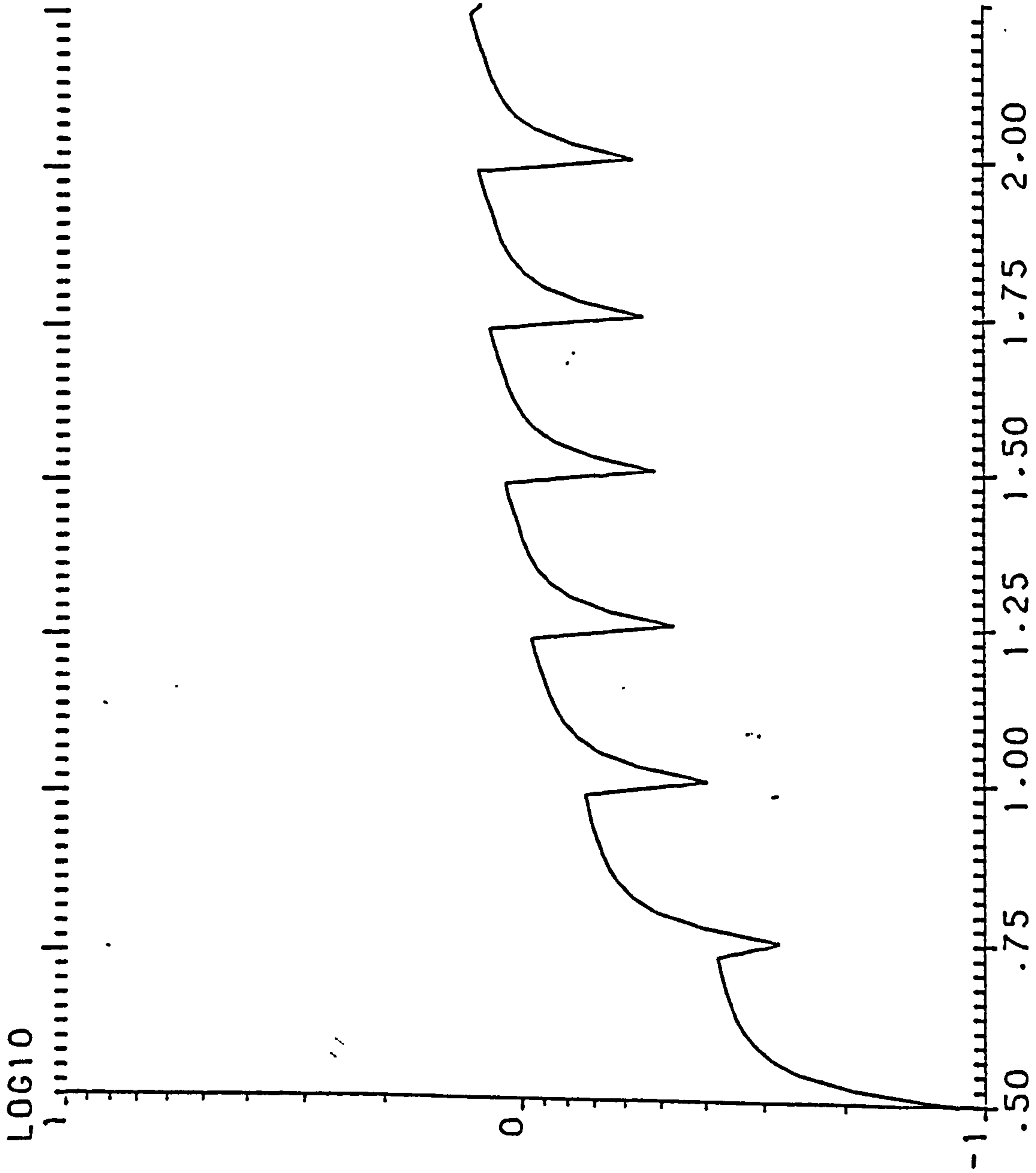

S. EFFICIENCY W. THICKNESS= .12M W. ORIENTATION=157.50  
 WD= 2M HD1= 22M HD2= 8M HOUSE T.=1.5 ST.



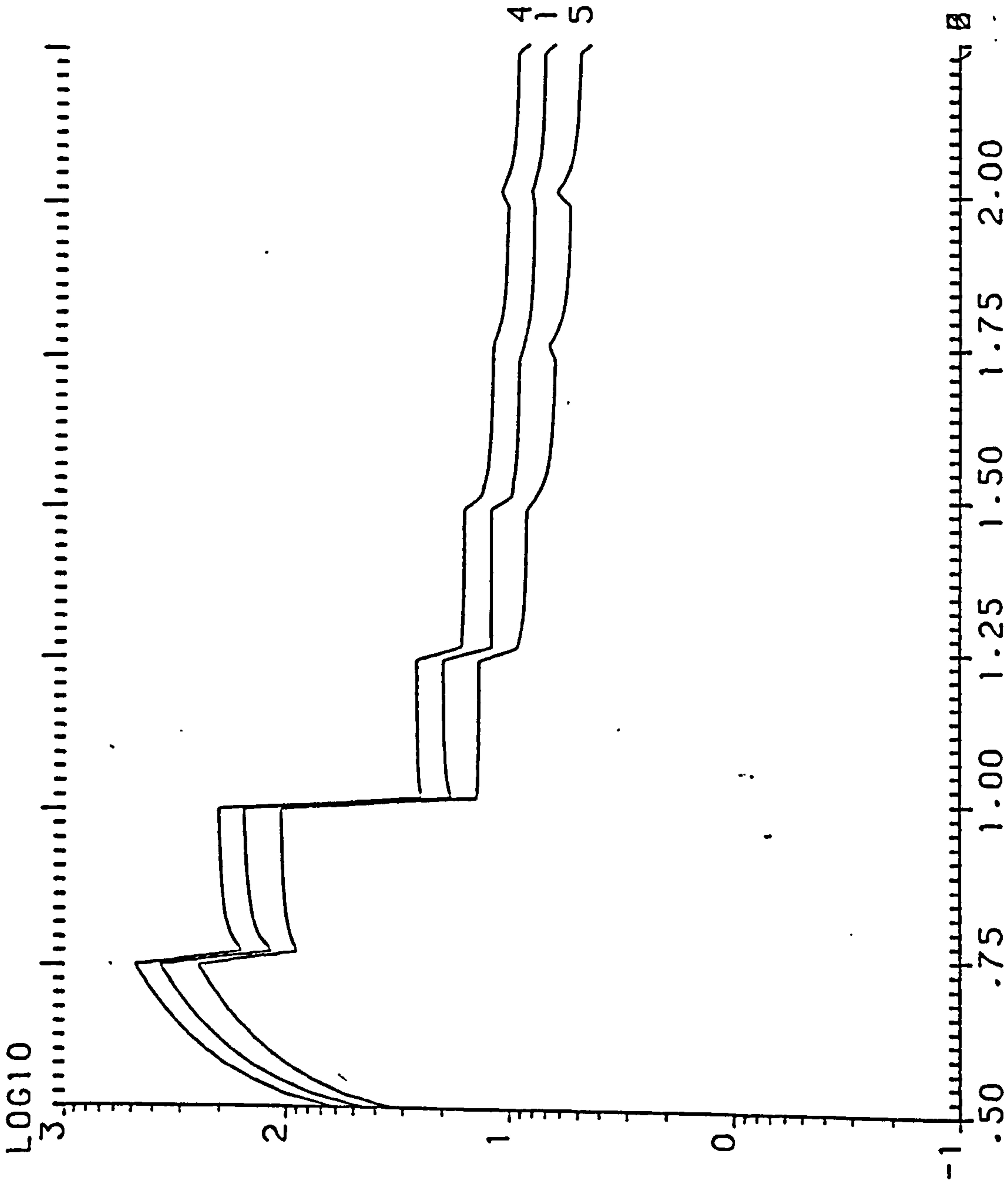

Y. EFFICIENCY W. THICKNESS= .12M W. ORIENTATION=180.00

WD= 2M HD1= 22M HD2= 8M HOUSE T.=1.5 ST.





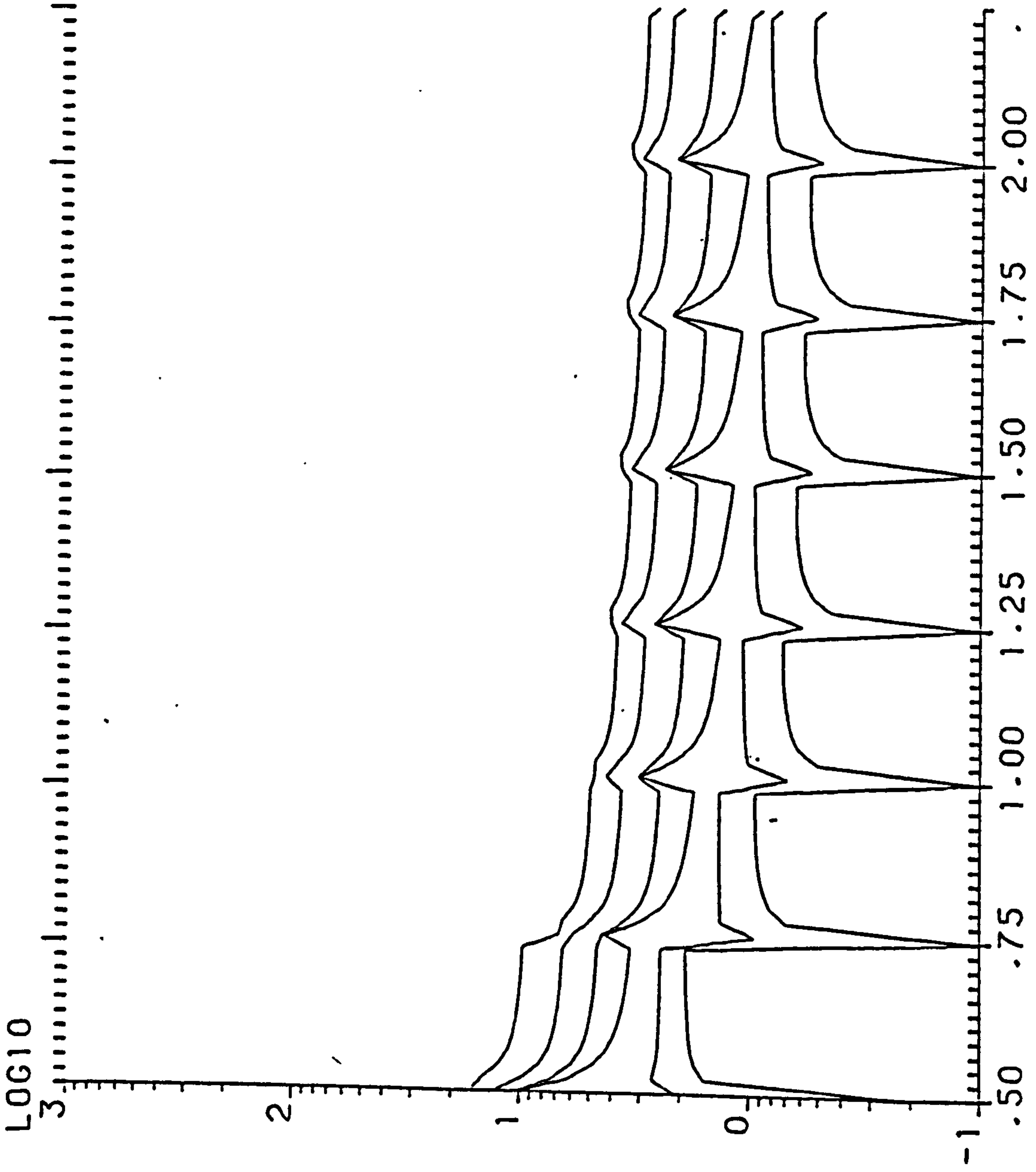

Y. EFFICIENCY W. THICKNESS= .12M W. ORIENTATION=202.50

WD= 2M HD1= 22M HD2= 8M HOUSE T.=1.5 ST.

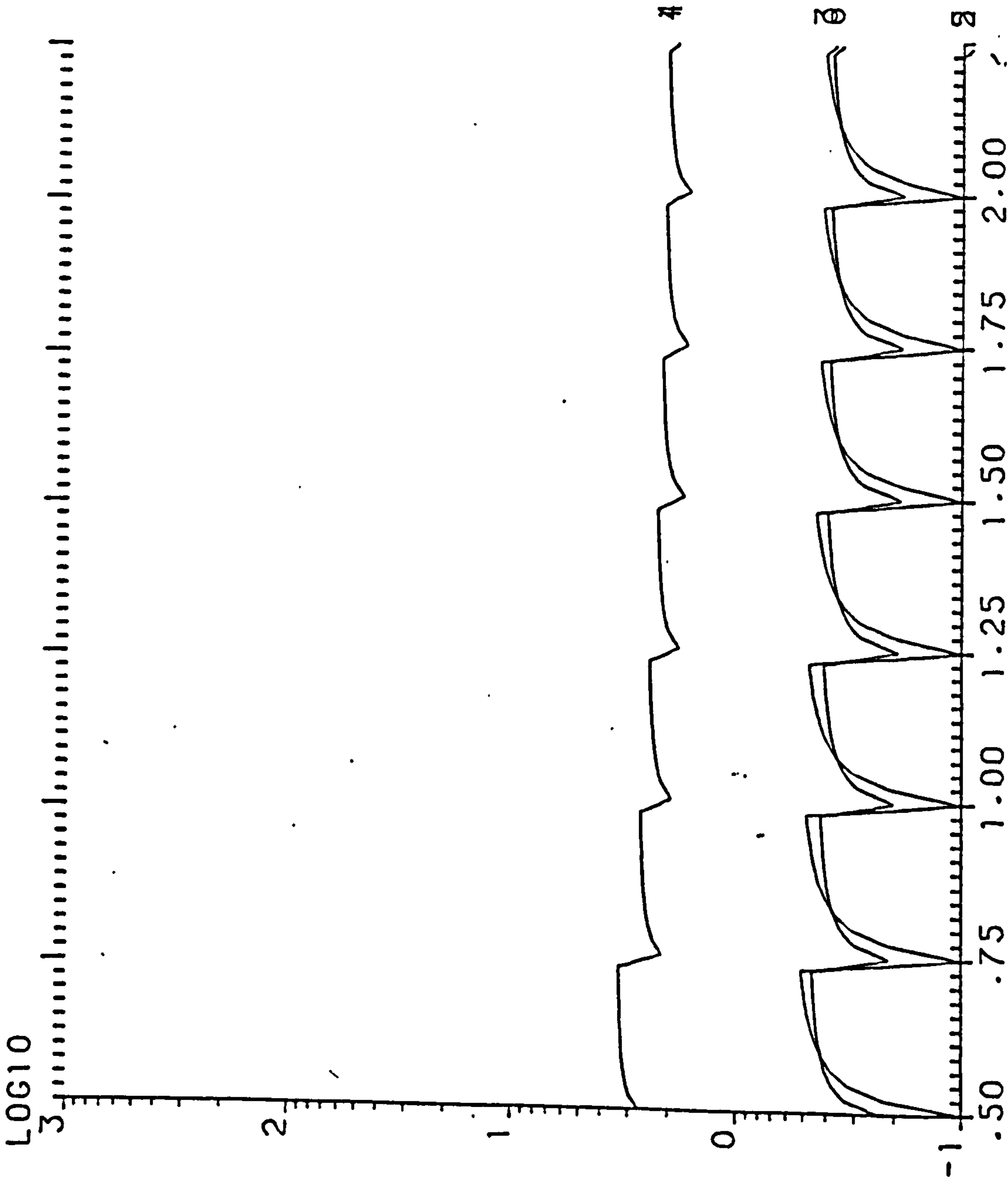

Y. EFFICIENCY W. THICKNESS= .12M W. ORIENTATION=225.00

WD= 2M HD1= 22M HD2= 8M HOUSE T.=1.5 ST.

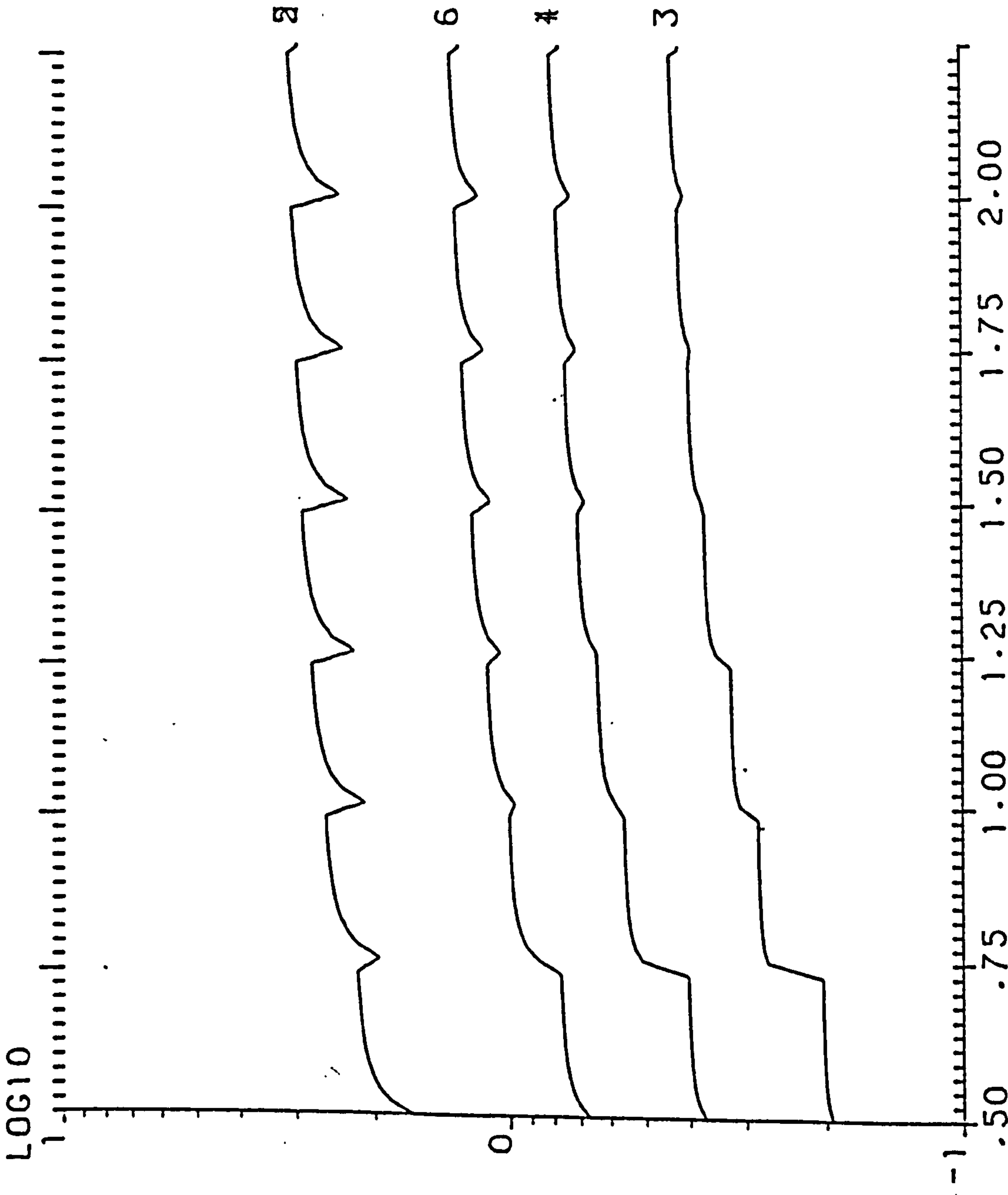

S. EFFICIENCY W. THICKNESS= .12M HD2= 8M HOUSE T.=1.5 ST.  
 W. ORIENTATION=225.00

WD= 2M HD1= 22M



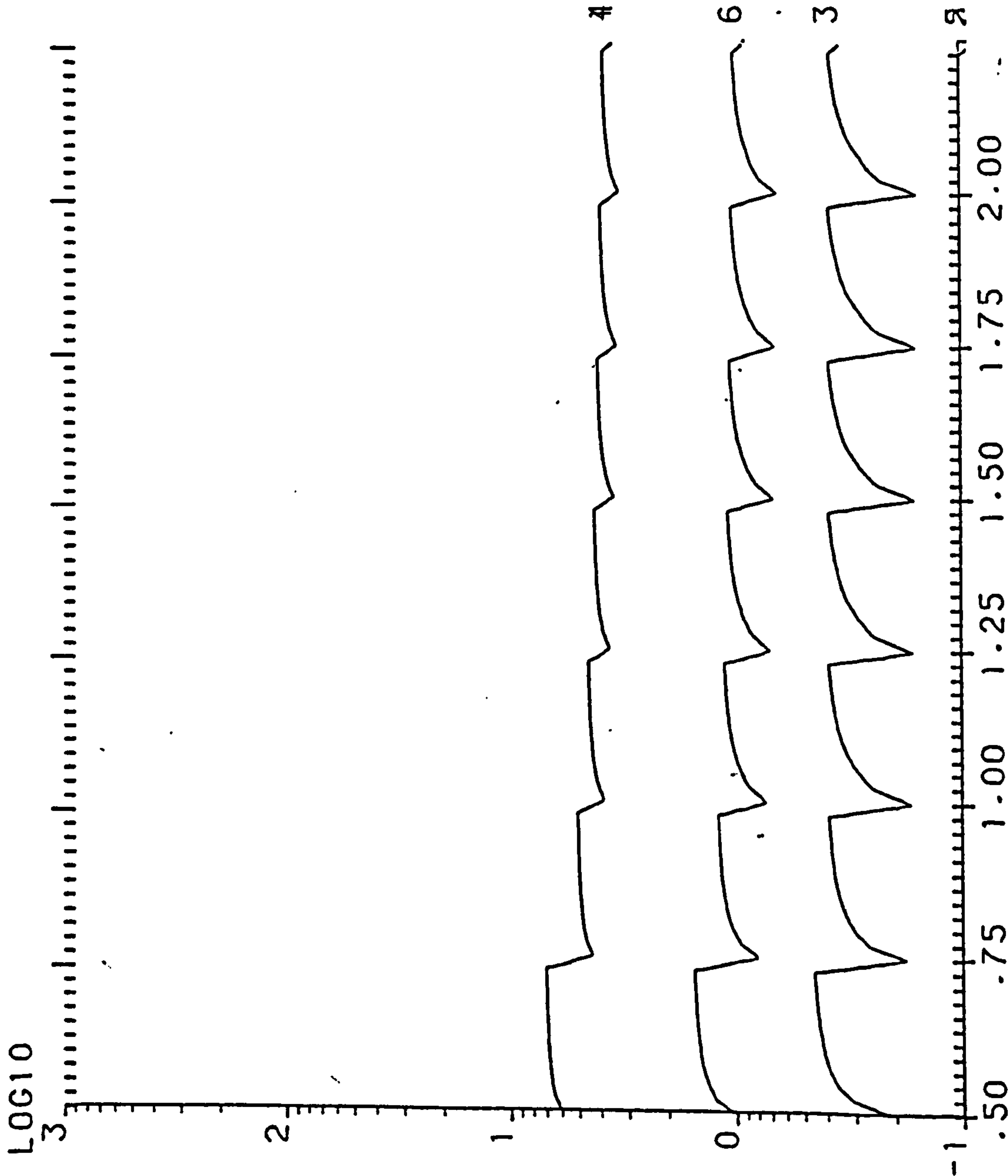

Y. EFFICIENCY    W. THICKNESS=    .12M    W. ORIENTATION=247.50  
WD= 2M    HD1= 22M    HD2= 8M    HOUSE T.=1.5 ST.



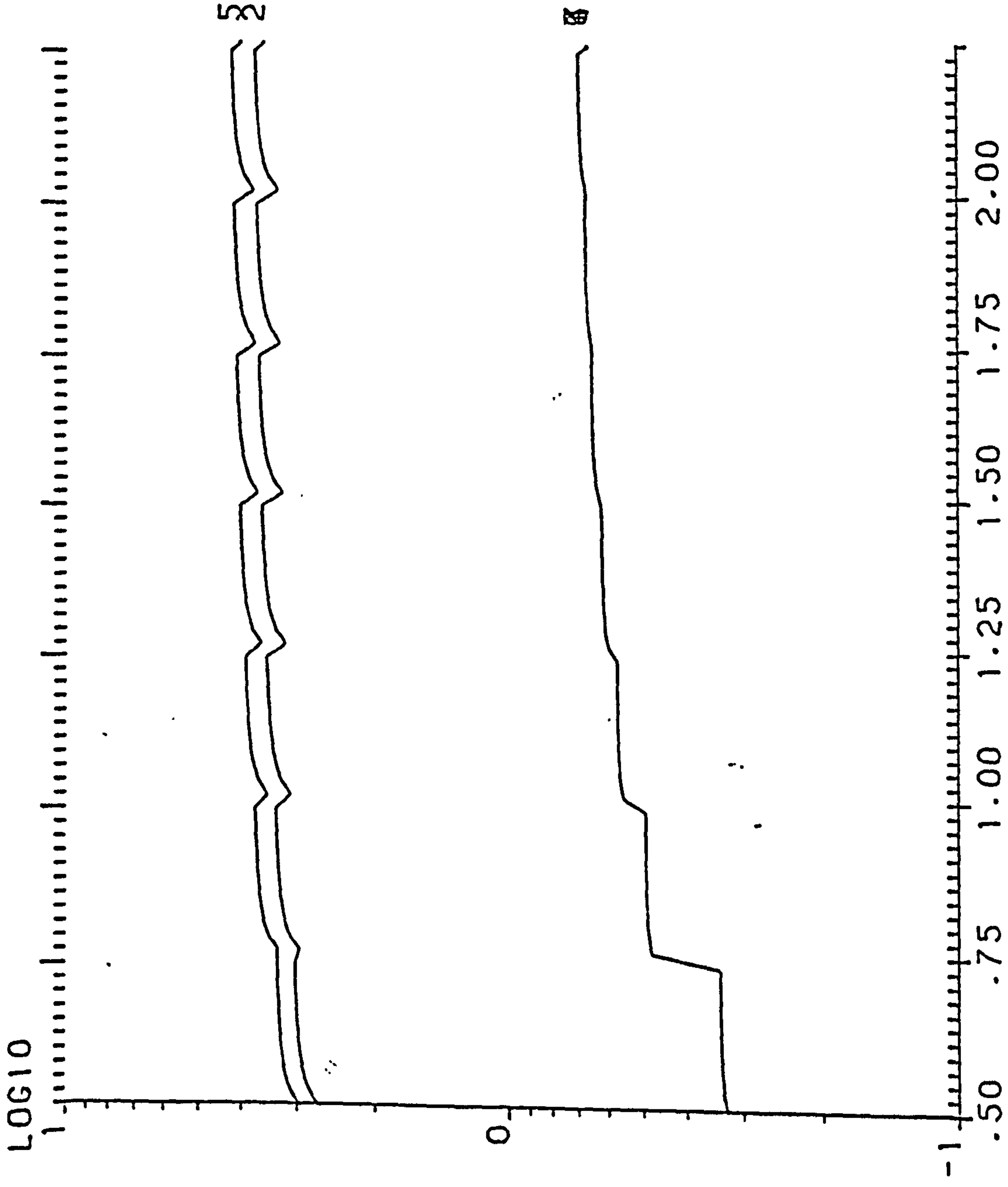

S. EFFICIENCY W. THICKNESS= .12M W. ORIENTATION=247.50

WD= 2M HD1= 22M HD2= 8M HOUSE T.=1.5 ST.

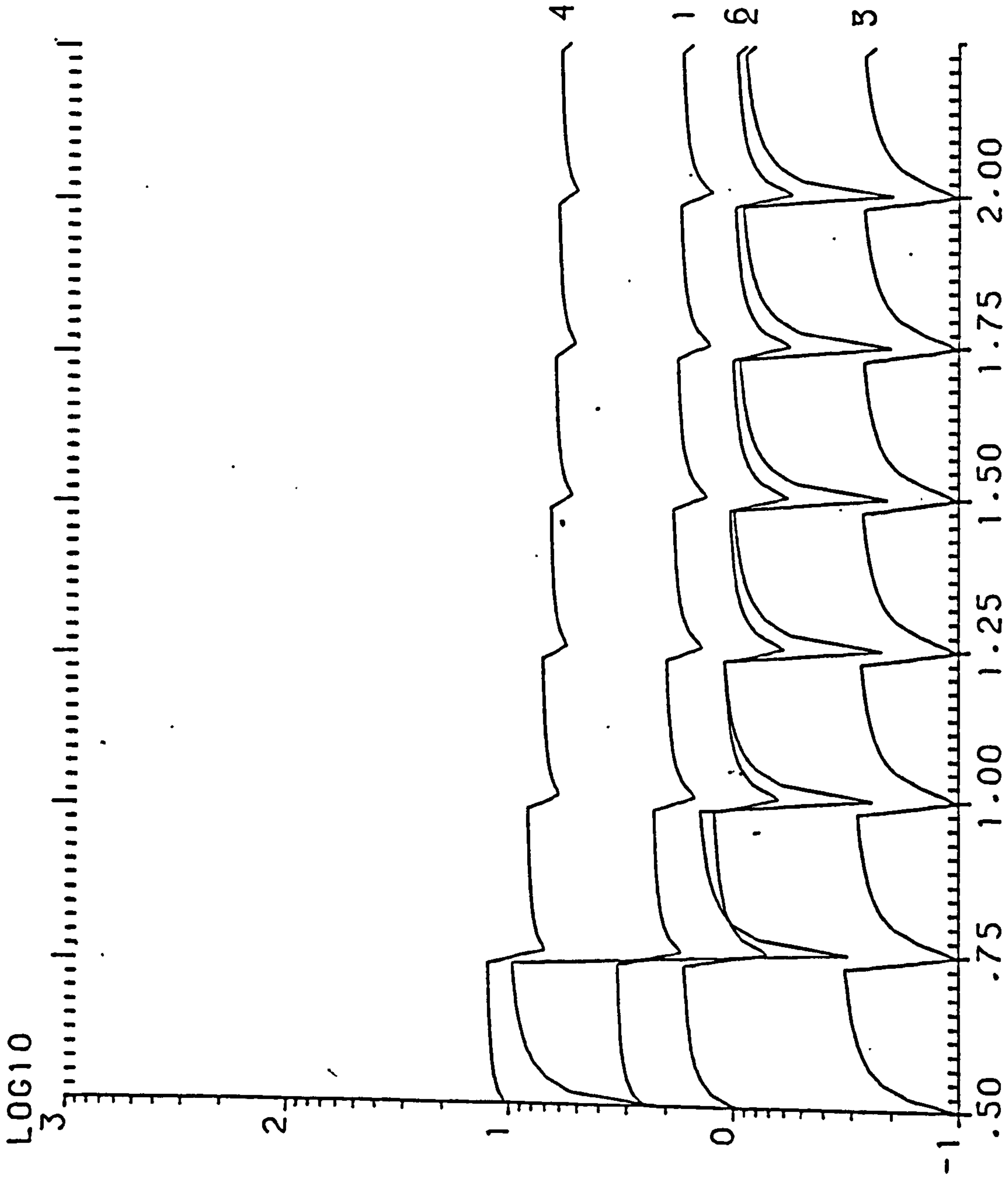

Y. EFFICIENCY W. THICKNESS= .12M W. ORIENTATION=270.00

WD= 2M HD1= 22M HD2= 8M HOUSE T.=1.5 ST.

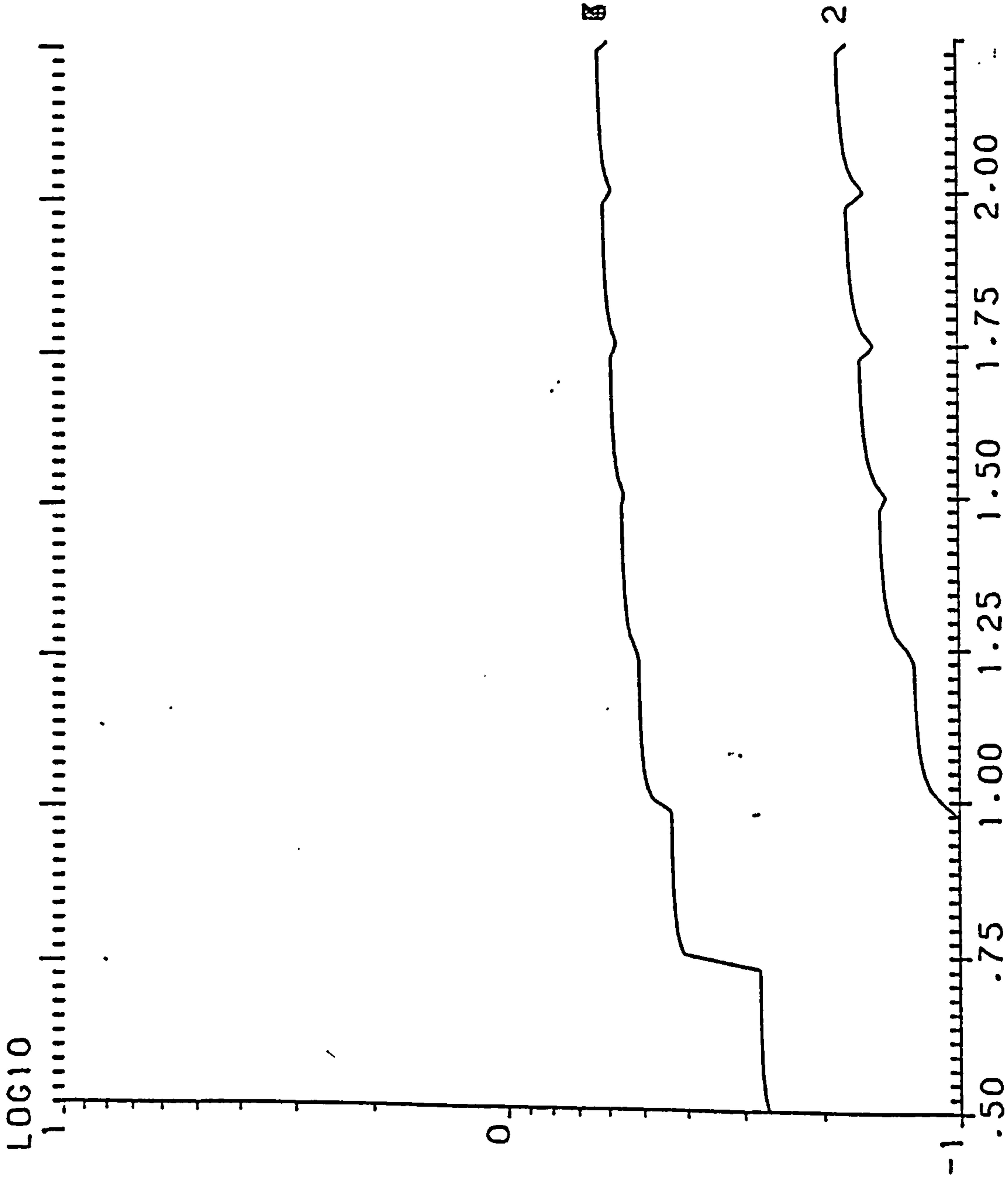

S. EFFICIENCY W. THICKNESS= .12M W. ORIENTATION=270.00

WD= 2M HD1= 22M HD2= 8M HOUSE T.=1.5 ST.



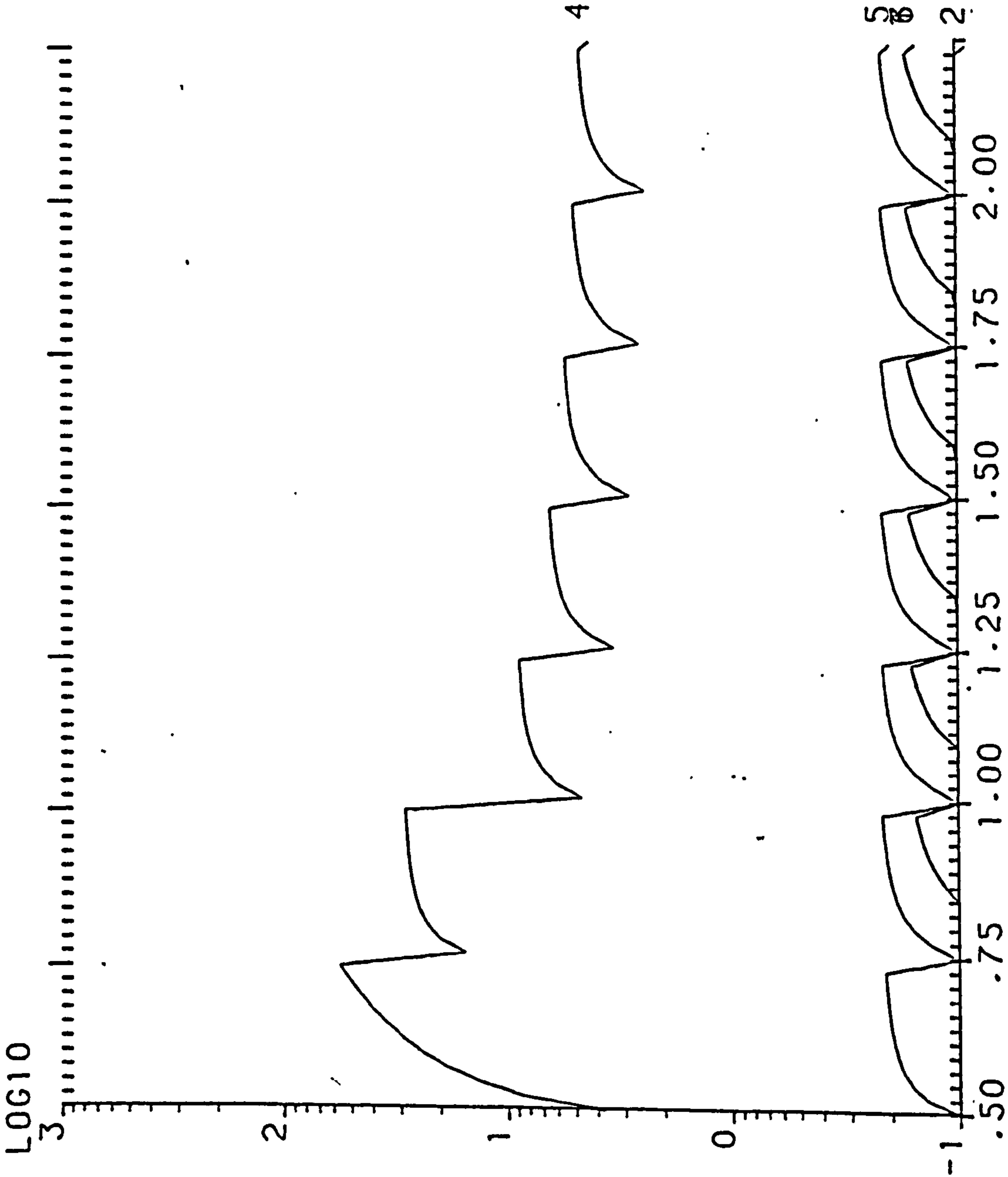

Y. EFFICIENCY W. THICKNESS= .12M W. ORIENTATION=292.50  
 WD= 2M HD1= 22M HD2= 8M HOUSE T.=1.5 ST.

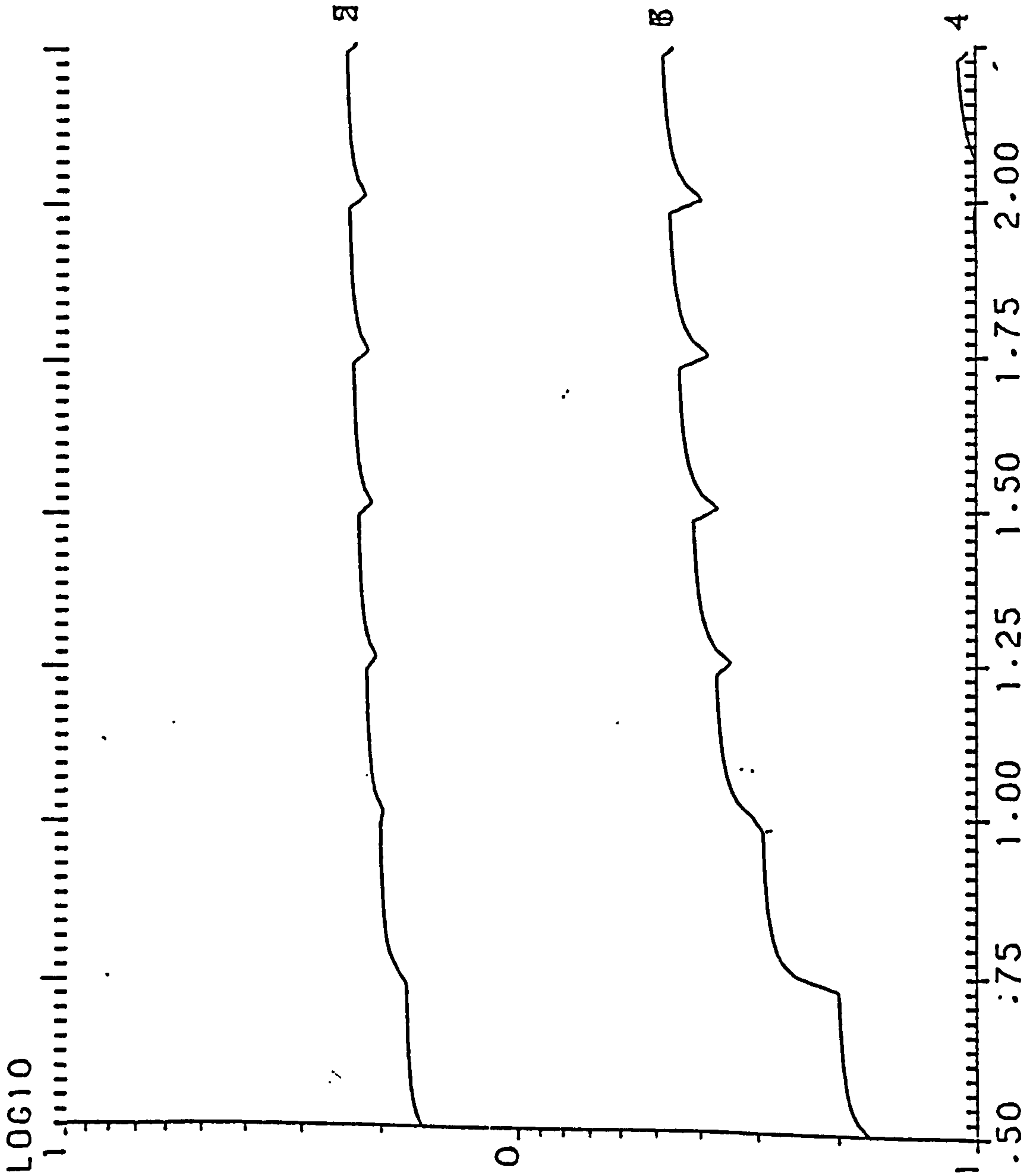

S. EFFICIENCY W. THICKNESS= .12M W. ORIENTATION=292.50

WD= 2M HD1= 22M HD2= 8M HOUSE T.=1.5 ST.





LOG10  
3  
2  
1  
0  
-1

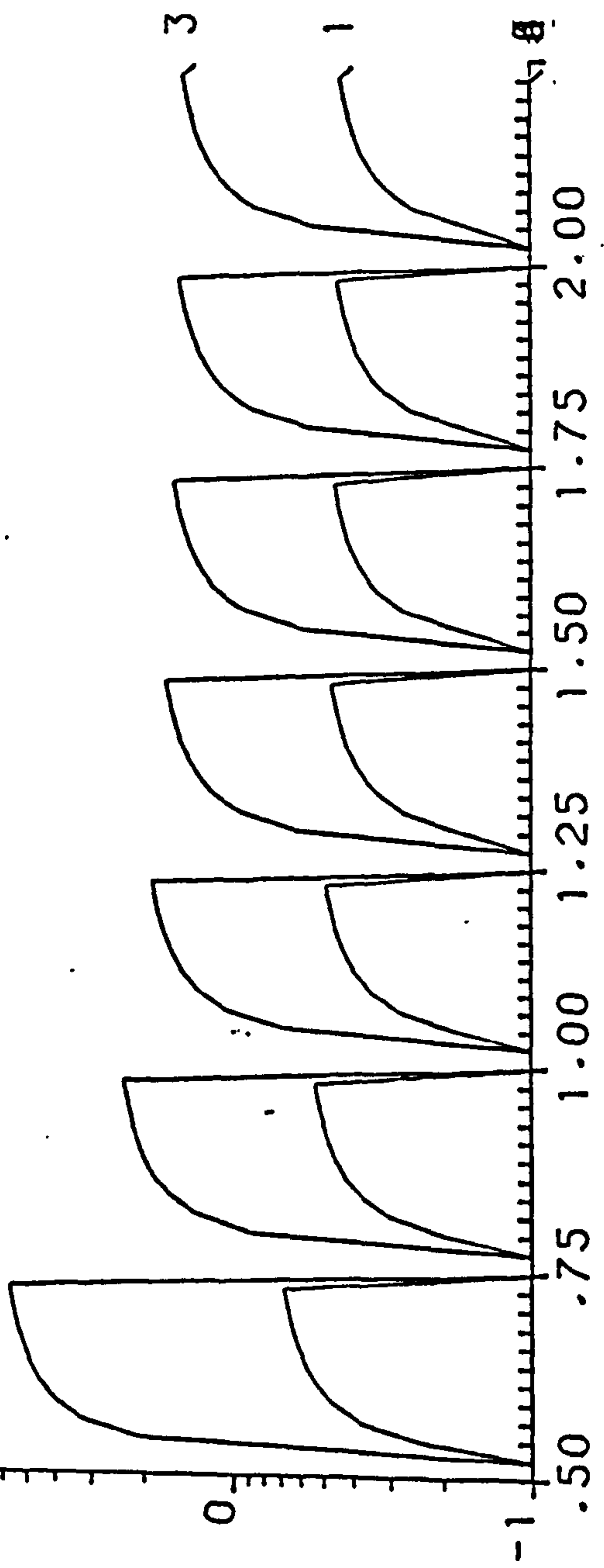

Y. EFFICIENCY W. THICKNESS= .12M W. ORIENTATION=315.00

WD= 2M HD1= 22M HD2= 8M HOUSE T.=1.5 ST.

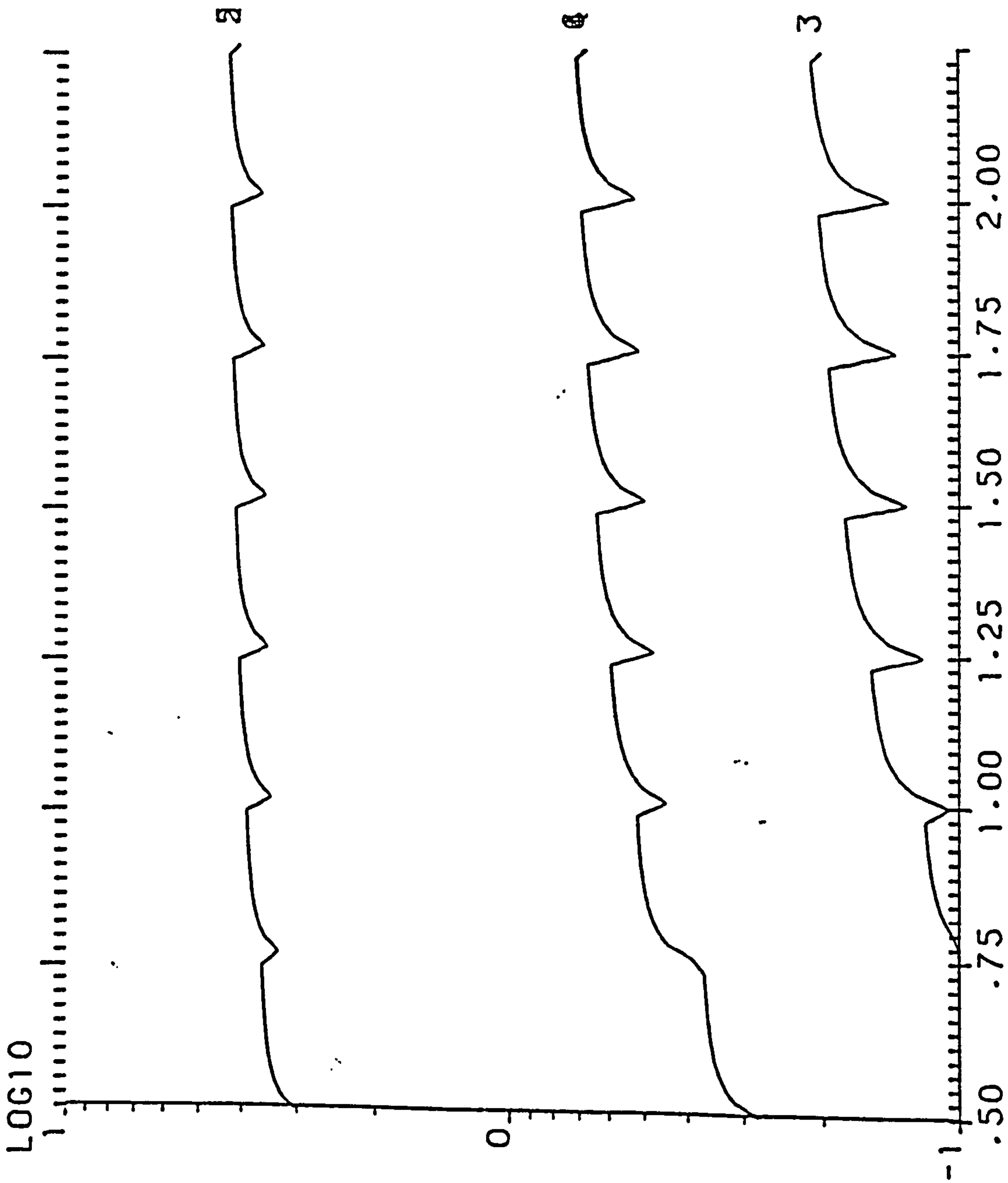

S. EFFICIENCY W. THICKNESS= .12M W. ORIENTATION=315.00

WD= 2M HD1= 22M HD2= 8M HOUSE T.=1.5 ST.



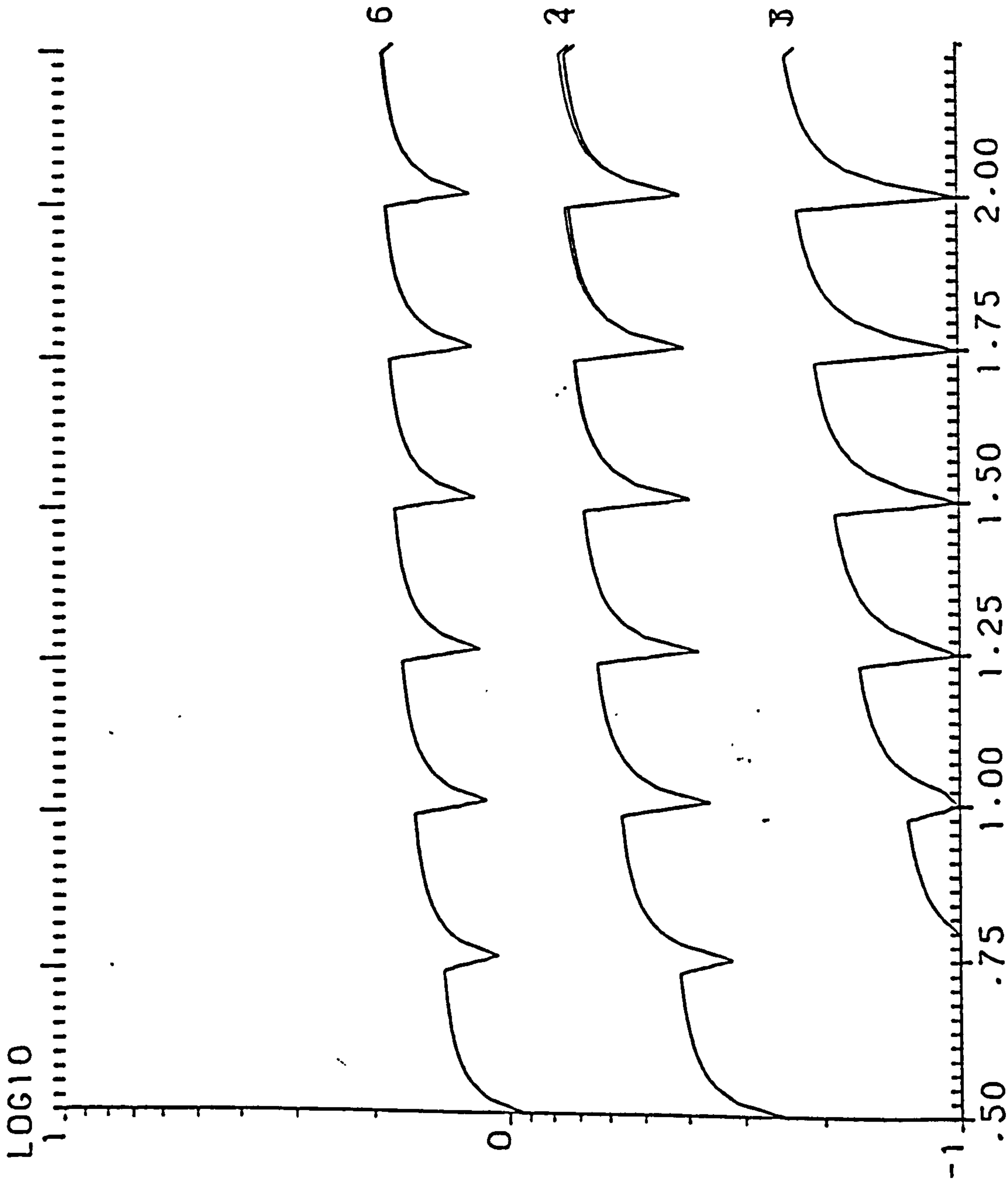

S. EFFICIENCY W. THICKNESS= .12M W. ORIENTATION=337.50

WD= 2M HD1= 22M HD2= 8M HOUSE T.=1.5 ST.



LOG10

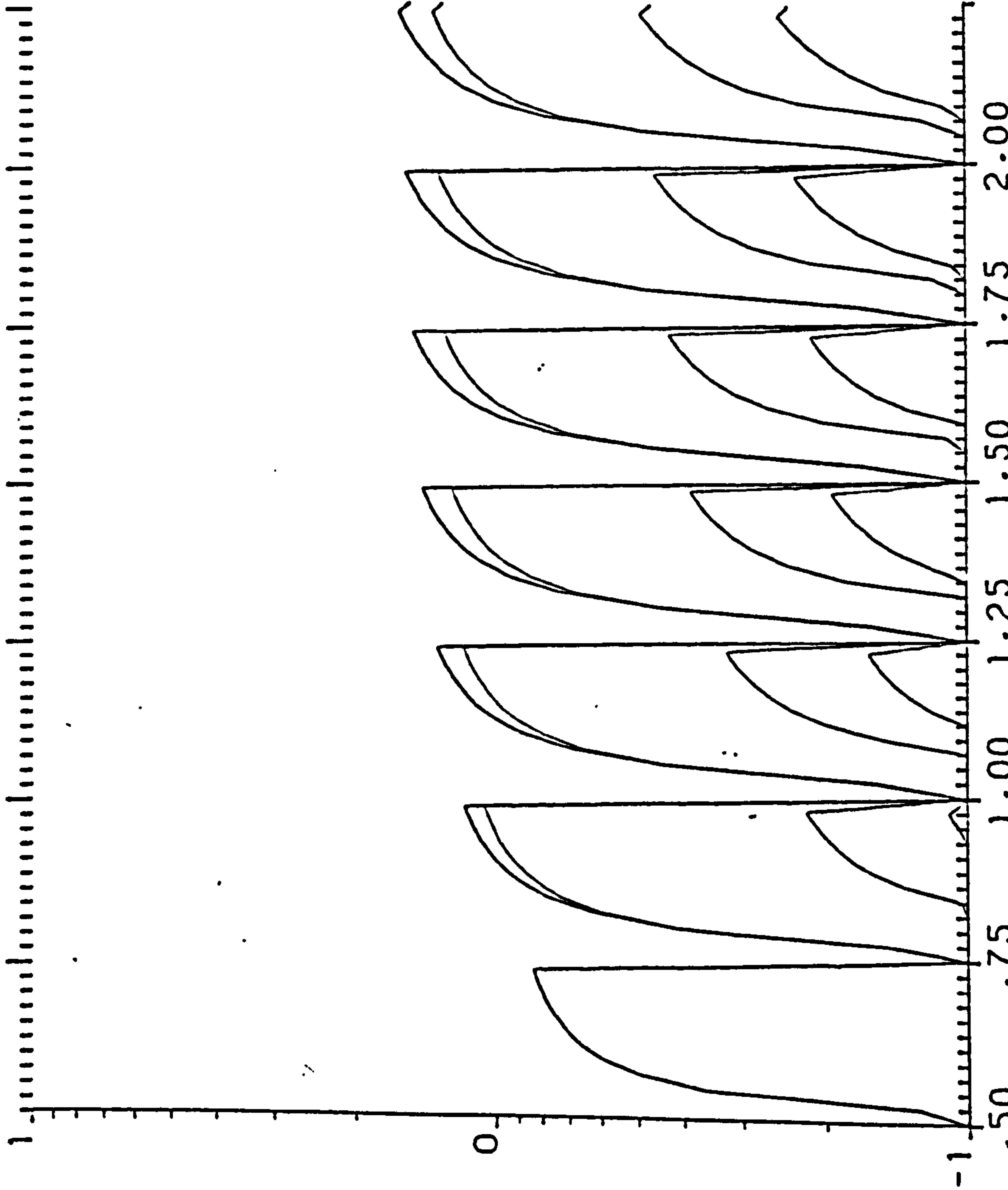

S. EFFICIENCY W. THICKNESS= .24M W. ORIENTATION= .00

WD= 2M HD1= 22M HD2= 8M HOUSE T.=1.5 ST.



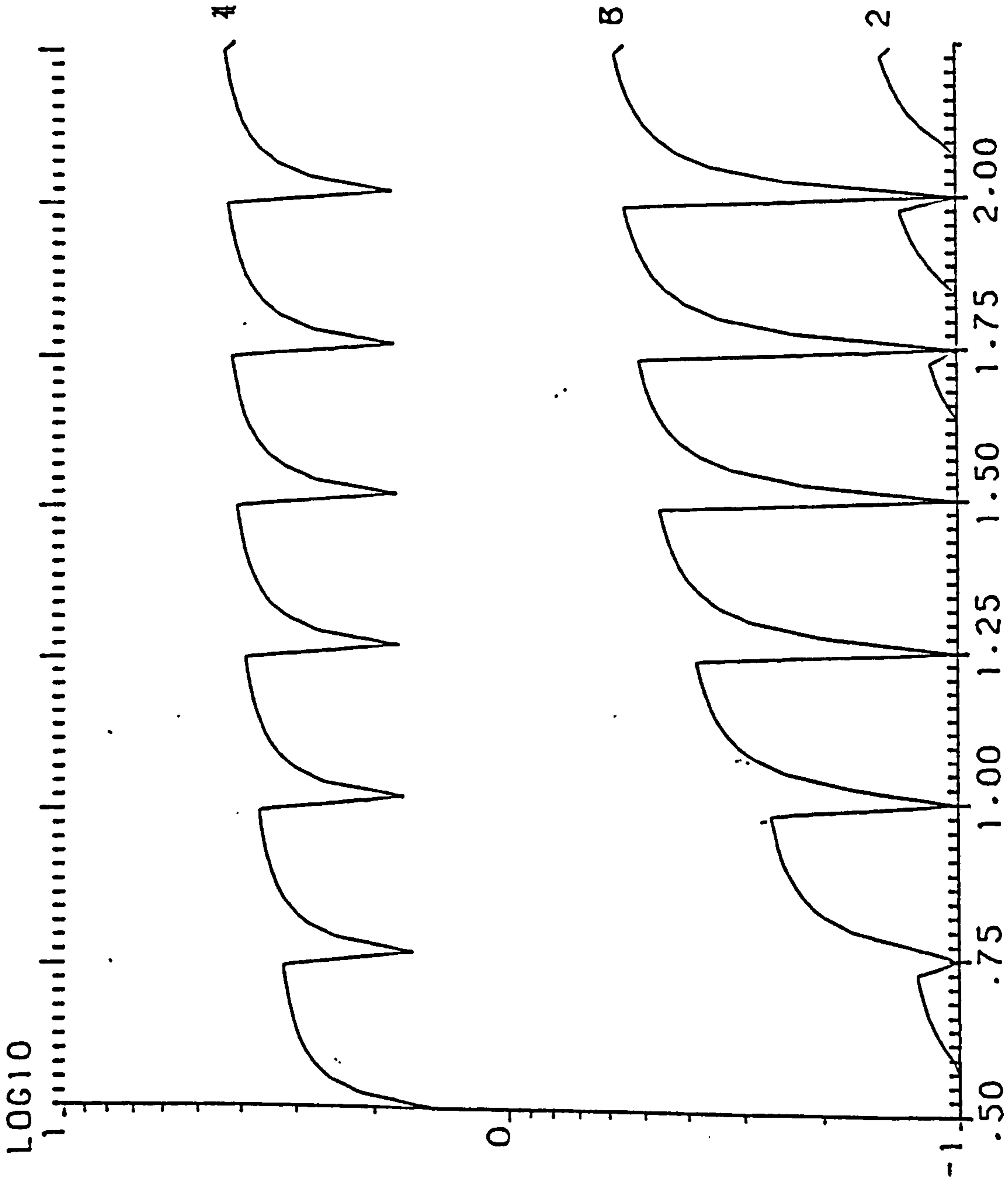

S. EFFICIENCY W. THICKNESS= .24M W. ORIENTATION= 22.50  
 WD= 2M HD1= 22M HD2= 8M HOUSE T.=1.5 ST.



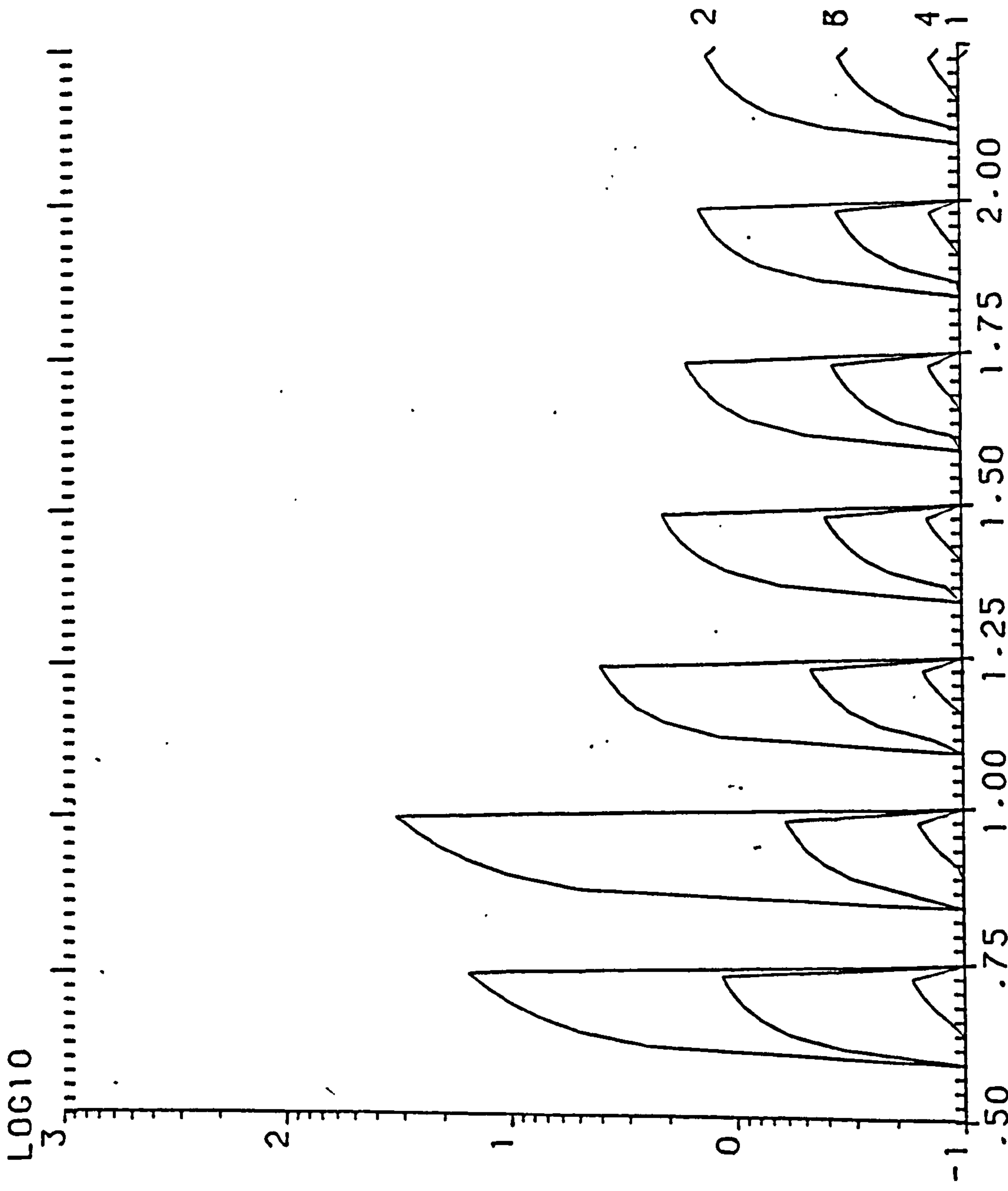

Y. EFFICIENCY W. THICKNESS= .24M W. ORIENTATION= 45.00

WD= 2M HD1= 22M HD2= 8M HOUSE T.=1.5 ST.

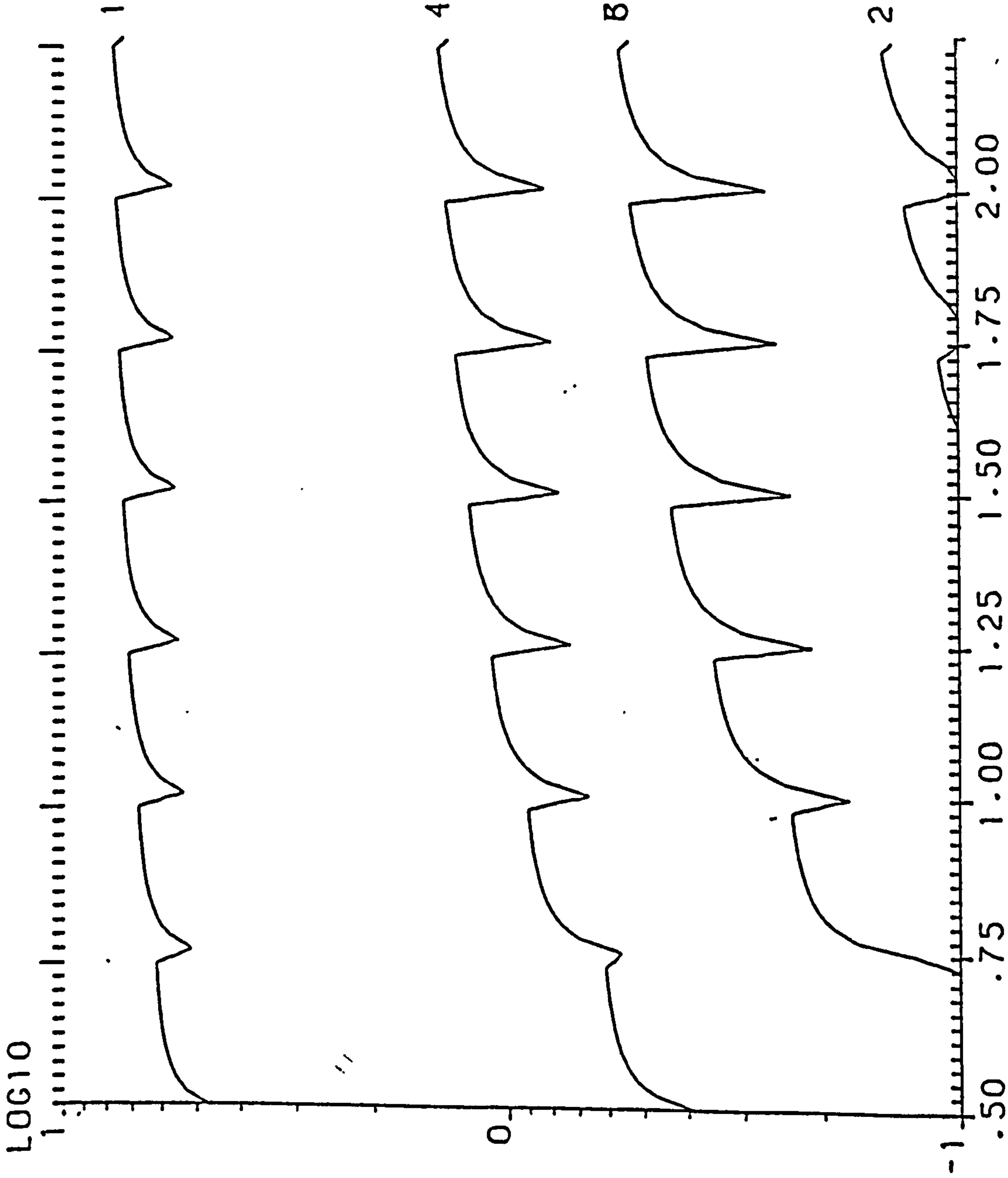

S. EFFICIENCY W. THICKNESS= .24M W. ORIENTATION= 45.00

WD= 2M HD1= 22M HD2= 8M HOUSE T.=1.5 ST.

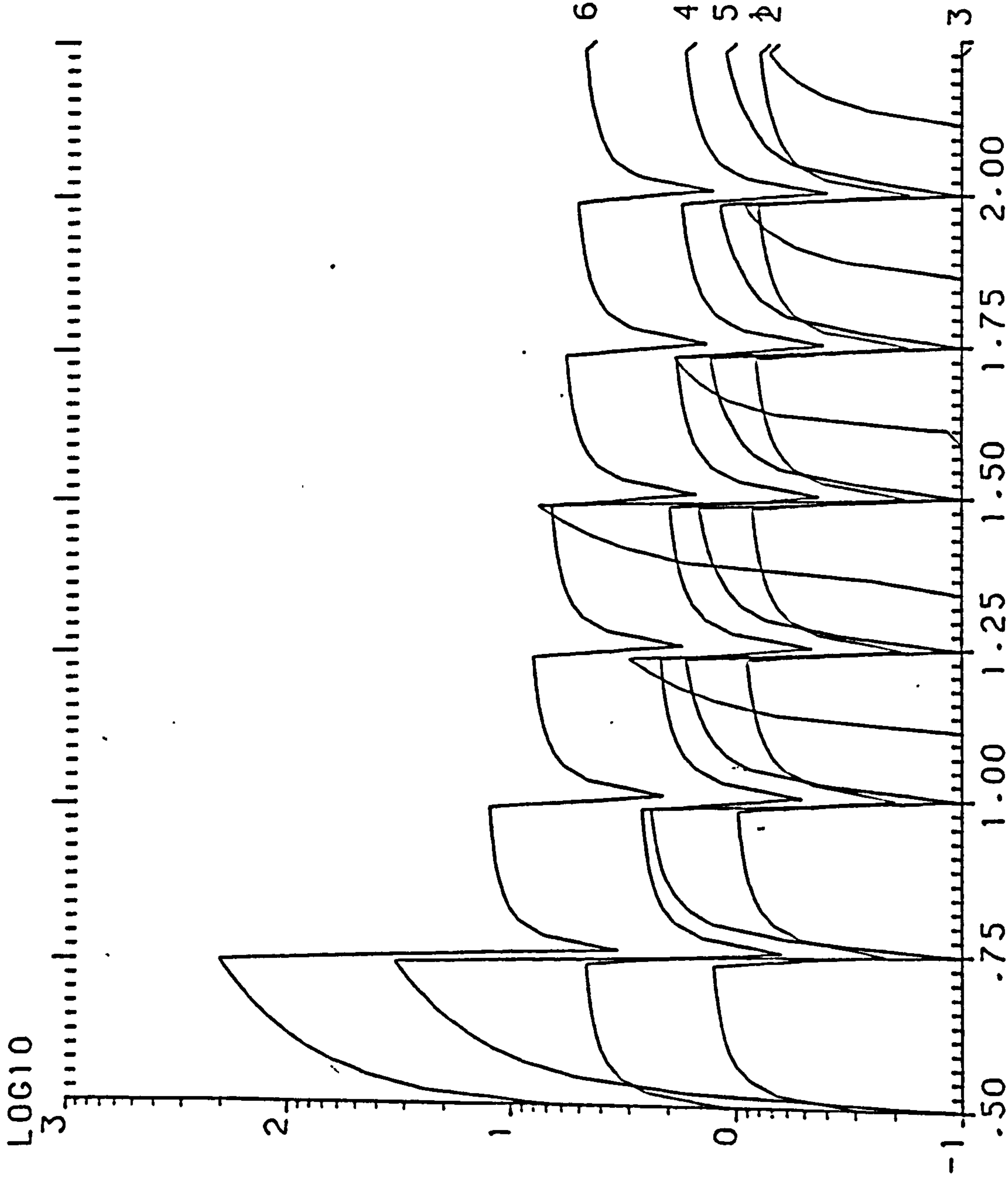

Y. EFFICIENCY W. THICKNESS= .24M W. ORIENTATION= 67.50

WD= 2M HD1= 22M HD2= 8M HOUSE T.=1.5 ST.

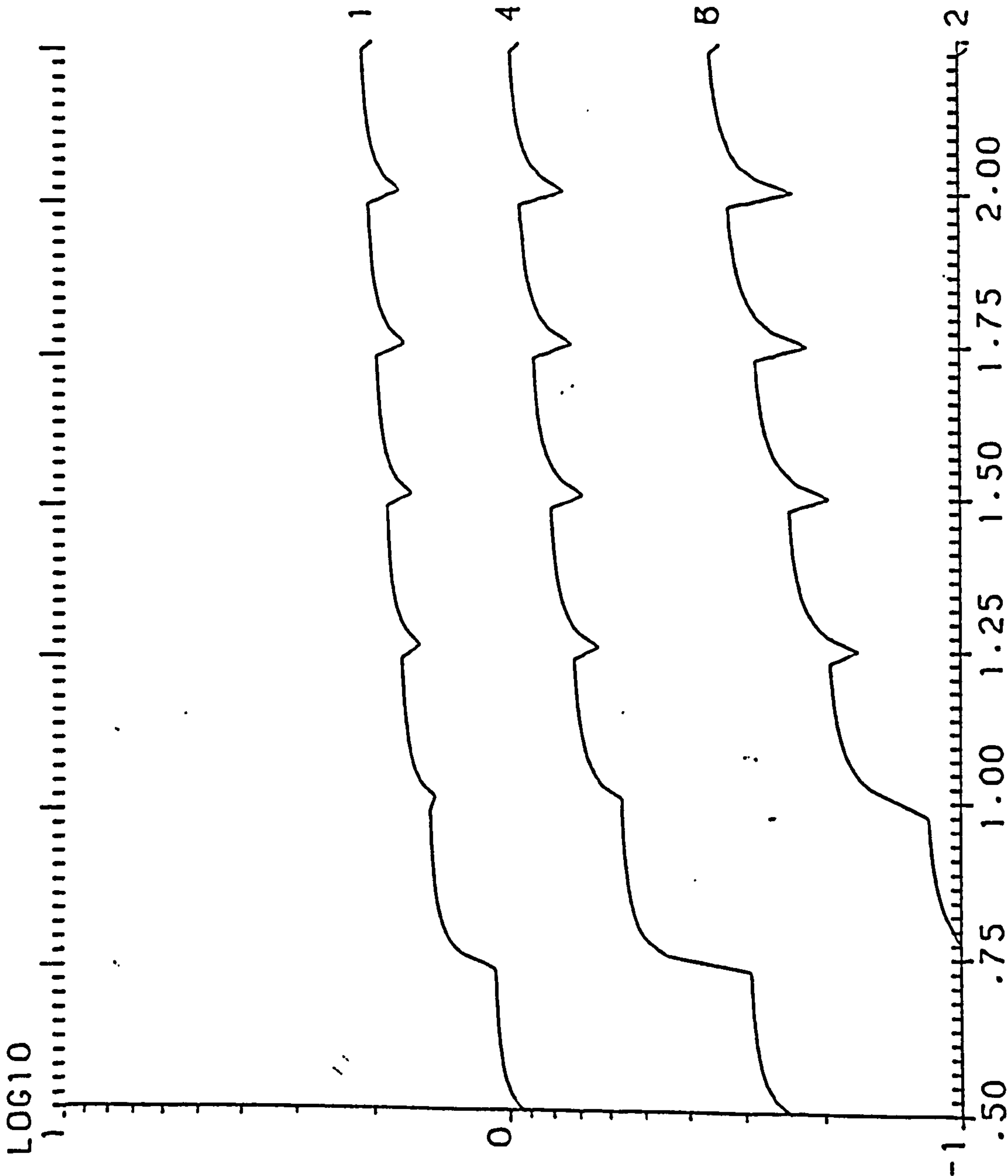

S. EFFICIENCY W. THICKNESS= .24M W. ORIENTATION= 67.50

WD= 2M. HD1= 22M HD2= 8M HOUSE T.=1.5 ST.



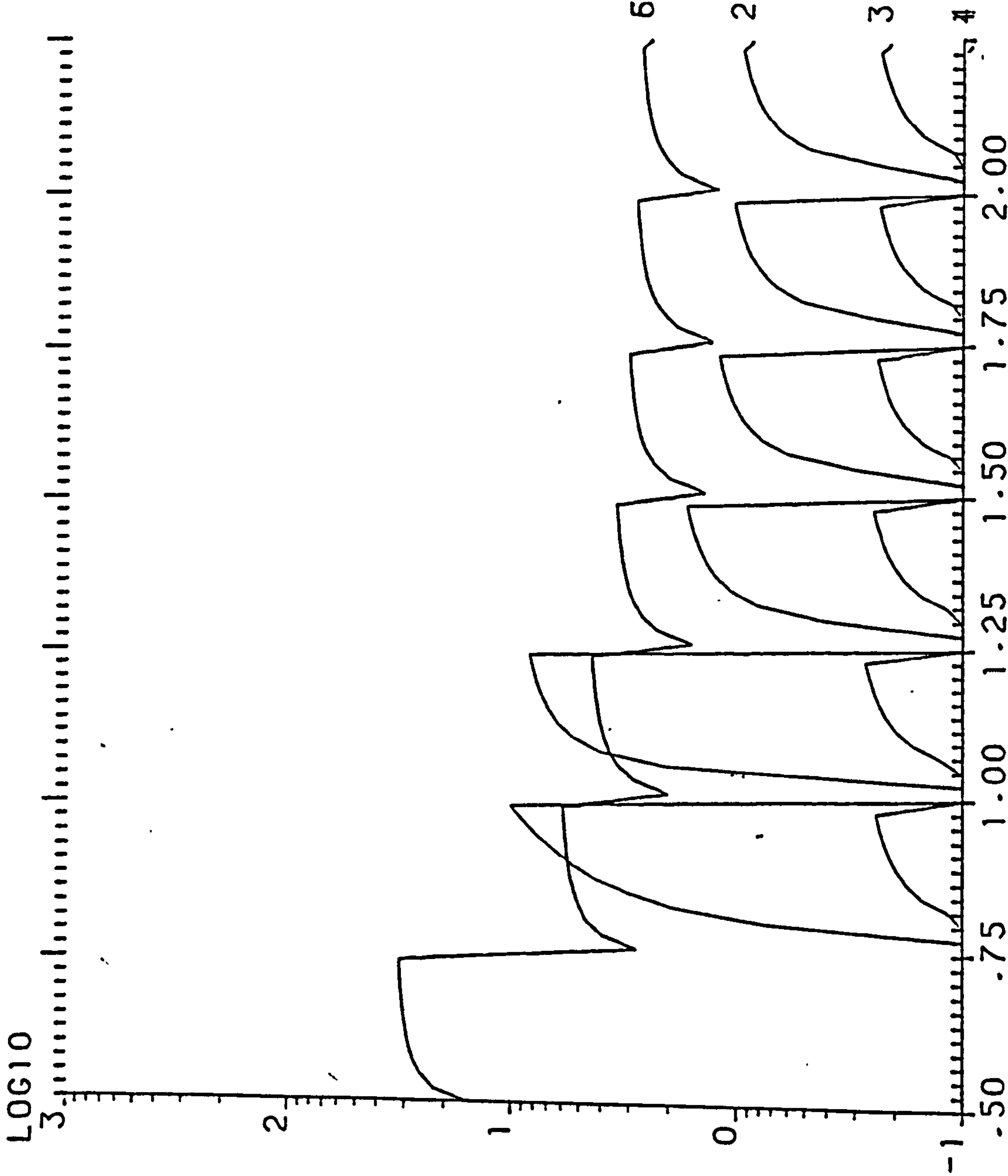

Y. EFFICIENCY W. THICKNESS= .24M W. ORIENTATION= 90.00  
 WD= 2M HD1= 22M HD2= 8M HOUSE T.=1.5 ST.



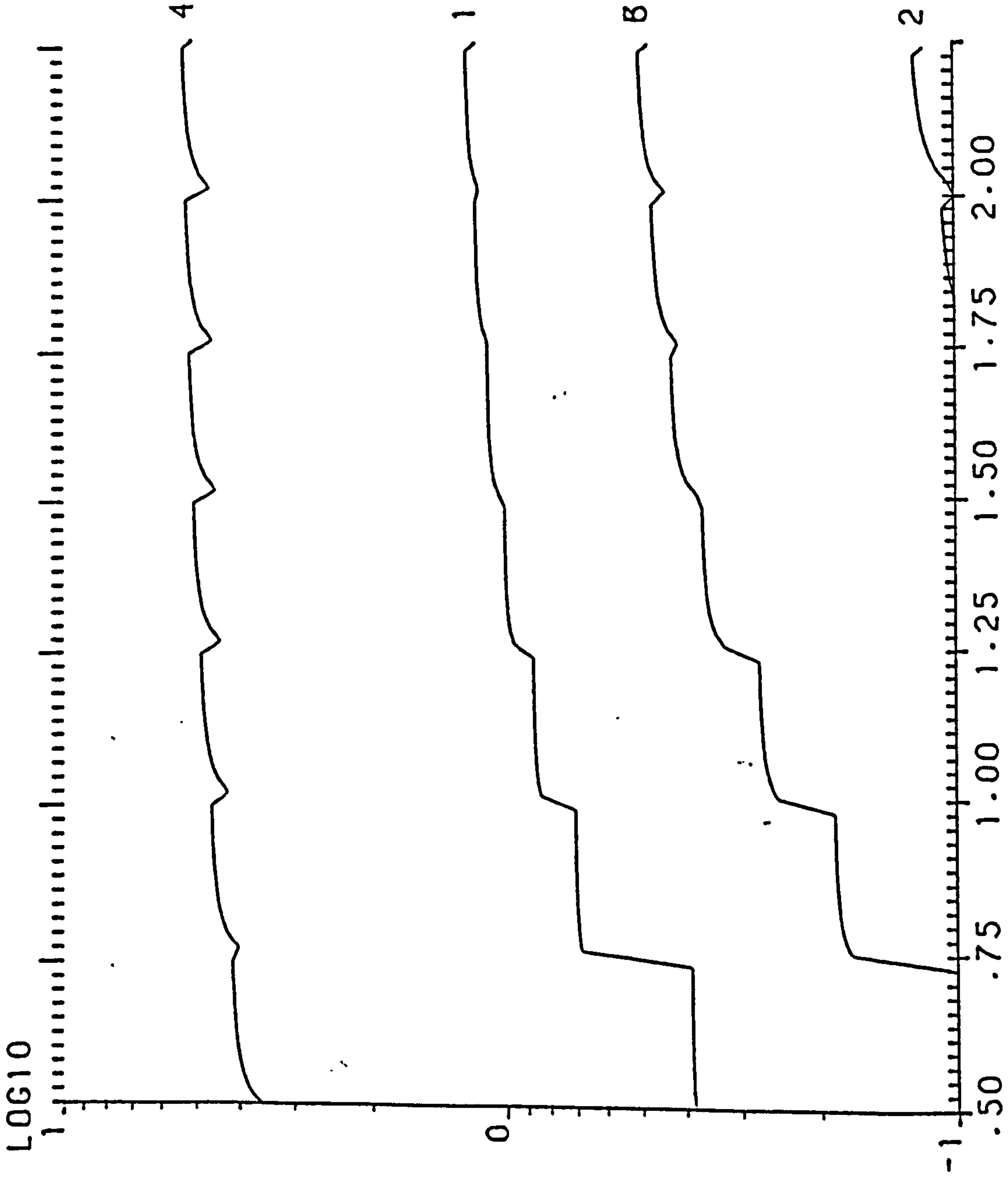

S. EFFICIENCY W. THICKNESS= .24M W. ORIENTATION= 90.00  
 WD= 2M HD1= 22M HD2= 8M HOUSE T.=1.5 ST.

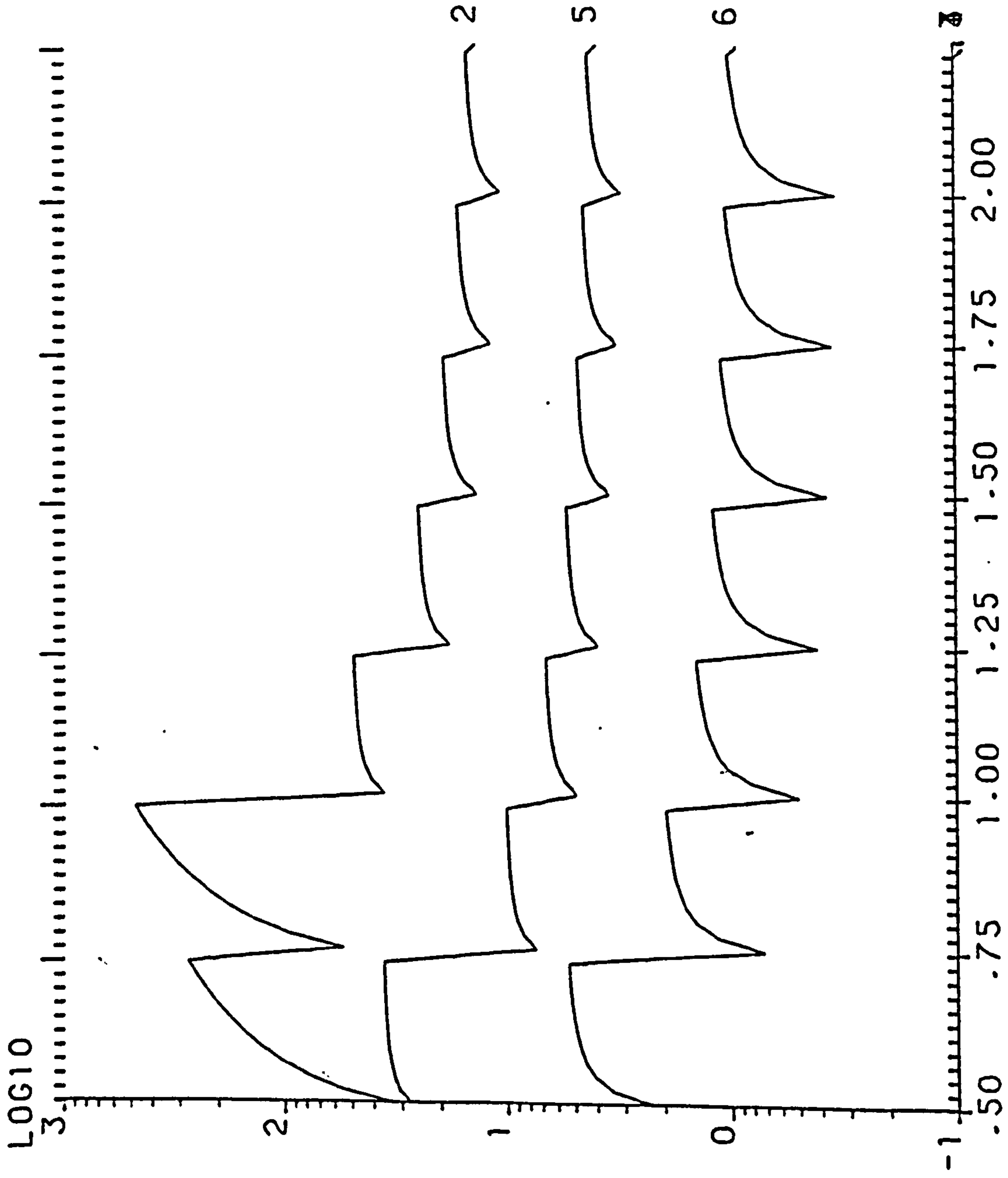

Y. EFFICIENCY W. THICKNESS= .24M W. ORIENTATION=112.50

WD= 2M HD1= 22M HD2= 8M HOUSE T.=1.5 ST.

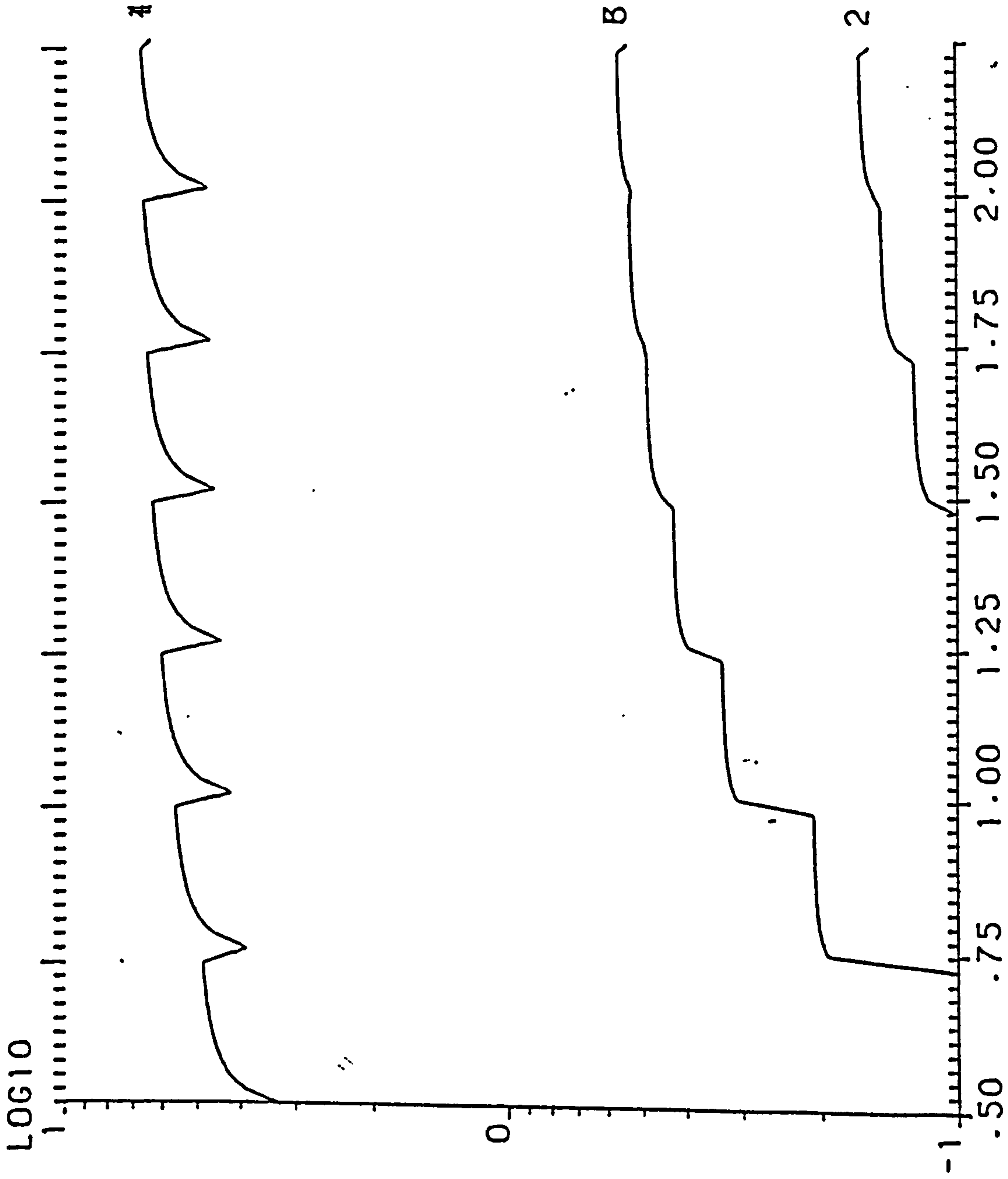

S. EFFICIENCY W. THICKNESS= .24M W. ORIENTATION=112.50

WD= 2M HD1= 22M HD2= 8M HOUSE T.=1.5 ST.



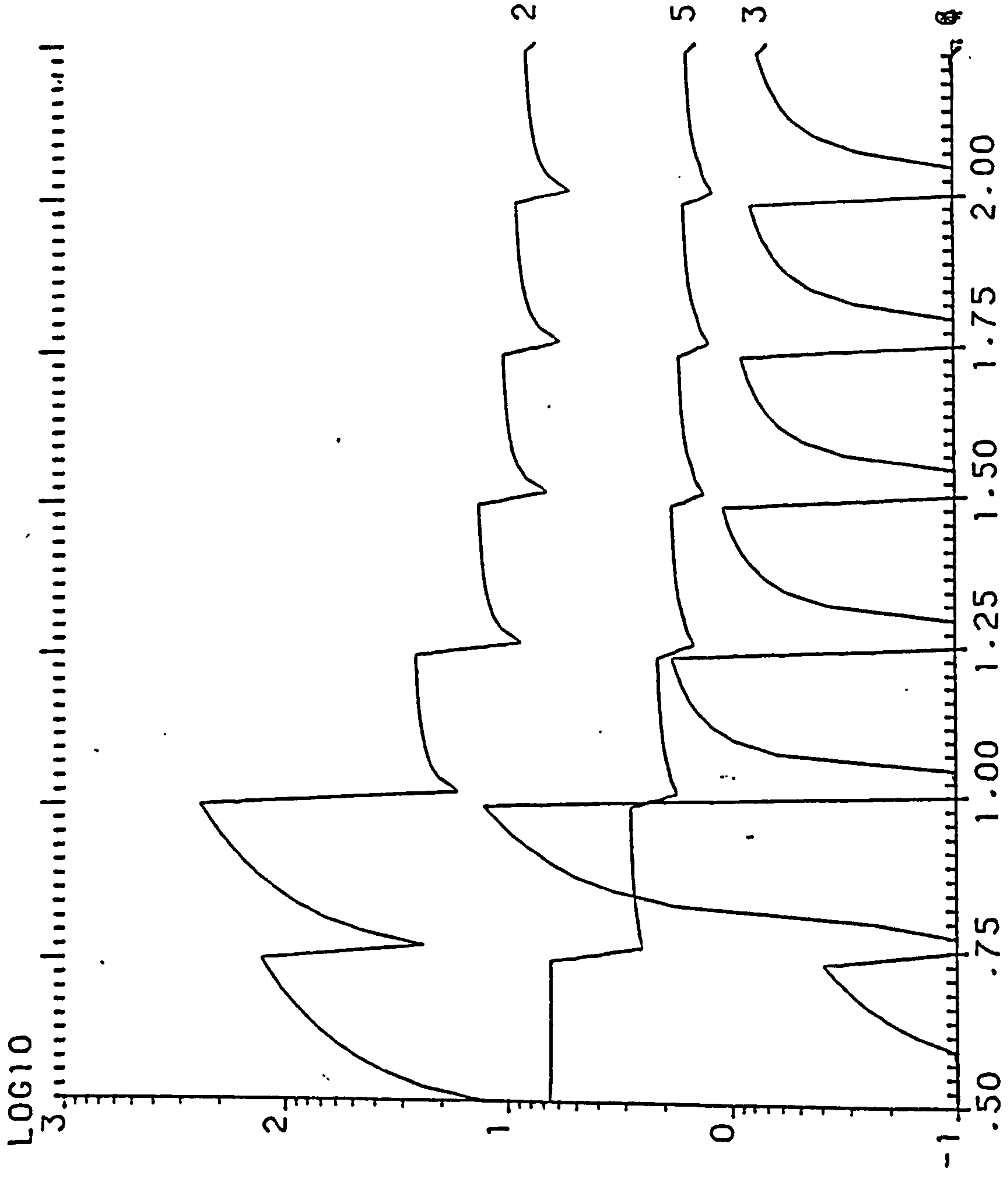

Y. EFFICIENCY W. THICKNESS= .24M W. ORIENTATION=135.00

WD= 2M HD1= 22M HD2= 8M HOUSE T.=1.5 ST.

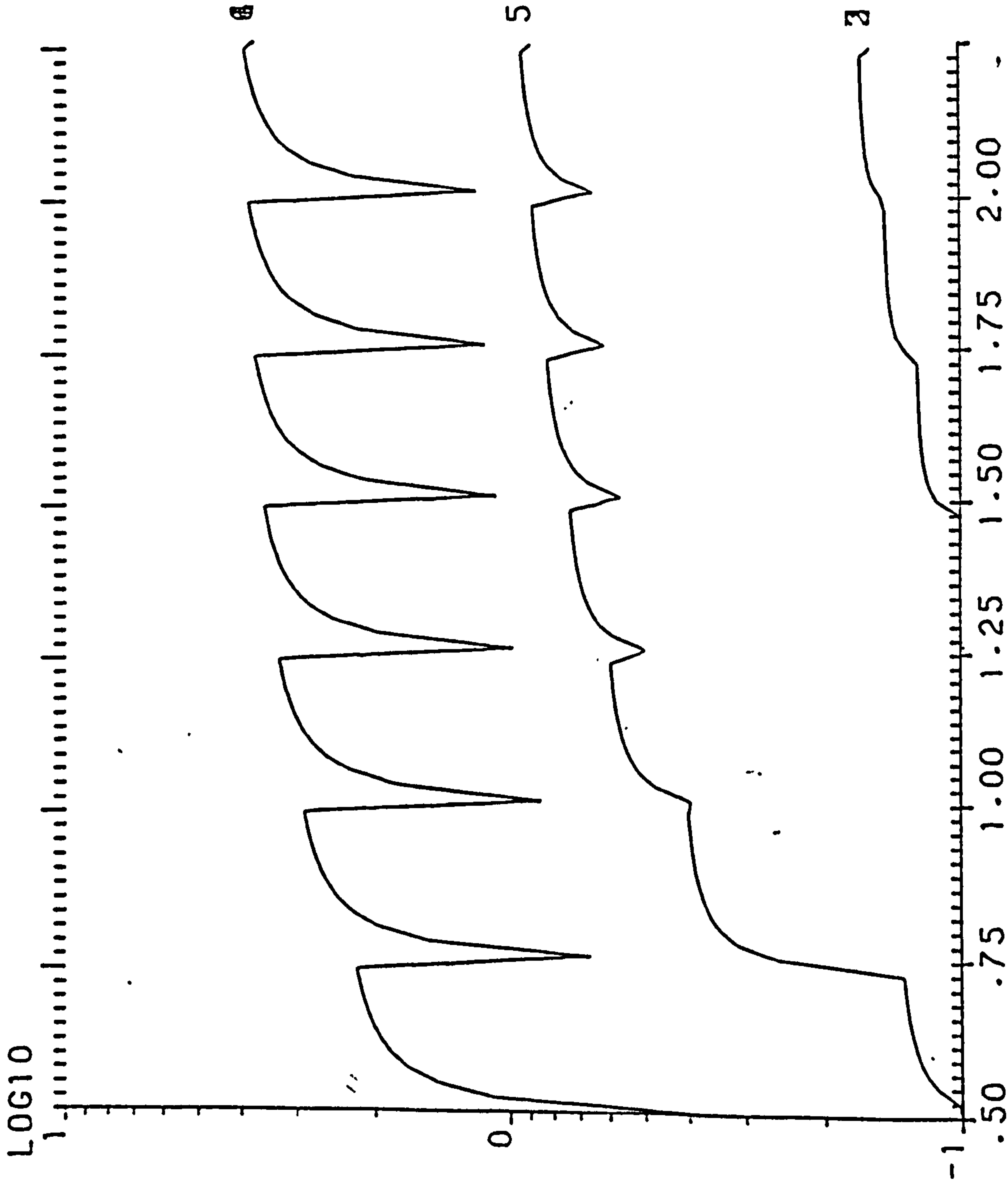

S. EFFICIENCY    W. THICKNESS= .24M    HD2= 8M    HOUSE T.=1.5 ST.  
 WD= 2M    HD1= 22M

W. ORIENTATION=135.00



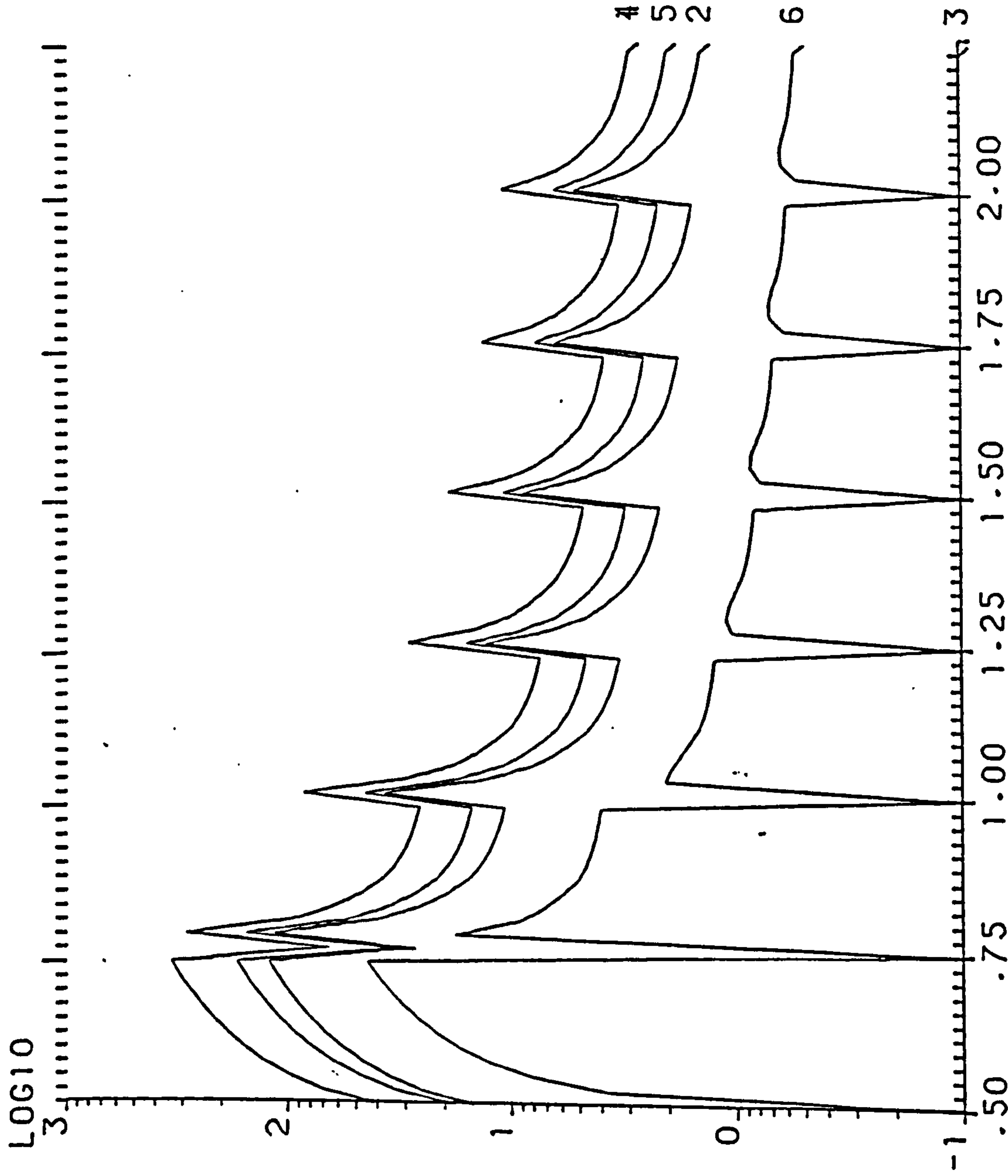

Y. EFFICIENCY W. THICKNESS= .24M W. ORIENTATION=157.50

WD= 2M HD1= 22M HD2= 8M HOUSE T.=1.5 ST.

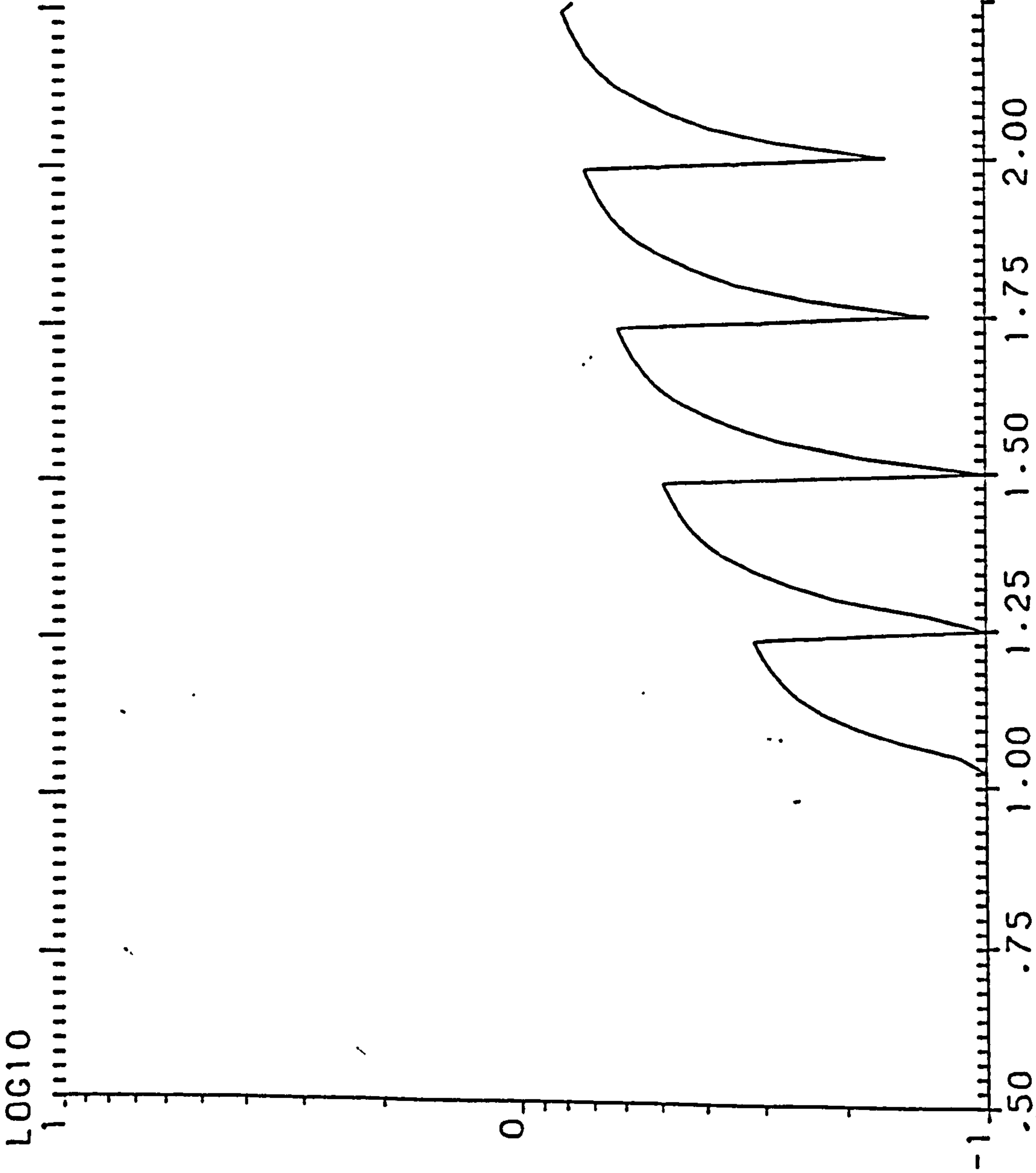

S. EFFICIENCY W. THICKNESS= .24M W. ORIENTATION=157.50

WD= 2M HD1= 22M HD2= 8M HOUSE T.=1.5 ST.



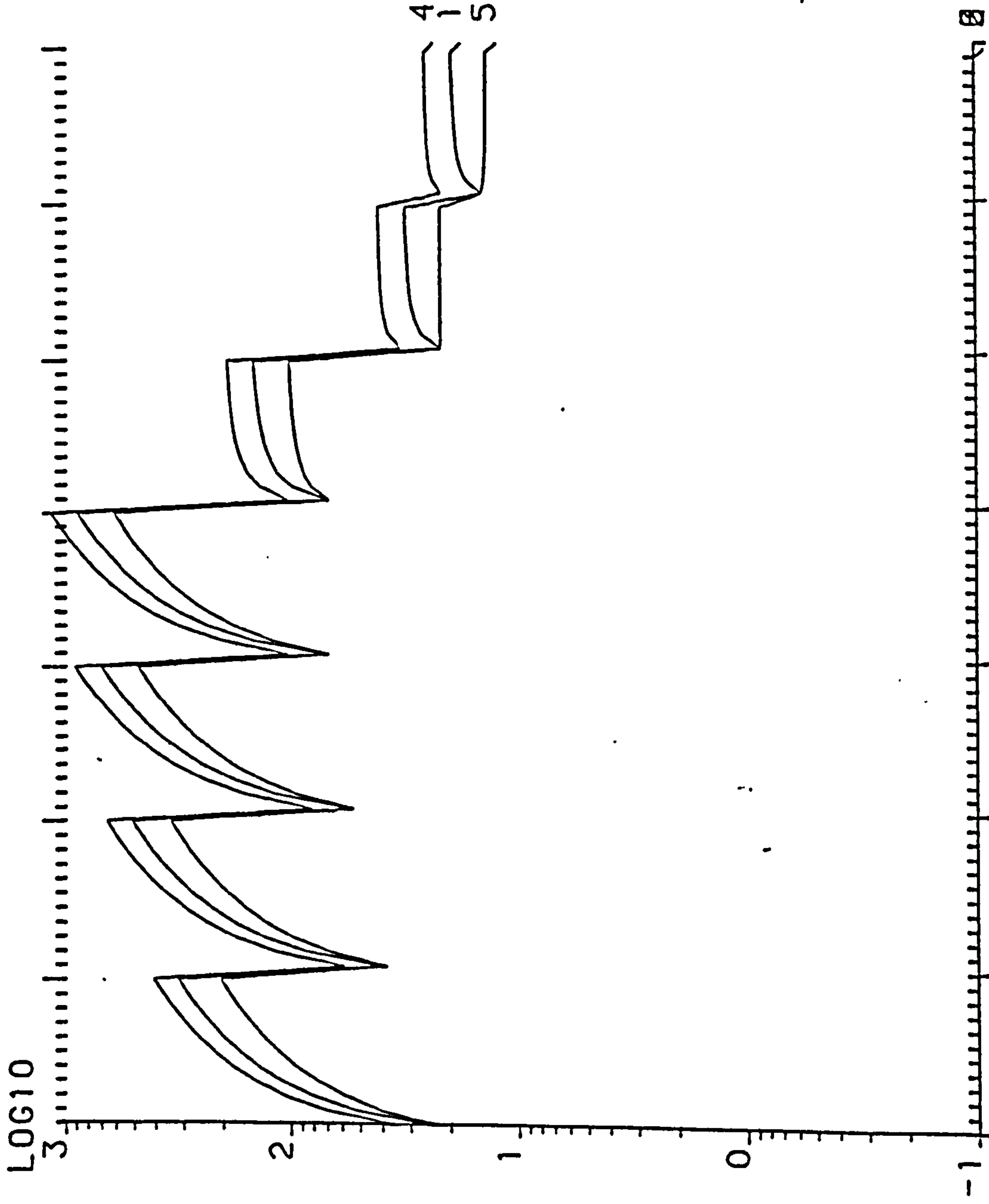

4  
1  
5

Y. EFFICIENCY W. THICKNESS= .24M W. ORIENTATION=180.00

WD= 2M HD1= 22M HD2= 8M HOUSE T.=1.5 ST.

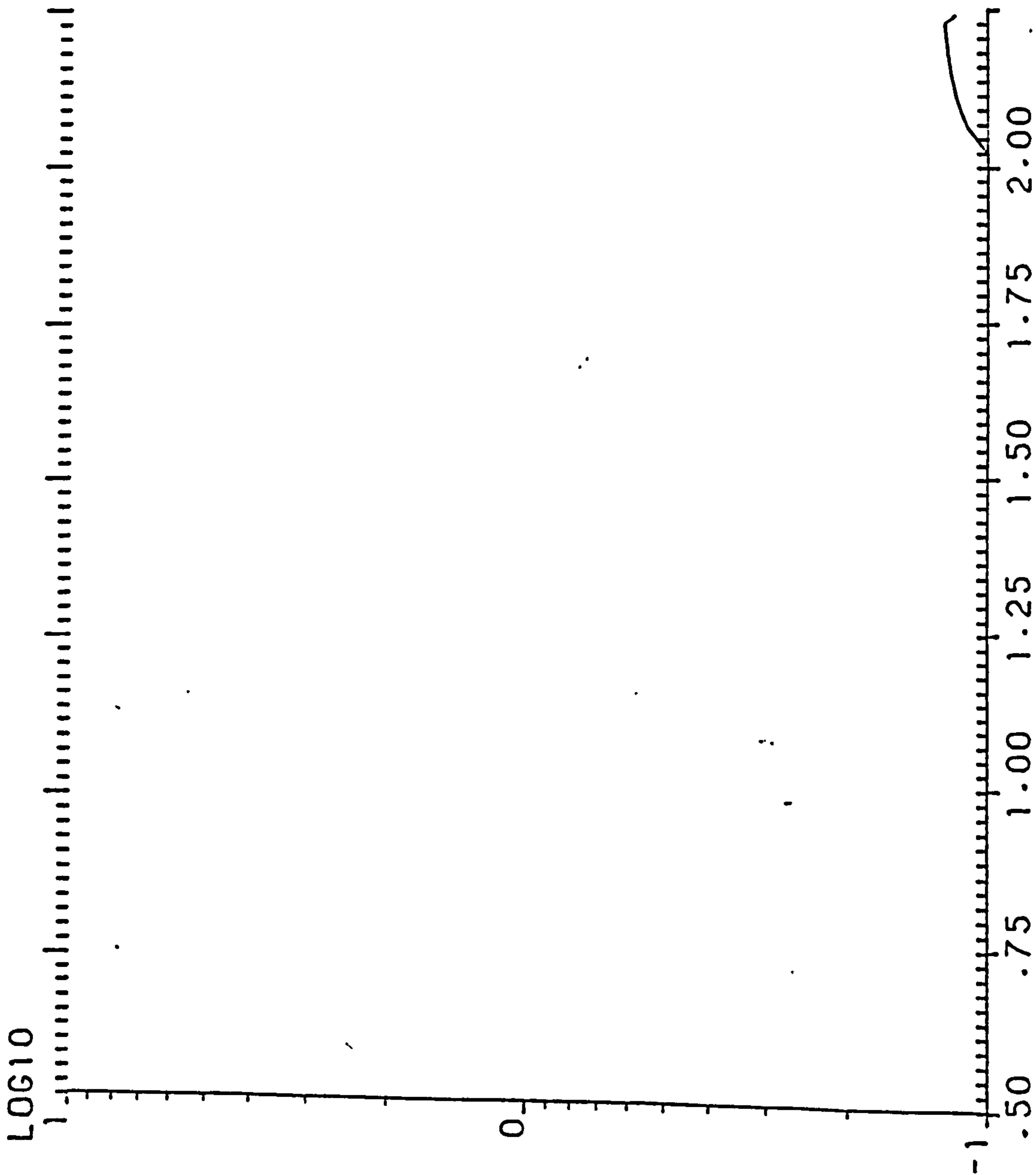

S. EFFICIENCY W. THICKNESS= .24M W. ORIENTATION=180.00

WD= 2M HD1= 22M HD2= 8M HOUSE T.=1.5 ST.







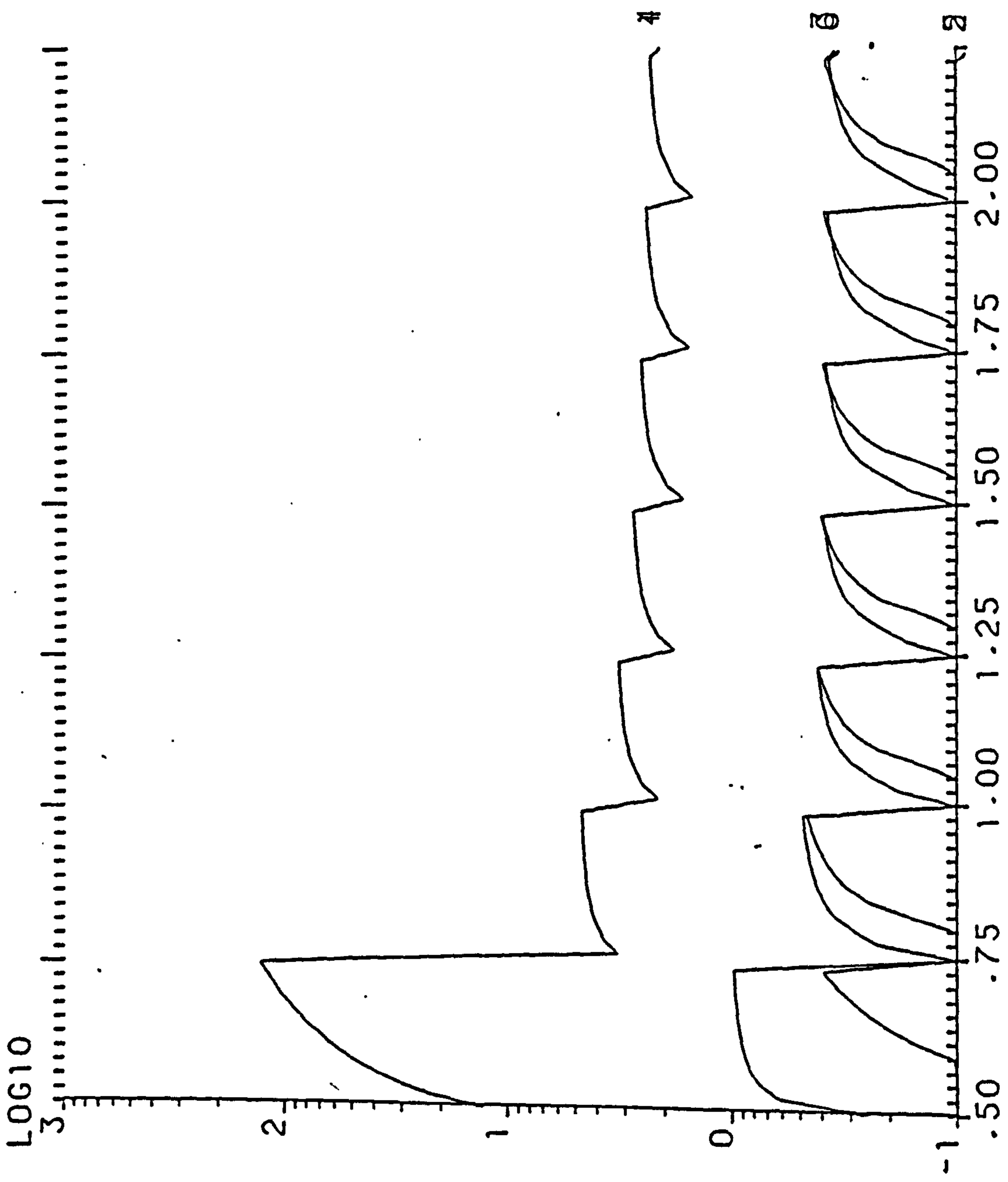

Y. EFFICIENCY W. THICKNESS= .24M W. ORIENTATION=225.00

WD= 2M HD1= 22M HD2= 8M HOUSE T.=1.5 ST.

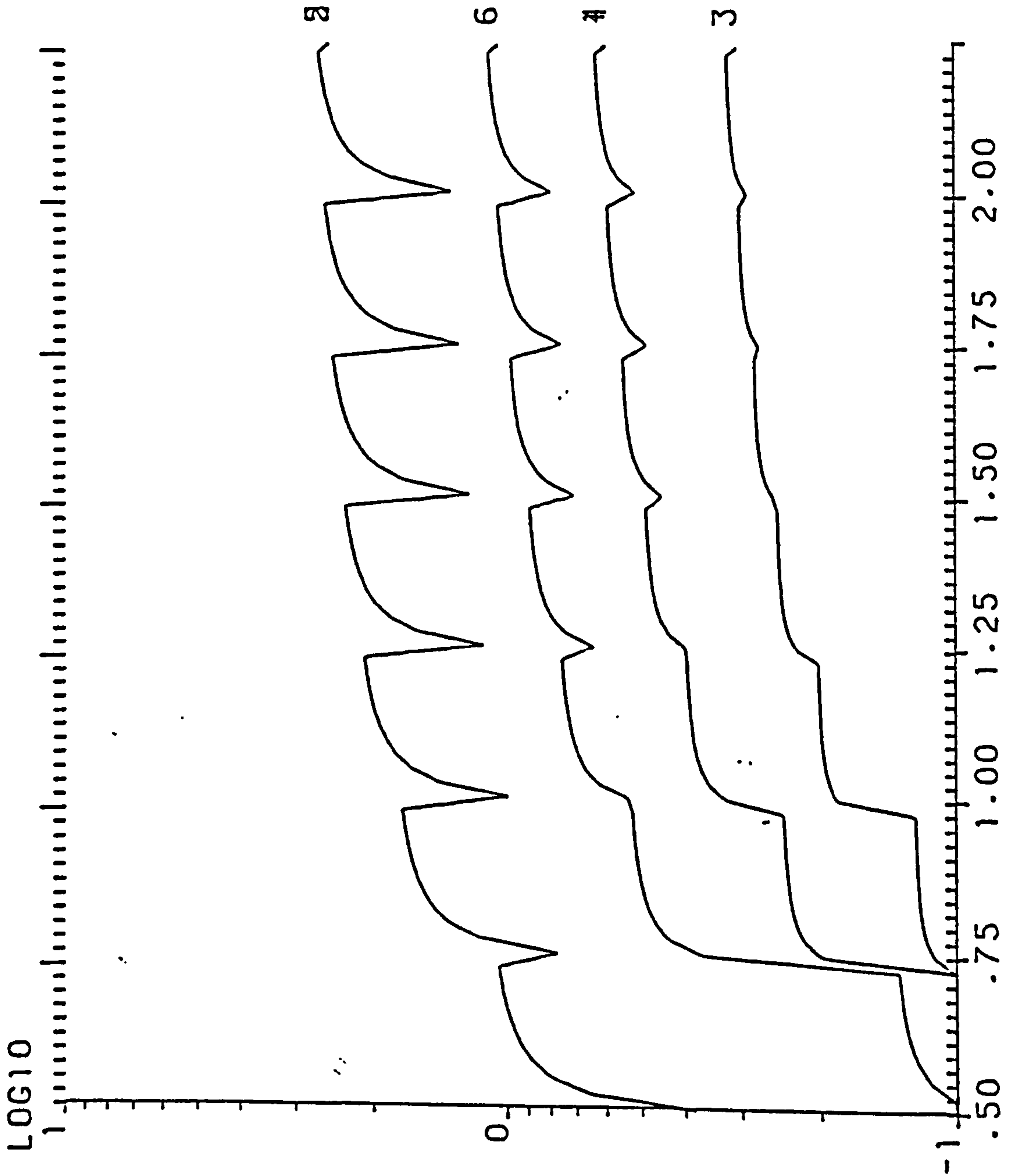

S. EFFICIENCY W. THICKNESS= .24M W. ORIENTATION=225.00

WD= 2M HD1= 22M HD2= 8M HOUSE T.=1.5 ST.



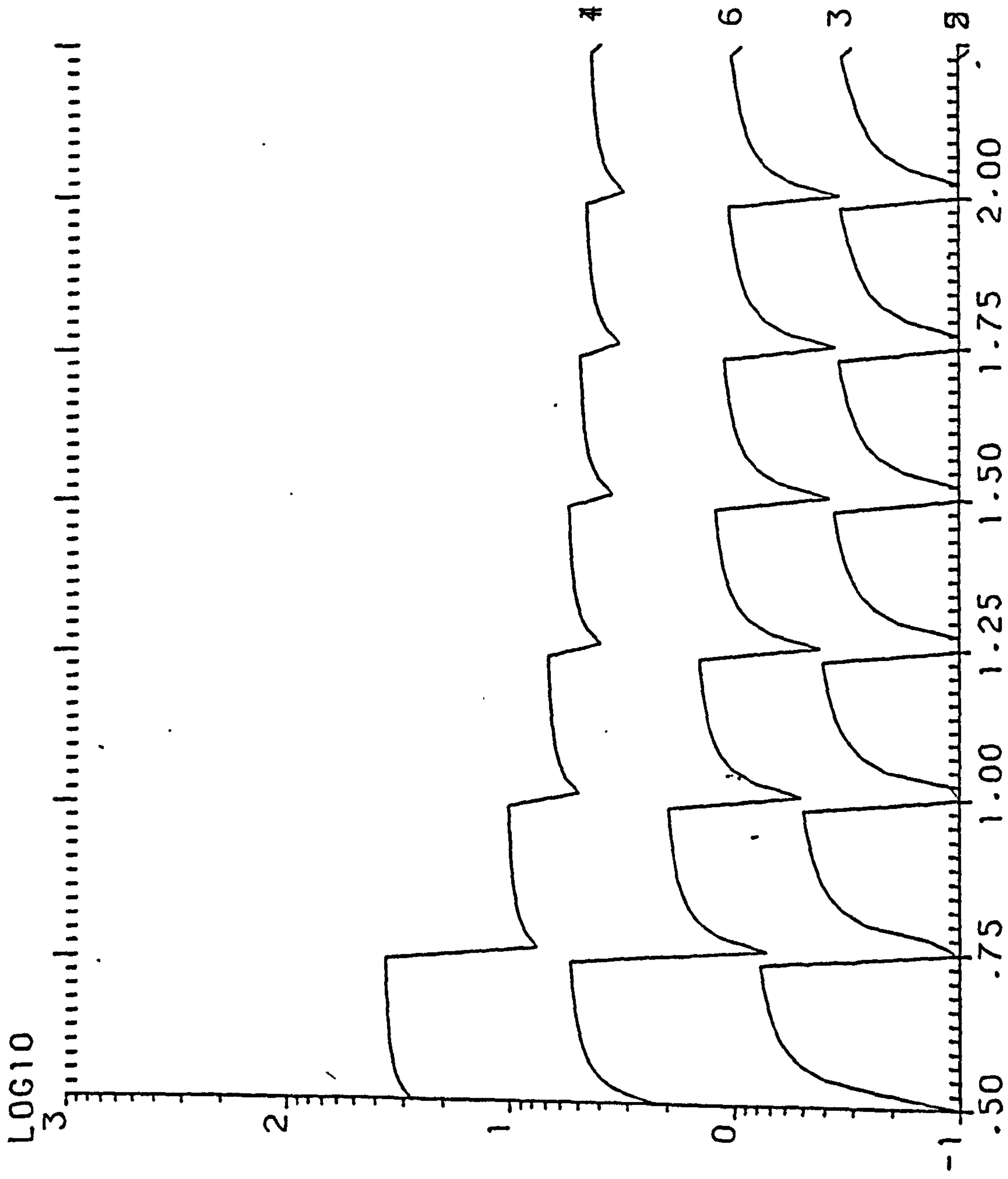

Y. EFFICIENCY W. THICKNESS= .24M W. ORIENTATION=247.50

WD= 2M HD1= 22M HD2= 8M HOUSE T.=1.5 ST.

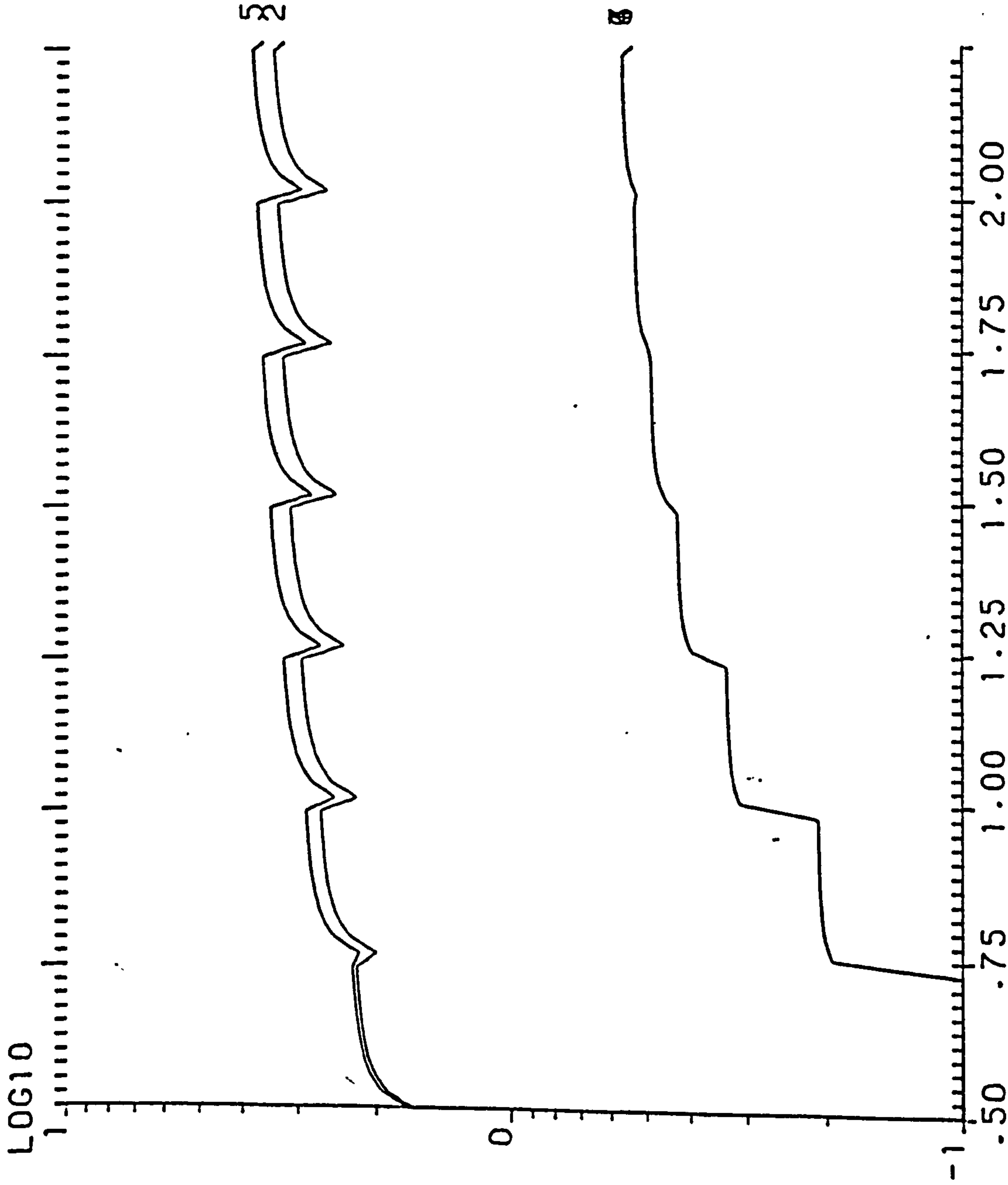

S. EFFICIENCY W. THICKNESS= .24M W. ORIENTATION=247.50  
WD= 2M HD1= 22M HD2= 8M HOUSE T.=1.5 ST.

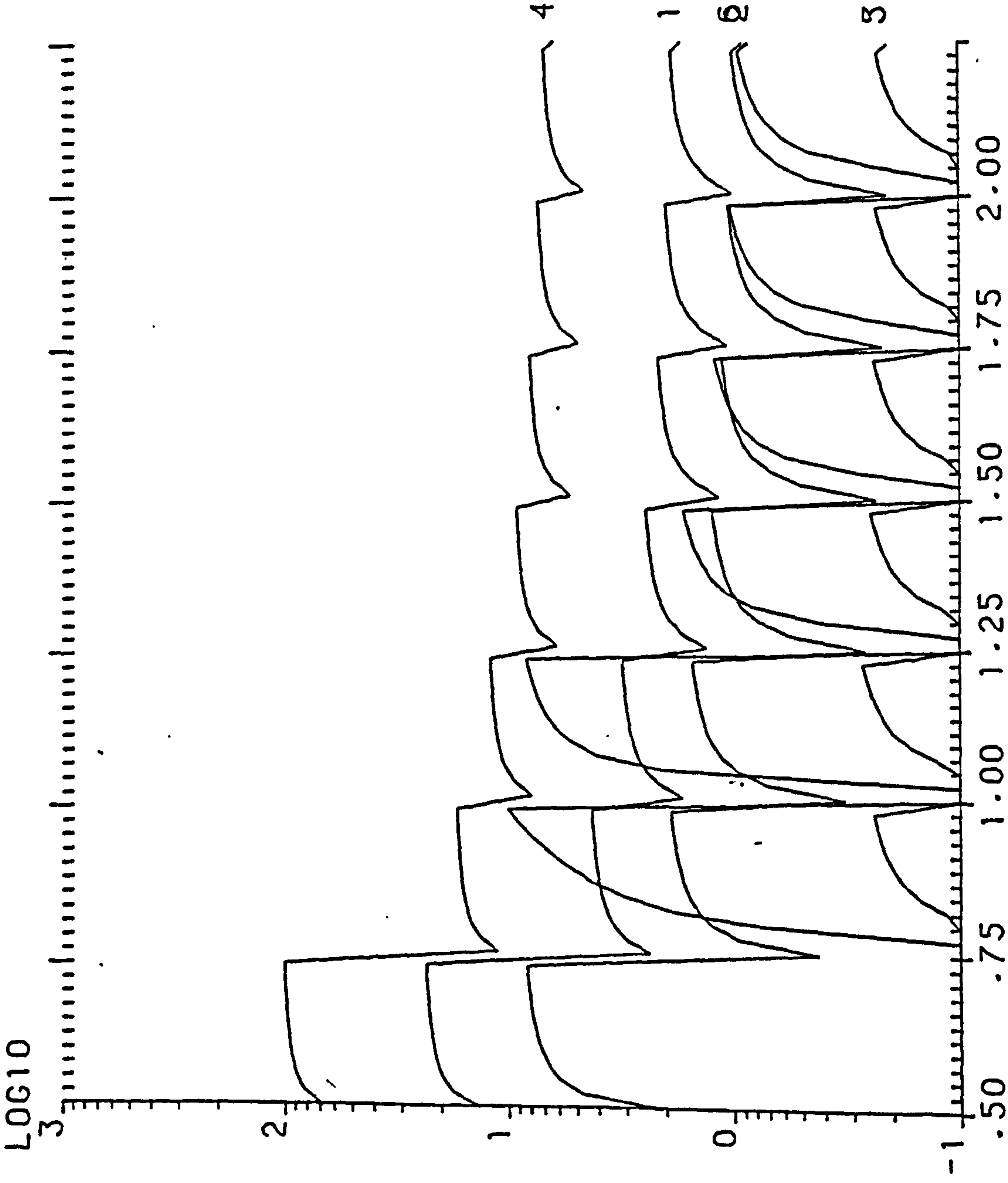

Y. EFFICIENCY W. THICKNESS= .24M W. ORIENTATION=270.00

WD= 2M HD1= 22M HD2= 8M HOUSE T.=1.5 ST.



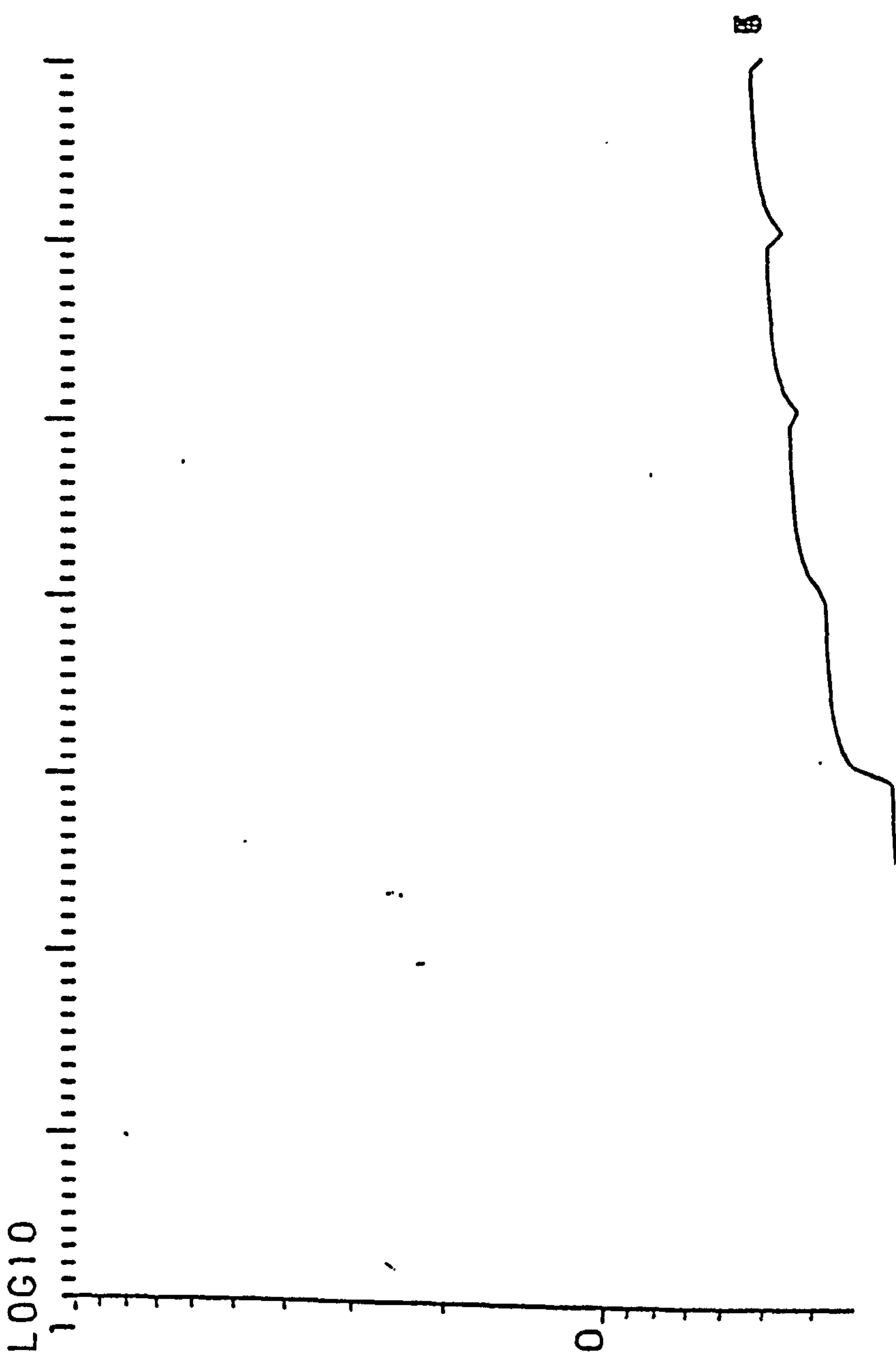

formance Low Performance

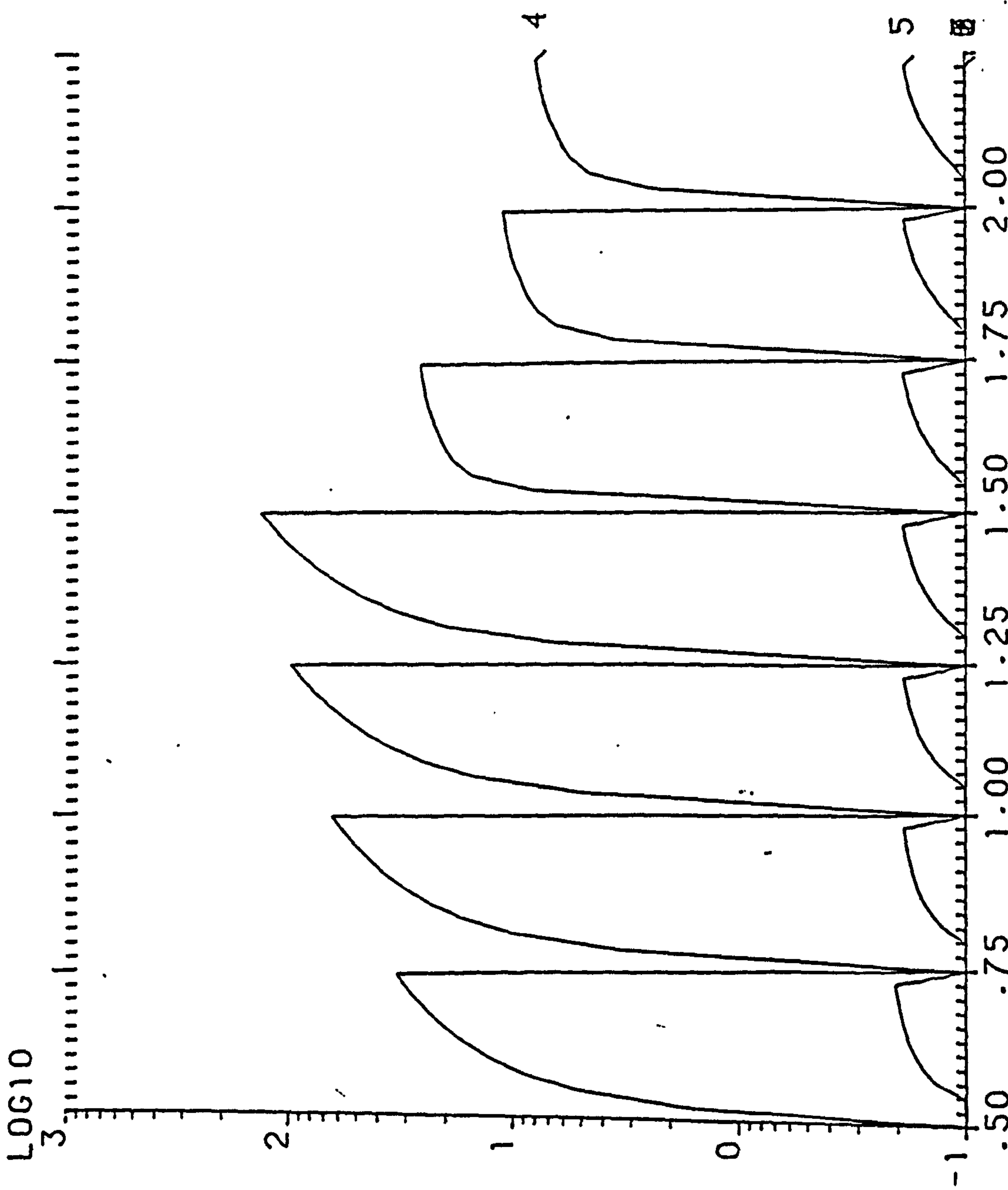

Y. EFFICIENCY W. THICKNESS= .24M W. ORIENTATION=292.50  
 WD= 2M HD1= 22M HD2= 8M HOUSE T.=1.5 ST.

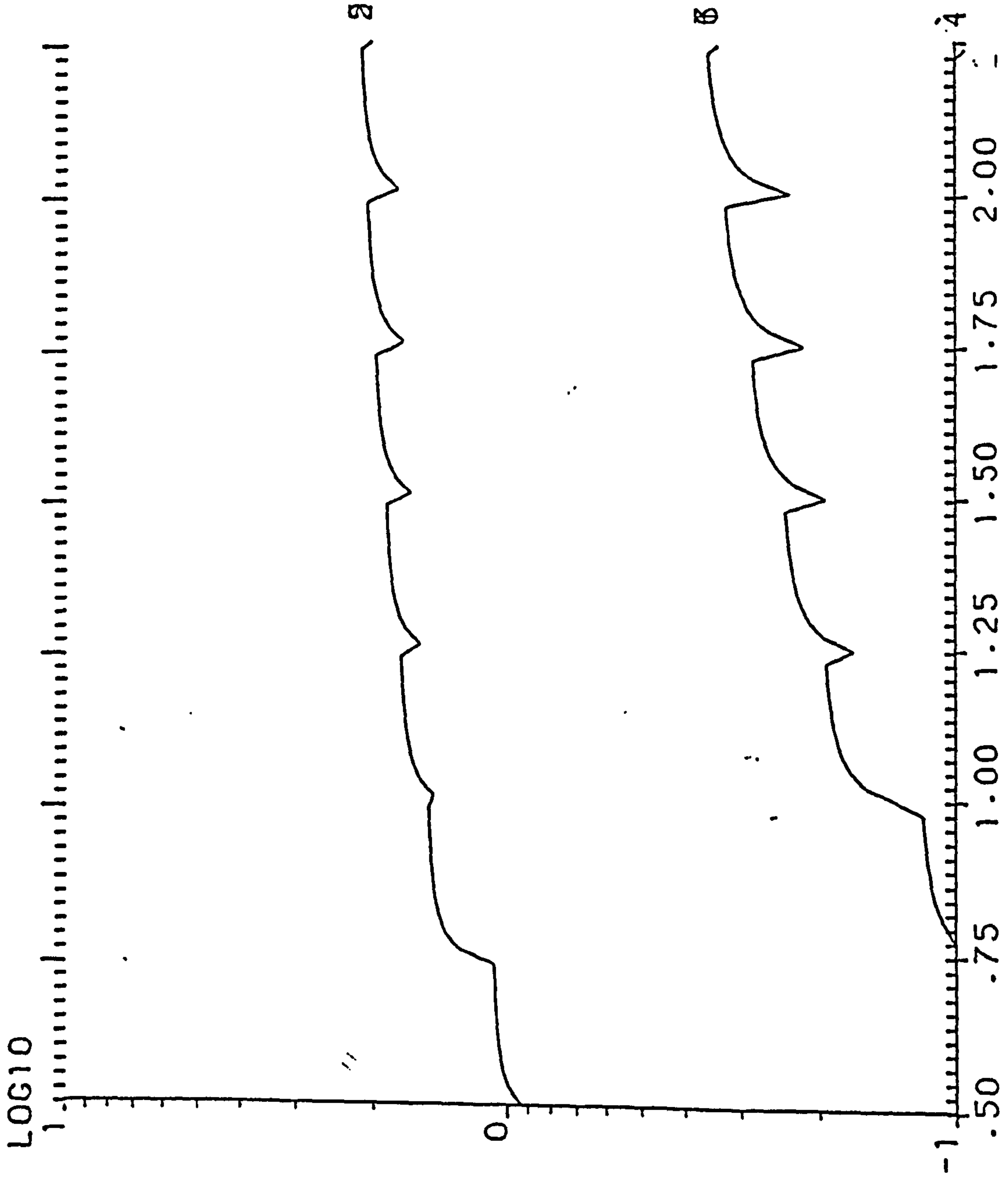

S. EFFICIENCY W. THICKNESS= .24M W. ORIENTATION=292.50  
 WD= 2M HD1= 22M HD2= 8M HOUSE T.=1.5 ST.

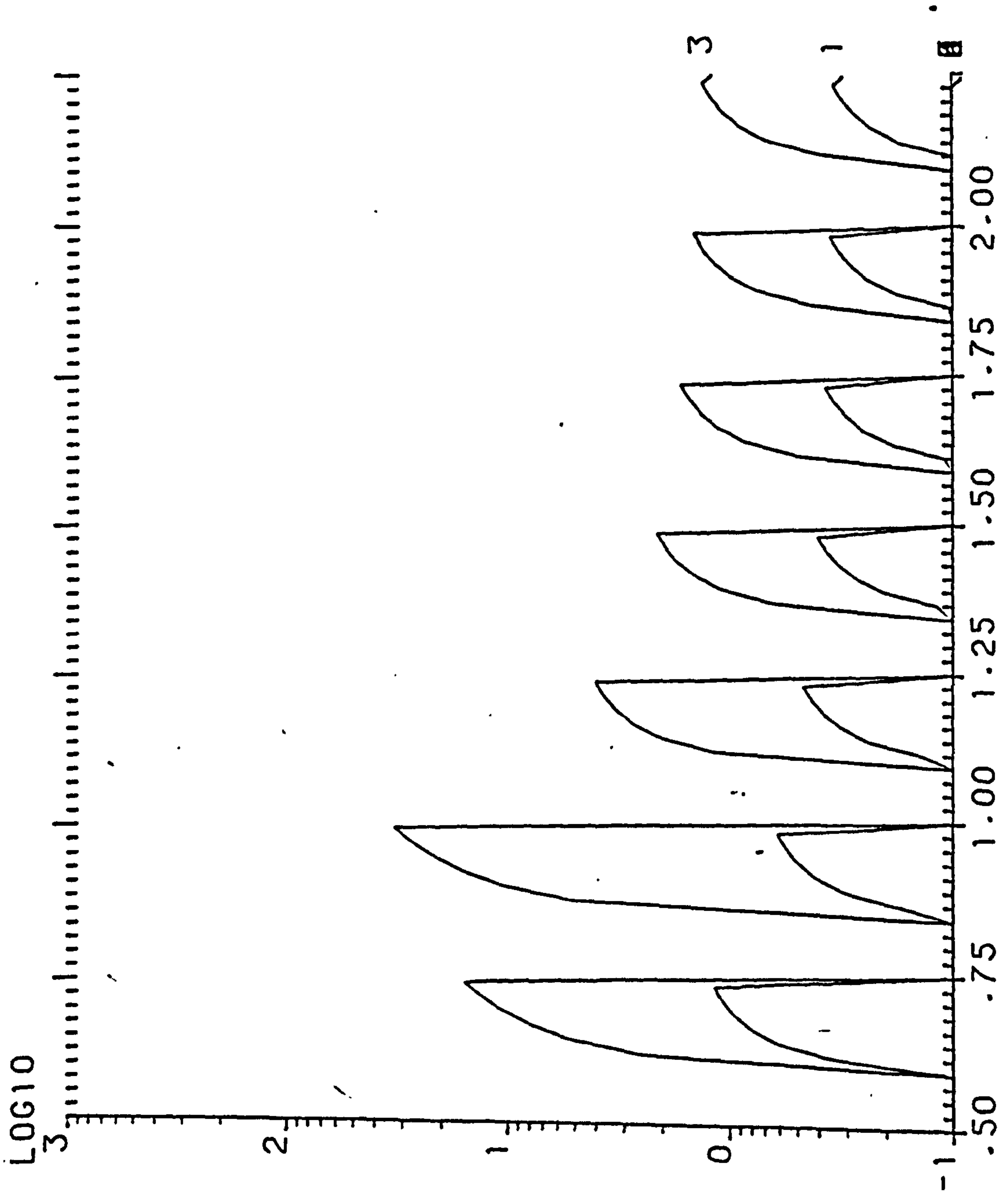

Y. EFFICIENCY W. THICKNESS= .24M W. ORIENTATION=315.00  
WD= 2M HD1= 22M HD2= 8M HOUSE T.=1.5 ST.

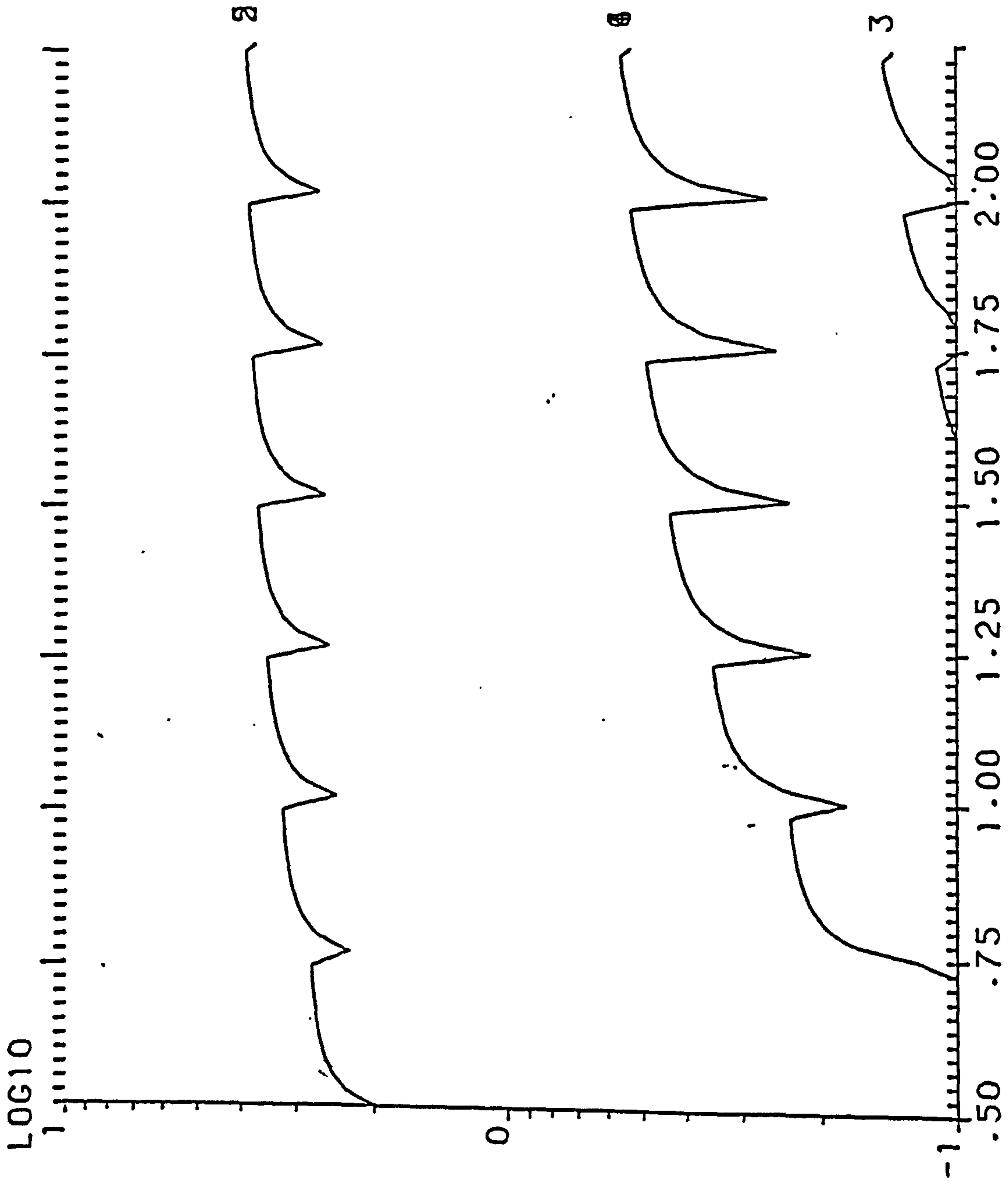

S. EFFICIENCY W. THICKNESS = .24M W. ORIENTATION=315.00

WD= 2M HD1= 22M HD2= 8M HOUSE T.=1.5 ST.



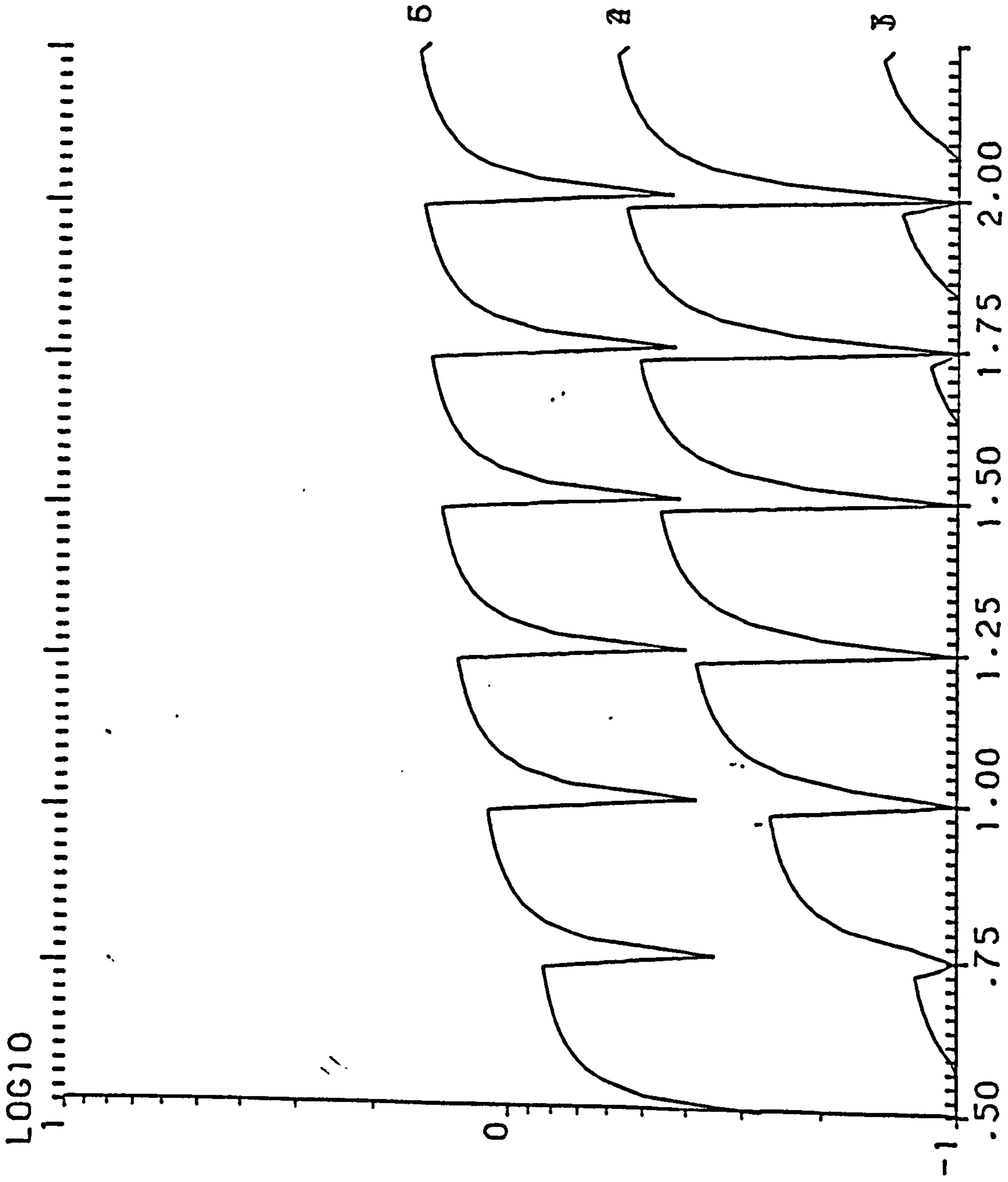

S. EFFICIENCY W. THICKNESS = .24M W. ORIENTATION = 337.50

WD = 2M HD1 = 22M HD2 = 8M HOUSE T. = 1.5 ST.

LOG10  
1  
0  
-1

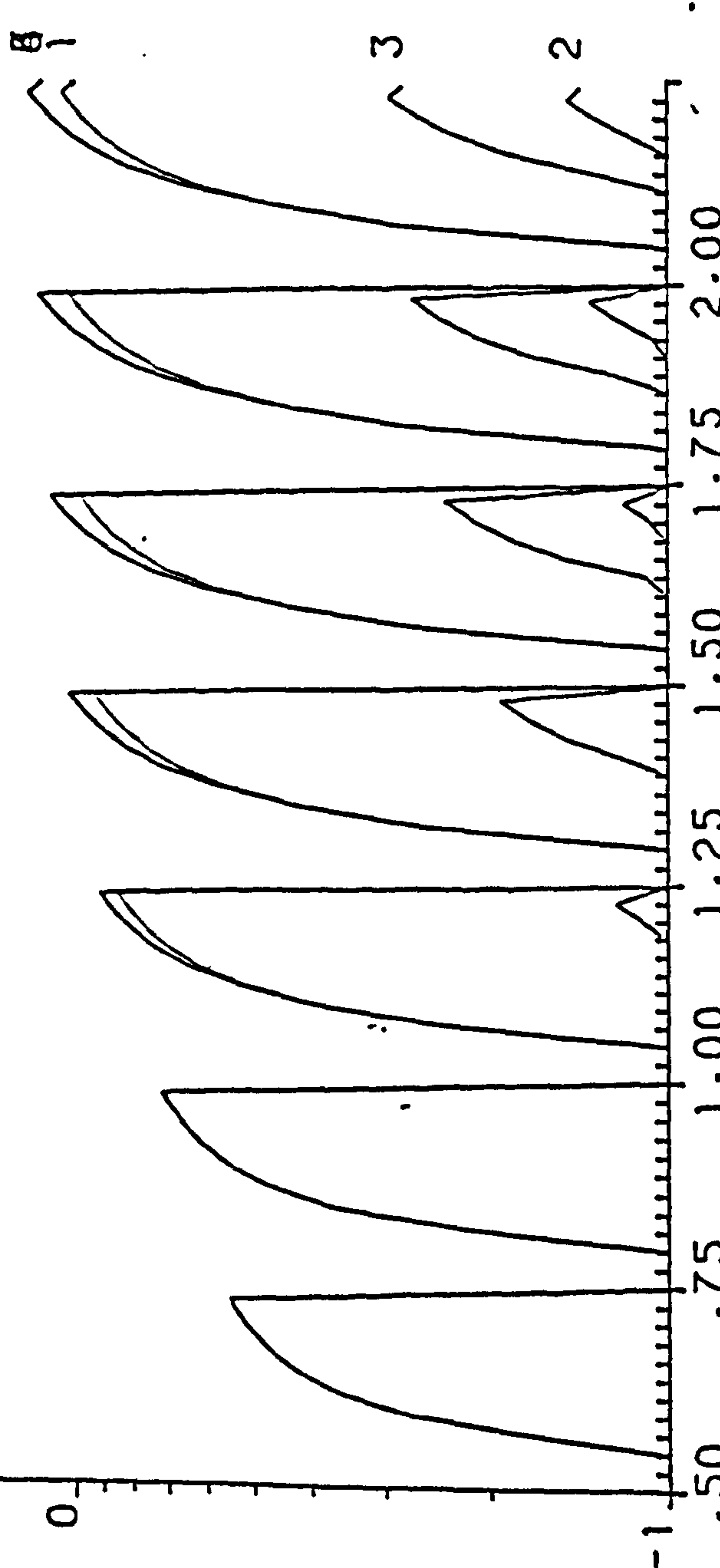

S. EFFICIENCY W. THICKNESS= .36M W. ORIENTATION= .00

WD= 2M HD1= 22M HD2= 8M HOUSE T.=1.5 ST.

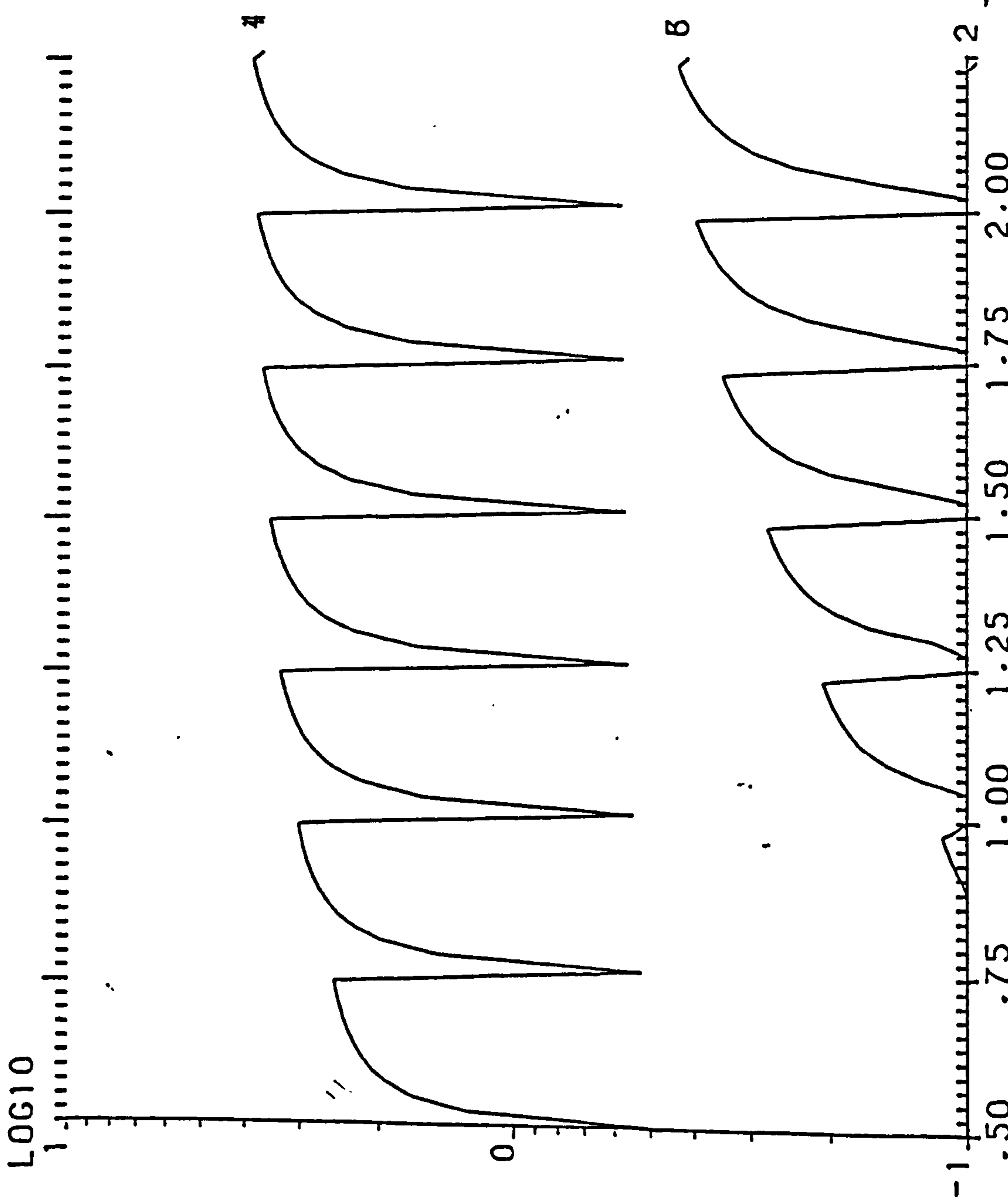

S. EFFICIENCY    W. THICKNESS= .36M    W. ORIENTATION= 22.50  
 WD= 2M    HD1= 22M    HD2= 8M    HOUSE T.=1.5 ST.

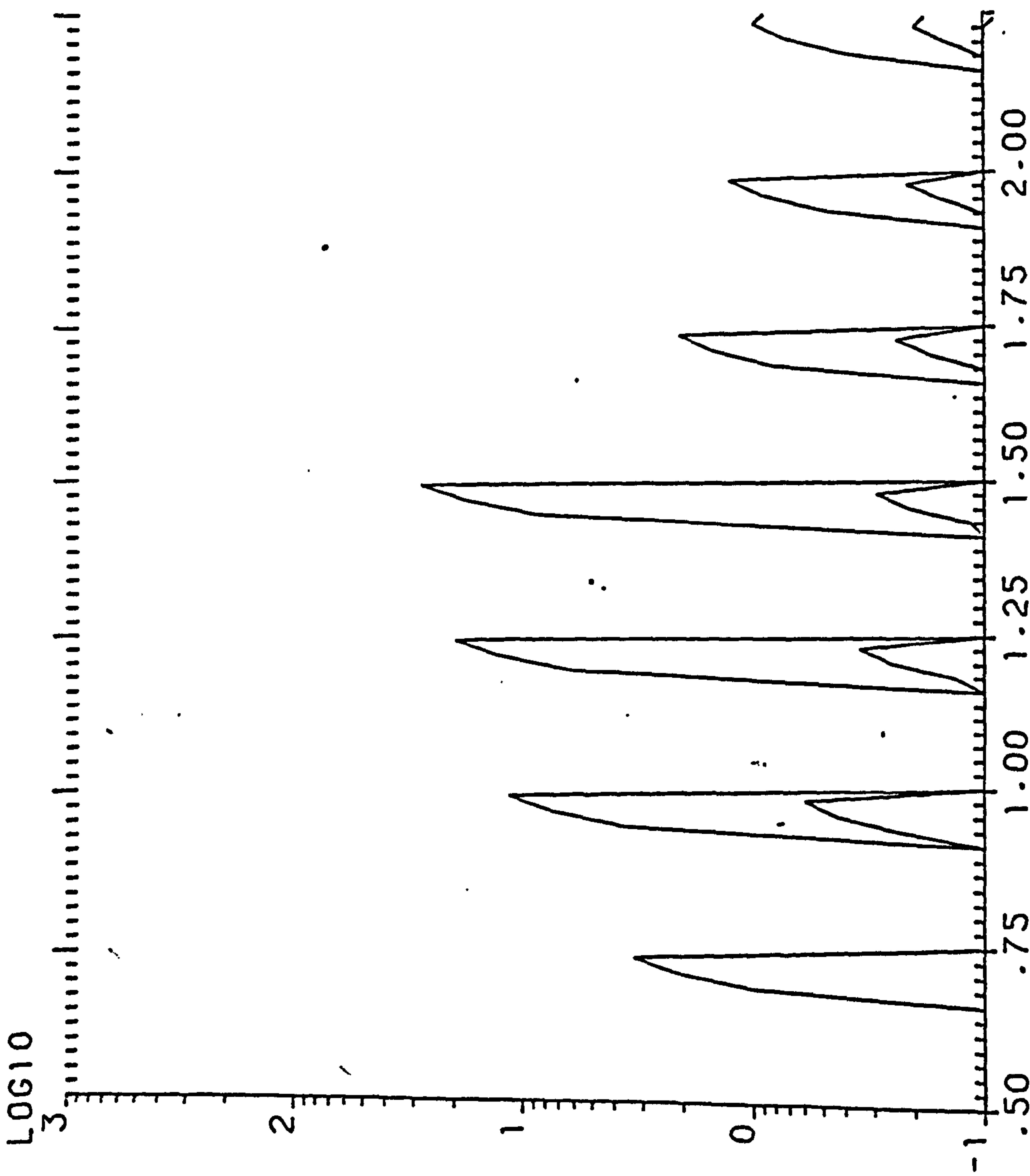

Y. EFFICIENCY W. THICKNESS= .36M W. ORIENTATION= 45.00  
 WD= 2M HD1= 22M HD2= 8M HOUSE T.=1.5 ST.

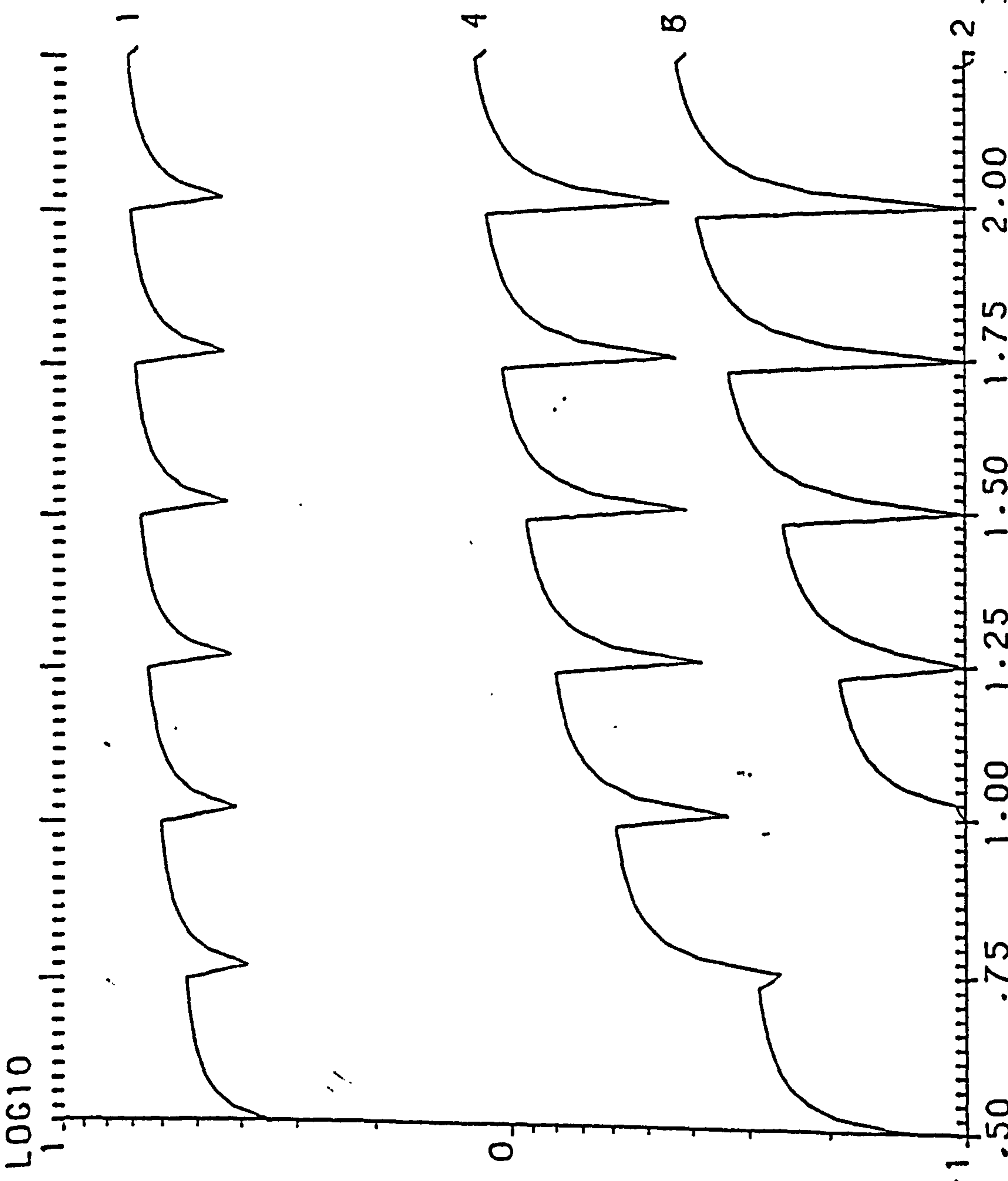

S. EFFICIENCY    W. THICKNESS= .36M    W. ORIENTATION= 45.00

WD= 2M    HD1= 22M    HD2= 8M    HOUSE T.=1.5 ST.





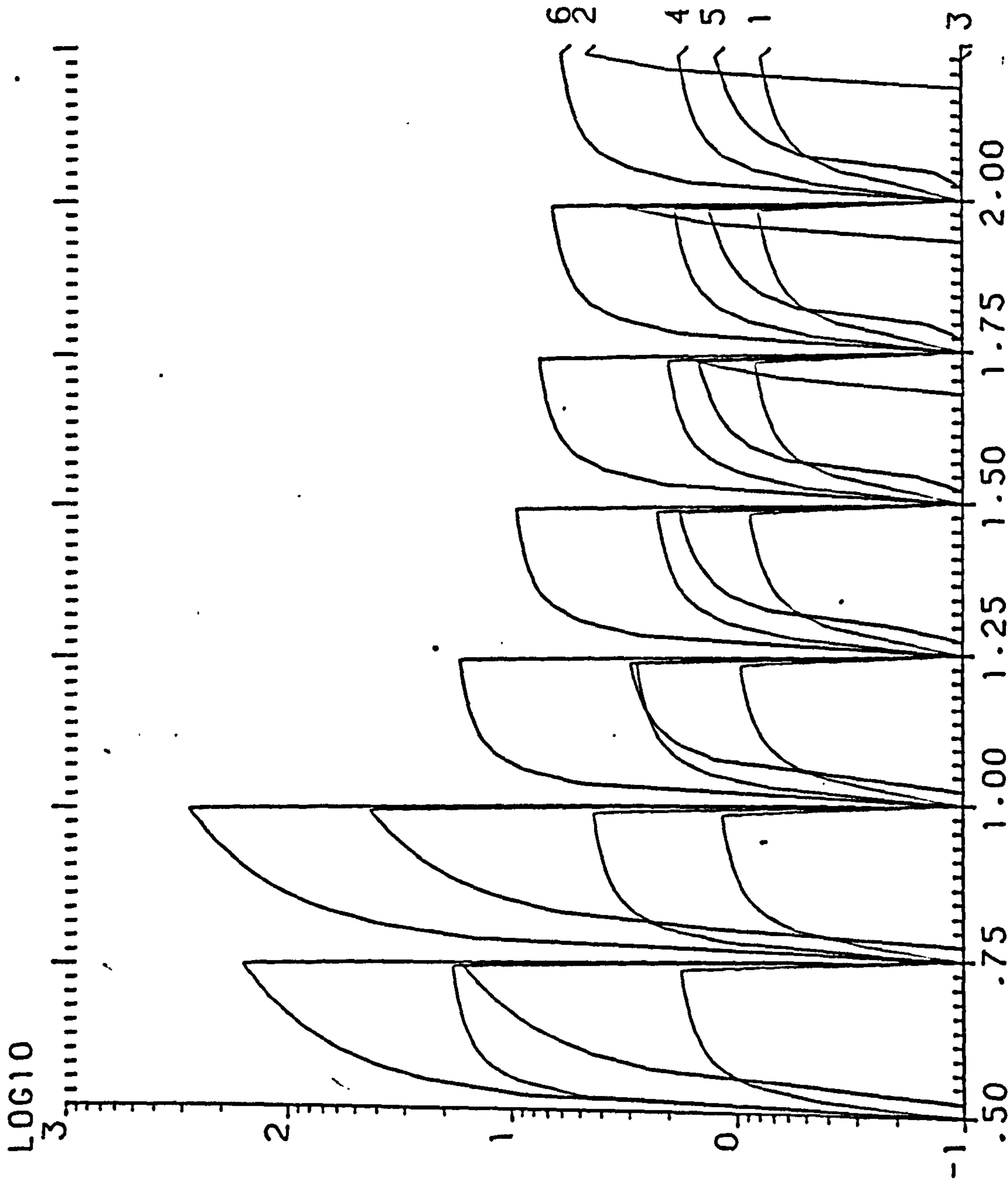

Y. EFFICIENCY W. THICKNESS= .36M W. ORIENTATION= 67.50

WD= 2M HD1= 22M HD2= 8M HOUSE T.=1.5 ST.

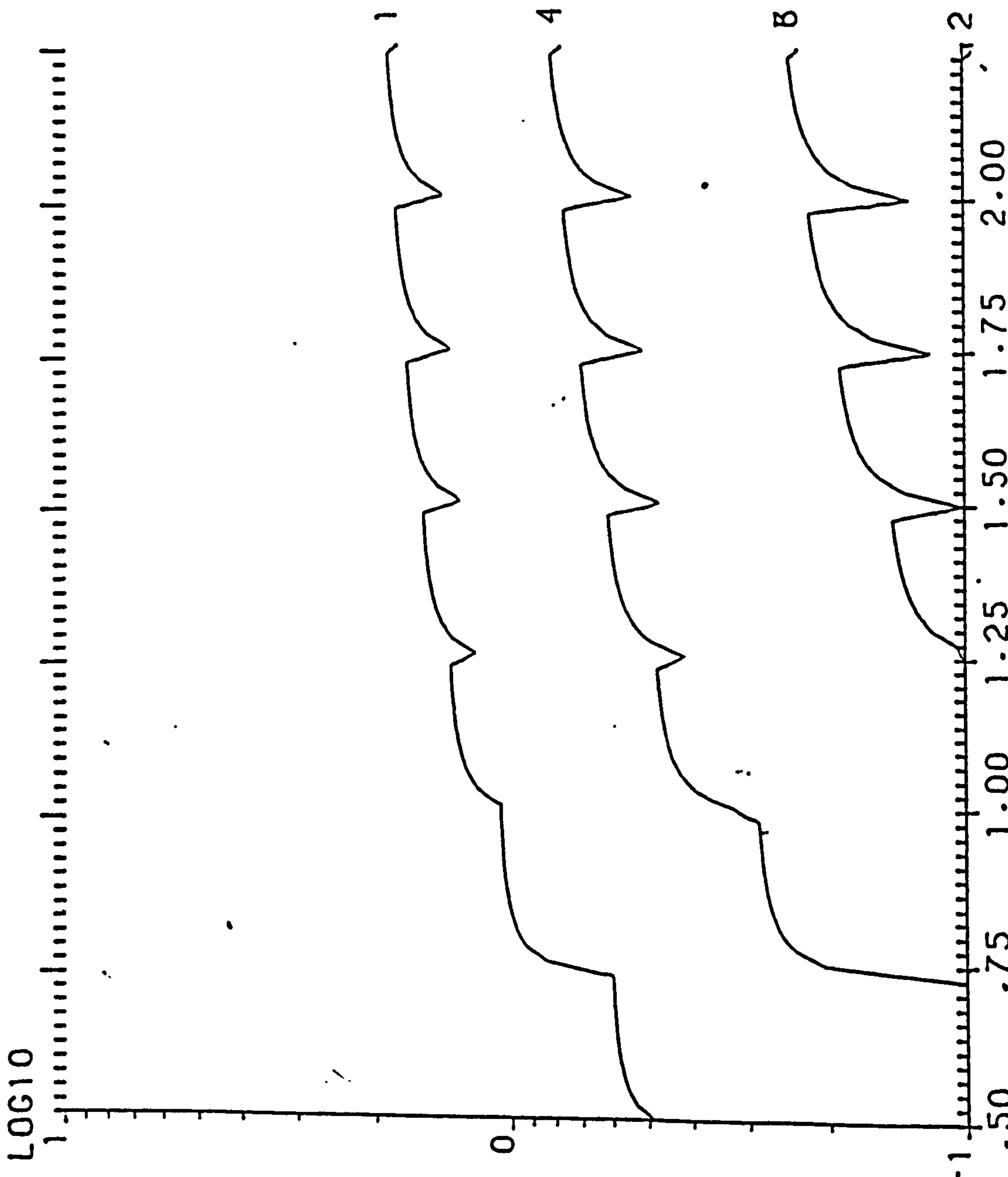

S. EFFICIENCY W. THICKNESS= .36M W. ORIENTATION= 67.50  
 WD= 2M HD1= 22M HD2= 8M HOUSE T.=1.5 ST.

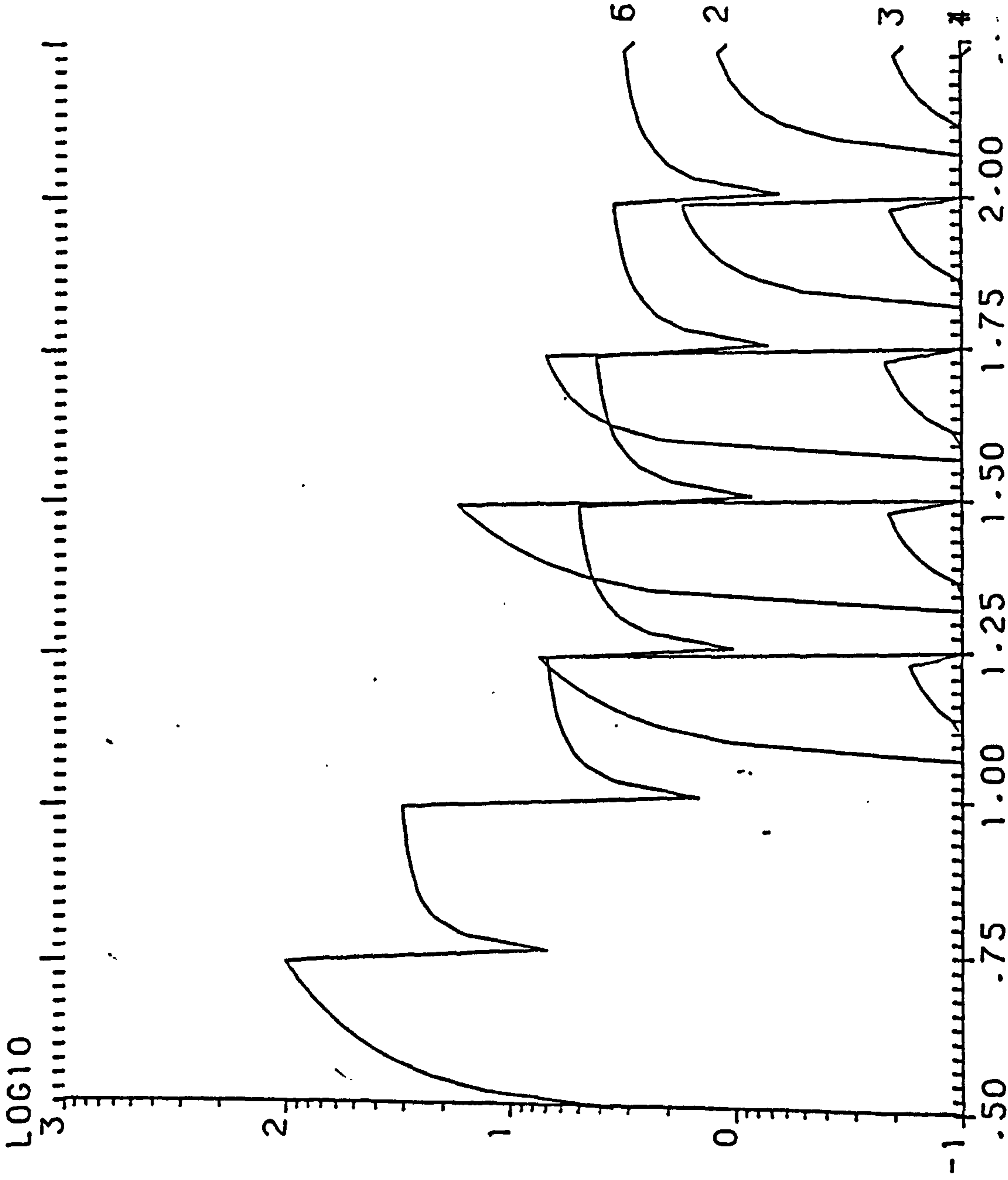

Y. EFFICIENCY W. THICKNESS= .36M W. ORIENTATION= 90.00

WD= 2M HD1= 22M HD2= 8M HOUSE T.=1.5 ST.

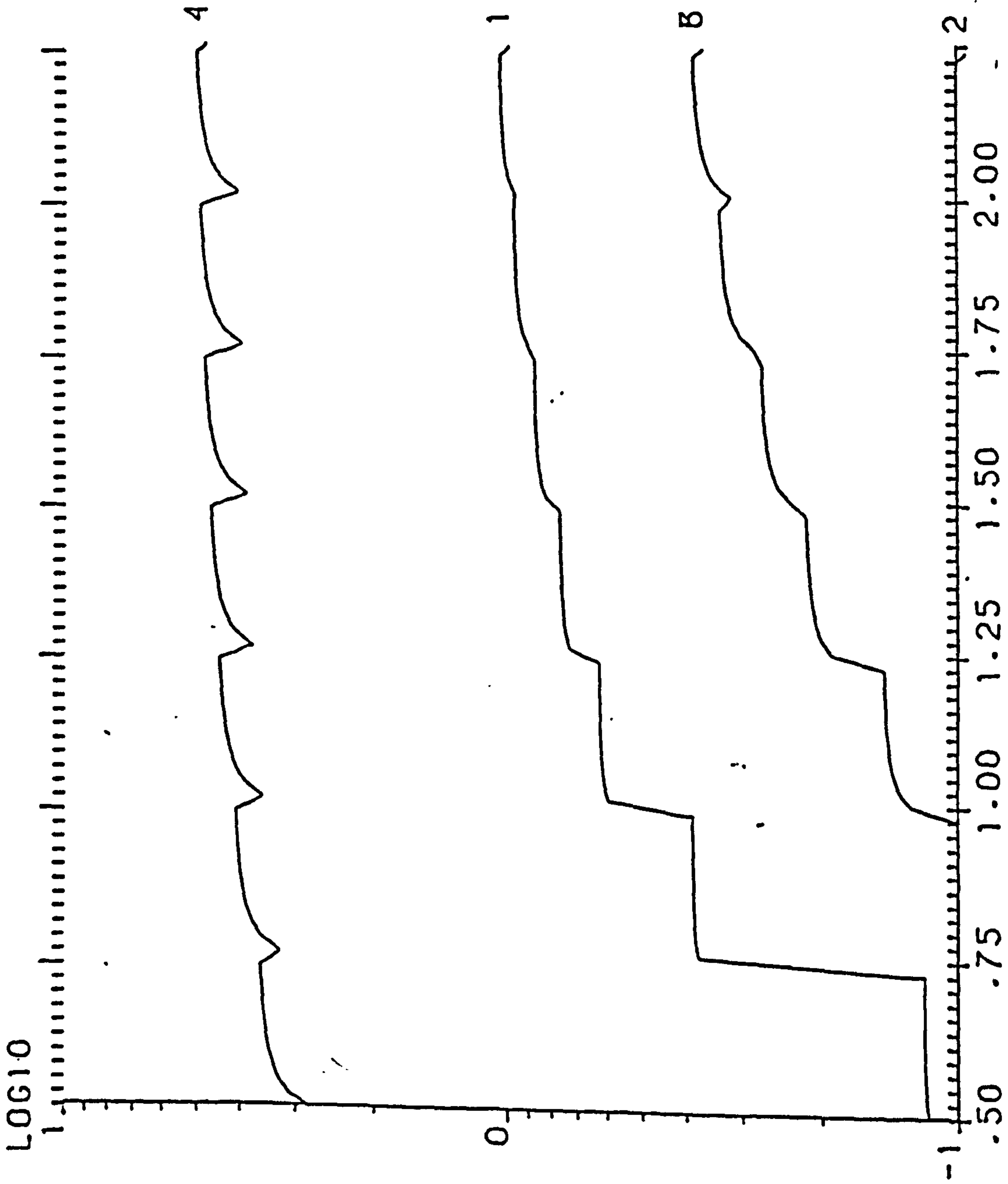

S. EFFICIENCY W. THICKNESS= .36M W. ORIENTATION= 90.00  
 WD= 2M HD1= 22M HD2= 8M HOUSE T.=1.5 ST.

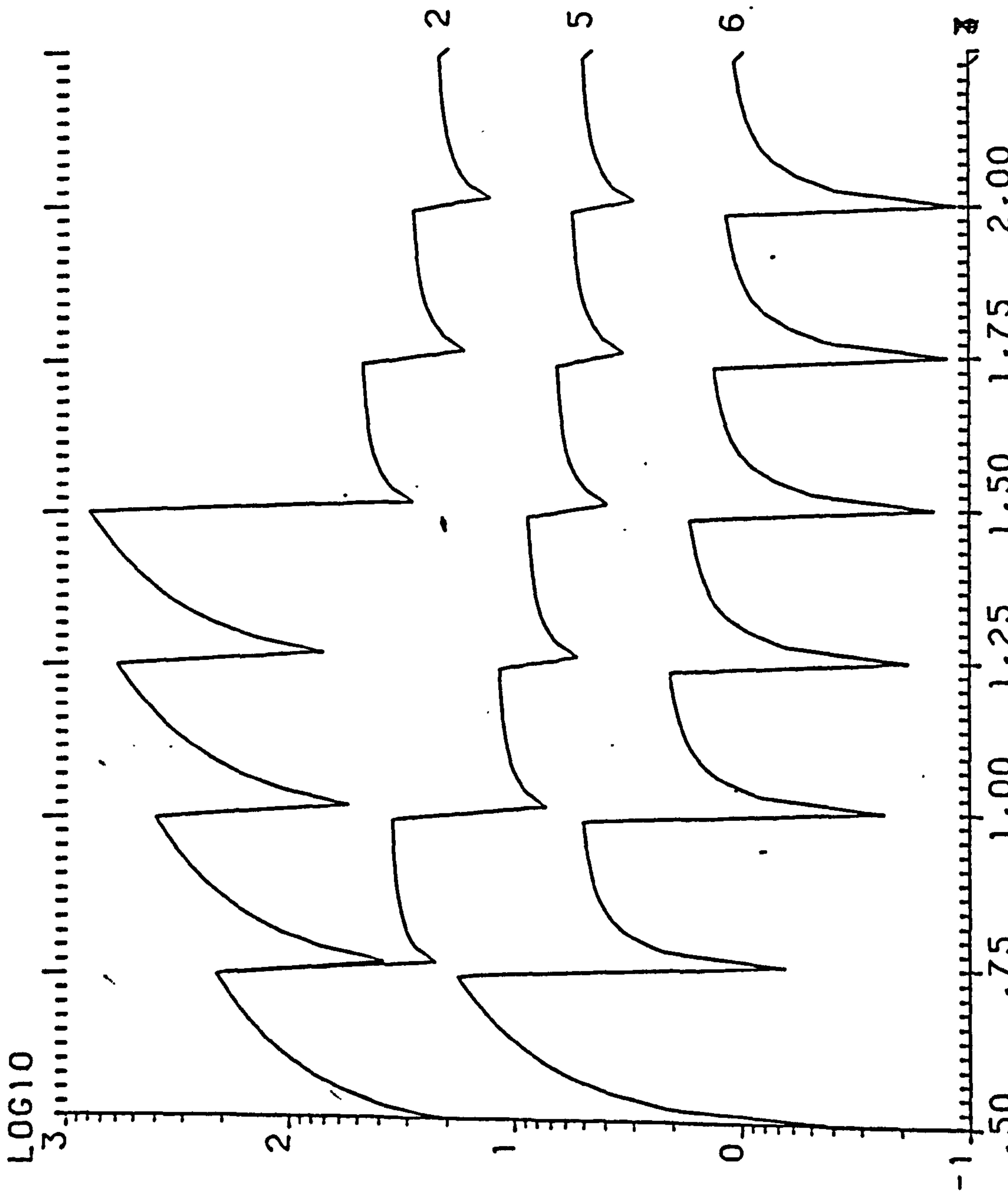

Y. EFFICIENCY W. THICKNESS= .36M W. ORIENTATION=112.50

WD= 2M HD1= 22M HD2= 8M HOUSE T.=1.5 ST.



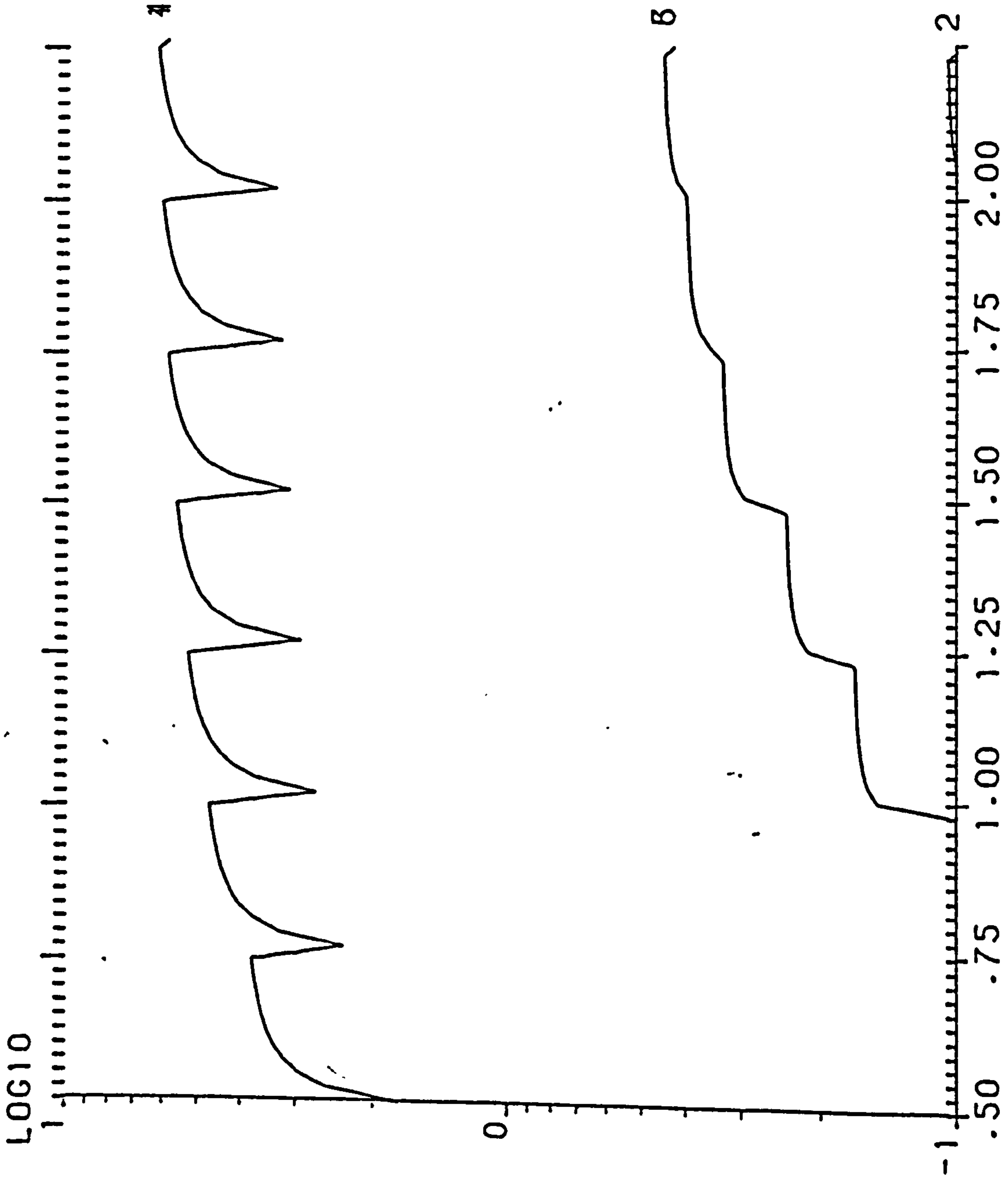

S. EFFICIENCY W. THICKNESS= .36M W. ORIENTATION=112.50

WD= 2M HD1= 22M HD2= 8M HOUSE T.=1.5 ST.



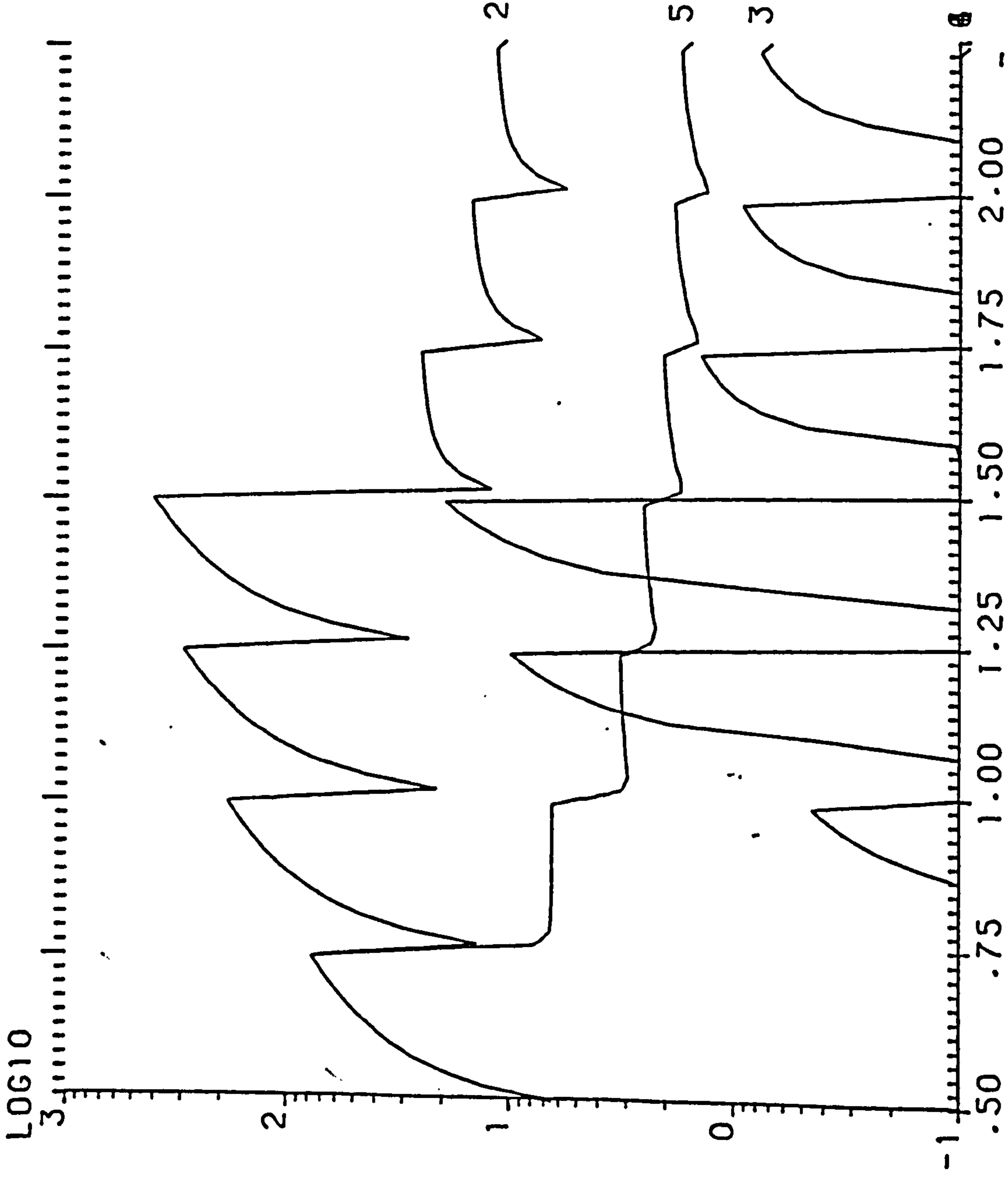

Y. EFFICIENCY W. THICKNESS= .36M W. ORIENTATION=135.00

WD= 2M HD1= 22M HD2= 8M HOUSE T.=1.5 ST.

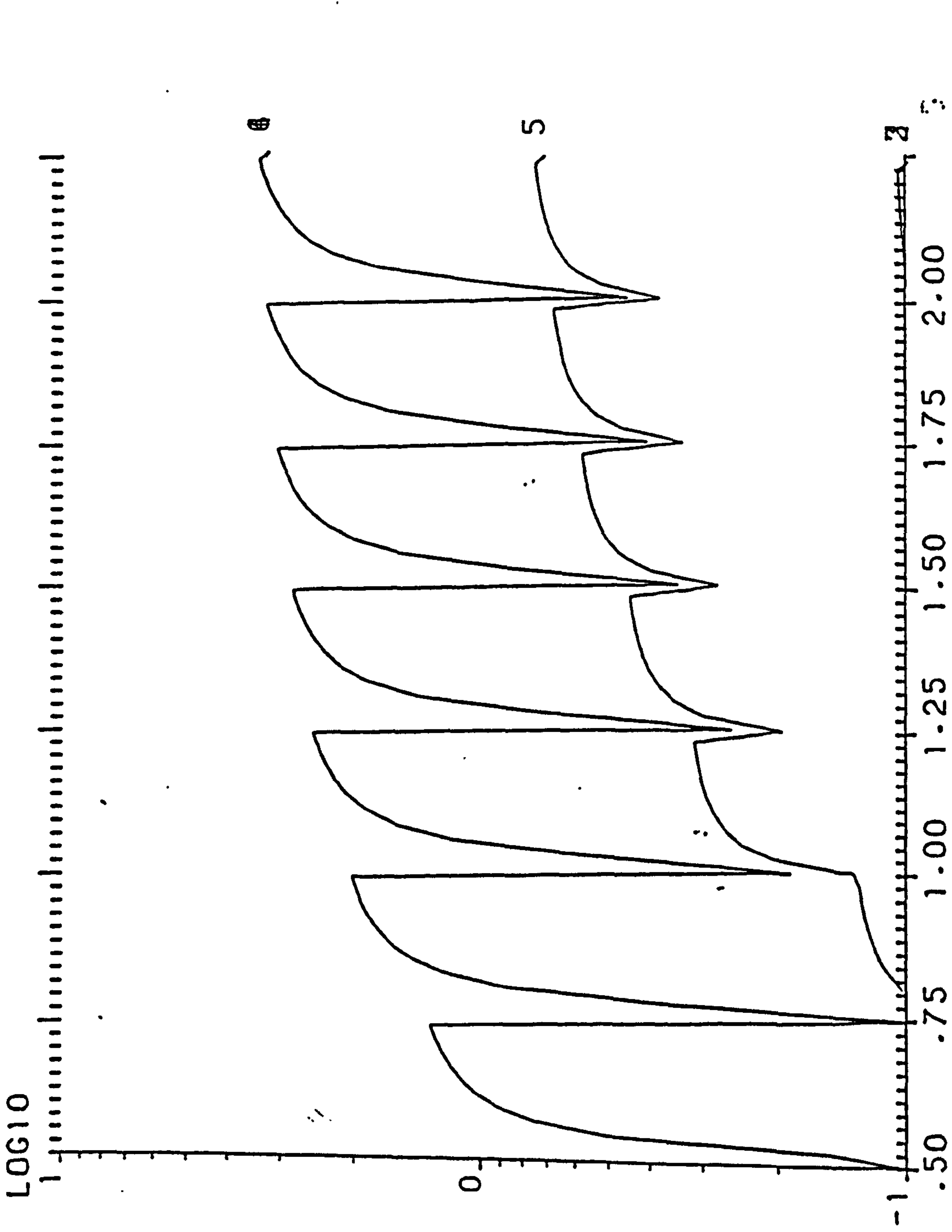

S. EFFICIENCY W. THICKNESS= .36M W. ORIENTATION=135.00

WD= 2M HD1= 22M HD2= 8M HOUSE T.=1.5 ST.

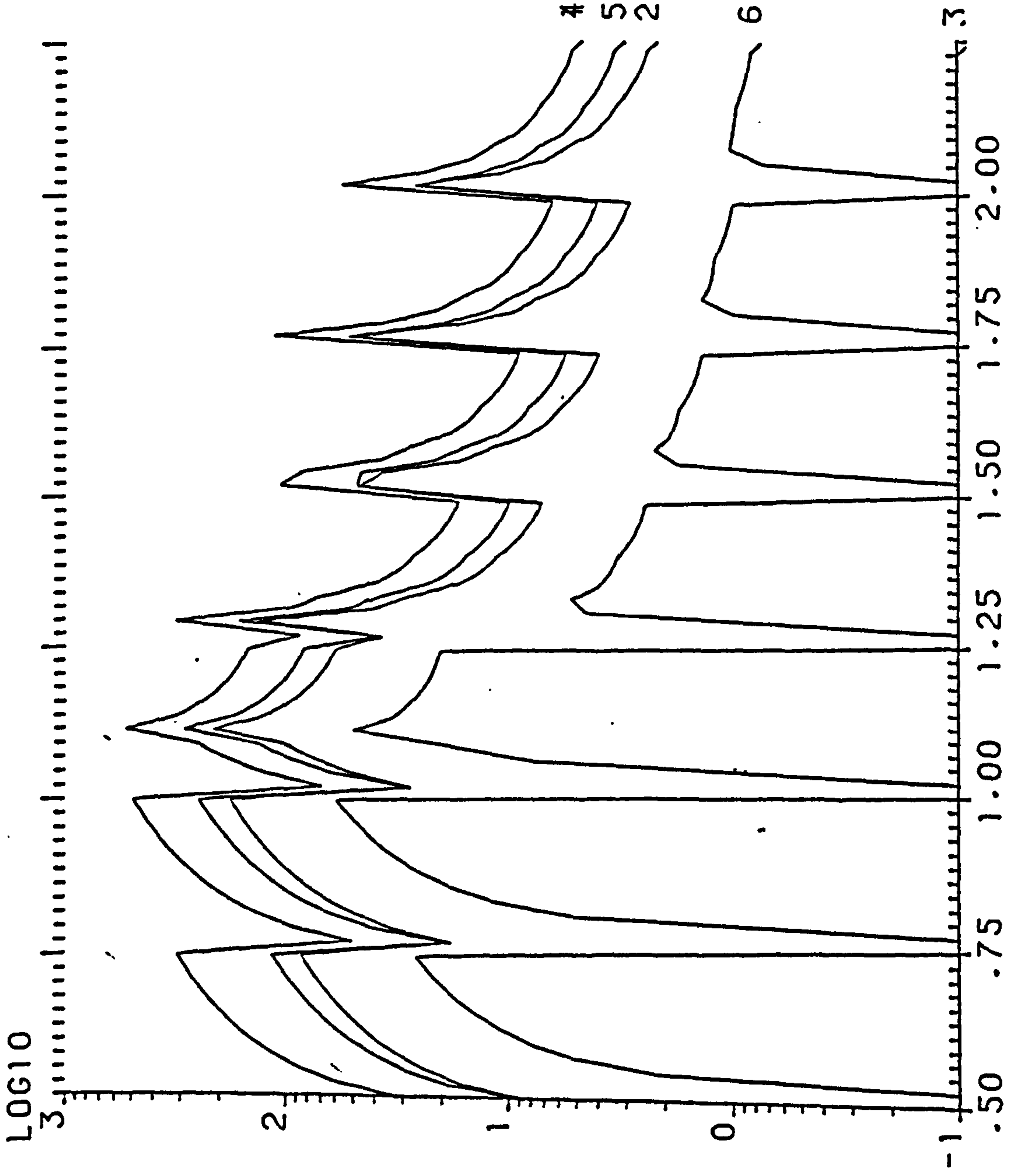

Y. EFFICIENCY W. THICKNESS = .36M W. ORIENTATION=157.50

WD= 2M HD1= 22M HD2= 8M HOUSE T.=1.5 ST.

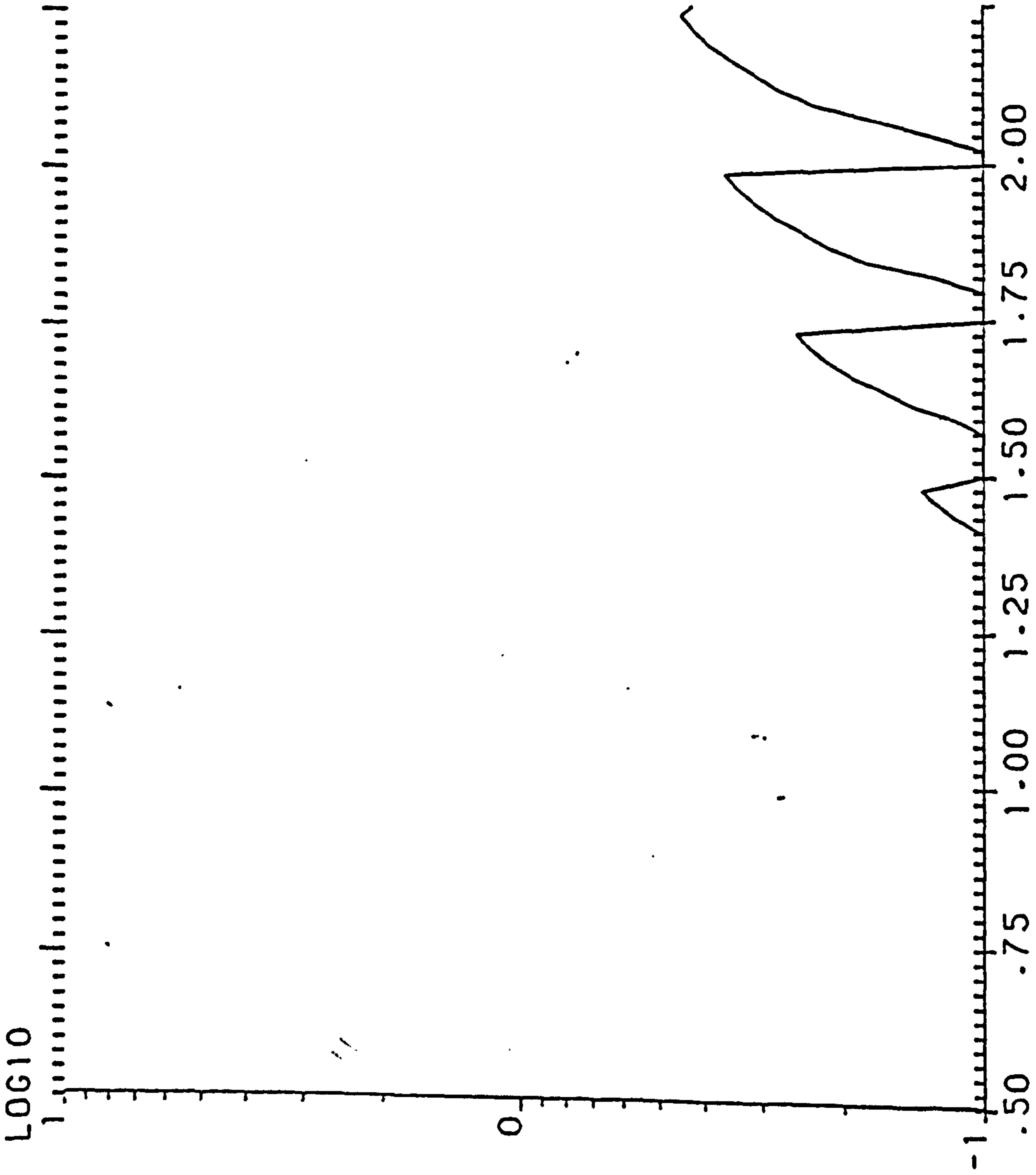

S. EFFICIENCY W. THICKNESS= .36M W. ORIENTATION=157.50

WD= 2M HD1= 22M HD2= 8M HOUSE T.=1.5 ST.





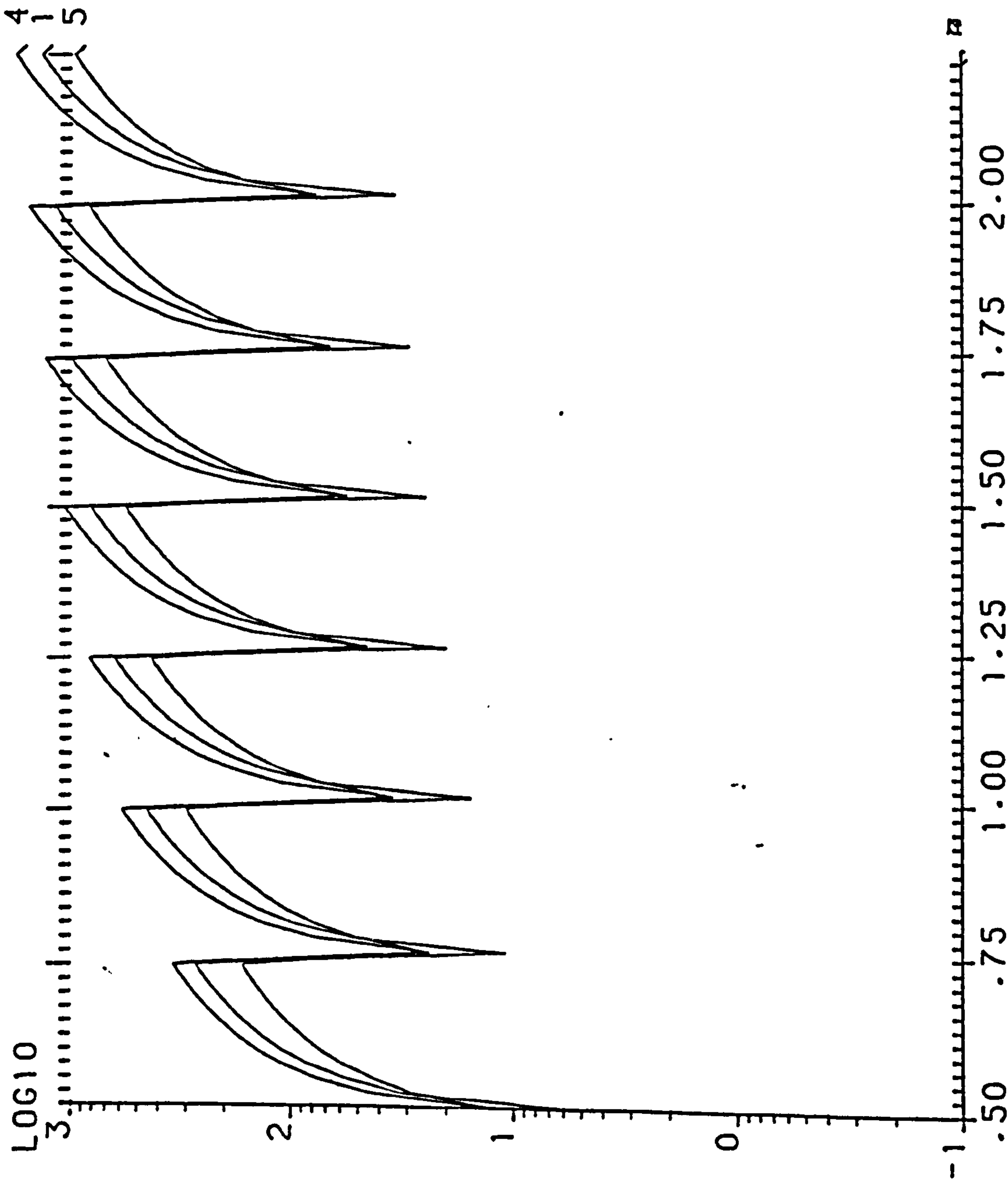

Y. EFFICIENCY W. THICKNESS= .36M W. ORIENTATION=180.00

WD= 2M HD1= 22M HD2= 8M HOUSE T.=1.5 ST.

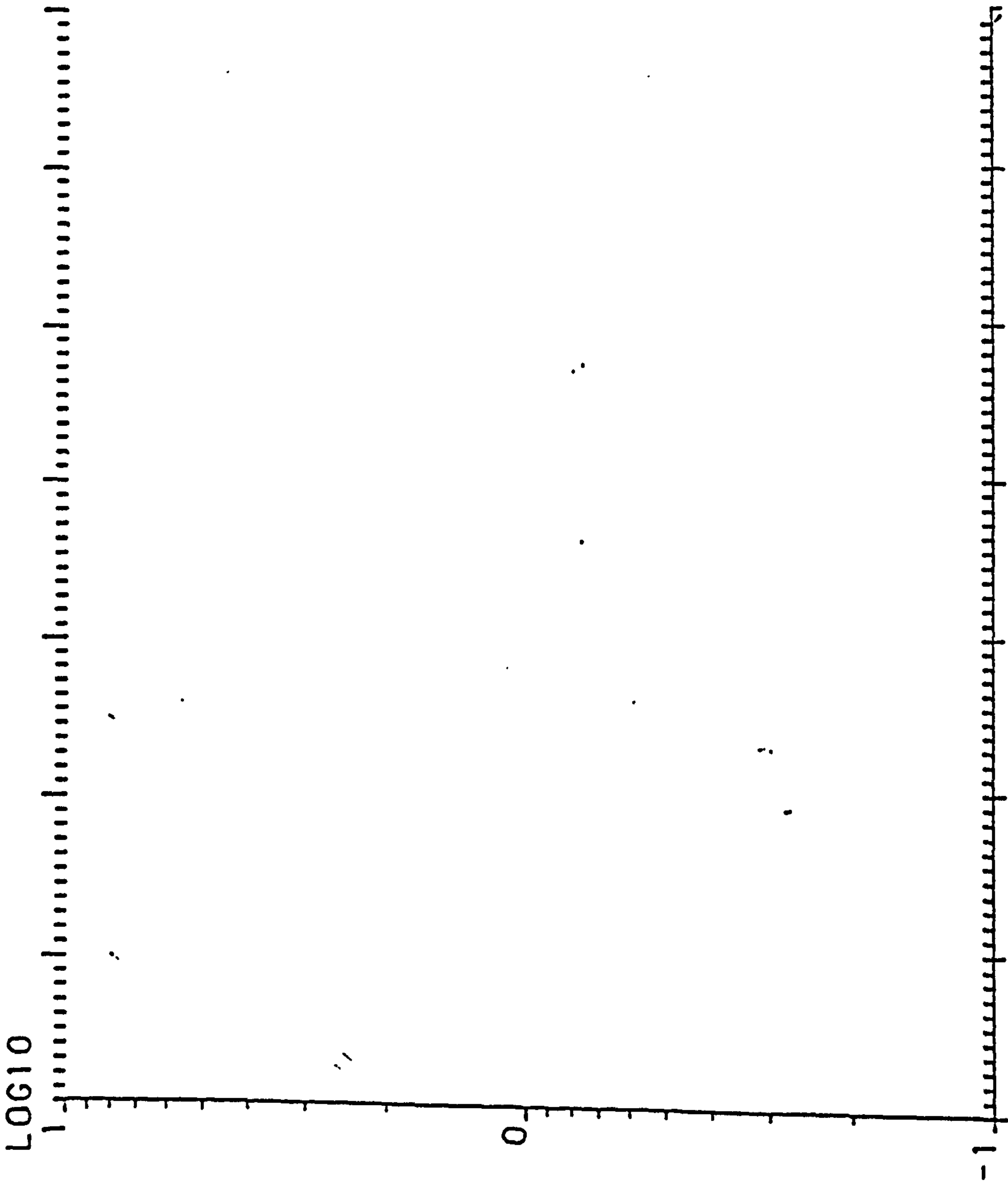

S. EFFICIENCY W. THICKNESS= .36M W. ORIENTATION=180.00

WD= 2M HD1= 22M HD2= 8M HOUSE T.=1.5 ST.



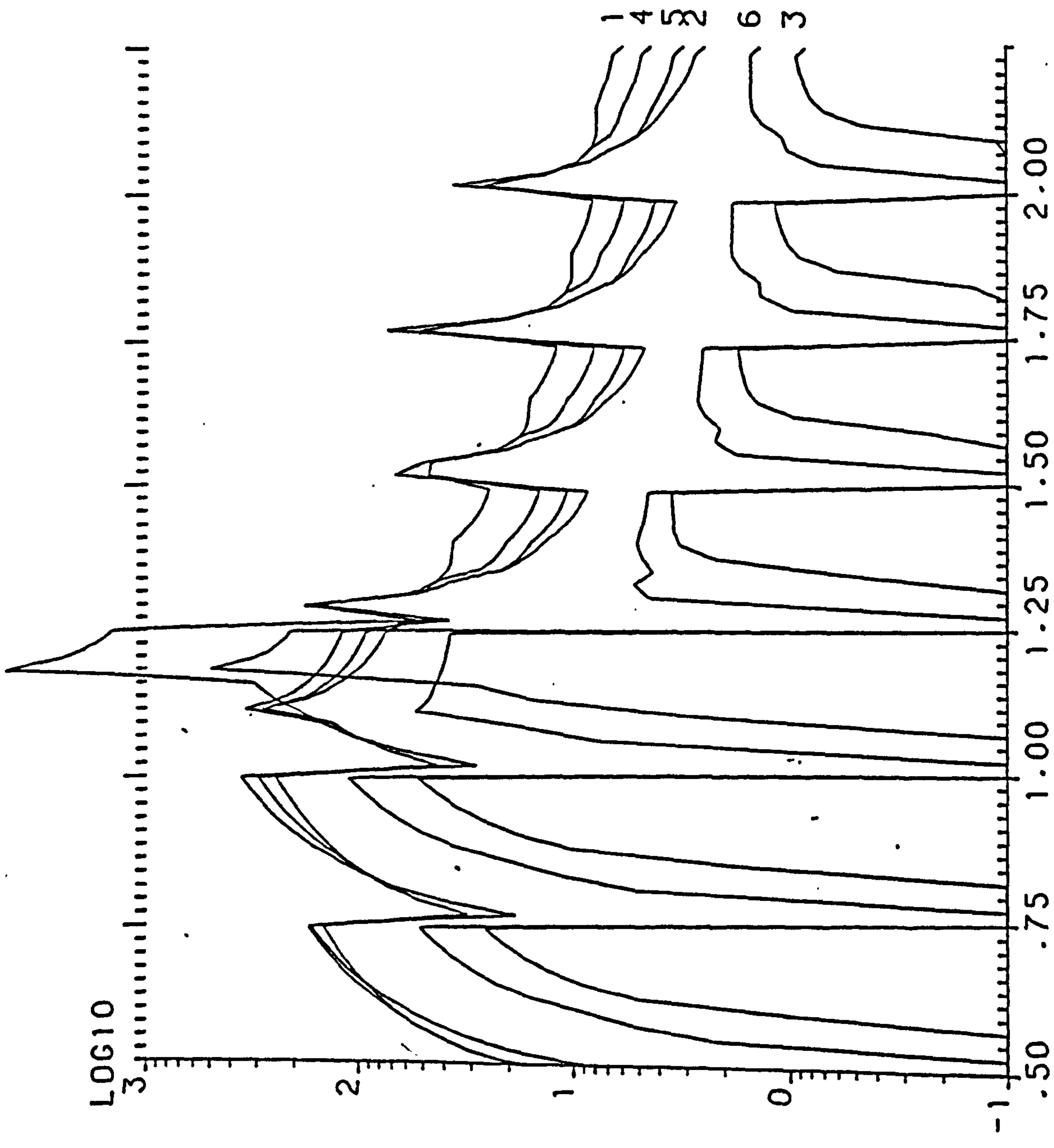

Y. EFFICIENCY W. THICKNESS= .36M W. ORIENTATION=202.50  
WD= 2M HD1= 22M HD2= 8M HOUSE T.=1.5 ST.

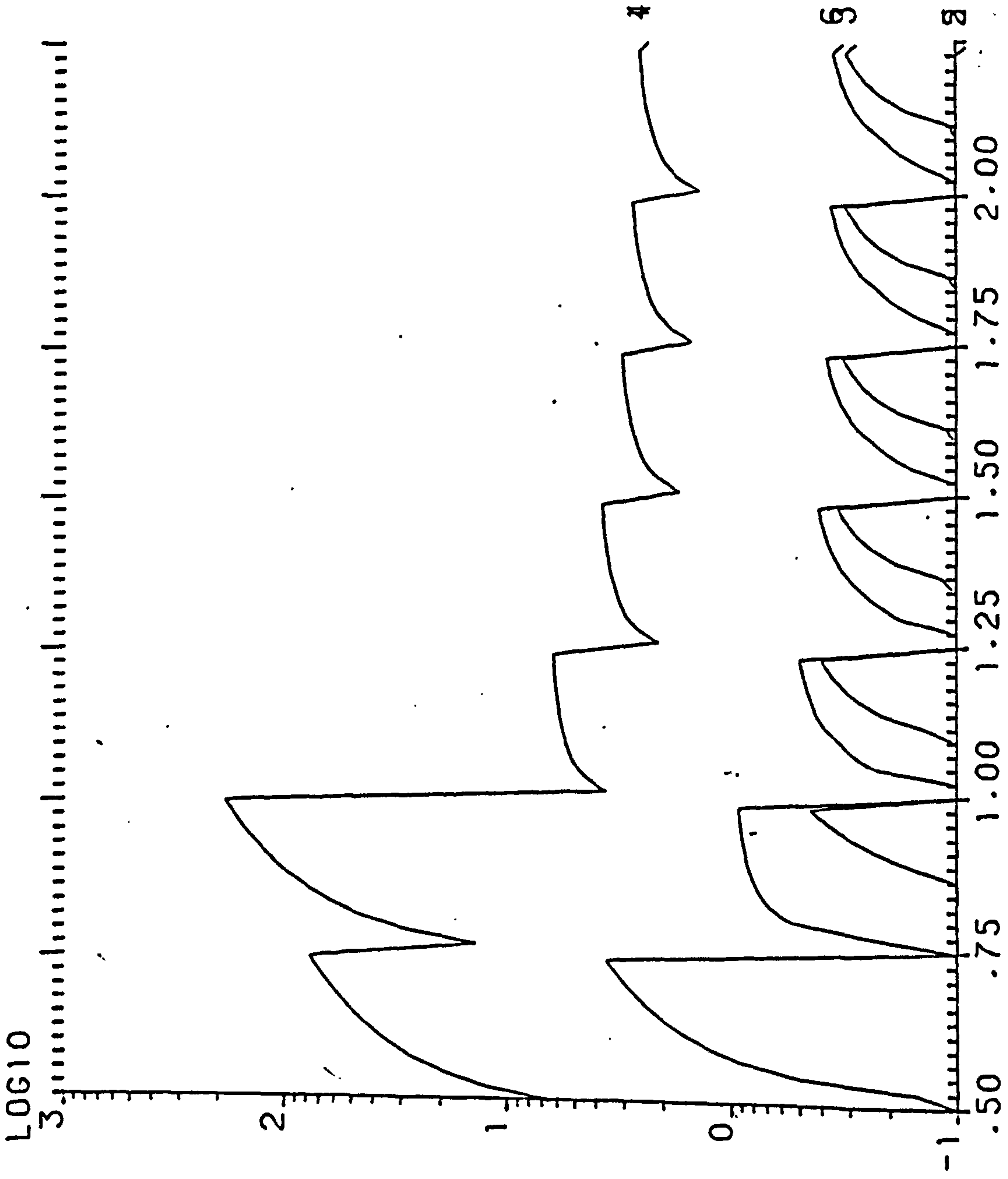

Y. EFFICIENCY    W. THICKNESS=    .36M    W. ORIENTATION=225.00

WD= 2M    HD1= 22M    HD2= 8M    HOUSE T.=1.5 ST.

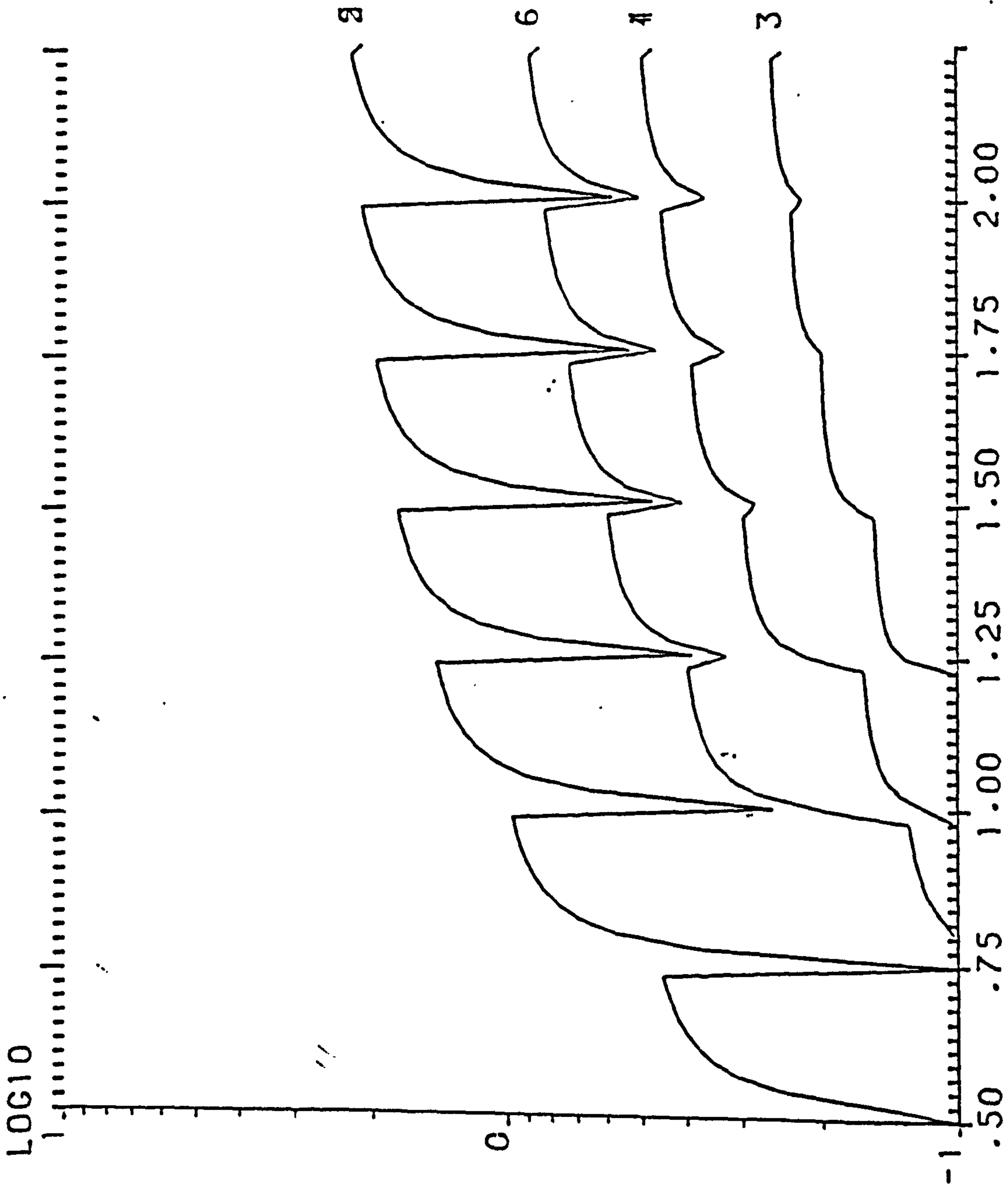

S. EFFICIENCY W. THICKNESS= .36M W. ORIENTATION=225.00

WD= 2M HD1= 22M HD2= 8M HOUSE T.=1.5 ST.





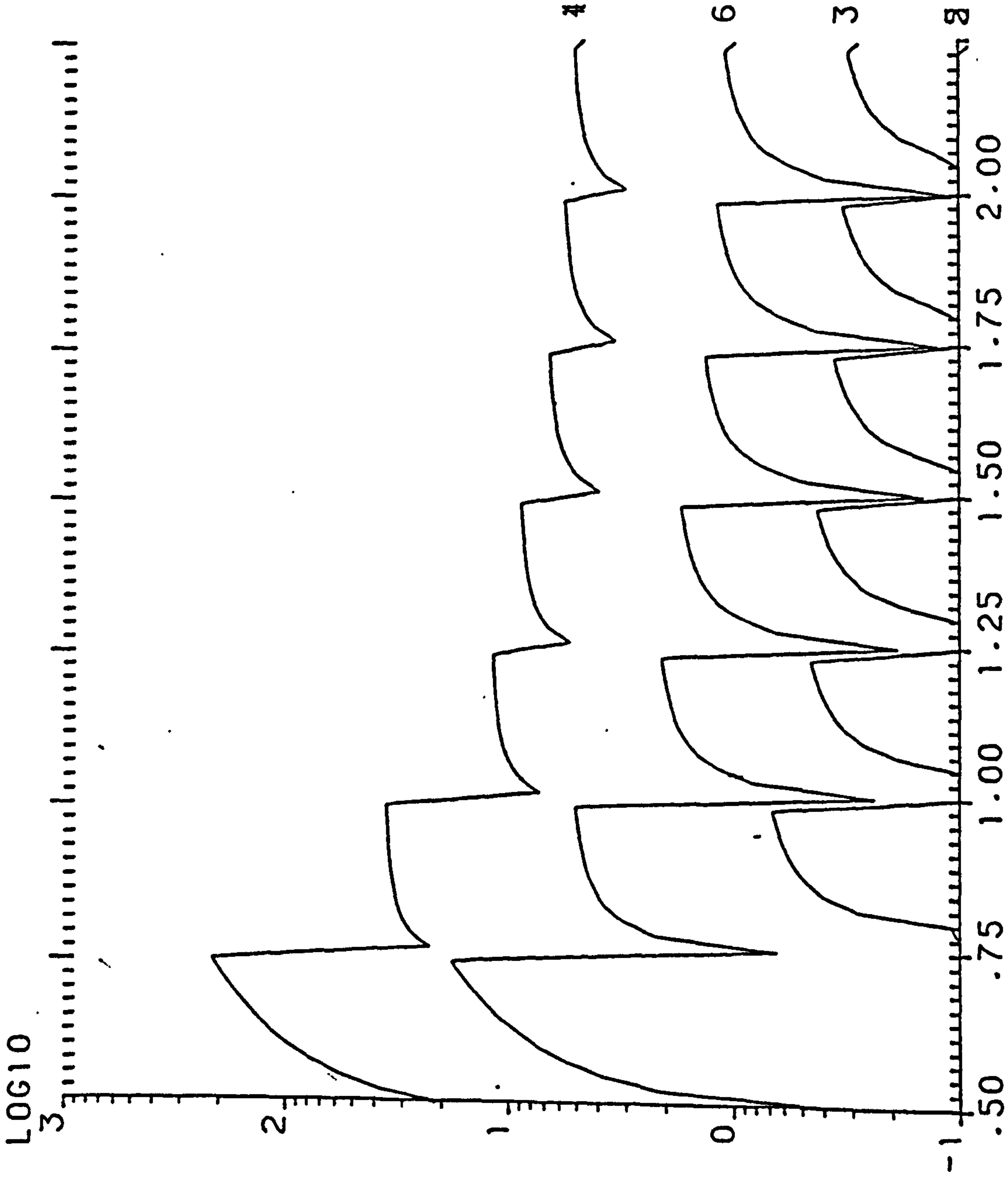

Y. EFFICIENCY    W. THICKNESS=    .36M    W. ORIENTATION=247.50

WD= 2M    HD1= 22M    HD2= 8M    HOUSE T.=1.5 ST.

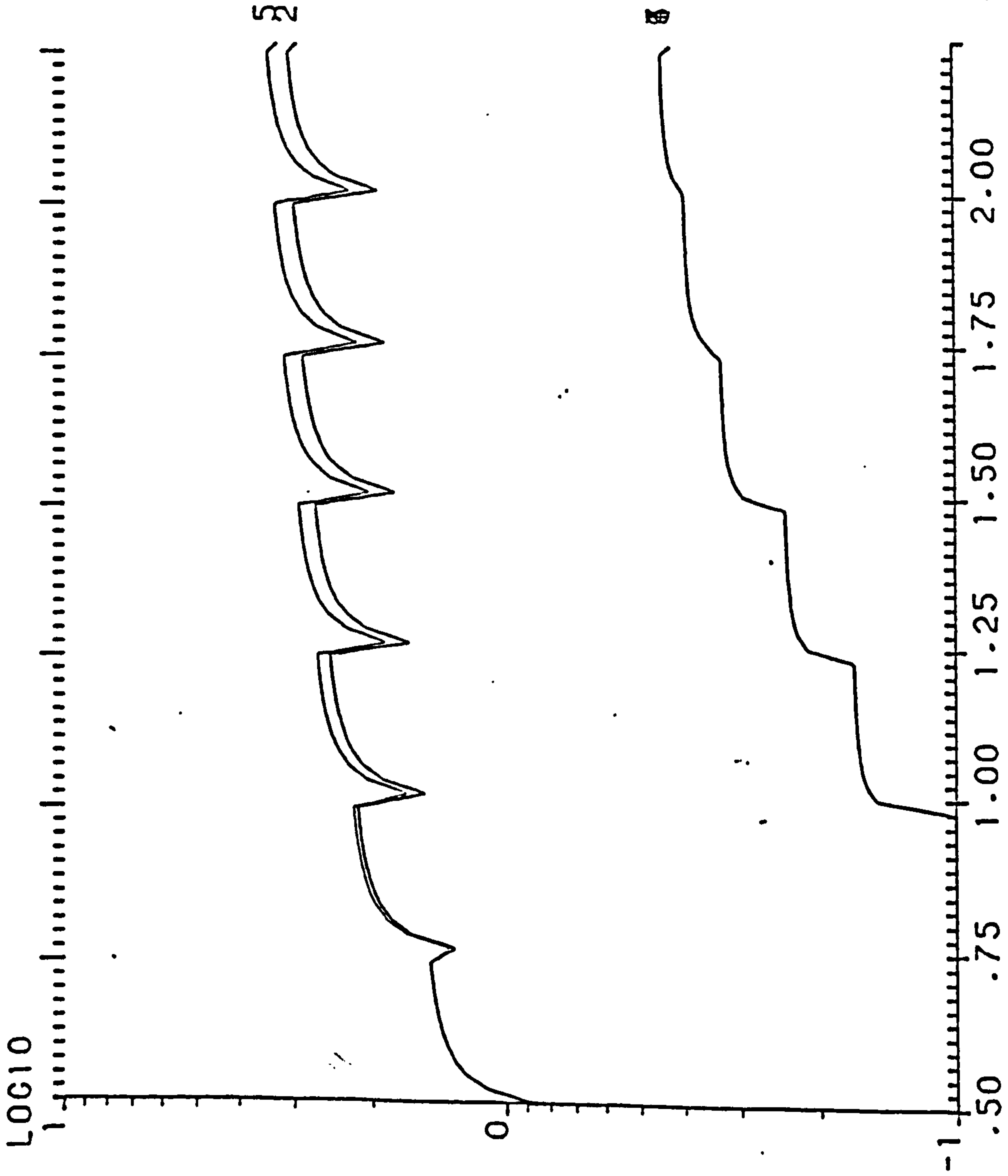

S. EFFICIENCY W. THICKNESS= .36M W. ORIENTATION=247.50

WD= 2M HD1= 22M HD2= 8M HOUSE T.=1.5 ST.



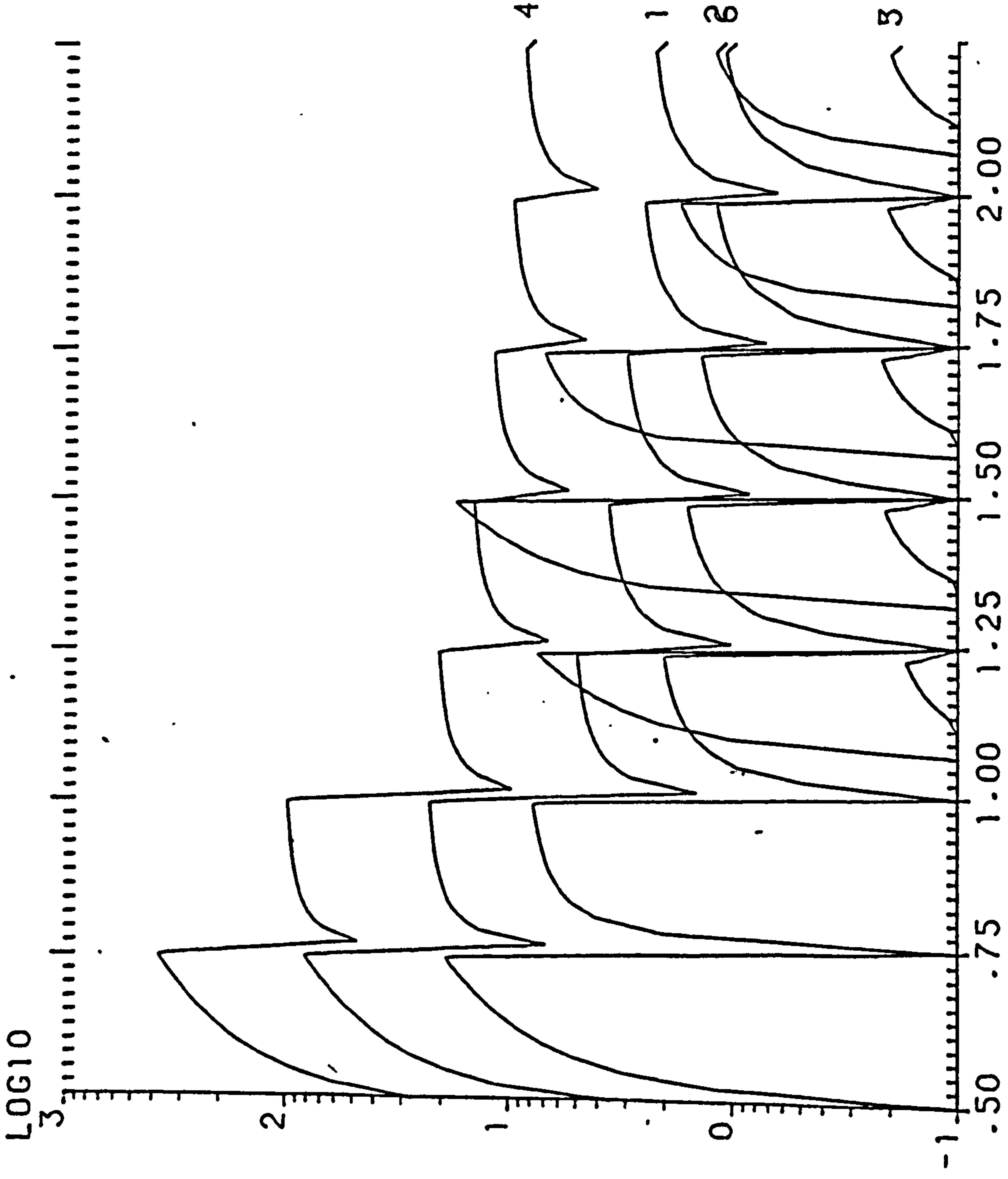

Y. EFFICIENCY W. THICKNESS= .36M W. ORIENTATION=270.00

WD= 2M HD1= 22M HD2= 8M HOUSE T.=1.5 ST.

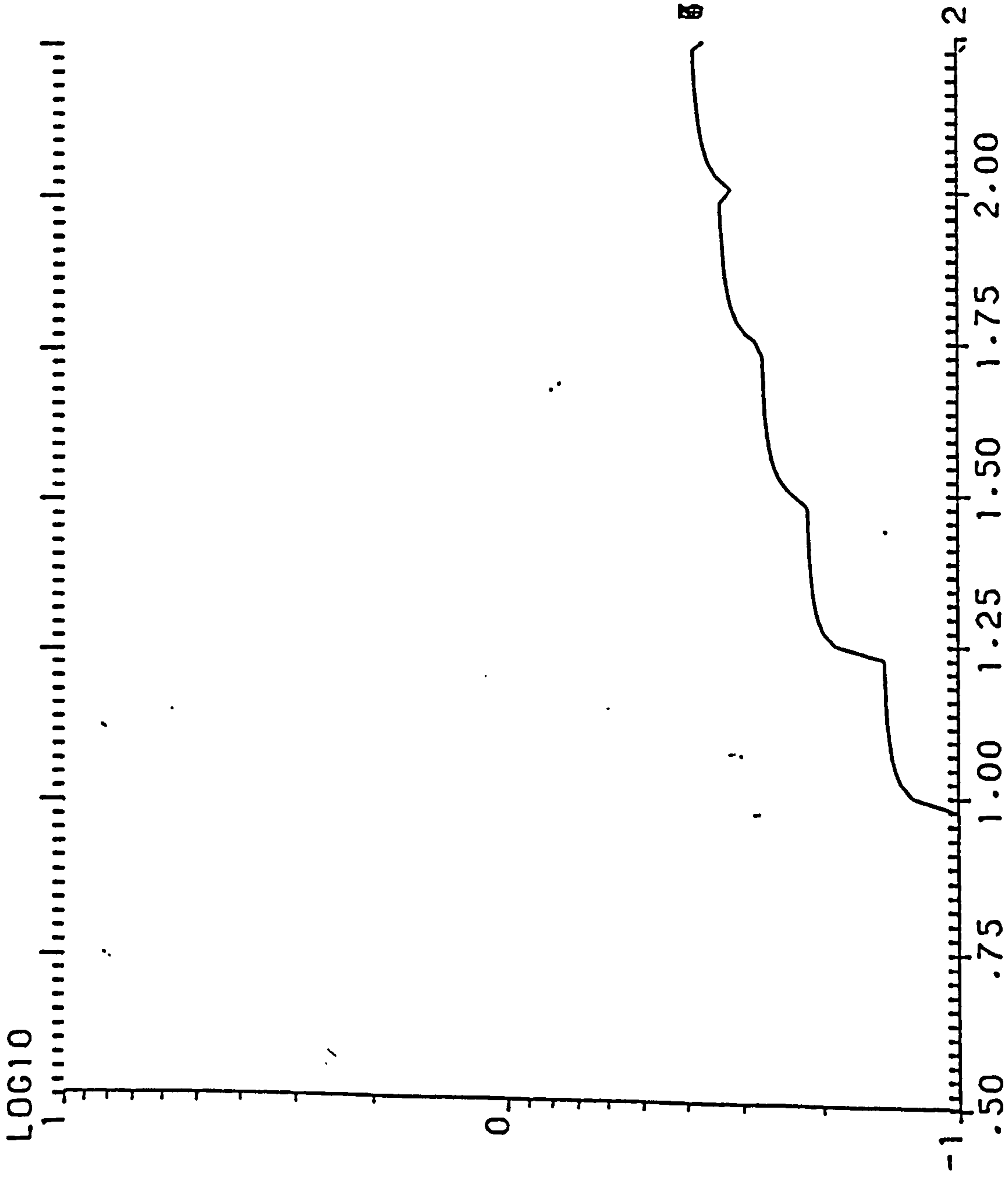

S. EFFICIENCY W. THICKNESS= .36M W. ORIENTATION=270.00

WD= 2M HD1= 22M HD2= 8M HOUSE T.=1.5 ST.



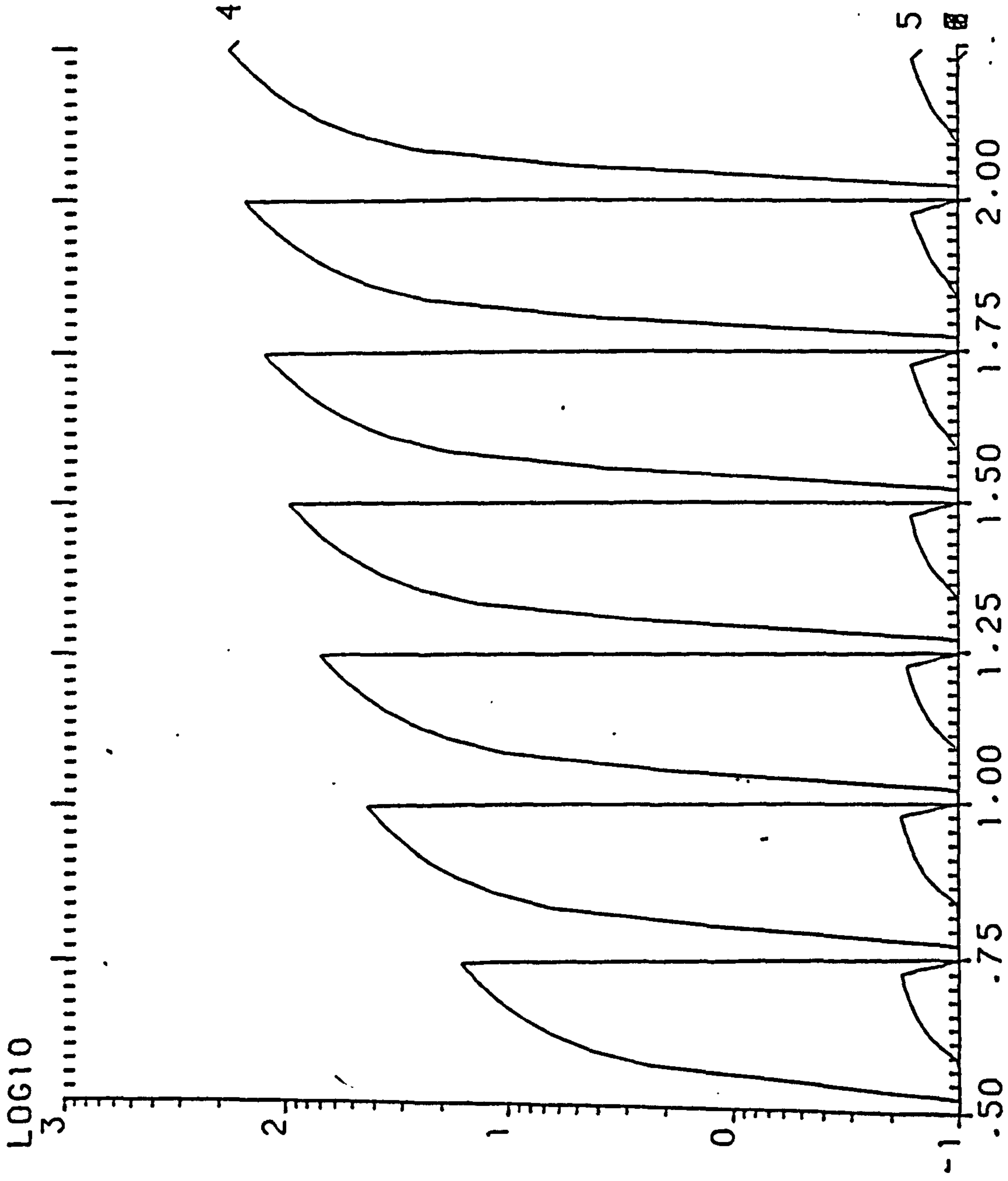

Y. EFFICIENCY W. THICKNESS= .36M W. ORIENTATION=292.50

WD= 2M HD1= 22M HD2= 8M HOUSE T.=1.5 ST.



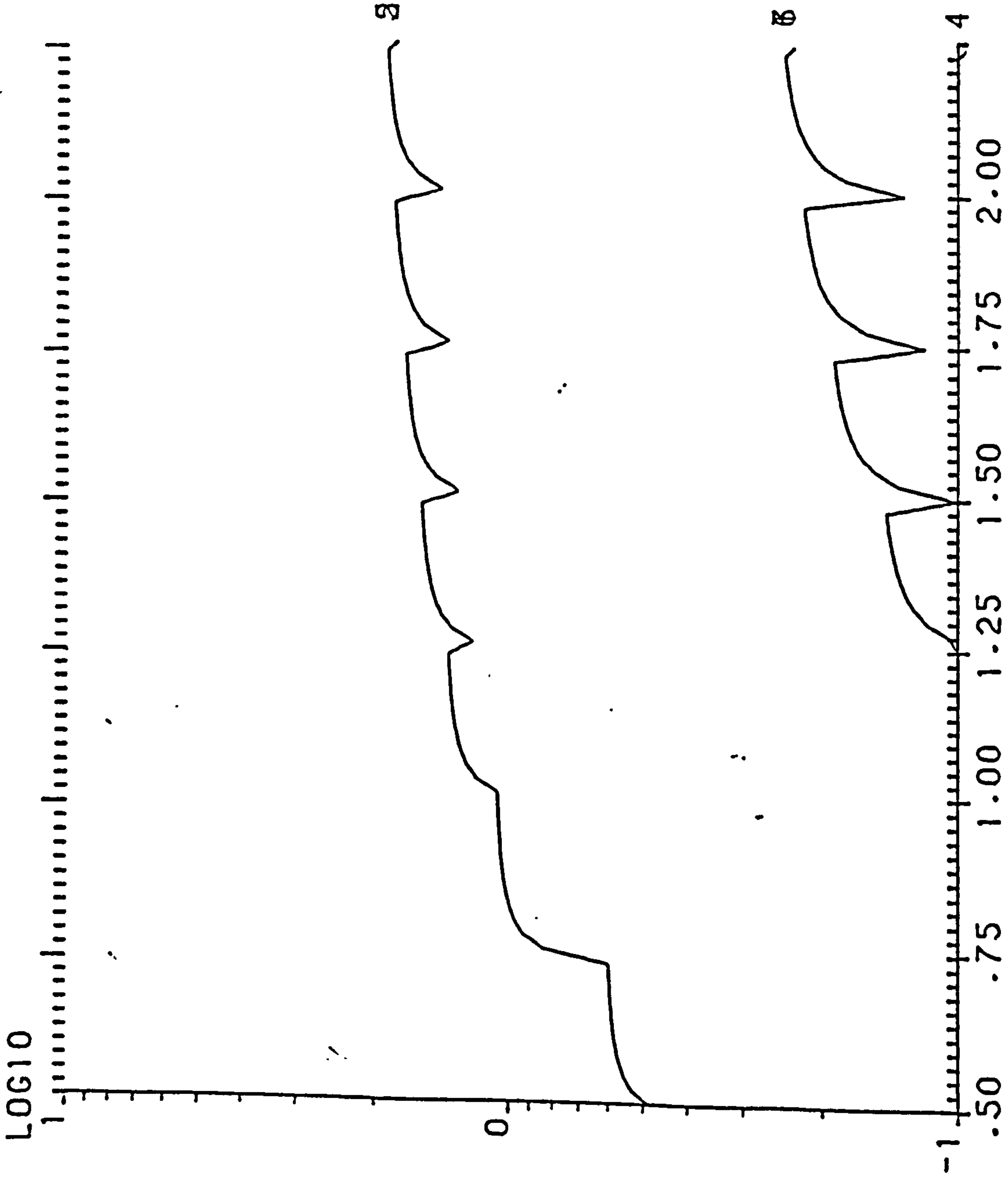

S. EFFICIENCY W. THICKNESS= .36M W. ORIENTATION=292.50

WD= 2M HD1= 22M HD2= 8M HOUSE T.=1.5 ST.

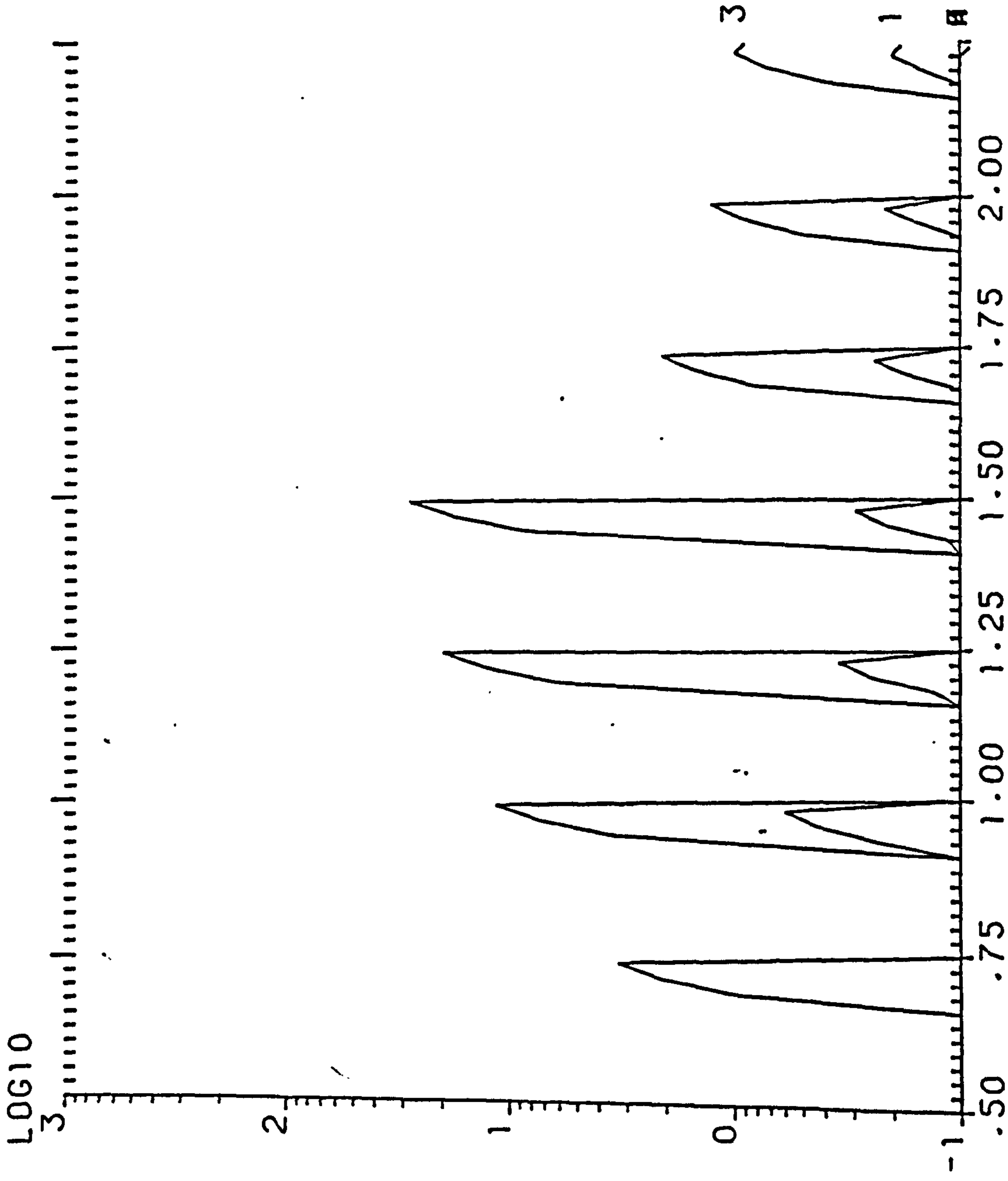

Y. EFFICIENCY W. THICKNESS= .36M W. ORIENTATION=315.00

WD= 2M HD1= 22M HD2= 8M HOUSE T.=1.5 ST.

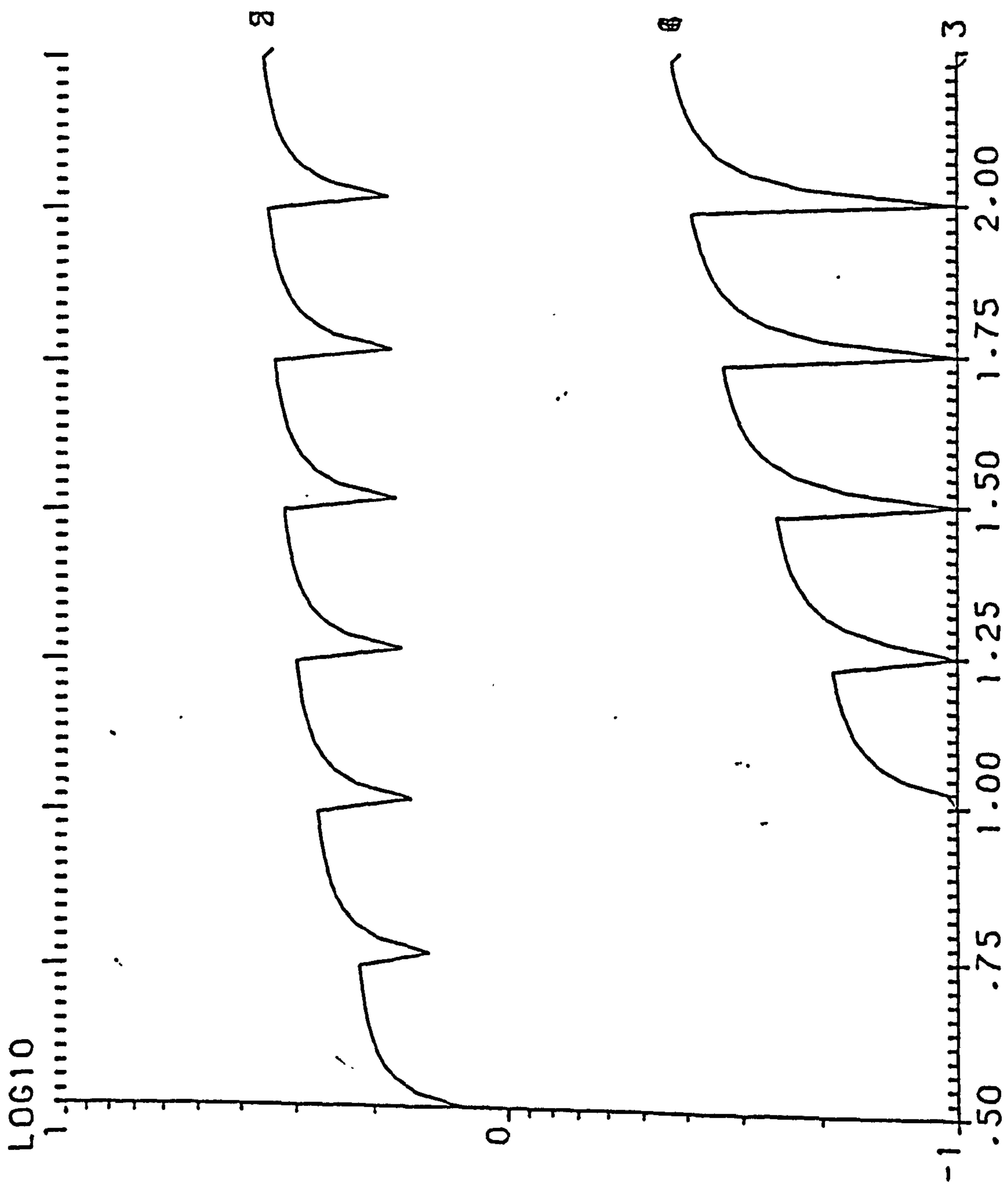

S. EFFICIENCY W. THICKNESS= .36M W. ORIENTATION=315.00  
 WD= 2M HD1= 22M HD2= 8M HOUSE T.=1.5 ST.

LOG10  
1  
0  
-1

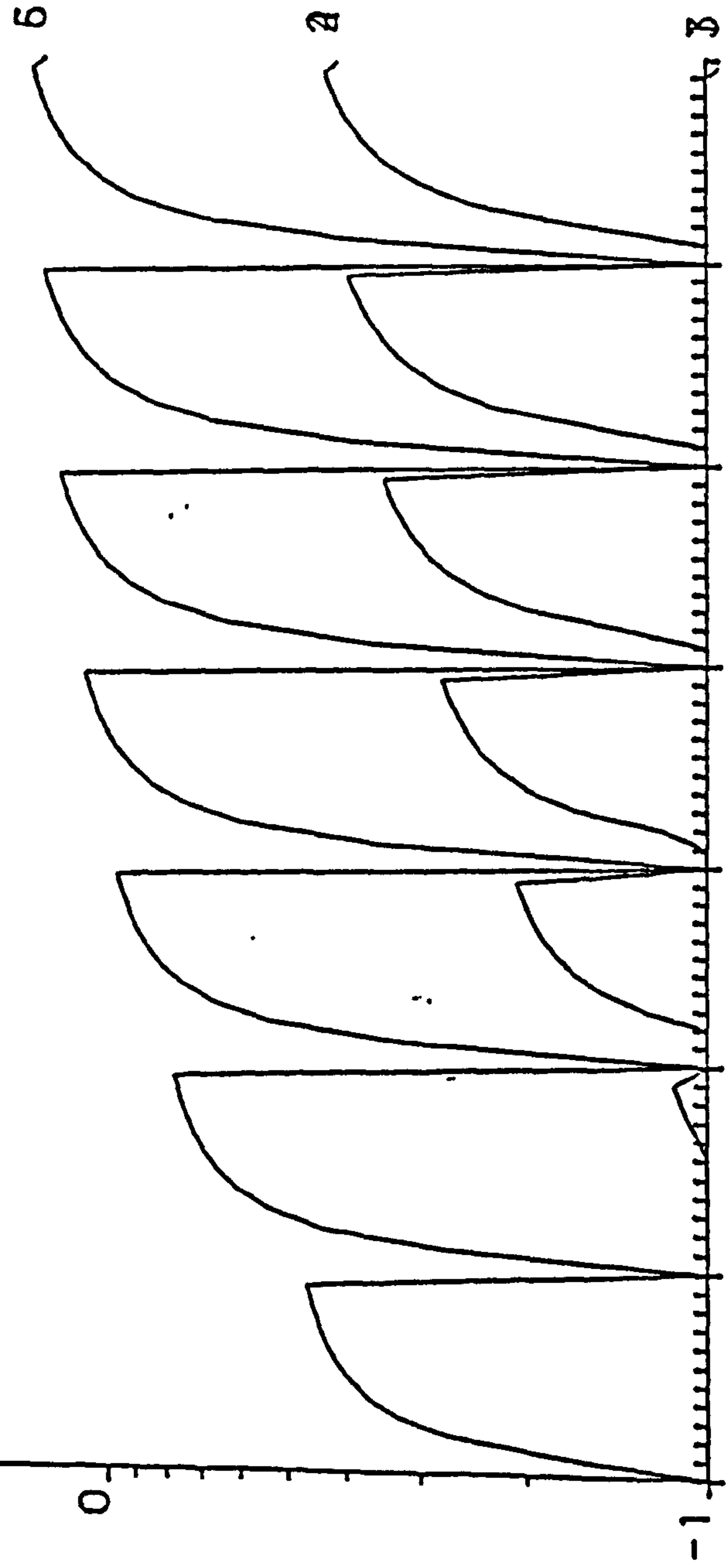

S. EFFICIENCY W. THICKNESS= .36M W. ORIENTATION=337.50

WD= 2M HD1= 22M HD2= 8M HOUSE T.=1.5 ST.



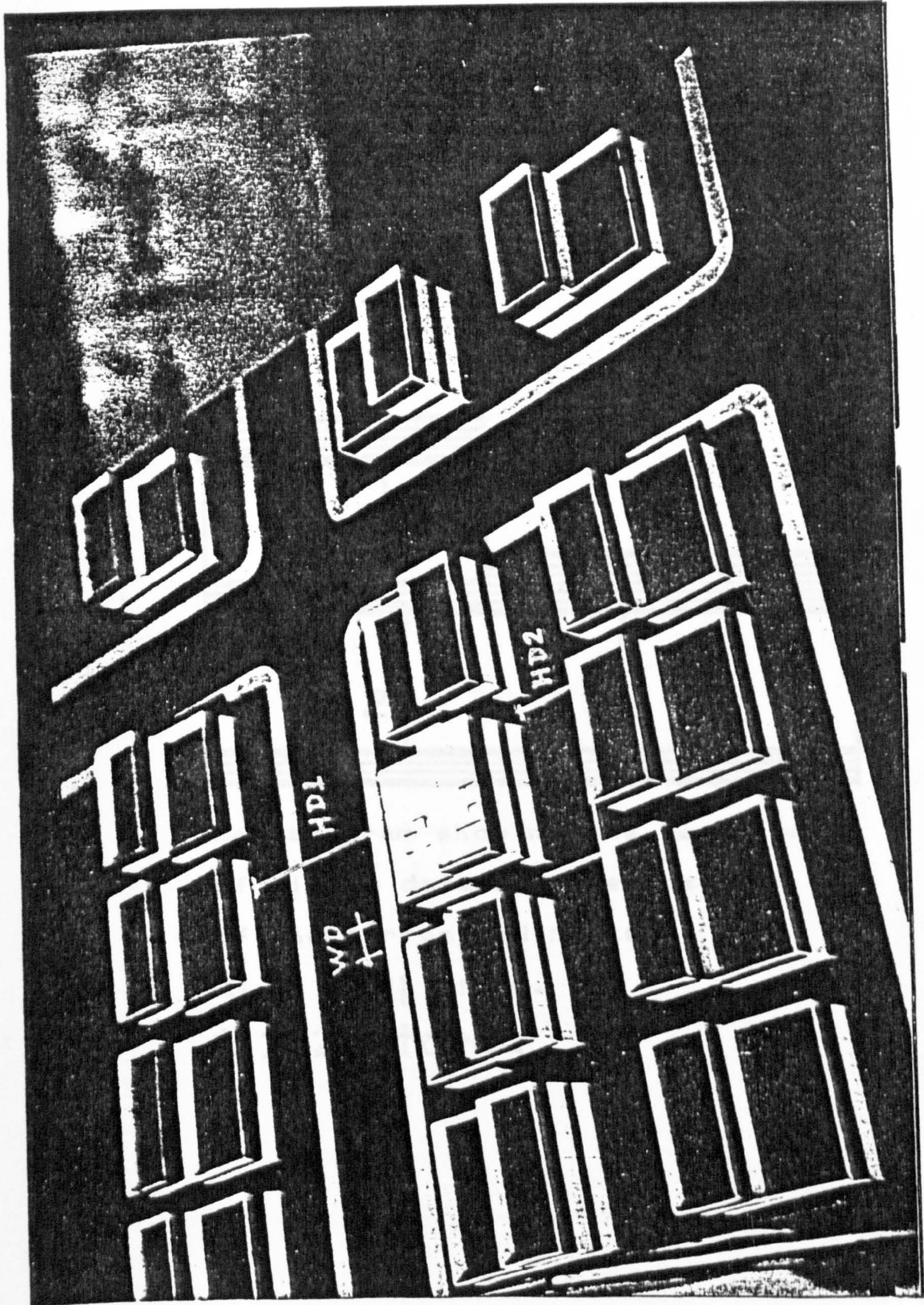

Model showing interhouse distances



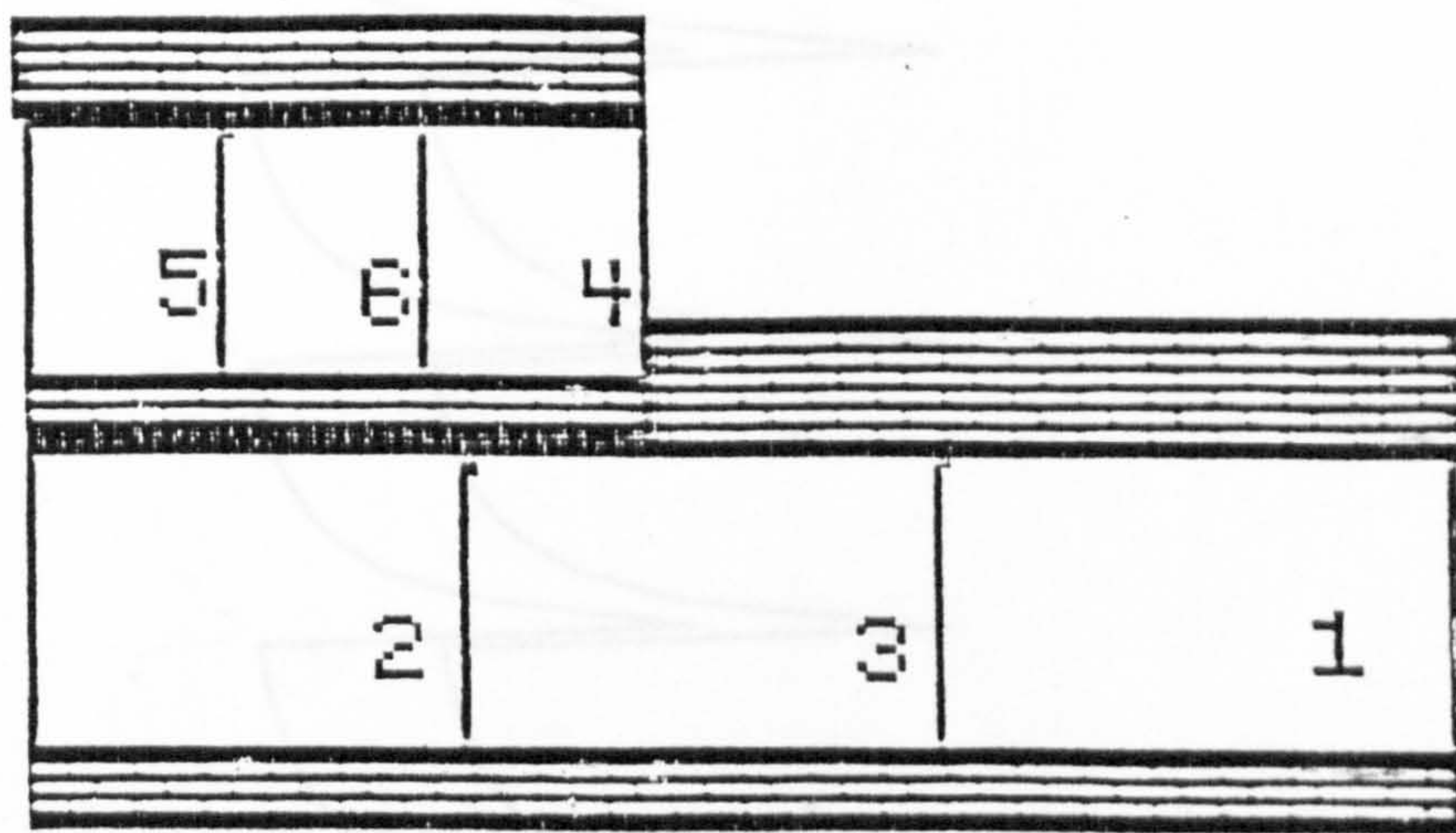

Key diagram showing the location  
of window data and the position  
of the corresponding curve

Side Wall No. 2  
1 1/2 Storey

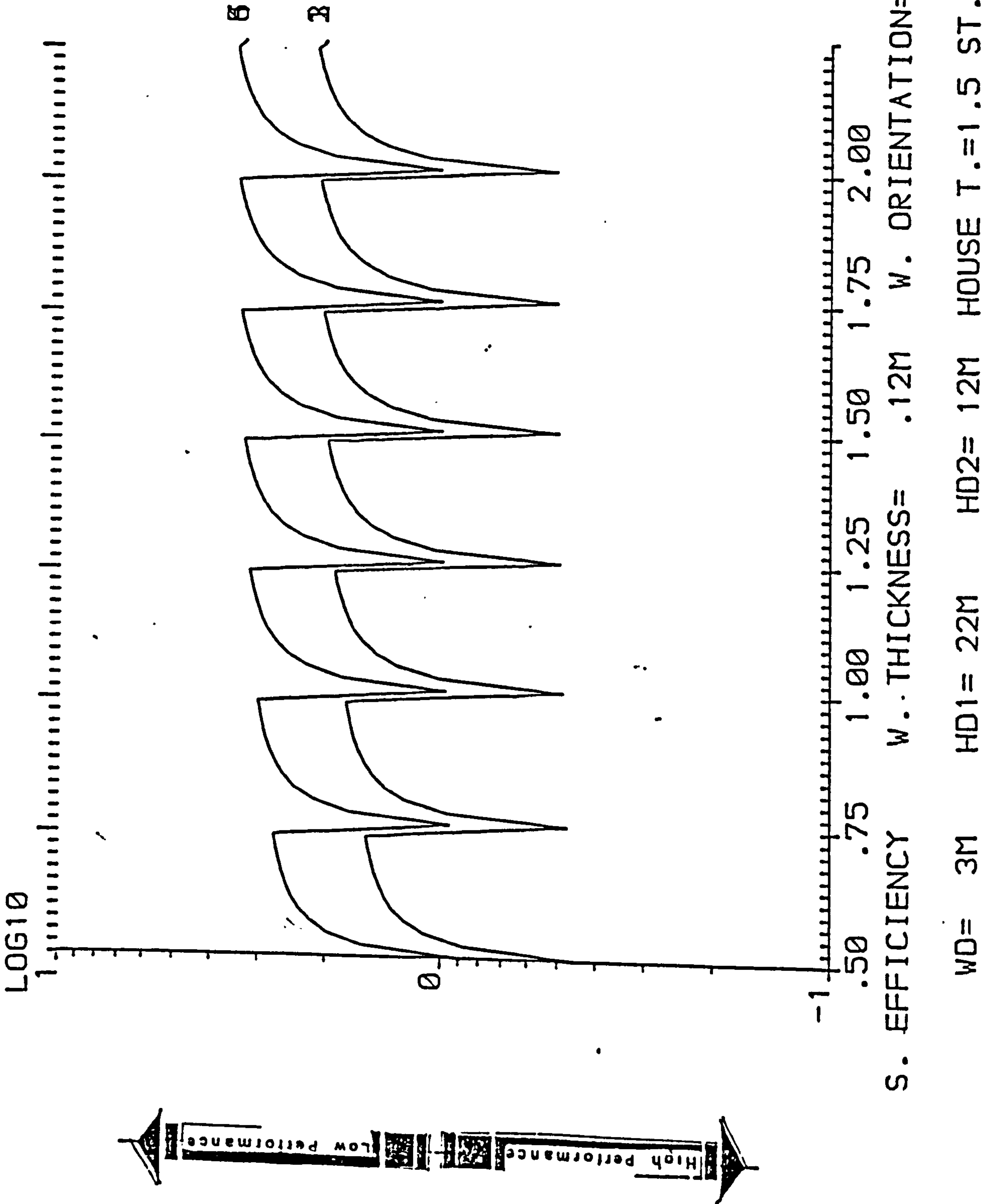

LOG10

1

0

-1

.50 .75 1.00 1.25 1.50 1.75 2.00

S. EFFICIENCY W. THICKNESS = .12M W. ORIENTATION = .00

WD = 3M HD1 = 22M HD2 = 12M HOUSE T. = 1.5 ST.



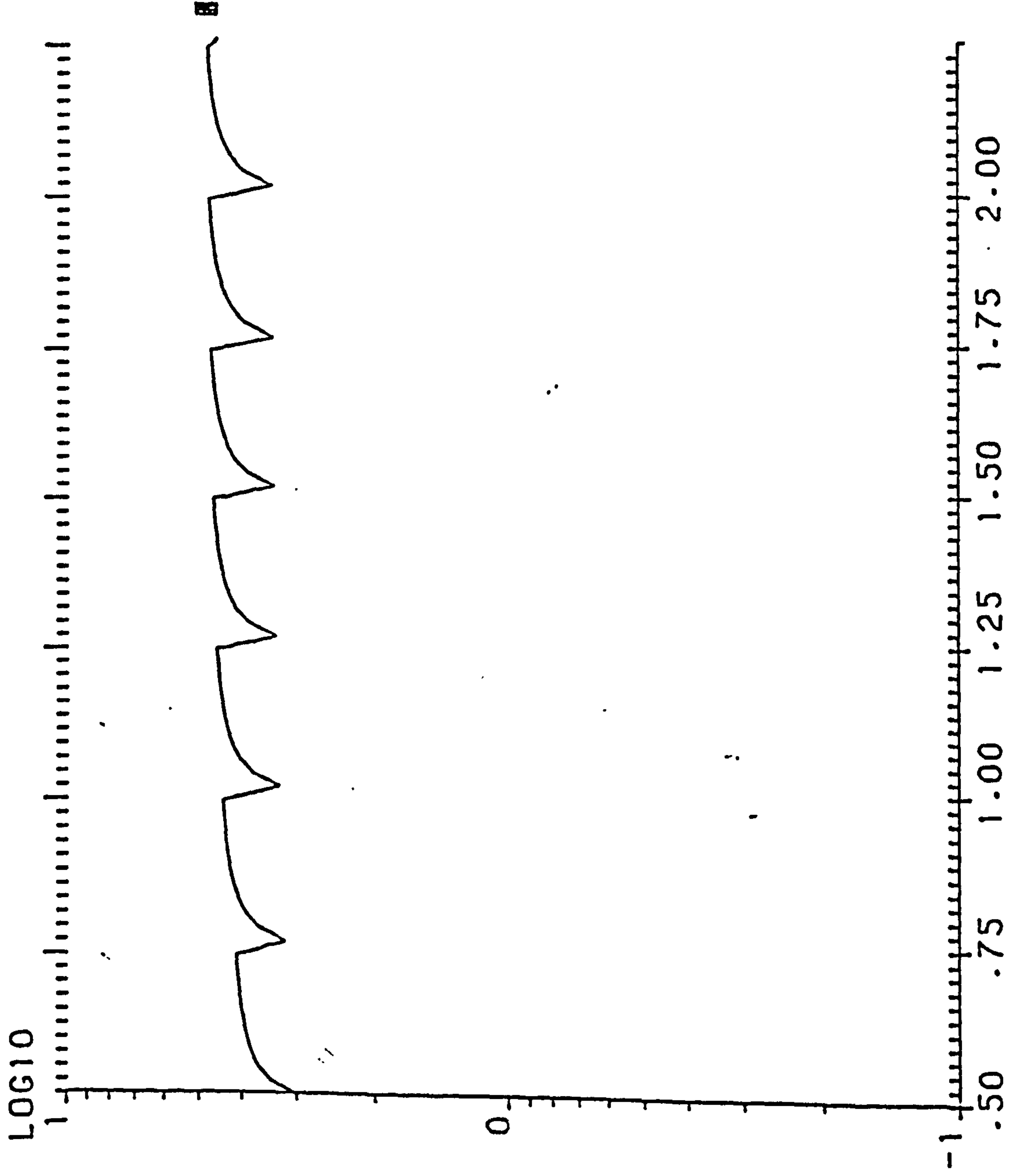

S. EFFICIENCY W. THICKNESS= .12M W. ORIENTATION= 22.50

WD= 3M HD1= 22M HD2= 12M HOUSE T.=1.5 ST.

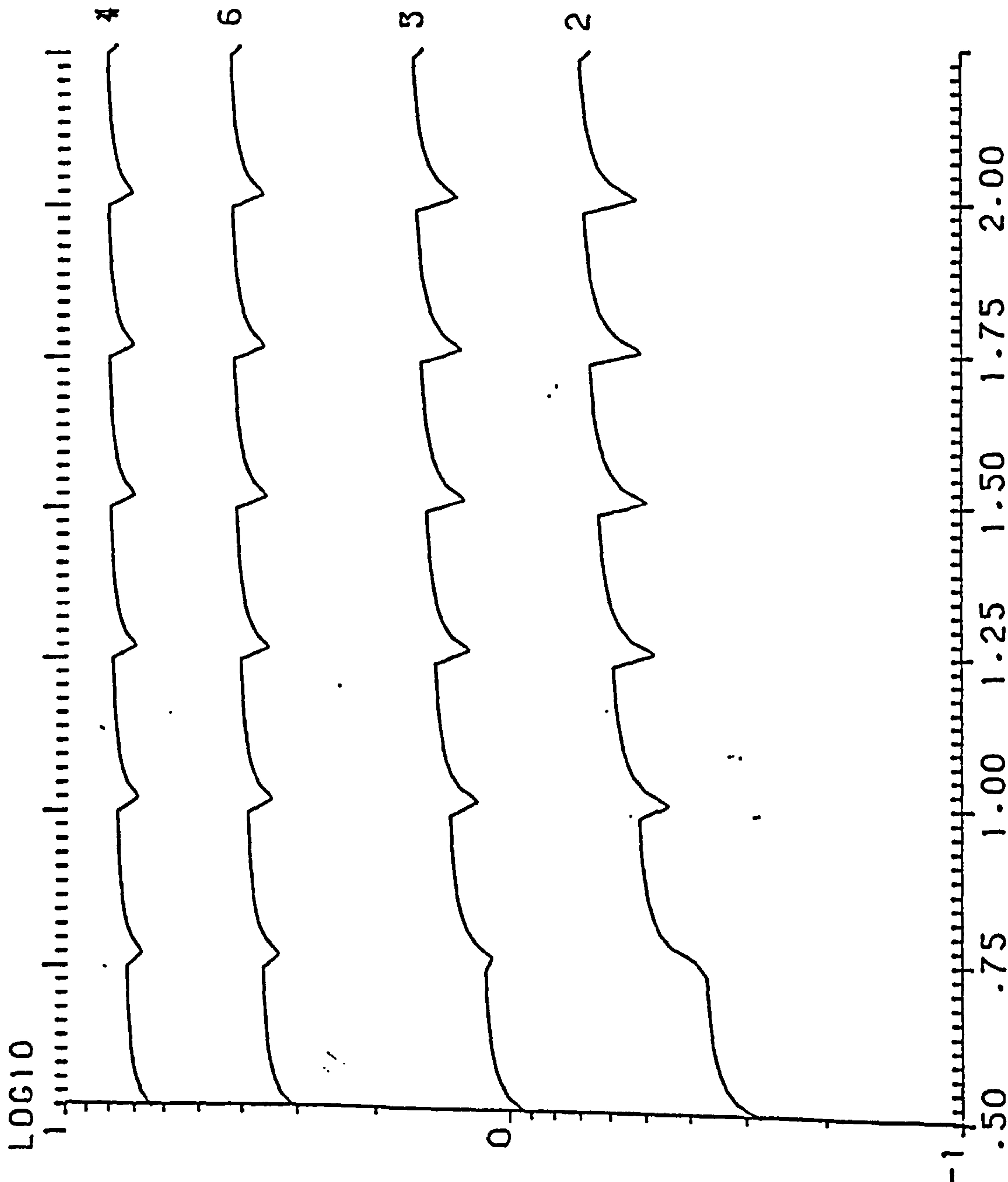

S. EFFICIENCY W. THICKNESS= .12M W. ORIENTATION= 45.00

WD= 3M HD1= 22M HD2= 12M HOUSE T.=1.5 ST.

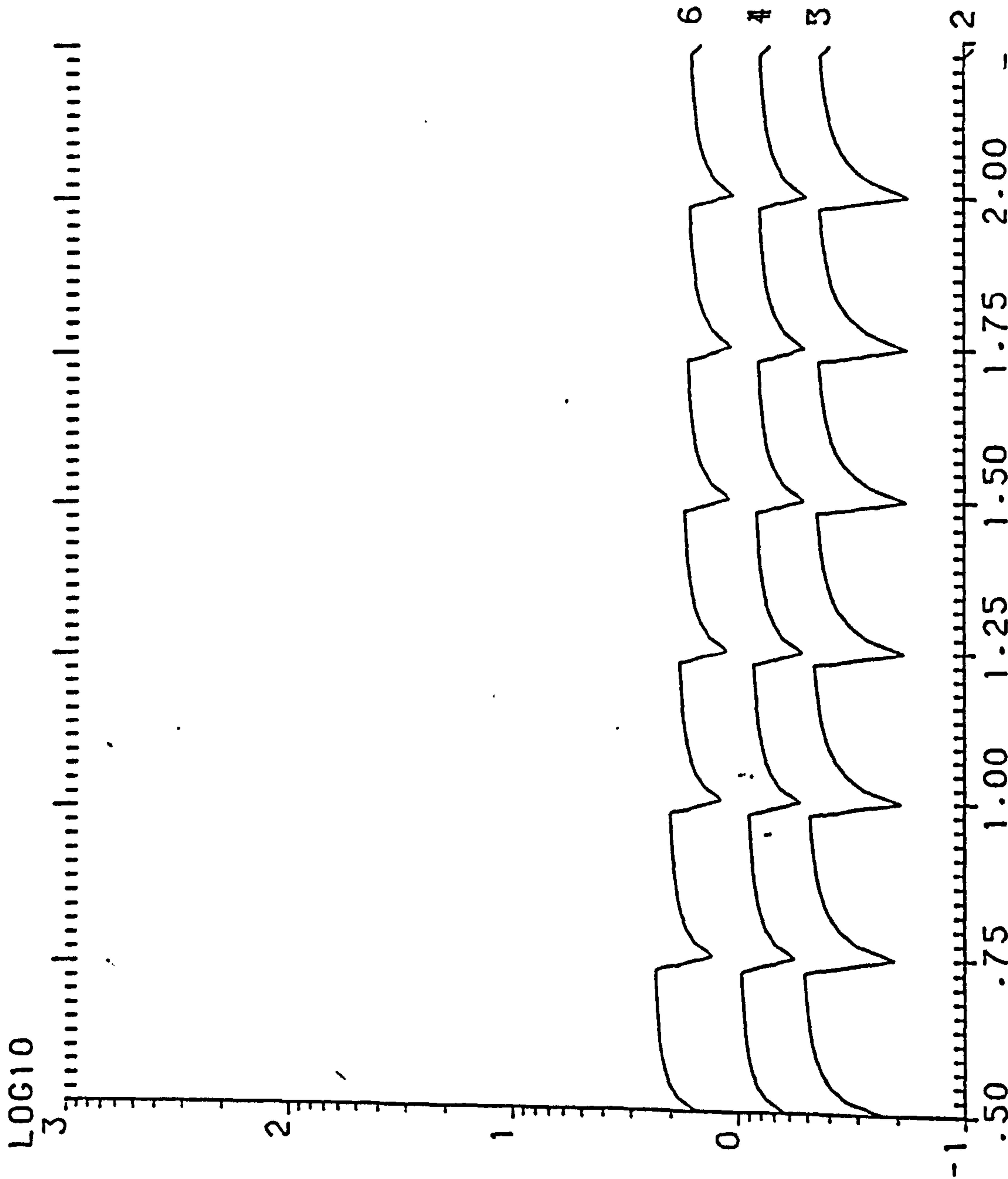

Y. EFFICIENCY W. THICKNESS= .12M W. ORIENTATION= 67.50  
WD= 3M HD1= 22M HD2= 12M HOUSE T.=1.5 ST.



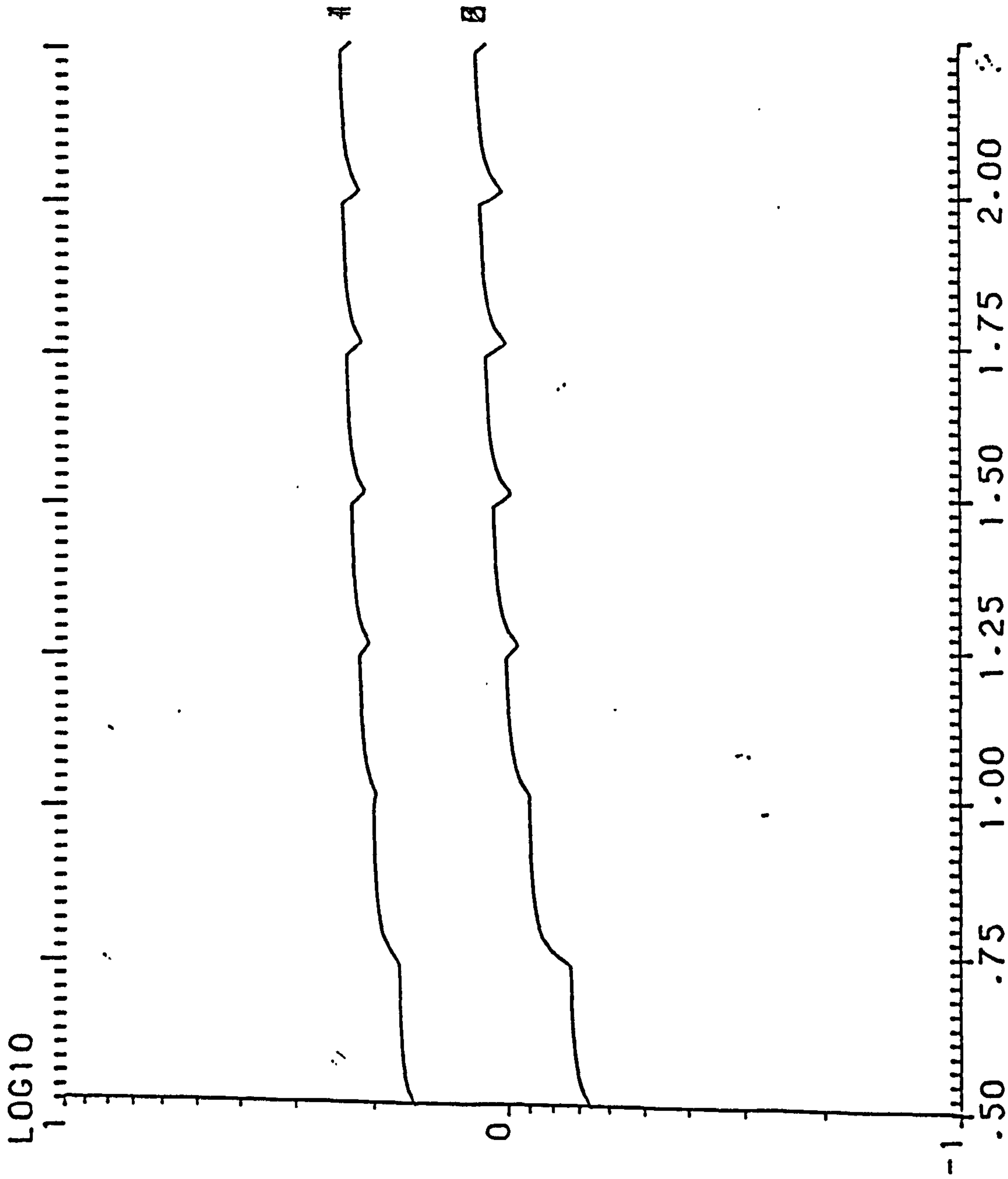

S. EFFICIENCY W. THICKNESS= .12M W. ORIENTATION= 67.50

WD= 3M HD1= 22M HD2= 12M HOUSE T.=1.5 ST.



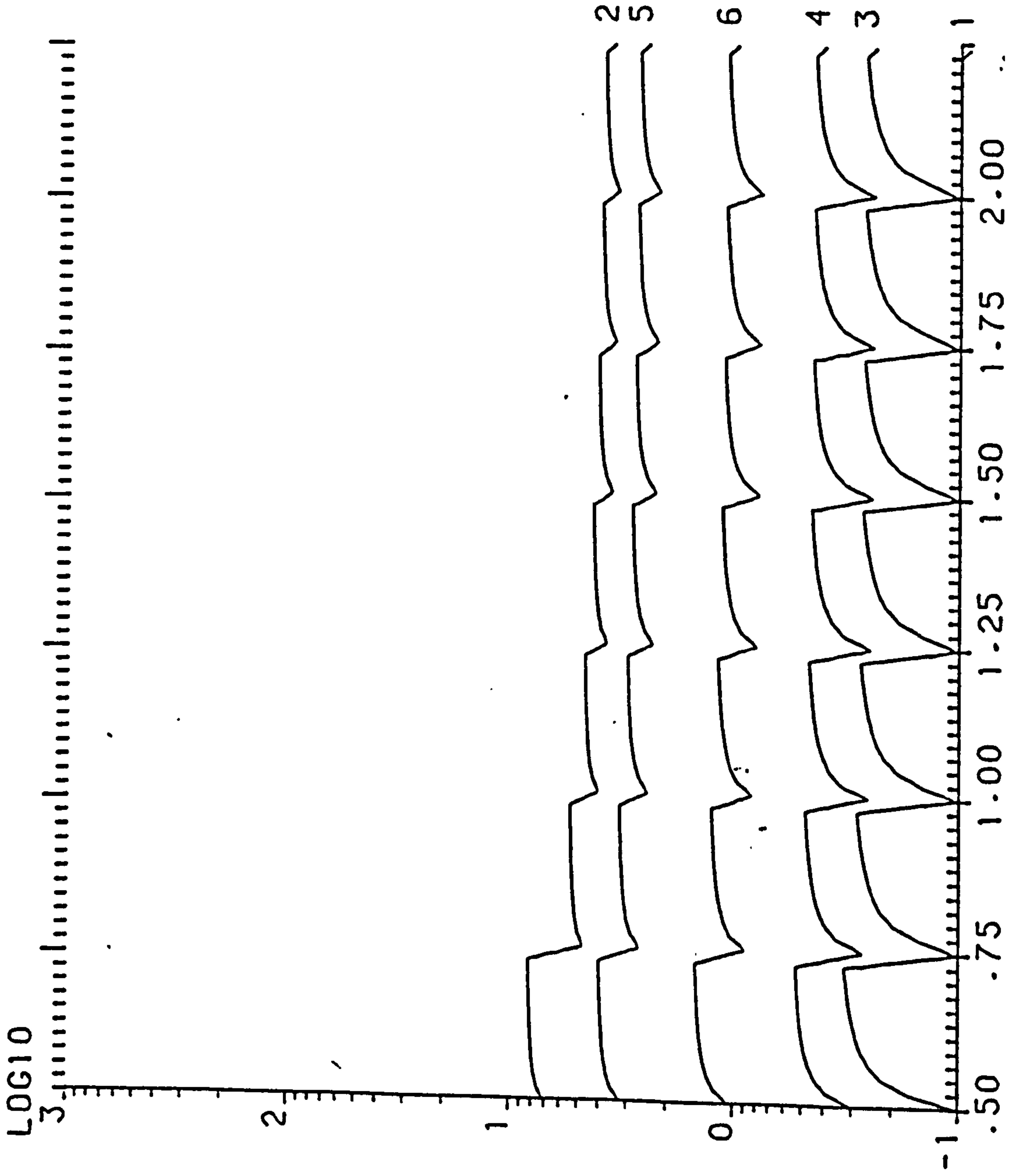

Y. EFFICIENCY W. THICKNESS= .12M W. ORIENTATION= 90.00

WD= 3M HD1= 22M HD2= 12M HOUSE T.=1.5 ST.

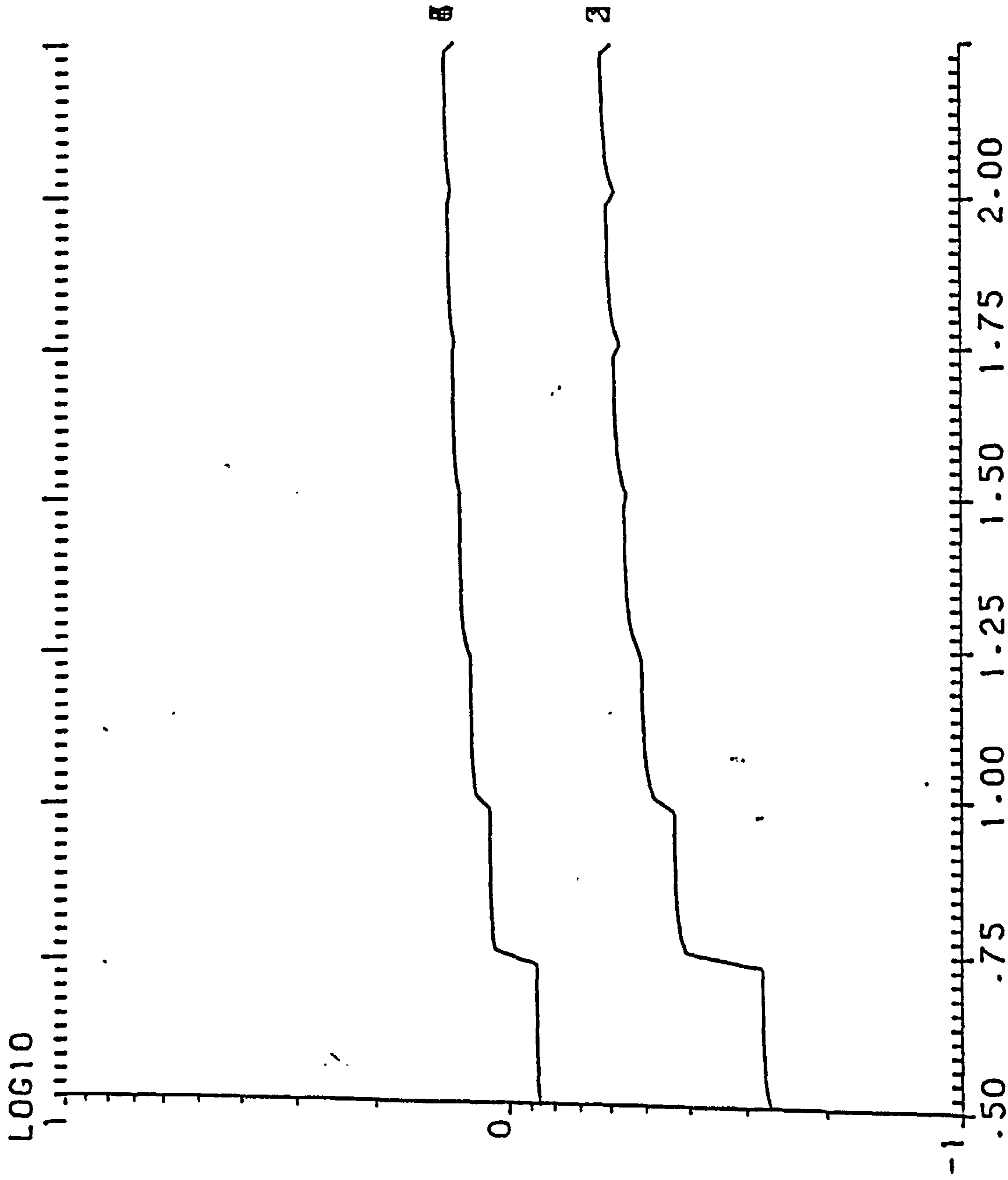

S. EFFICIENCY W. THICKNESS= .12M W. ORIENTATION= 90.00

WD= .3M HD1= 22M HD2= 12M HOUSE T.=1.5 ST.

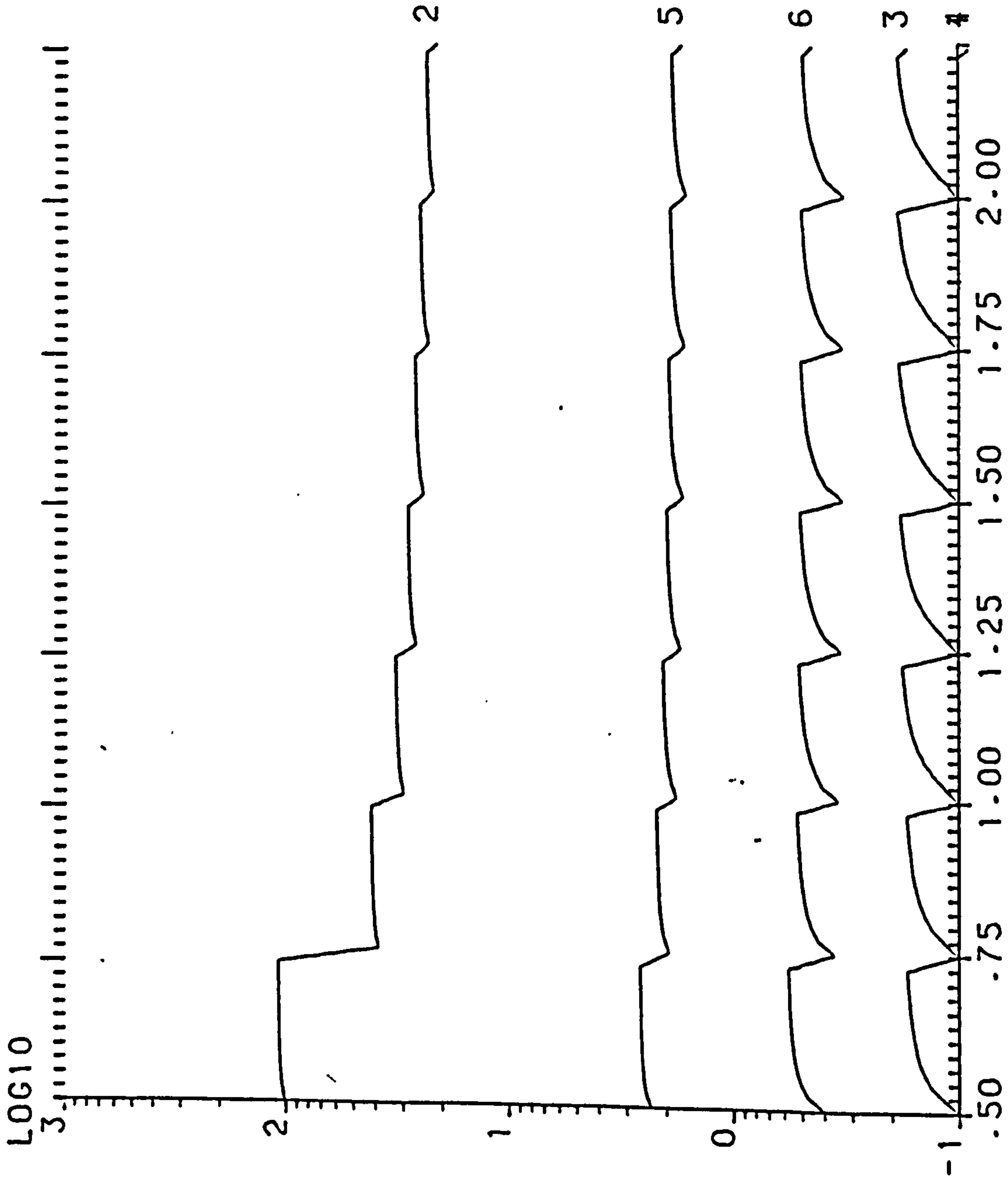

Y. EFFICIENCY W. THICKNESS= .12M W. ORIENTATION=112.50

WD= 3M HD1= 22M HD2= 12M HOUSE T.=1.5 ST.

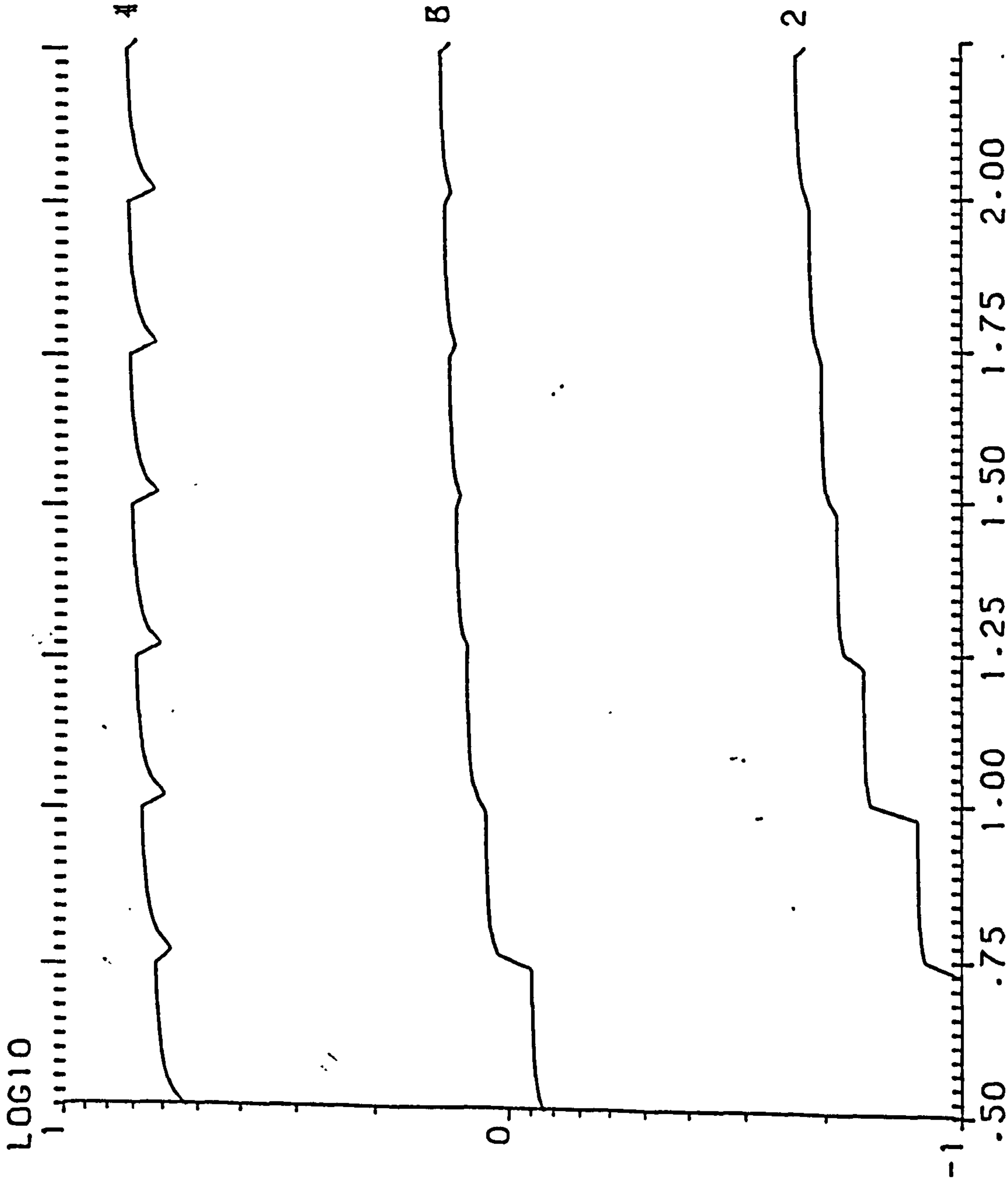

S. EFFICIENCY W. THICKNESS = .12M W. ORIENTATION=112.50

WD= 3M HD1= 22M HD2= 12M HOUSE T.=1.5 ST.



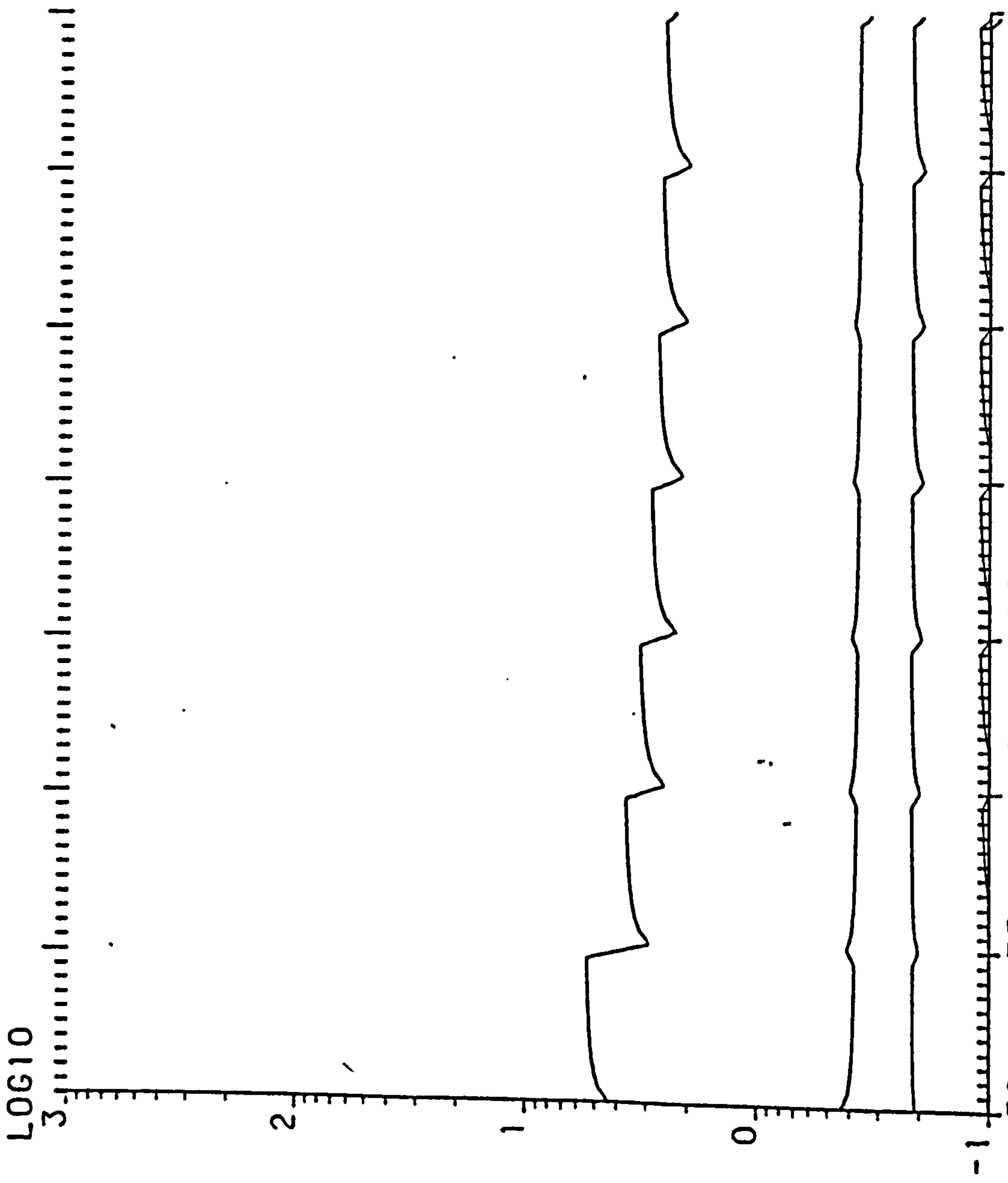

Y. EFFICIENCY W. THICKNESS= .12M W. ORIENTATION=135.00

WD= 3M HD1= 22M HD2= 12M HOUSE T.=1.5 ST.

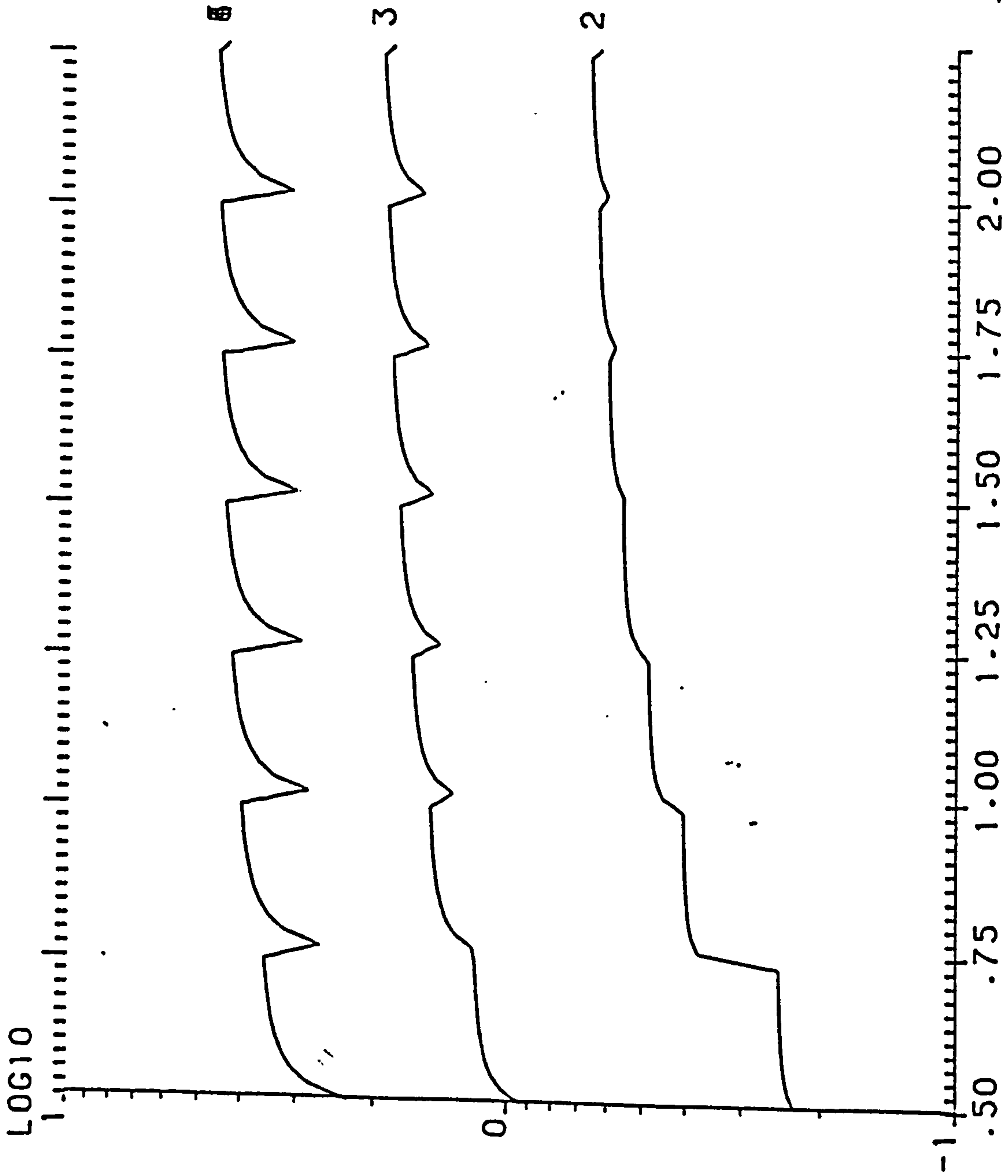

S. EFFICIENCY W. THICKNESS= .12M W. ORIENTATION=135.00

WD= 3M HD1= 22M HD2= 12M HOUSE T.=1.5 ST.



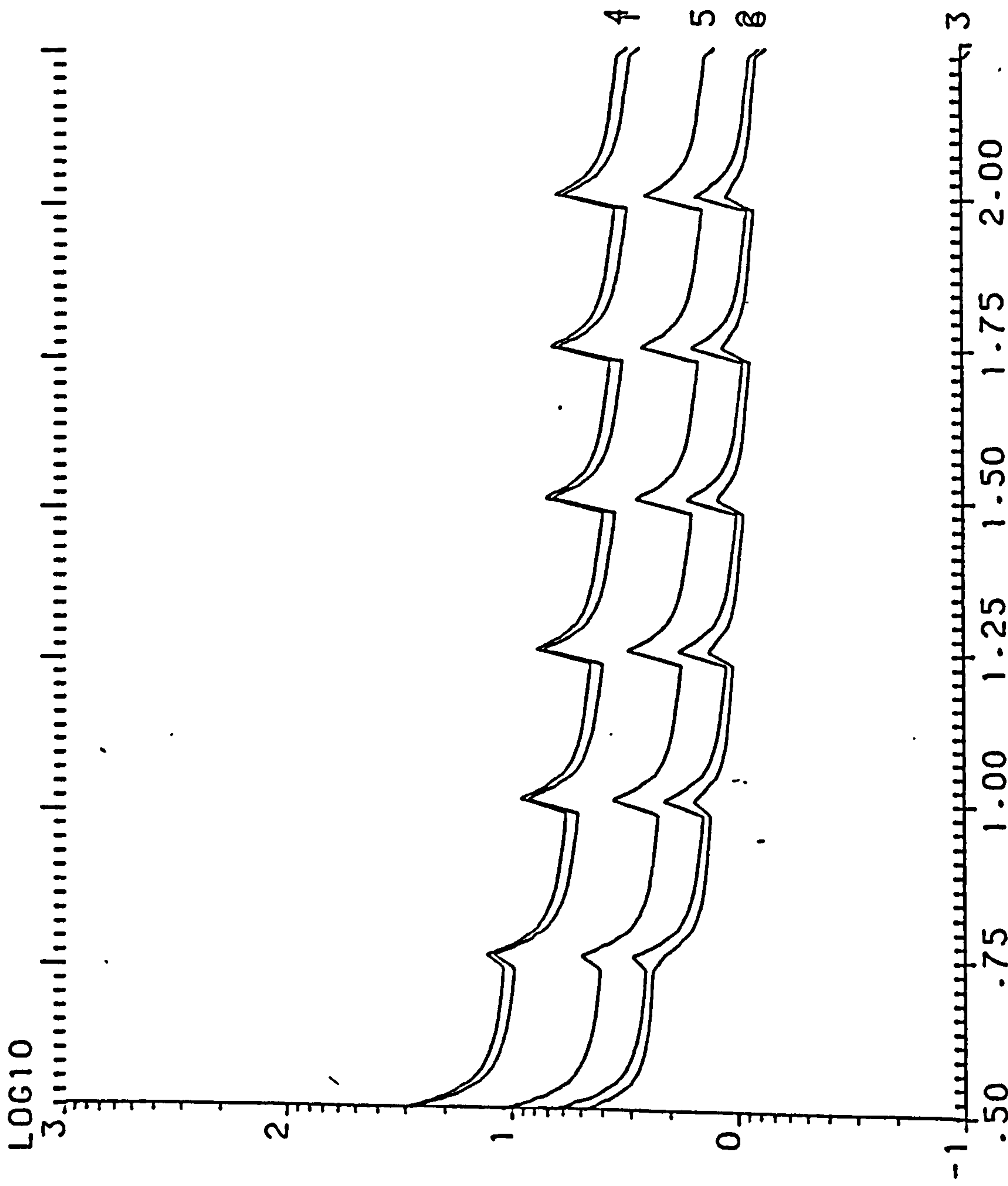

Y. EFFICIENCY W. THICKNESS= .12M W. ORIENTATION=157.50  
 WD= 3M HD1= 22M HD2= 12M HOUSE T.=1.5 ST.

LOG10

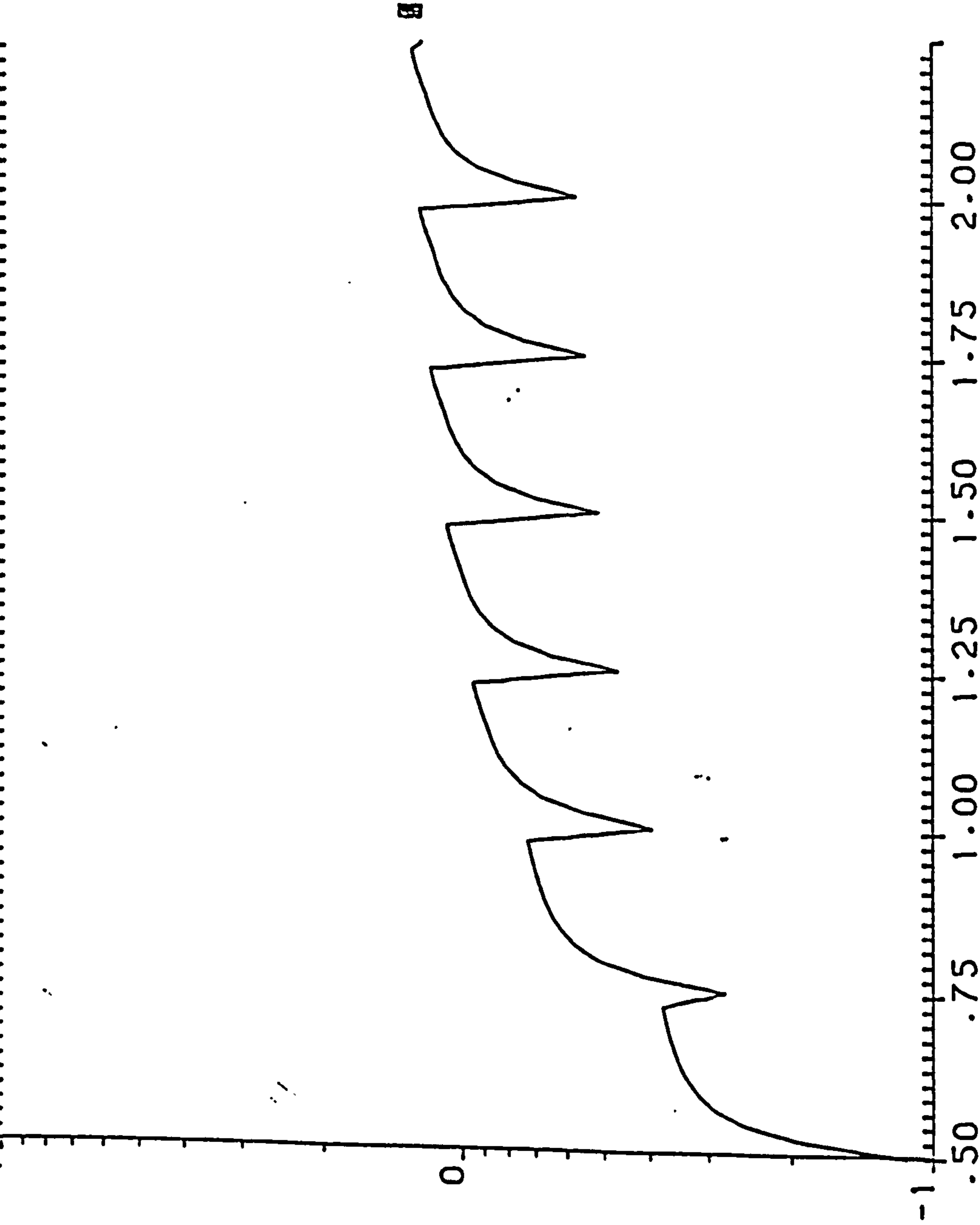

S. EFFICIENCY W. THICKNESS= .12M HD1= 22M HD2= 12M HOUSE T.=1.5 ST.  
 W. ORIENTATION=157.50

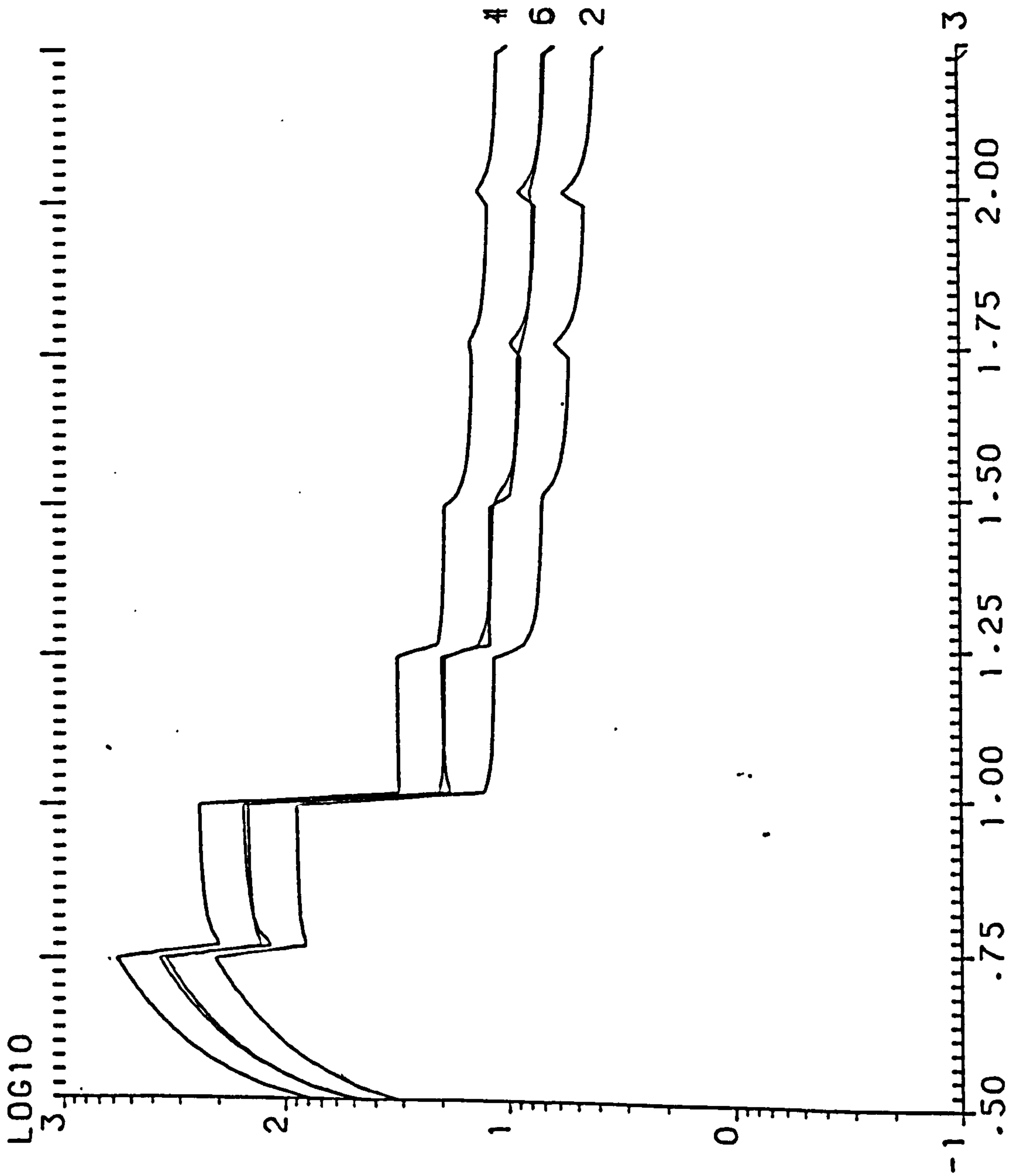

Y. EFFICIENCY W. THICKNESS= .12M W. ORIENTATION=180.00

WD= 3M HD1= 22M HD2= 12M HOUSE T.=1.5 ST.



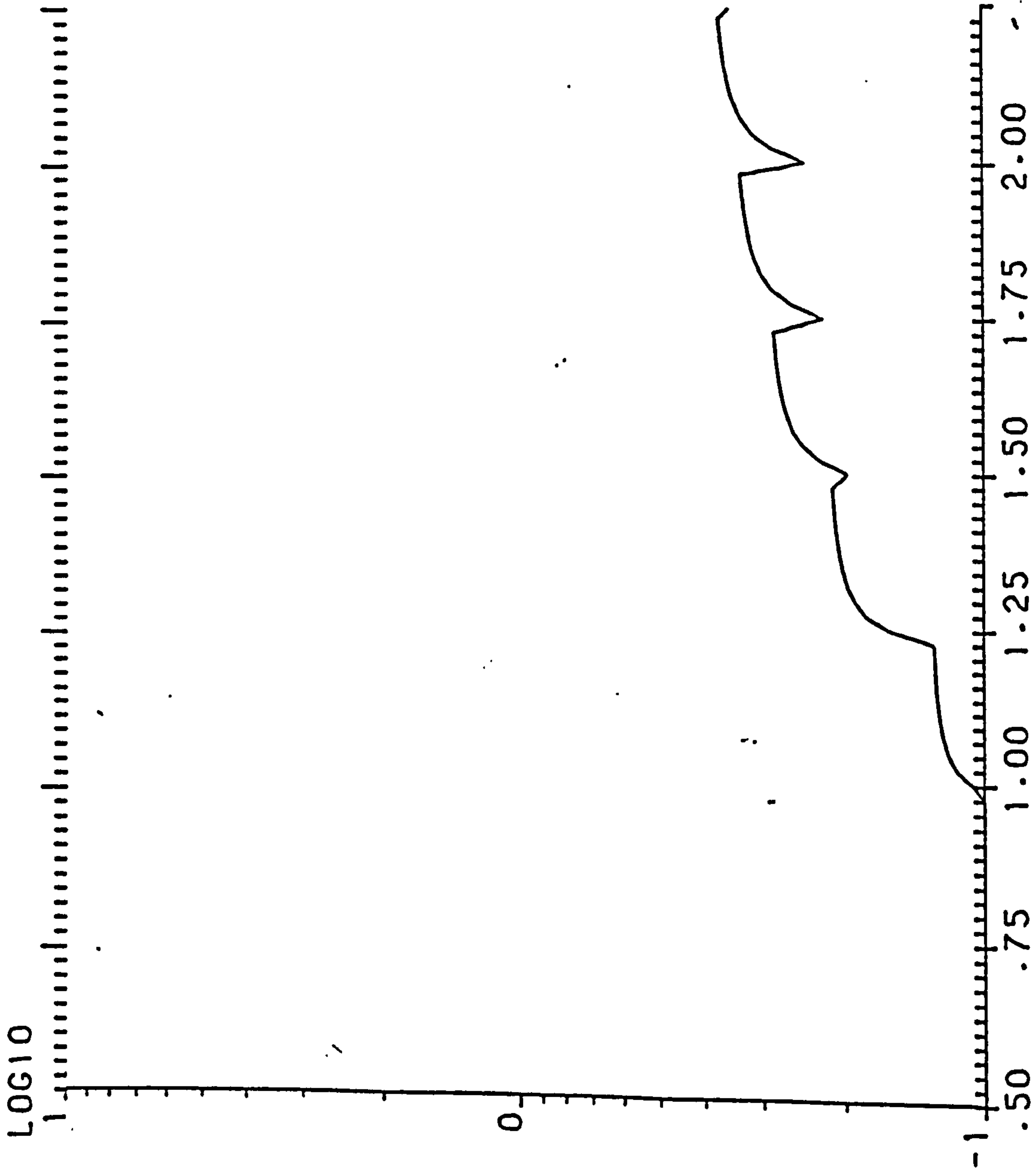

S. EFFICIENCY W. THICKNESS= .12M W. ORIENTATION=180.00  
 WD= 3M HD1= 22M HD2= 12M HOUSE T.=1.5 ST.



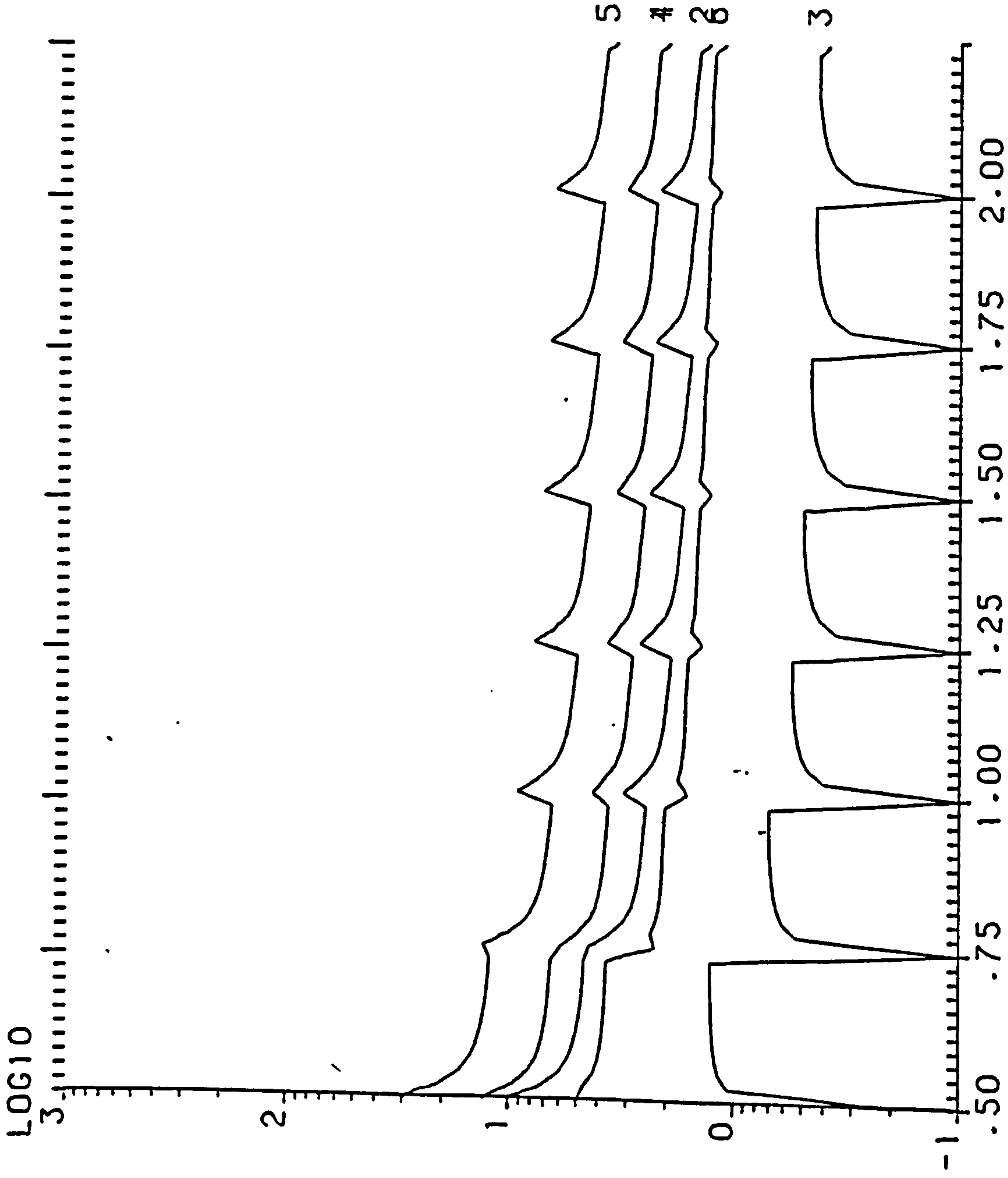

Y. EFFICIENCY W. THICKNESS= .12M W. ORIENTATION=202.50

WD= 3M HD1= 22M HD2= 12M HOUSE T.=1.5 ST.

LOG10  
3  
2  
1  
0  
-1

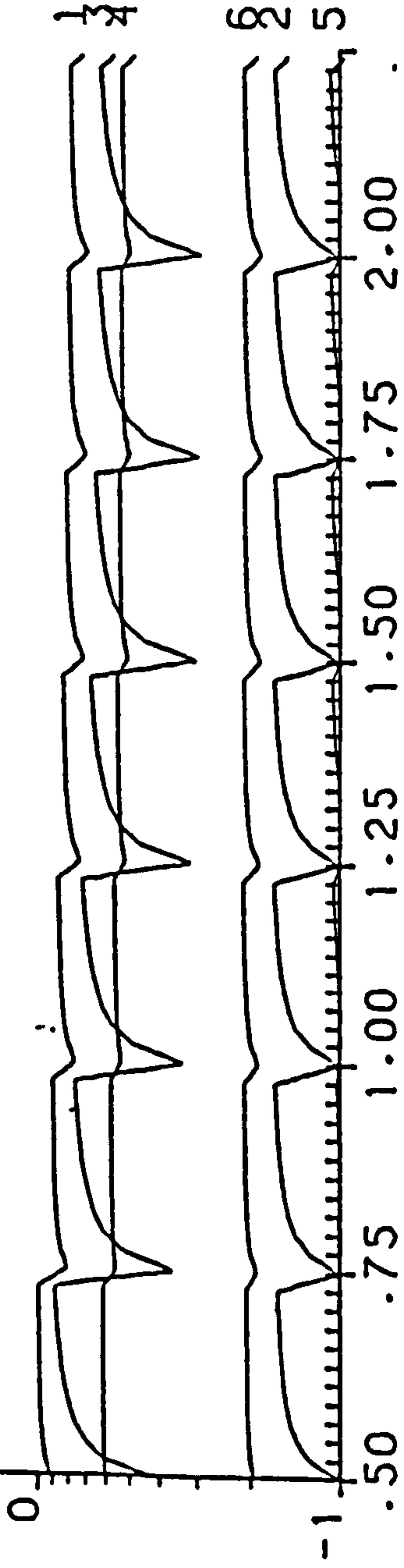

Y. EFFICIENCY W. THICKNESS= .12M W. ORIENTATION=225.00

WD= 3M HD1= 22M HD2= 12M HOUSE T.=1.5 ST.

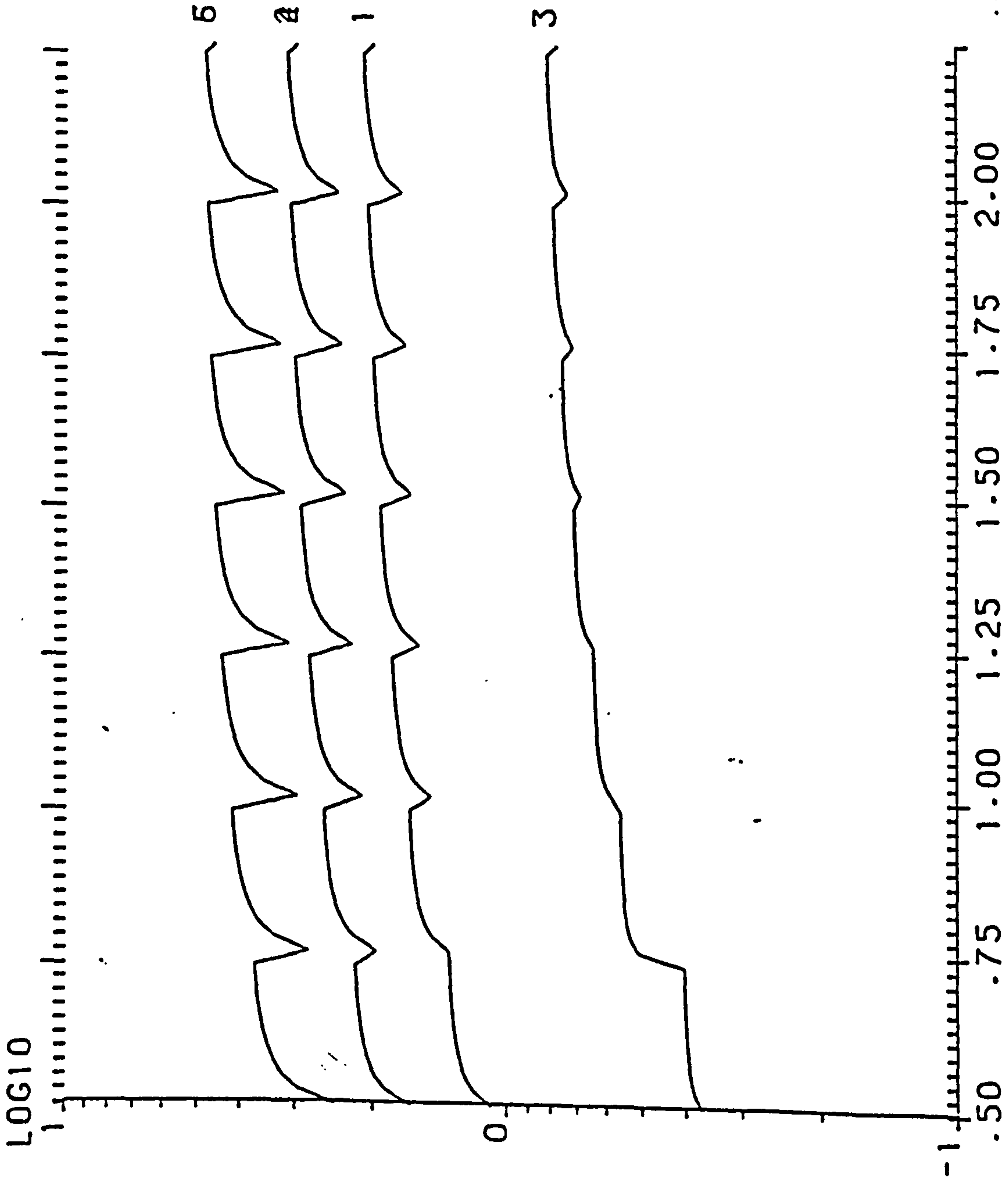

S. EFFICIENCY W. THICKNESS= .12M W. ORIENTATION=225.00  
 WD= 3M HD1= 22M HD2= 12M HOUSE T.=1.5 ST.

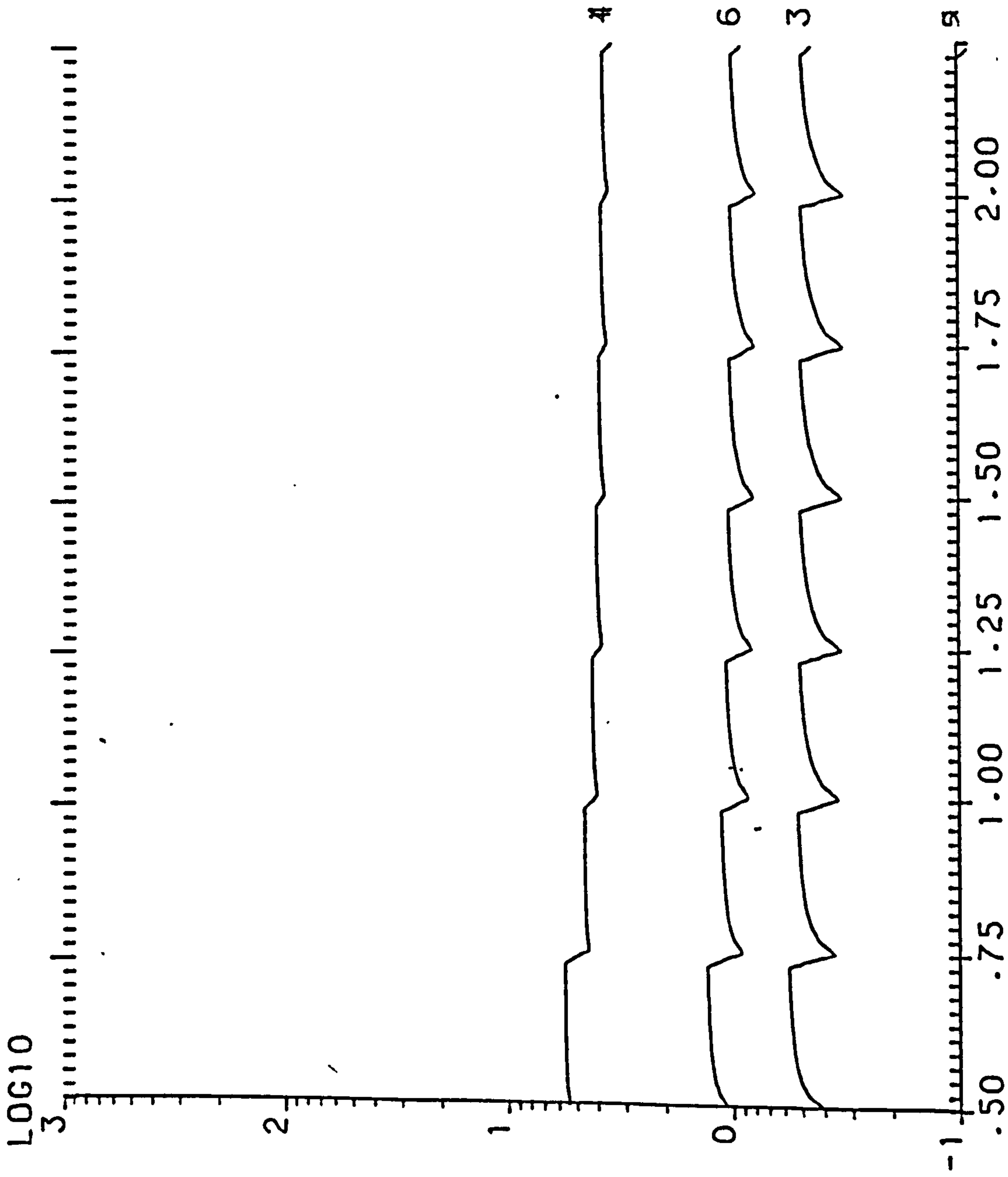

Y. EFFICIENCY W. THICKNESS= .12M W. ORIENTATION=247.50

WD= 3M HD1= 22M HD2= 12M HOUSE T.=1.5 ST.



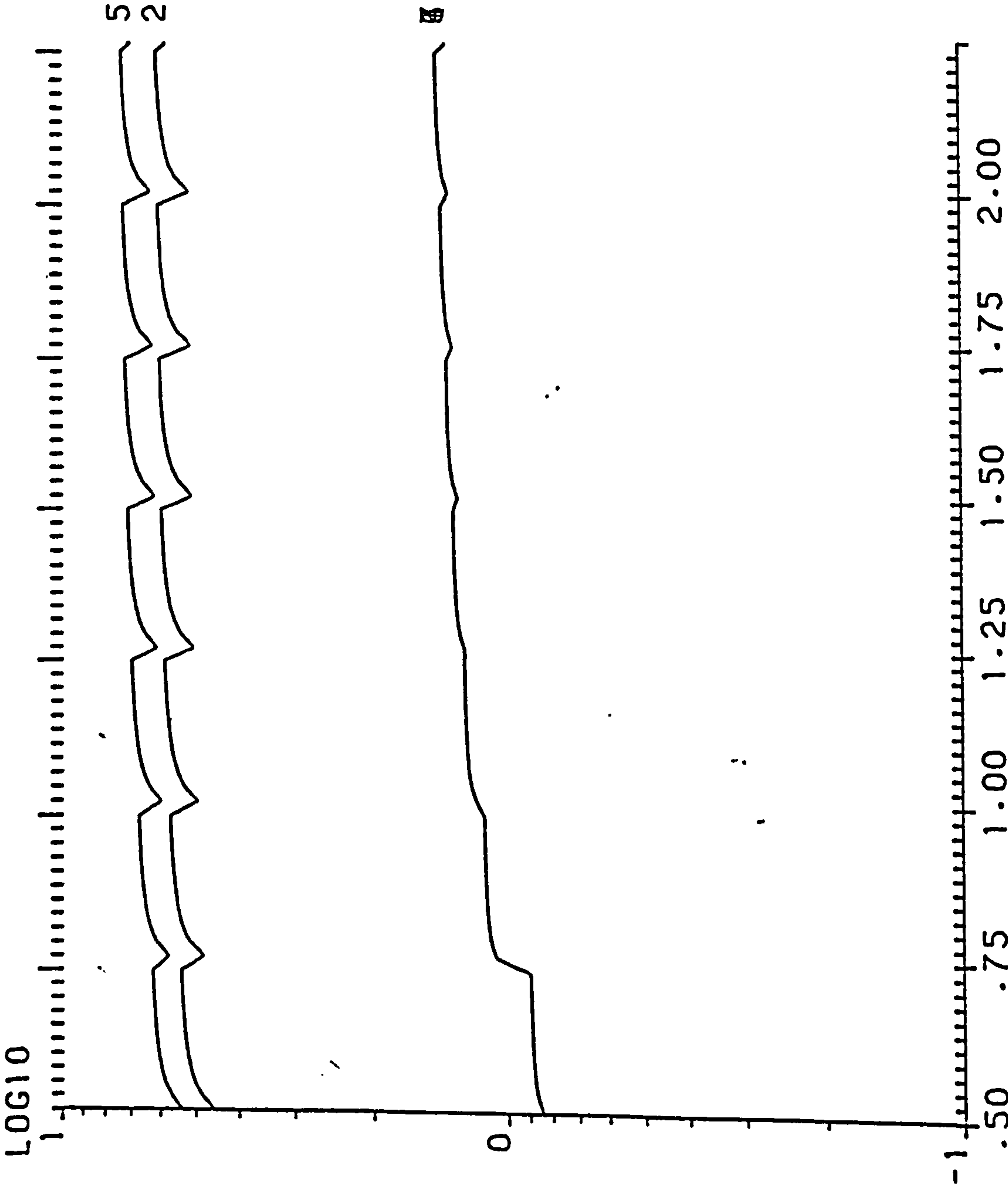

S. EFFICIENCY W. THICKNESS= .12M W. ORIENTATION=247.50

WD= 3M HD1= 22M HD2= 12M HOUSE T.=1.5 ST.

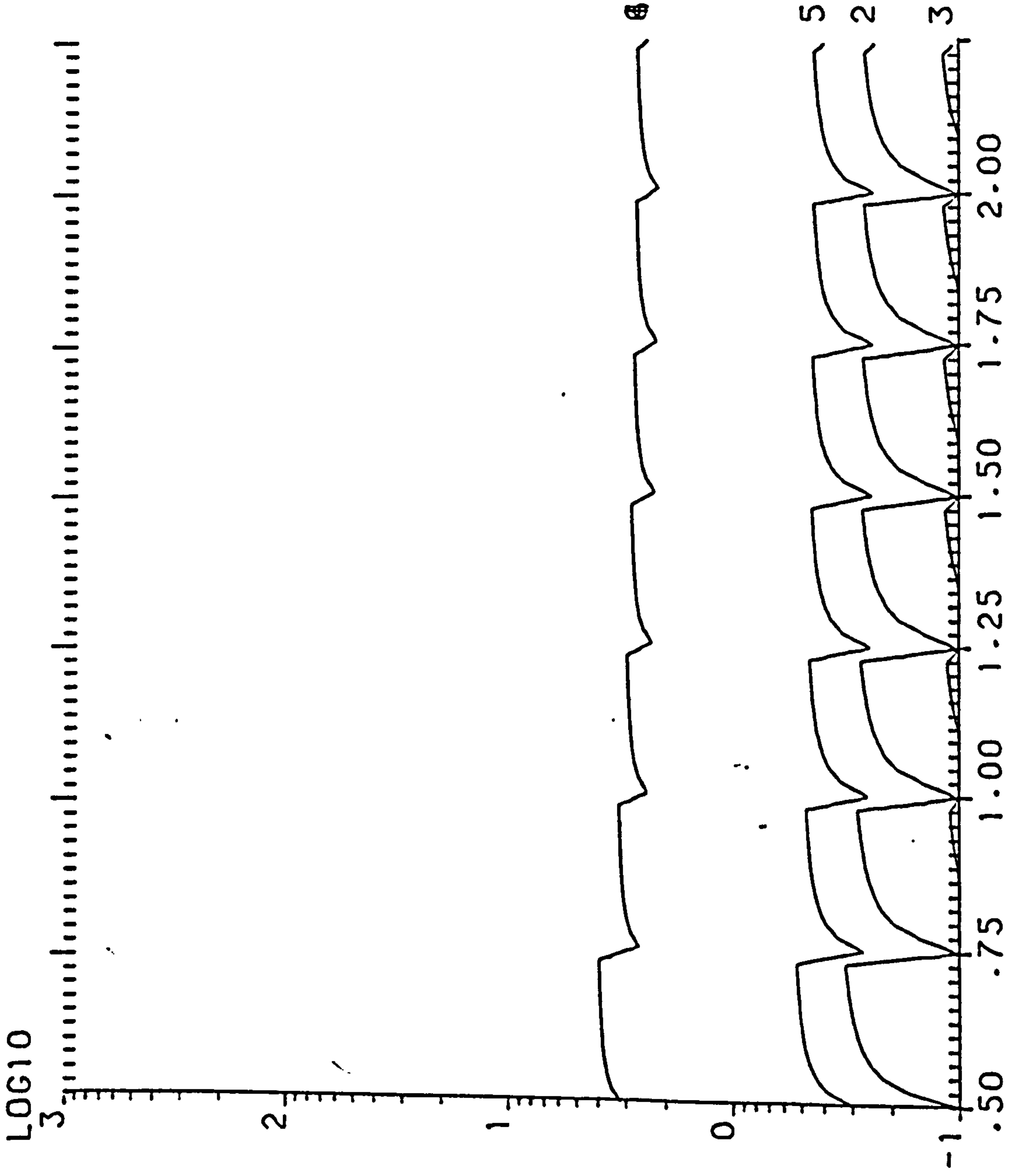

Y. EFFICIENCY W. THICKNESS= .12M W. ORIENTATION=270.00

WD= 3M HD1= 22M HD2= 12M HOUSE T.=1.5 ST.

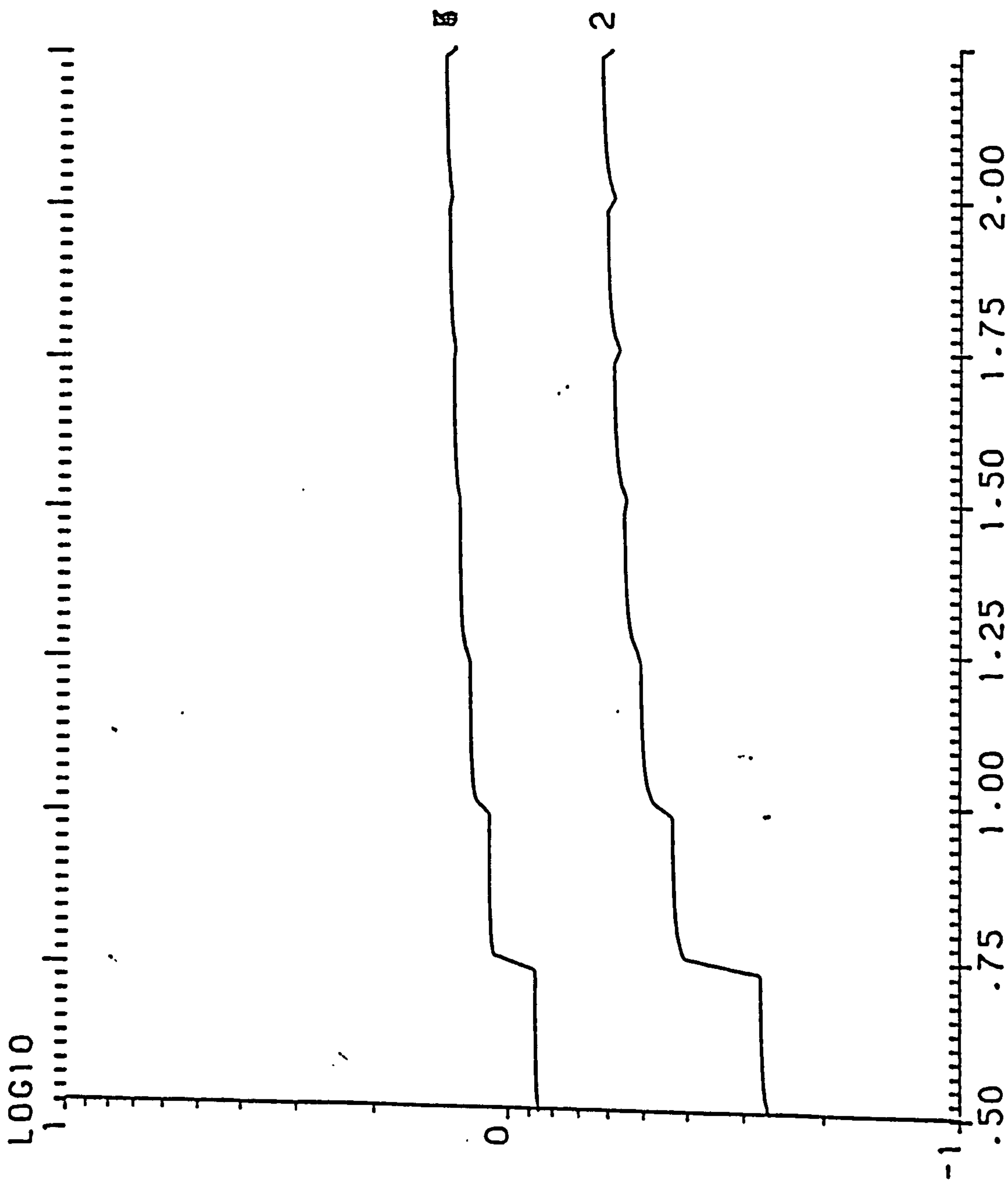

S. EFFICIENCY W. THICKNESS= .12M W. ORIENTATION=270.00

WD= 3M HD1= 22M HD2= 12M HOUSE T.=1.5 ST.

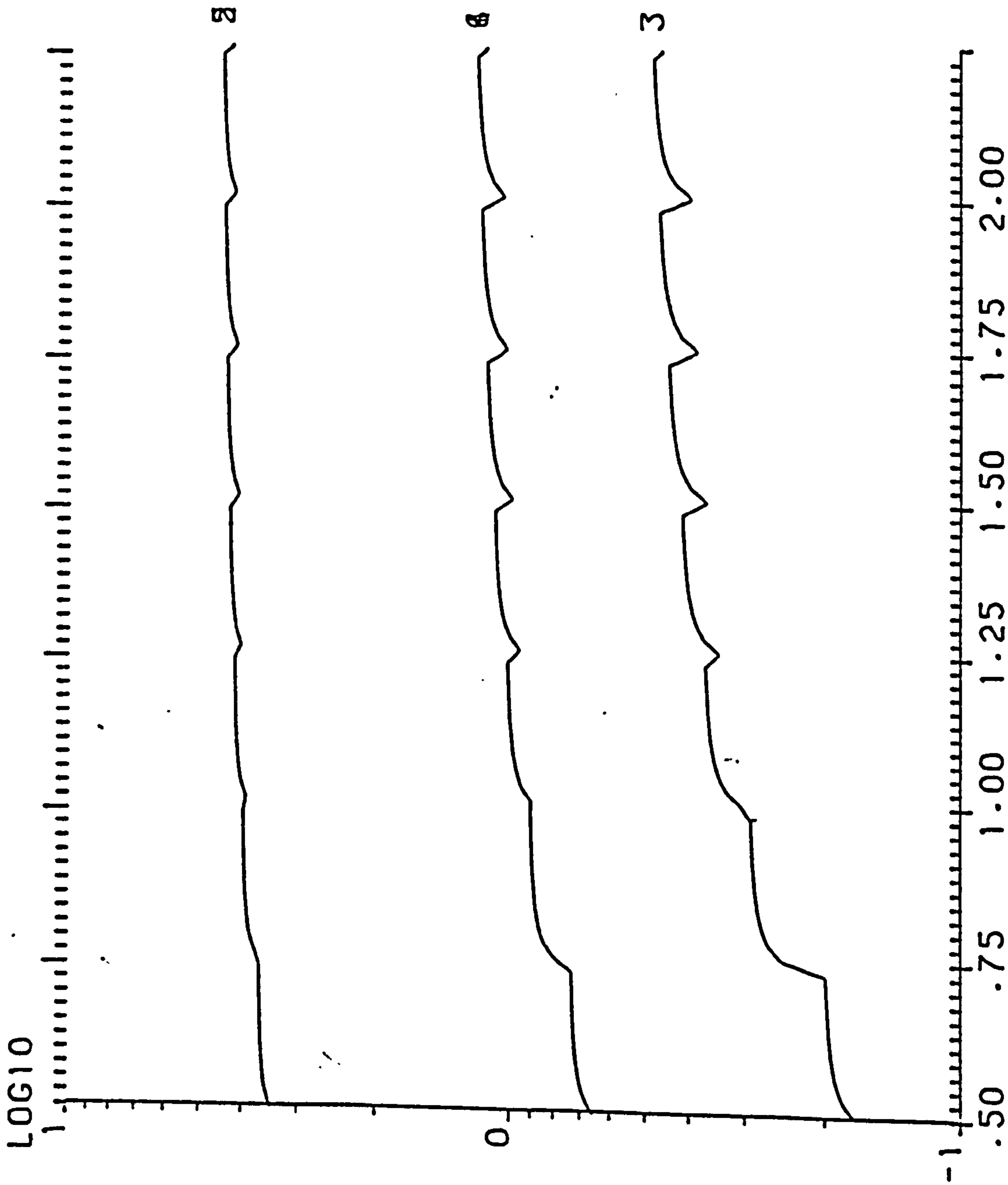

S. EFFICIENCY W. THICKNESS= .12M HD2= 12M HOUSE T.=1.5 ST.

WD= 3M HD1= 22M



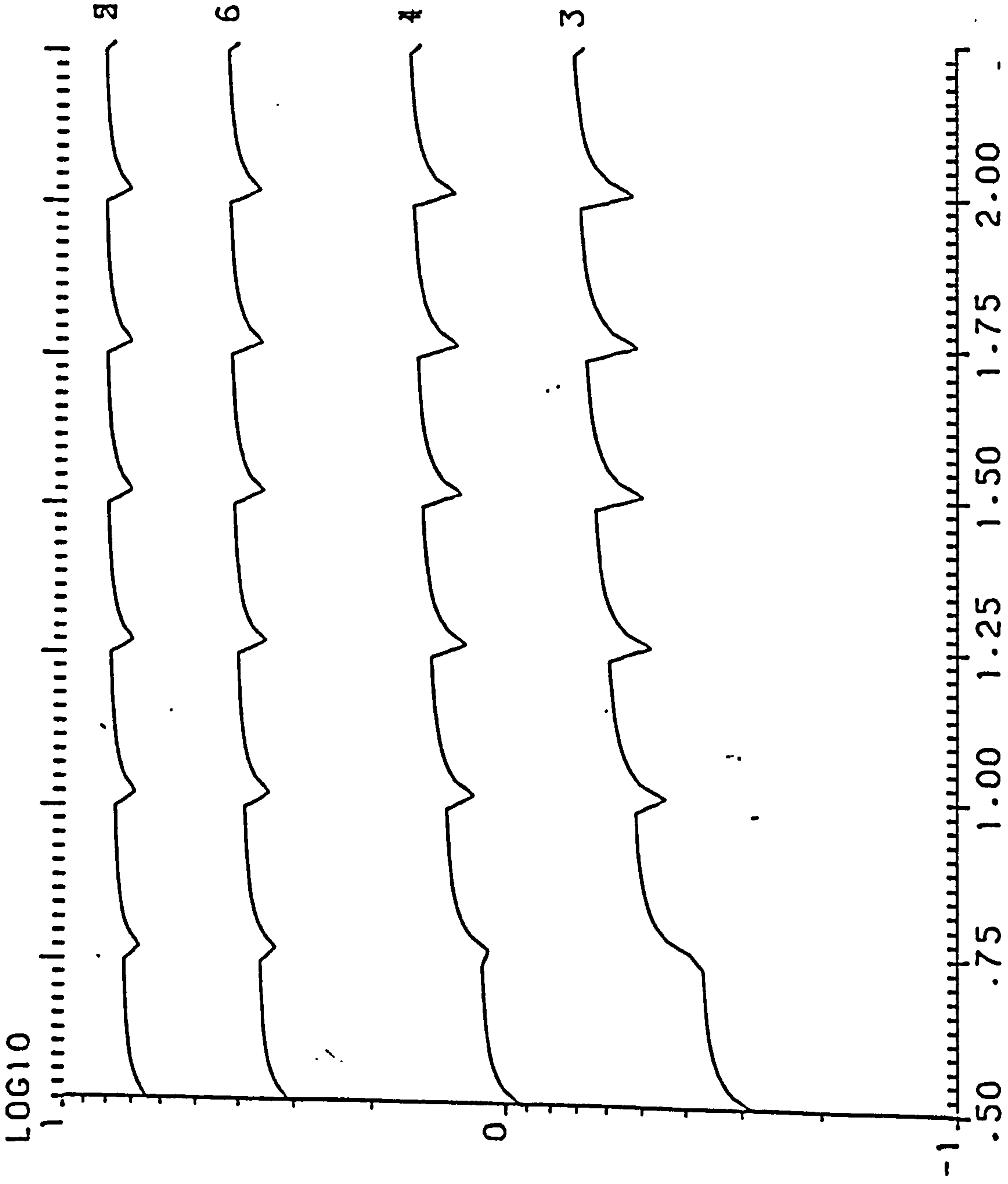

S. EFFICIENCY W. THICKNESS= .12M W. ORIENTATION=315.00

WD= 3M HD1= 22M HD2= 12M HOUSE T.=1.5 ST.



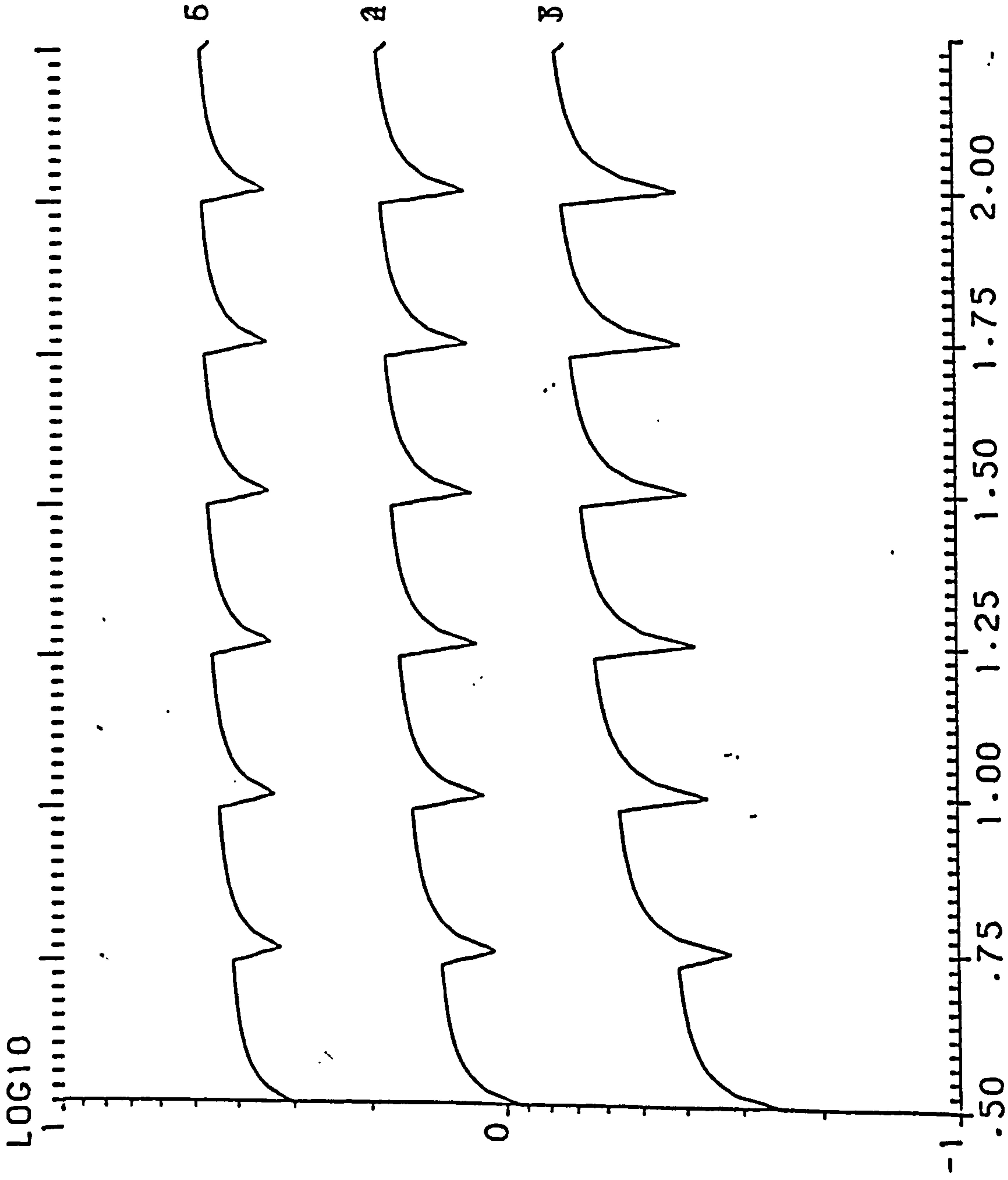

S. EFFICIENCY    W. THICKNESS = .12M    W. ORIENTATION = 337.50

WD = 3M    HD1 = 22M    HD2 = 12M    HOUSE T. = 1.5 ST.

LOG10

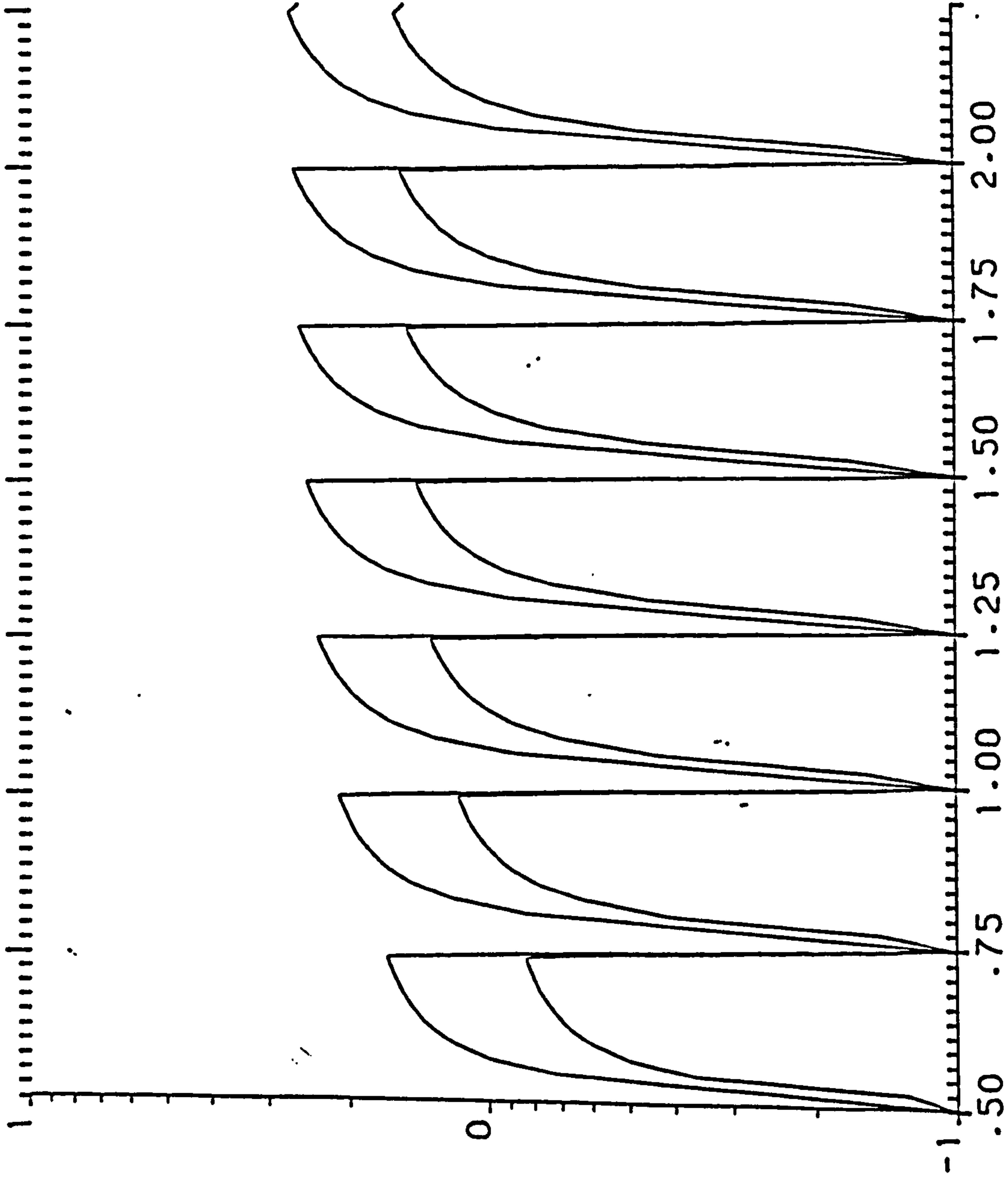

S. EFFICIENCY    W. THICKNESS=    .24M    W. ORIENTATION=    .00  
 WD=    3M    HD1= 22M    HD2= 12M    HOUSE T.=1.5 ST.

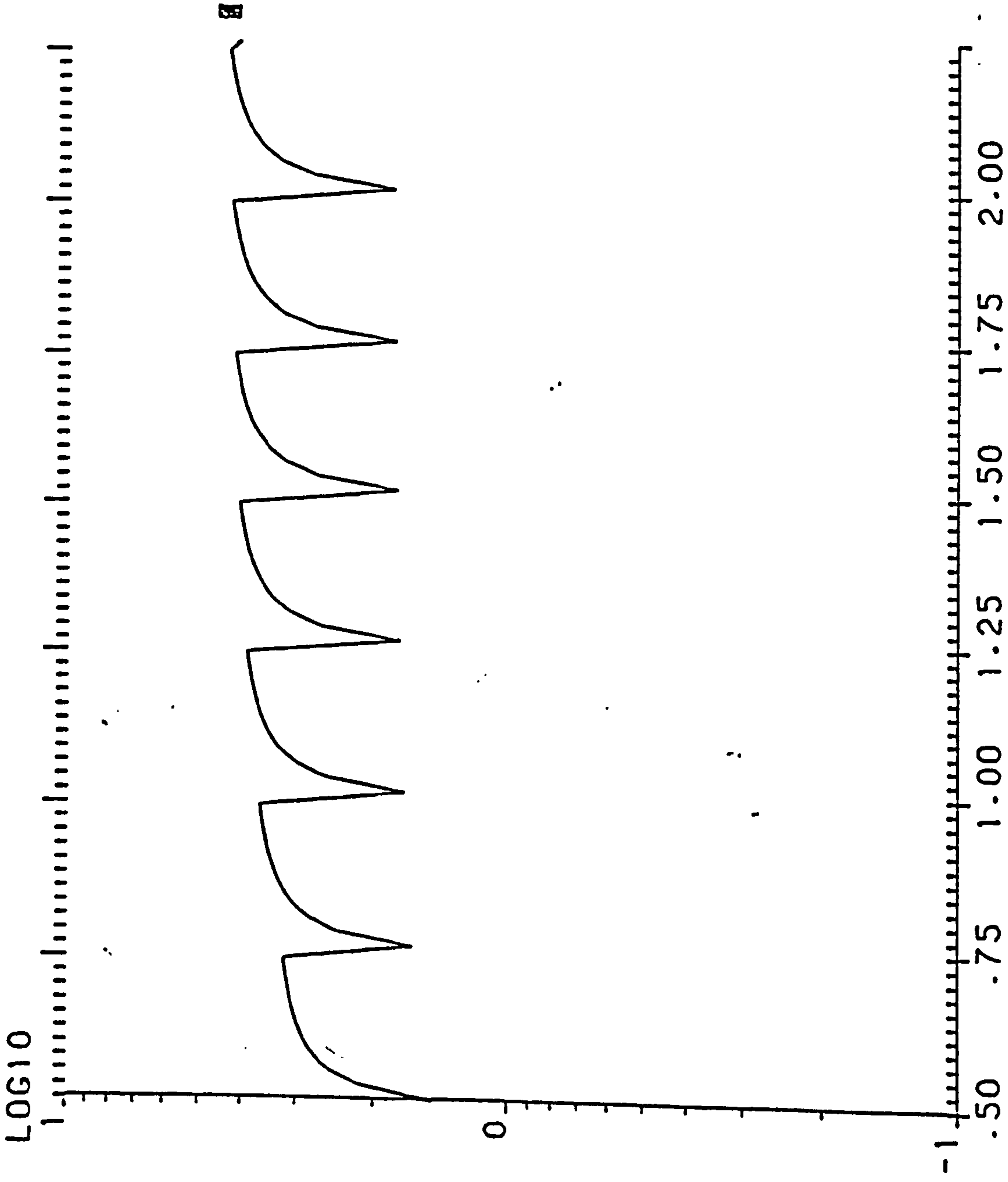

S. EFFICIENCY W. THICKNESS= .24M W. ORIENTATION= 22.50

WD= 3M HD1= 22M HD2= 12M HOUSE T.=1.5 ST.

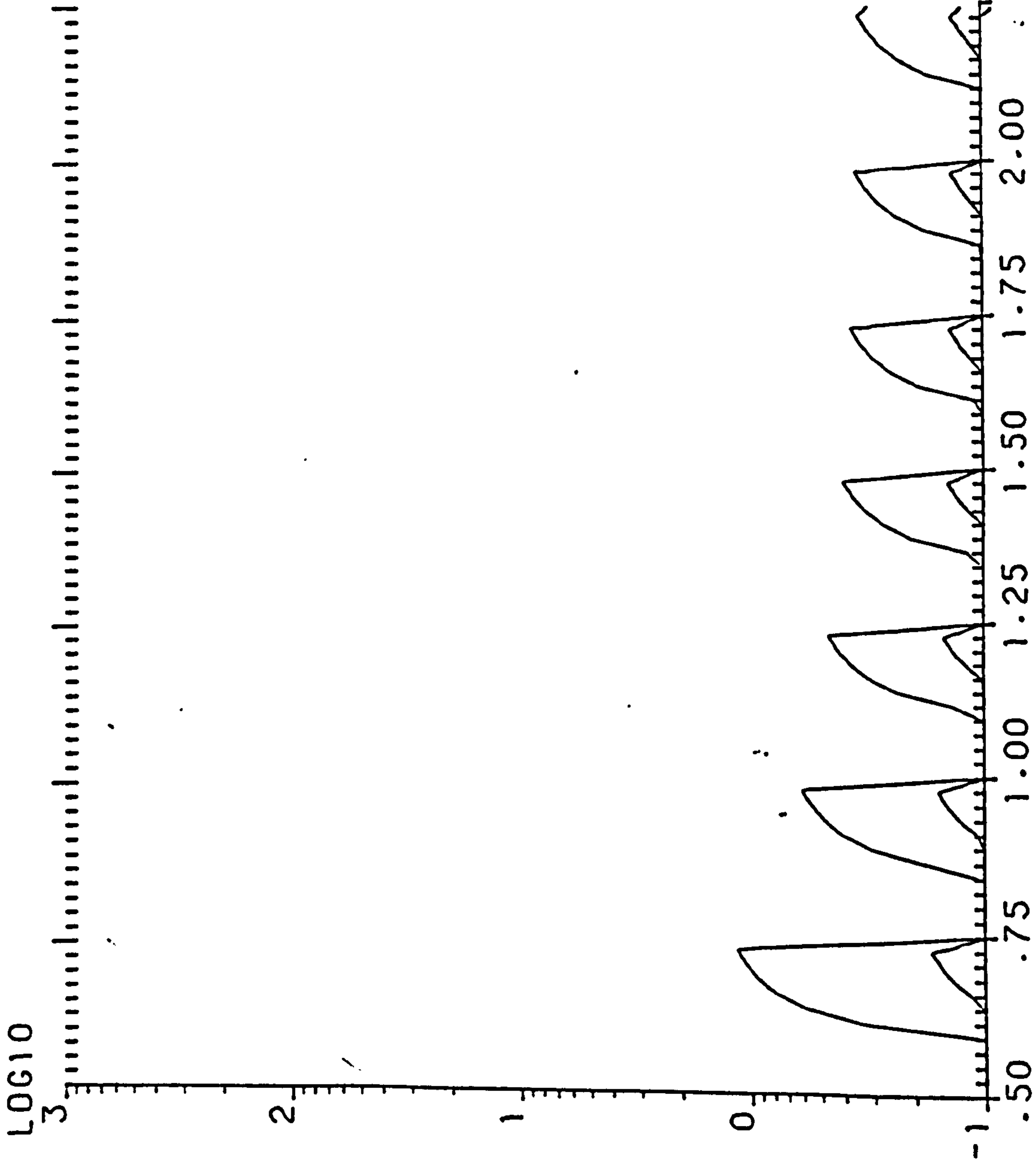

Y. EFFICIENCY W. THICKNESS = .24M W. ORIENTATION = 45.00

WD = 3M HD1 = 22M HD2 = 12M HOUSE T. = 1.5 ST.

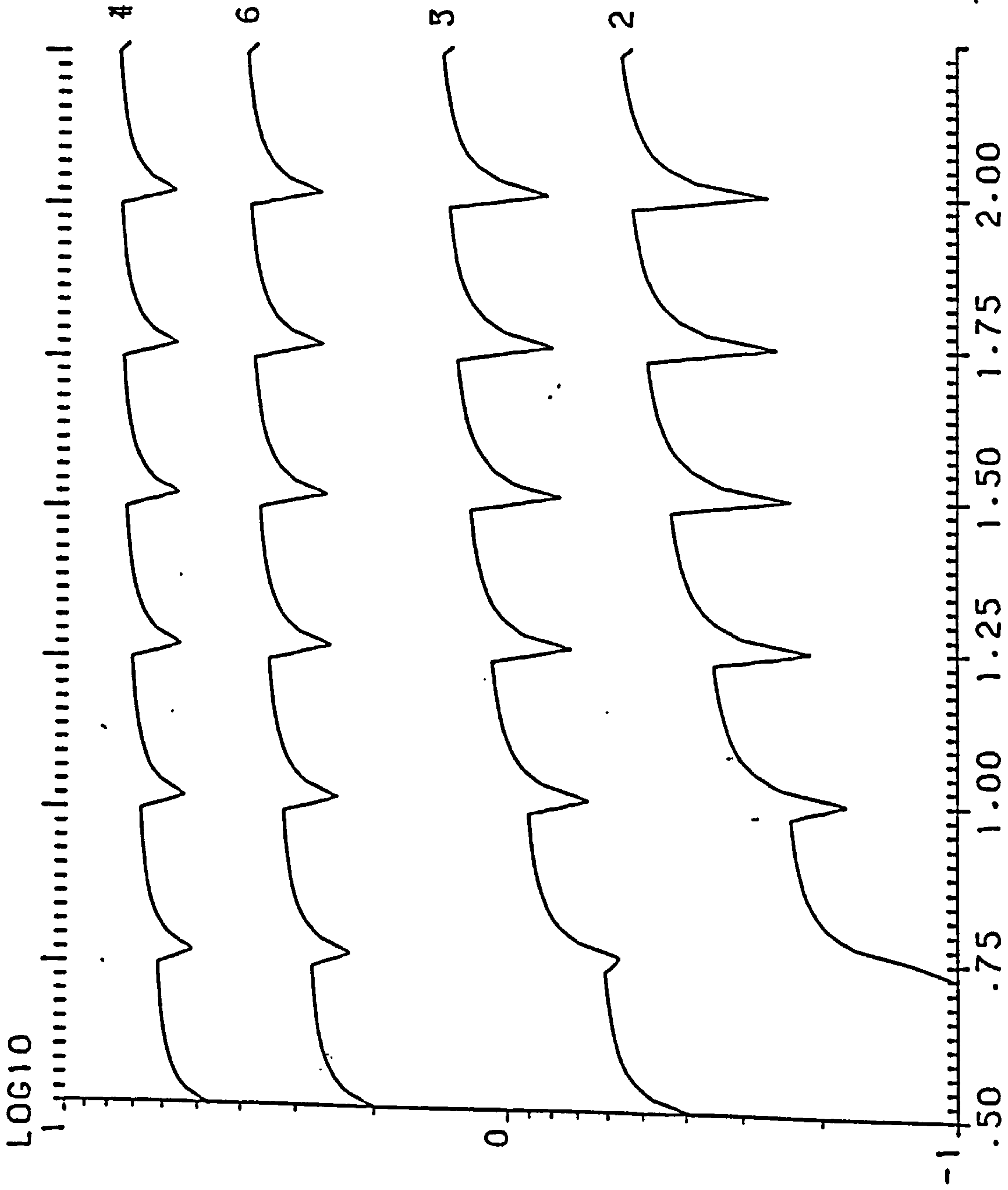

S. EFFICIENCY W. THICKNESS= .24M W. ORIENTATION= 45.00

WD= 3M HD1= 22M HD2= 12M HOUSE T.=1.5 ST.



LOG10  
3  
2  
1  
0  
-1

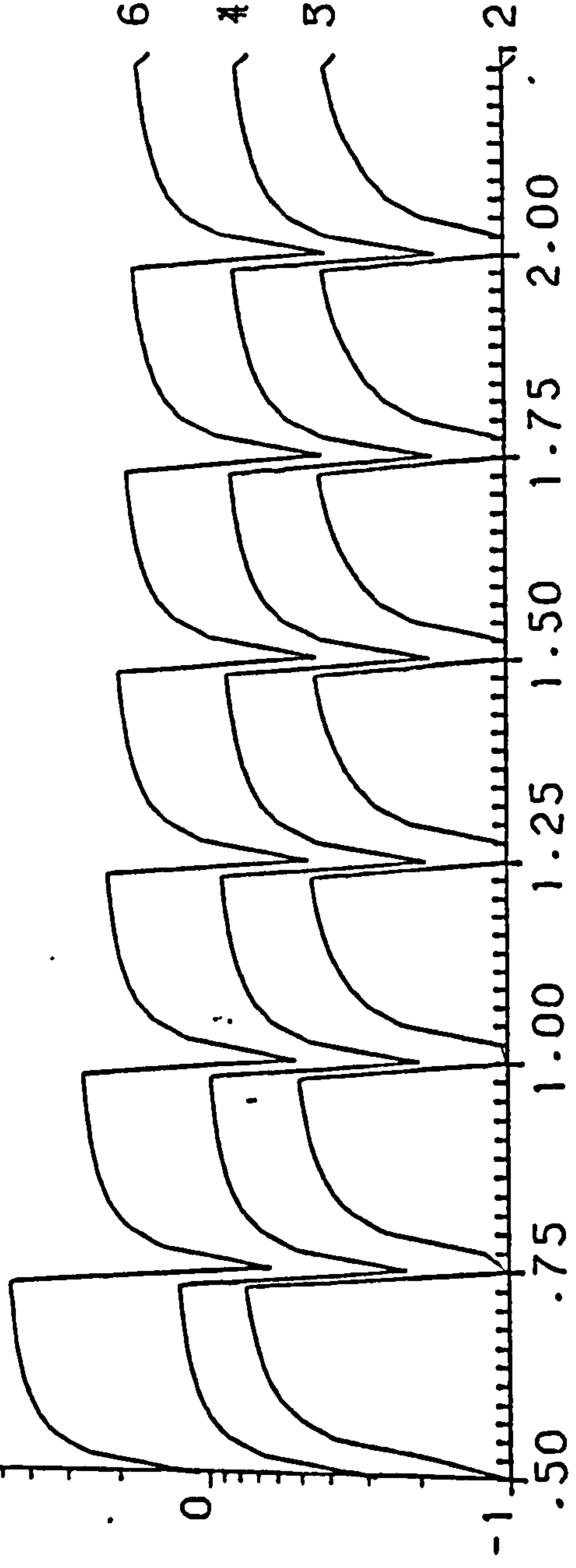
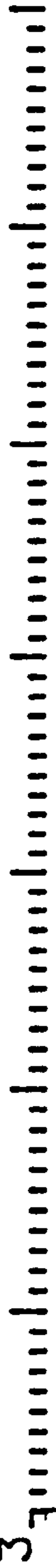

Y. EFFICIENCY W. THICKNESS= .24M W. ORIENTATION= 67.50

WD= 3M HD1= 22M HD2= 12M HOUSE T.=1.5 ST.

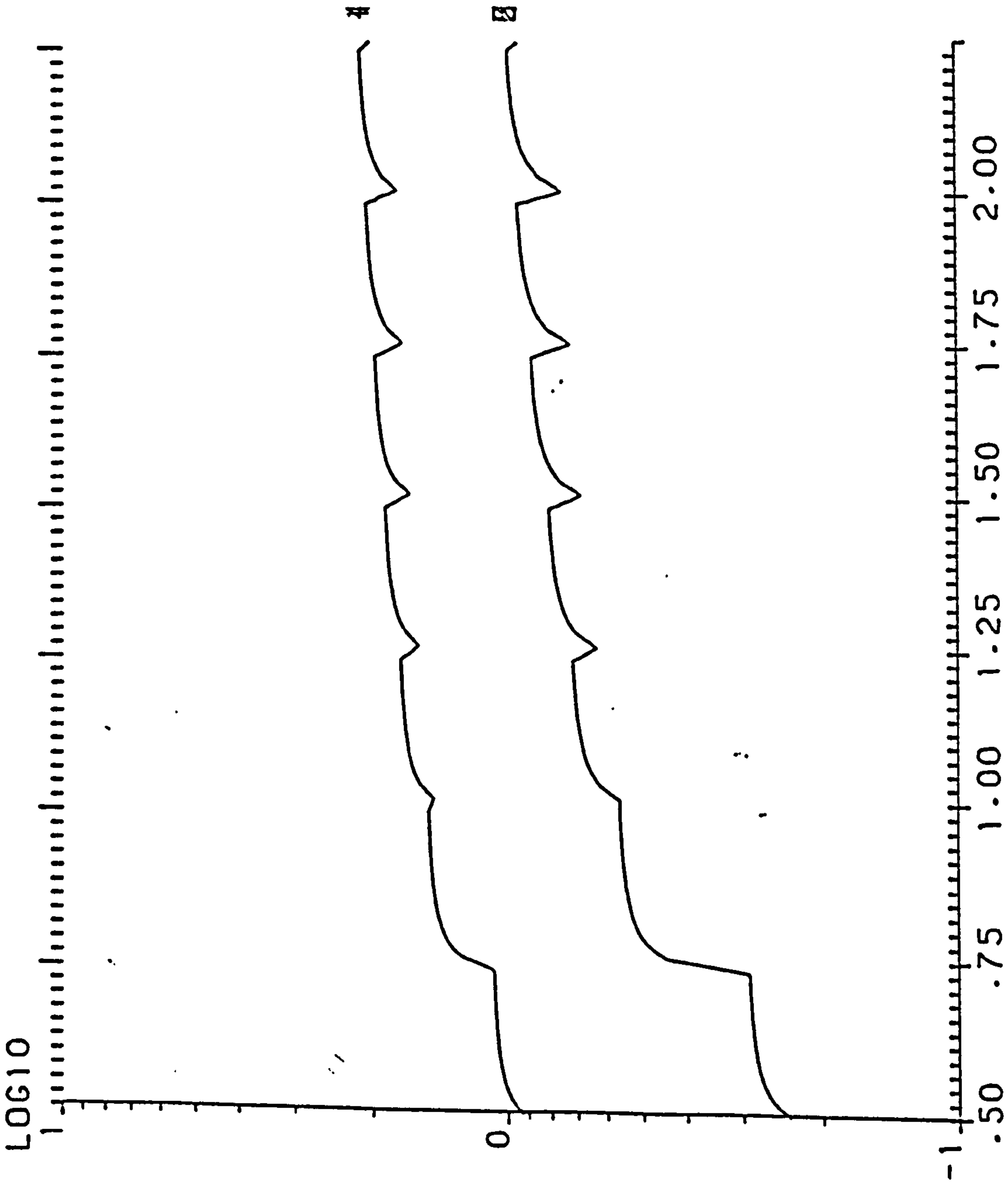

S. EFFICIENCY W. THICKNESS= .24M W. ORIENTATION= 67.50

WD= 3M HD1= 22M HD2= 12M HOUSE T.=1.5 ST.

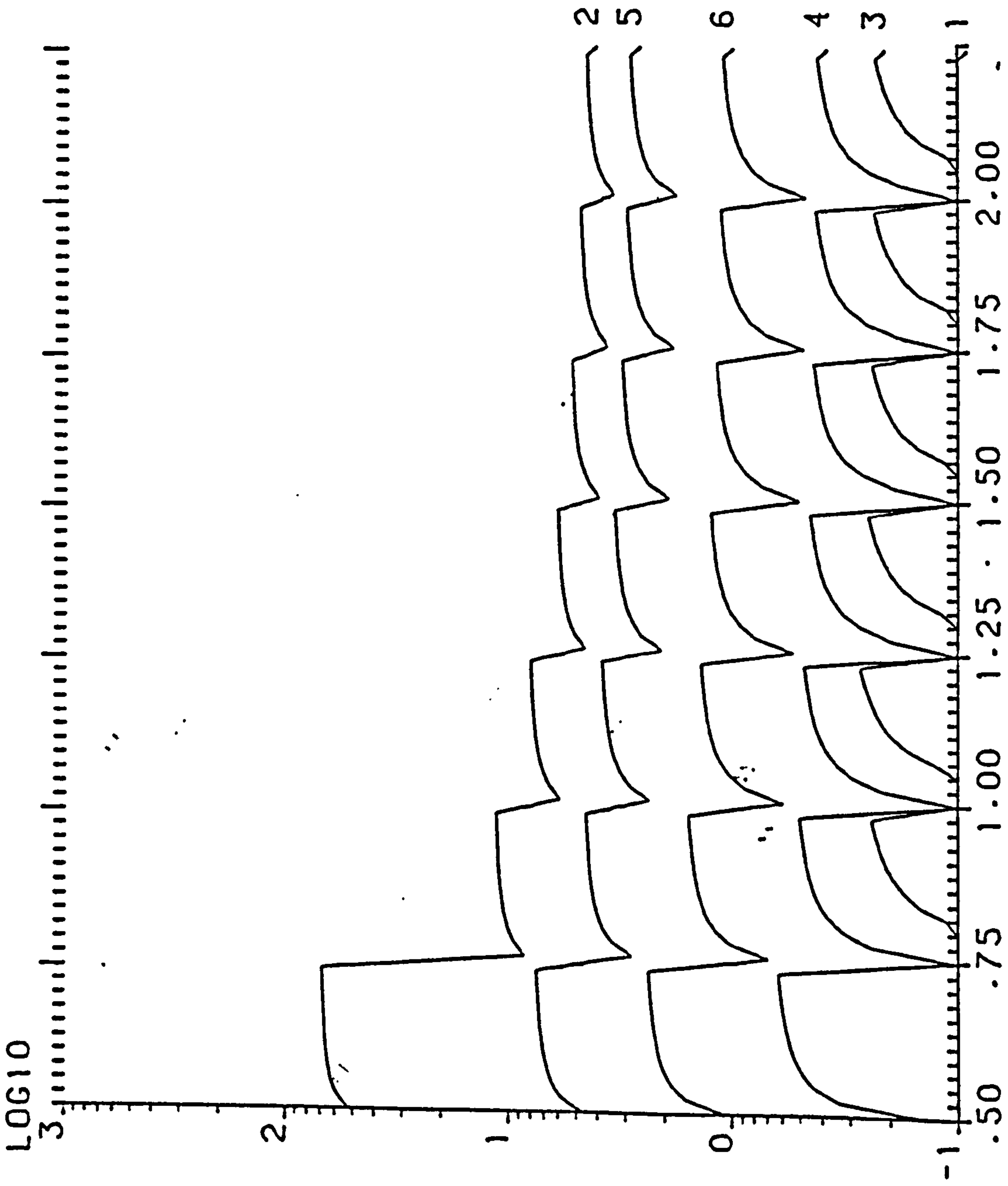

Y. EFFICIENCY W. THICKNESS= .24M W. ORIENTATION= 90.00

WD= 3M HD1= 22M HD2= 12M HOUSE T.=1.5 ST.

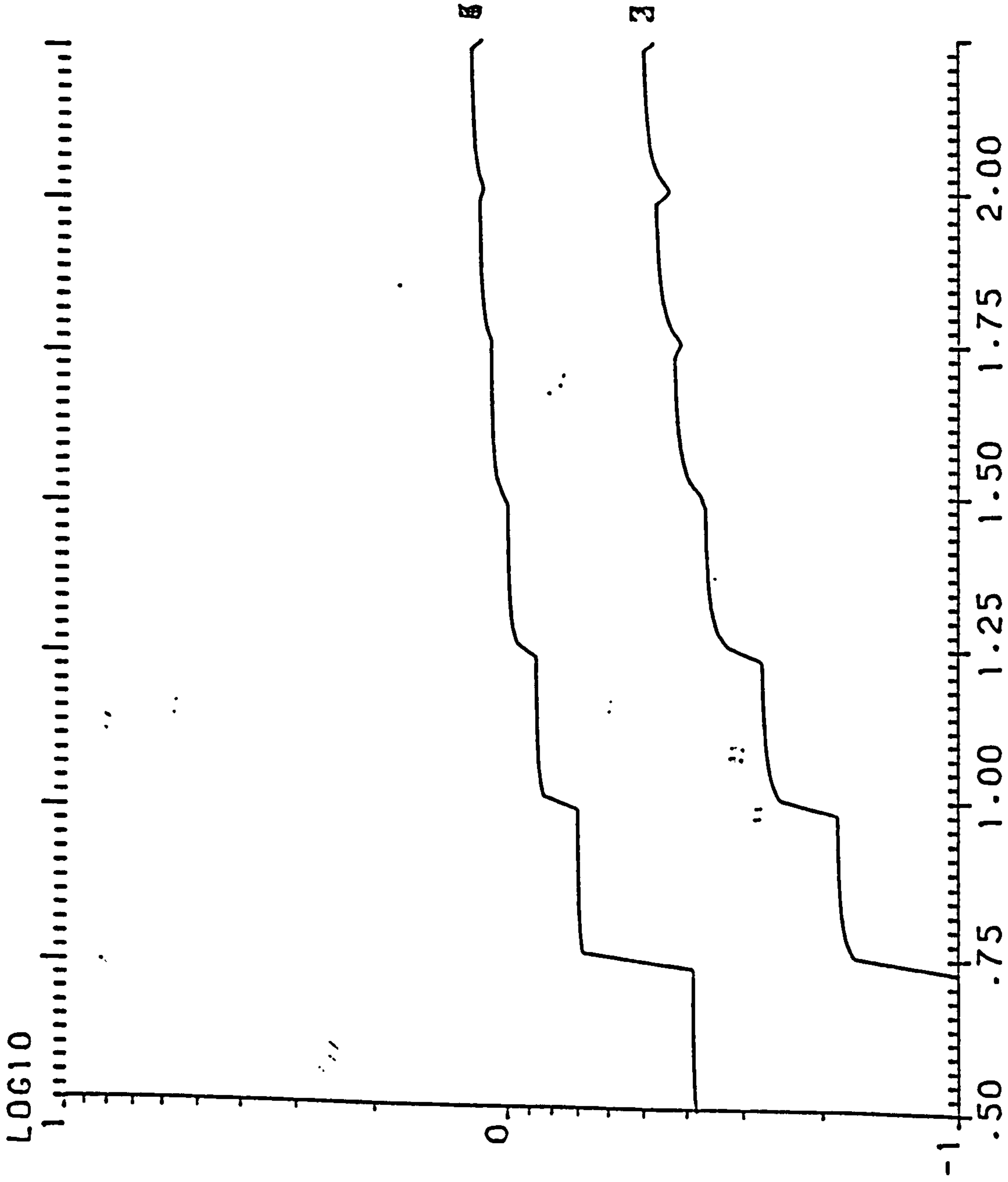

S. EFFICIENCY W. THICKNESS= .24M W. ORIENTATION= 90.00

WD= 3M HD1= 22M HD2= 12M HOUSE T.=1.5 ST.



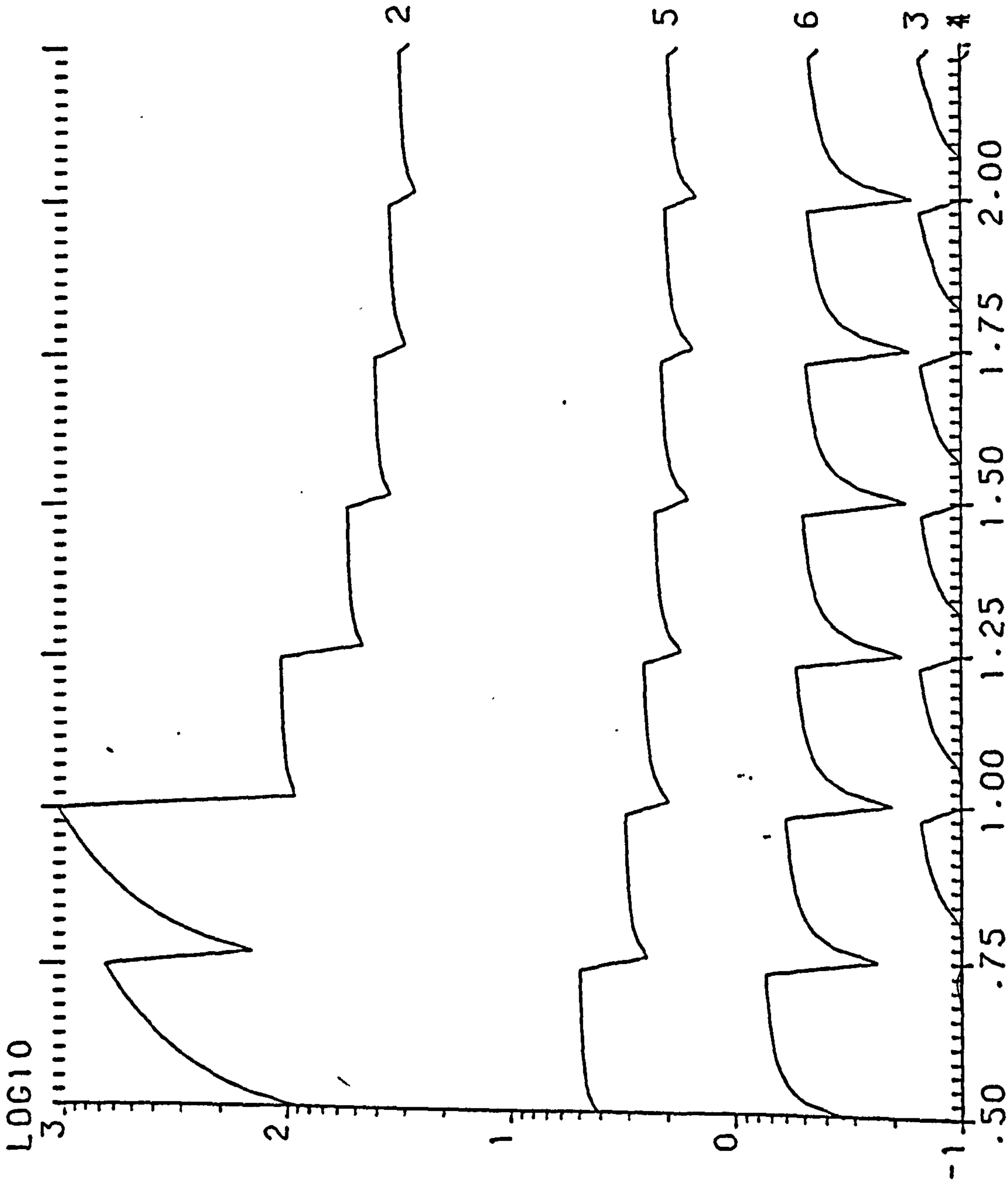

Y. EFFICIENCY W. THICKNESS= .24M W. ORIENTATION=112.50

WD= 3M HD1= 22M HD2= 12M HOUSE T.=1.5 ST.



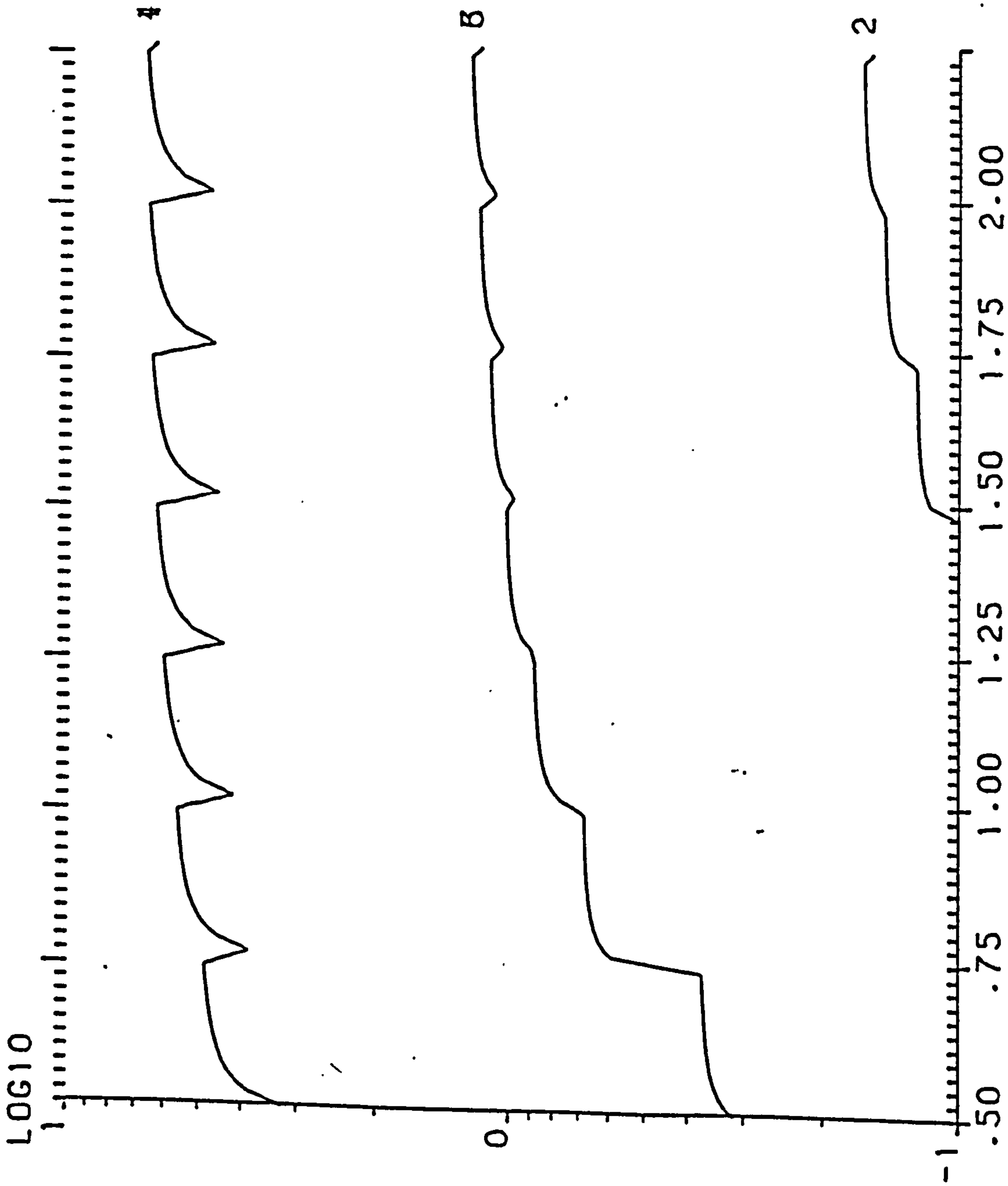

S. EFFICIENCY W. THICKNESS= .24M W. ORIENTATION=112.50

WD= 3M HD1= 22M HD2= 12M HOUSE T.=1.5 ST.



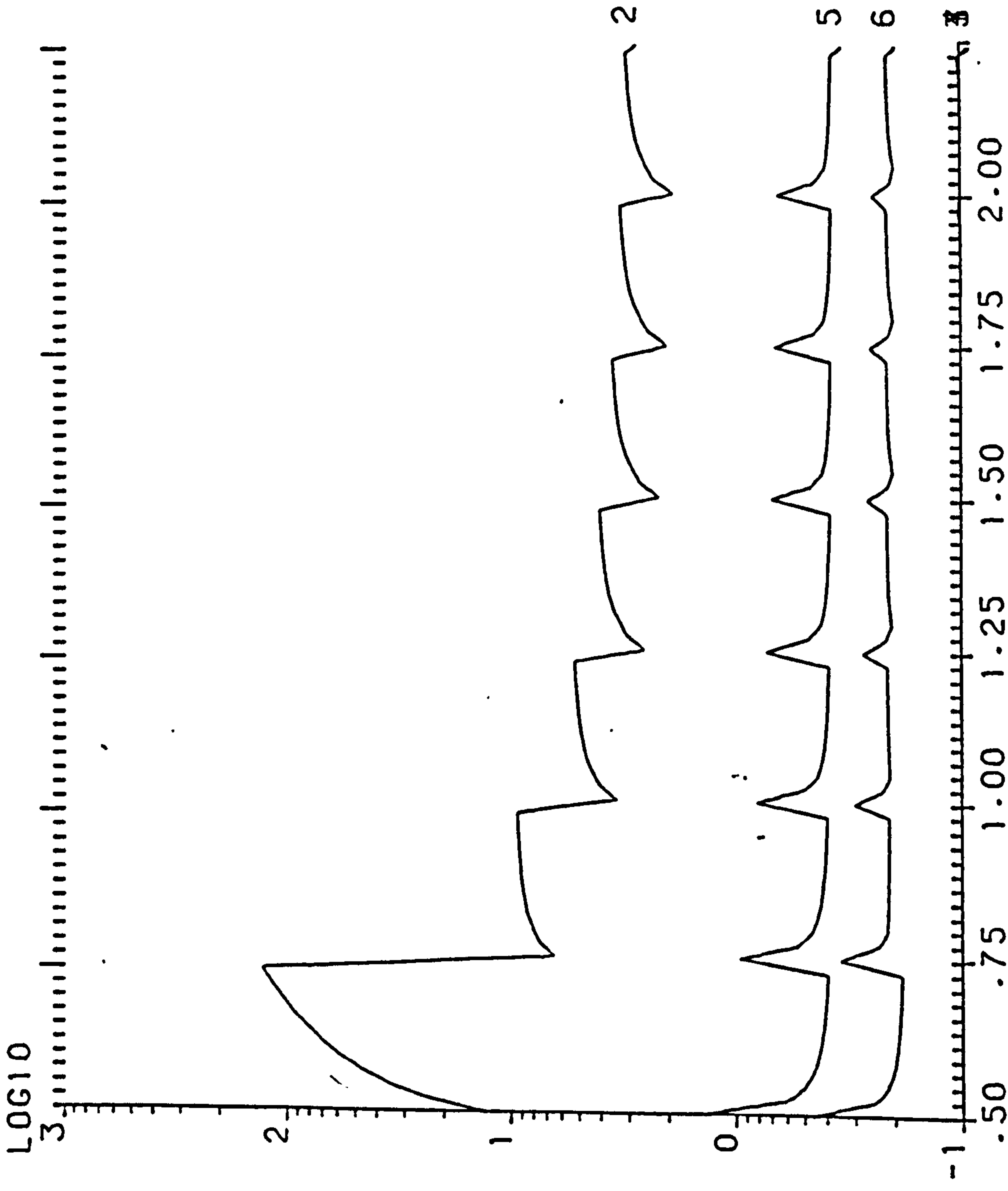

Y. EFFICIENCY W. THICKNESS= .24M W. ORIENTATION=135.00

WD= 3M HD1= 22M HD2= 12M HOUSE T.=1.5 ST.

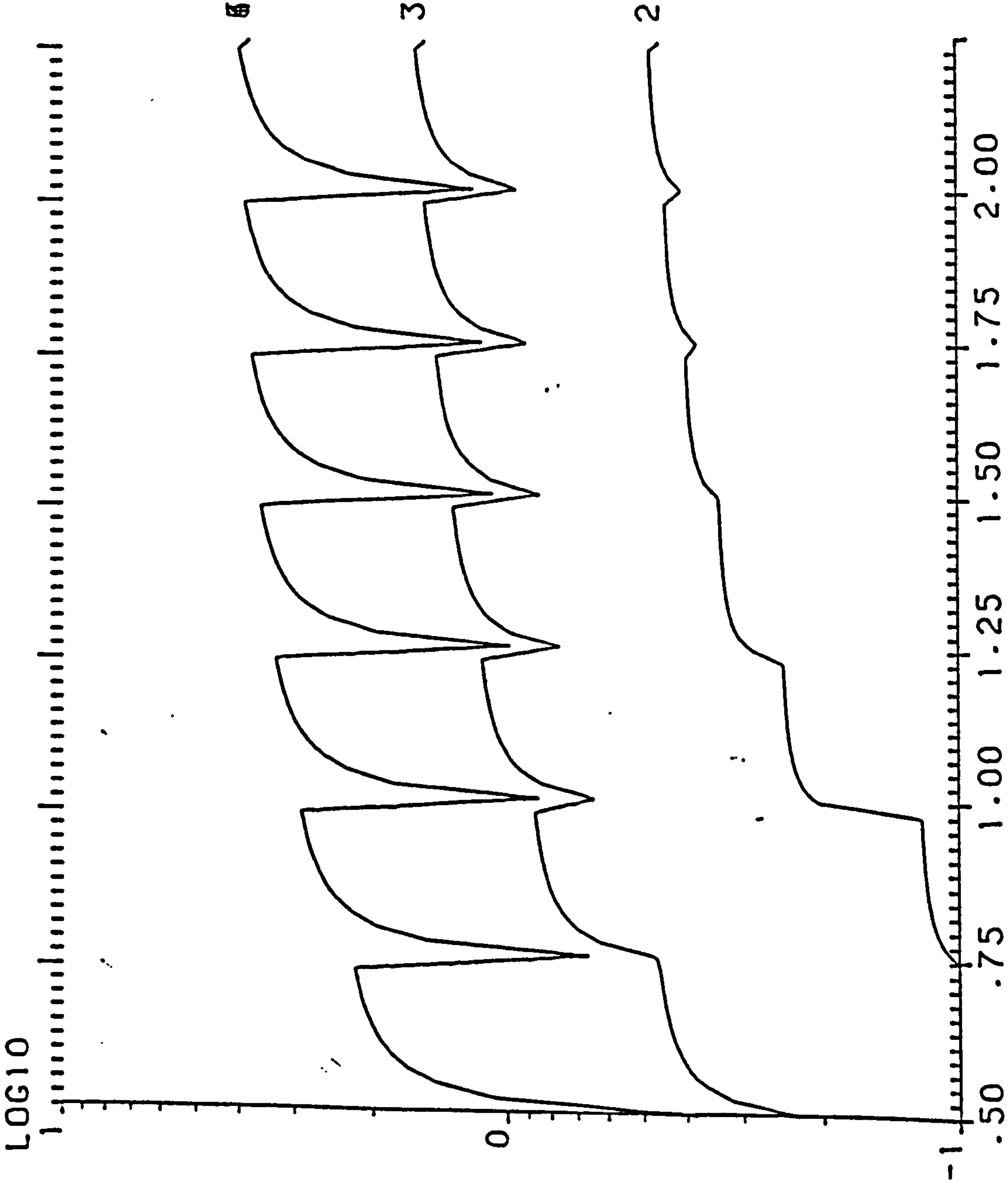

S. EFFICIENCY W. THICKNESS= .24M W. ORIENTATION=135.00

WD= 3M HD1= 22M HD2= 12M HOUSE T.=1.5 ST.



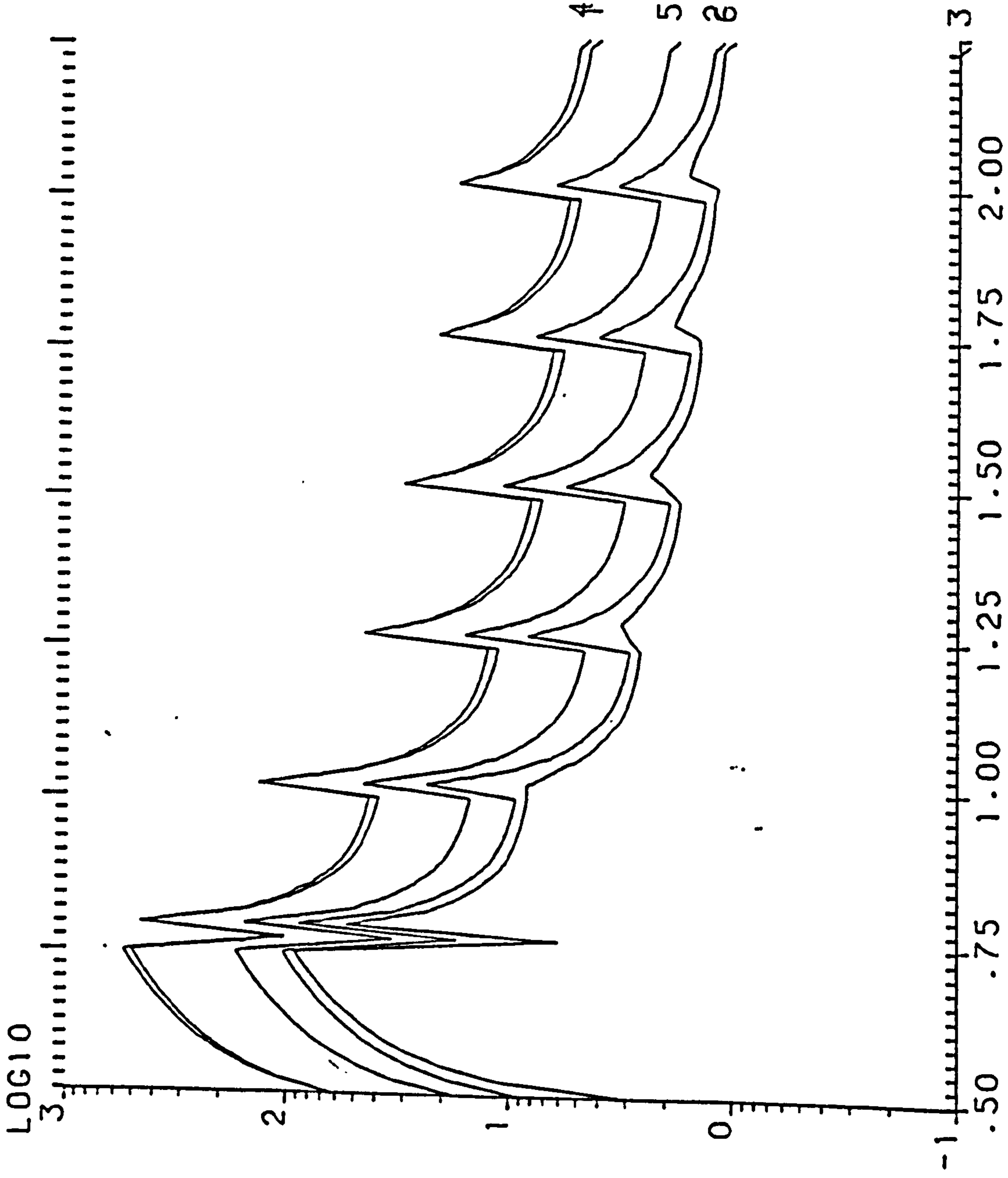

Y. EFFICIENCY    W. THICKNESS=    .24M    W. ORIENTATION=157.50

WD= 3M    HD1= 22M    HD2= 12M    HOUSE T.=1.5 ST.

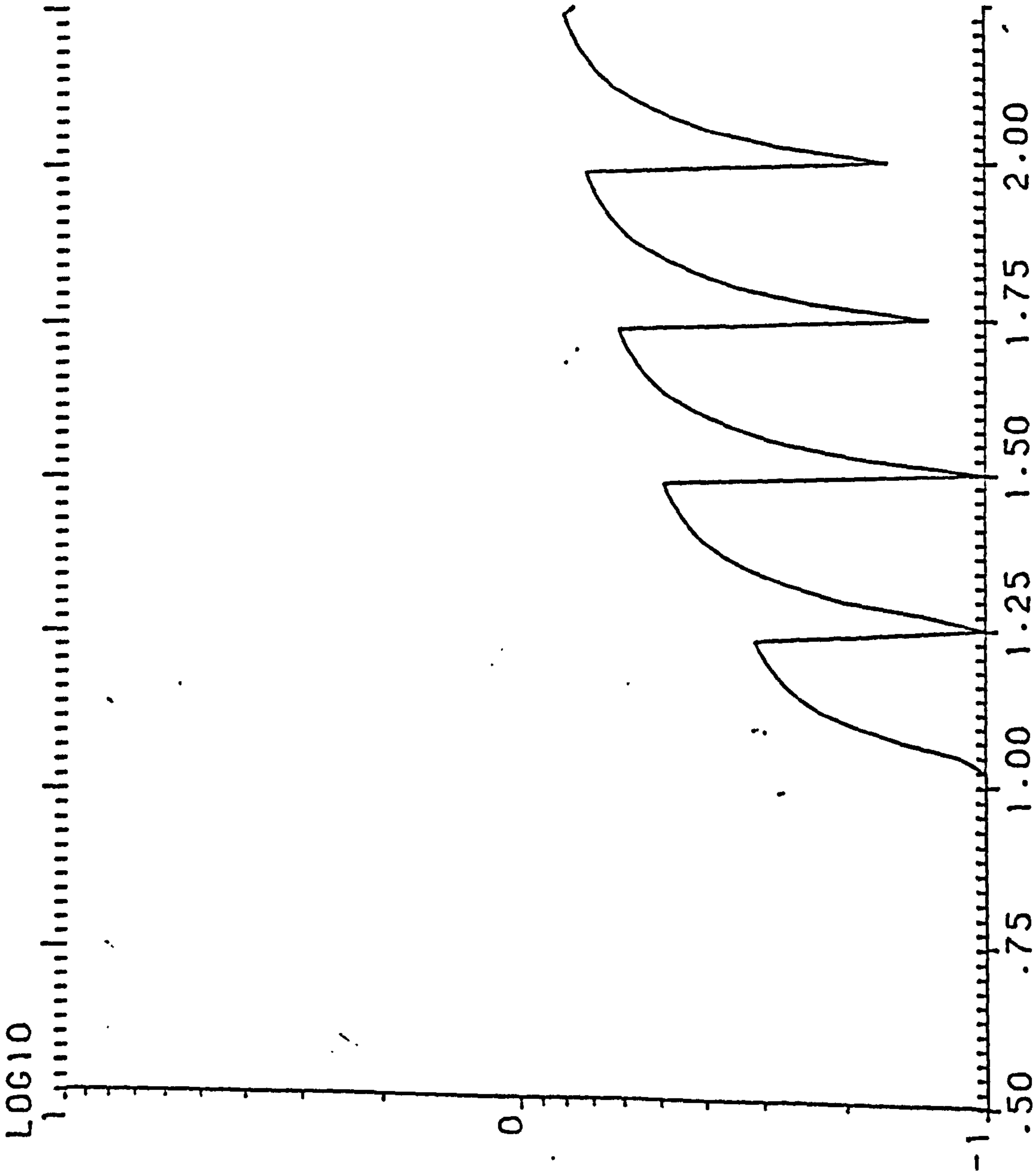

S. EFFICIENCY W. THICKNESS= .24M W. ORIENTATION=157.50

WD= 3M HD1= 22M HD2= 12M HOUSE T.=1.5 ST.



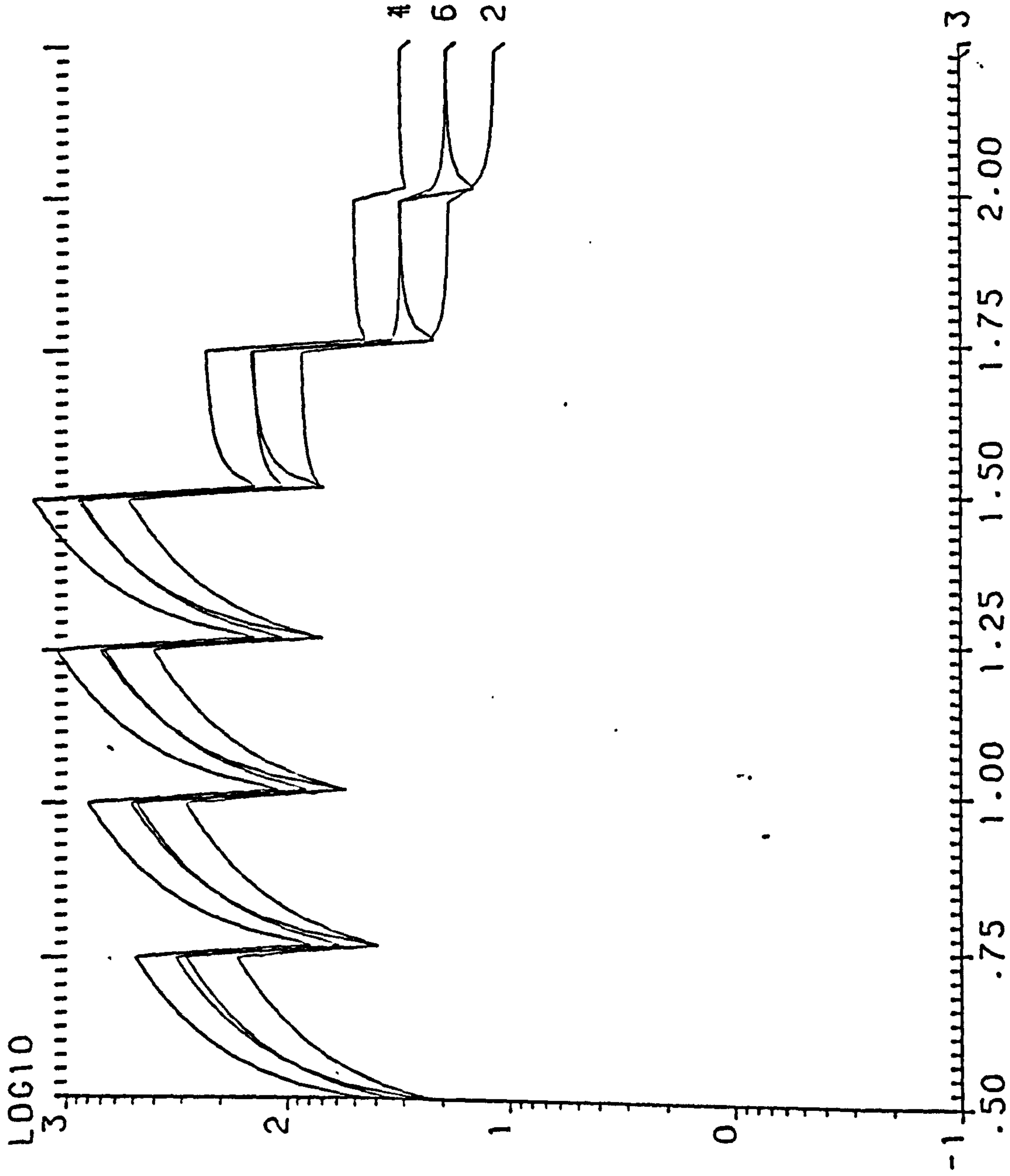

Y. EFFICIENCY W. THICKNESS= .24M W. ORIENTATION=180.00  
 WD= 3M HD1= 22M HD2= 12M HOUSE T.=1.5 ST.

LOG10  
1  
0  
-1

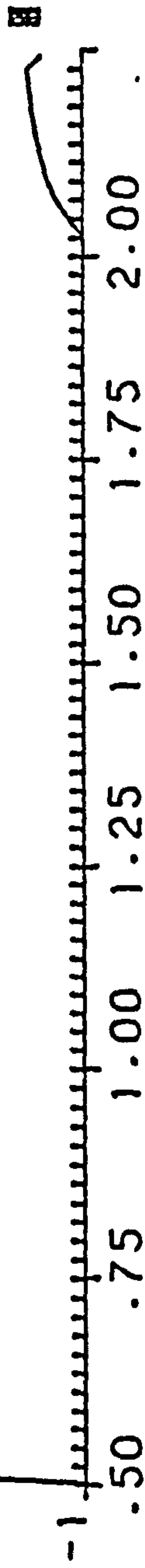

.50 .75 1.00 1.25 1.50 1.75 2.00  
S. EFFICIENCY W. THICKNESS= .24M W. ORIENTATION=180.00

WD= 3M HD1= 22M HD2= 12M HOUSE T.=1.5 ST.

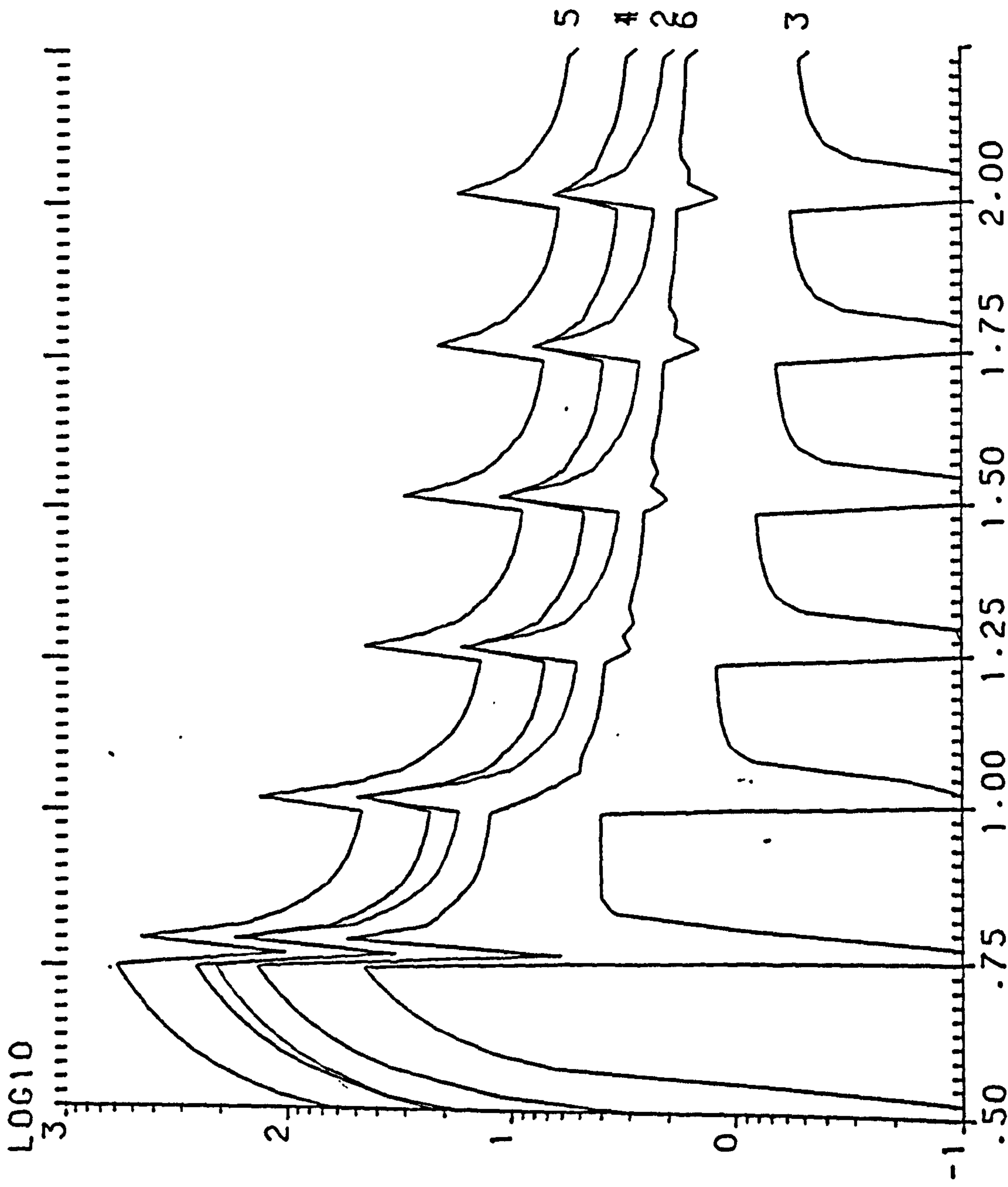

Y. EFFICIENCY W. THICKNESS= .24M W. ORIENTATION=202.50

WD= 3M HD1= 22M HD2= 12M HOUSE T.=1.5 ST.

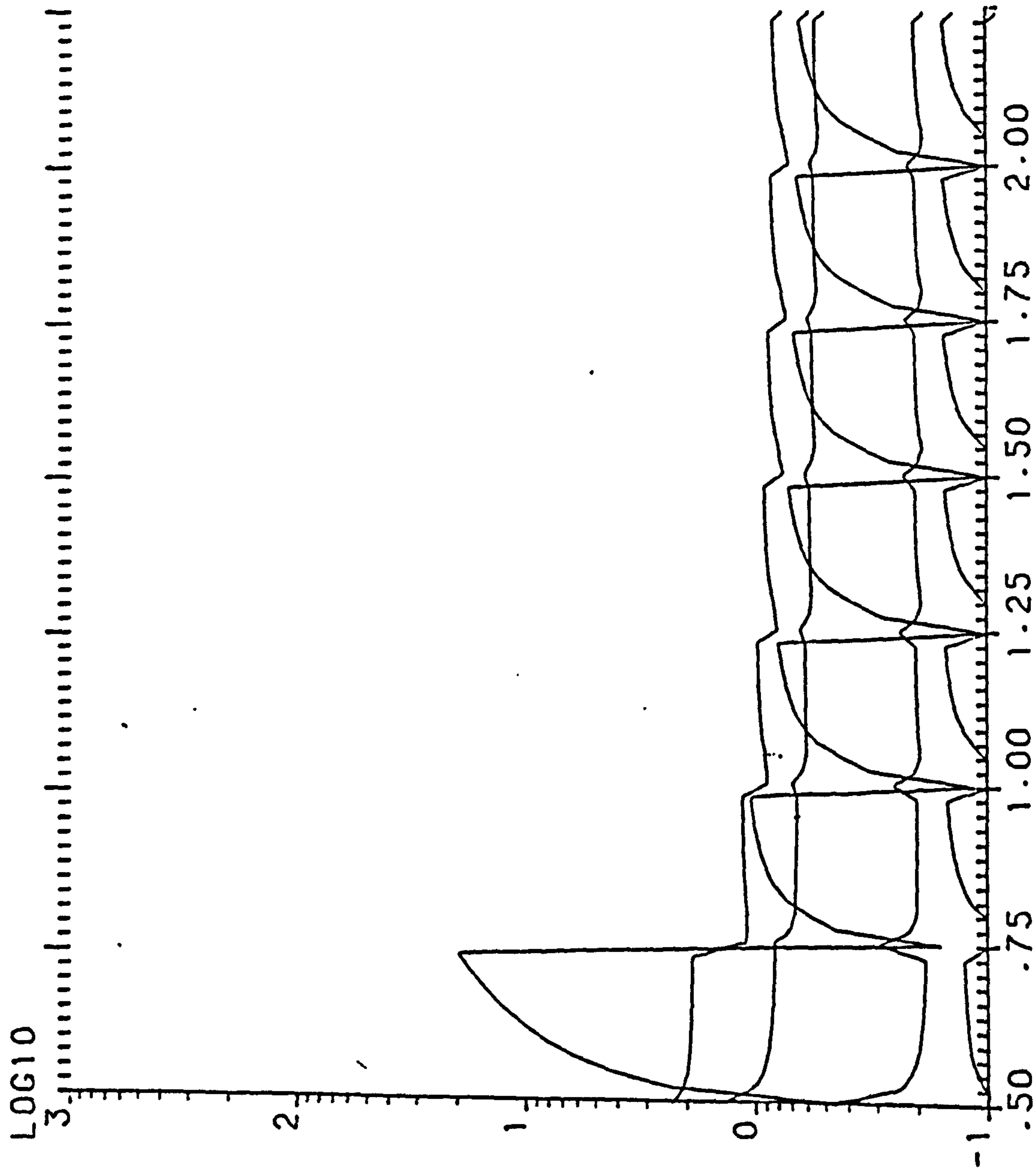

Y. EFFICIENCY W. THICKNESS= .24M W. ORIENTATION=225.00

WD= 3M HD1= 22M HD2= 12M HOUSE T.=1.5 ST.

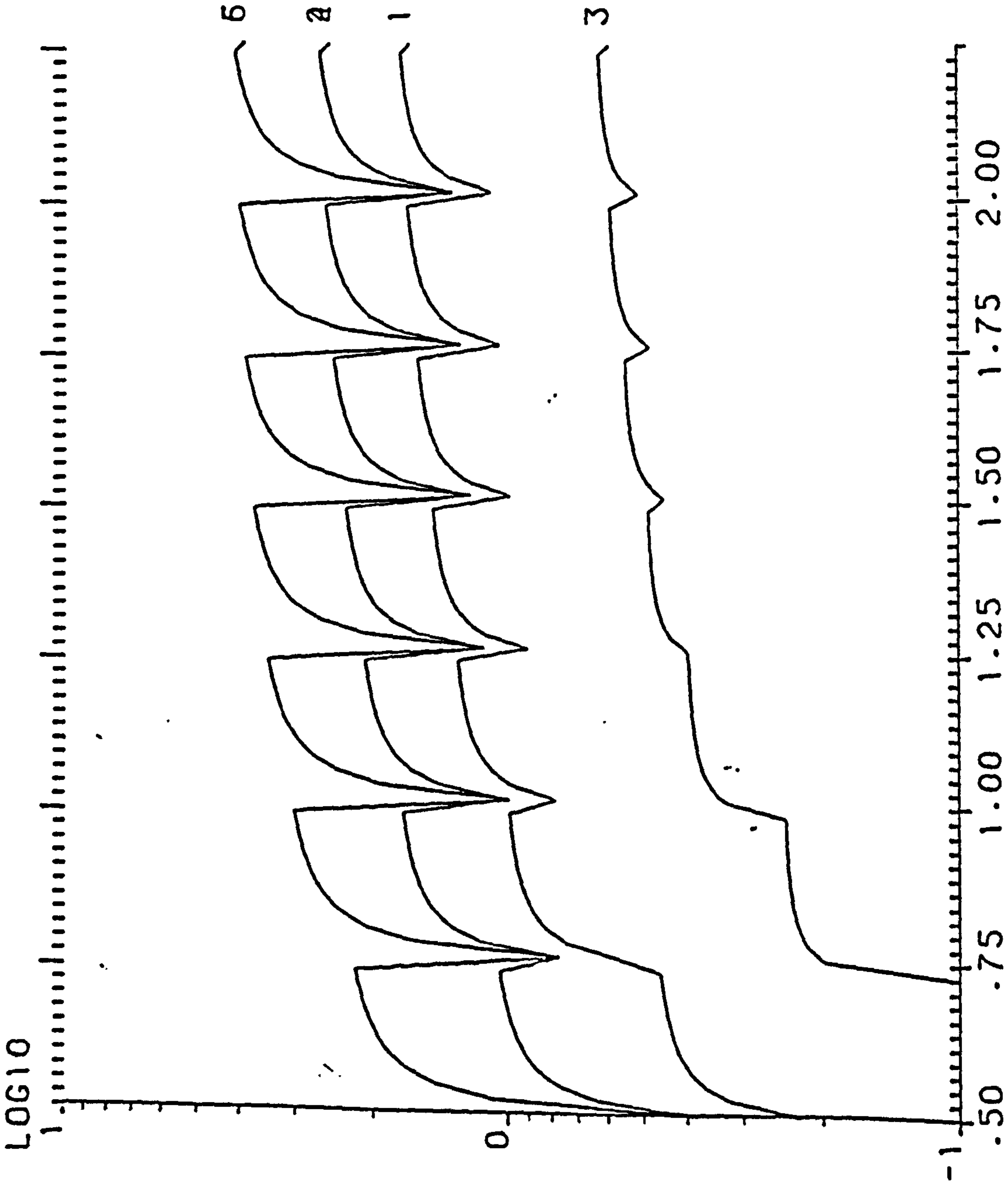

S. EFFICIENCY W. THICKNESS= .24M W. ORIENTATION=225.00

WD= 3M HD1= 22M HD2= 12M HOUSE T.=1.5 ST.



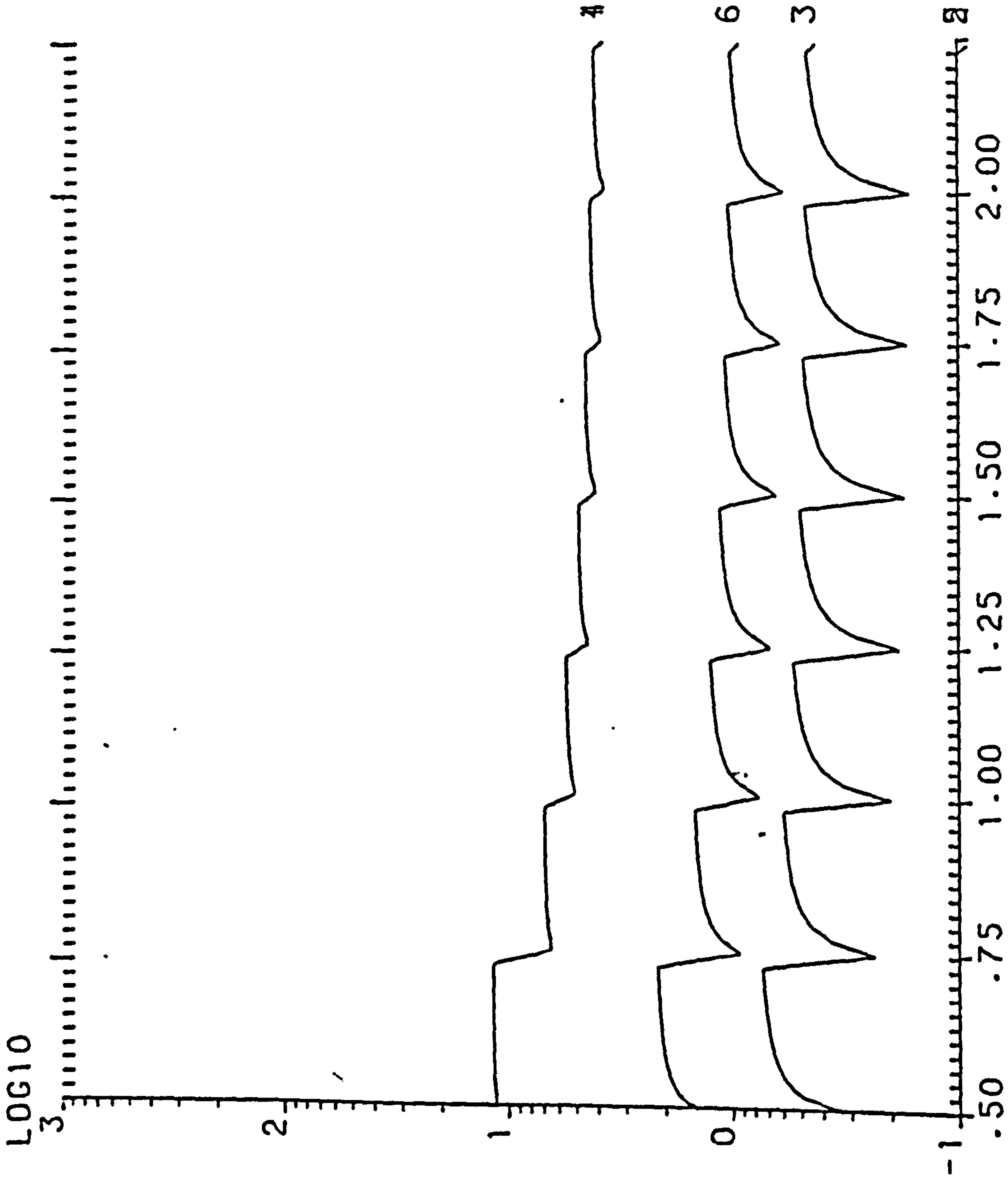

Y. EFFICIENCY W. THICKNESS= .24M W. ORIENTATION=247.50

WD= 3M HD1= 22M HD2= 12M HOUSE T.=1.5 ST.

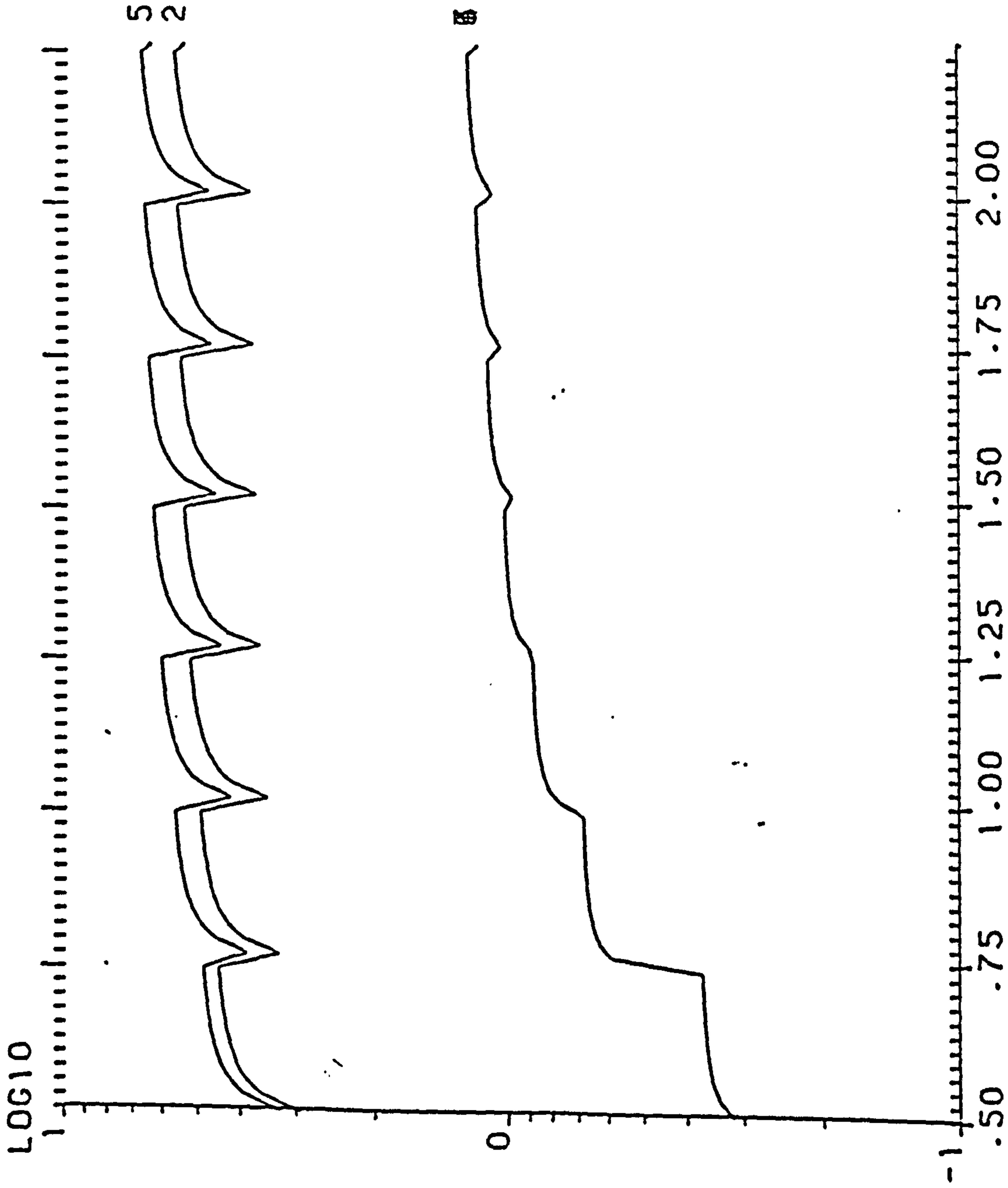

S. EFFICIENCY W. THICKNESS= .24M W. ORIENTATION=247.50

WD= 3M HD1= 22M HD2= 12M HOUSE T.=1.5 ST.



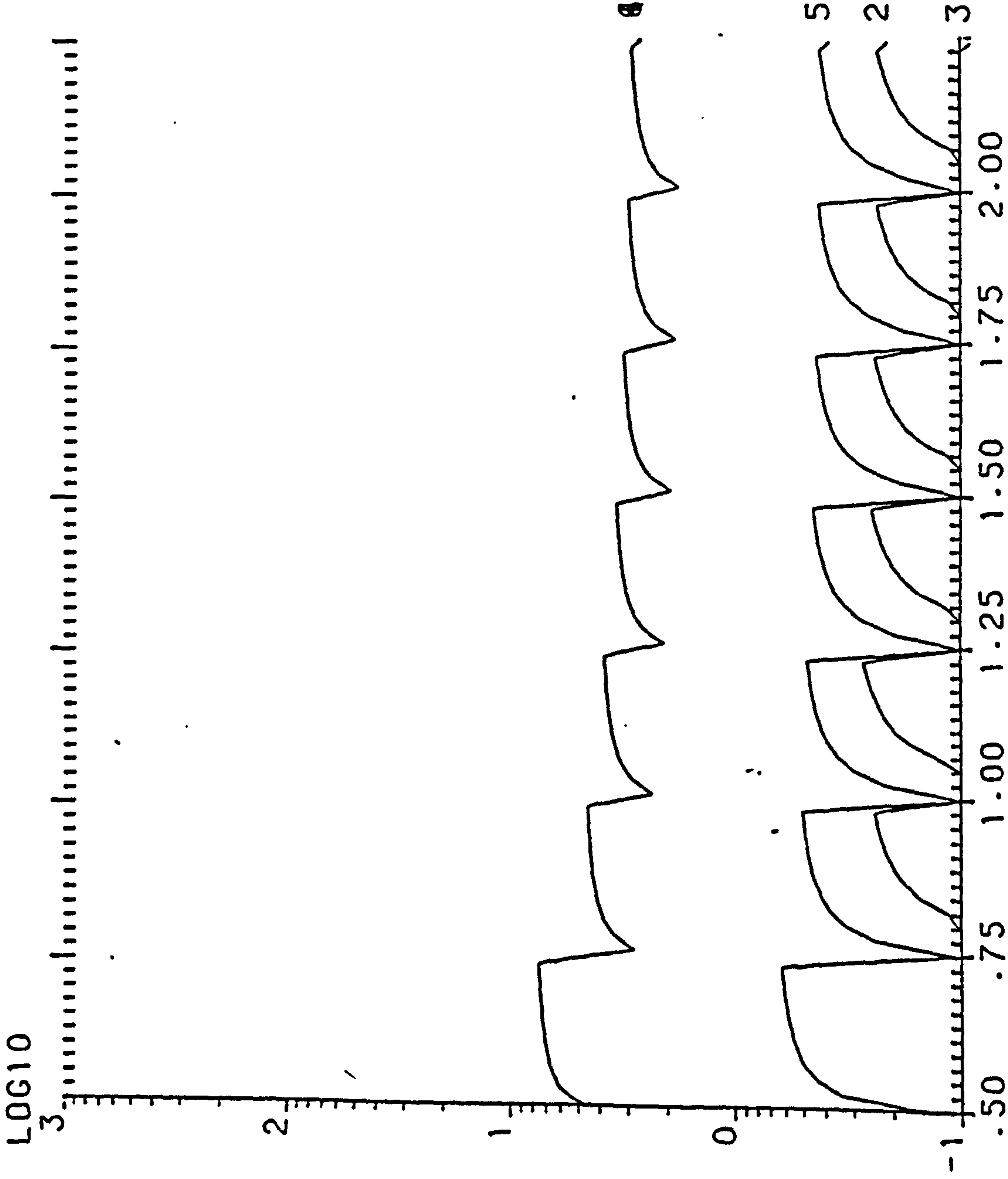

Y. EFFICIENCY W. THICKNESS= .24M W. ORIENTATION=270.00

WD= 3M HD1= 22M HD2= 12M HOUSE T.=1.5 ST.

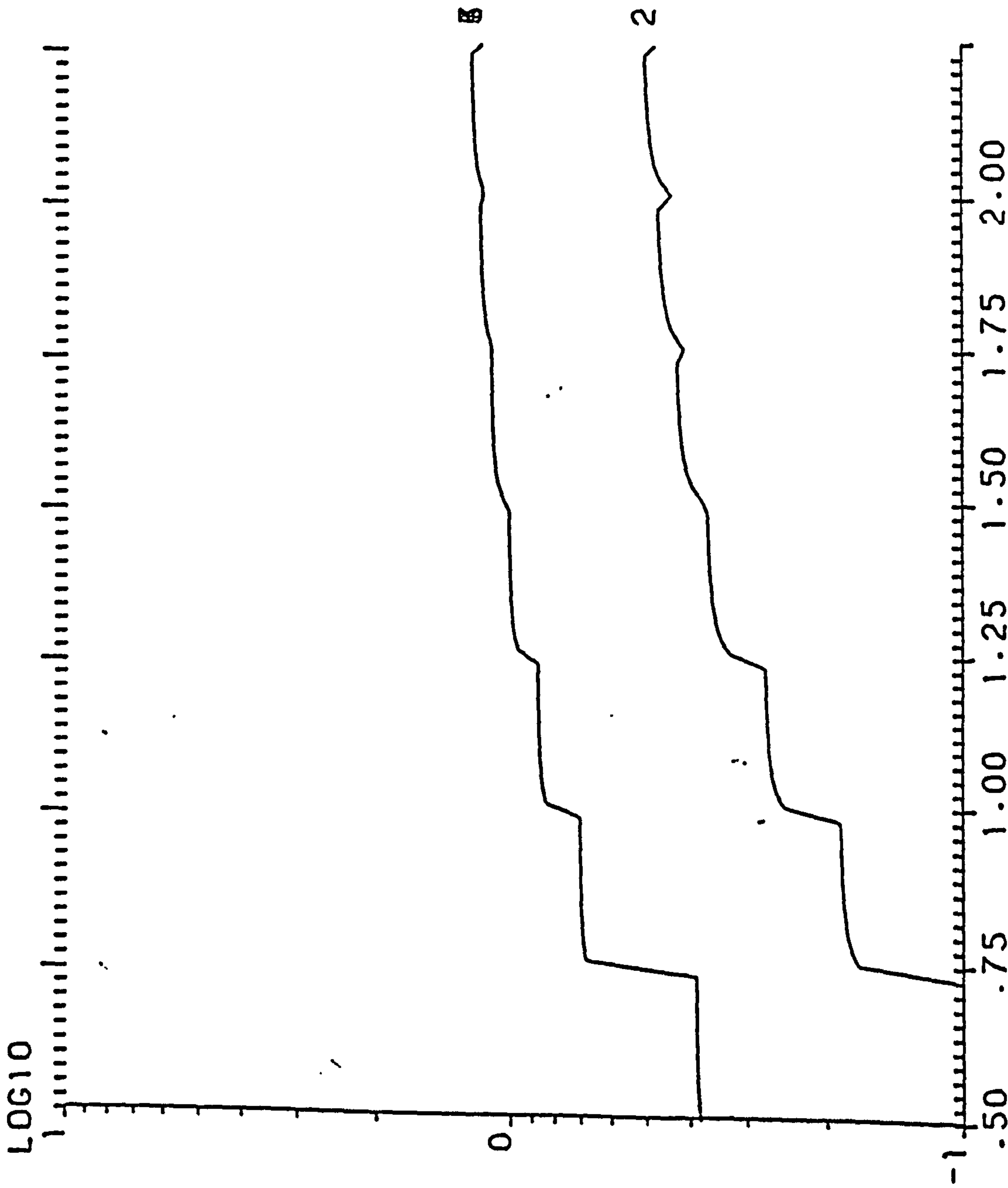

S. EFFICIENCY W. THICKNESS= .24M W. ORIENTATION=270.00

WD= 3M HD1= 22M HD2= 12M HOUSE T.=1.5 ST.



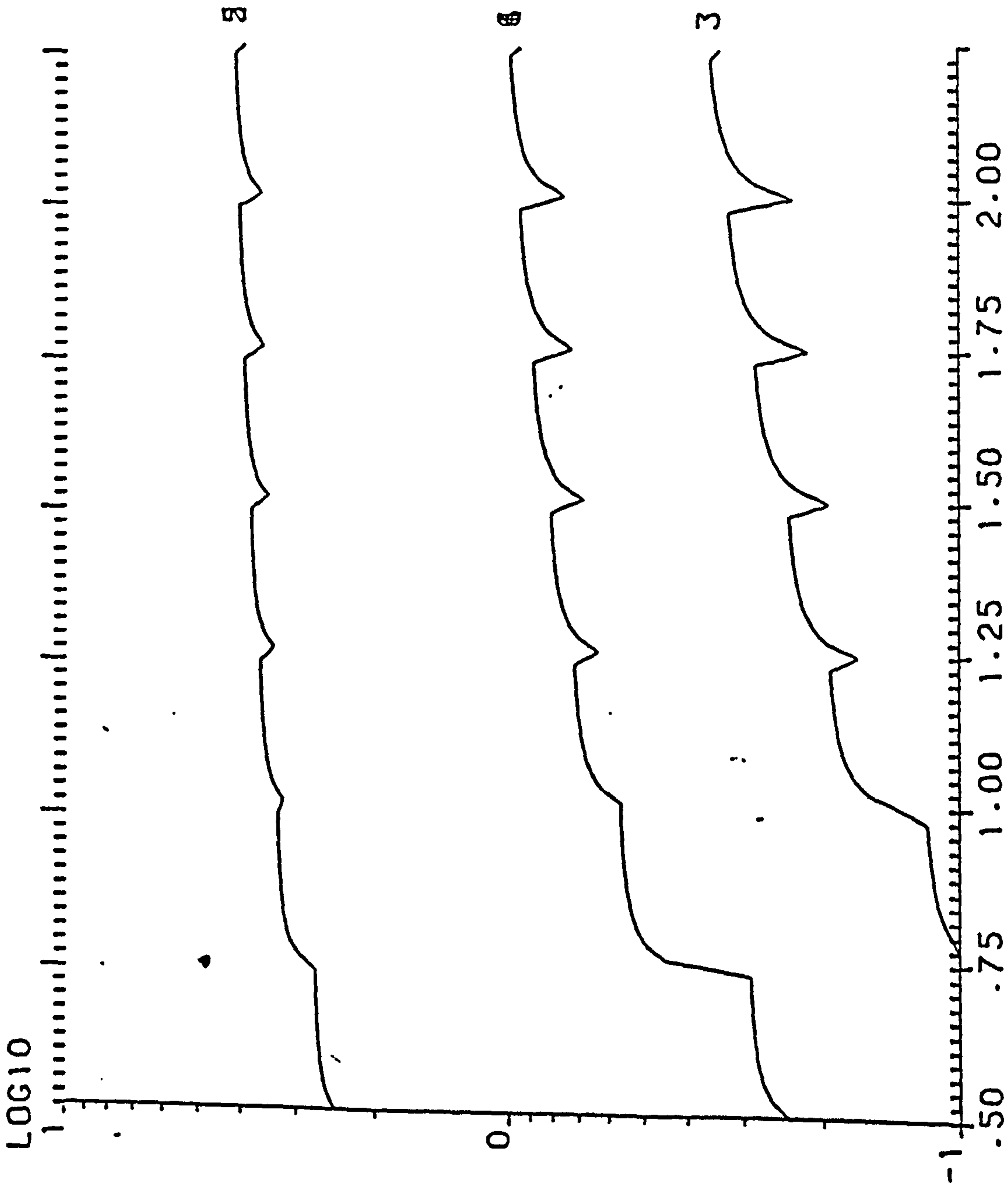

S. EFFICIENCY W. THICKNESS= .24M W. ORIENTATION=292.50

WD= 3M HD1= 22M HD2= 12M HOUSE T.=1.5 ST.





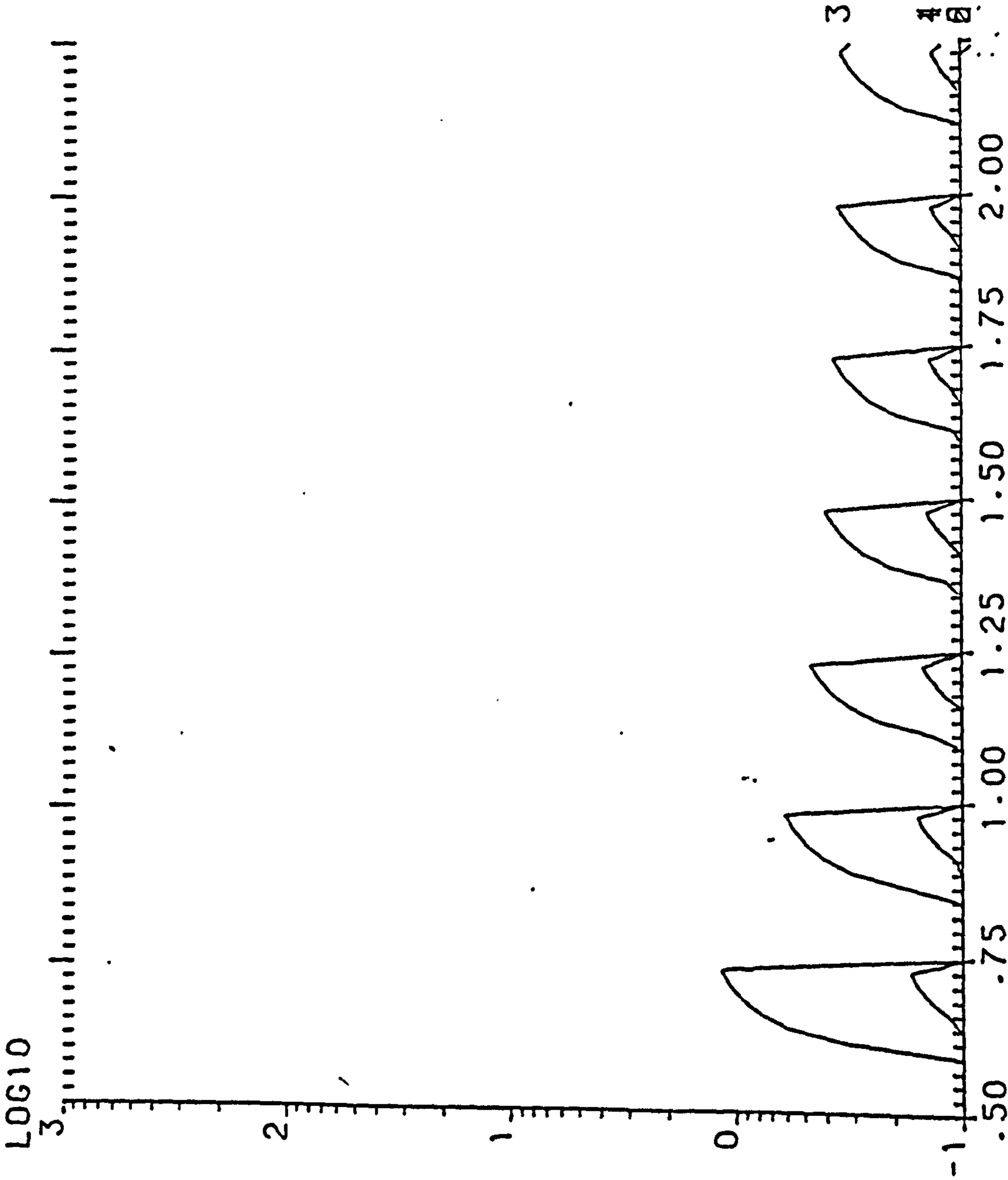

Y. EFFICIENCY W. THICKNESS= .24M W. ORIENTATION=315.00

WD= 3M HD1= 22M HD2= 12M HOUSE T.=1.5 ST.

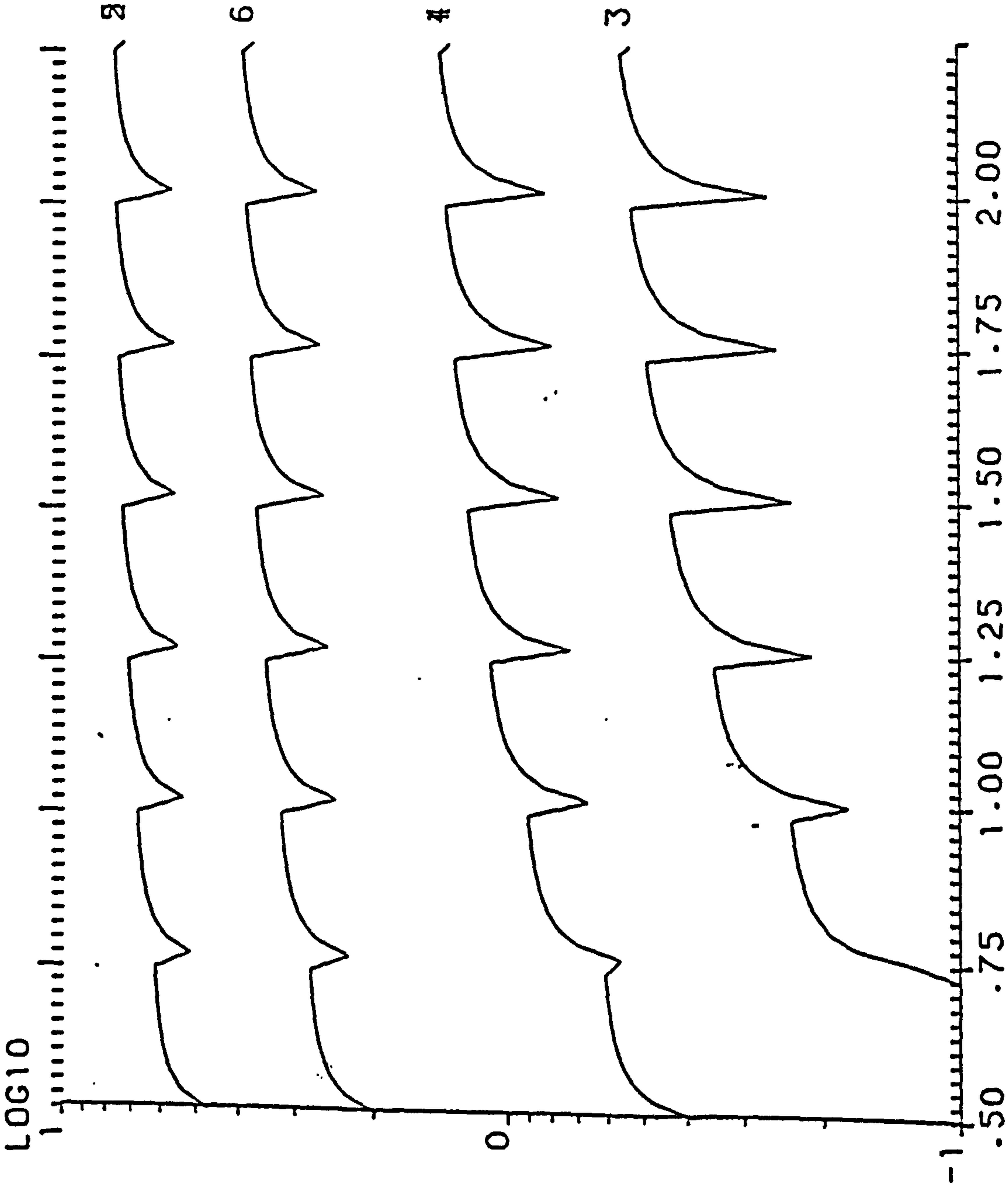

S. EFFICIENCY W. THICKNESS= .24M W. ORIENTATION=315.00  
 WD= 3M HD1= 22M HD2= 12M HOUSE T.=1.5 ST.

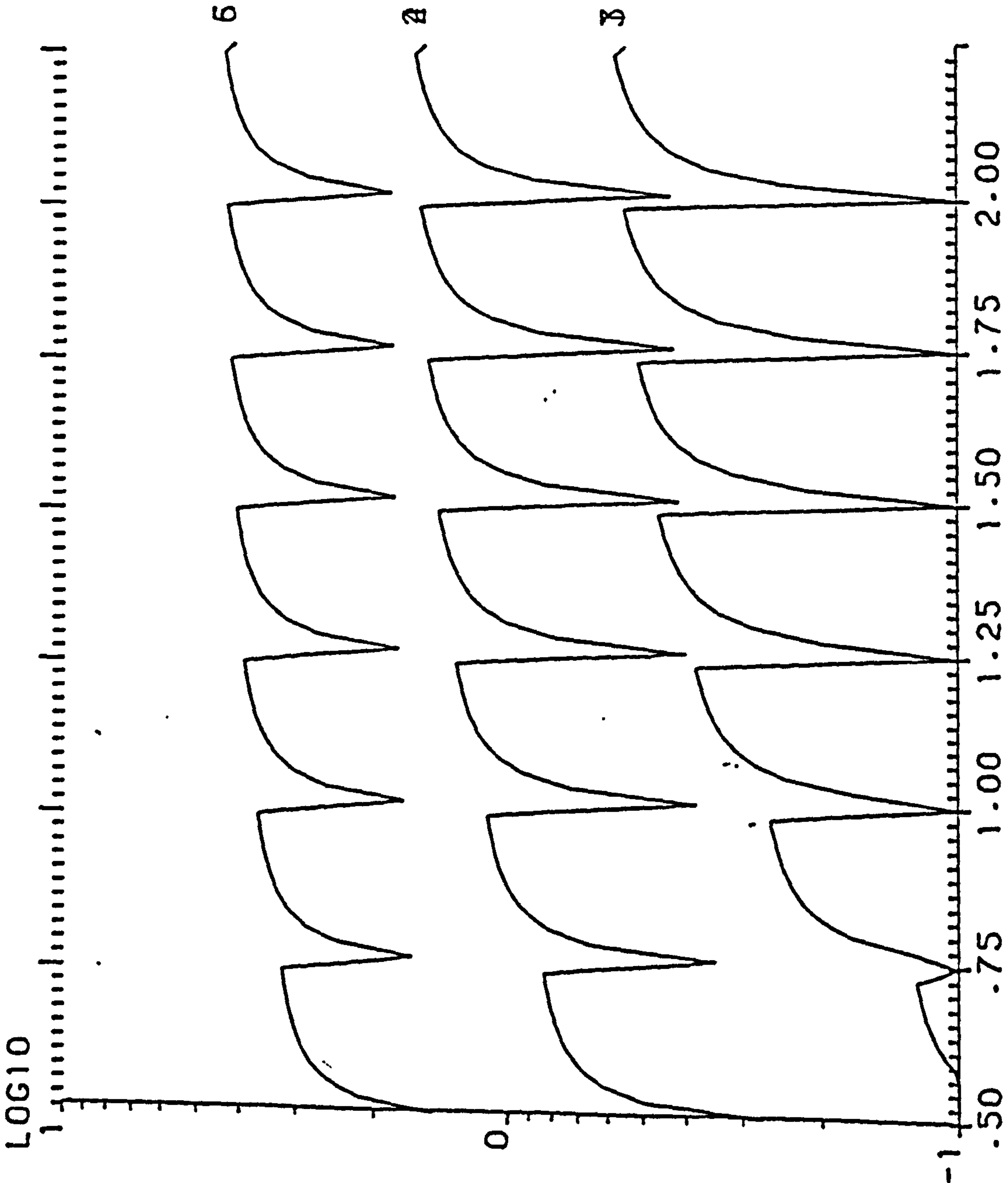

S. EFFICIENCY    W. THICKNESS= .24M    HD2= 12M    HOUSE T.=1.5 ST.  
 WD= 3M    HD1= 22M

W. ORIENTATION=337.50

LOG10

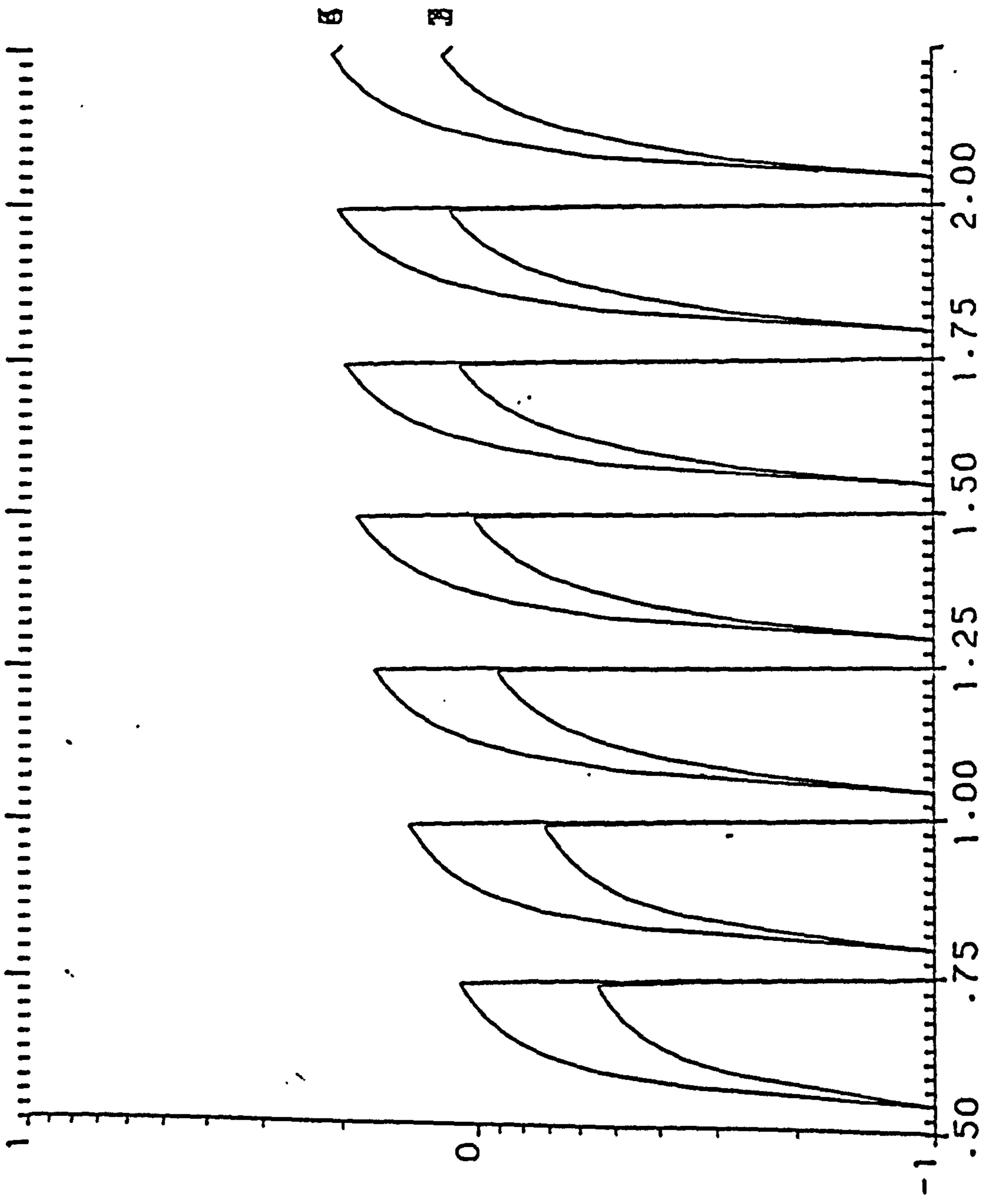

S. EFFICIENCY    W. THICKNESS=    .36M    W. ORIENTATION=    .00  
 WD=    3M    HD1= 22M    HD2= 12M    HOUSE T.=1.5 ST.

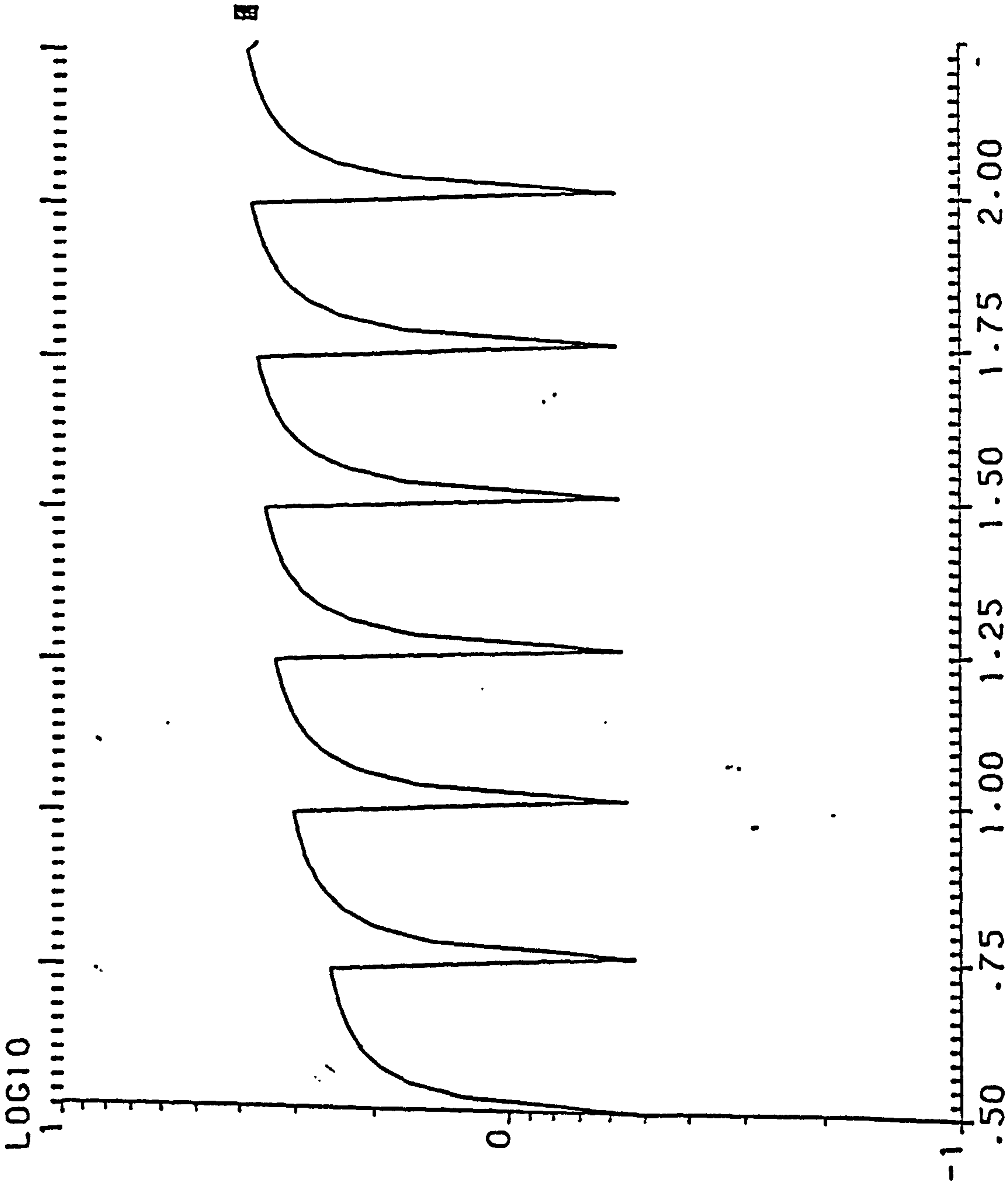

S. EFFICIENCY W. THICKNESS= .36M W. ORIENTATION= 22.50

WD= 3M HD1= 22M HD2= 12M HOUSE T.=1.5 ST.



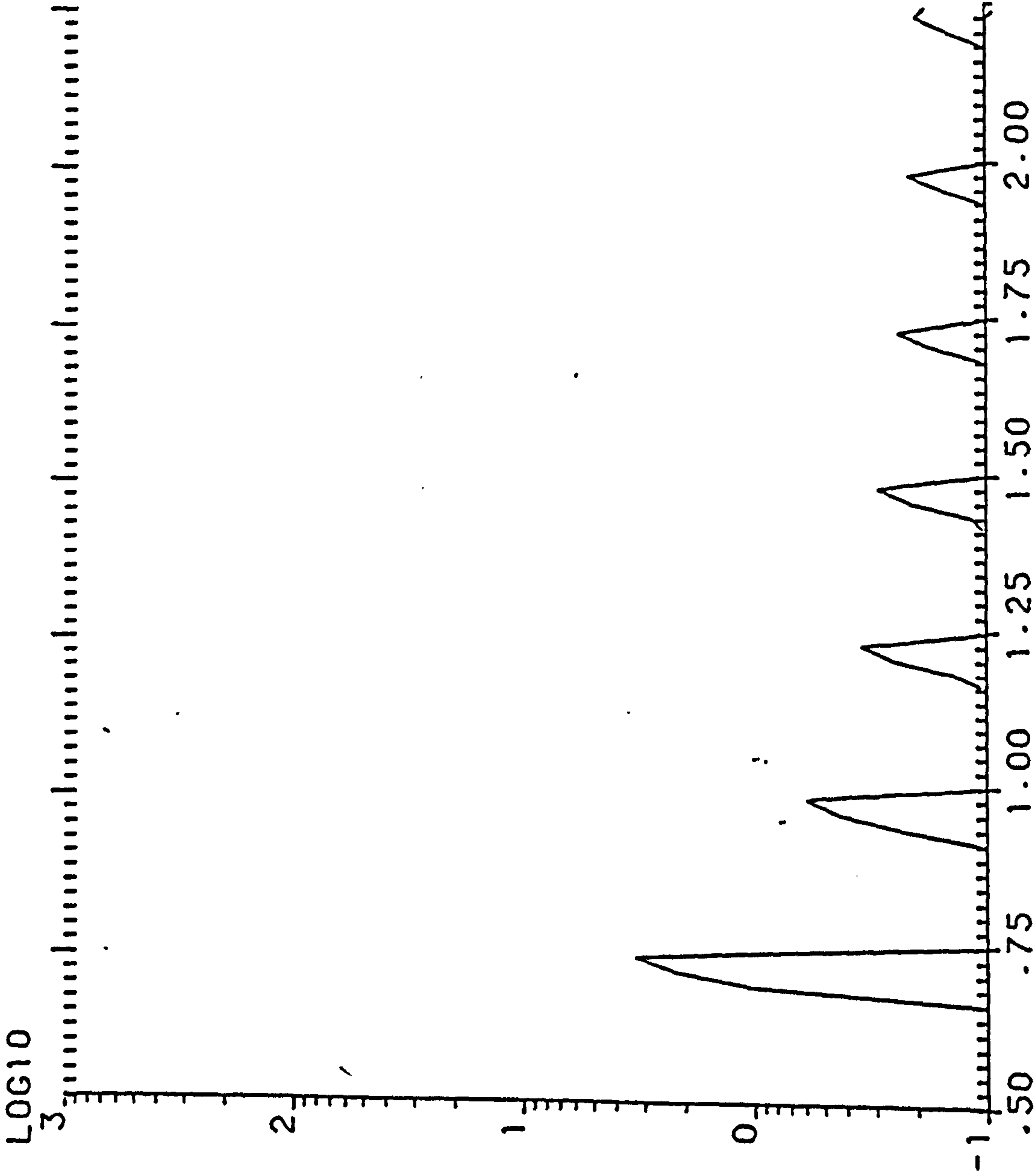

Y. EFFICIENCY W. THICKNESS= .36M W. ORIENTATION= 45.00

WD= 3M HD1= 22M HD2= 12M HOUSE T.=1.5 ST.

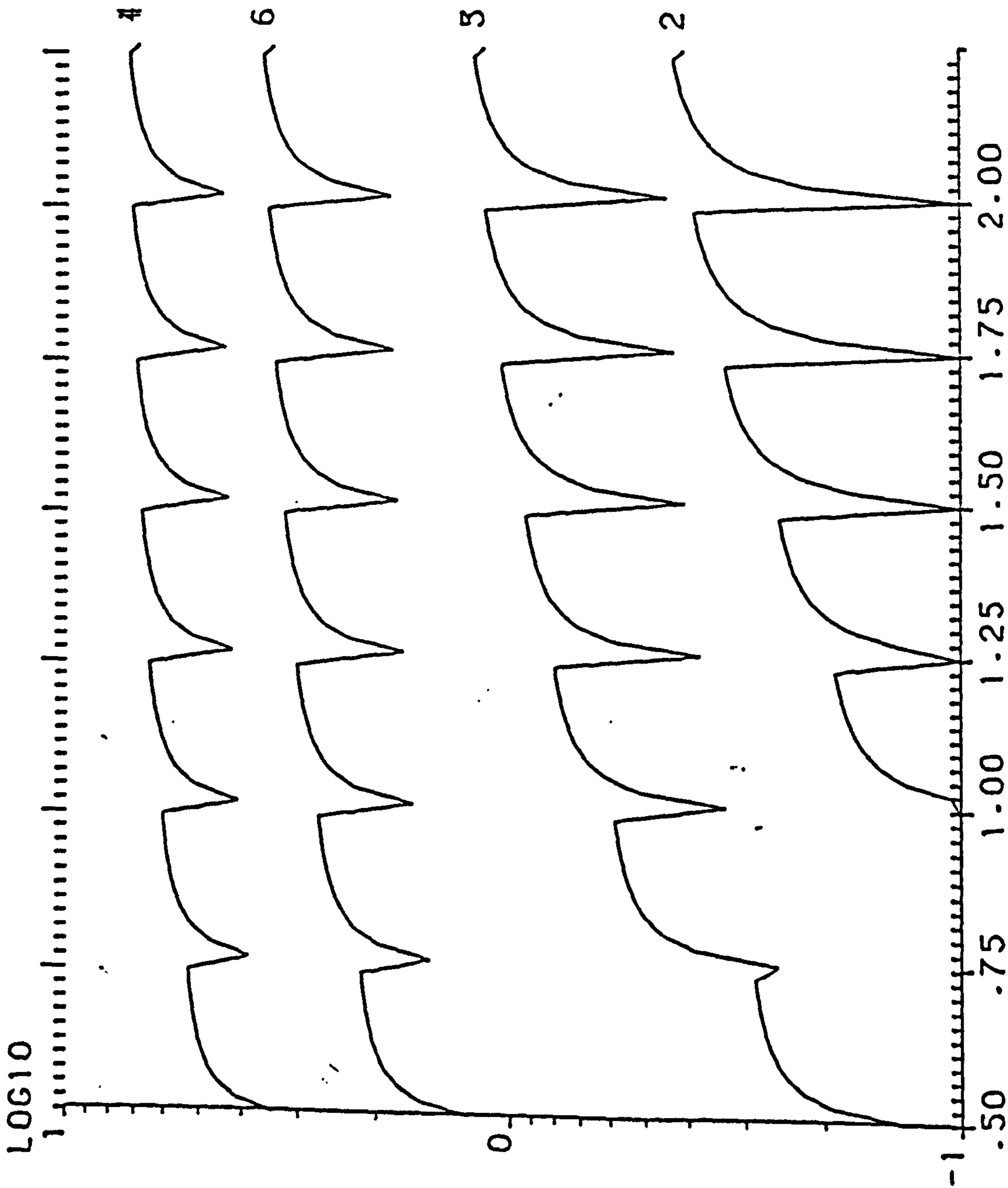

S. EFFICIENCY W. THICKNESS= .36M W. ORIENTATION= 45.00

WD= 3M HD1= 22M HD2= 12M HOUSE T.=1.5 ST.

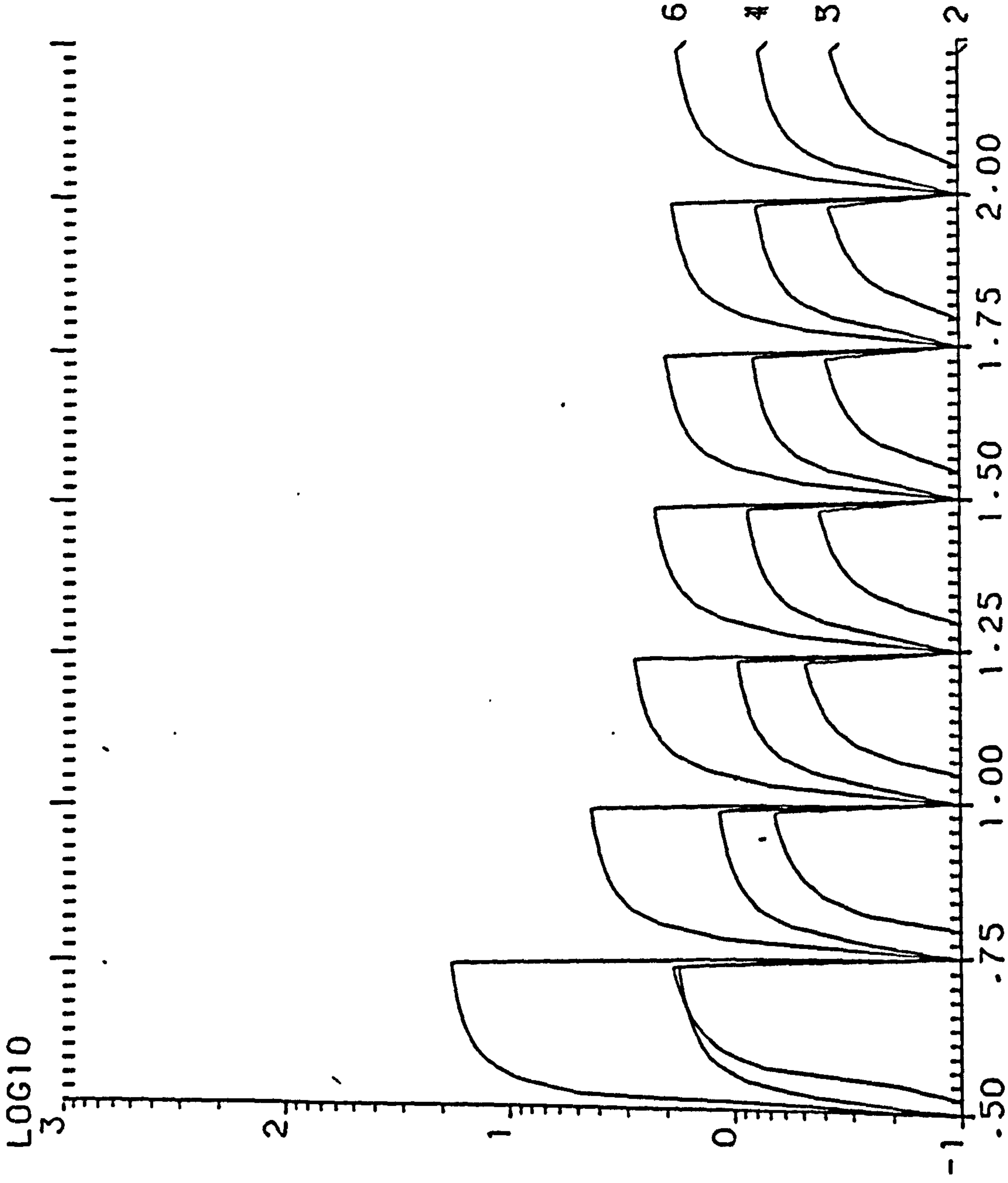

Y. EFFICIENCY W. THICKNESS= .36M W. ORIENTATION= 67.50  
WD= 3M HD1= 22M HD2= 12M HOUSE T.=1.5 ST.

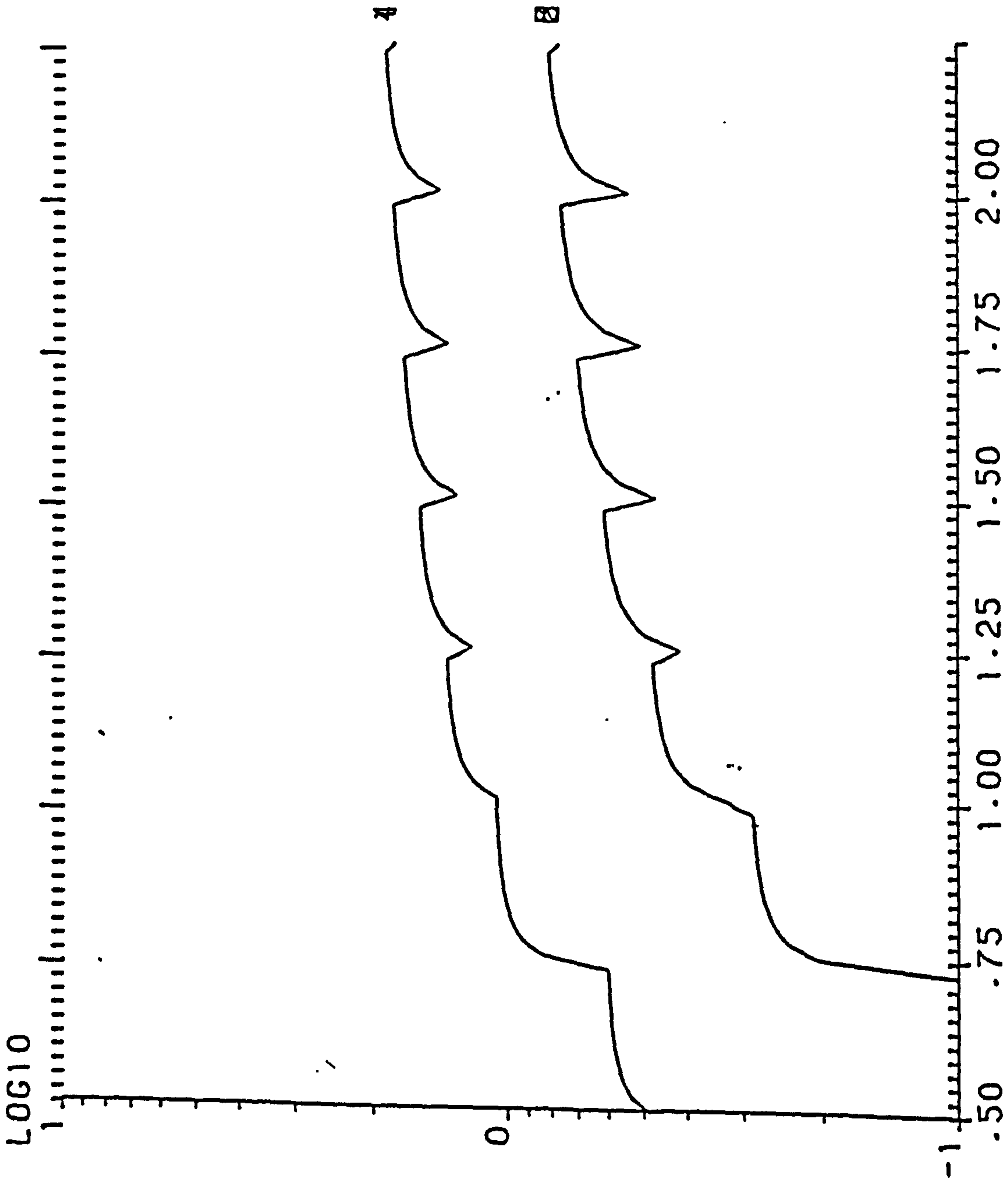

S. EFFICIENCY    W. THICKNESS=    .36M    W. ORIENTATION= 67.50  
 WD= 3M    HD1= 22M    HD2= 12M    HOUSE T.=1.5 ST.

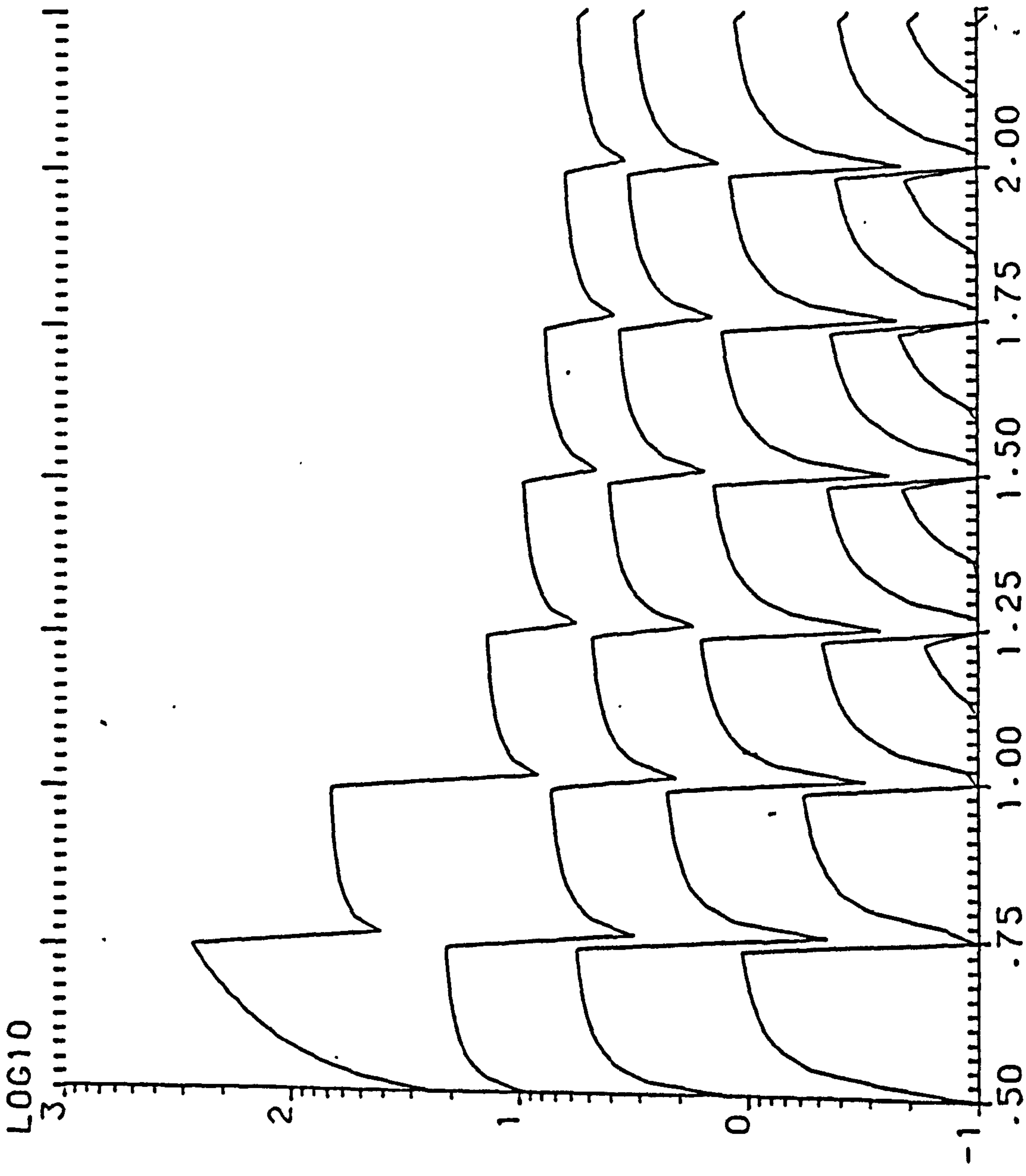

Y. EFFICIENCY    W. THICKNESS=    .36M    W. ORIENTATION= 90.00  
WD= 3M    HD1= 22M    HD2= 12M    HOUSE T.=1.5 ST.



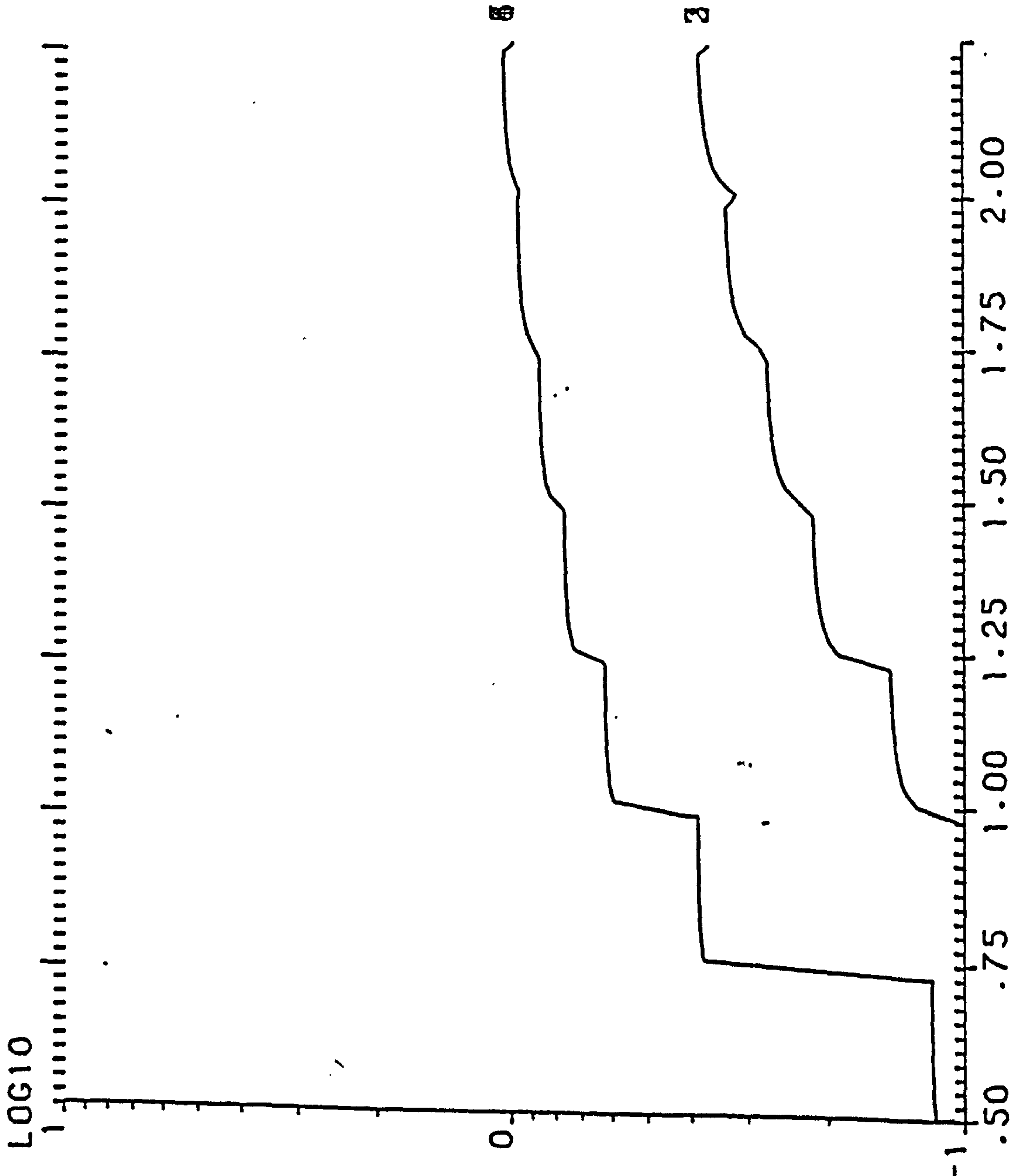

S. EFFICIENCY    W. THICKNESS= .36M    W. ORIENTATION= 90.00  
 WD= 3M    HD1= 22M    HD2= 12M    HOUSE T.=1.5 ST.



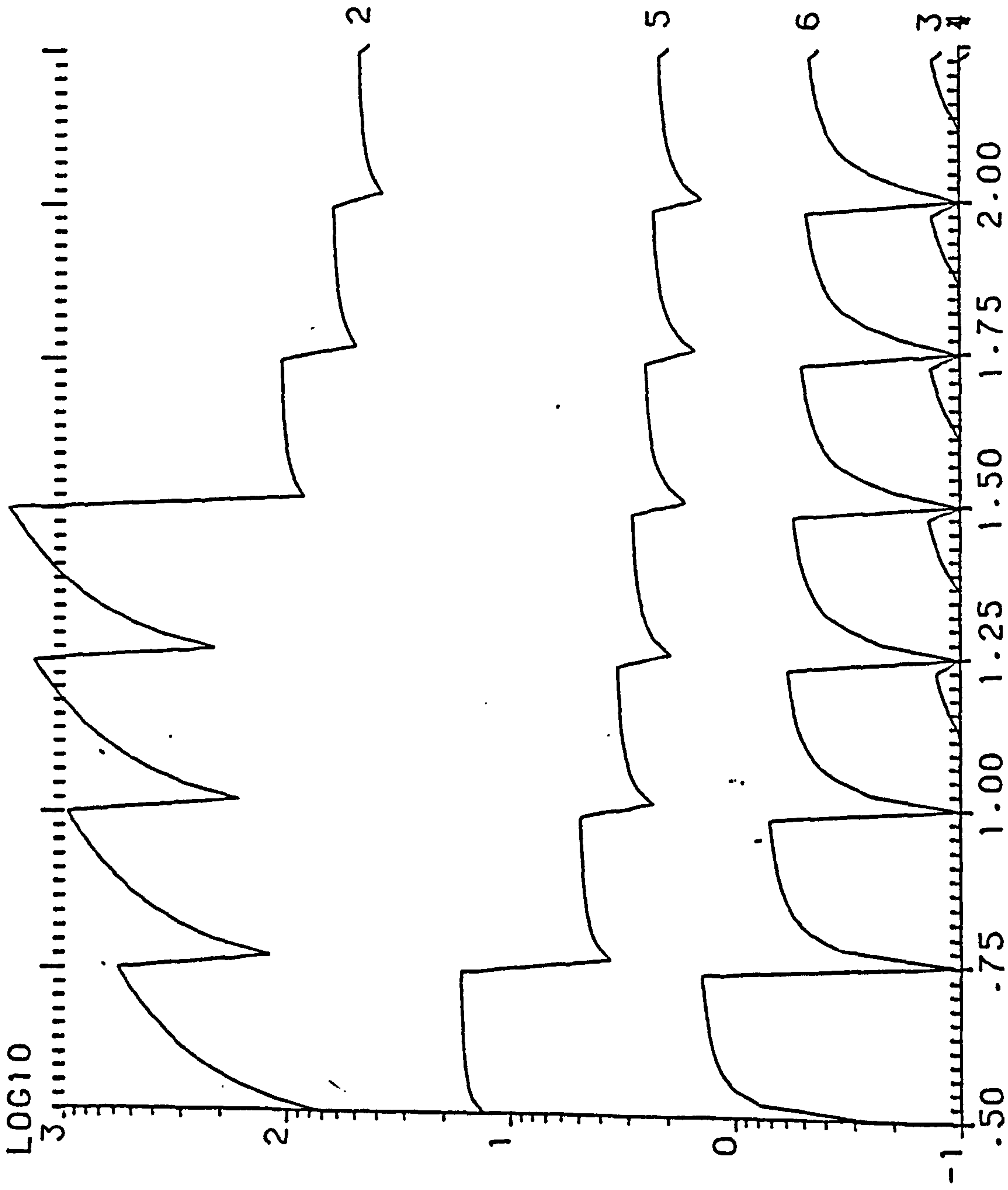

Y. EFFICIENCY W. THICKNESS= .36M W. ORIENTATION=112.50

WD= 3M HD1= 22M HD2= 12M HOUSE T.=1.5 ST.

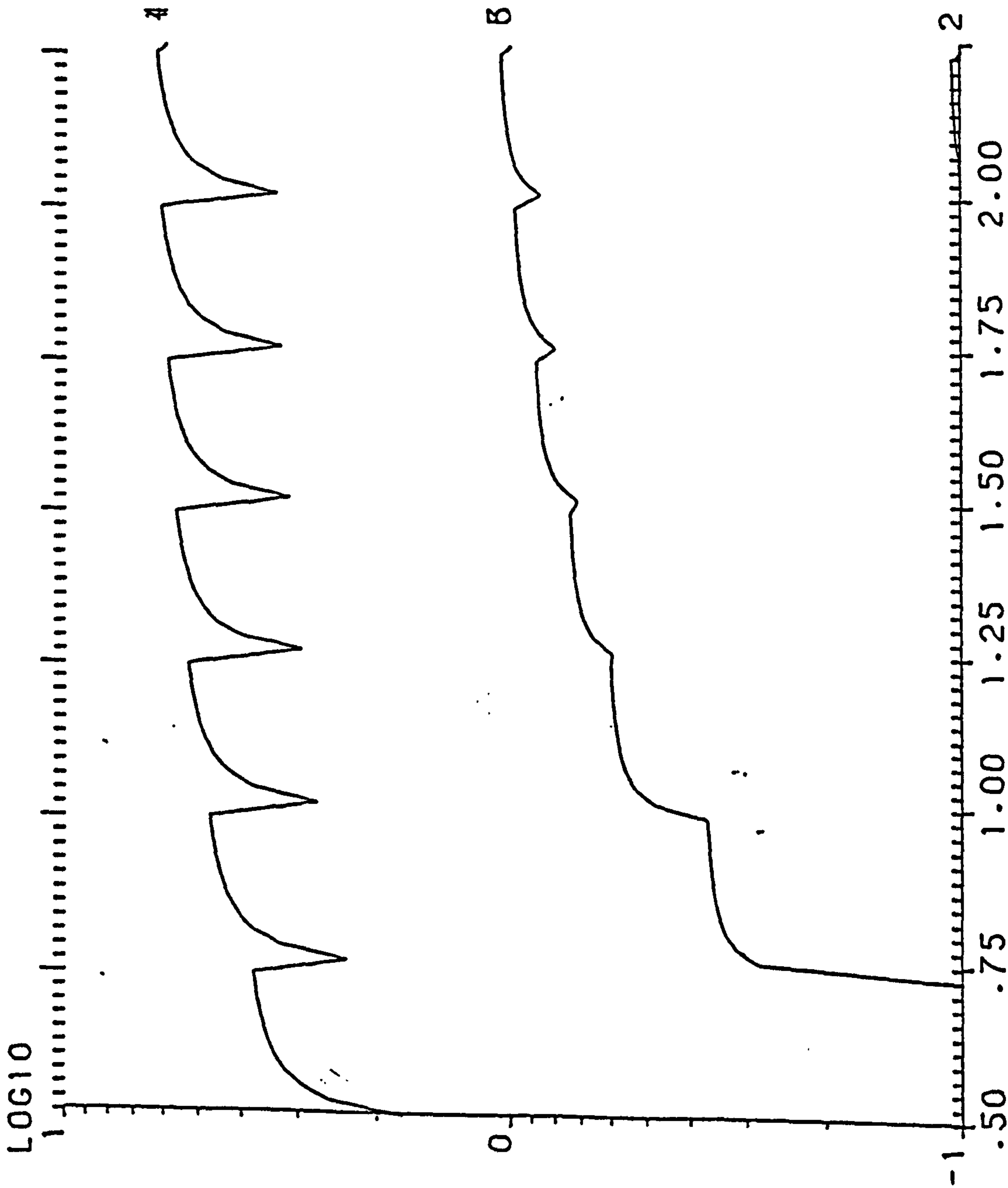

S. EFFICIENCY W. THICKNESS= .36M W. ORIENTATION=112.50

WD= 3M HD1= 22M HD2= 12M HOUSE T.=1.5 ST.

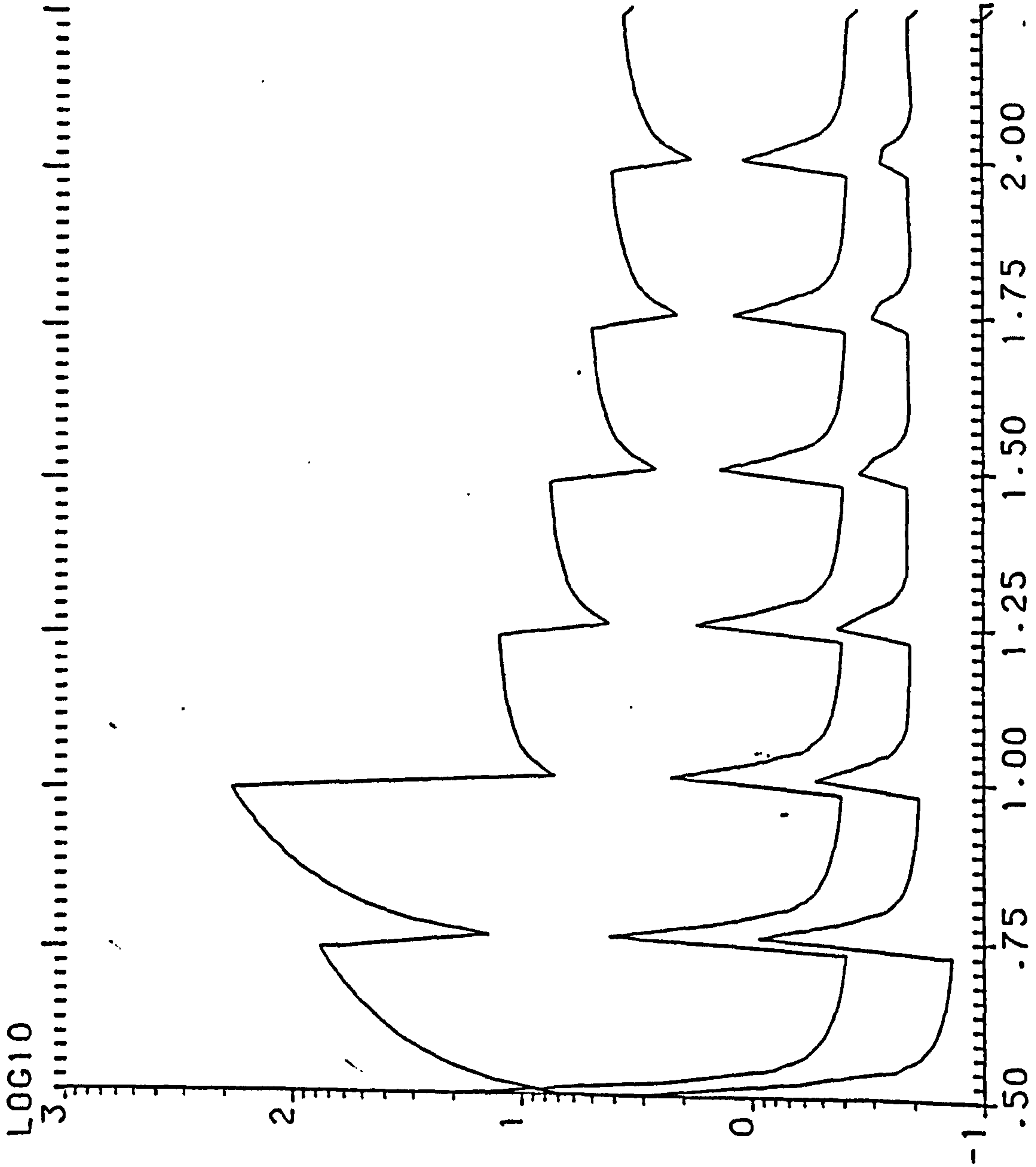

Y. EFFICIENCY W. THICKNESS= .36M W. ORIENTATION=135.00

WD= 3M HD1= 22M HD2= 12M HOUSE T.=1.5 ST.

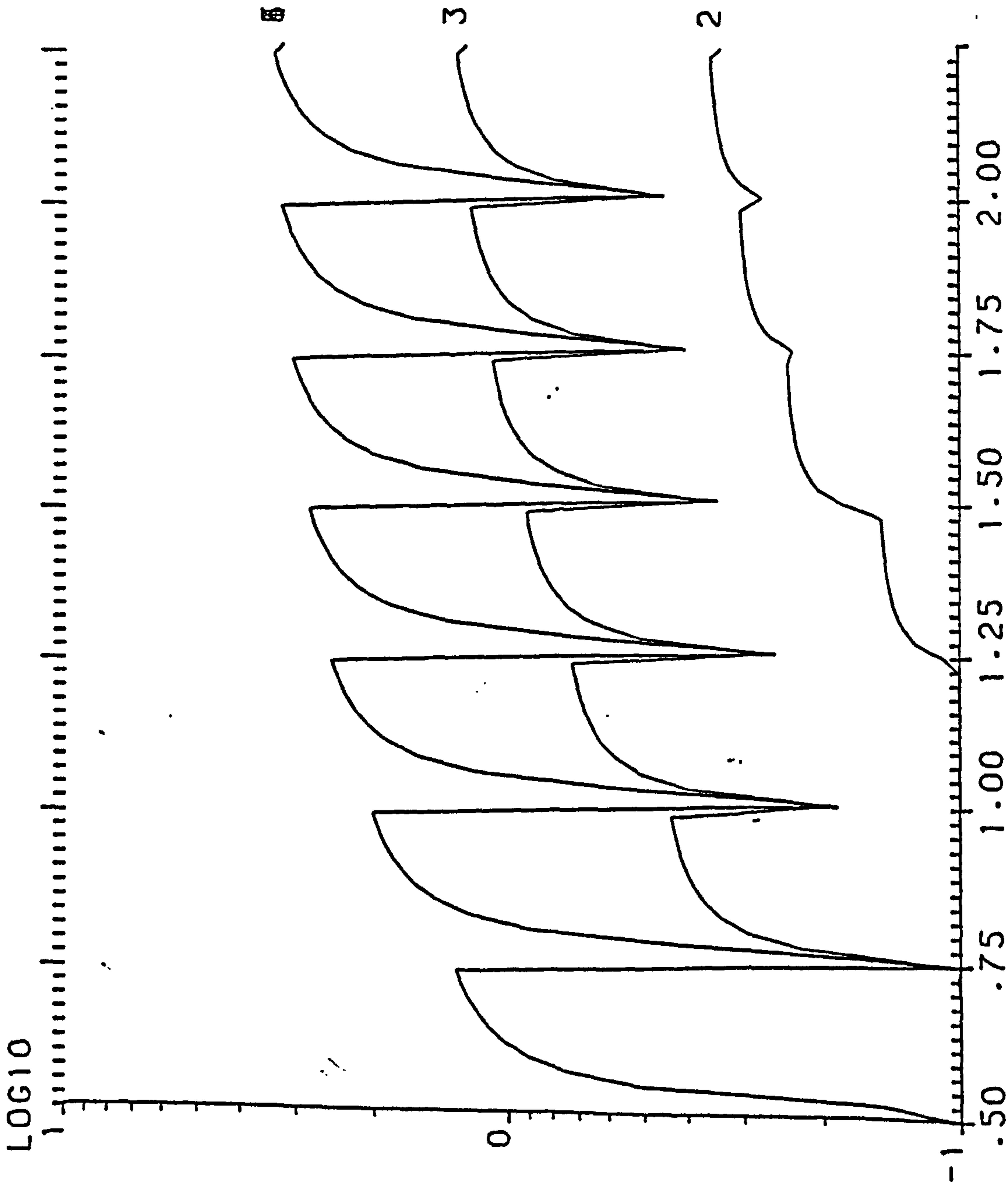

S. EFFICIENCY W. THICKNESS= .36M W. ORIENTATION=135.00

WD= 3M HD1= 22M HD2= 12M HOUSE T.=1.5 ST.



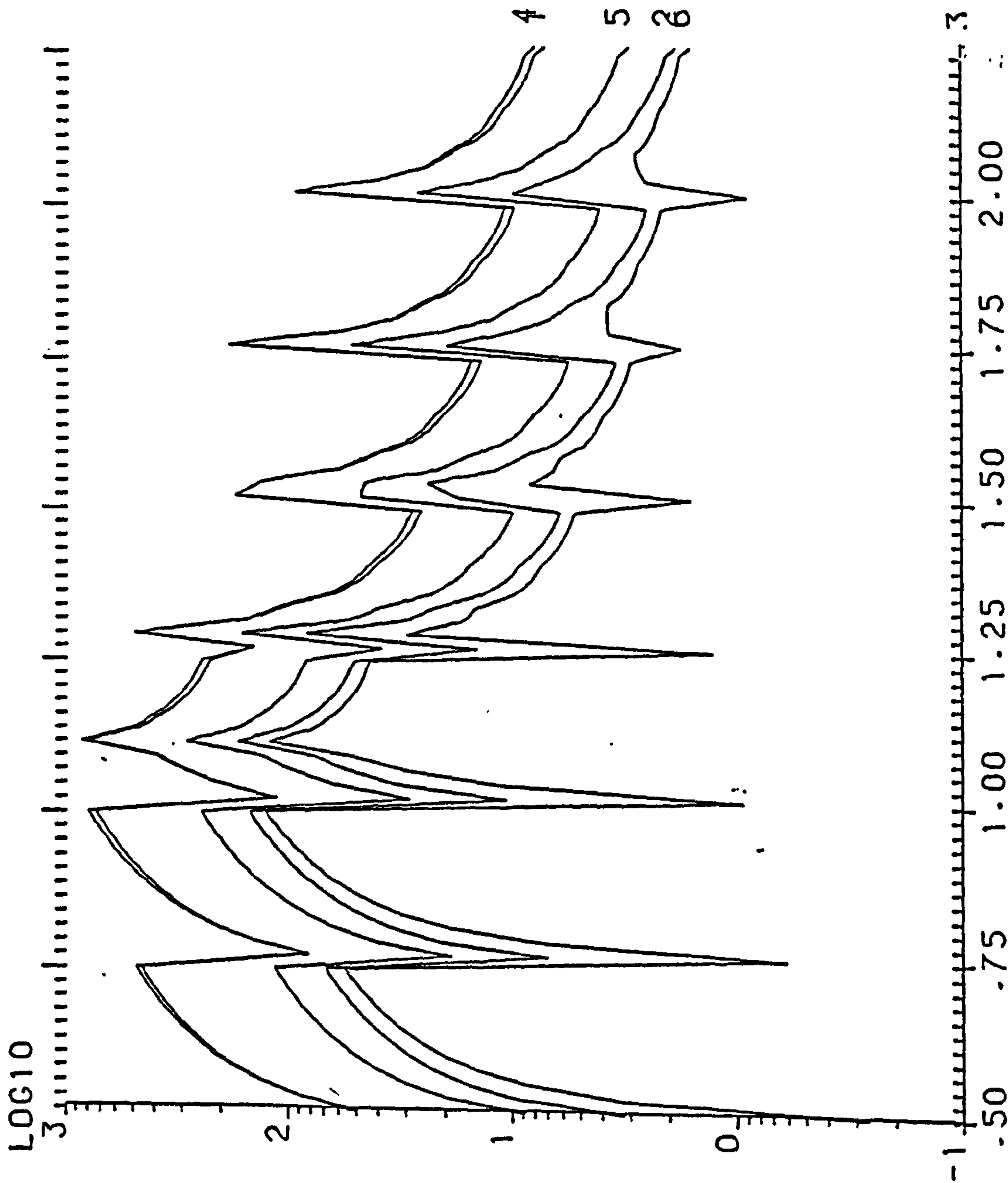

Y. EFFICIENCY W. THICKNESS= .36M W. ORIENTATION=157.50

WD= 3M HD1= 22M HD2= 12M HOUSE T.=1.5 ST.

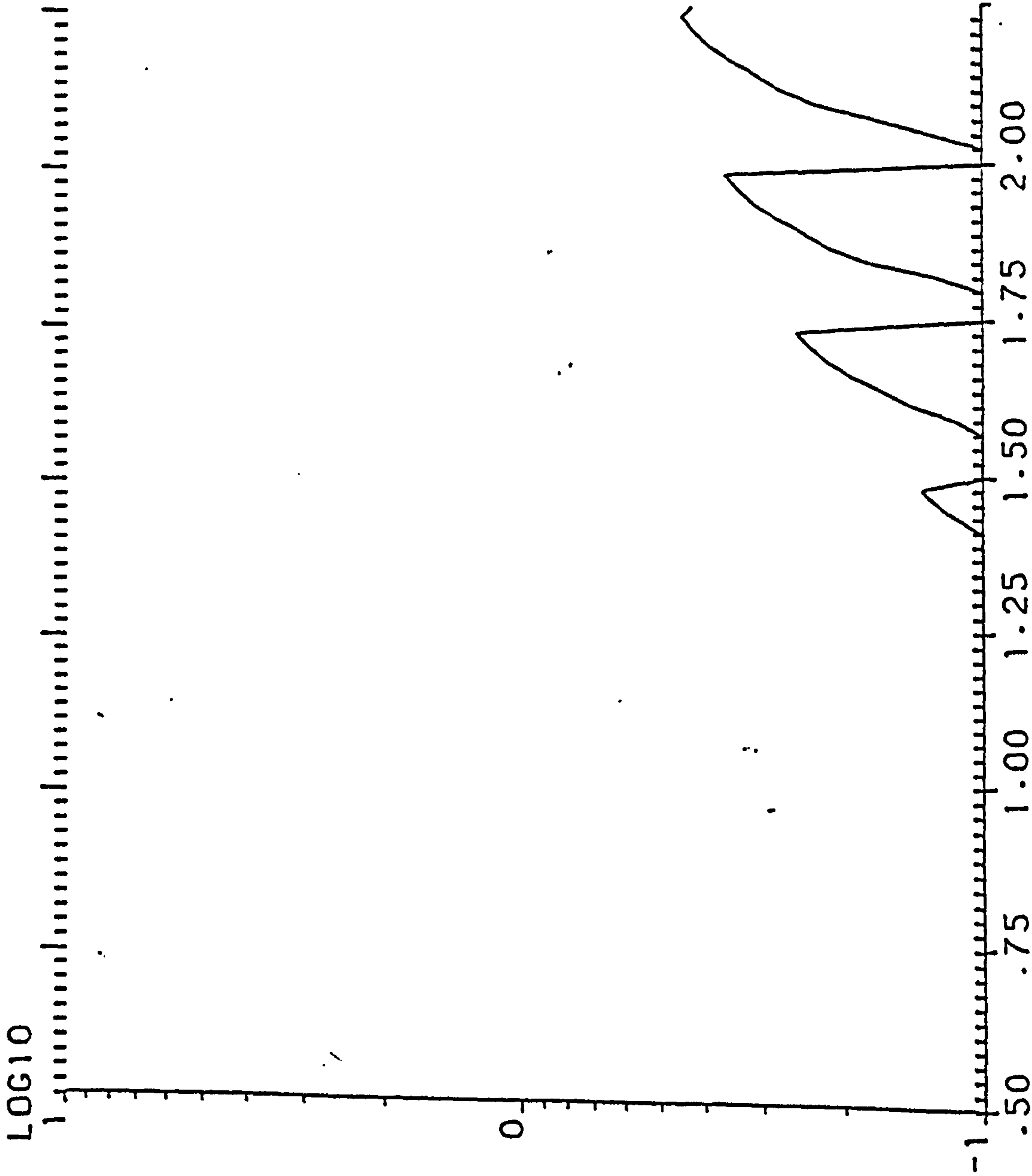

S. EFFICIENCY W. THICKNESS= .36M W. ORIENTATION=157.50

WD= 3M HD1= 22M HD2= 12M HOUSE T.=1.5 ST.



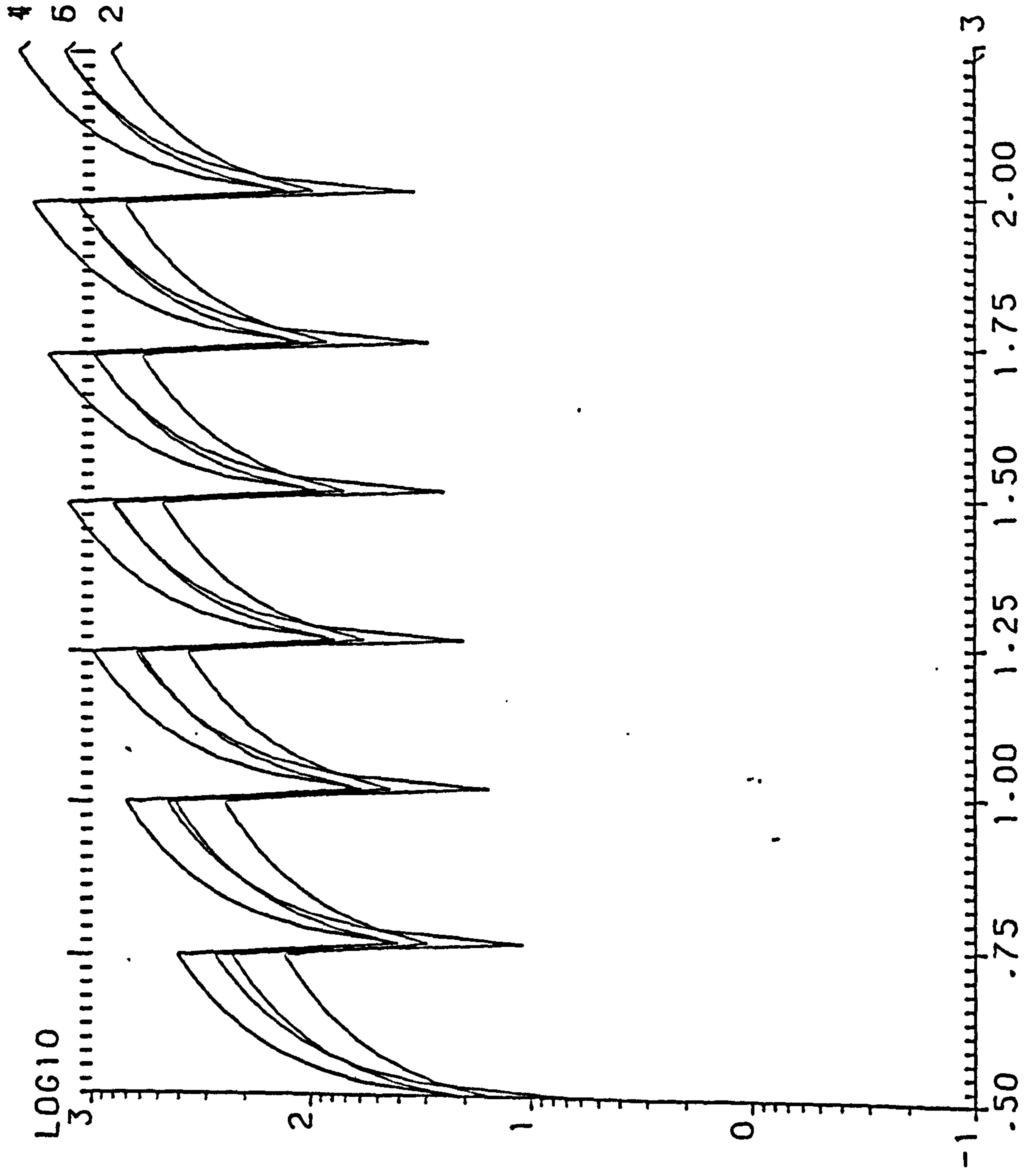

Y. EFFICIENCY W. THICKNESS= .36M W. ORIENTATION=180.00

WD= 3M HD1= 22M HD2= 12M HOUSE T.=1.5 ST.

LOG10  
1  
0  
-1



-1  
 .50 .75 1.00 1.25 1.50 1.75 2.00  
 S. EFFICIENCY W. THICKNESS= .36M W. ORIENTATION=180.00  
 WD= 3M HD1= 22M HD2= 12M HOUSE T.=1.5 ST.

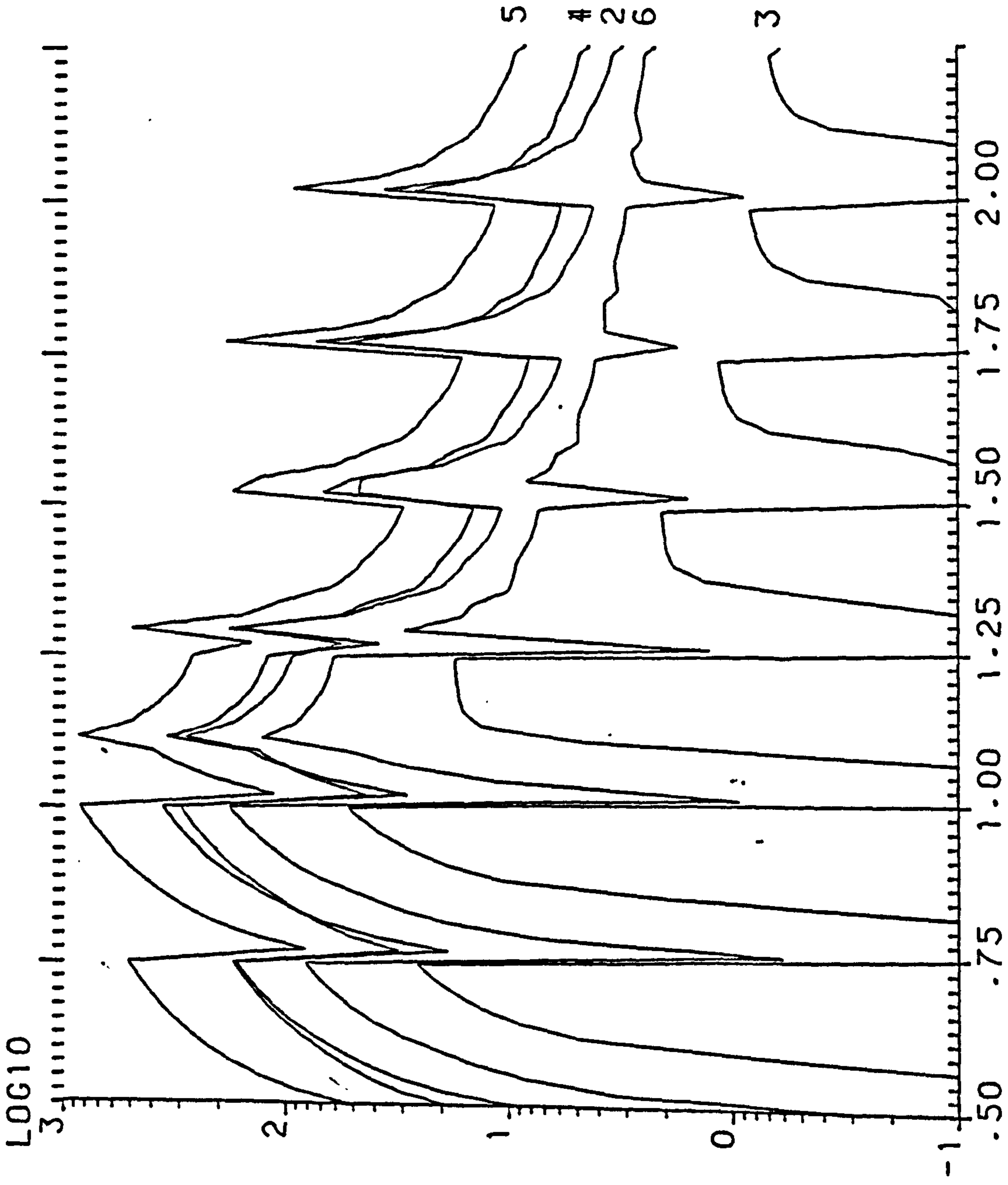

Y. EFFICIENCY W. THICKNESS= .36M W. ORIENTATION=202.50

WD= 3M HD1= 22M HD2= 12M HOUSE T.=1.5 ST.



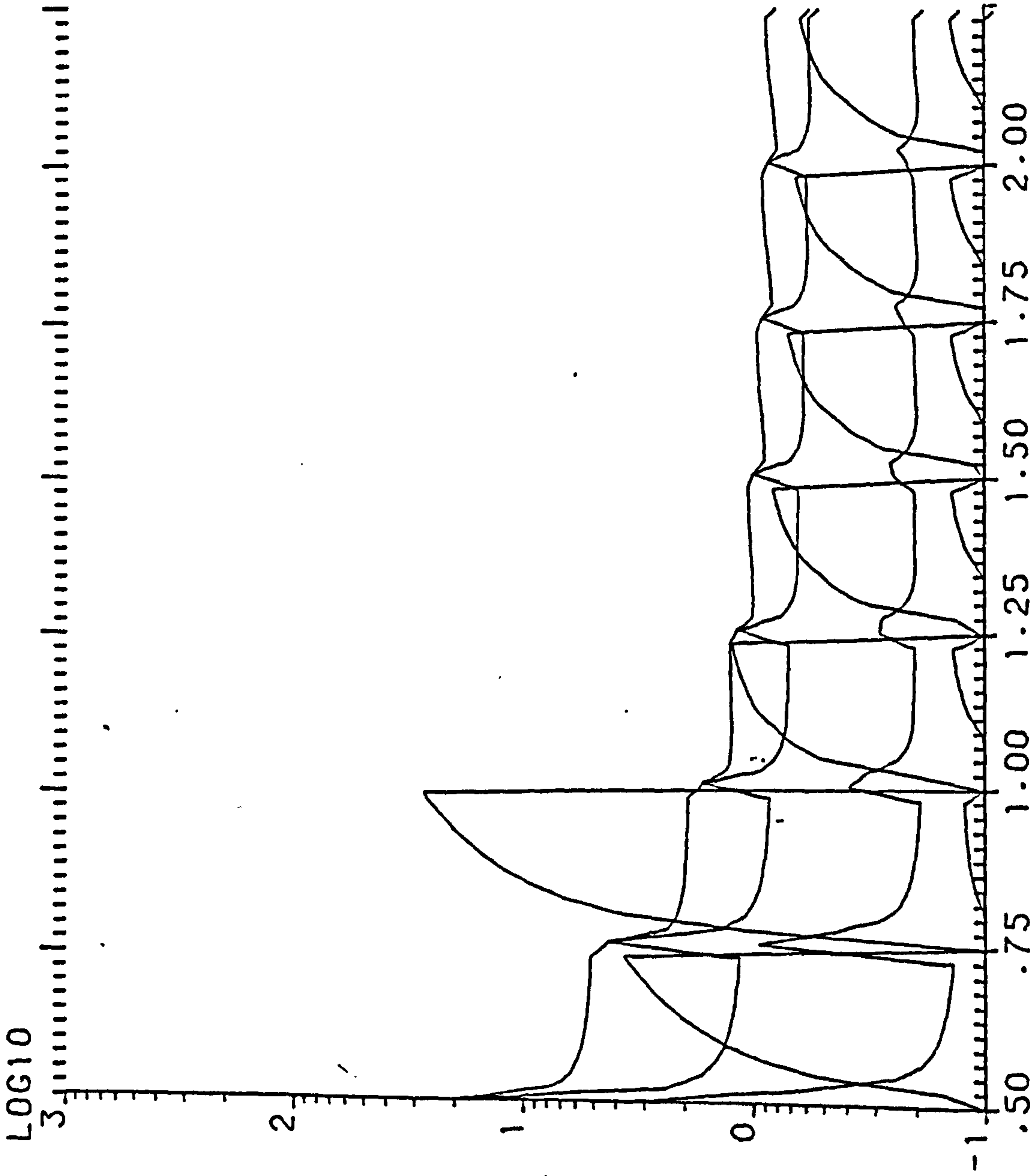

Y. EFFICIENCY W. THICKNESS= .36M W. ORIENTATION=225.00

WD= 3M HD1= 22M HD2= 12M HOUSE T.=1.5 ST.

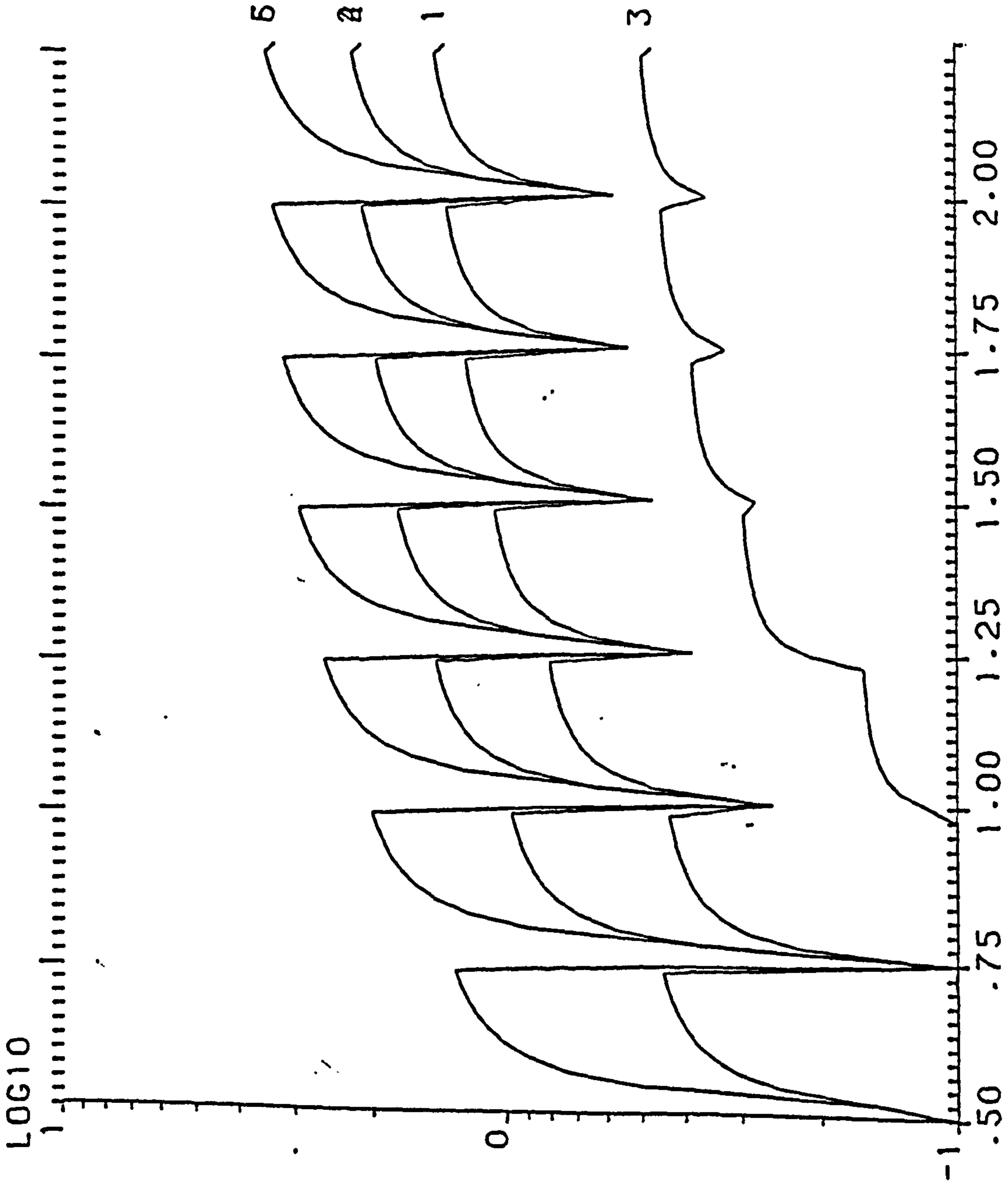

S. EFFICIENCY    W. THICKNESS= .36M    HD2= 12M    HOUSE T.=1.5 ST.  
 HD1= 22M



LOG10

1

0

-1

.50

.75

1.00

1.25

1.50

1.75

2.00

6

2

1

3

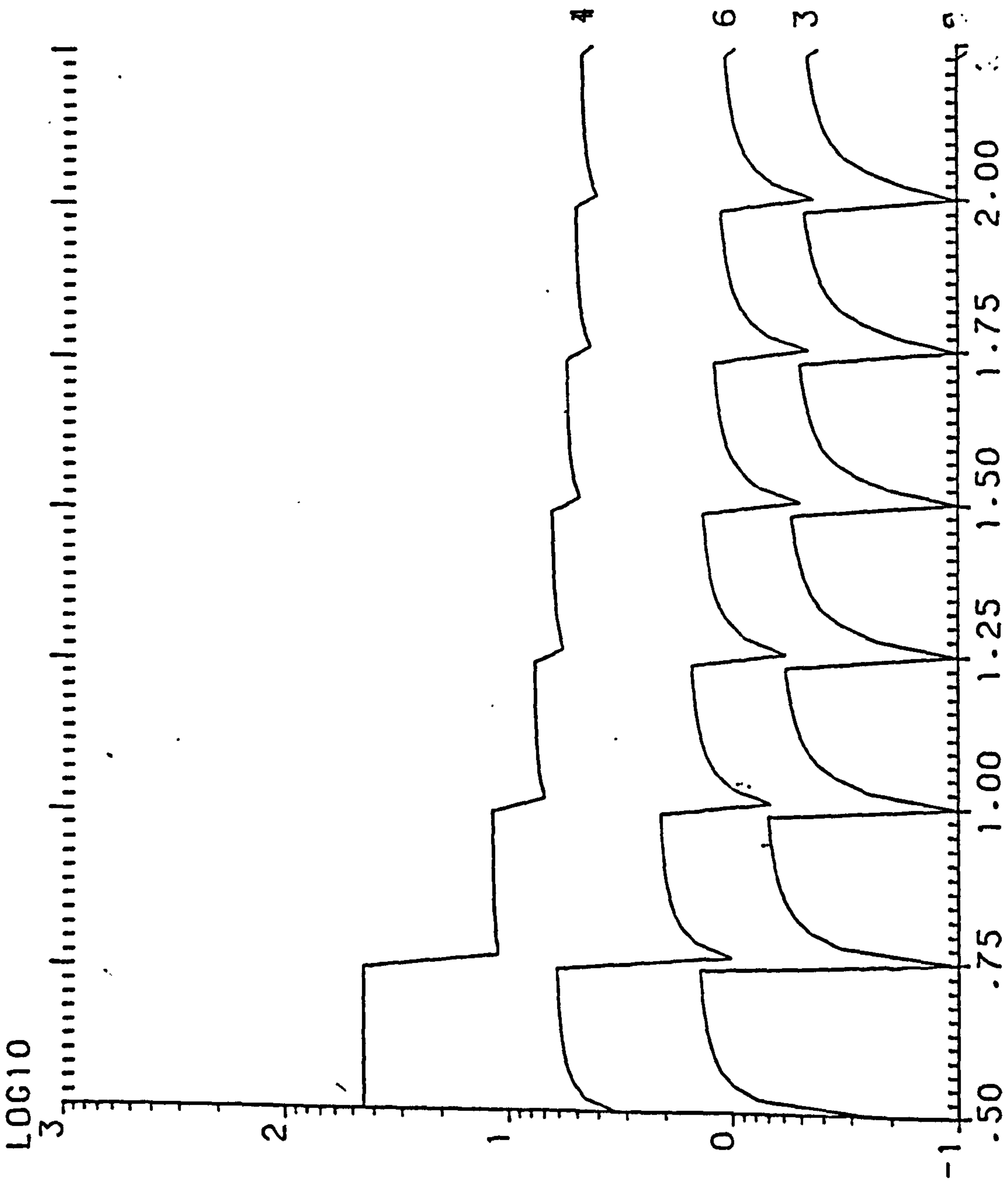

Y. EFFICIENCY W. THICKNESS= .36M W. ORIENTATION=247.50

WD= 3M HD1= 22M HD2= 12M HOUSE T.=1.5 ST.

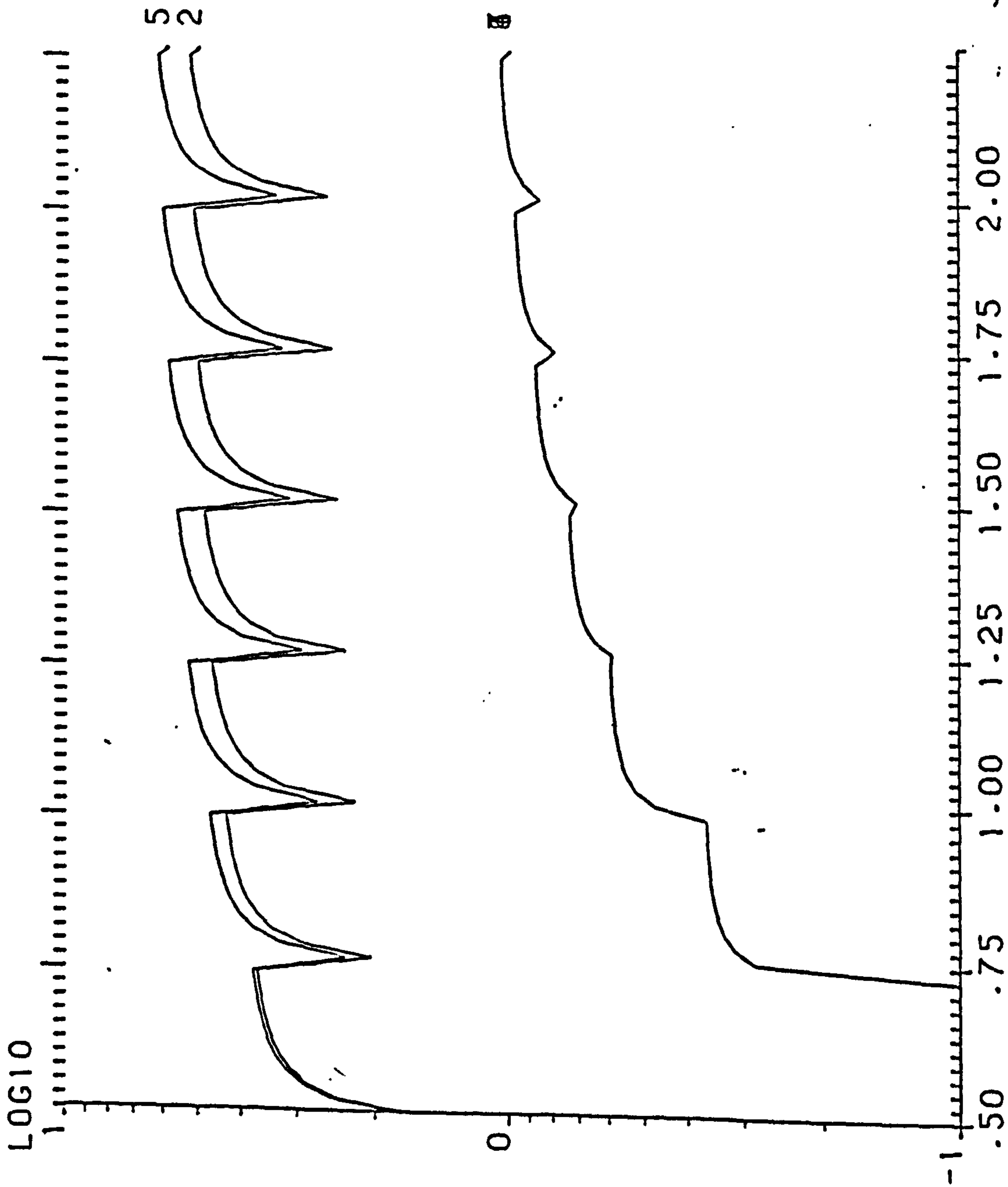

S. EFFICIENCY W. THICKNESS= .36M W. ORIENTATION=247.50

WD= 3M HD1= 22M HD2= 12M HOUSE T.=1.5 ST.

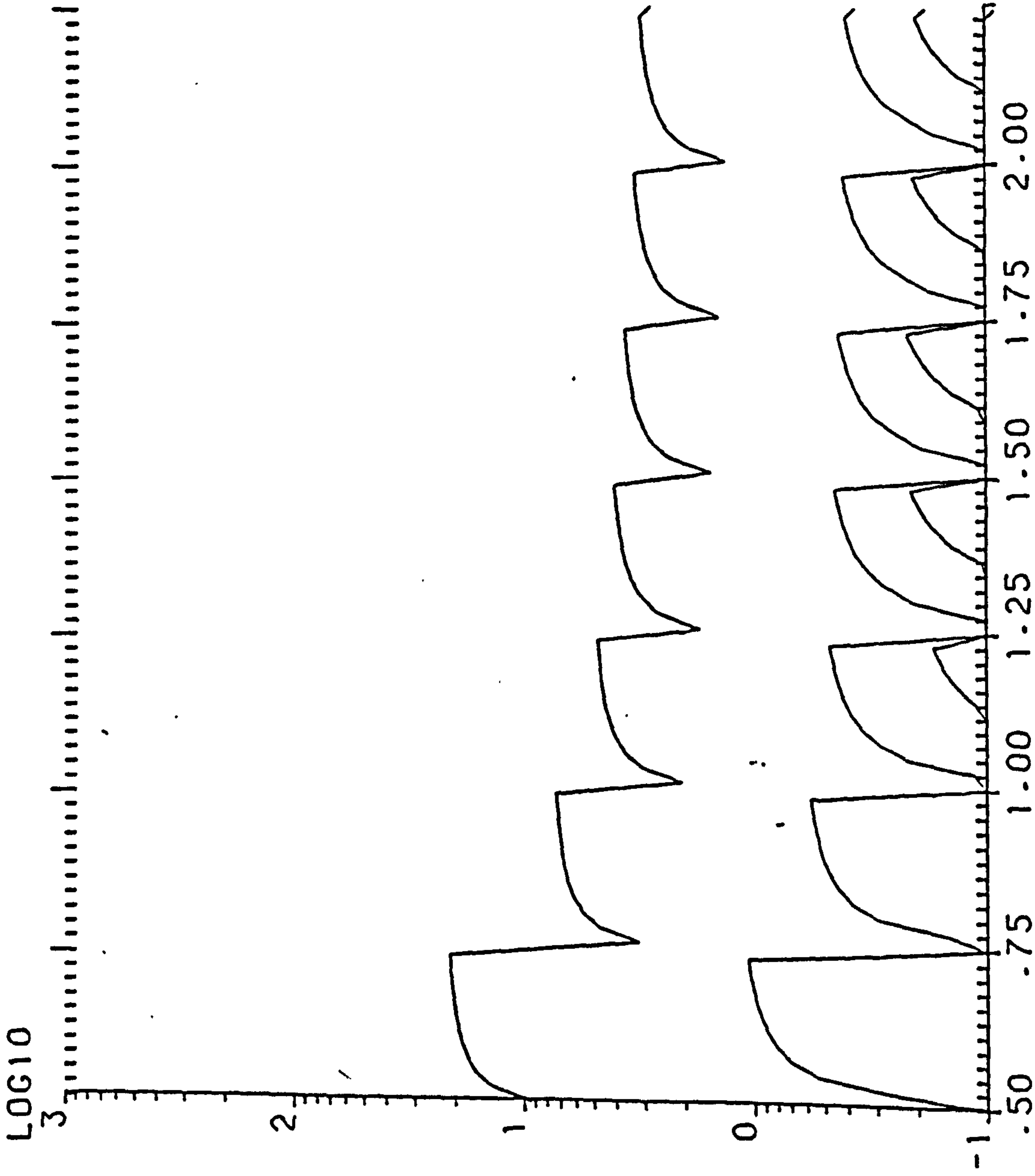

Y. EFFICIENCY W. THICKNESS= .36M W. ORIENTATION=270.00

WD= 3M HD1= 22M HD2= 12M HOUSE T.=1.5 ST.



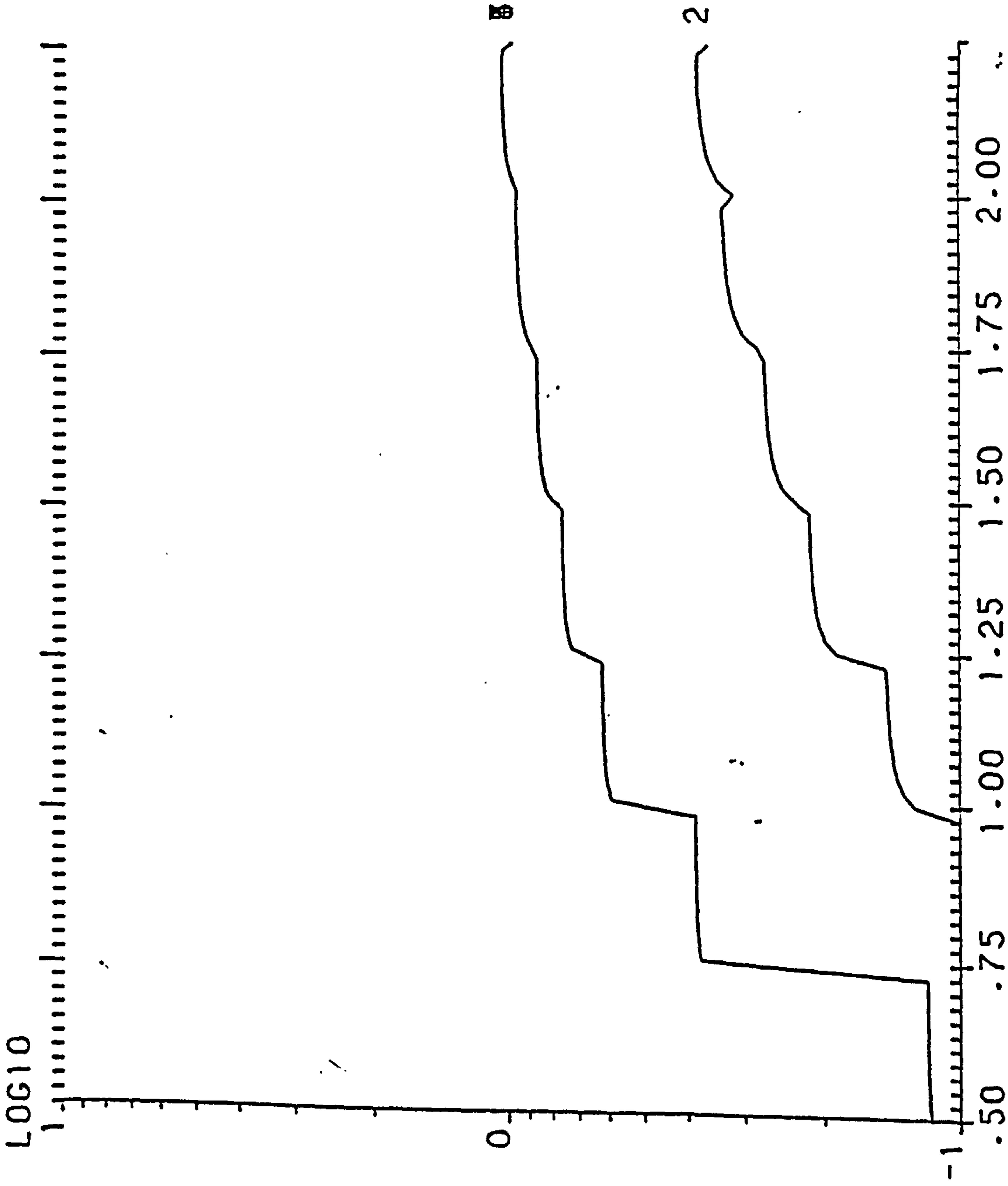

S. EFFICIENCY W. THICKNESS= .36M W. ORIENTATION=270.00

WD= 3M HD1= 22M HD2= 12M HOUSE T.=1.5 ST.

LOG10  
3  
2  
1  
0  
-1

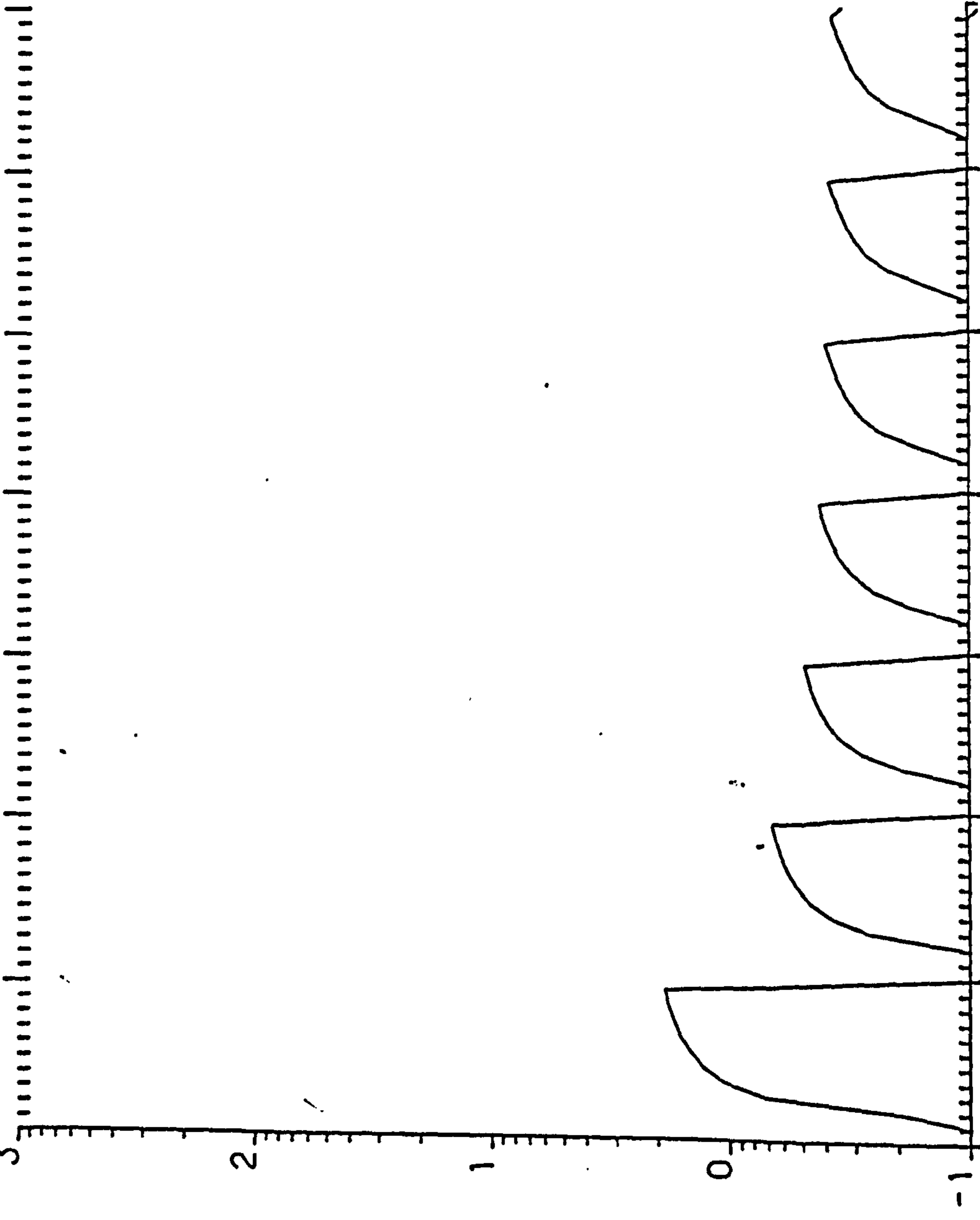

Y. EFFICIENCY W. THICKNESS= .36M W. ORIENTATION=292.50  
WD= 3M HD1= 22M HD2= 12M HOUSE T.=1.5 ST.

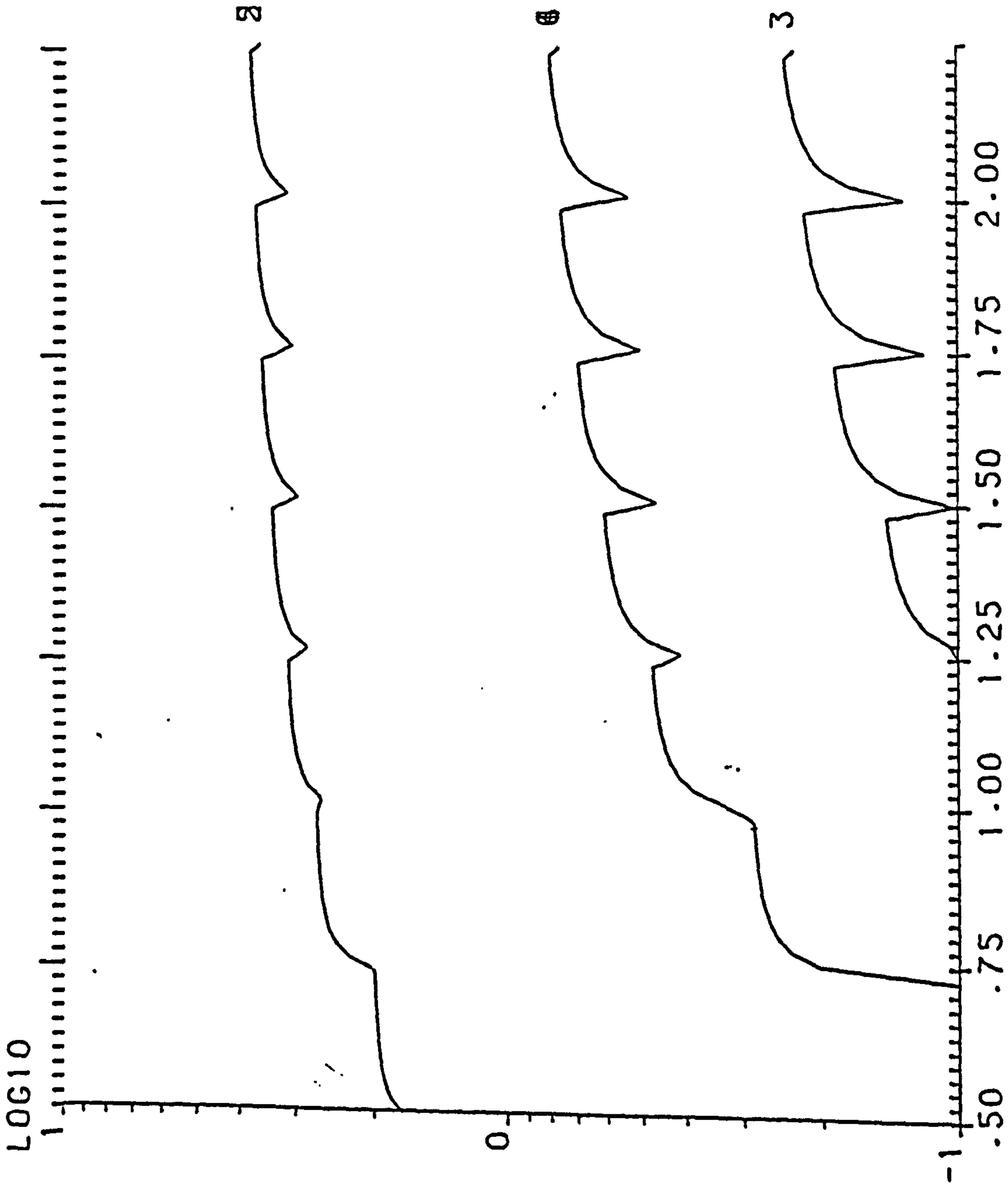

S. EFFICIENCY W. THICKNESS= .36M W. ORIENTATION=292.50

WD= 3M HD1= 22M HD2= 12M HOUSE T.=1.5 ST.



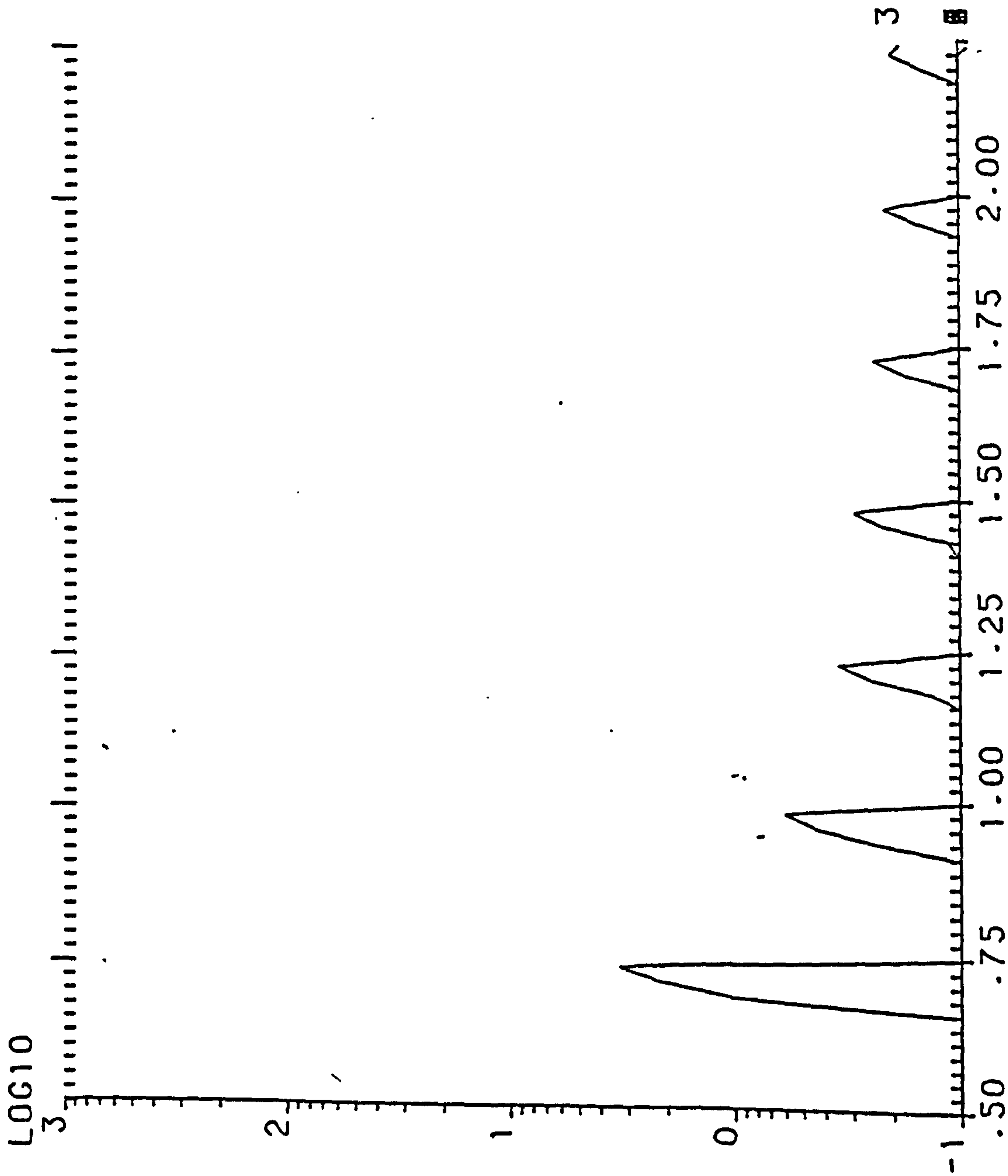

Y. EFFICIENCY W. THICKNESS= .36M W. ORIENTATION=315.00

WD= 3M HD1= 22M HD2= 12M HOUSE T.=1.5 ST.

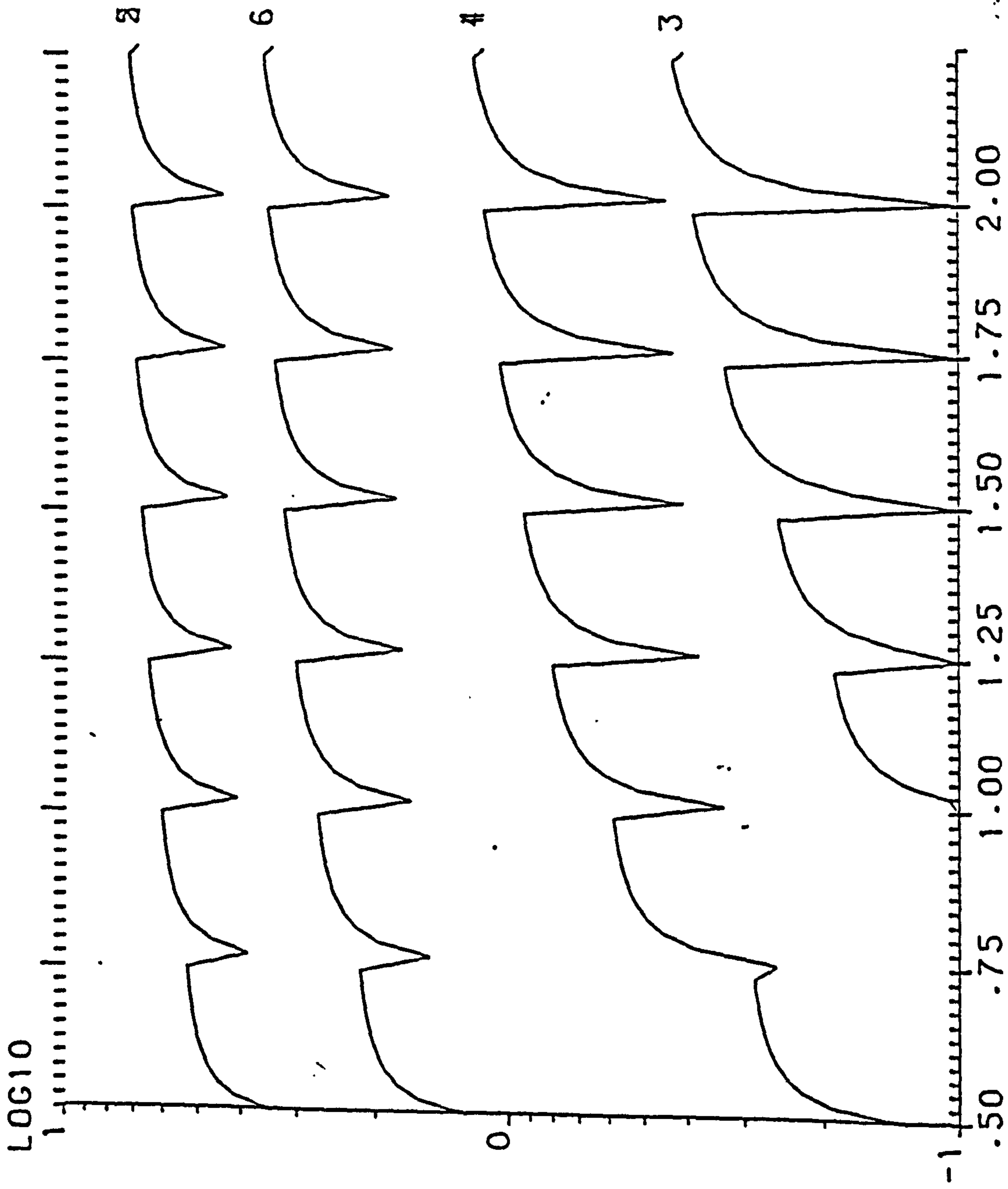

S. EFFICIENCY W. THICKNESS= .36M W. ORIENTATION=315.00

WD= 3M HD1= 22M HD2= 12M HOUSE T.=1.5 ST.

LOG10  
1  
0  
-1

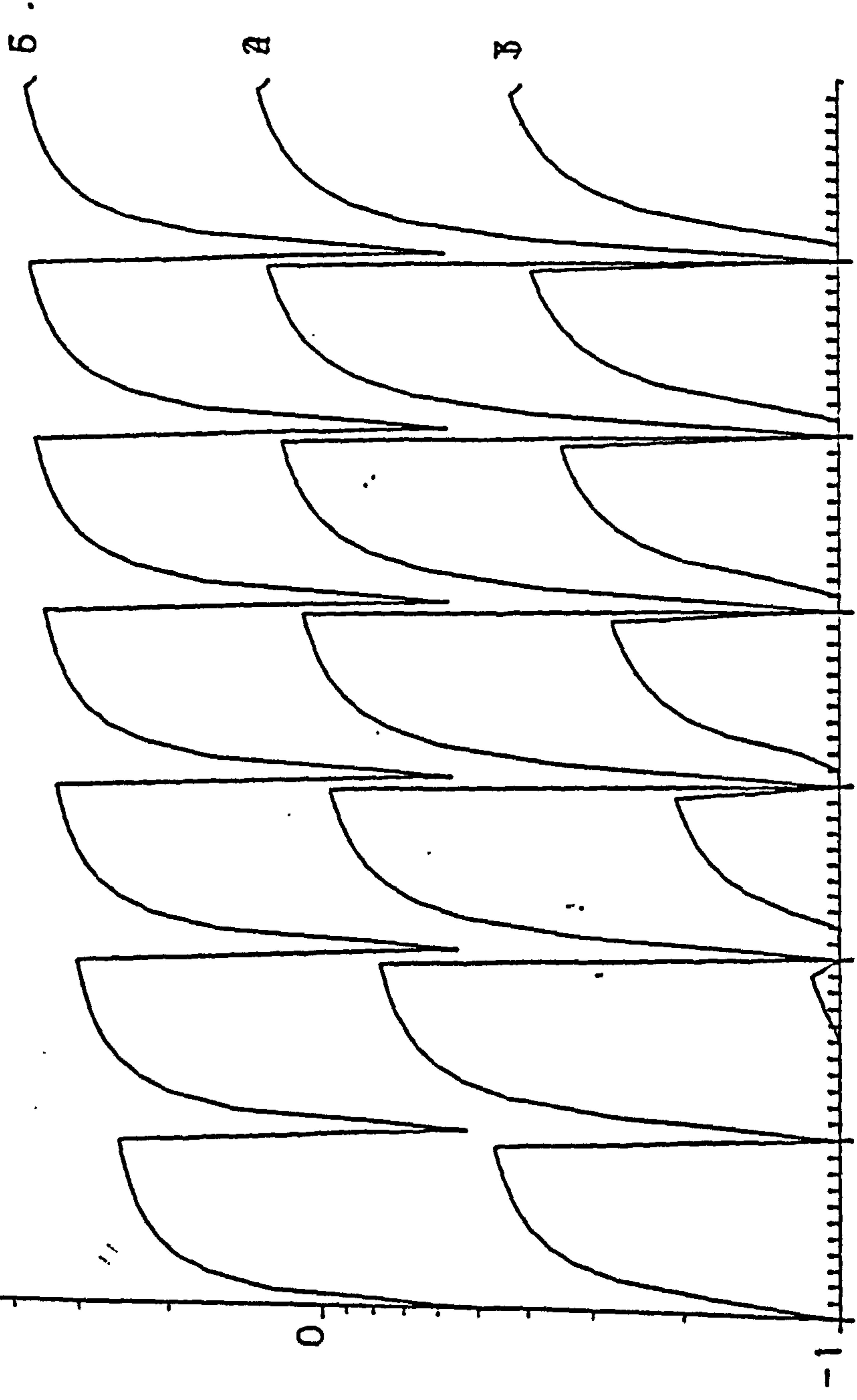

S. EFFICIENCY W. THICKNESS= .36M W. ORIENTATION=337.50

WD= 3M HD1= 22M HD2= 12M HOUSE T.=1.5 ST.



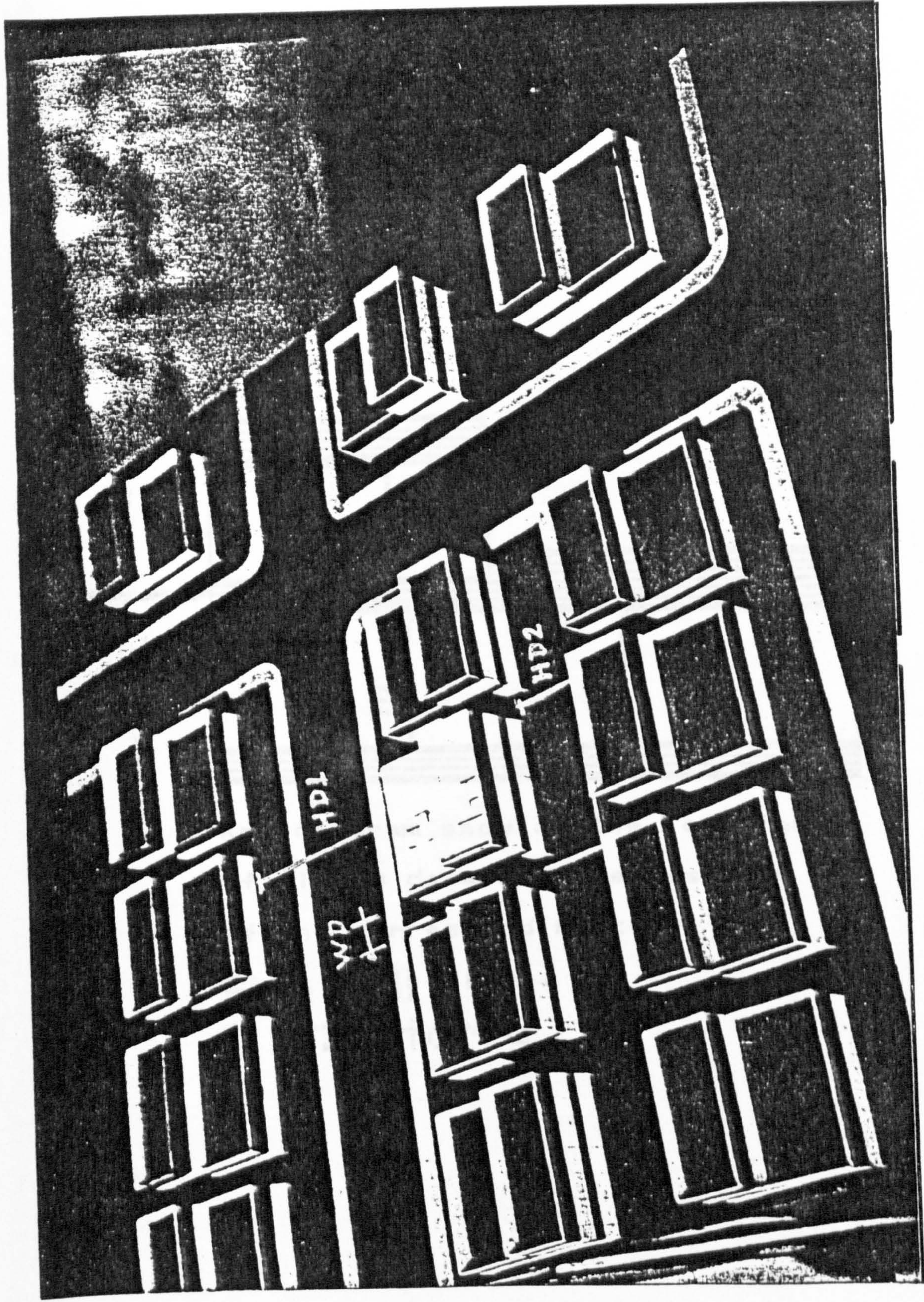

Model showing interhouse distances



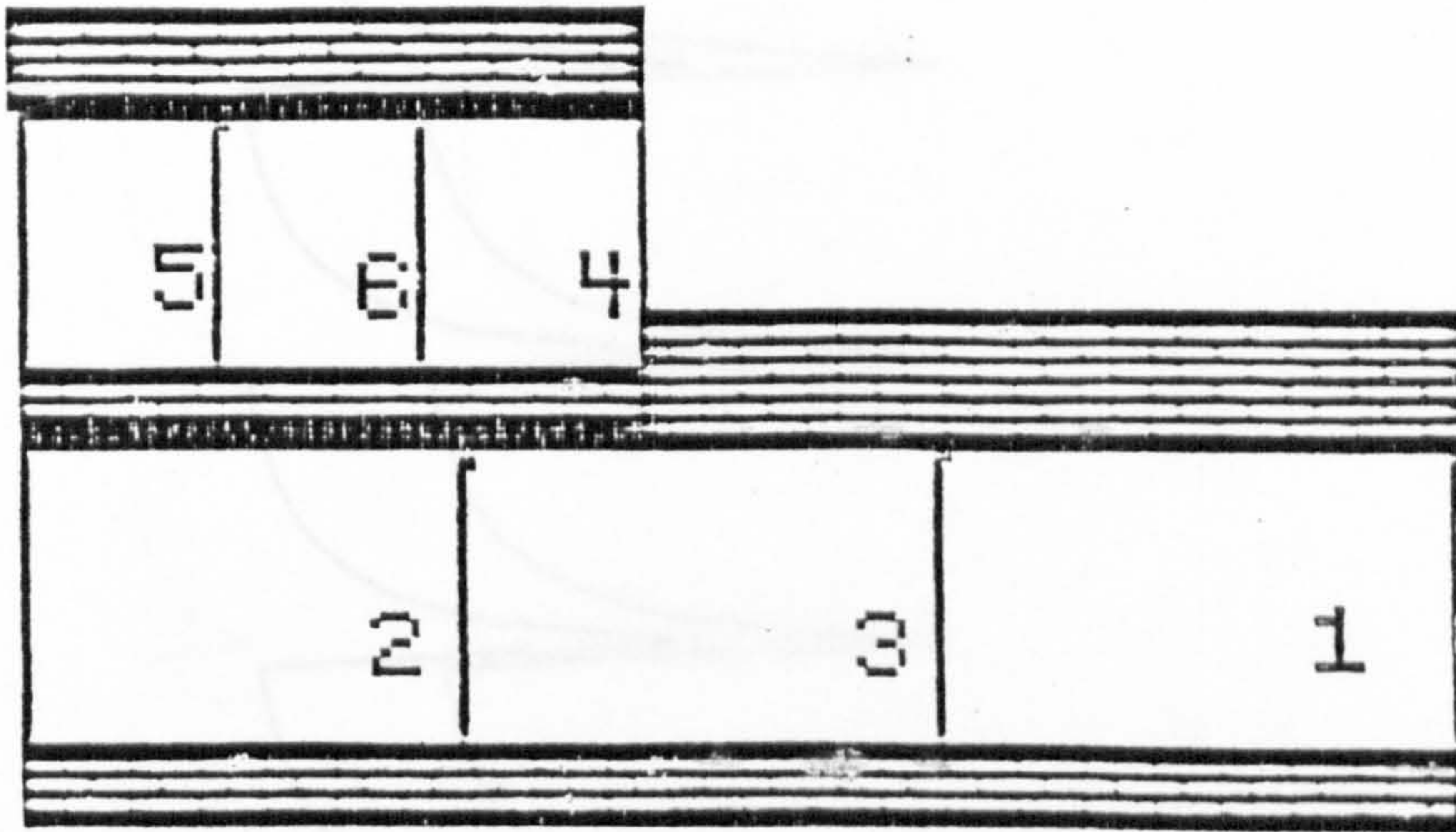

Key diagram showing the location  
of window data and the position  
of the corresponding curve

Side Wall No. 2  
1 1/2 Storey

LOG10

EFFICIENCY 0.75 1.00 1.25 1.50 1.75 2.00

W. THICKNESS = 0.12M W. ORIENTATION = 0.02

HD1 = 2.2M HD2 = 4M HOUSE T. = 1.5 ST.

LOG10  
1

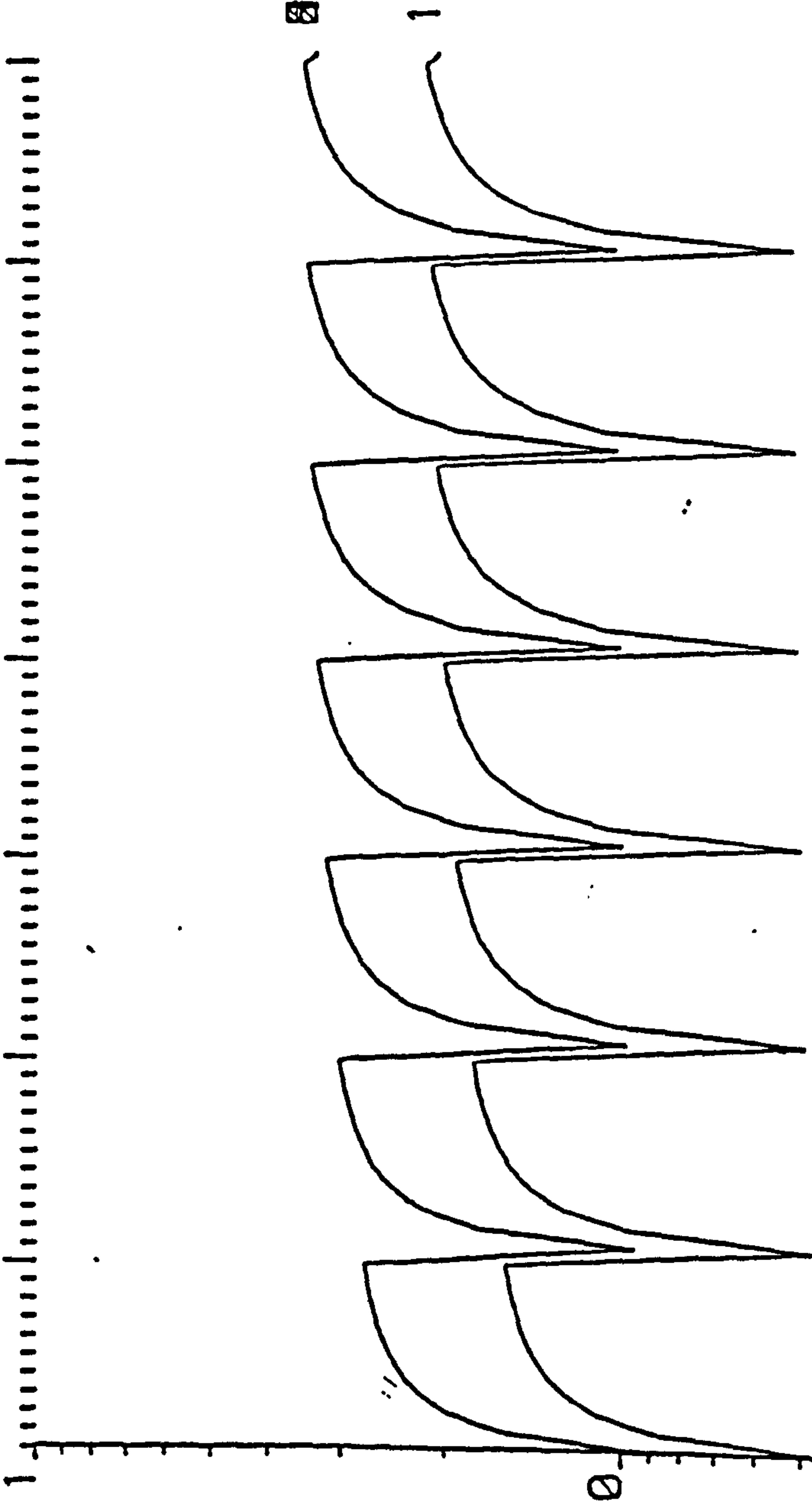

-1  
 .50 .75 1.00 1.25 1.50 1.75 2.00  
 S. EFFICIENCY W. THICKNESS= .12M W. ORIENTATION= .00  
 WD= 4M HD1= 22M HD2= 4M HOUSE T.=1.5 ST.

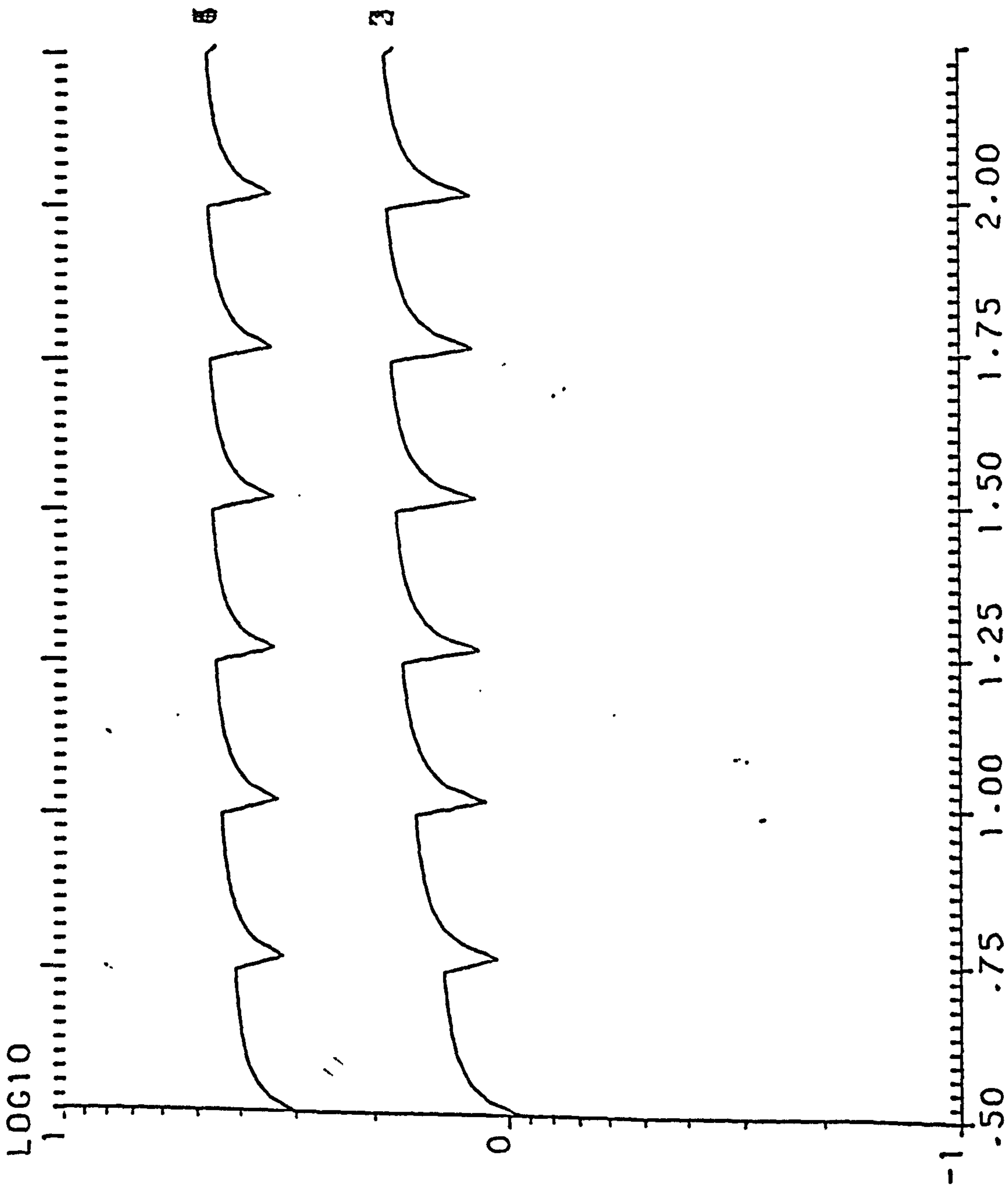

S. EFFICIENCY W. THICKNESS= .12M W. ORIENTATION= 22.50

WD= 4M HD1= 22M HD2= 4M HOUSE T.=1.5 ST.

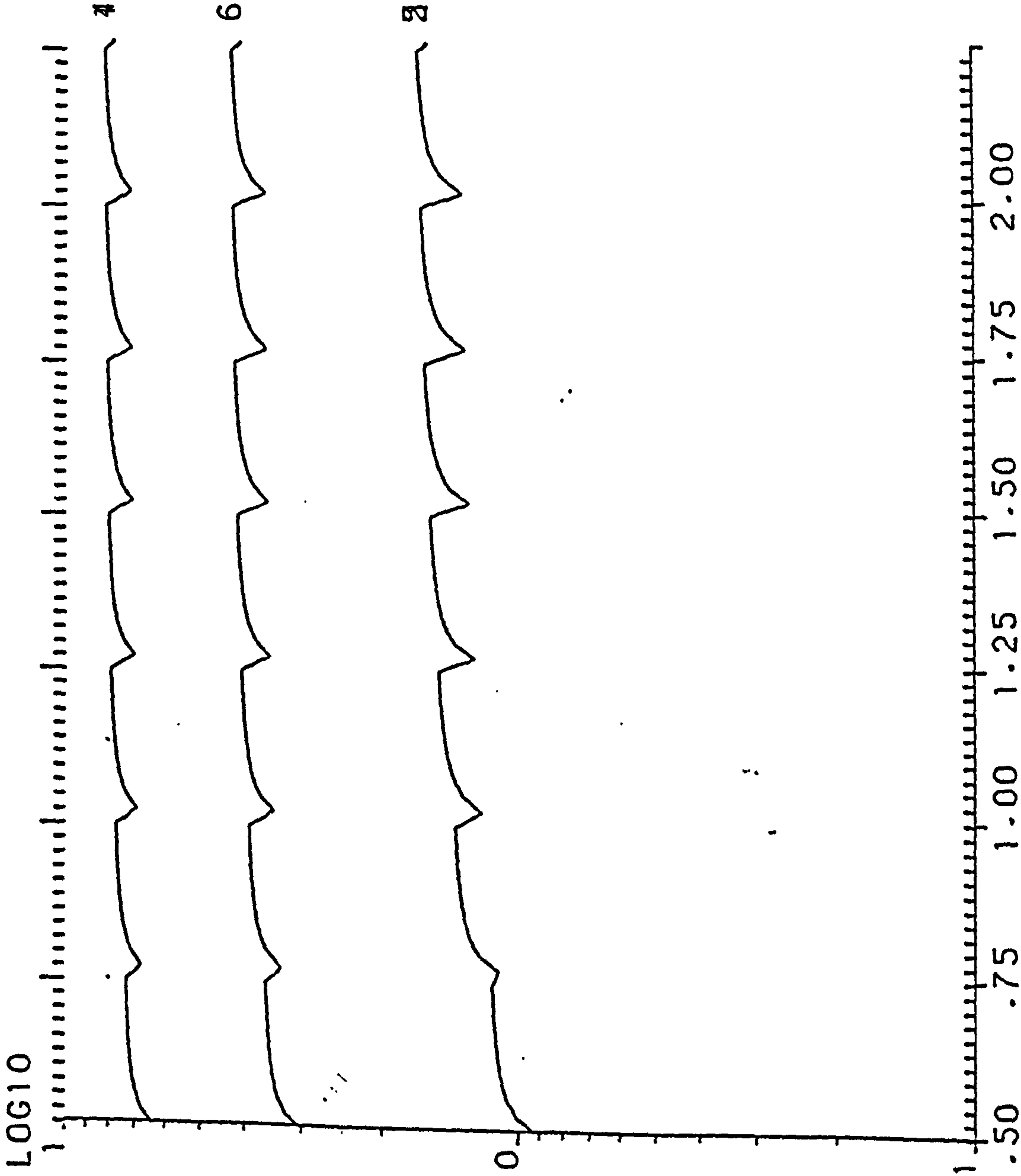

S. EFFICIENCY W. THICKNESS= .12M HD2= 4M HOUSE T.= 1.5 ST.  
 .50 .75 1.00 1.25 1.50 1.75 2.00 W. ORIENTATION= 45.00

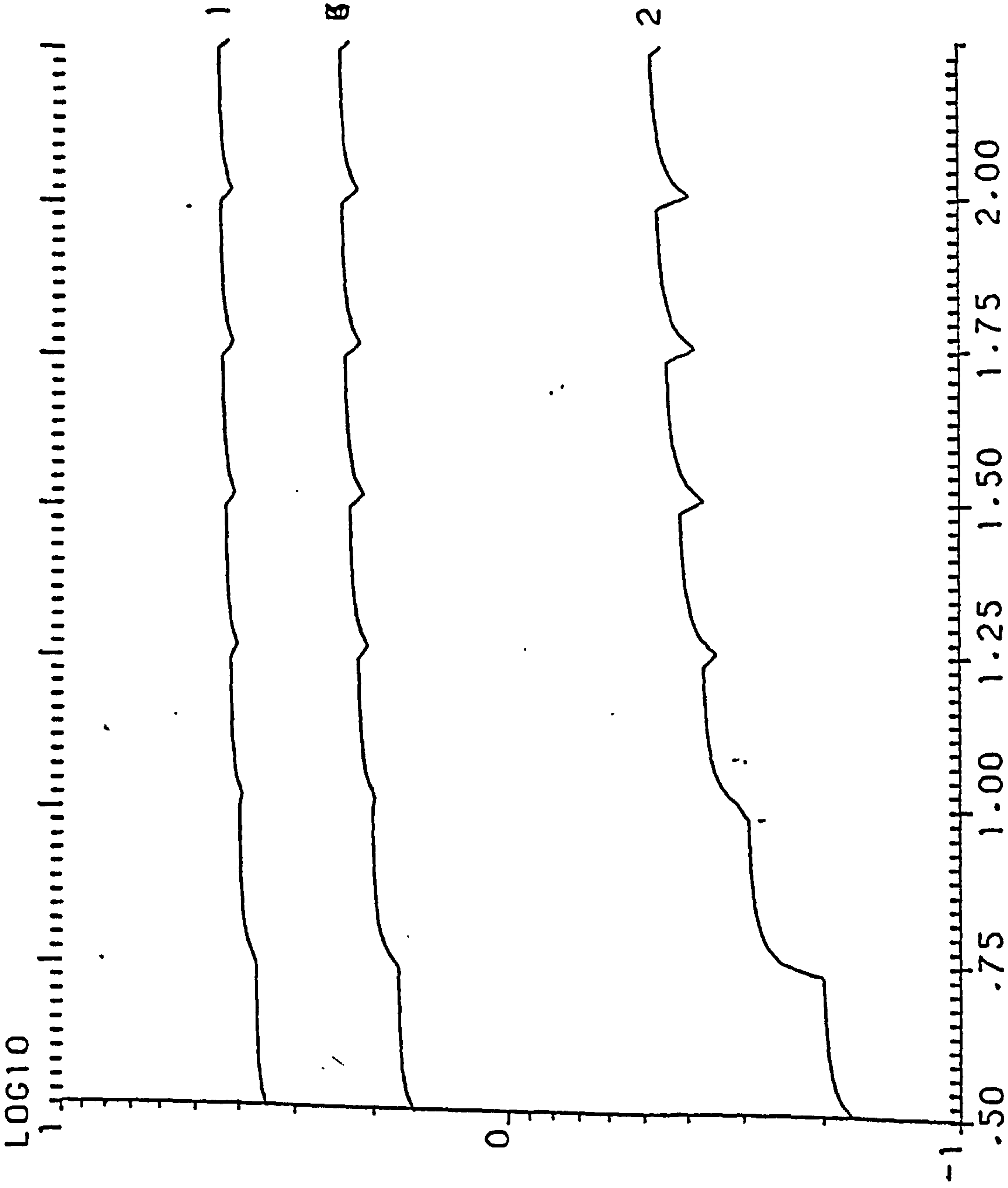

S. EFFICIENCY W. THICKNESS= .12M HD2= 4M HOUSE T.=1.5 ST.  
 W. ORIENTATION= 67.50

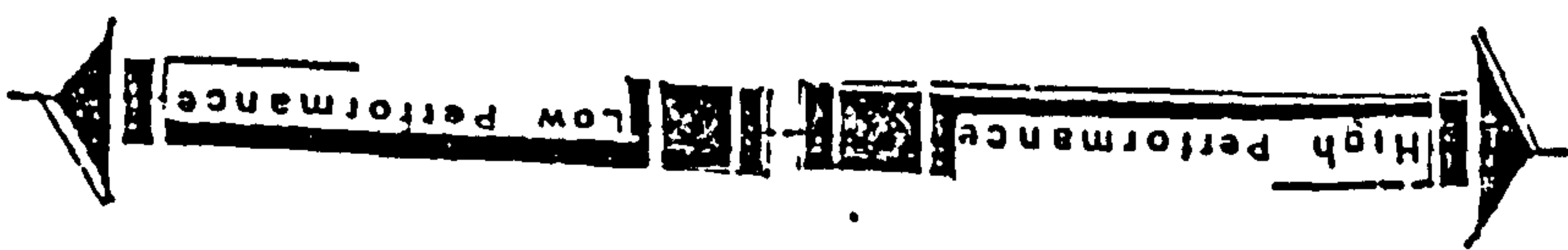



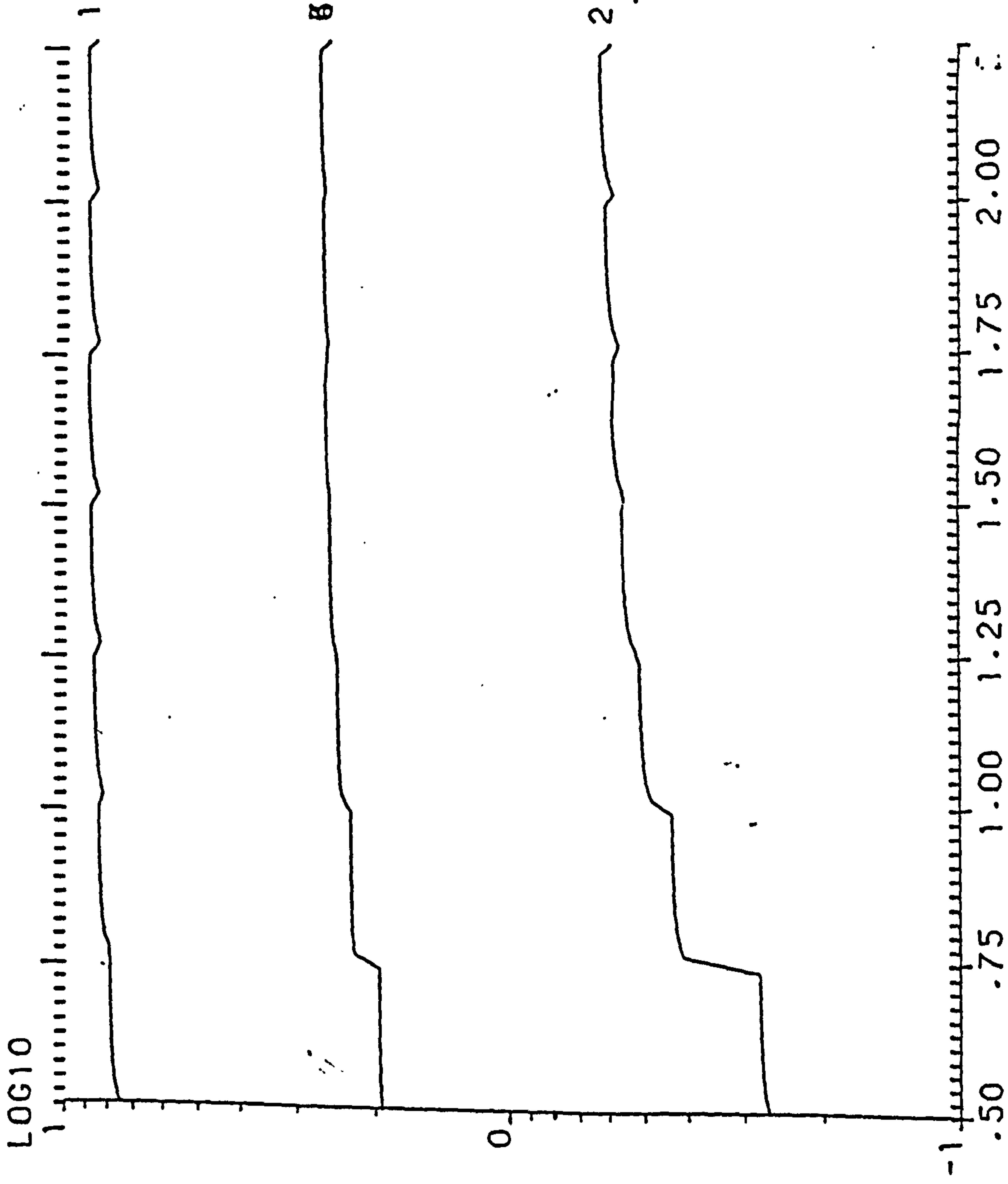

S. EFFICIENCY    W. THICKNESS=    .12M    W. ORIENTATION= 90.00  
 WD= 4M    HD1= 22M    HD2= 4M    HOUSE T.= 1.5 ST.

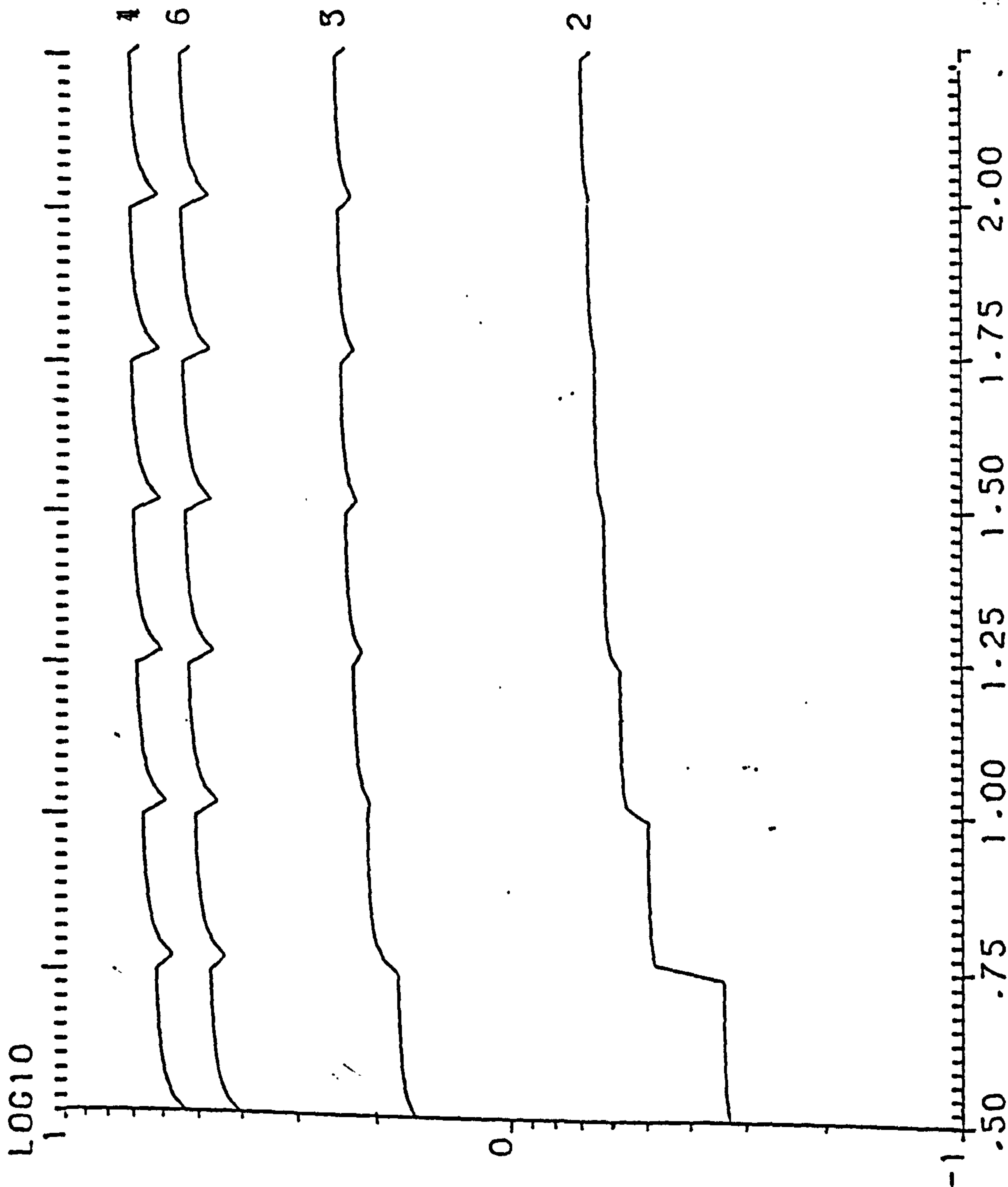

S. EFFICIENCY W. THICKNESS= .12M W. ORIENTATION=112.50  
 WD= 4M HD1= 22M HD2= 4M HOUSE T.=1.5 ST.

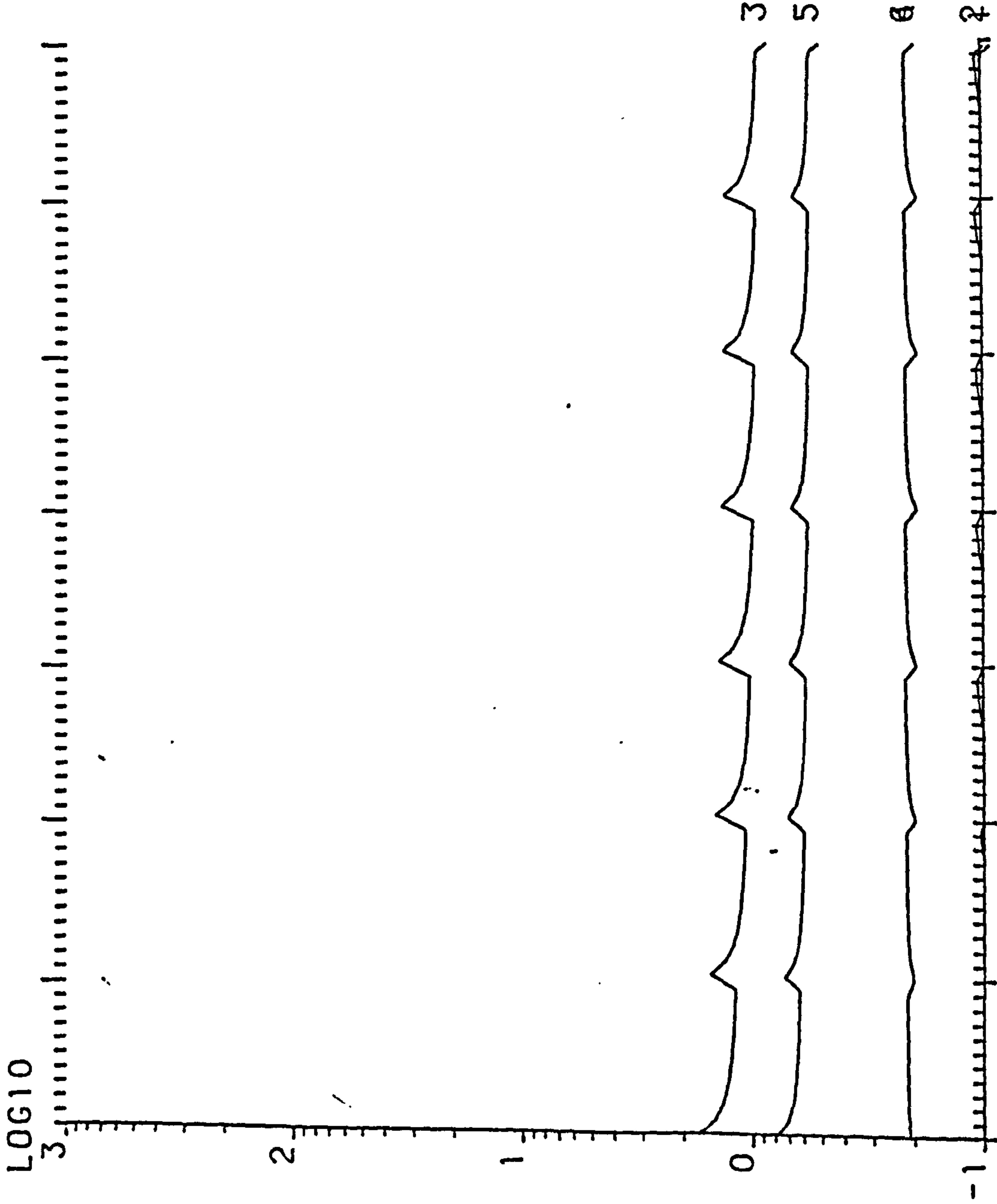

.50 .75 1.00 1.25 1.50 1.75 2.00  
Y. EFFICIENCY W. THICKNESS= .12M W. ORIENTATION=135.00  
WD= 4M HD1= 22M HD2= 4M HOUSE T.=1.5 ST.

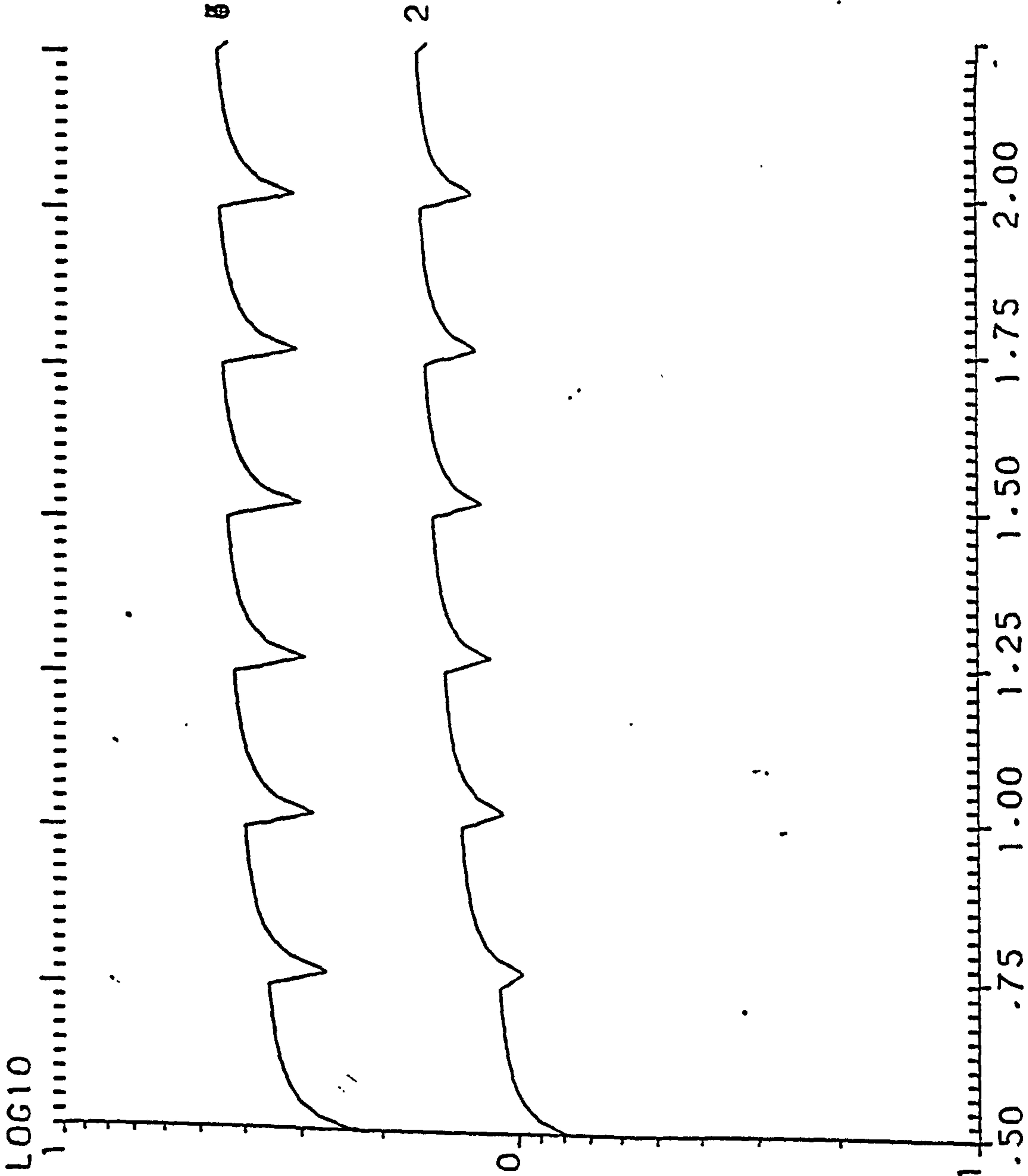

S. EFFICIENCY W. THICKNESS= .12M W. ORIENTATION=135.00

WD= 4M HD1= 22M HD2= 4M HOUSE T.=1.5 ST.



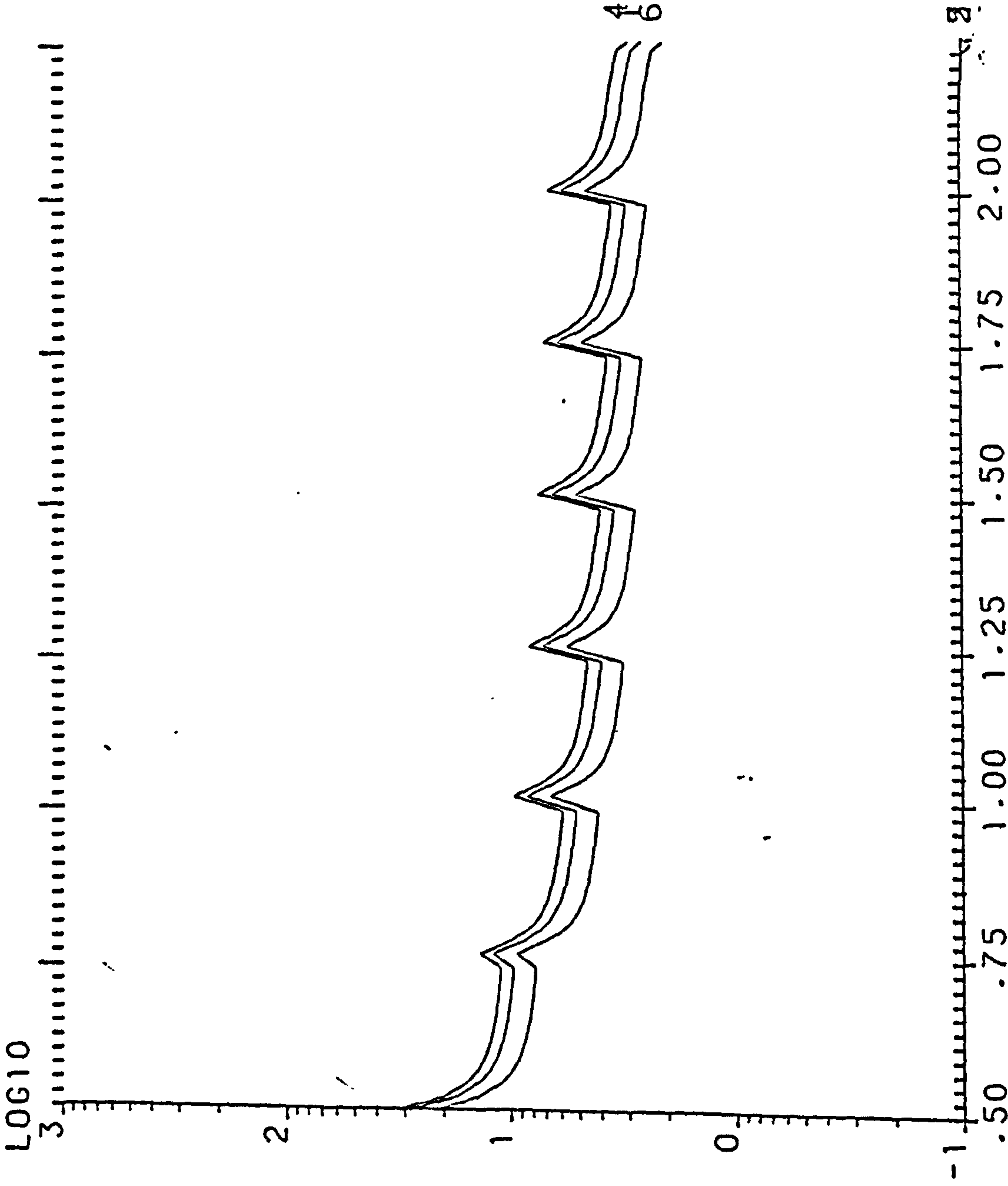

Y. EFFICIENCY W. THICKNESS= .12M W. ORIENTATION=157.50

WD= 4M HD1= 22M HD2= 4M HOUSE T.=1.5 ST.



LOG10

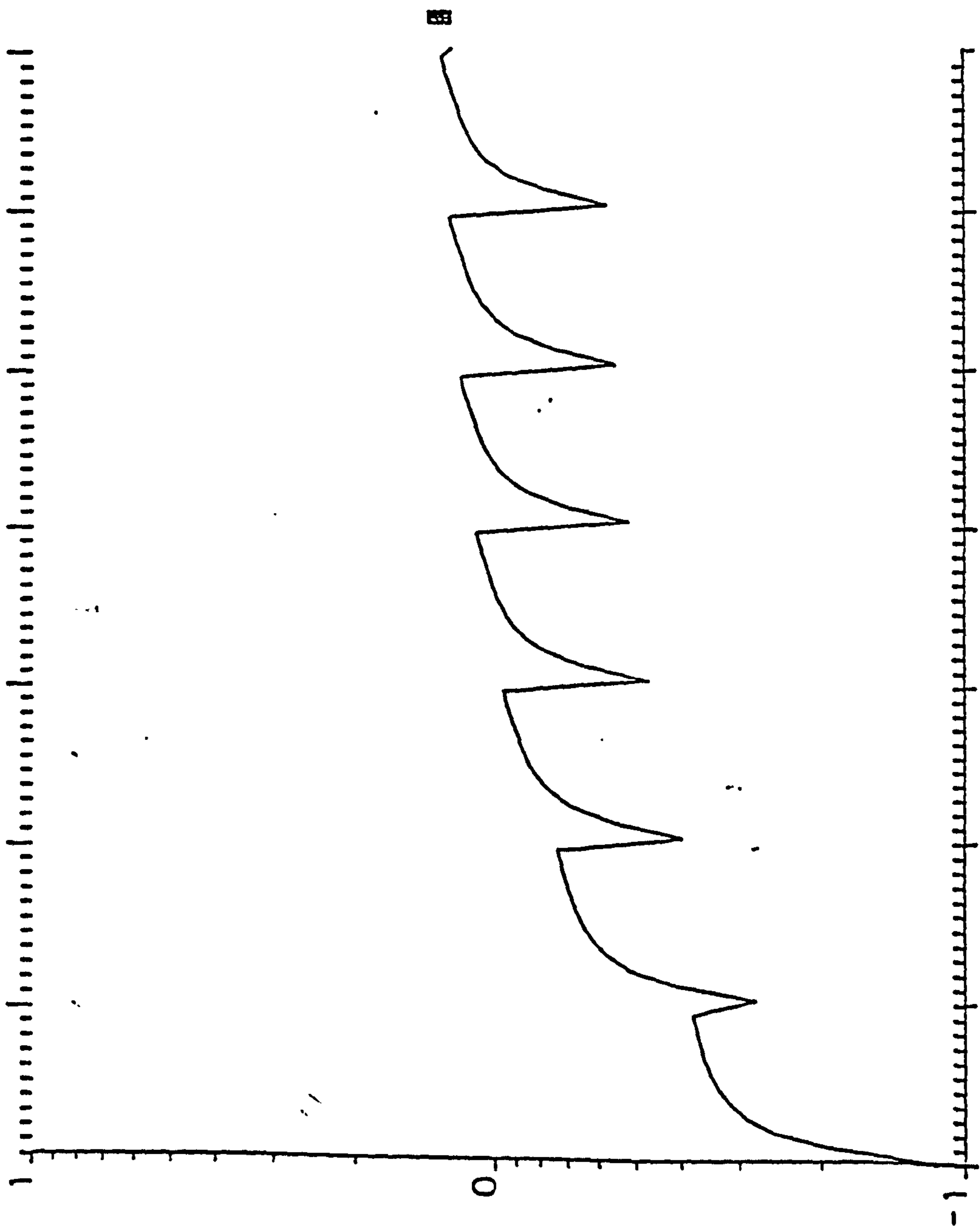

S. EFFICIENCY    W. THICKNESS=    .12M    HD2=    4M    HOUSE T.=1.5 ST.  
 HD1= 22M

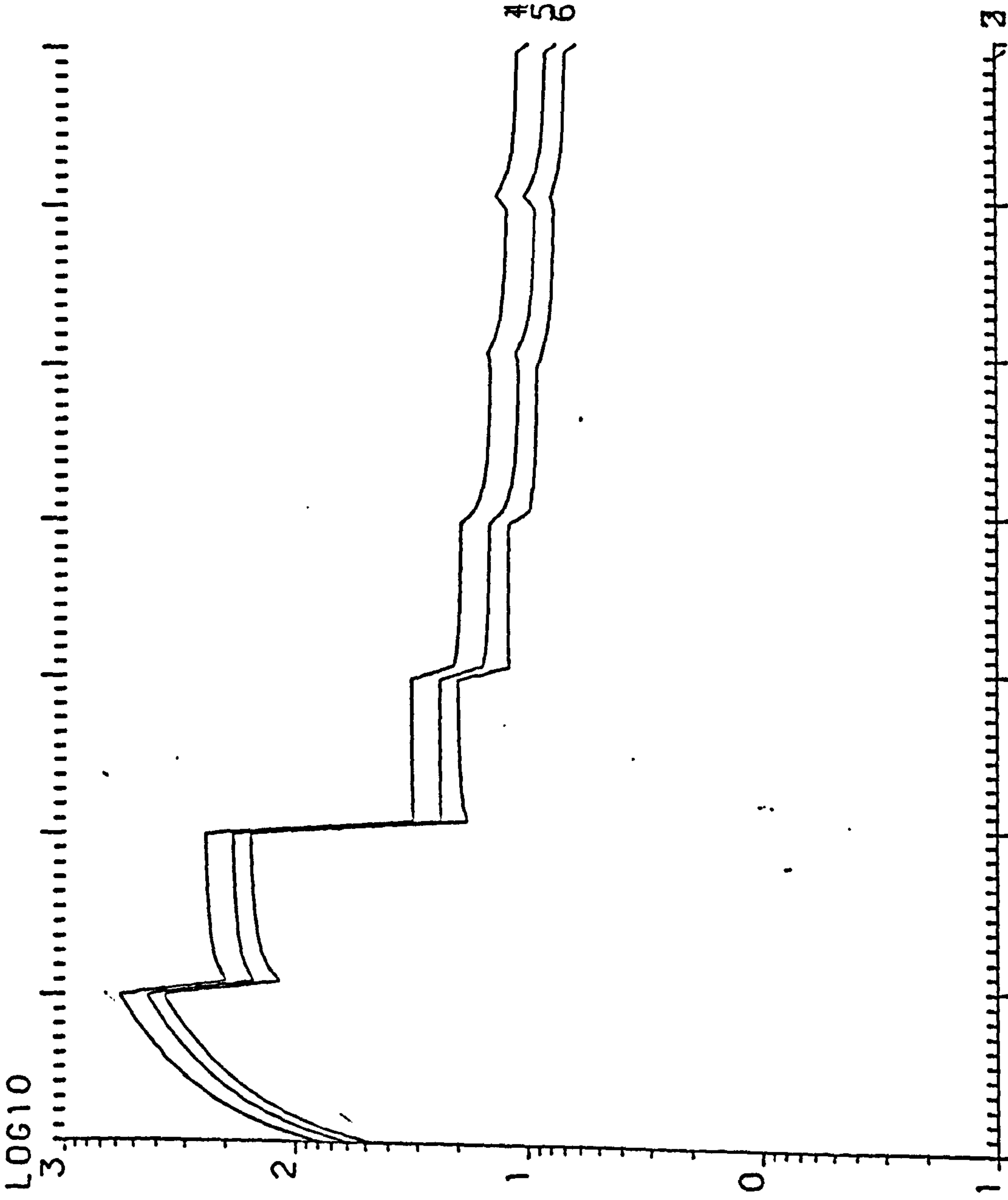

Y. EFFICIENCY W. THICKNESS= .12M W. ORIENTATION=180.00  
 WD= 4M HD1= 22M HD2= 4M HOUSE T.=1.5 ST.

450

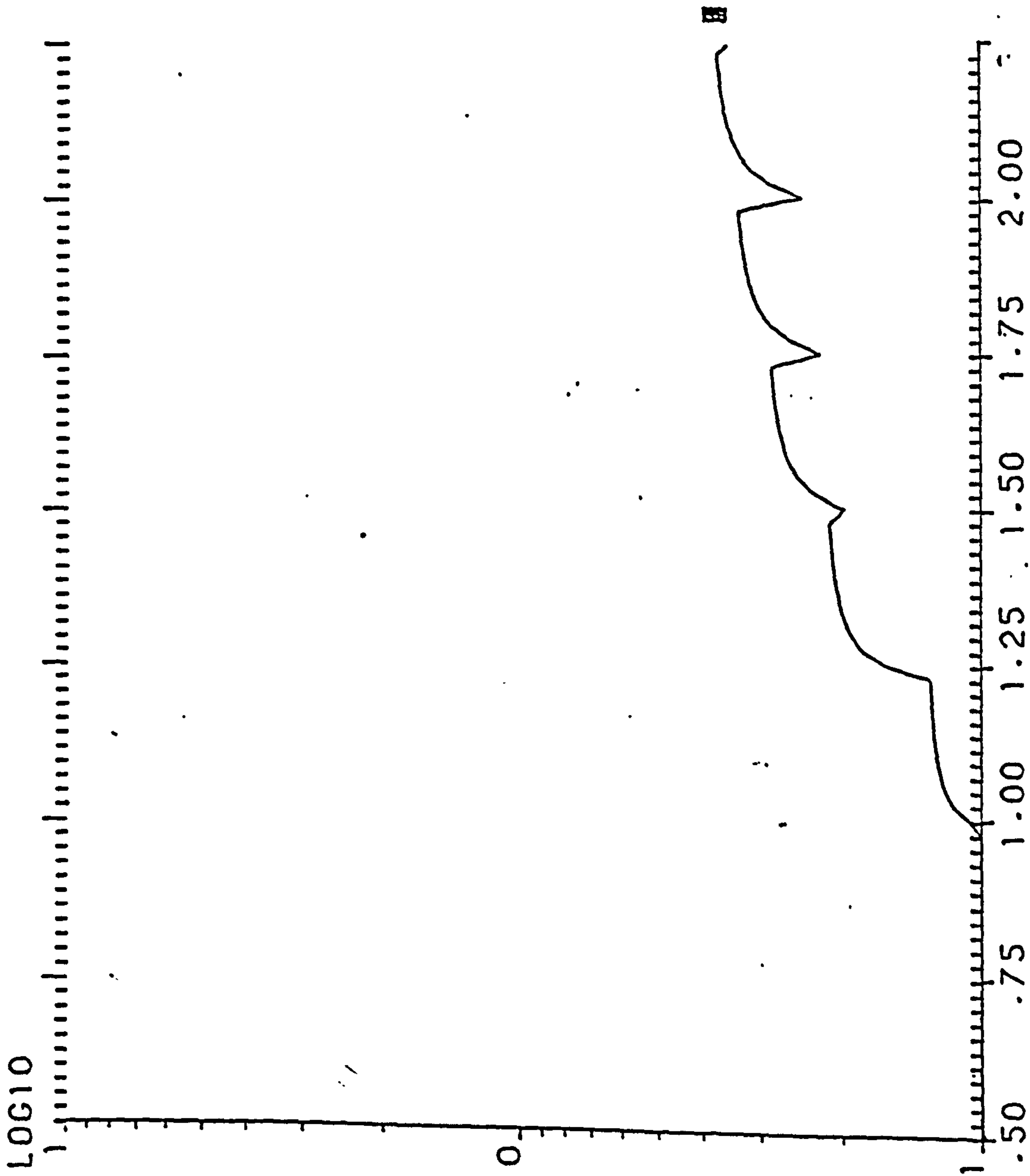

S. EFFICIENCY W. THICKNESS= .12M W. ORIENTATION=180.00

WD= 4M HD1= 22M HD2= 4M HOUSE T.=1.5 ST.

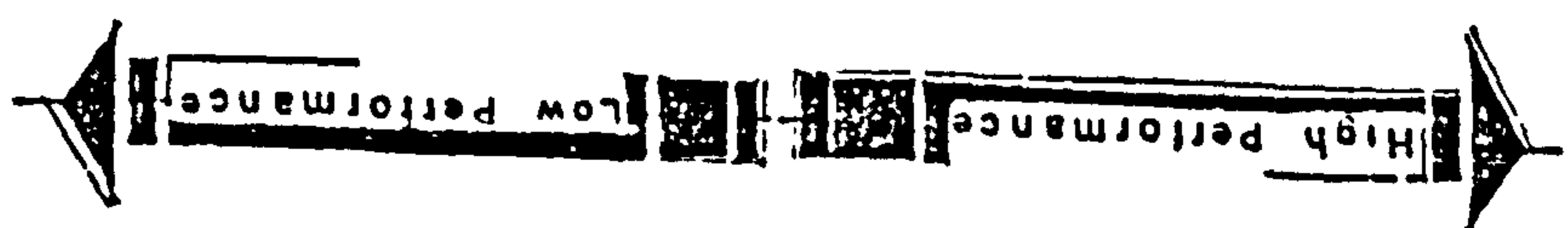

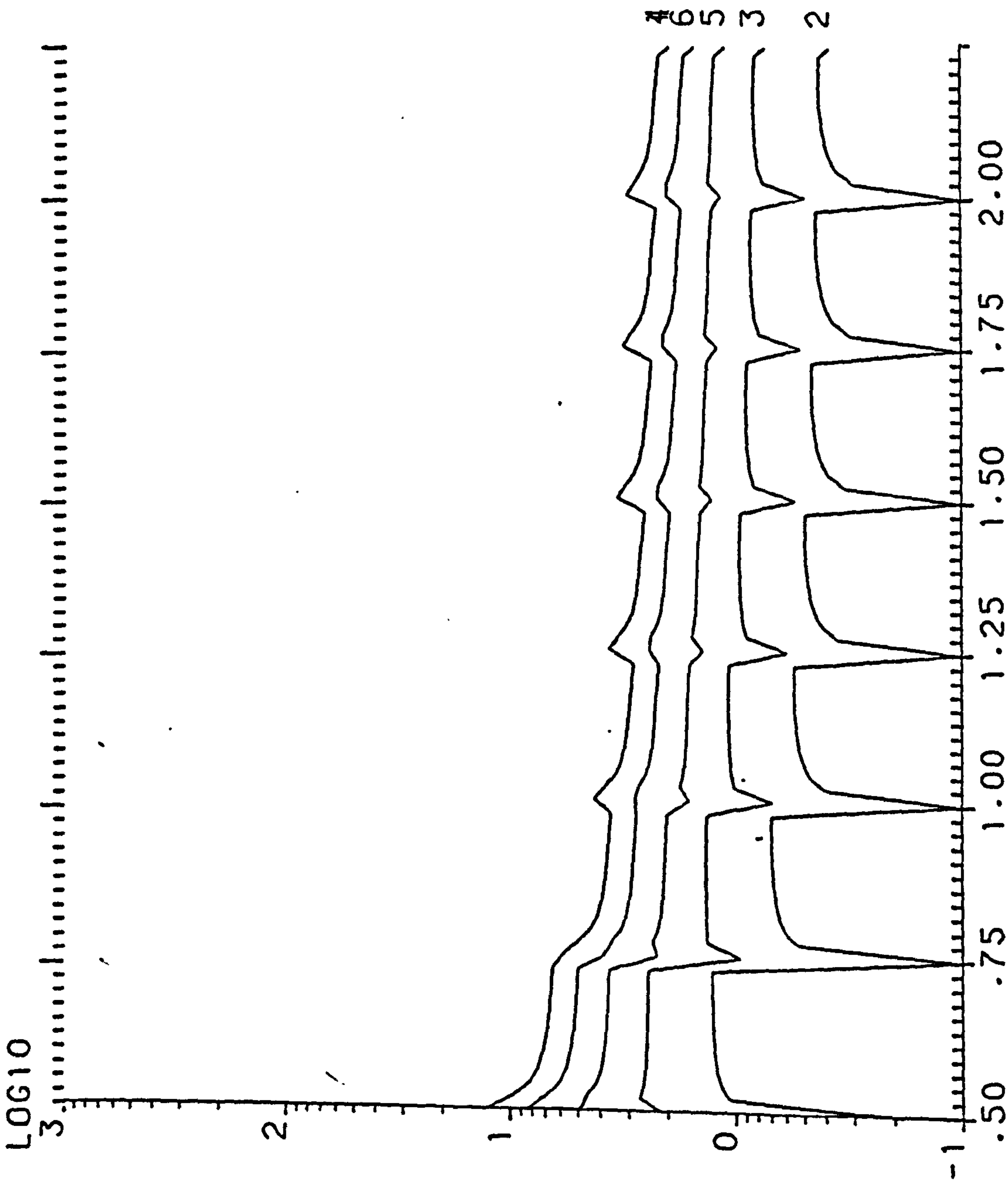

Y. EFFICIENCY    W. THICKNESS= .12M    W. ORIENTATION=202.50  
 WD= 4M    HD1= 22M    HD2= 4M    HOUSE T.=1.5 ST.

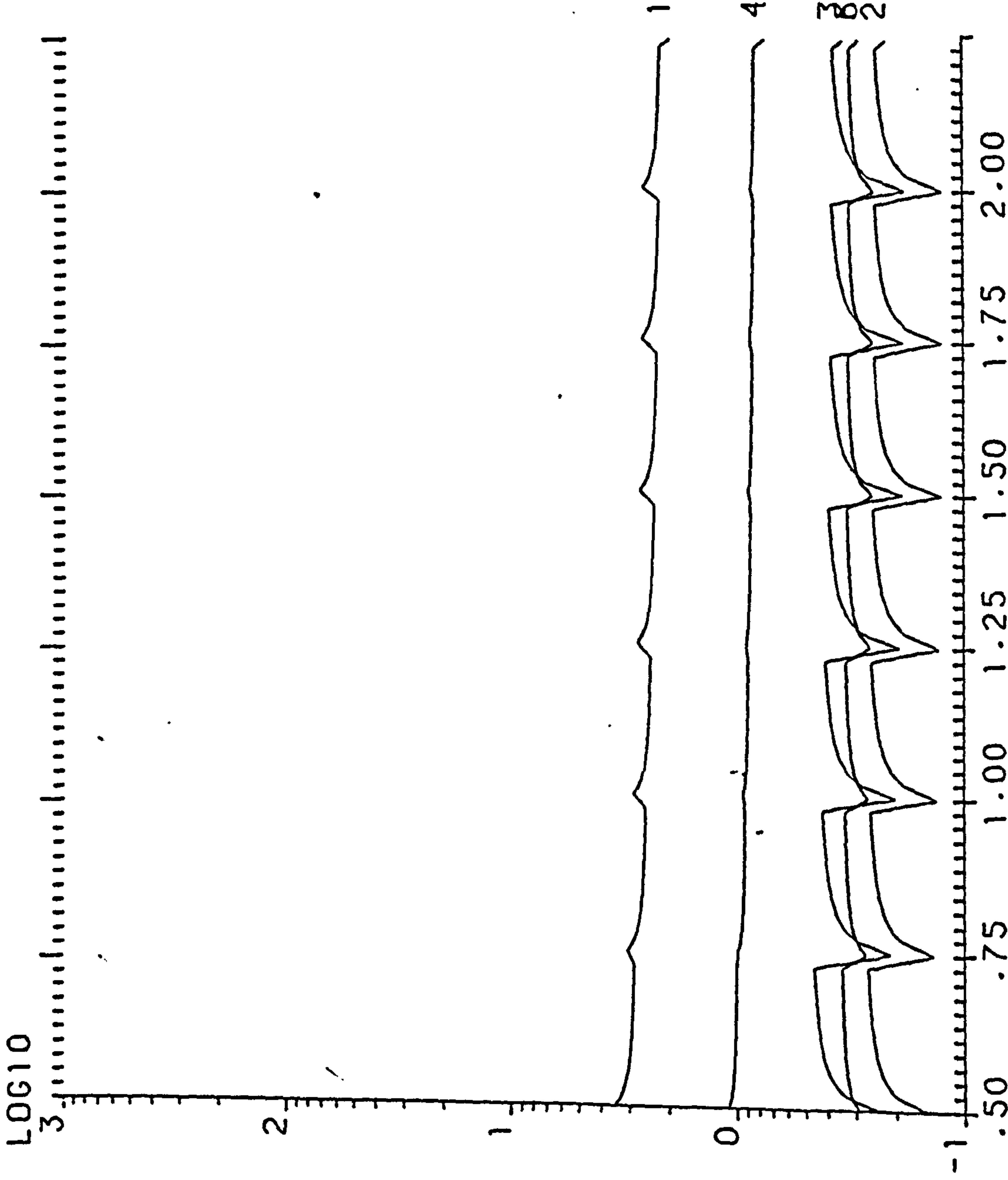

Y. EFFICIENCY W. THICKNESS= .12M W. ORIENTATION=225.00  
WD= 4M HD1= 22M HD2= 4M HOUSE T.=1.5 ST.



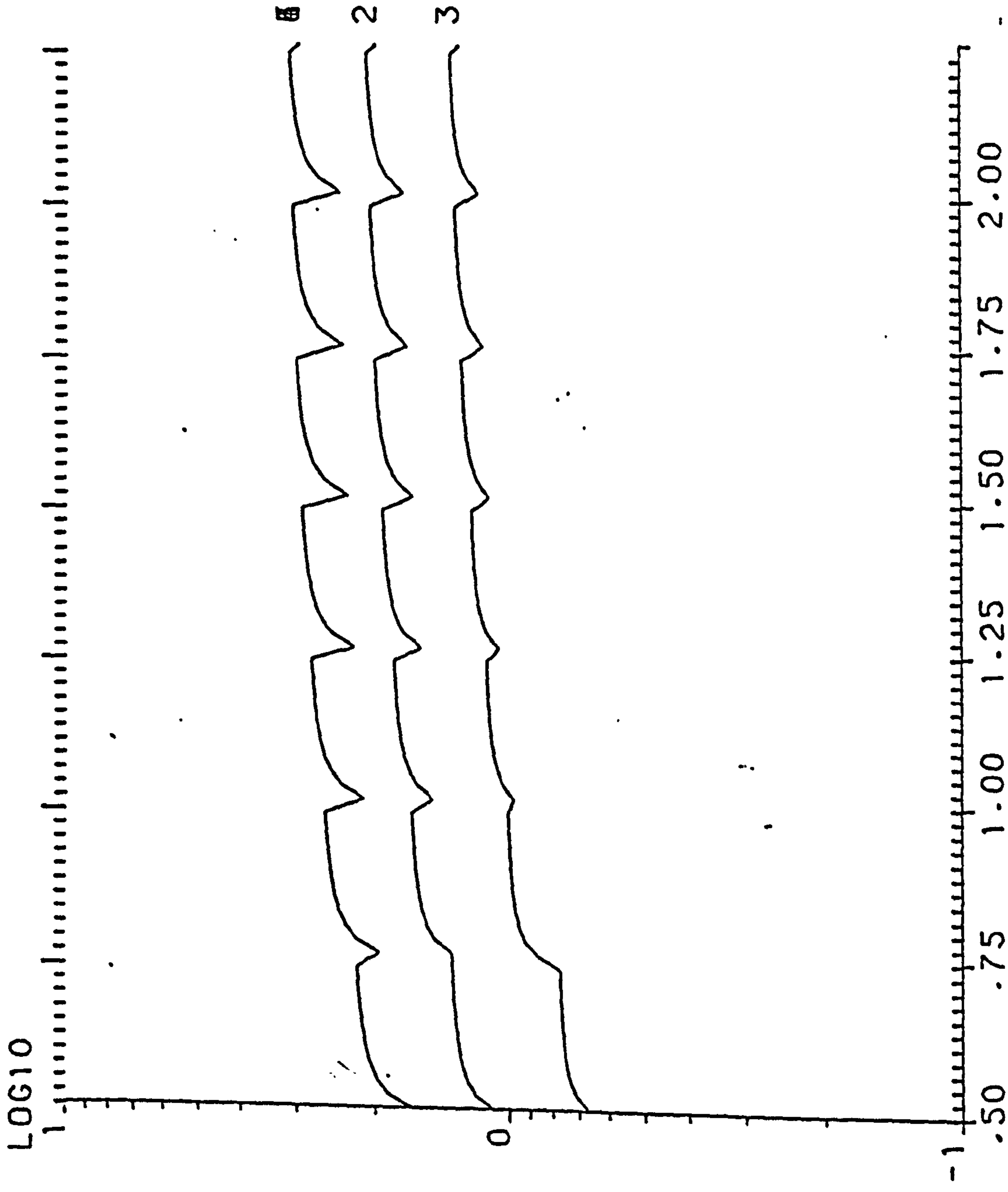

S. EFFICIENCY    W. THICKNESS= .12M    HD2= 4M    HOUSE T.=1.5 ST.  
 WD= 4M    HD1= 22M

W. ORIENTATION=225.00

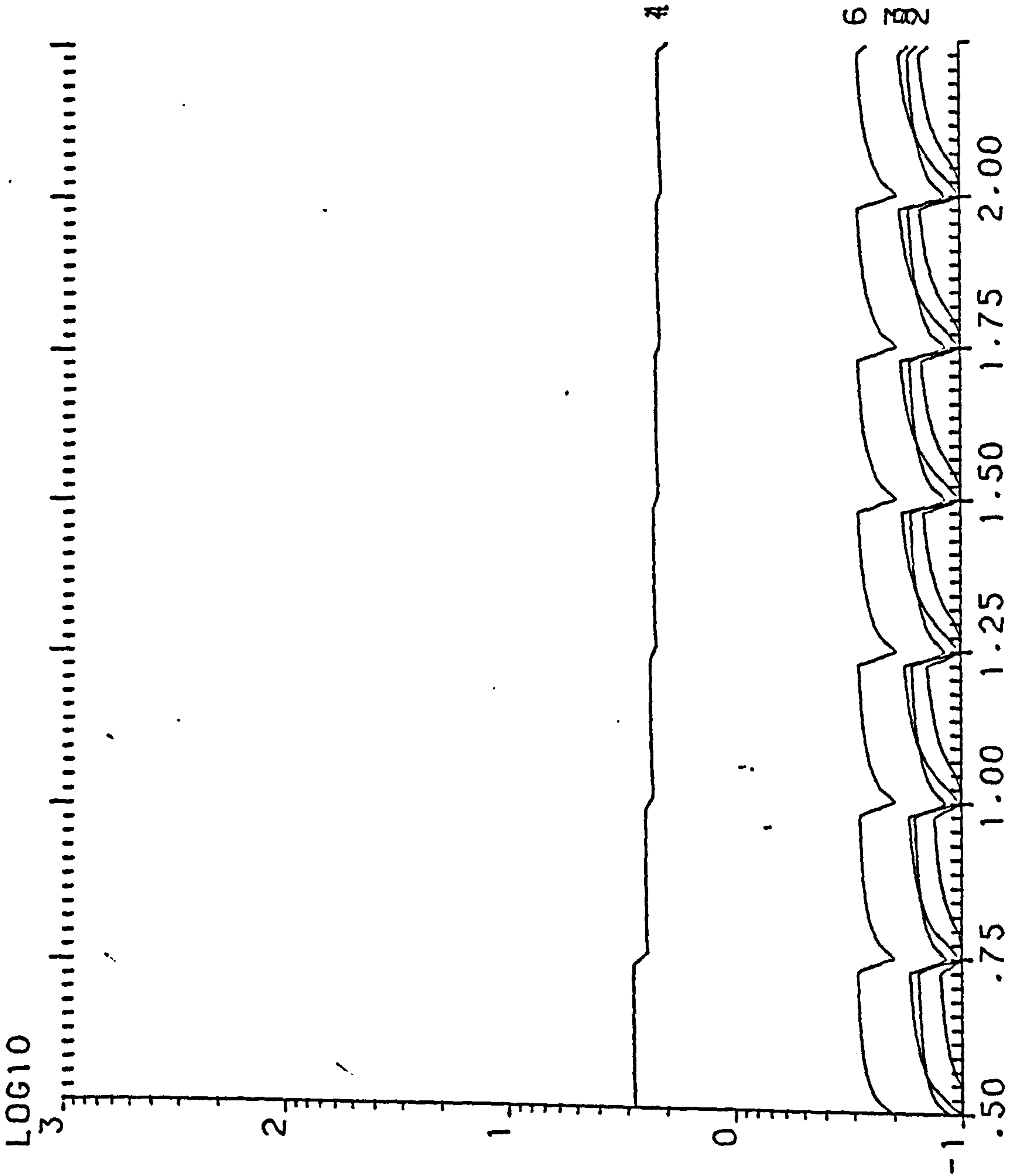

Y. EFFICIENCY W. THICKNESS= .12M W. ORIENTATION=247.50

WD= 4M HD1= 22M HD2= 4M HOUSE T.=1.5 ST.

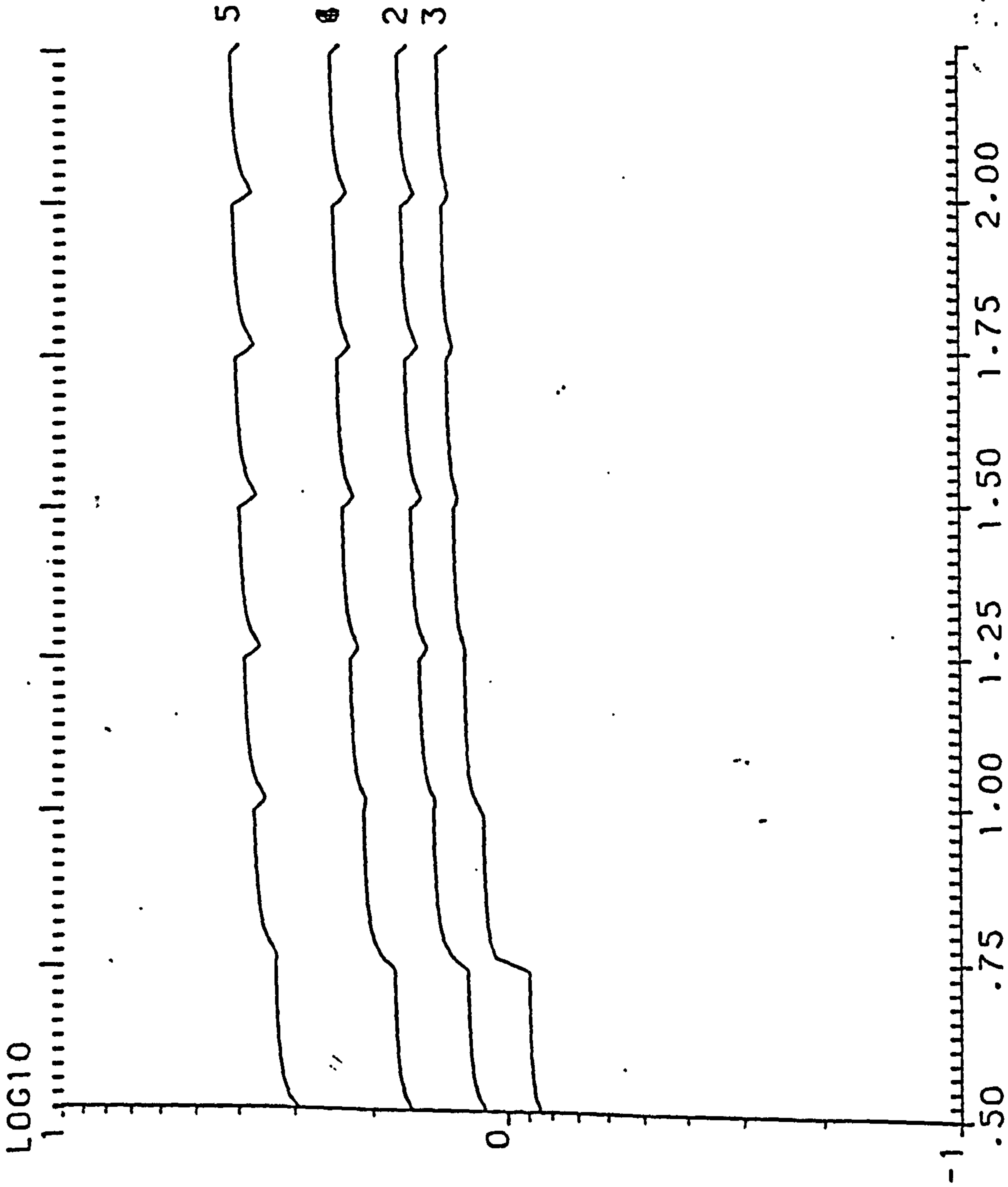

S. EFFICIENCY W. THICKNESS= .12M W. ORIENTATION=247.50

WD= 4M HD1= 22M HD2= 4M HOUSE T.=1.5 ST.

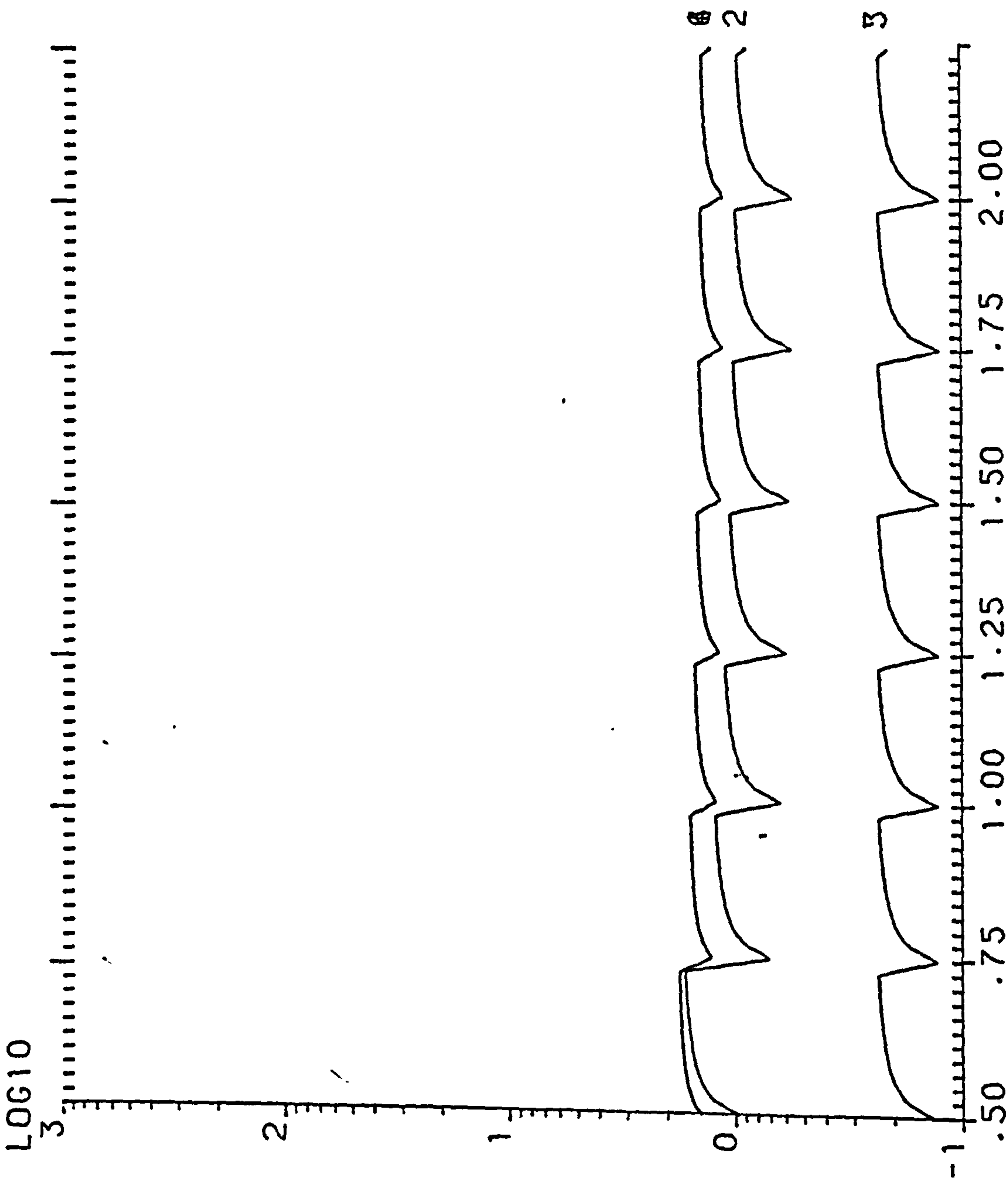

Y. EFFICIENCY W. THICKNESS= .12M W. ORIENTATION=270.00  
WD= 4M HD1= 22M HD2= 4M HOUSE T.=1.5 ST.

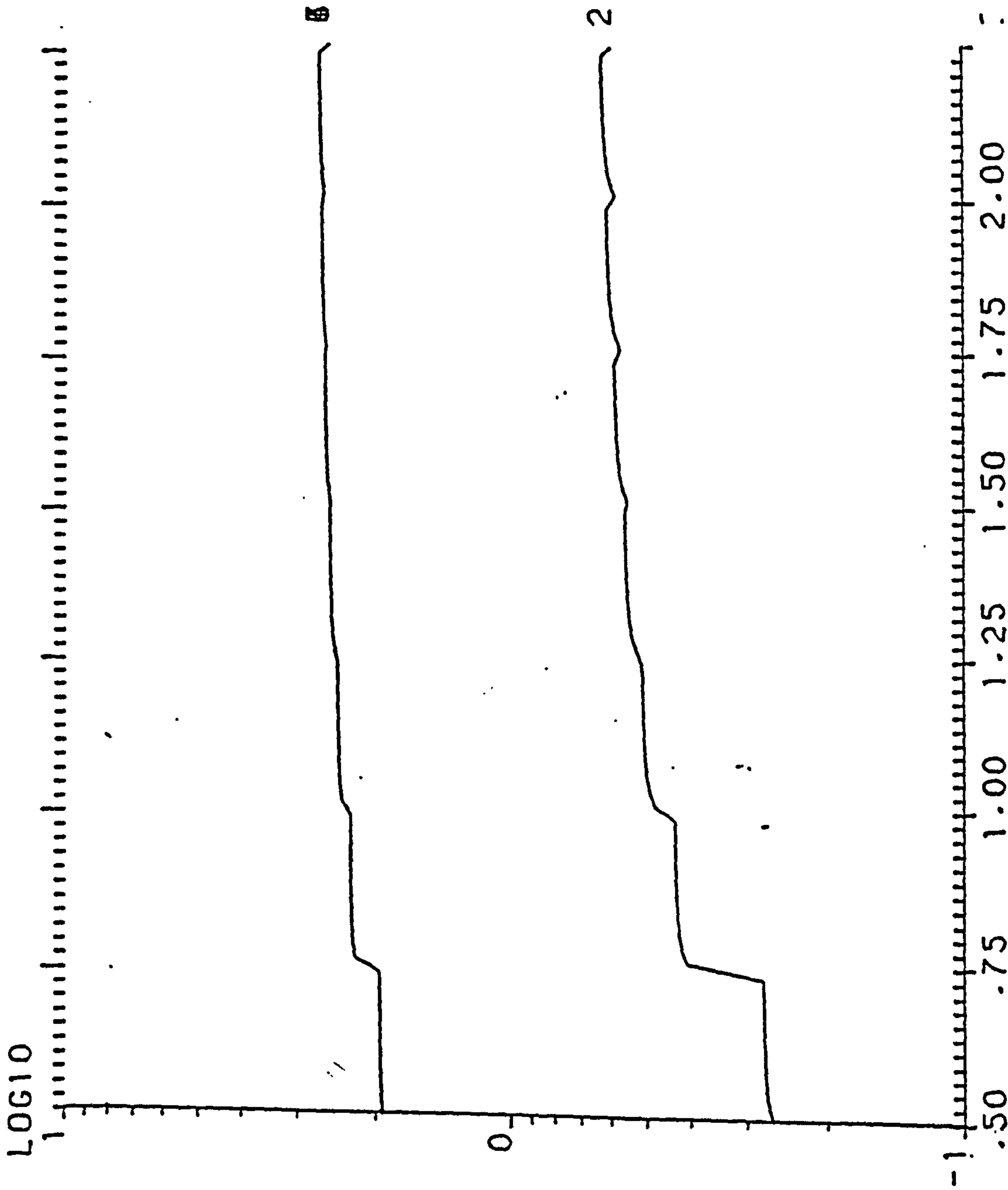

S. EFFICIENCY W. THICKNESS= .12M W. ORIENTATION=270.00

WD= 4M HD1= 22M HD2= 4M HOUSE T.=1.5 ST.



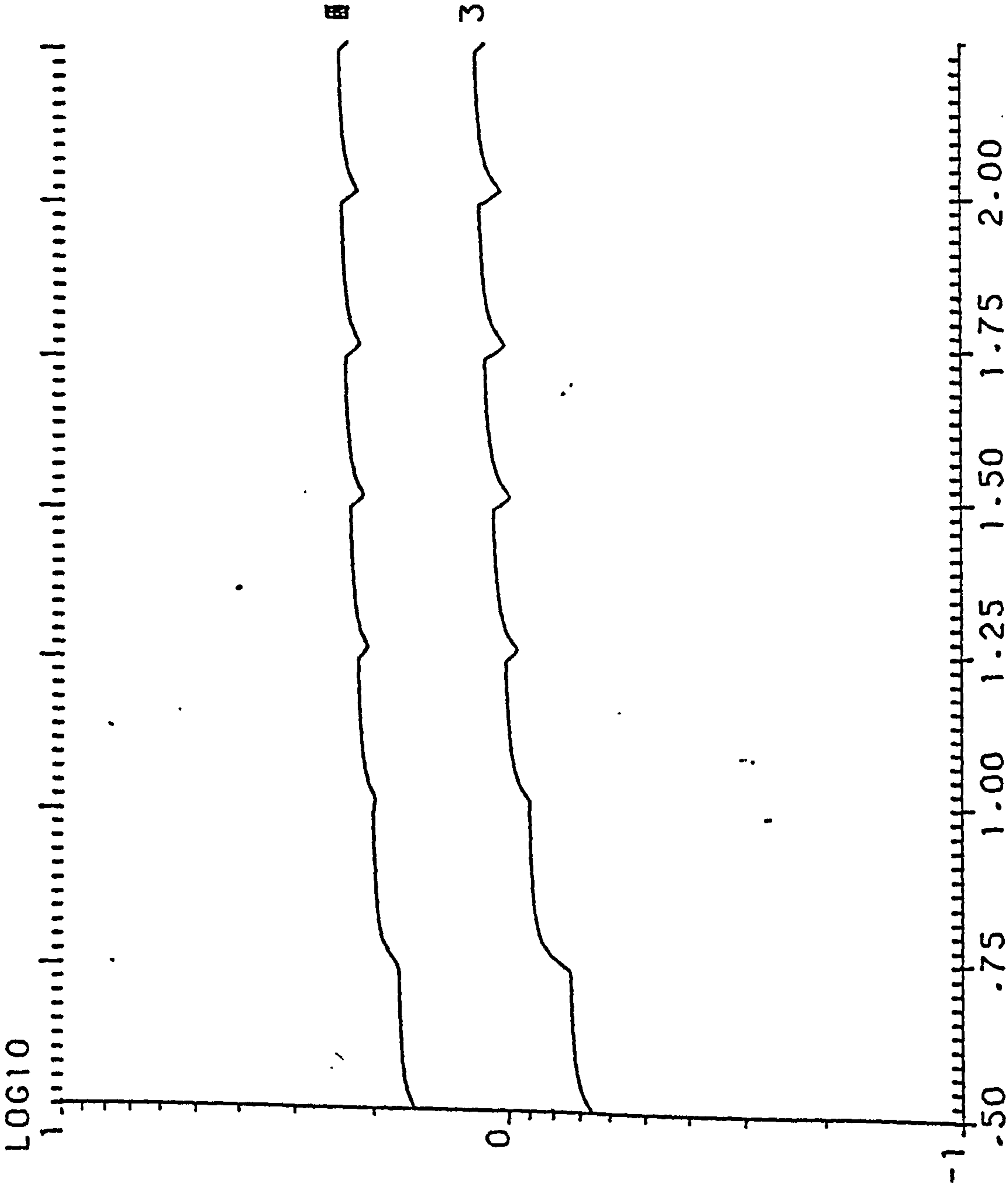

S. EFFICIENCY W. THICKNESS= .12M W. ORIENTATION=292.50  
 WD= 4M HD1= 22M HD2= 4M HOUSE T.=1.5 ST.

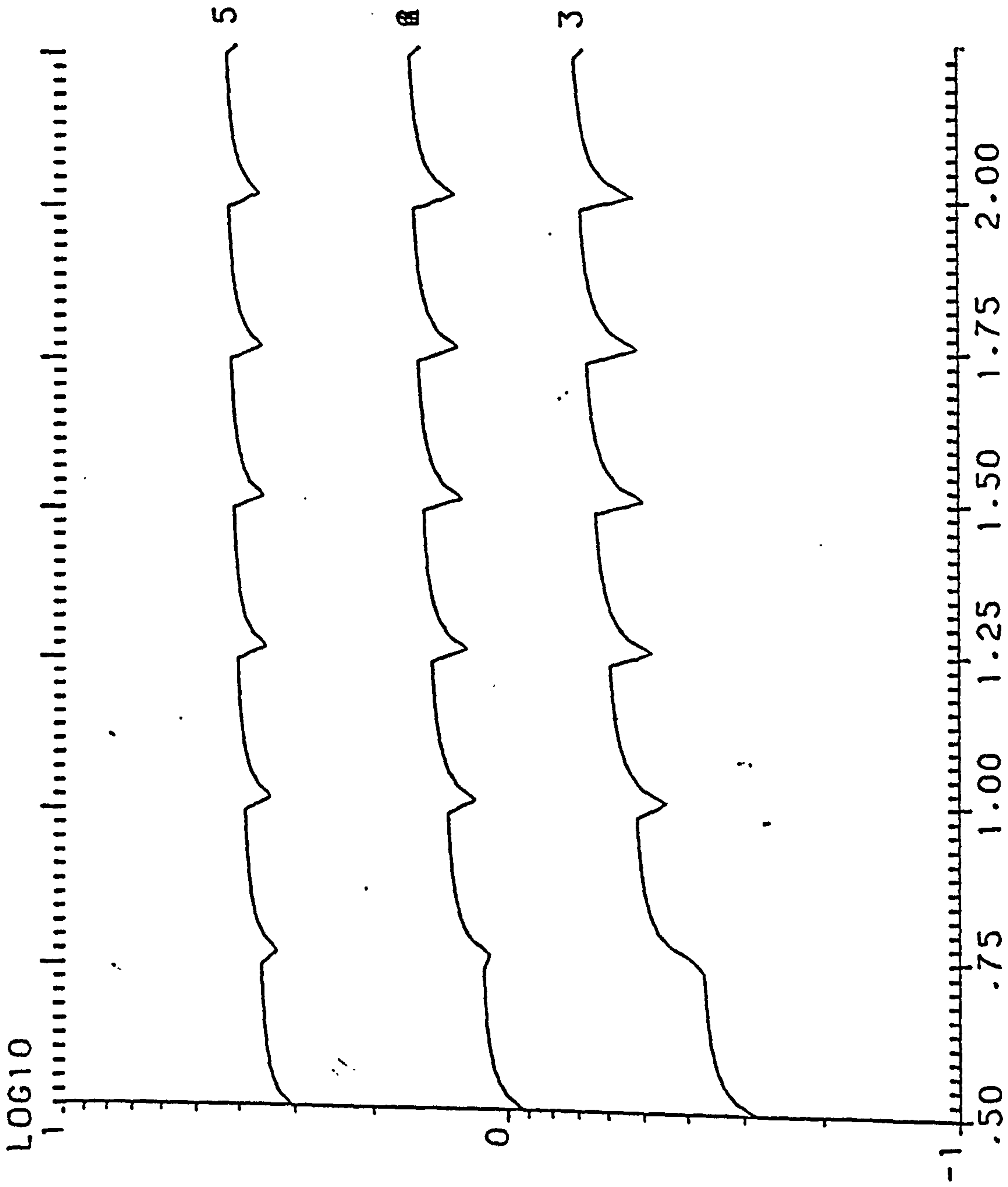

S. EFFICIENCY W. THICKNESS= .12M W. ORIENTATION=315.00

WD= 4M HD1= 22M HD2= 4M HOUSE T.=1.5 ST.



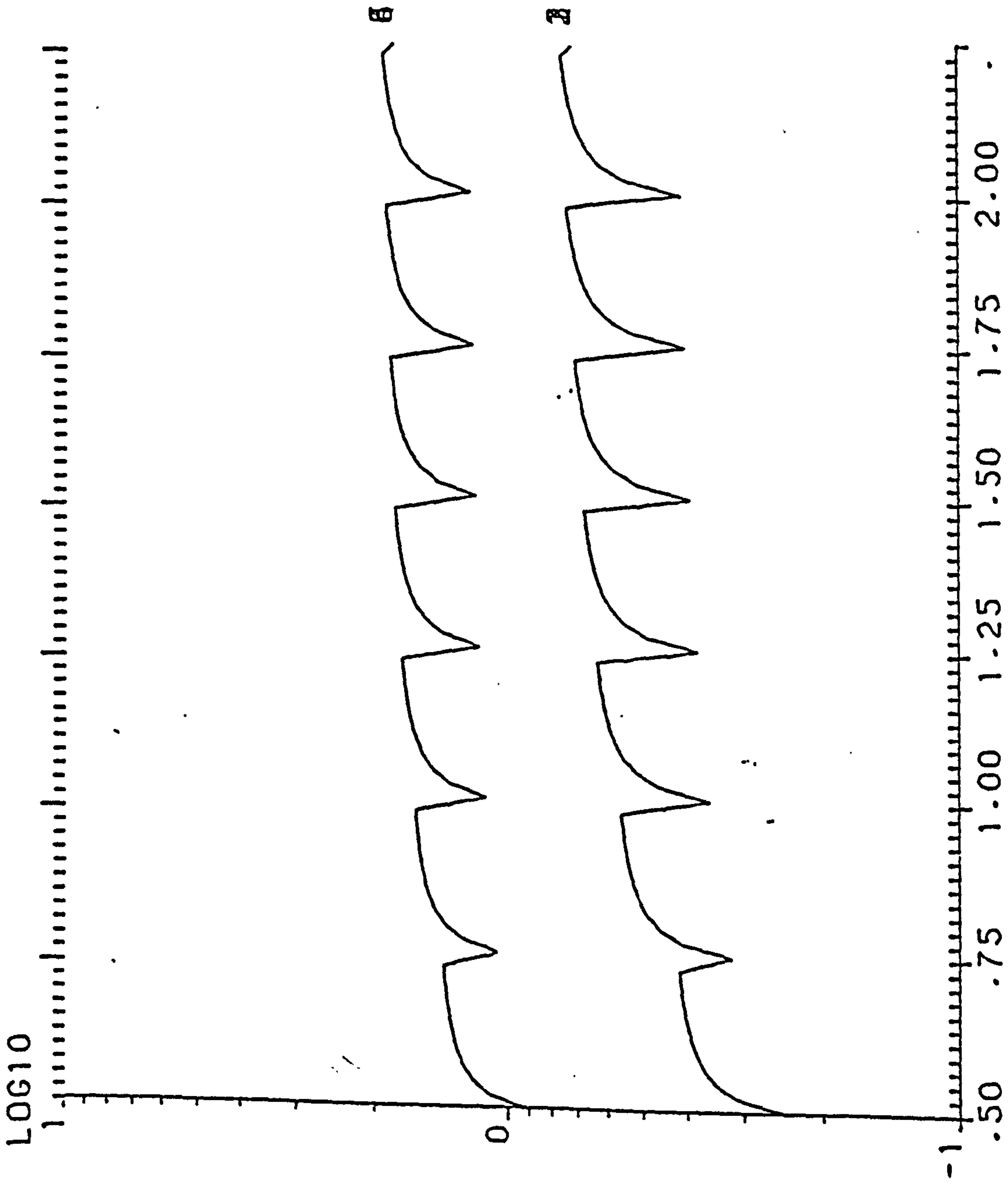

S. EFFICIENCY W. THICKNESS= .12M W. ORIENTATION=337.50  
 WD= 4M HD1= 22M HD2= 4M HOUSE T.=1.5 ST.



LOG10

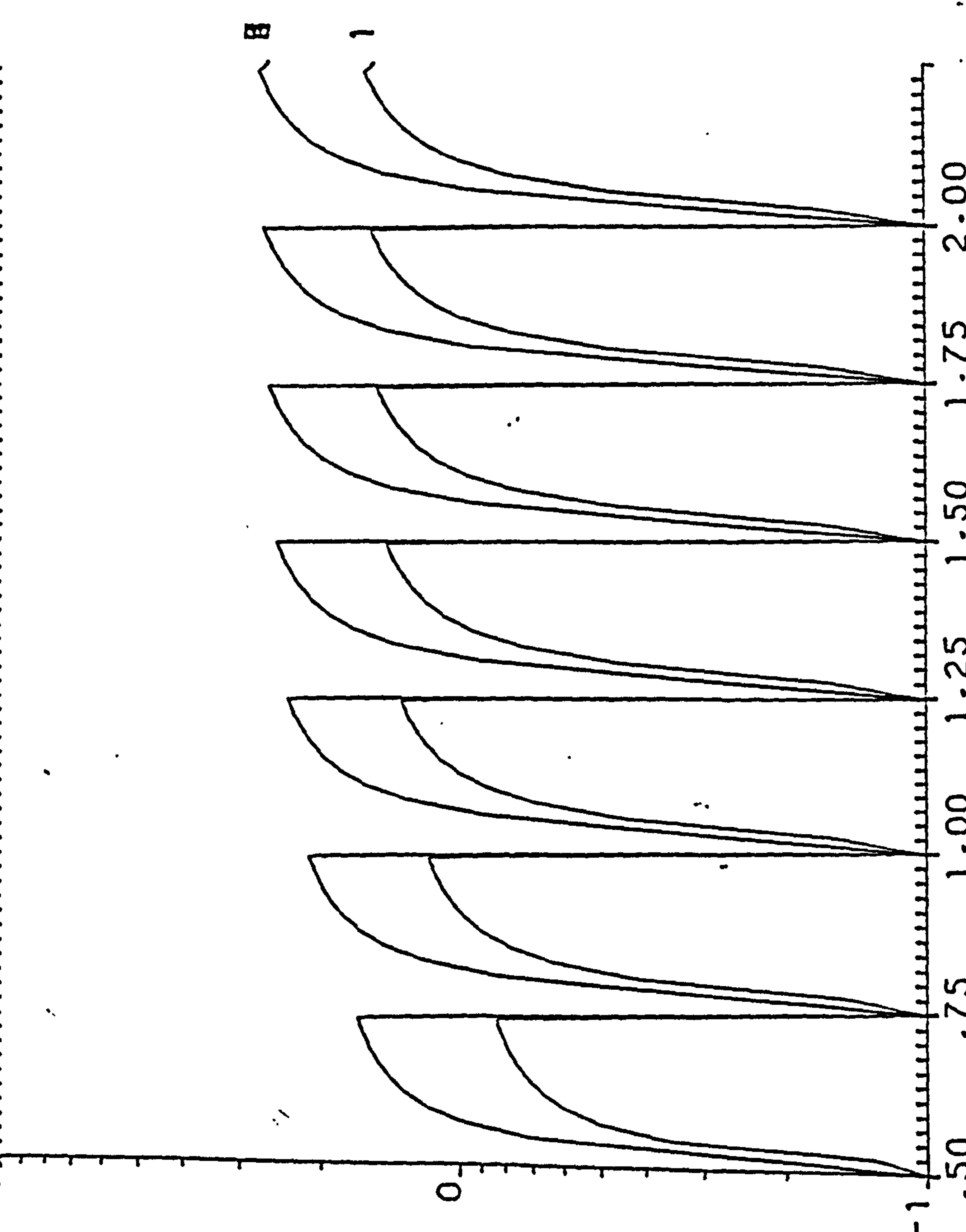

S. EFFICIENCY W. THICKNESS= .24M W. ORIENTATION= .00

WD= 4M HD1= 22M HD2= 4M HOUSE T.=1.5 ST.



LOG10

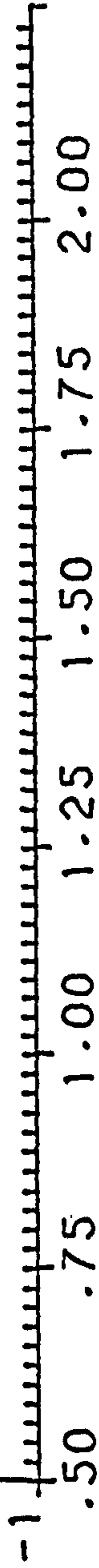
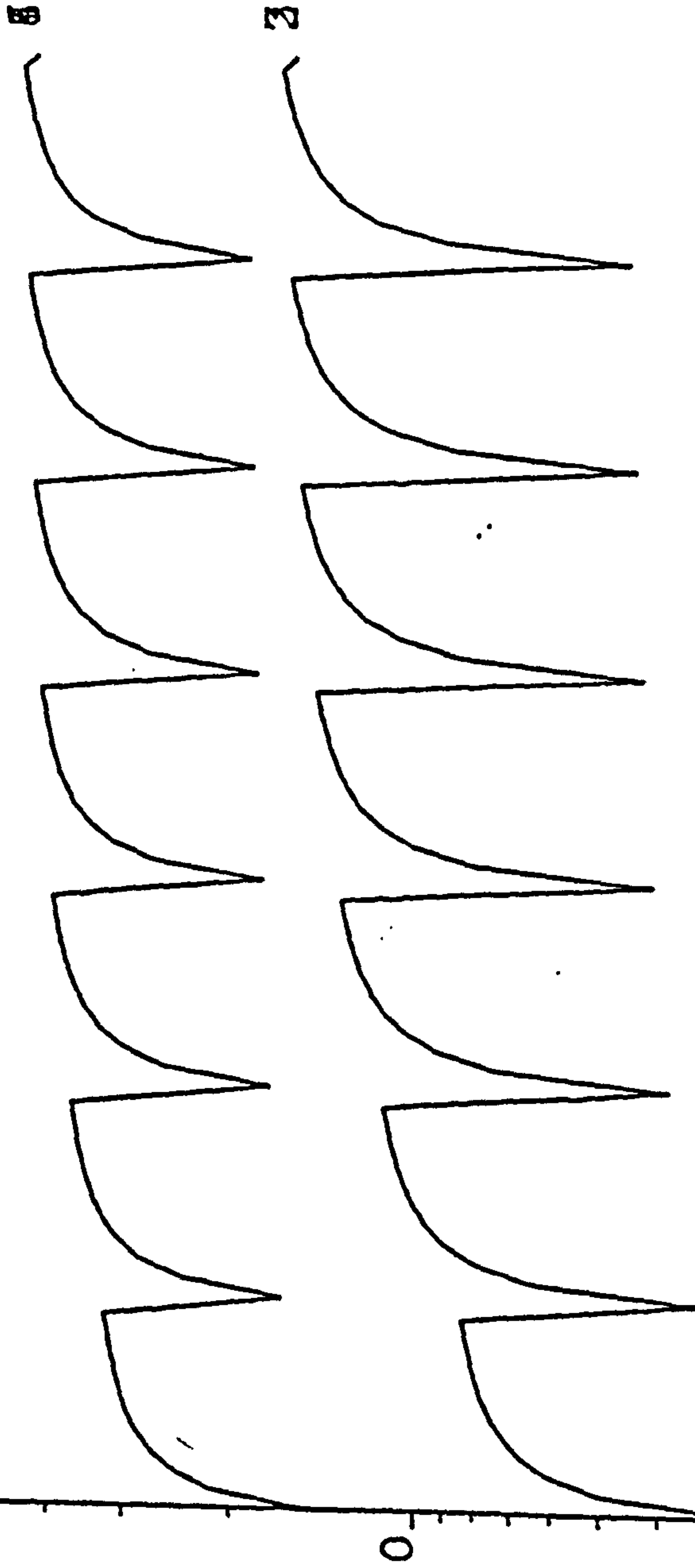

S. EFFICIENCY    W. THICKNESS= .24M    HD2= 4M    HOUSE T.=1.5 ST.

WD= 4M    HD1= 22M    W. ORIENTATION= 22.50



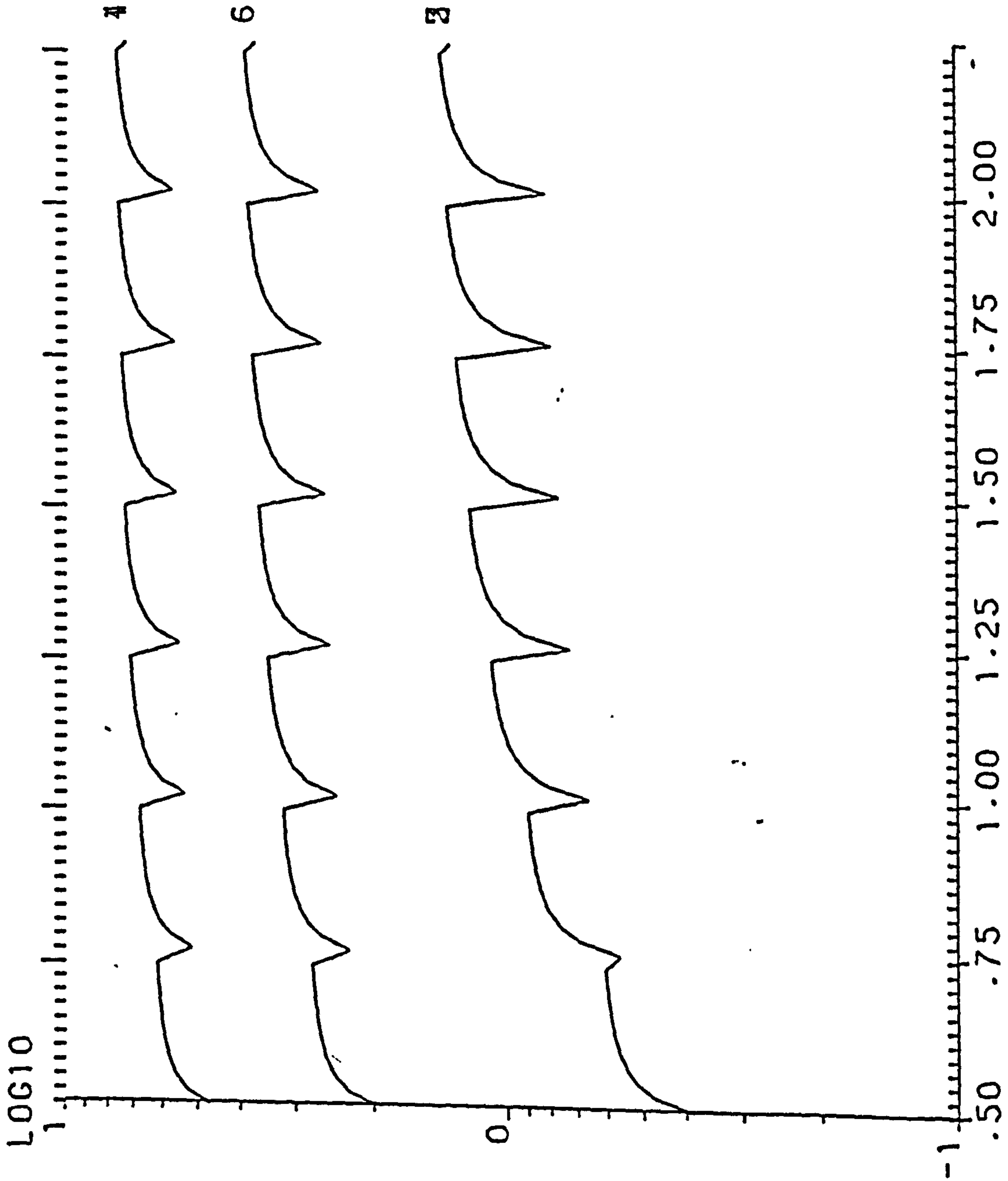

S. EFFICIENCY W. THICKNESS = .24M HD2 = 4M HOUSE T. = 1.5 ST. W. ORIENTATION = 45.00

WD = 4M HD1 = 22M

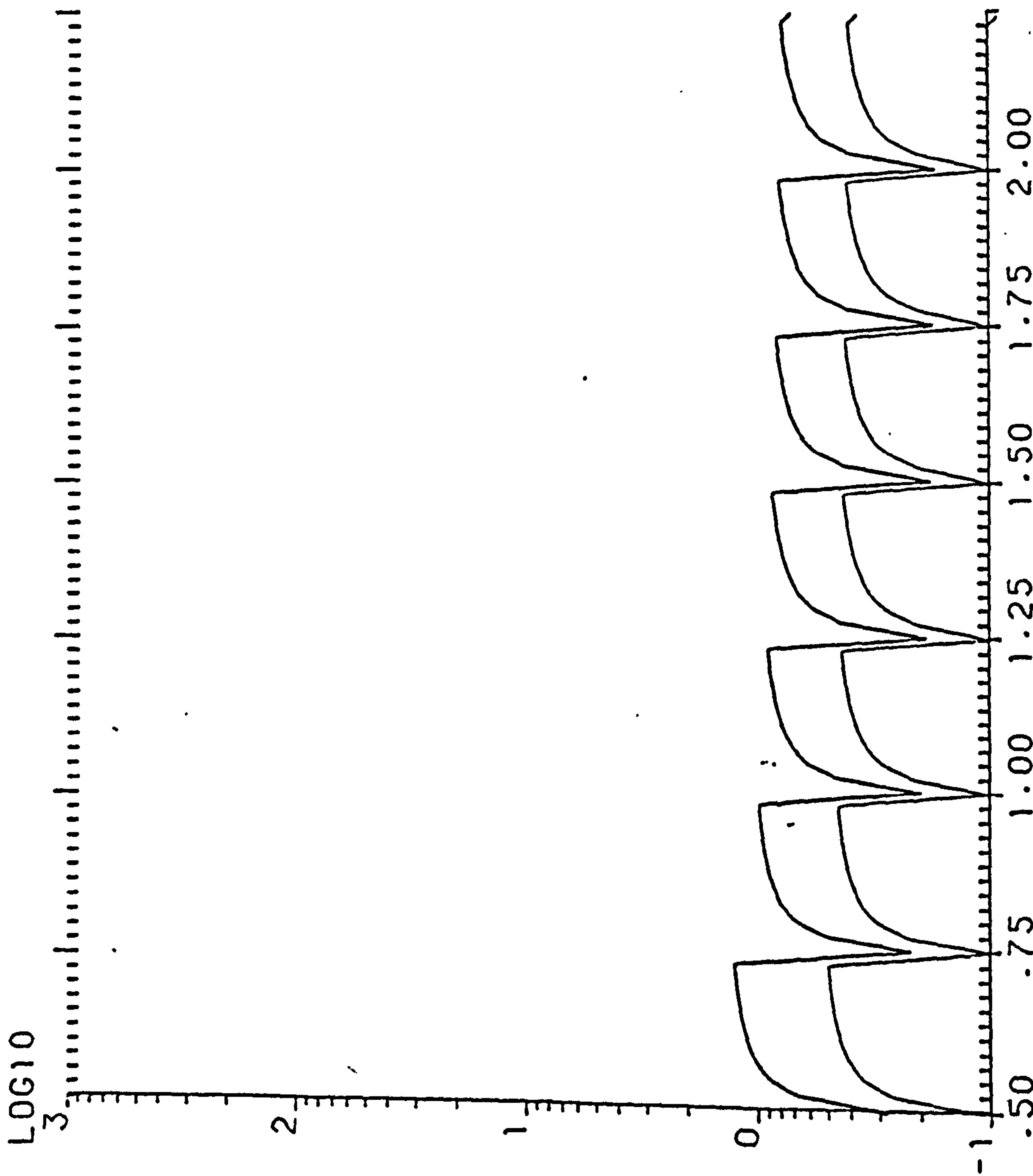

Y. EFFICIENCY W. THICKNESS= .24M W. ORIENTATION= 67.50

WD= 4M HD1= 22M HD2= 4M HOUSE T.=1.5 ST.

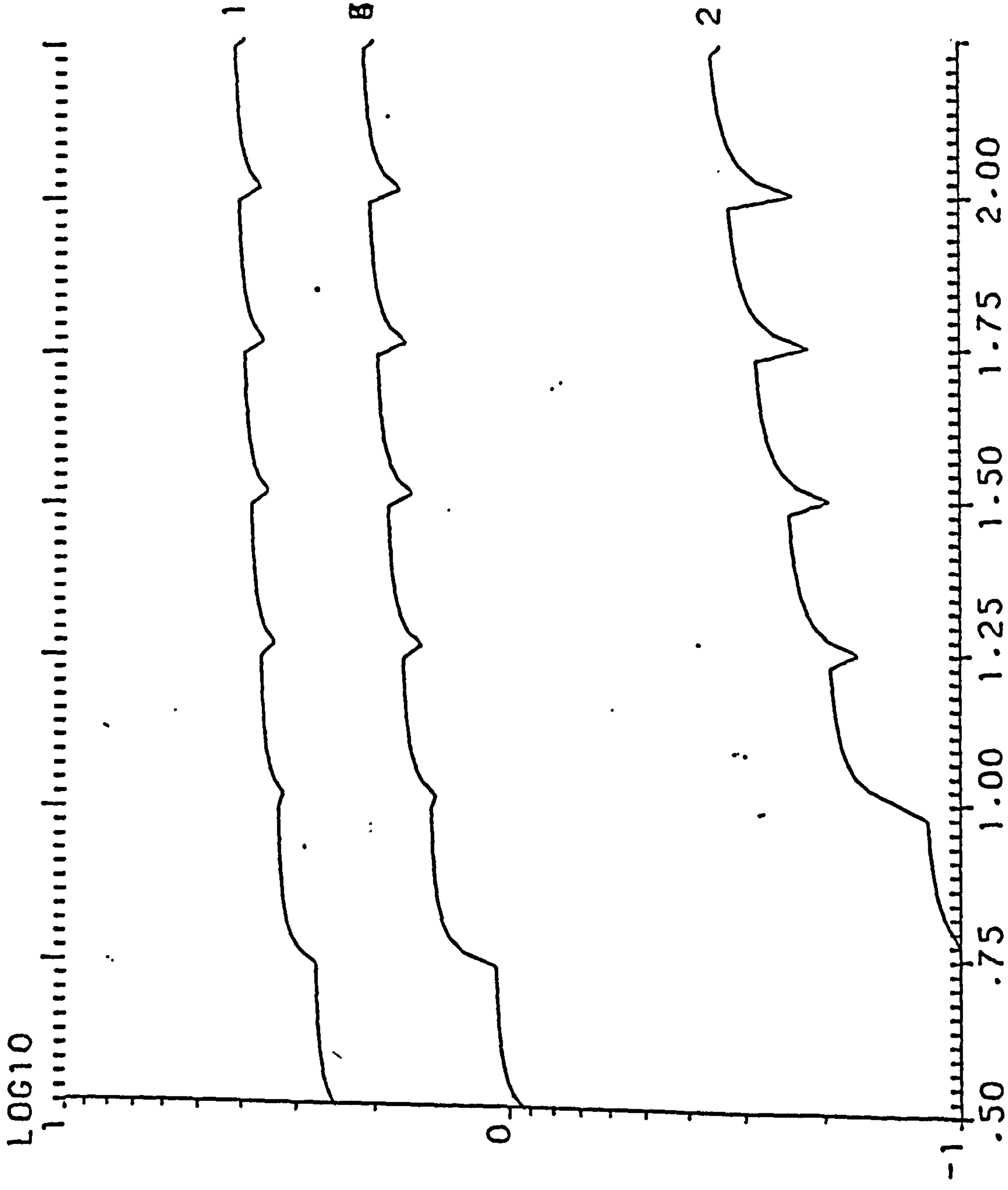

S. EFFICIENCY W. THICKNESS= .24M HD2= 4M HOUSE T.=1.5 ST.

WD= 4M HD1= 22M HD2= 4M HOUSE T.=1.5 ST.

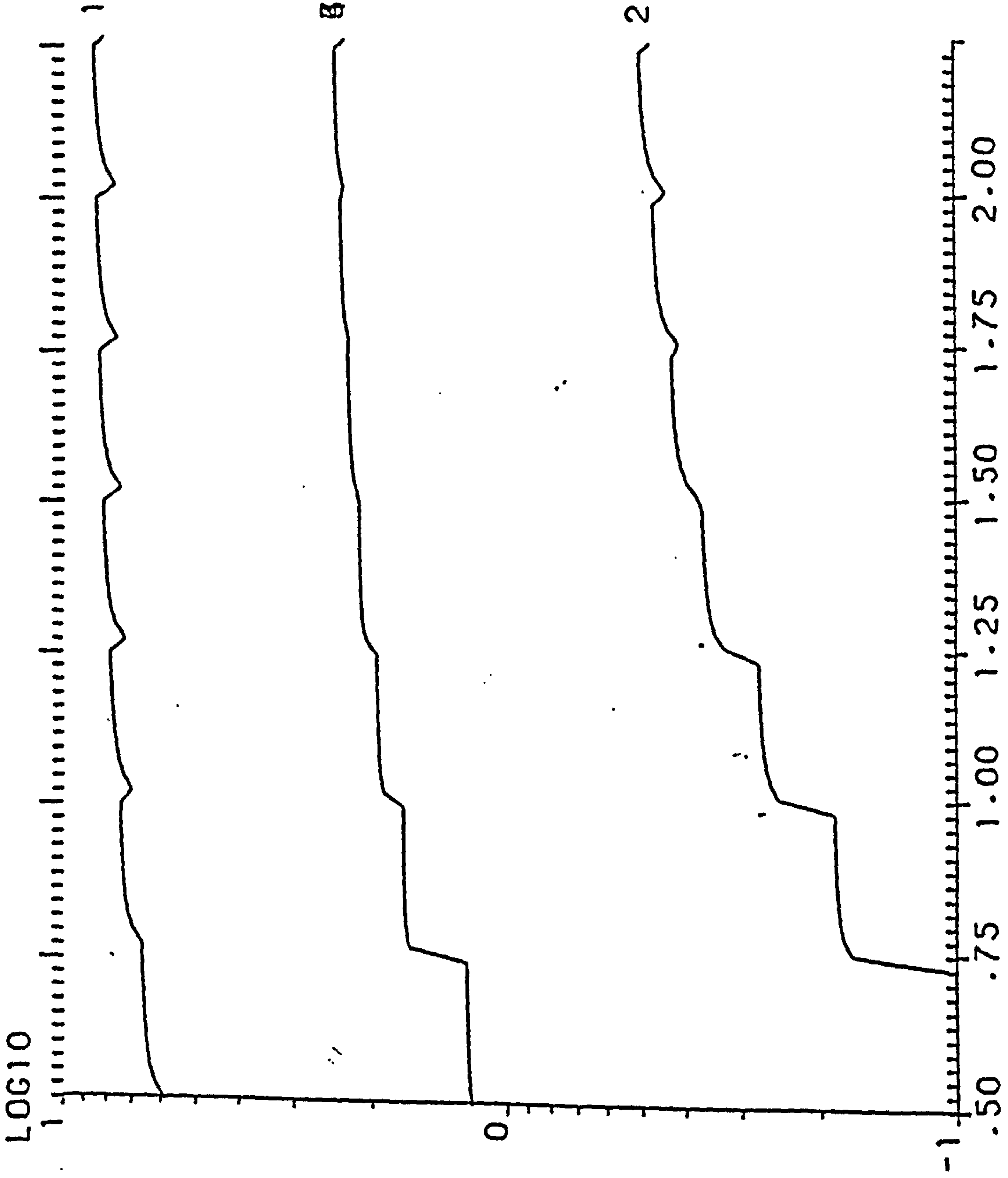

S. EFFICIENCY W. THICKNESS= .24M HD2= 4M HOUSE T.=1.5 ST.  
 WD= 4M HD1= 22M



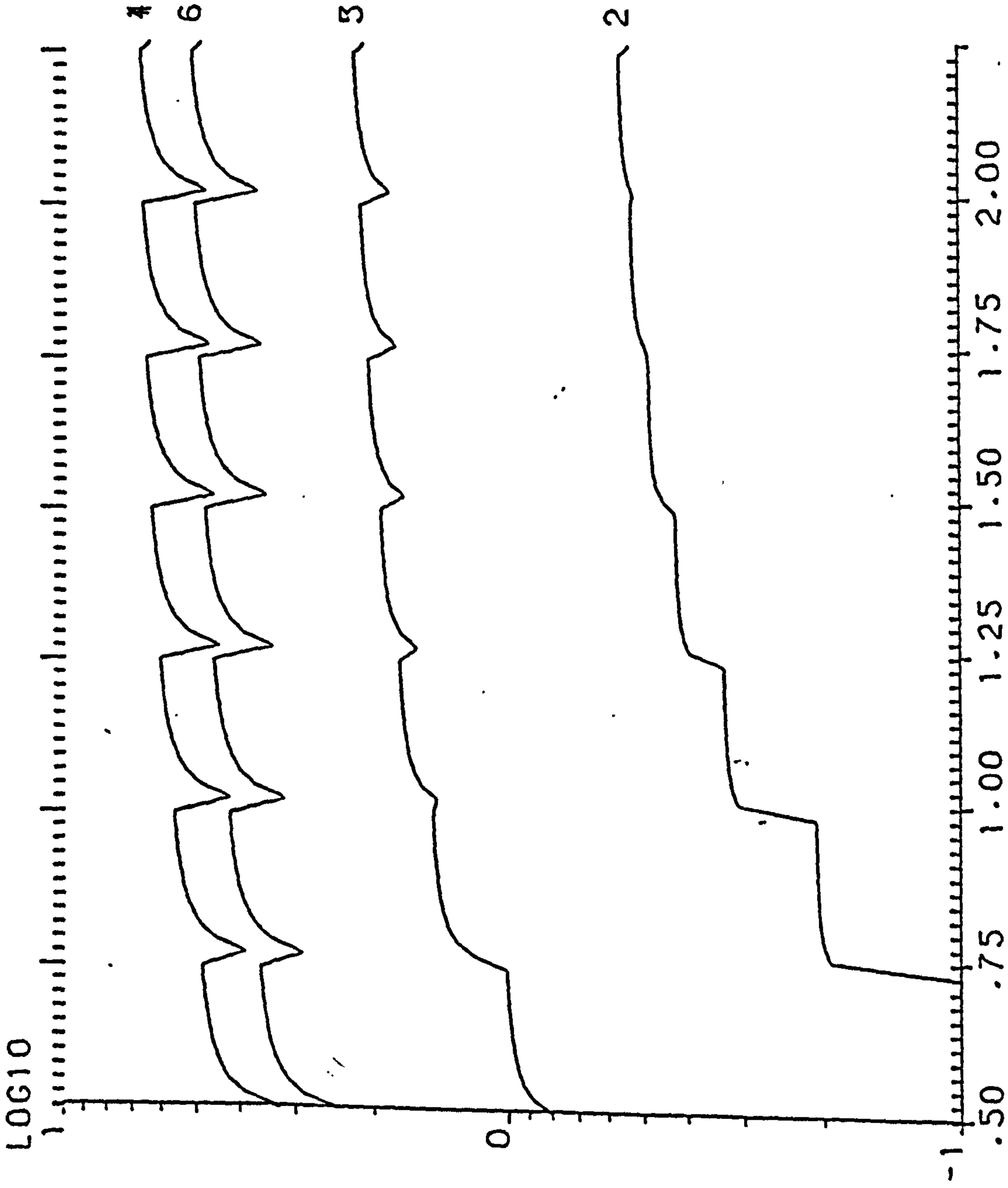

S. EFFICIENCY W. THICKNESS= .24M HD2= 4M HOUSE T.= 1.5 ST.  
 WD= 4M HD1= 22M



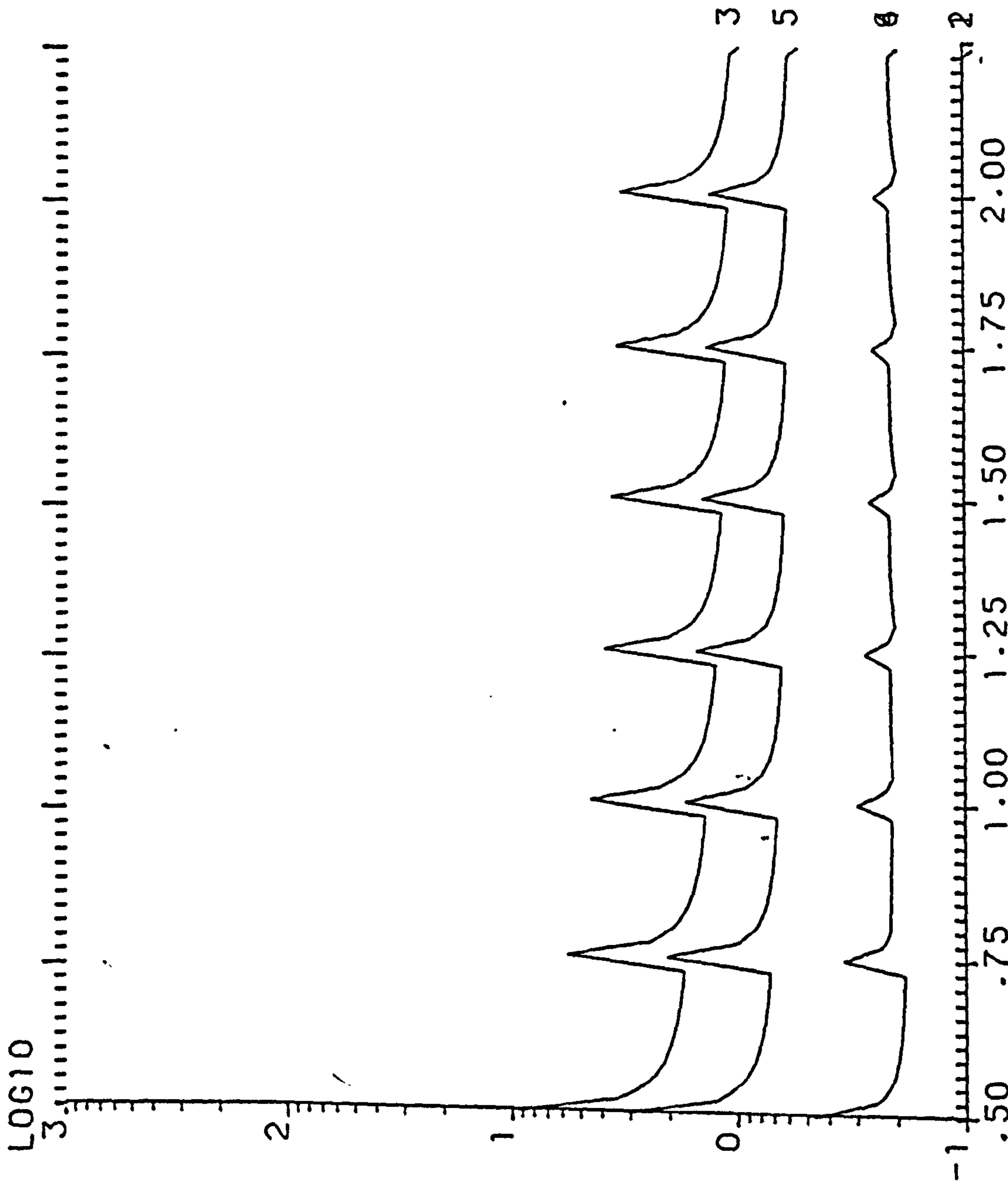

Y. EFFICIENCY W. THICKNESS= .24M W. ORIENTATION=135.00  
WD= 4M HD1= 22M HD2= 4M HOUSE T.=1.5 ST.

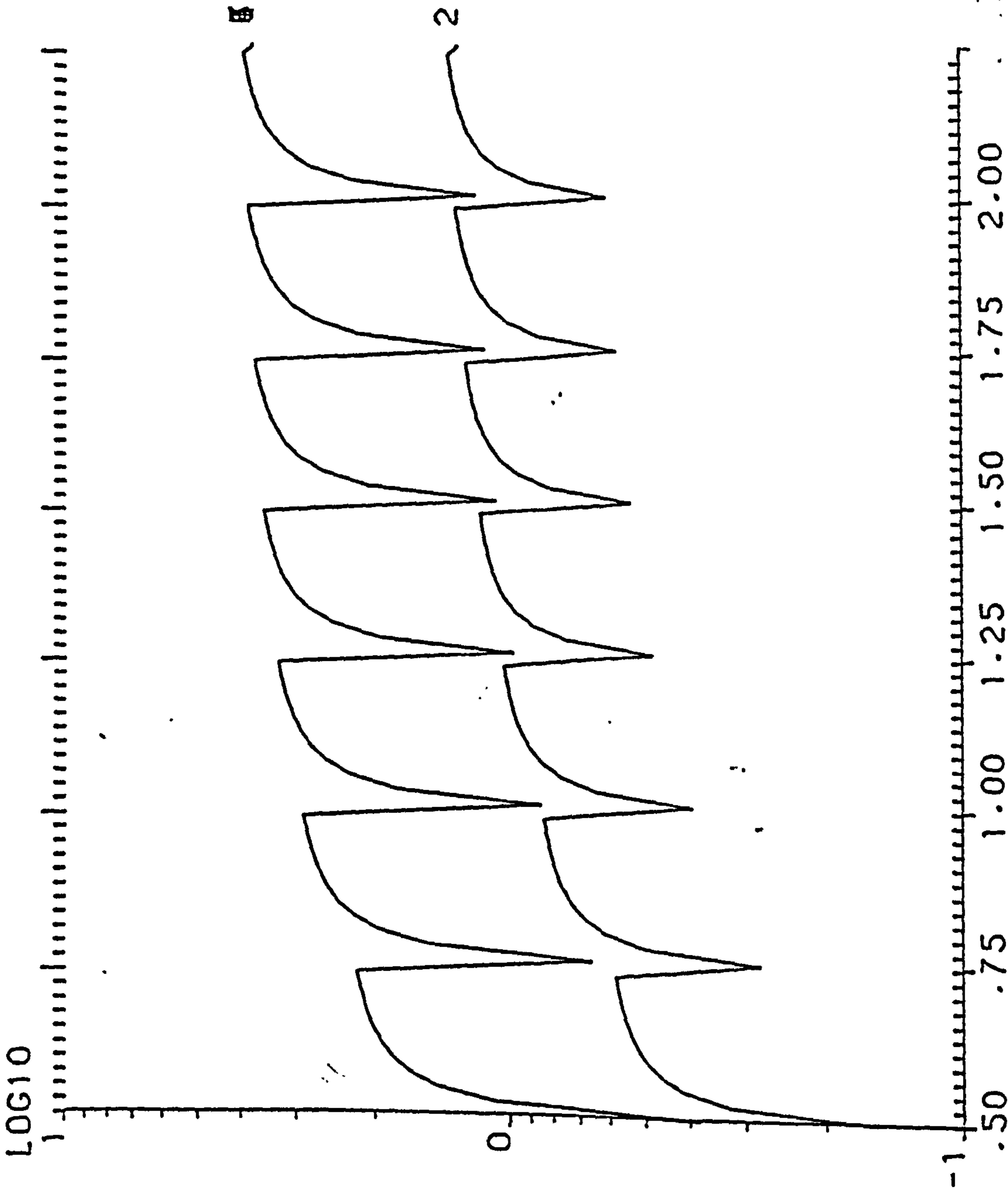

S. EFFICIENCY W. THICKNESS= .24M W. ORIENTATION=135.00

WD= 4M HD1= 22M HD2= 4M HOUSE T.=1.5 ST.

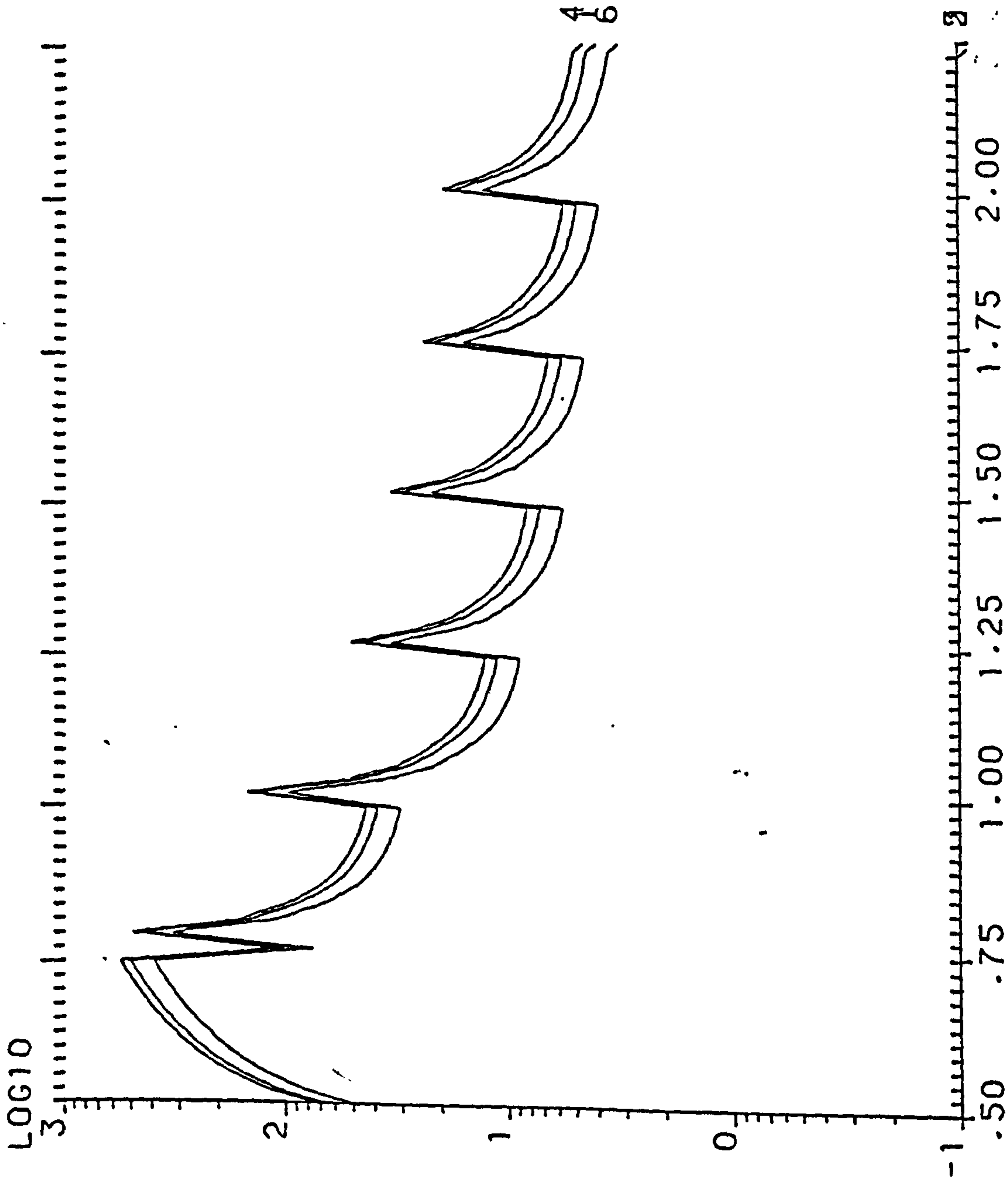

46

Y. EFFICIENCY    W. THICKNESS=    .24M    W. ORIENTATION=157.50

WD= 4M    HD1= 22M    HD2= 4M    HOUSE T.=1.5 ST.

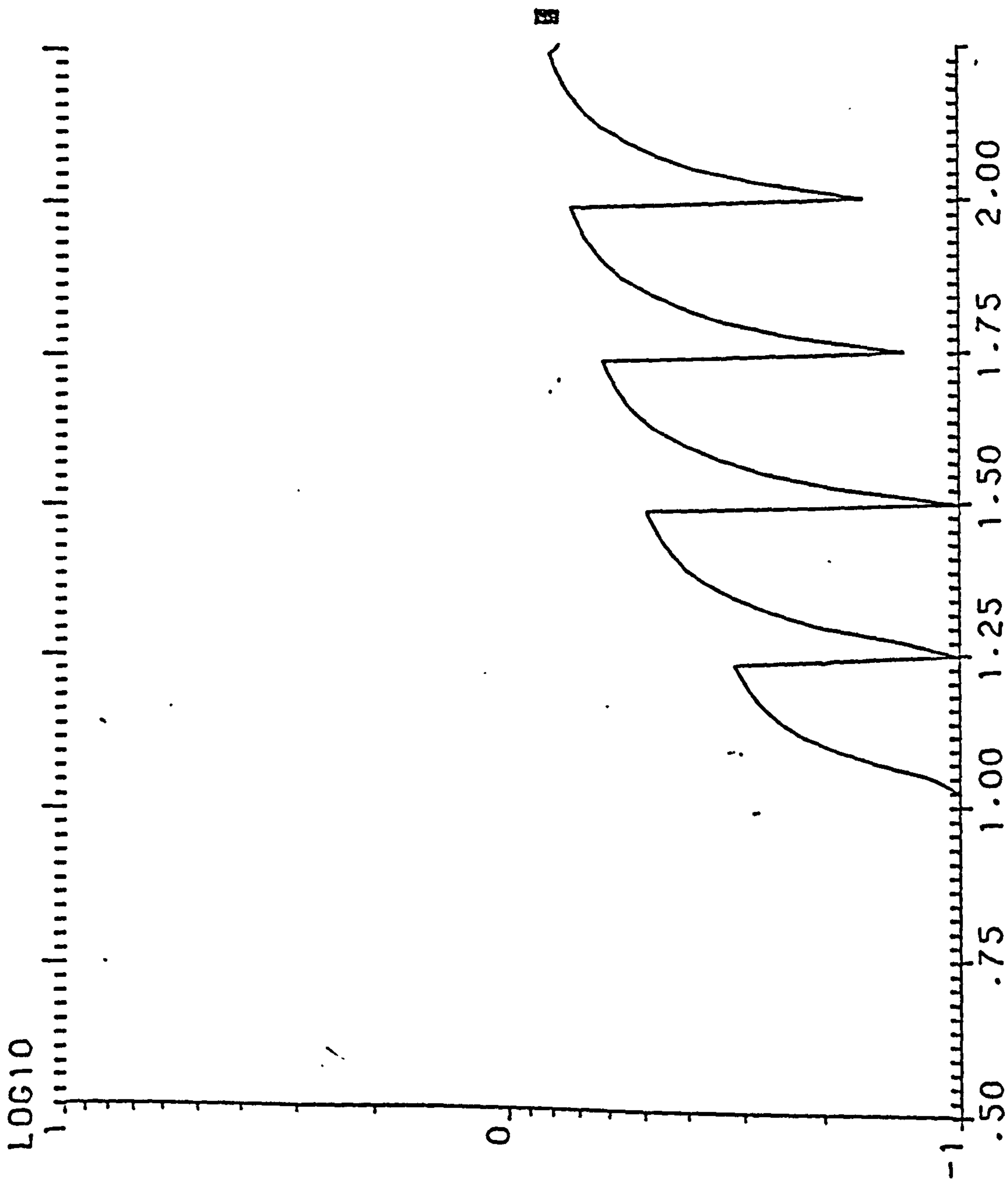

S. EFFICIENCY W. THICKNESS= .24M W. ORIENTATION=157.50

WD= 4M HD1= 22M HD2= 4M HOUSE T.=1.5 ST.



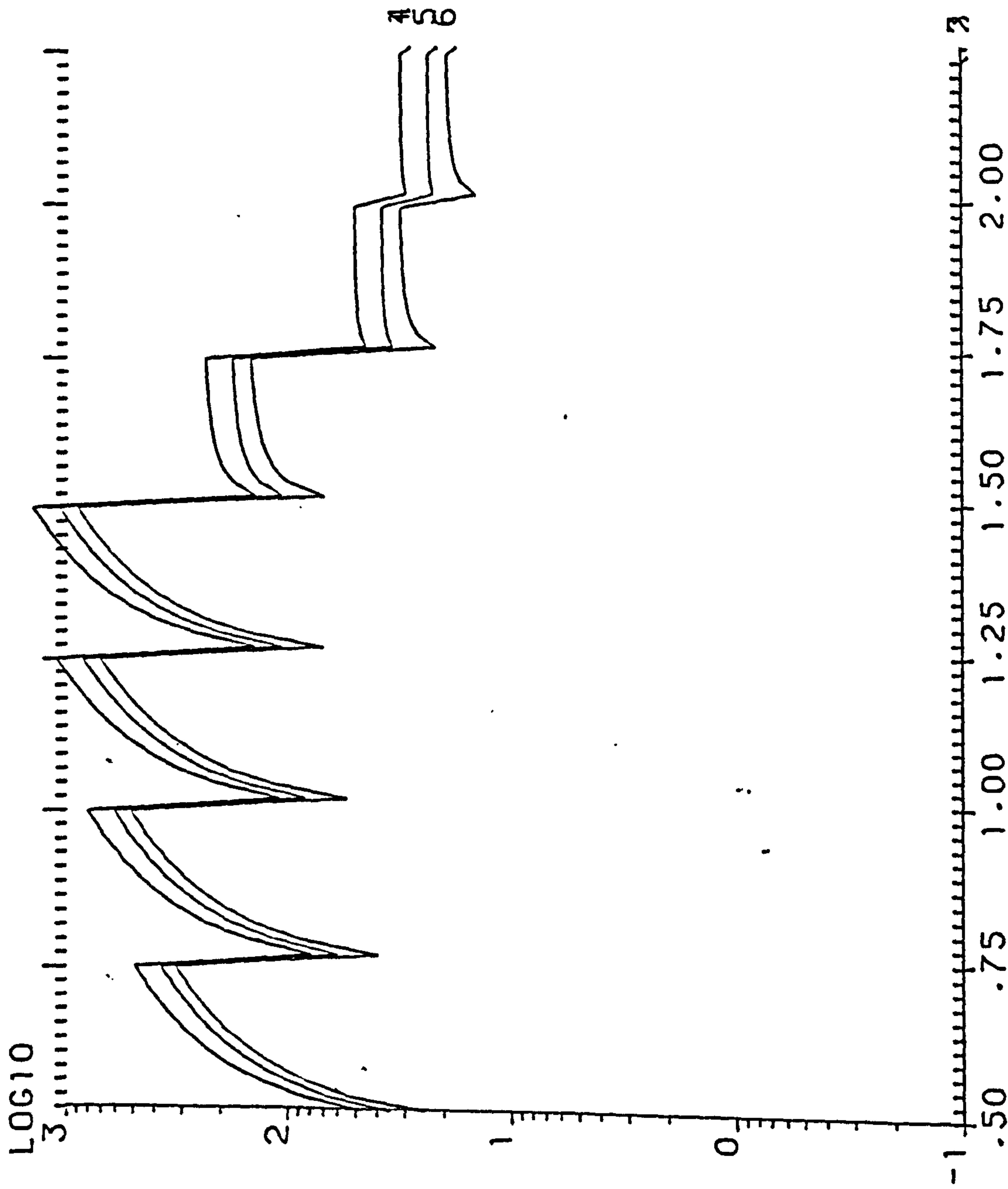

Y. EFFICIENCY W. THICKNESS= .24M W. ORIENTATION=180.00

WD= 4M HD1= 22M HD2= 4M HOUSE T.=1.5 ST.



LOG10  
1  
0  
-1

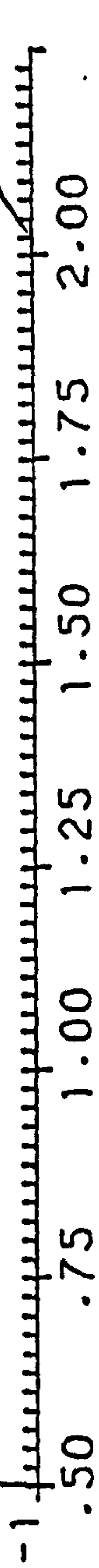

S. EFFICIENCY W. THICKNESS = .24M HD2 = 4M HOUSE T. = 1.5 ST. W. ORIENTATION = 180.00

WD = 4M HD1 = 22M

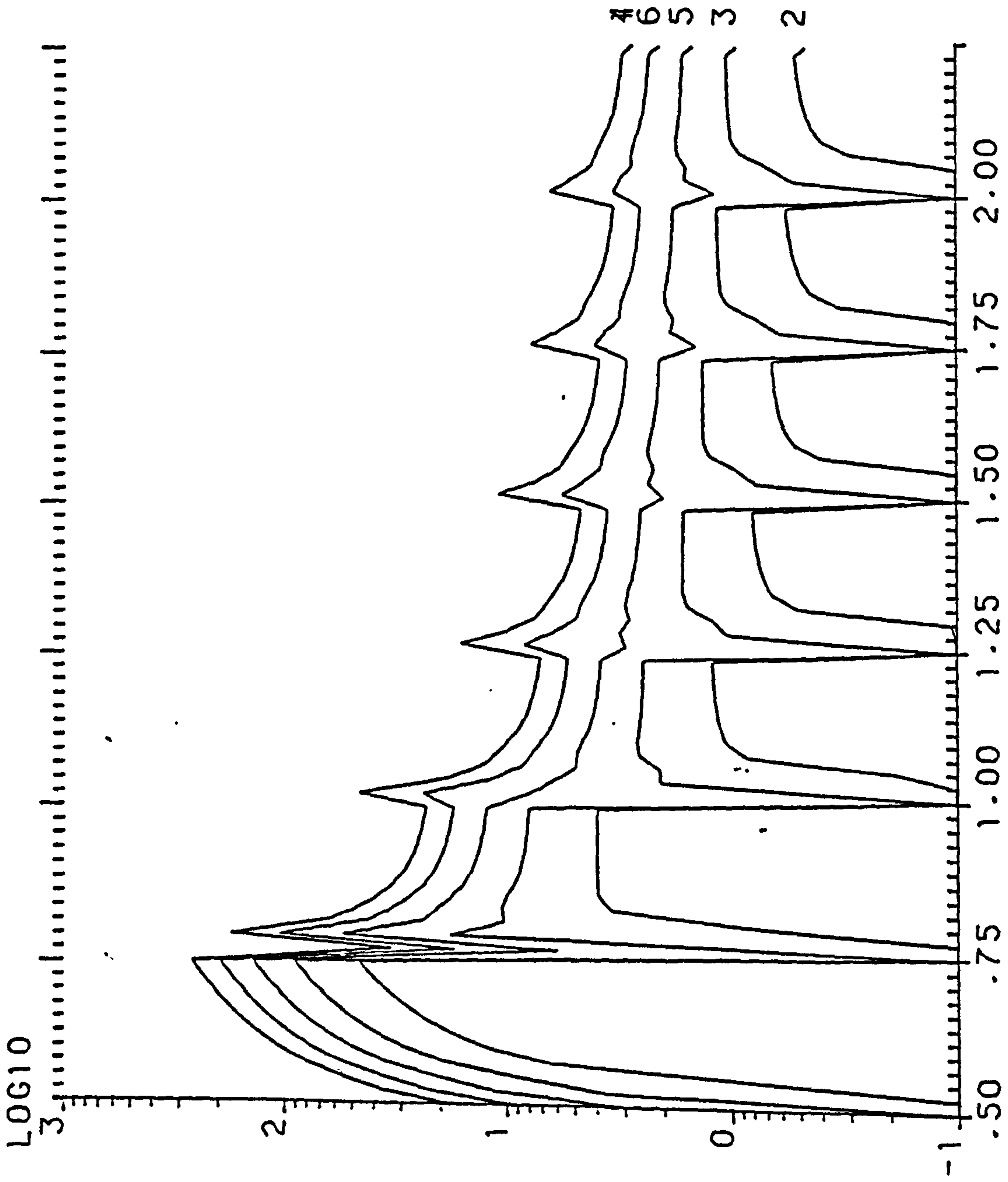

Y. EFFICIENCY W. THICKNESS= .24M W. ORIENTATION=202.50

WD= 4M HD1= 22M HD2= 4M HOUSE T.=1.5 ST.

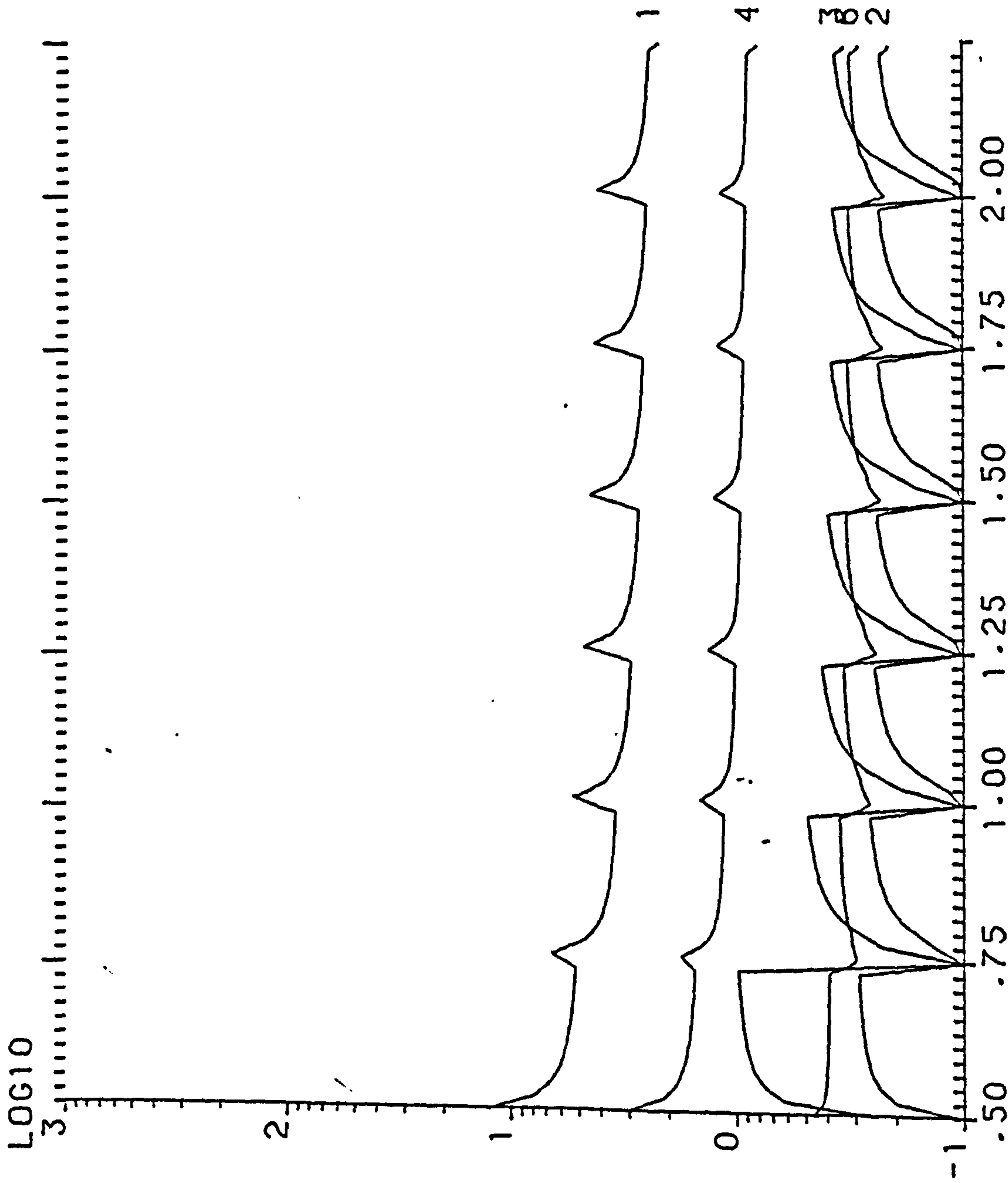

Y. EFFICIENCY W. THICKNESS= .24M W. ORIENTATION=225.00

WD= 4M HD1= 22M HD2= 4M HOUSE T.=1.5 ST.

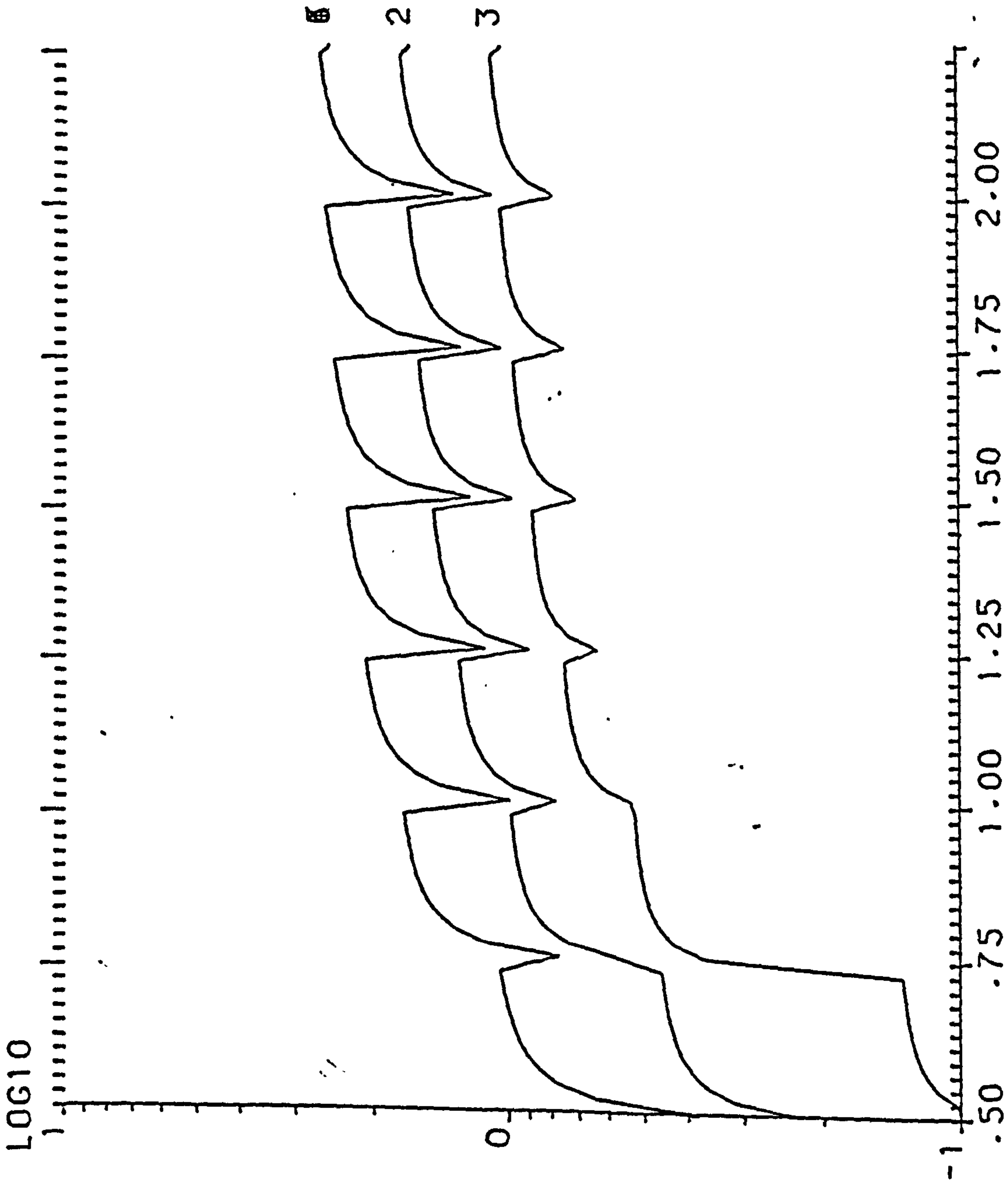

S. EFFICIENCY W. THICKNESS= .24M HD2= 4M HOUSE T.=1.5 ST.  
 W. ORIENTATION=225.00

WD= 4M HD1= 22M HD2= 4M HOUSE T.=1.5 ST.



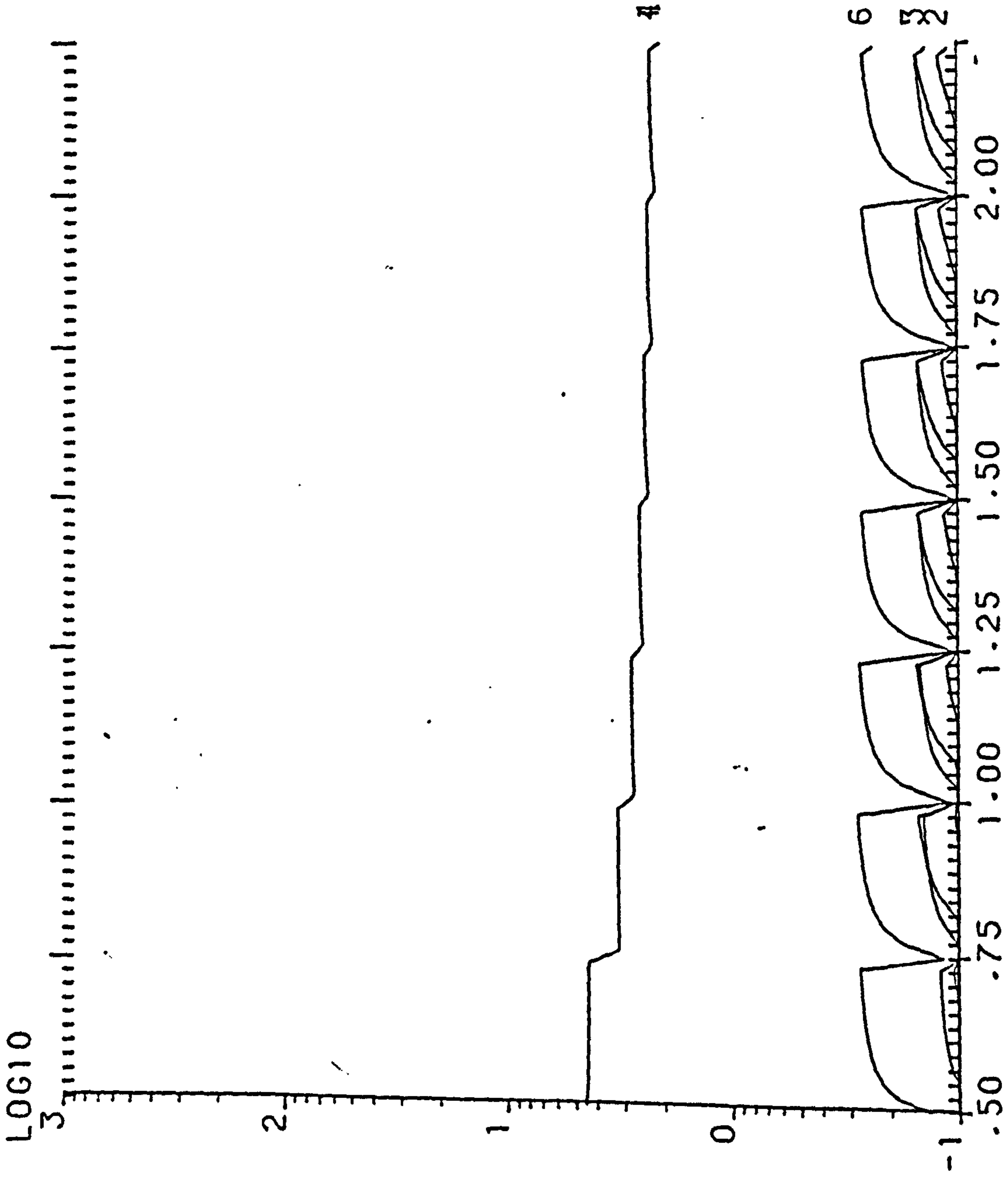

Y. EFFICIENCY W. THICKNESS= .24M W. ORIENTATION=247.50  
 WD= 4M HD1= 22M HD2= 4M HOUSE T.=1.5 ST.



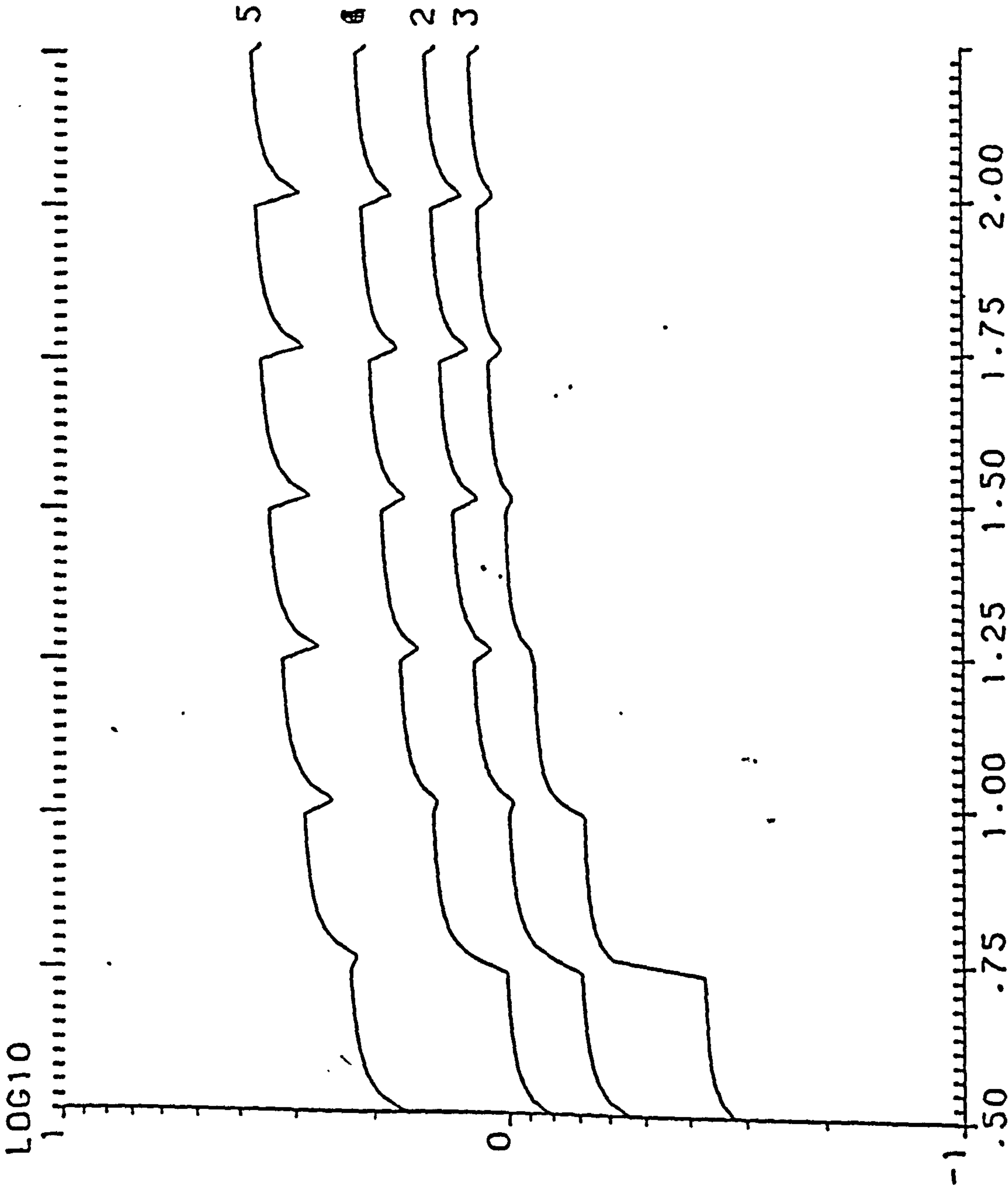

S. EFFICIENCY W. THICKNESS= .24M HD2= 4M HOUSE T.=1.5 ST.  
 W. ORIENTATION=247.50

WD= 4M HD1= 22M

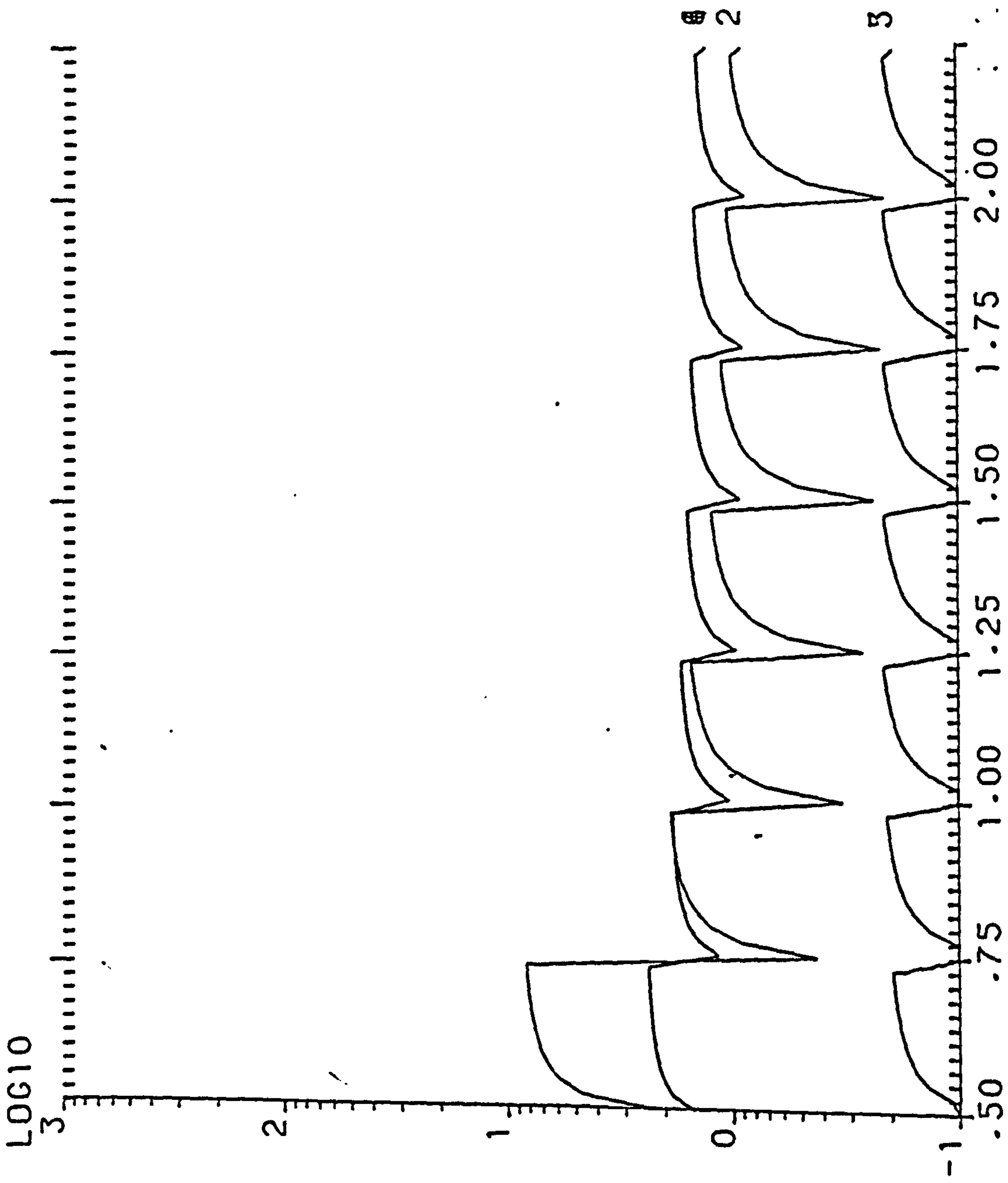

Y. EFFICIENCY W. THICKNESS= .24M W. ORIENTATION=270.00

WD= 4M HD1= 22M HD2= 4M HOUSE T.=1.5 ST.

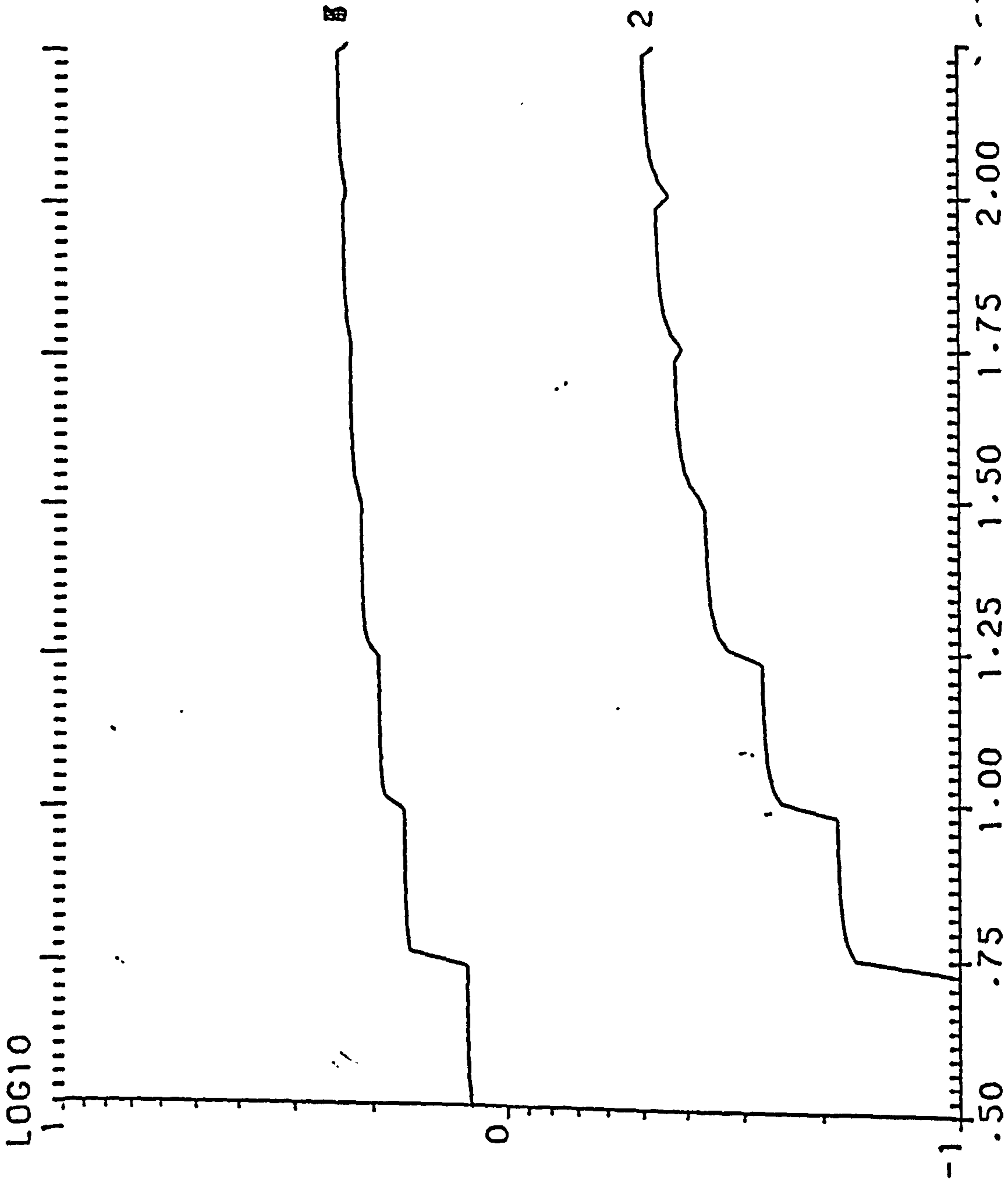

S. EFFICIENCY W. THICKNESS= .24M W. ORIENTATION=270.00

WD= 4M HD1= 22M HD2= 4M HOUSE T.=1.5 ST.



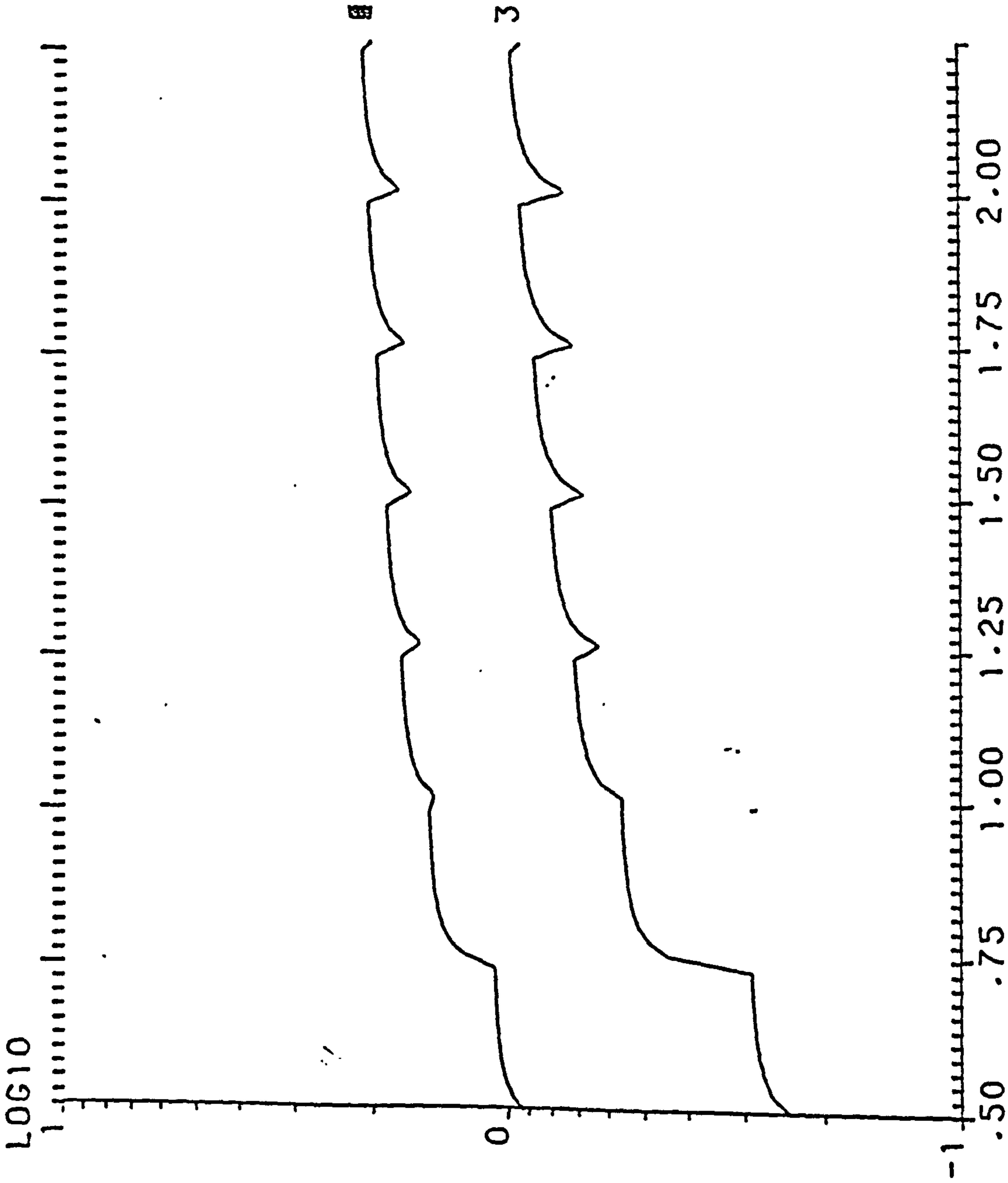

S. EFFICIENCY W. THICKNESS= .24M HD2= 4M HOUSE I.=1.5 ST.  
 W. ORIENTATION=292.50

WD= 4M HD1= 22M HD2= 4M HOUSE I.=1.5 ST.



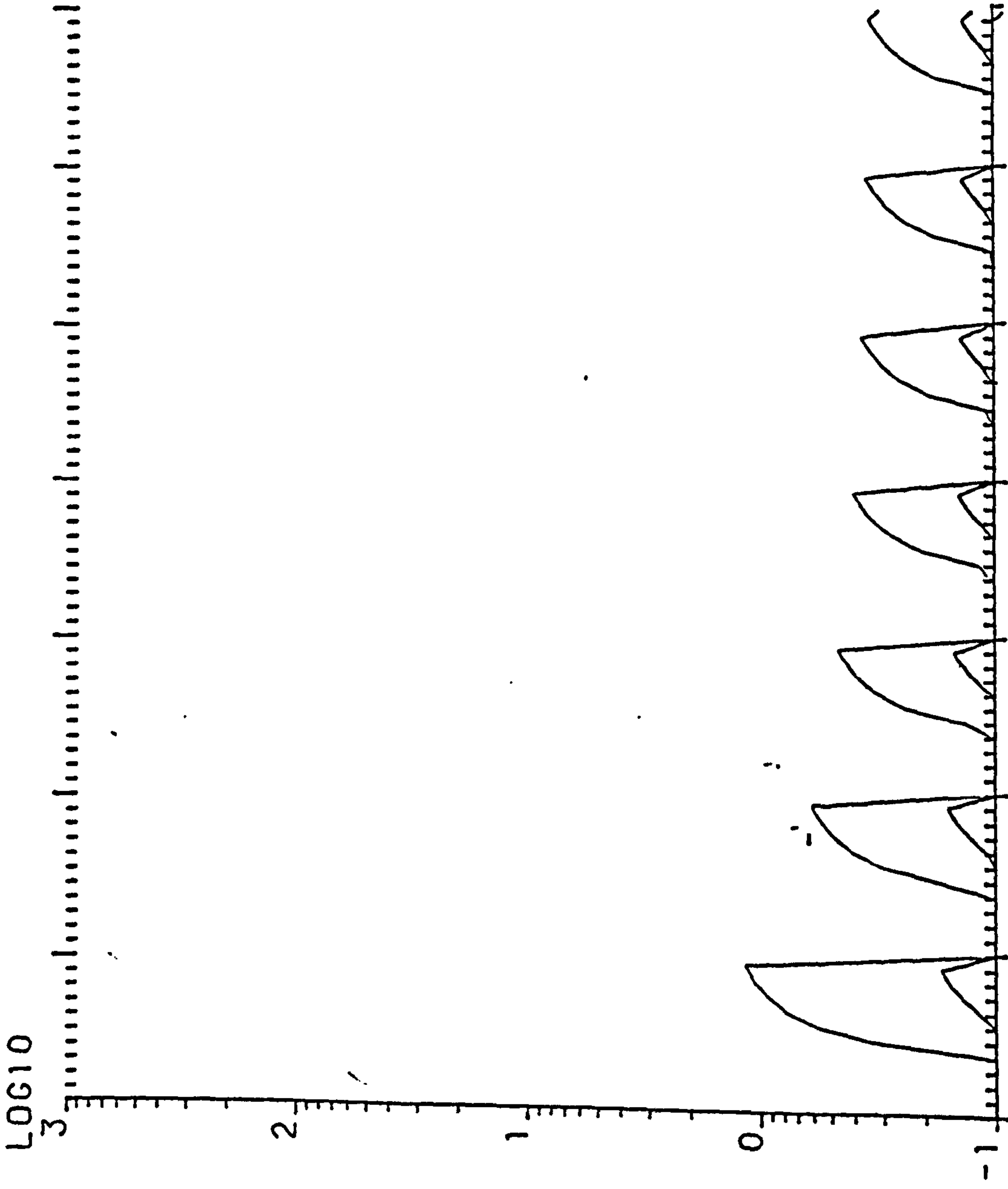

Y. EFFICIENCY W. THICKNESS= .24M W. ORIENTATION=315.00

WD= 4M HD1= 22M HD2= 4M HOUSE T.=1.5 ST.



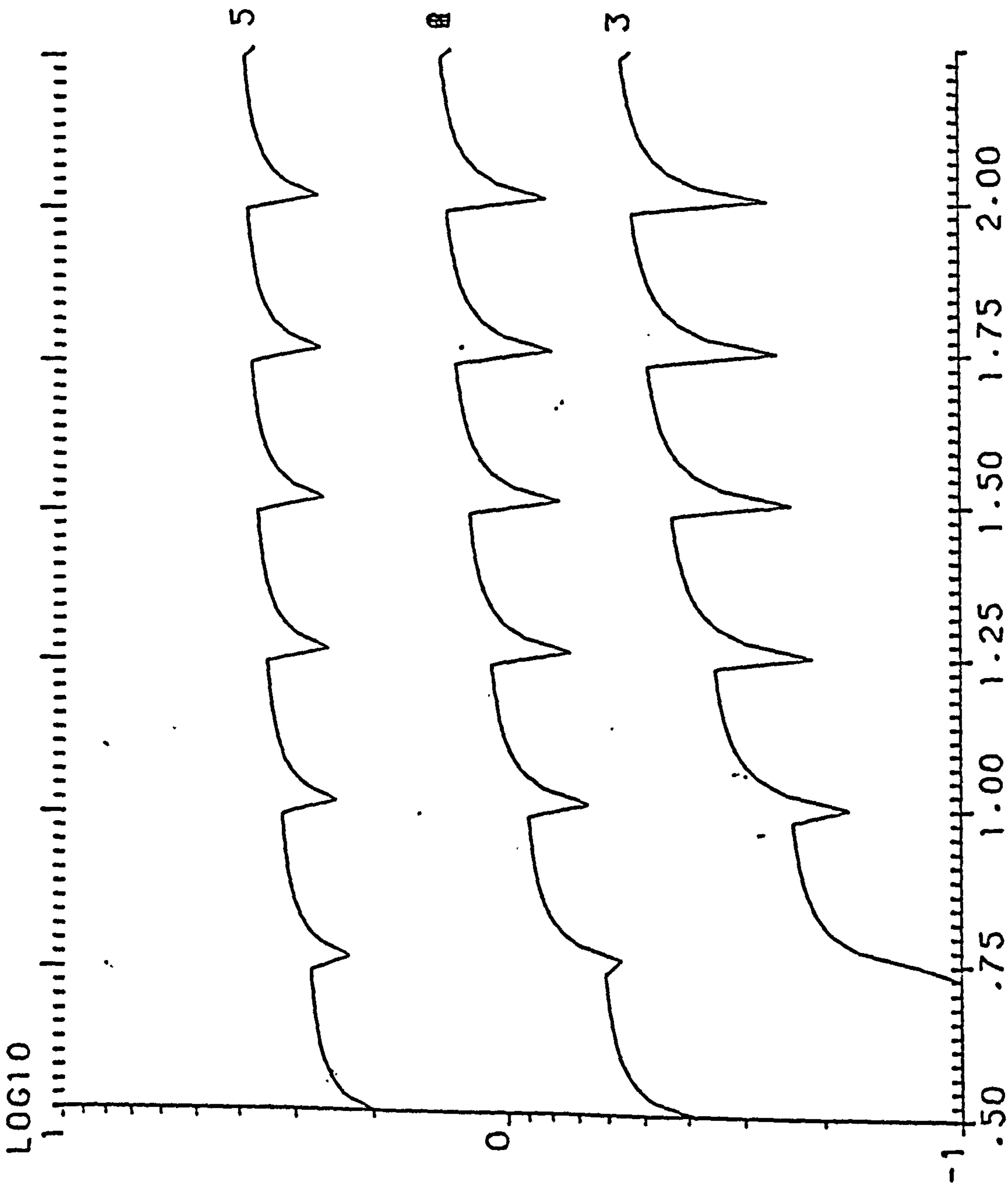

S. EFFICIENCY W. THICKNESS= .24M HD2= 4M HOUSE T.=1.5 ST. W. ORIENTATION=315.00

WD= 4M HD1= 22M



LOG10

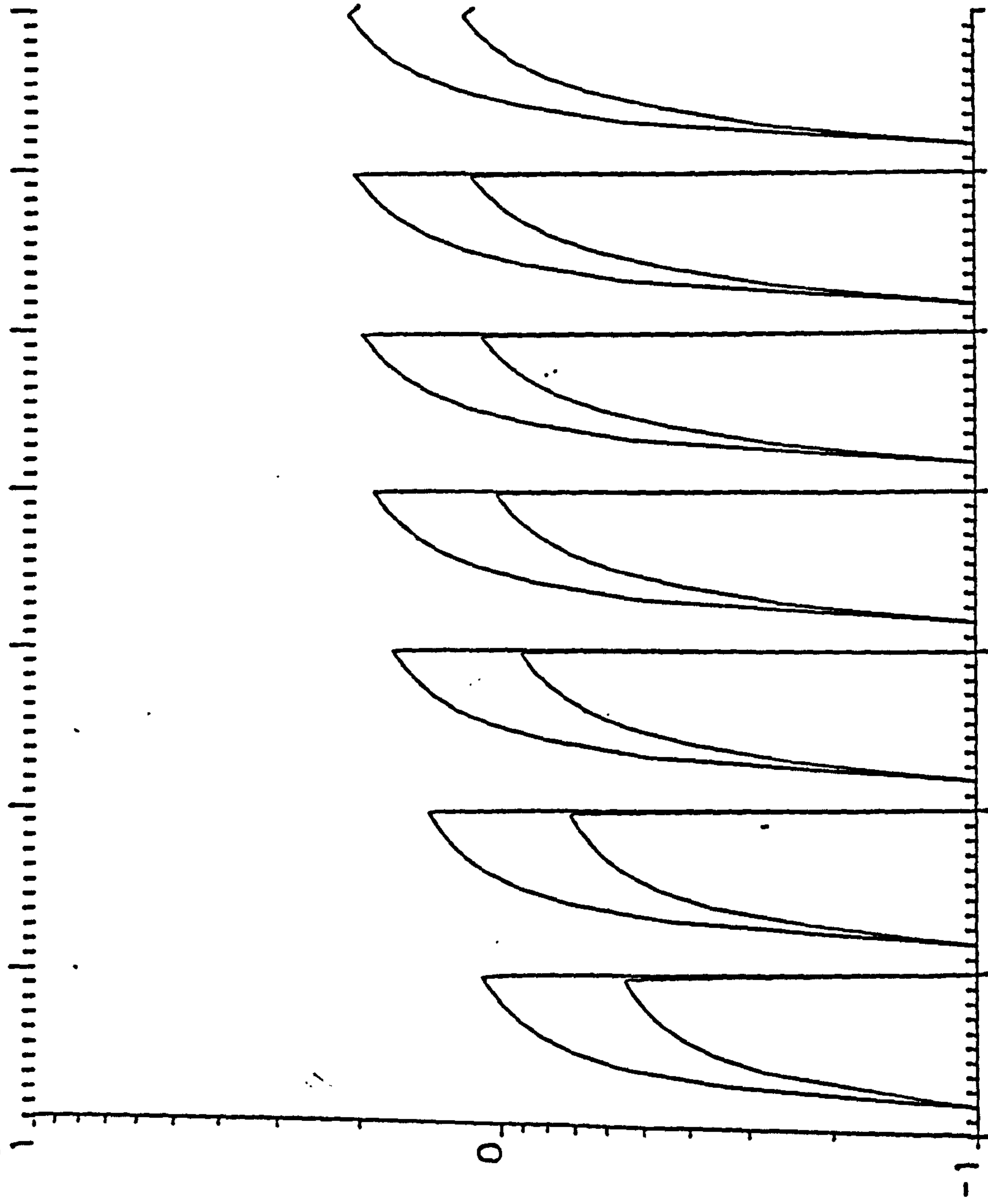

S. EFFICIENCY W. THICKNESS= .36M W. ORIENTATION= .00

WD= 4M HD1= 22M HD2= 4M HOUSE T.= 1.5 ST.

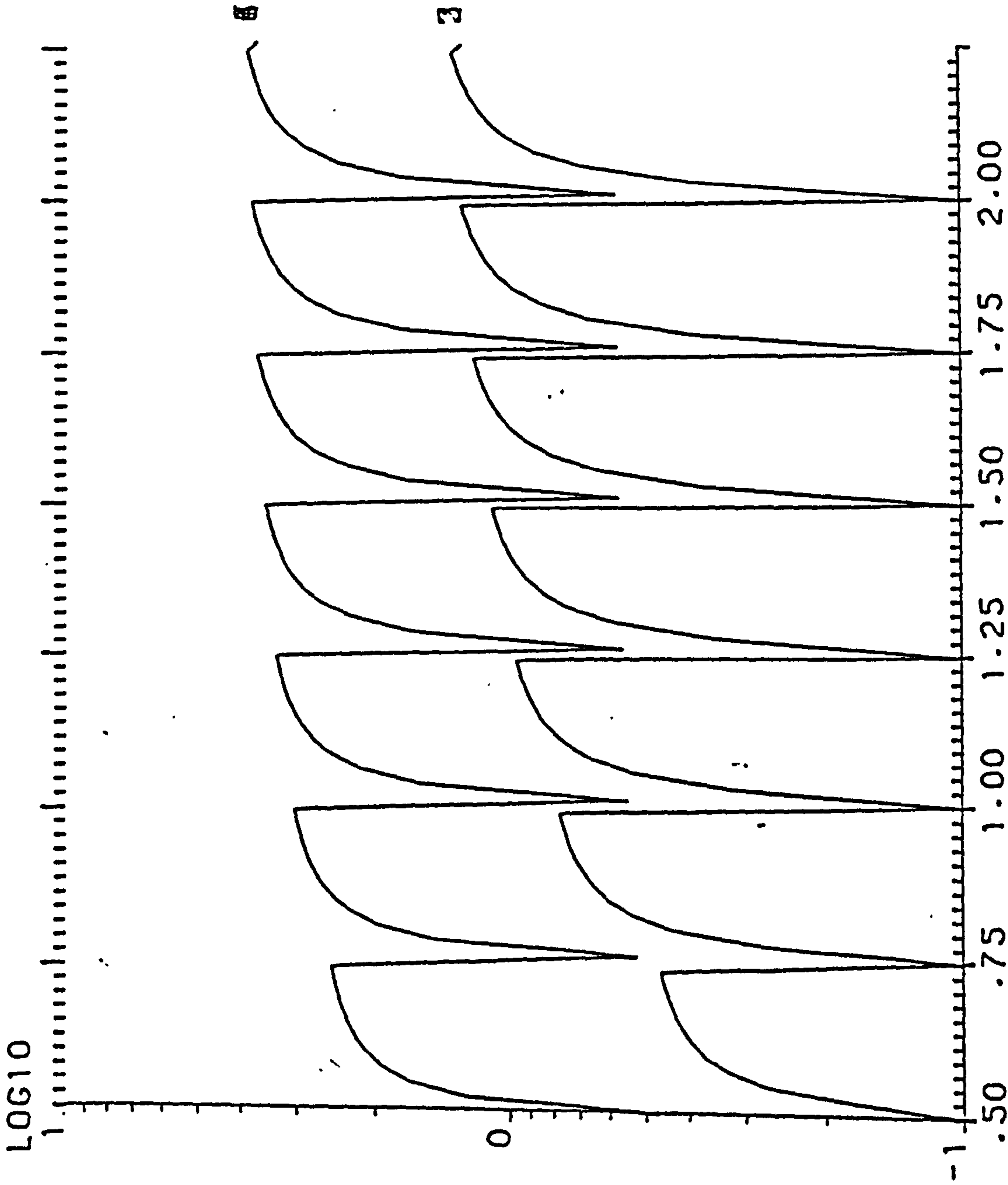

S. EFFICIENCY W. THICKNESS= .36M W. ORIENTATION= 22.50

WD= 4M HD1= 22M HD2= 4M HOUSE T.= 1.5 ST.

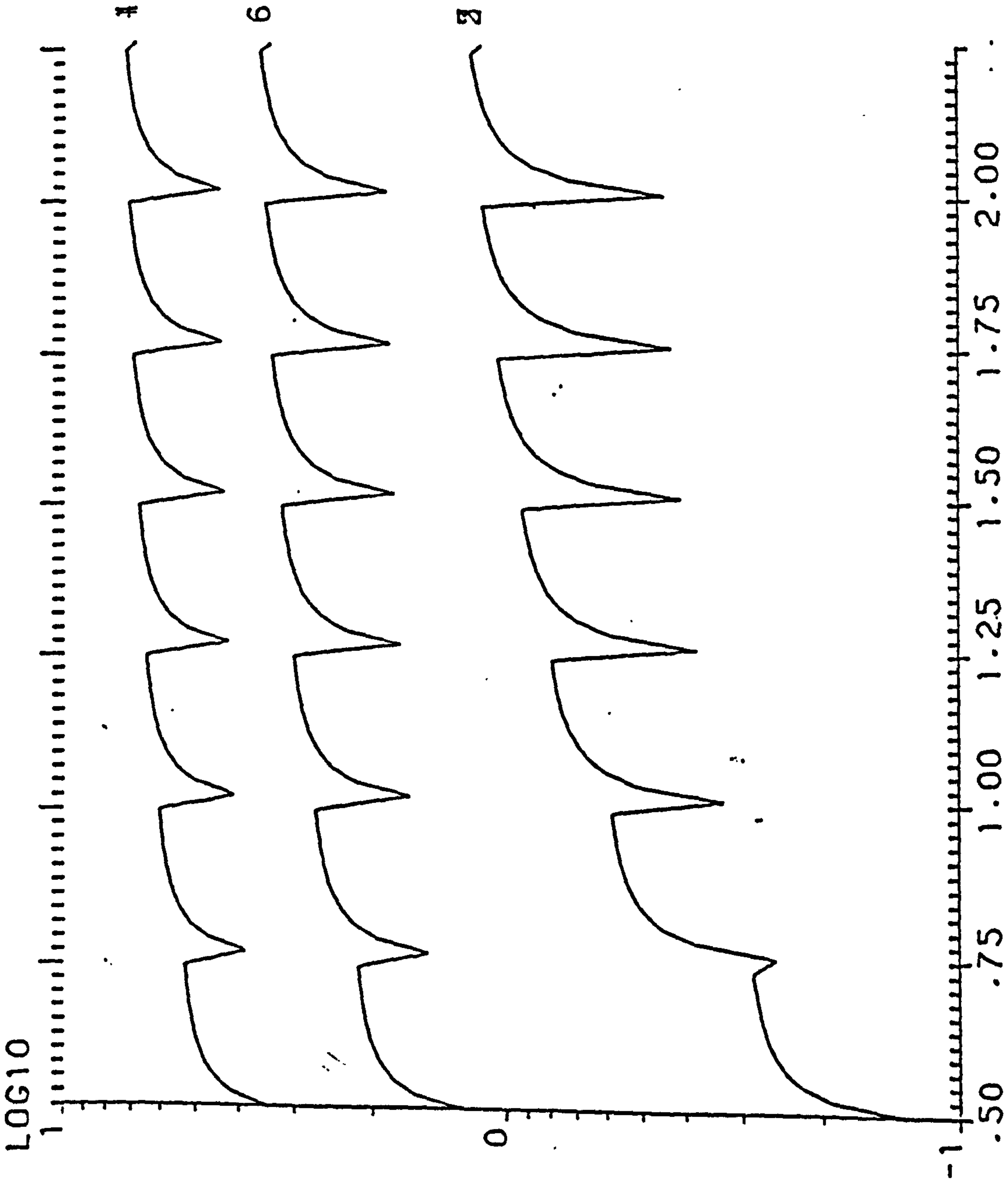

S. EFFICIENCY    W. THICKNESS=    .36M    W. ORIENTATION= 45.00

WD= 4M    HD1= 22M    HD2= 4M    HOUSE T.=1.5 ST.



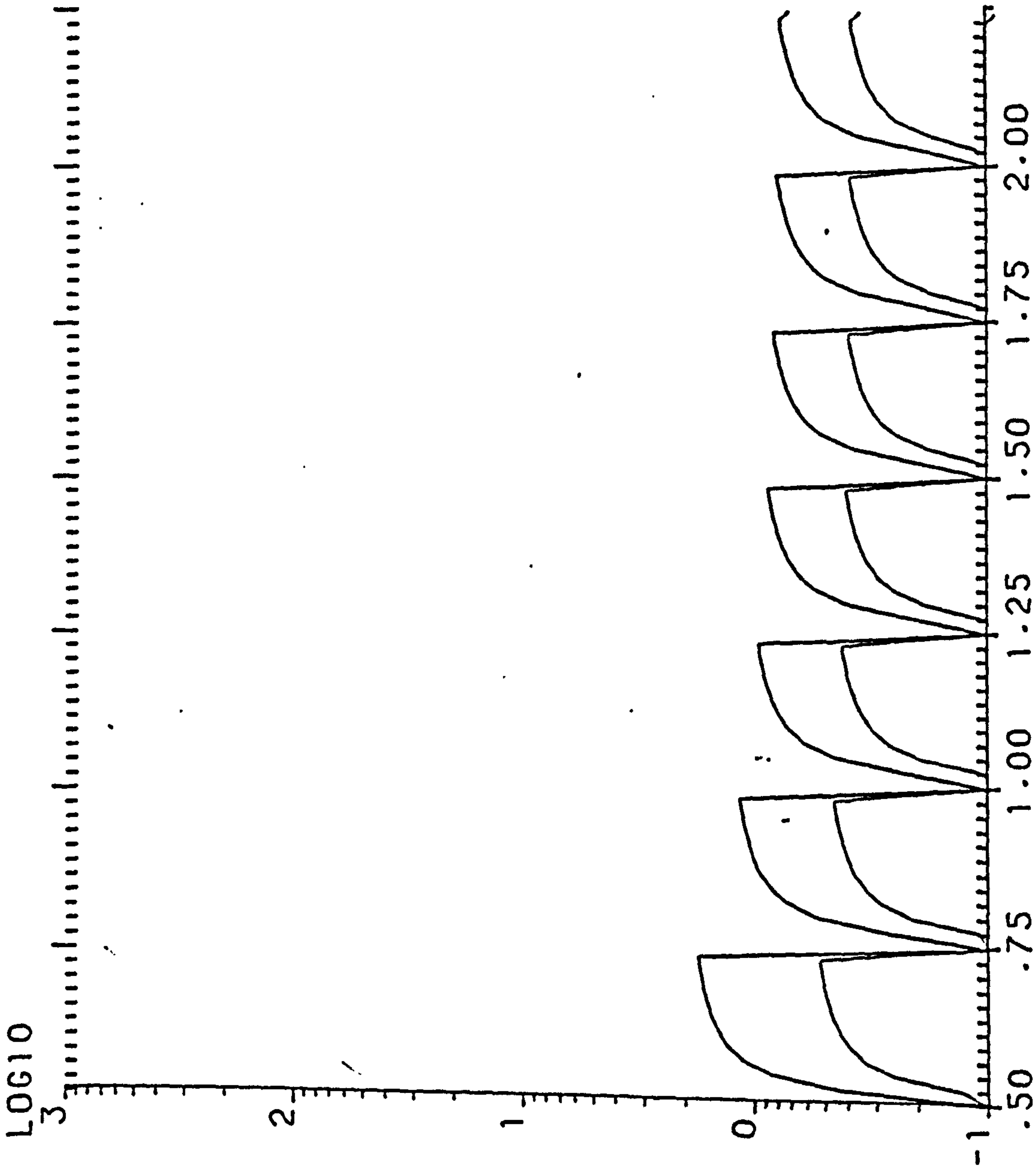

Y. EFFICIENCY W. THICKNESS= .36M W. ORIENTATION= 67.50

WD= 4M HD1= 22M HD2= 4M HOUSE T.=1.5 ST.

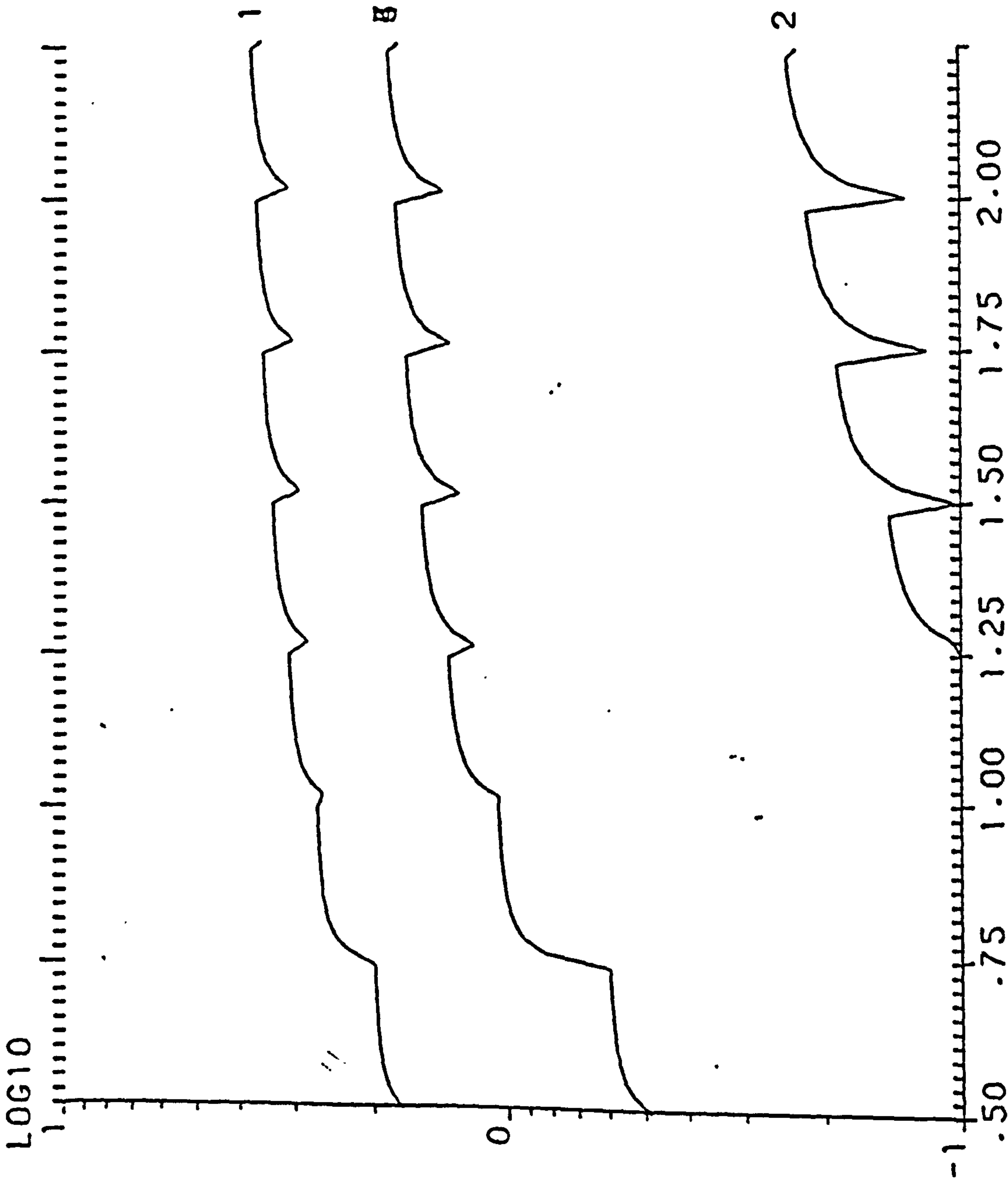

S. EFFICIENCY W. THICKNESS= .36M W. ORIENTATION= 67.50

WD= 4M HD1= 22M HD2= 4M HOUSE T.= 1.5 ST.

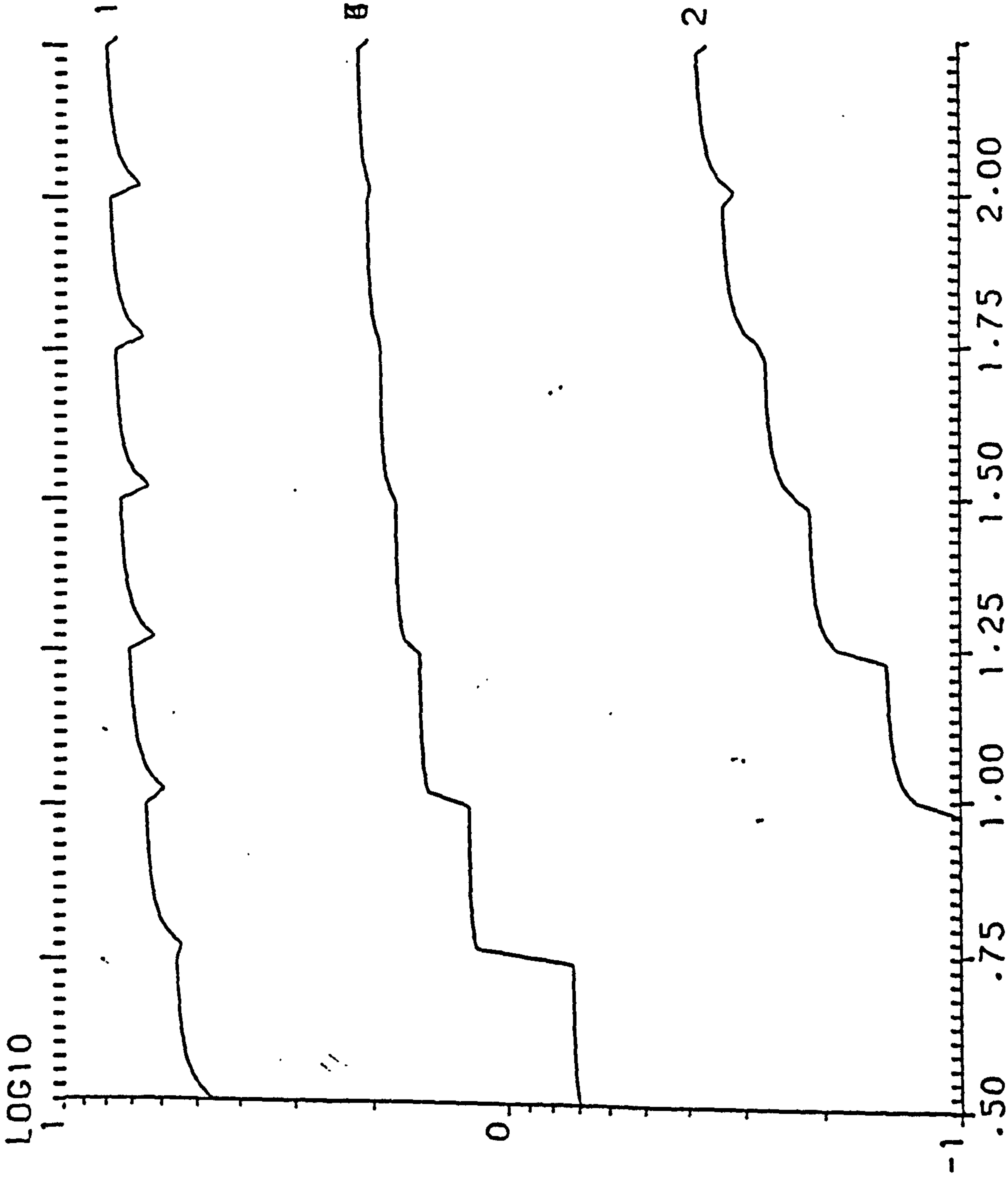

S. EFFICIENCY W. THICKNESS= .36M W. ORIENTATION= 90.00

WD= 4M HD1= 22M HD2= 4M HOUSE T.= 1.5 ST.



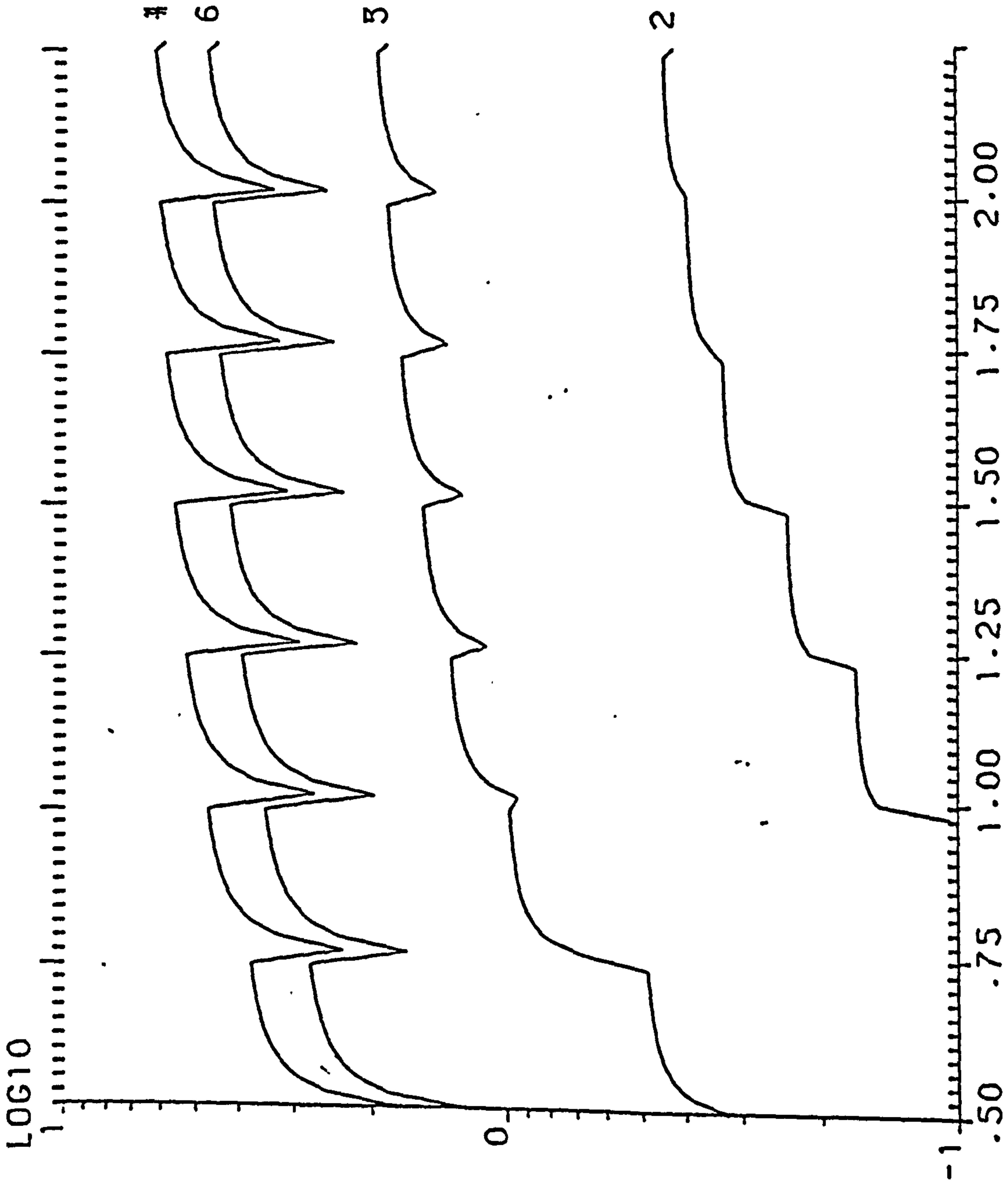

S. EFFICIENCY W. THICKNESS= .36M W. ORIENTATION=112.50

WD= 4M HD1= 22M HD2= 4M HOUSE T.=1,5 ST.

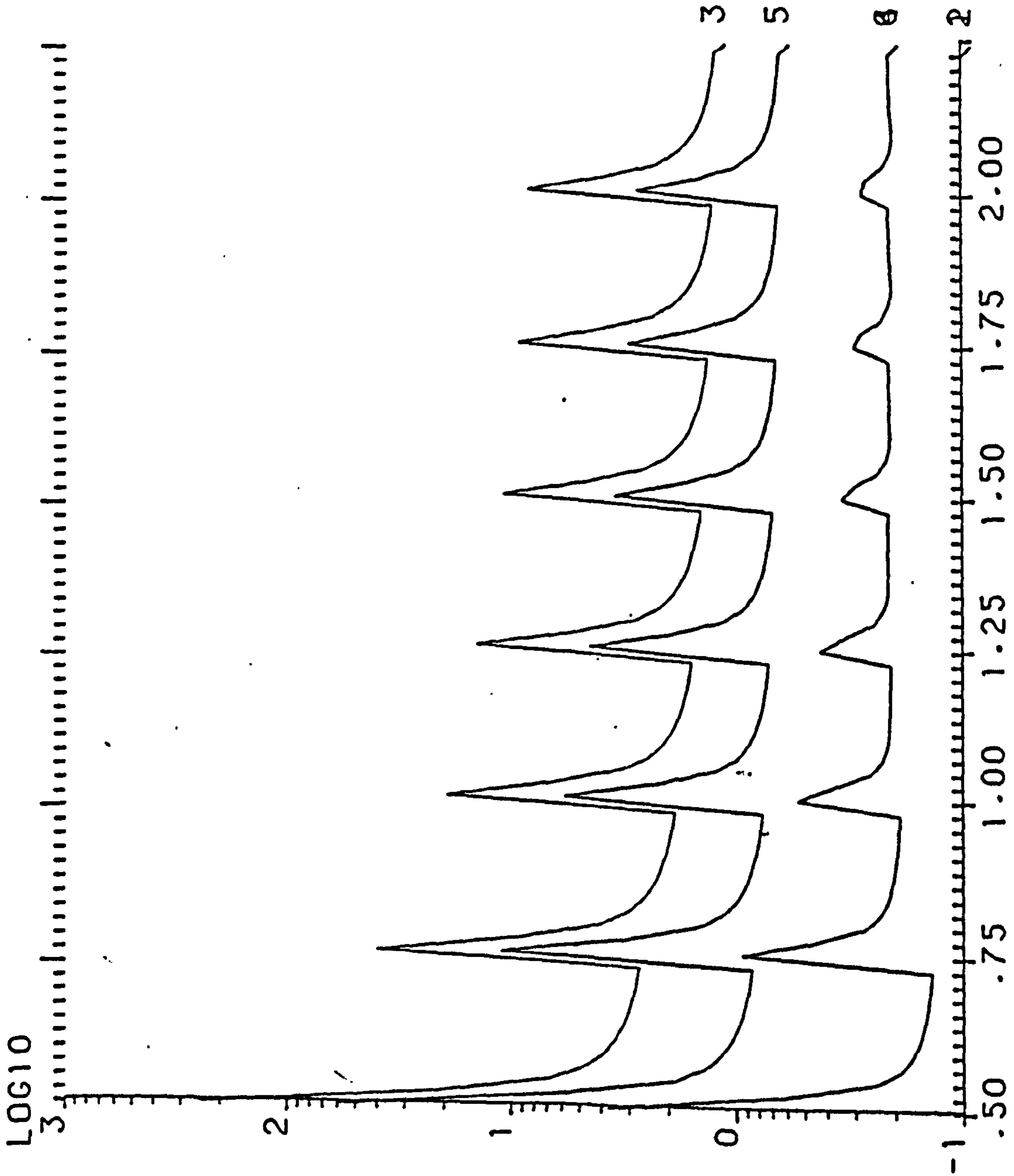

Y. EFFICIENCY W. THICKNESS= .36M W. ORIENTATION=135.00  
WD= 4M HD1= 22M HD2= 4M HOUSE T.=1.5 ST.



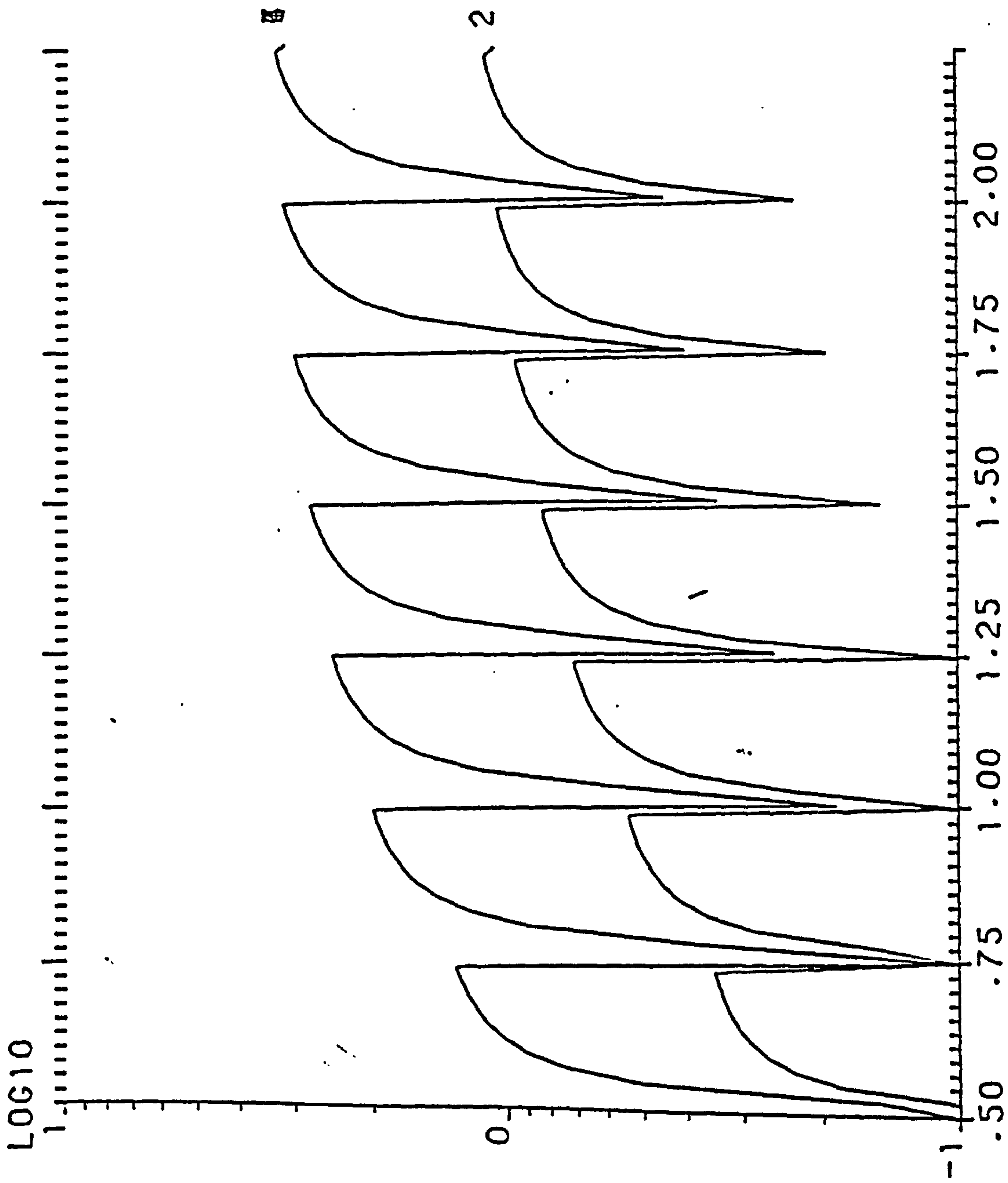

S. EFFICIENCY W. THICKNESS= .36M HD2= 4M HOUSE T.=1.5 ST.  
 W. ORIENTATION=135.00

WD= 4M HD1= 22M



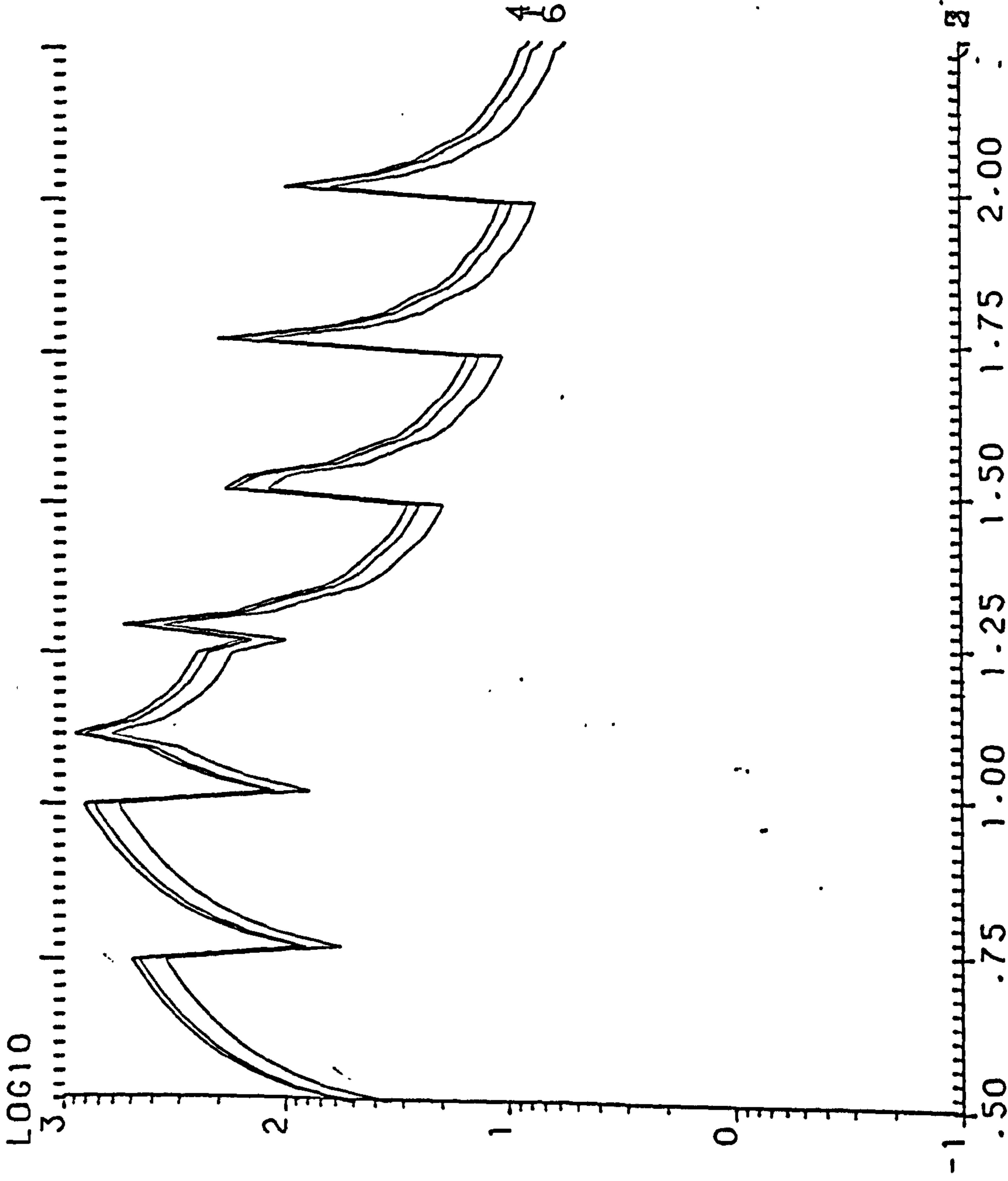

Y. EFFICIENCY W. THICKNESS= .36M W. ORIENTATION=157.50

WD= 4M HD1= 22M HD2= 4M HOUSE T.=1.5 ST.

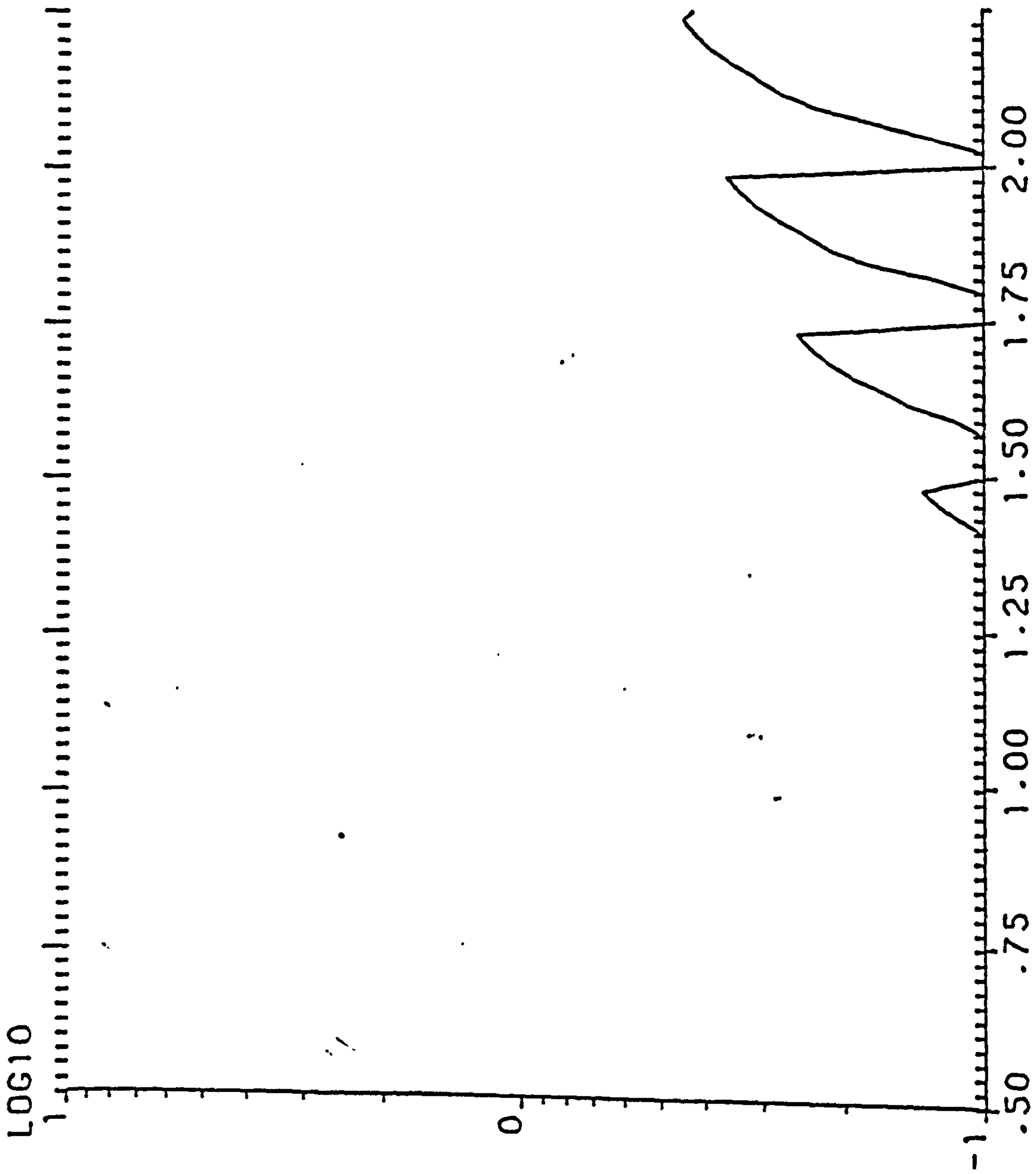

S. EFFICIENCY W. THICKNESS= .36M W. ORIENTATION=157.50

WD= 4M HD1= 22M HD2= 4M HOUSE T.=1.5 ST.



LOG10

1

0

-1

.50 1.00 1.25 1.50 1.75 2.00

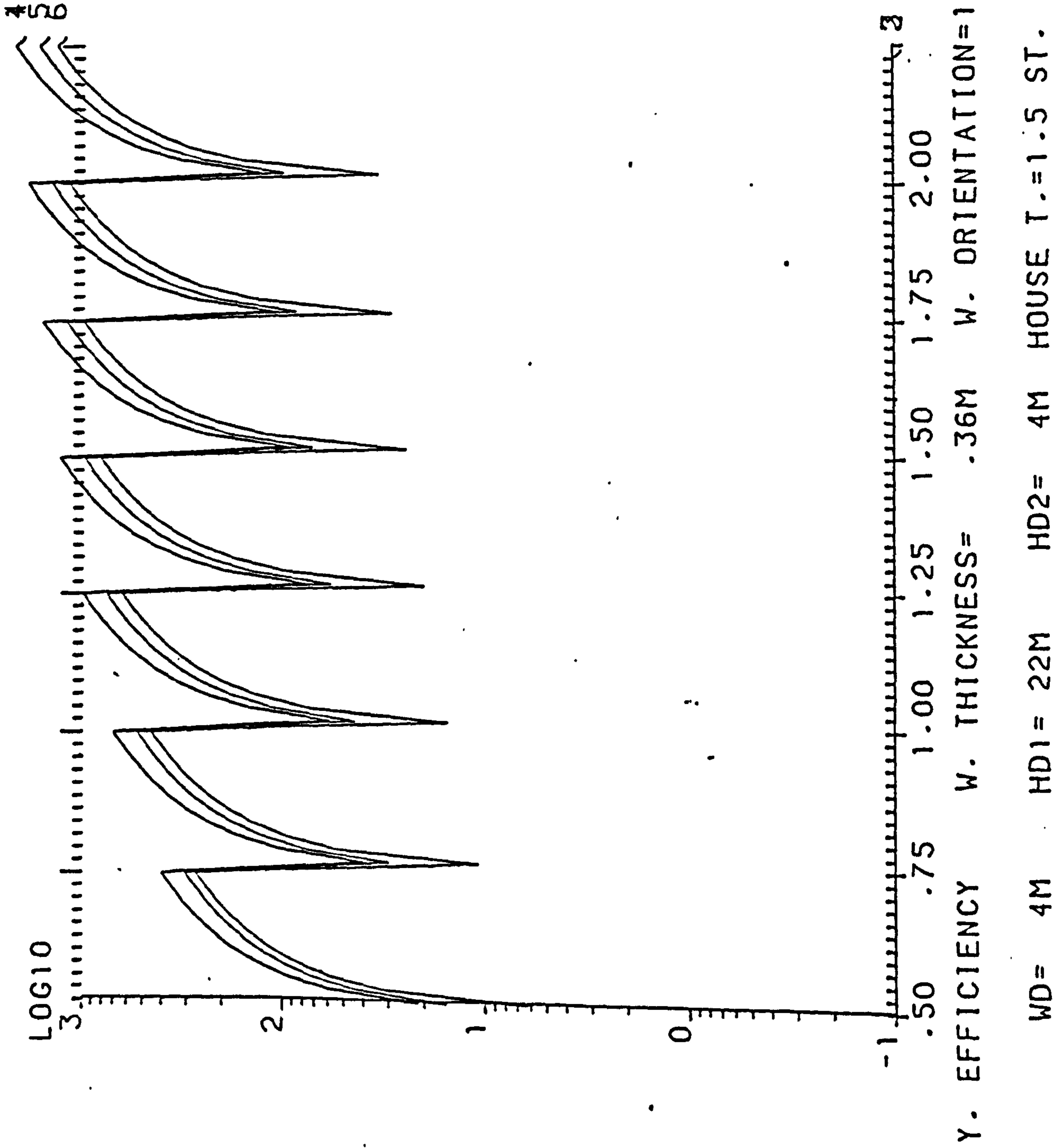

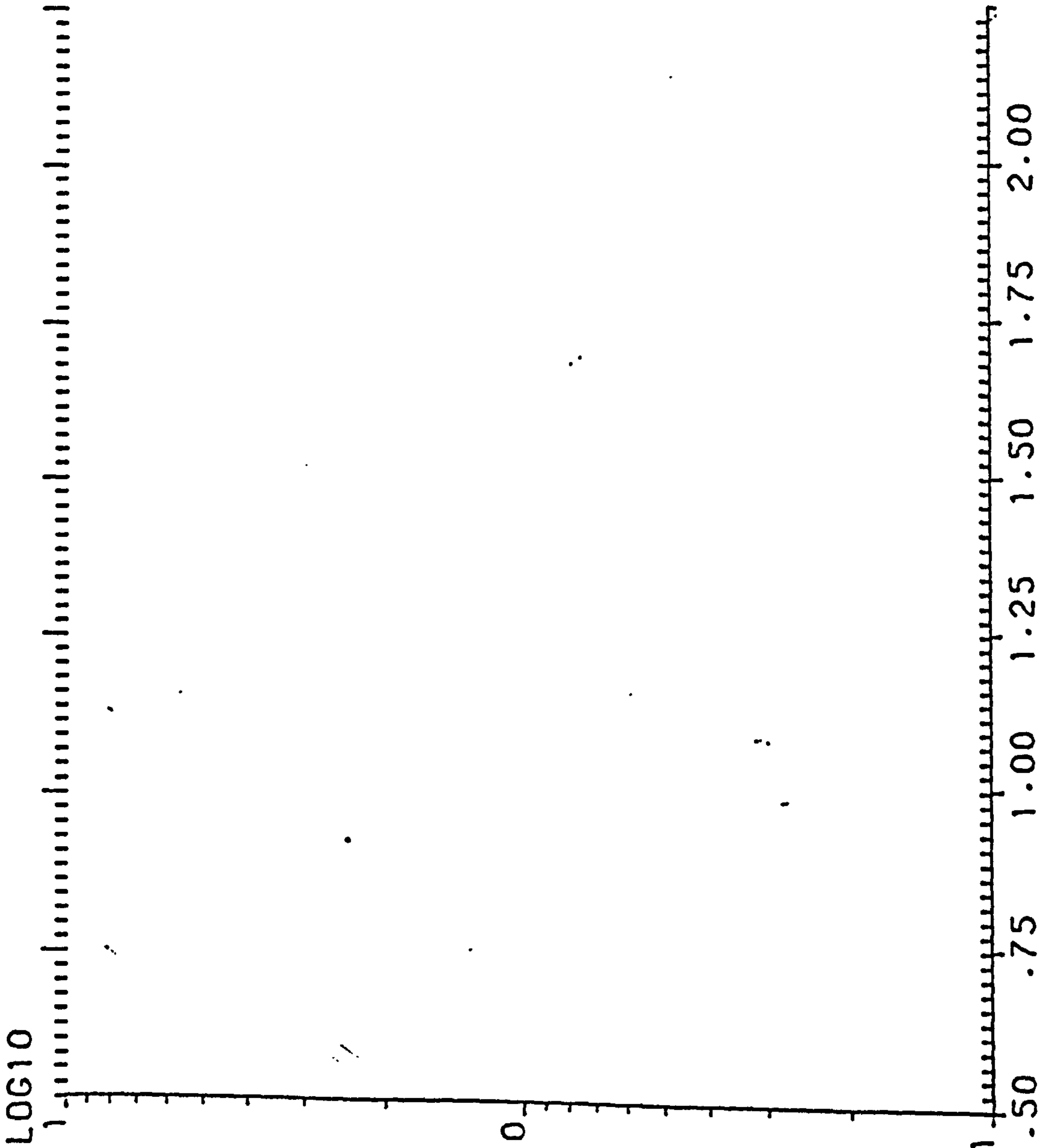

S. EFFICIENCY W. THICKNESS= .36M W. ORIENTATION=180.00

WD= 4M HD1= 22M HD2= 4M HOUSE T.=1.5 ST.



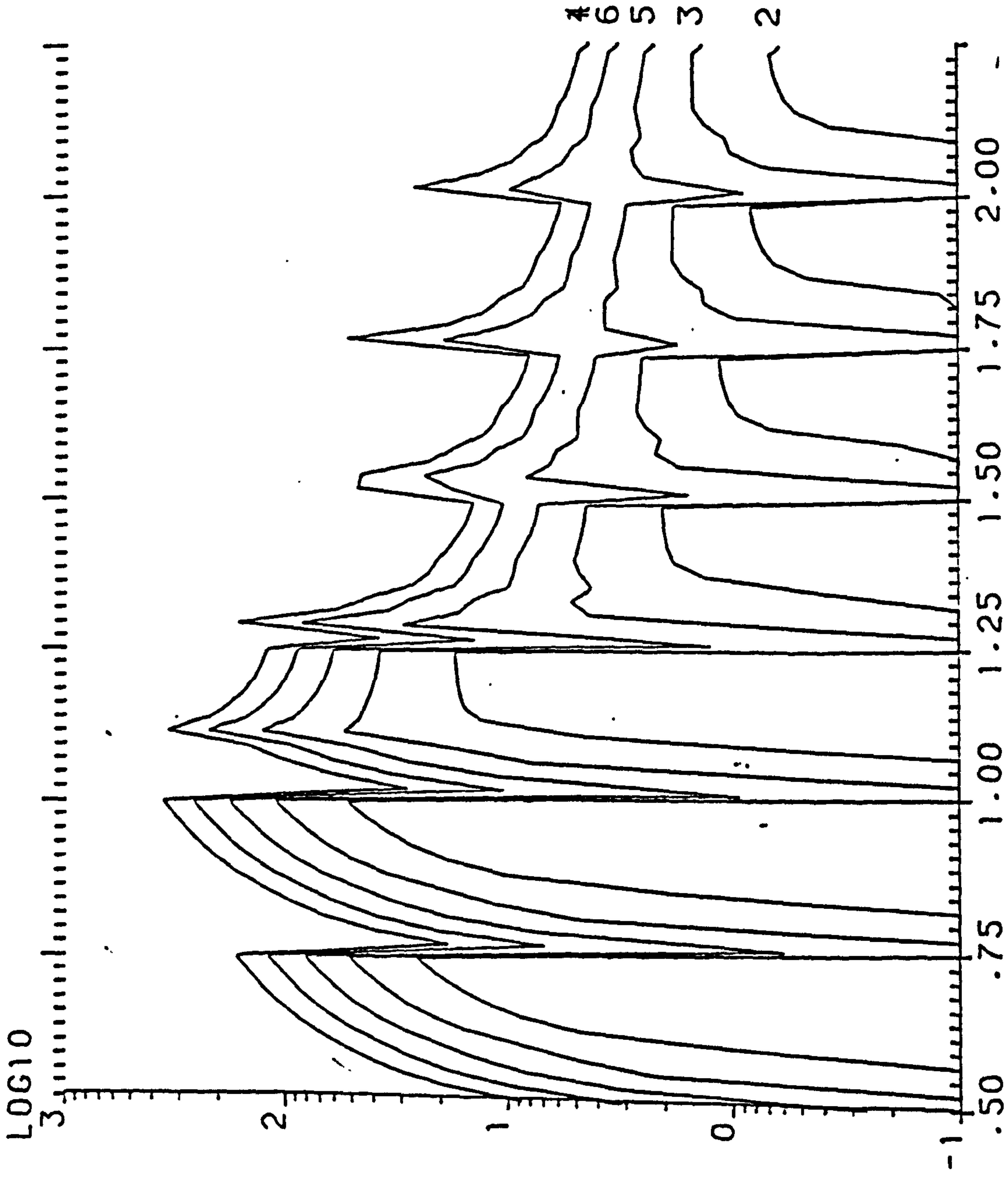

Y. EFFICIENCY W. THICKNESS= .36M W. ORIENTATION=202.50

WD= 4M HD1= 22M HD2= 4M HOUSE T.=1.5 ST.

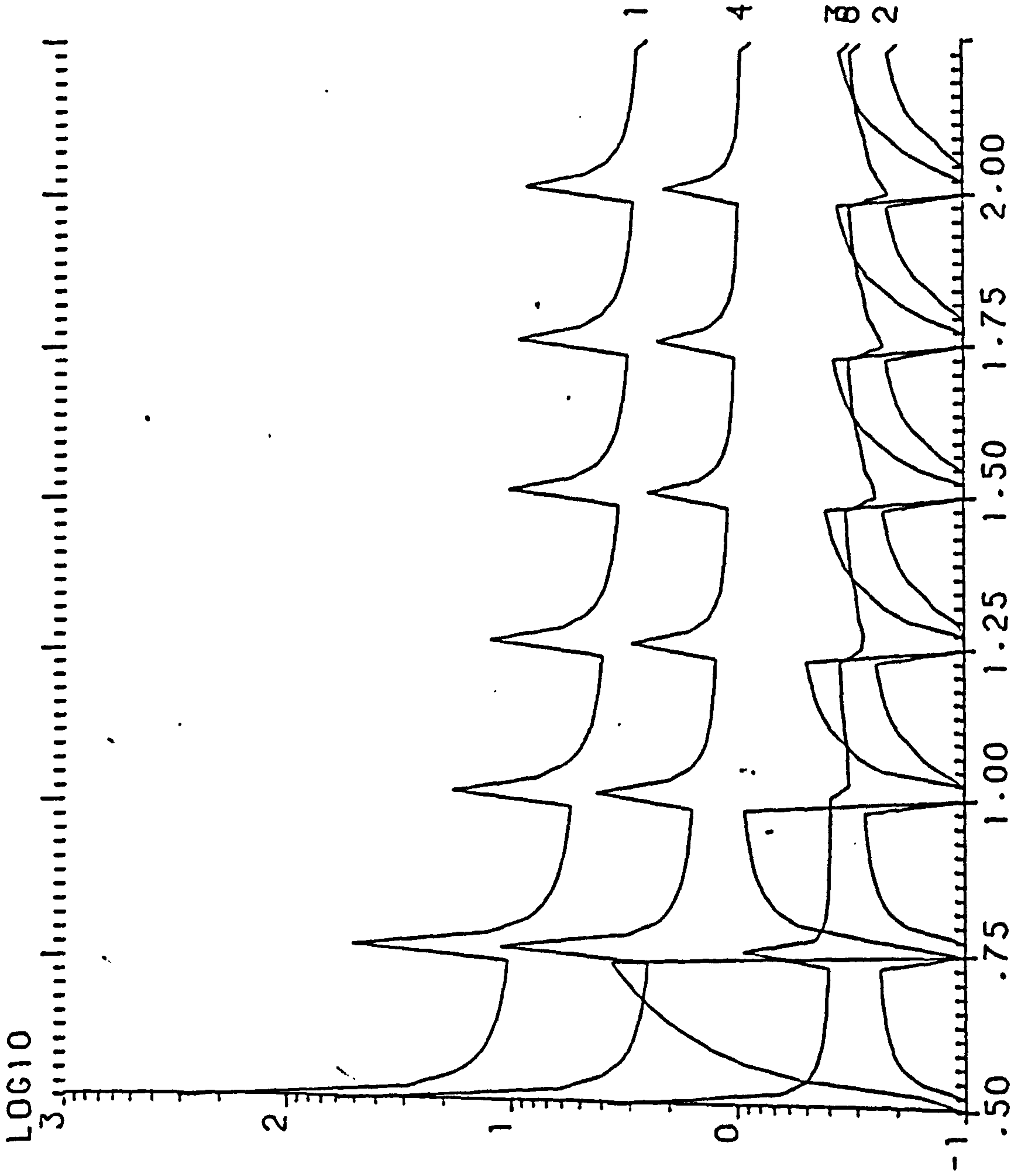

Y. EFFICIENCY W. THICKNESS= .36M W. ORIENTATION=225.00

WD= 4M HD1= 22M HD2= 4M HOUSE T.=1.5 ST.

LOG10

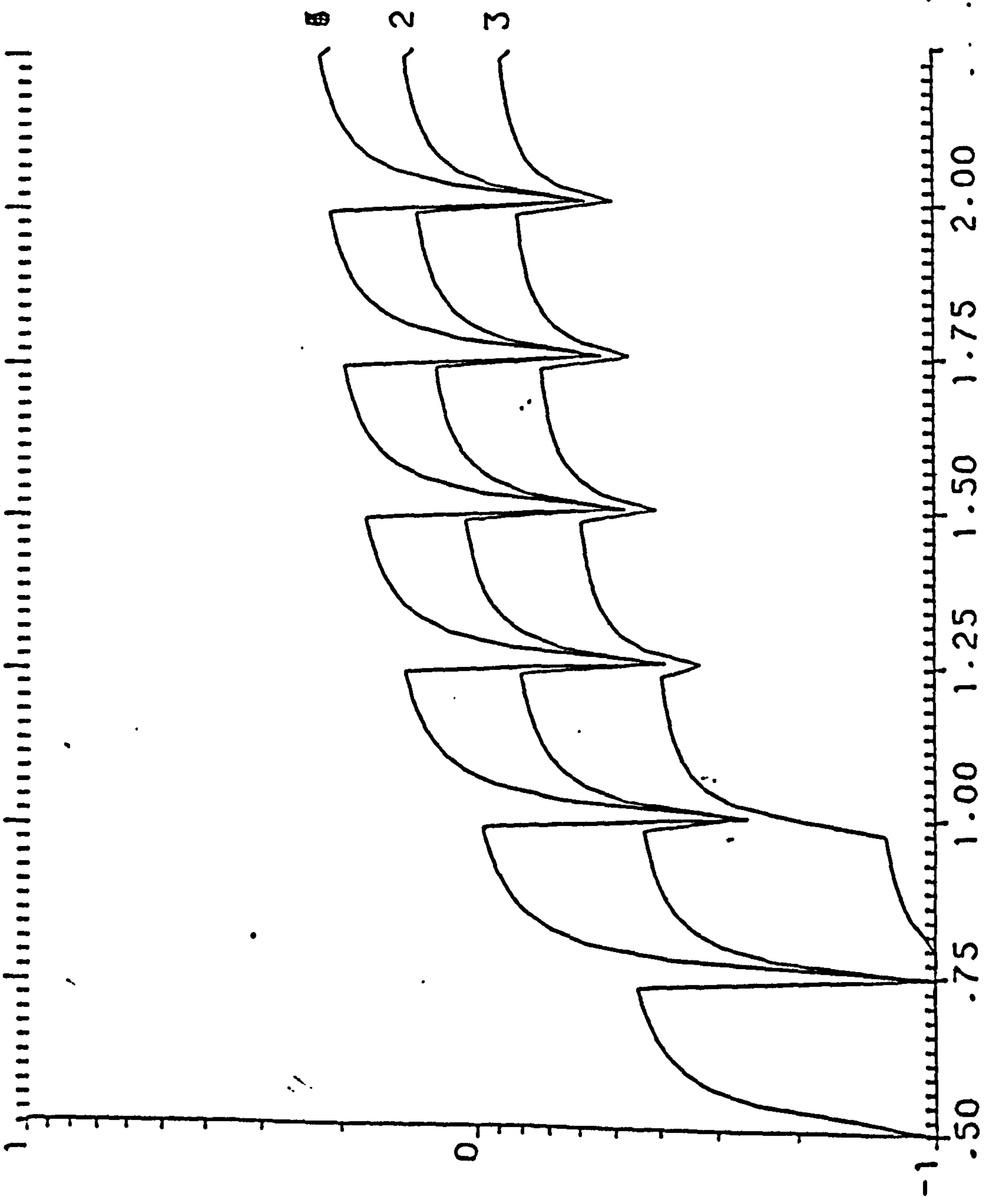

S. EFFICIENCY    W. THICKNESS=    .36M    HD2=    4M    HOUSE T.=1.5 ST.  
 W. ORIENTATION=225.00

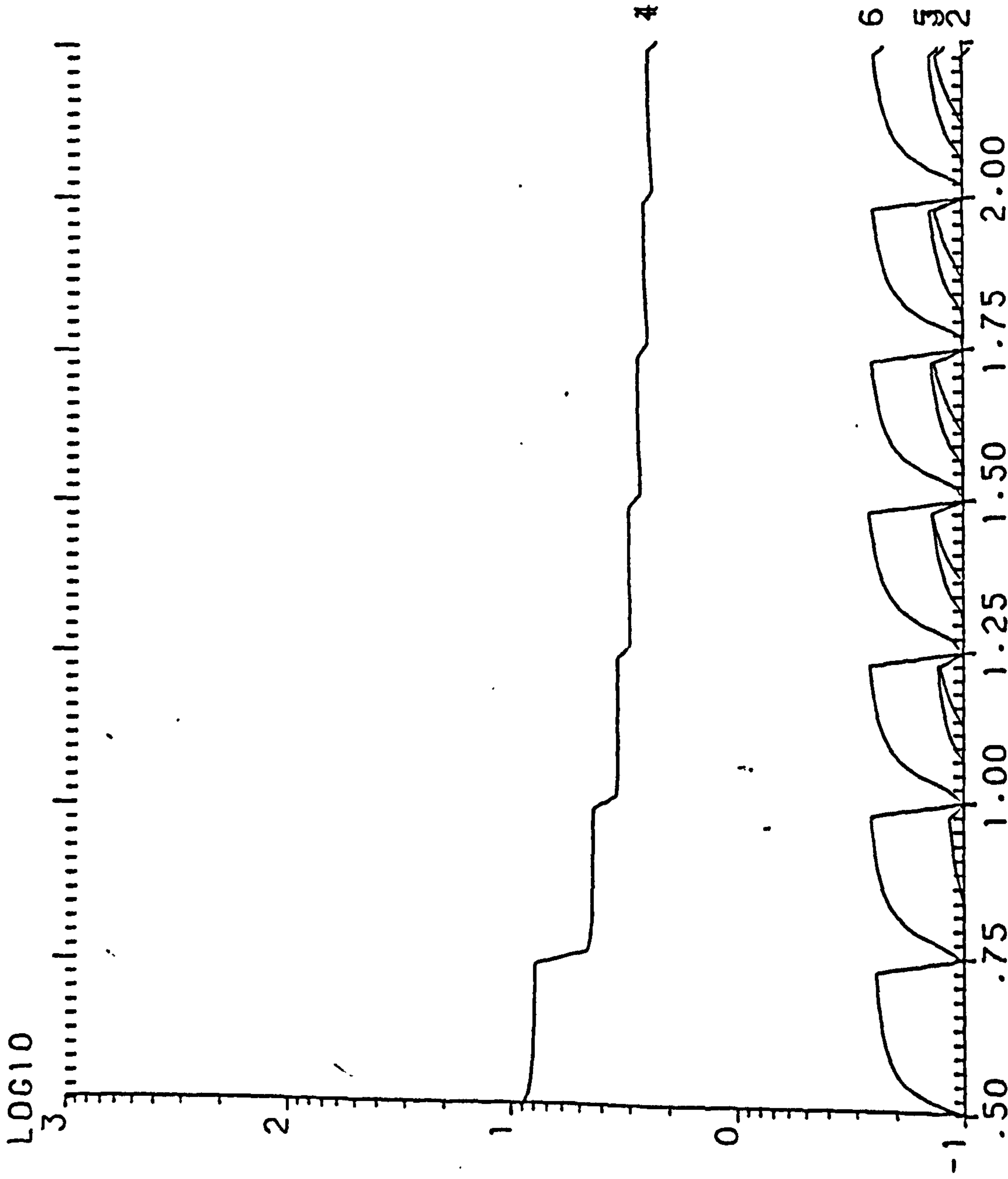

Y. EFFICIENCY W. THICKNESS= .36M W. ORIENTATION=247.50

WD= 4M HD1= 22M HD2= 4M HOUSE T.=1.5 ST.

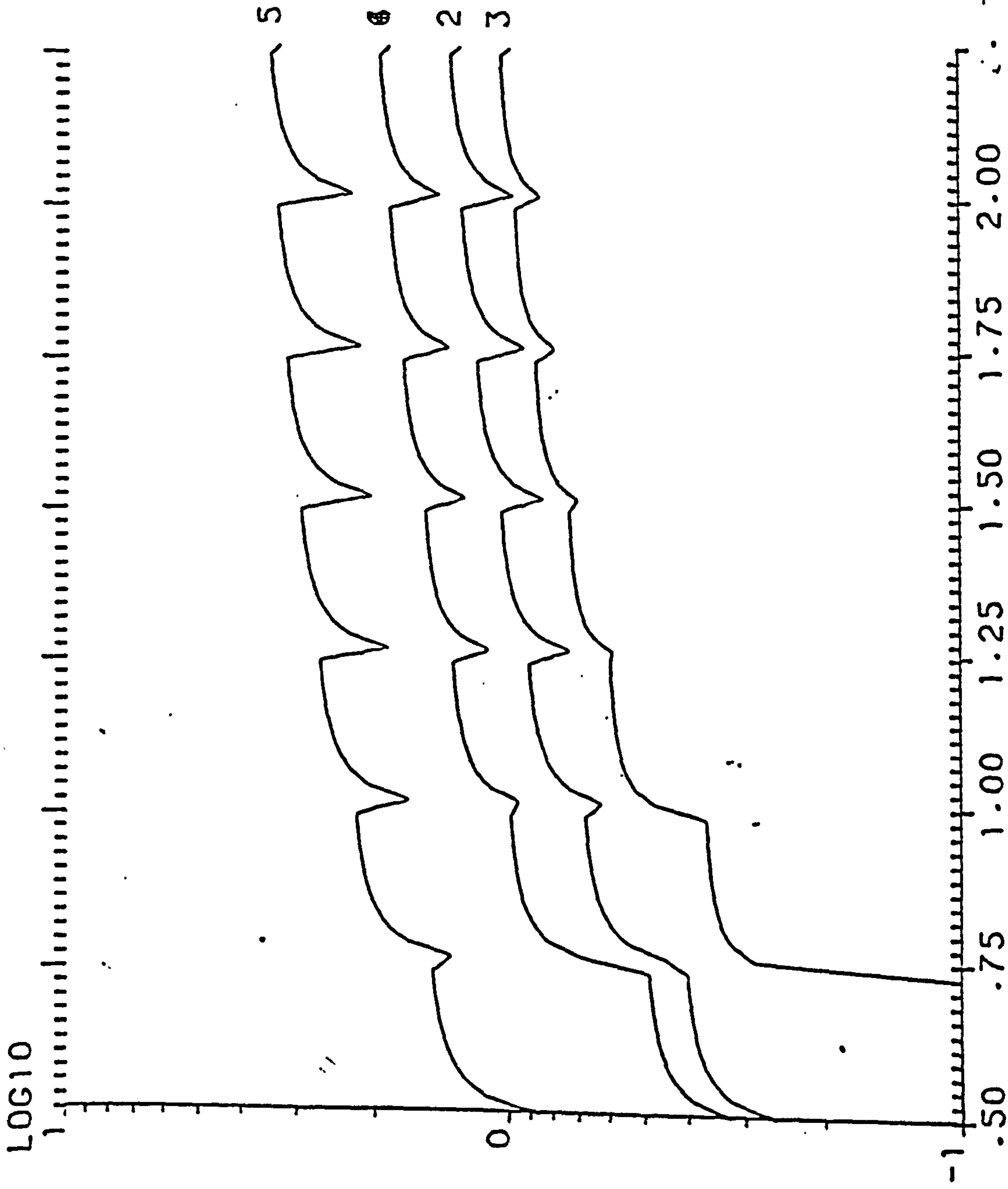

S. EFFICIENCY    W. THICKNESS=    .36M    W. ORIENTATION=247.50  
 WD= 4M    HD1= 22M    HD2= 4M    HOUSE T.=1.5 ST.



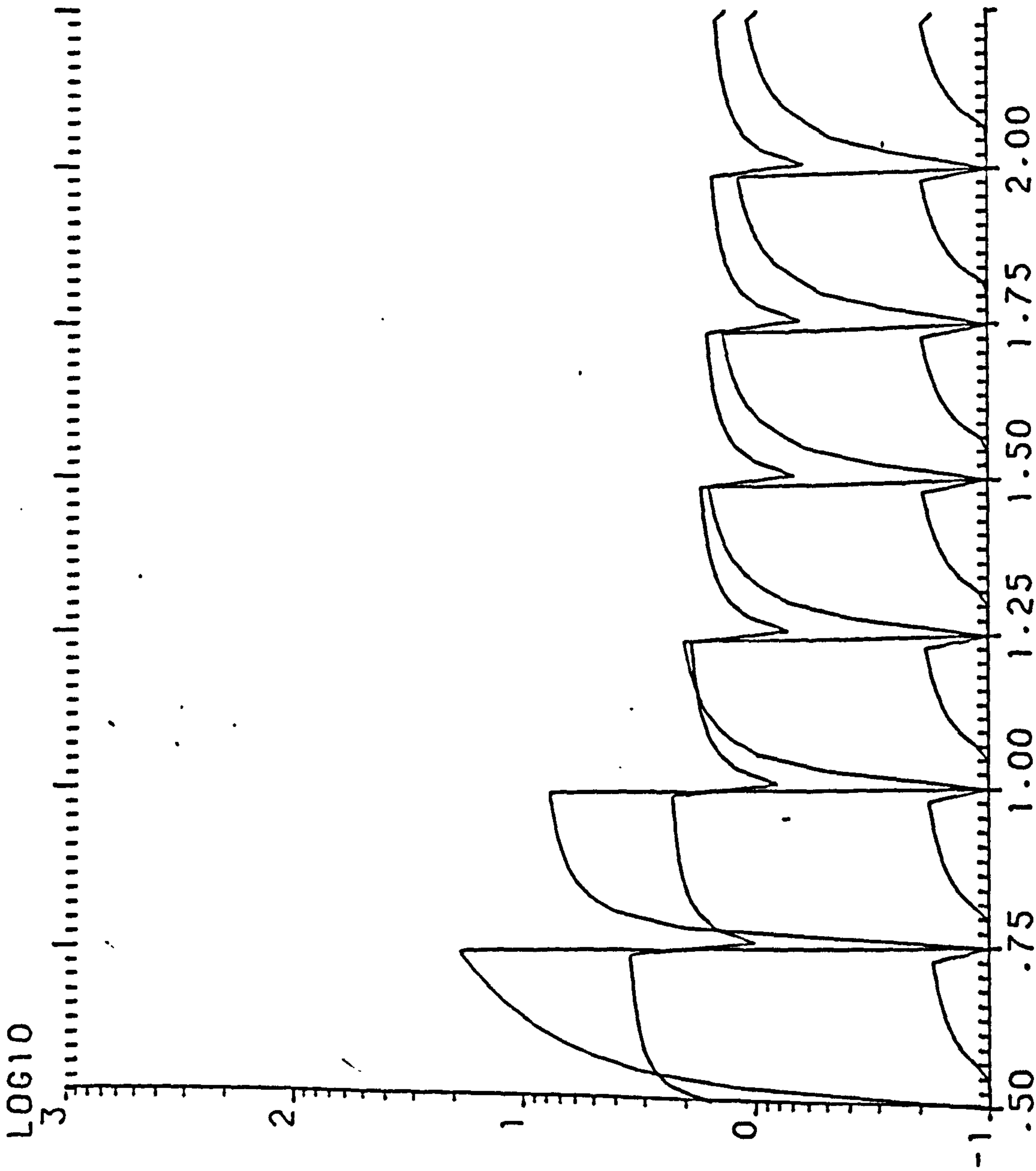

Y. EFFICIENCY W. THICKNESS= .36M W. ORIENTATION=270.00

WD= 4M HD1= 22M HD2= 4M HOUSE T.=1.5 ST.

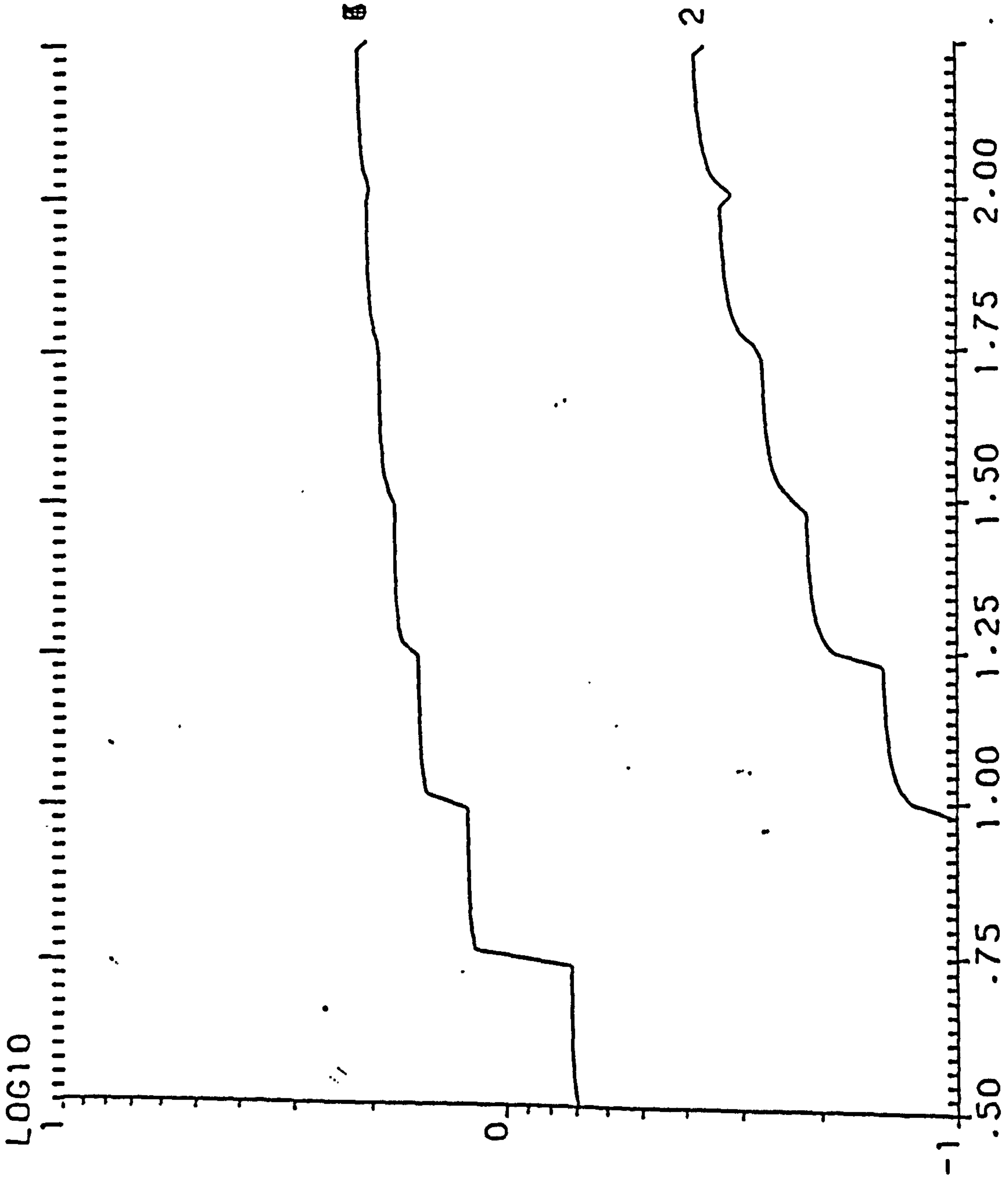

S. EFFICIENCY W. THICKNESS= .36M W. ORIENTATION=270.00

WD= 4M HD1= 22M HD2= 4M HOUSE T.=1.5 ST.



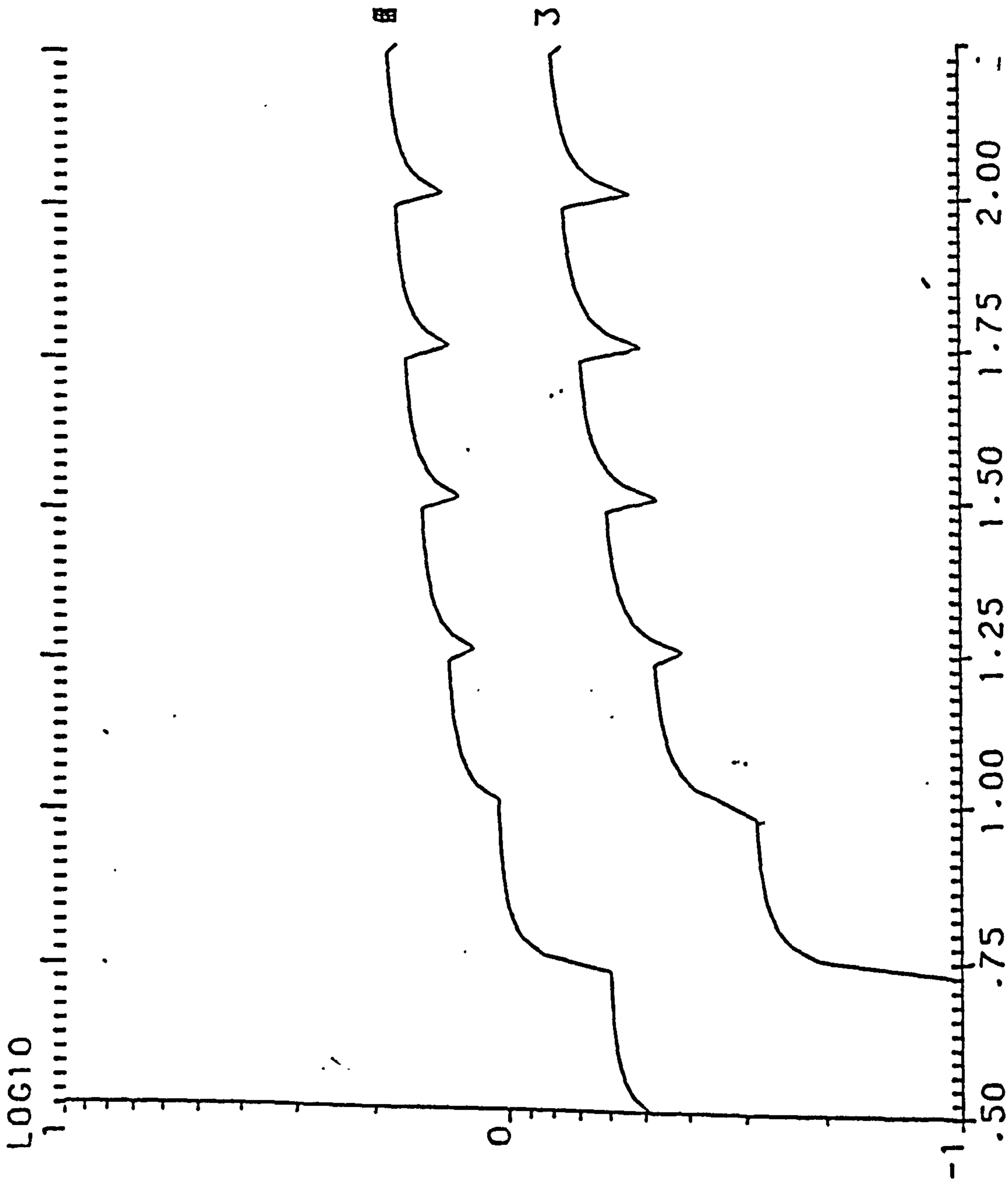

S. EFFICIENCY W. THICKNESS= .36M W. ORIENTATION=292.50

WD= 4M HD1= 22M HD2= 4M HOUSE T.= 1.5 ST.



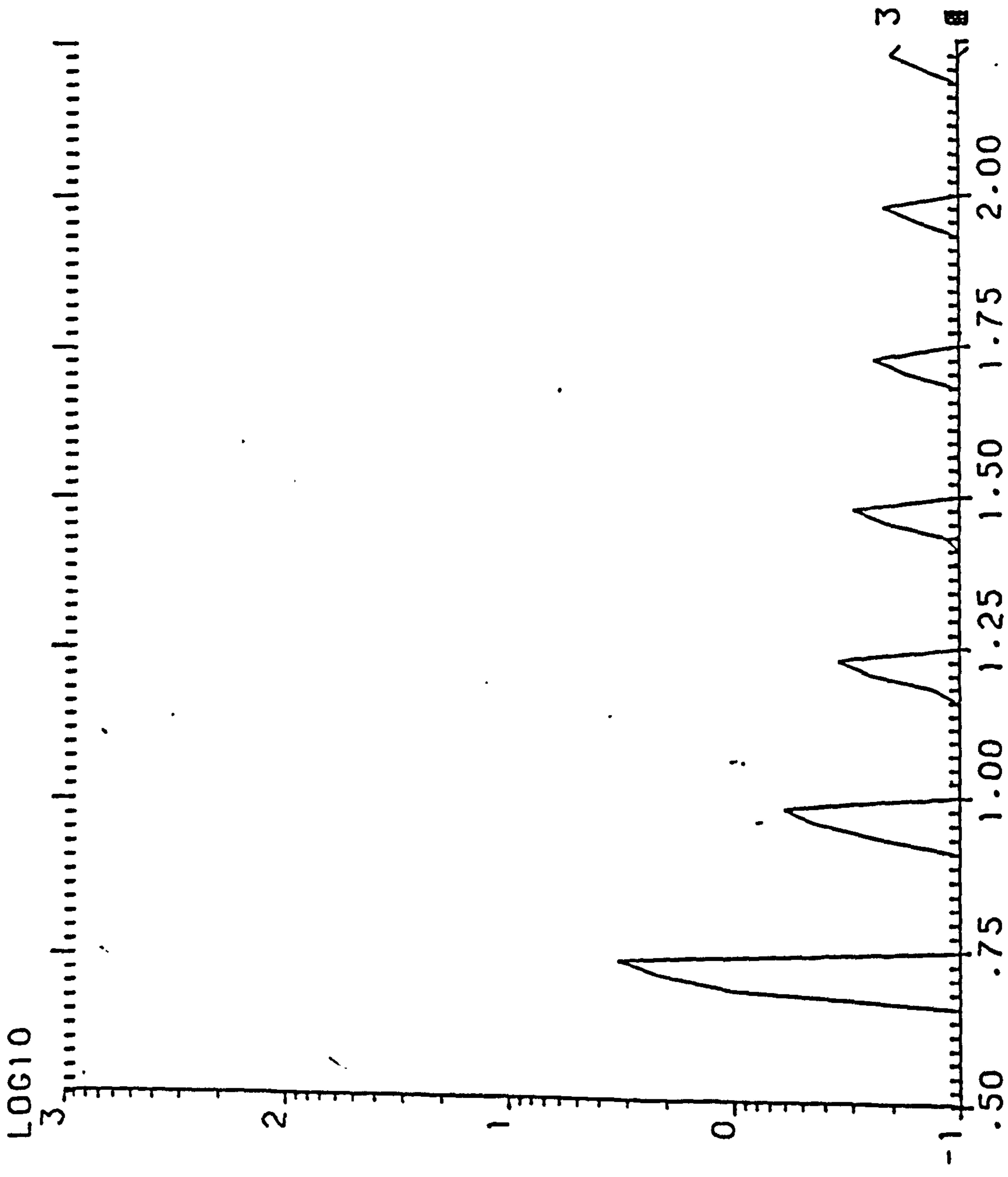

Y. EFFICIENCY W. THICKNESS= .36M W. ORIENTATION=315.00

WD= 4M HD1= 22M HD2= 4M HOUSE T.=1.5 ST.

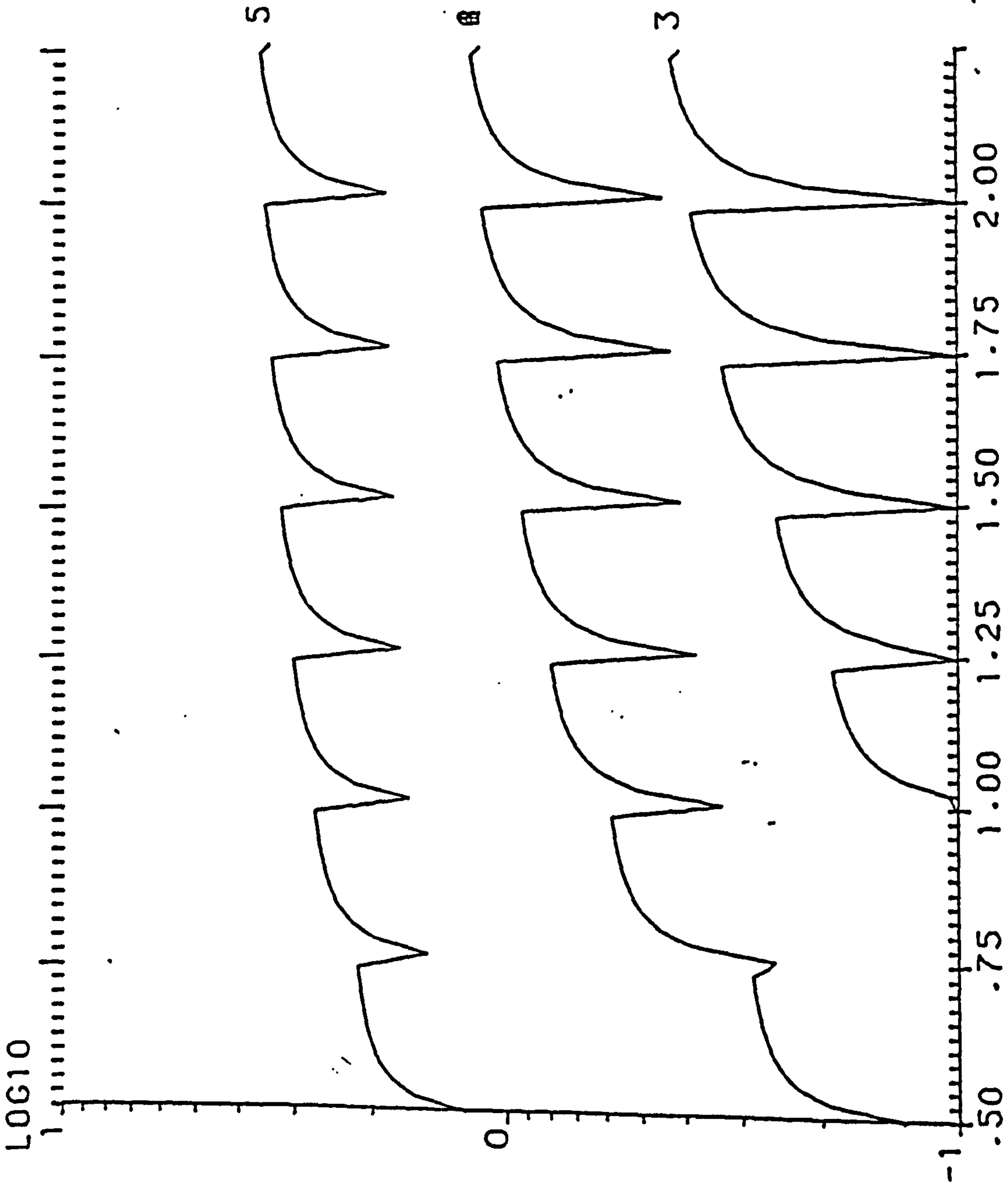

S. EFFICIENCY W. THICKNESS= .36M W. ORIENTATION=315.00  
 WD= 4M HD1= 22M HD2= 4M HOUSE T.=1.5 ST.



LOG10

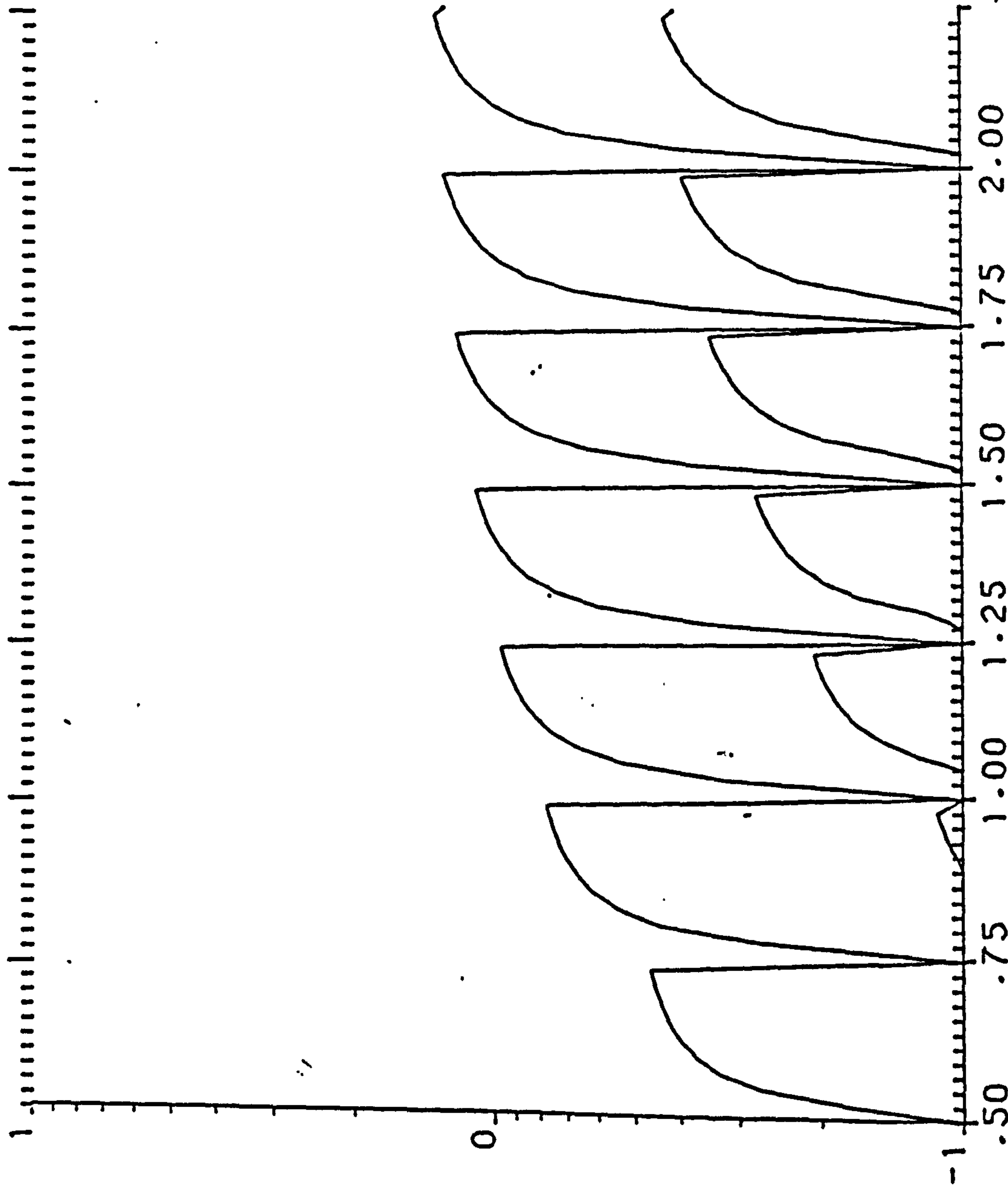

S. EFFICIENCY W. THICKNESS= .36M W. ORIENTATION=337.50

WD= 4M HD1= 22M HD2= 4M HOUSE T.=1.5 ST.





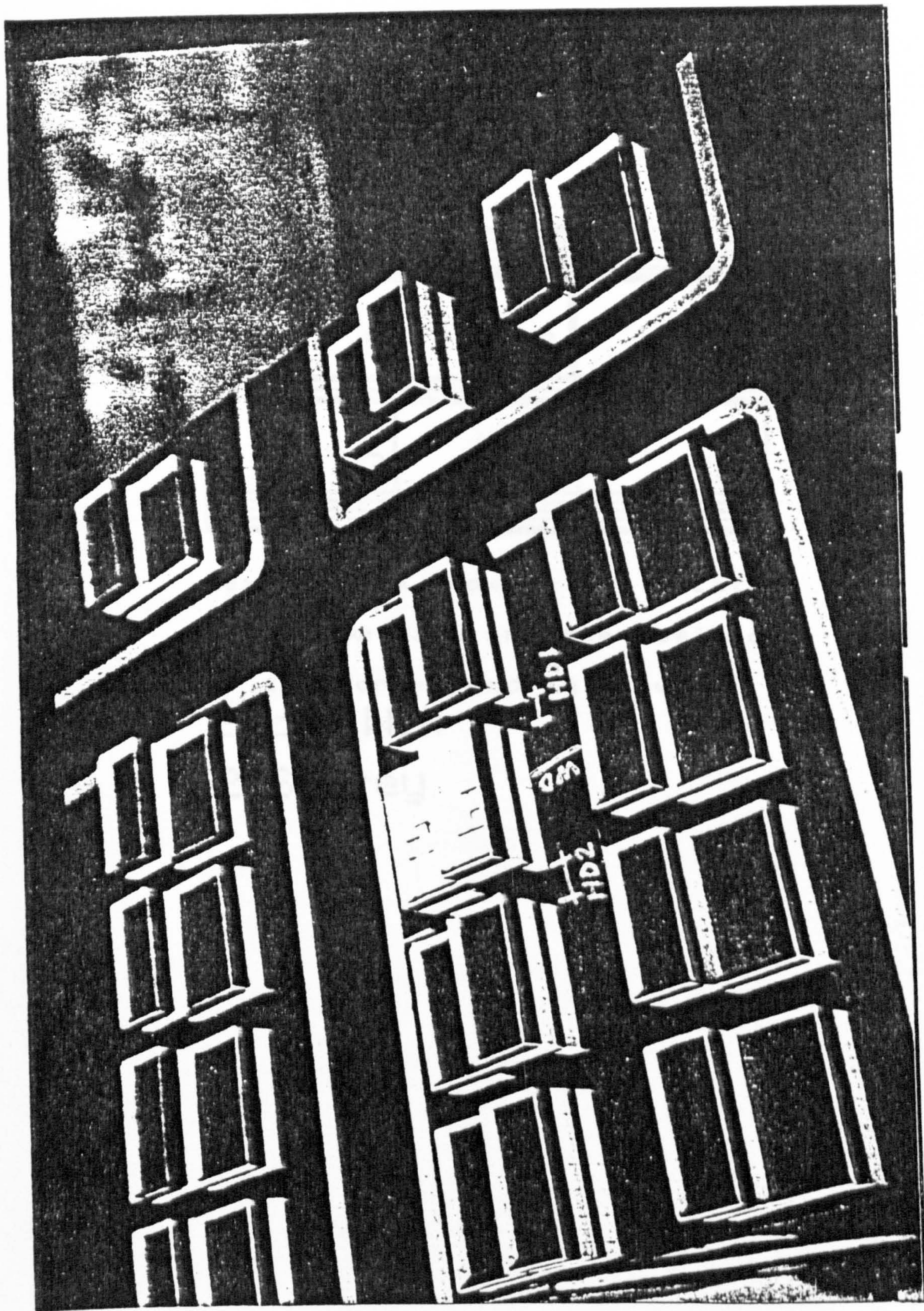

Model showing interhouse distances



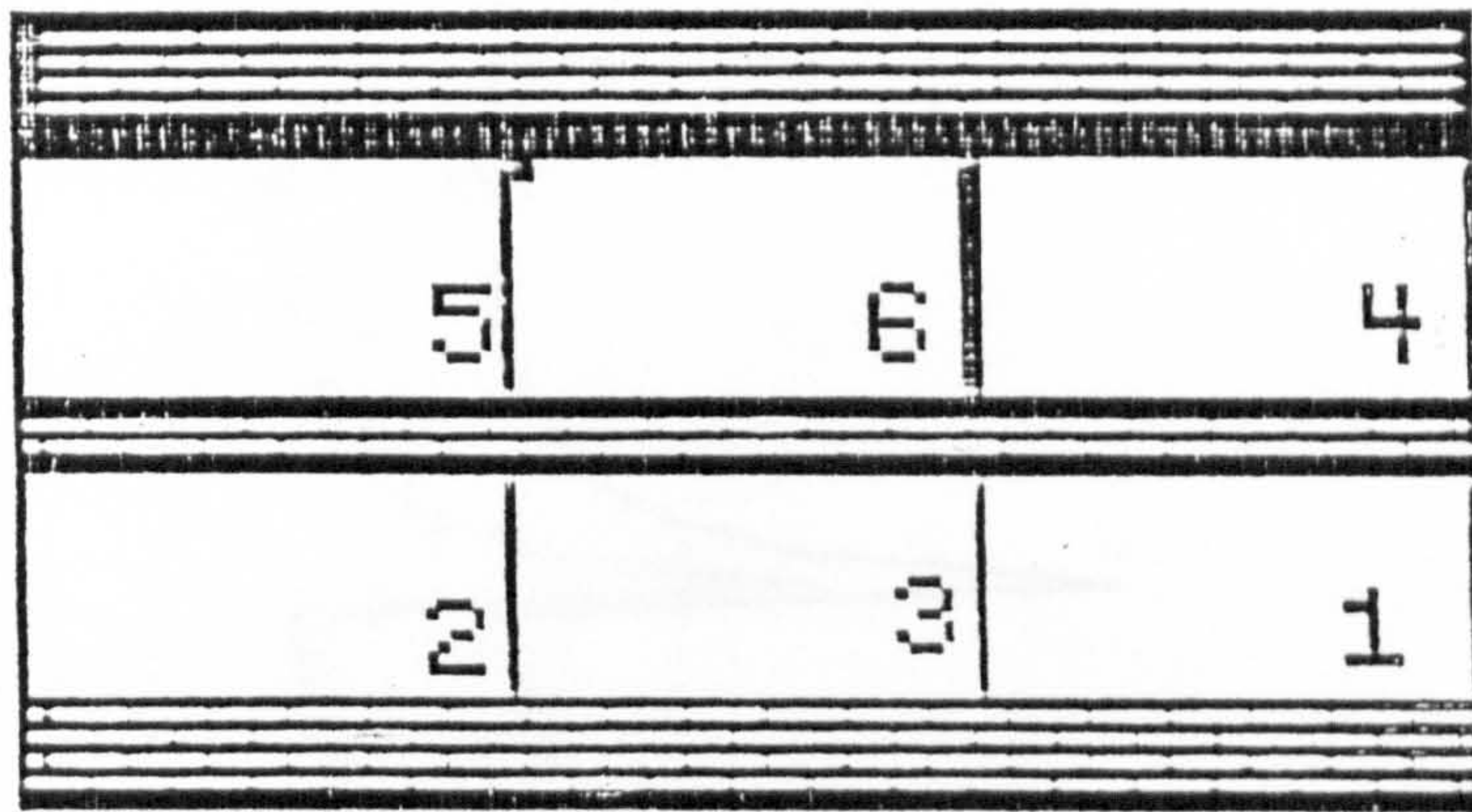

Key diagram showing the location  
of window data and the position  
of the corresponding curve  
Back Wall  
2 Storey

50  
S. EFFICIENCY  
W. THICKNESS  
M. ORIENTATION  
H01  
H02  
HOUSE

LOG10  
1

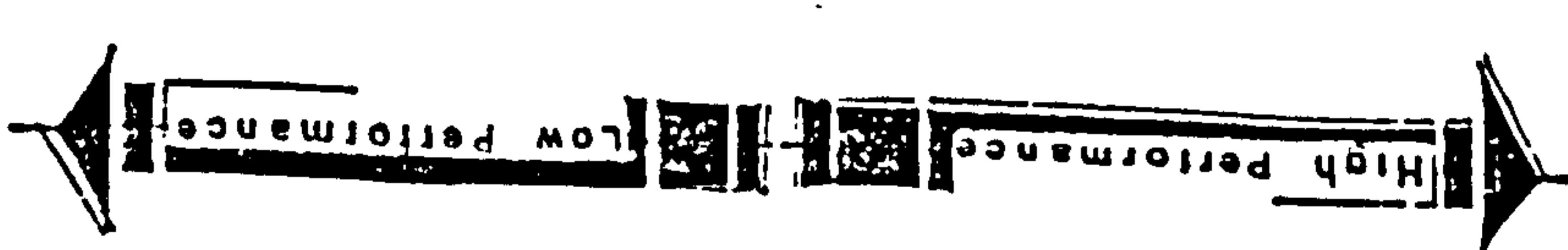
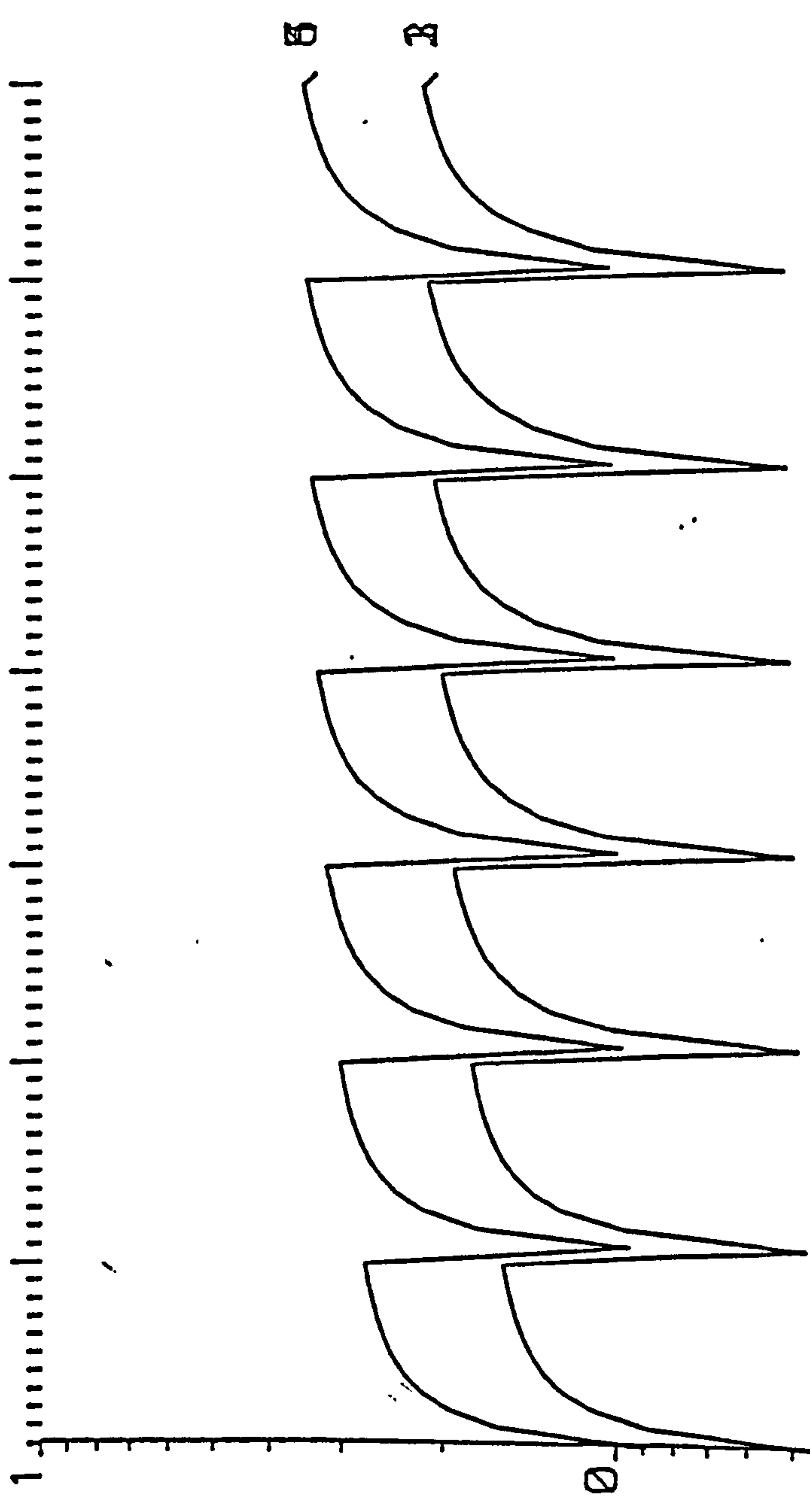

-1  
 .50 .75 1.00 1.25 1.50 1.75 2.00  
 S. EFFICIENCY W. THICKNESS= .12M W. ORIENTATION= .00  
 WD= 4M HD1= 4M HD2= 4M HOUSE T.=2.0 ST.

LOG10

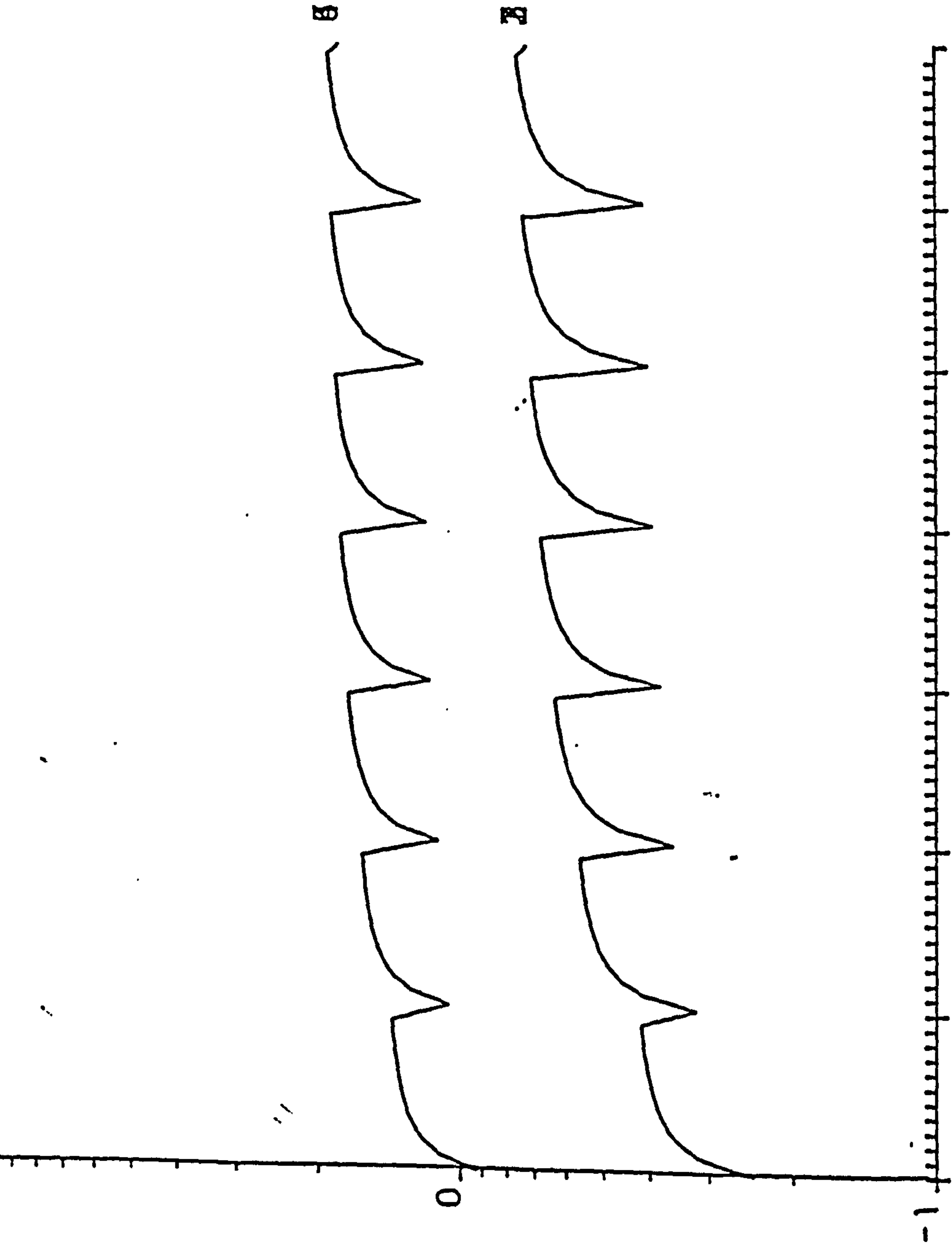

S. EFFICIENCY W. THICKNESS= .12M W. ORIENTATION= 22.50

WD= 4M HD1= 4M HD2= 4M HOUSE T.=2.0 ST.





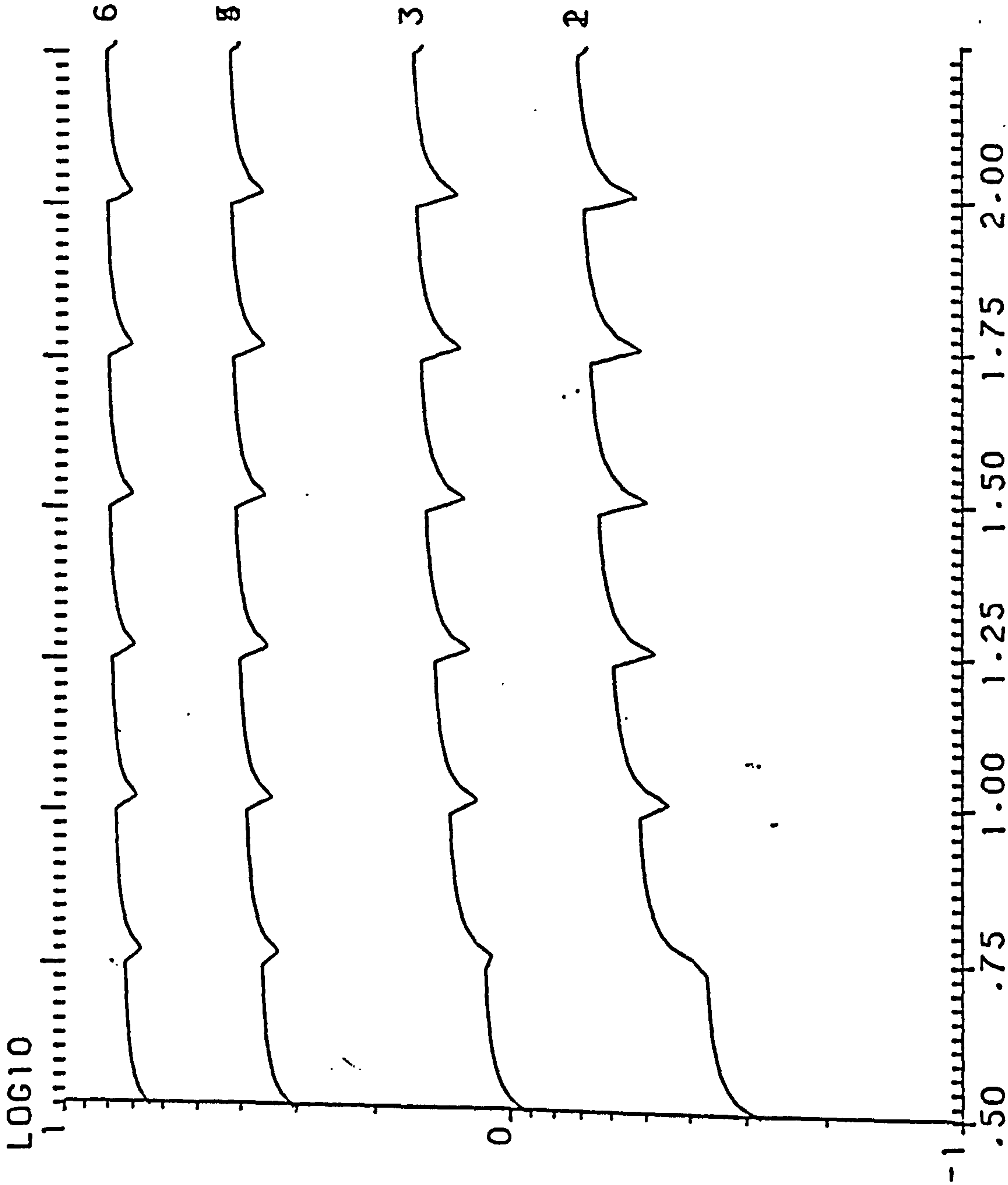

S. EFFICIENCY W. THICKNESS= .12M W. ORIENTATION= 45.00  
 WD= 4M HD1= 4M HD2= 4M HOUSE T.=2.0 ST.

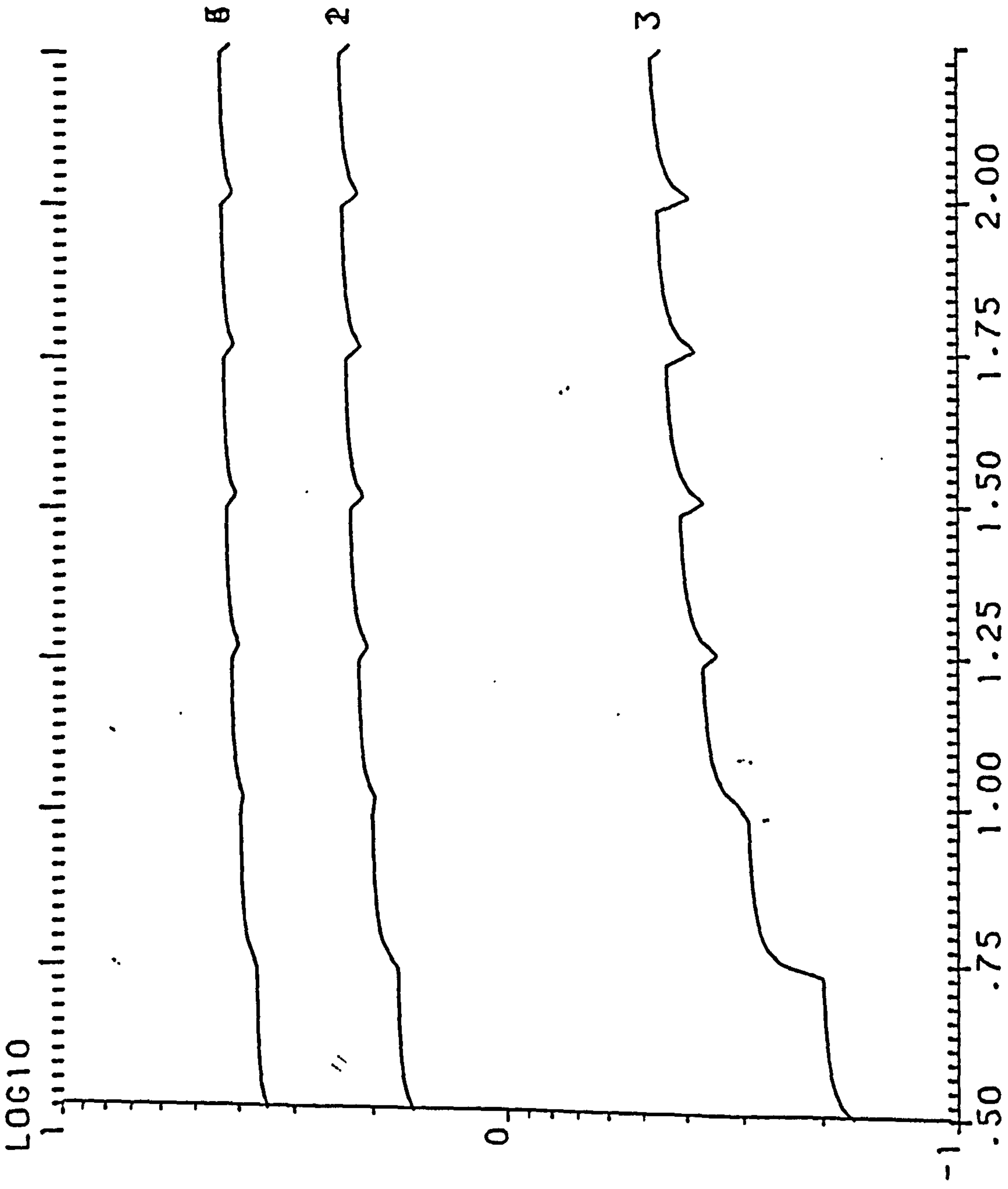

S. EFFICIENCY W. THICKNESS= .12M W. ORIENTATION= 67.50

WD= 4M HD1= 4M HD2= 4M HOUSE T.=2.0 ST.



LOG10  
1

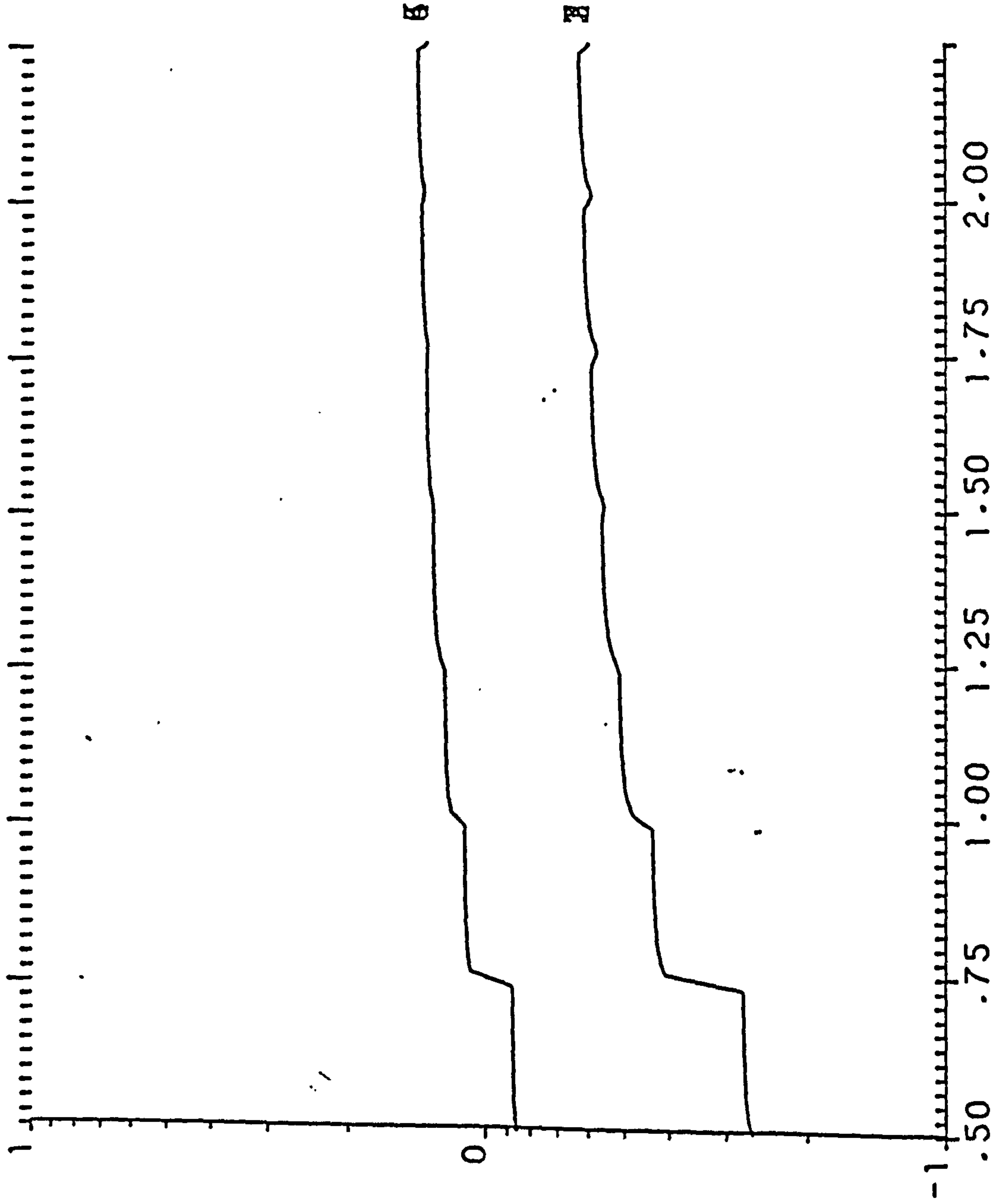

S. EFFICIENCY W. THICKNESS= .12M W. ORIENTATION= 90.00

WD= 4M HD1= 4M HD2= 4M HOUSE T.=2.0 ST.

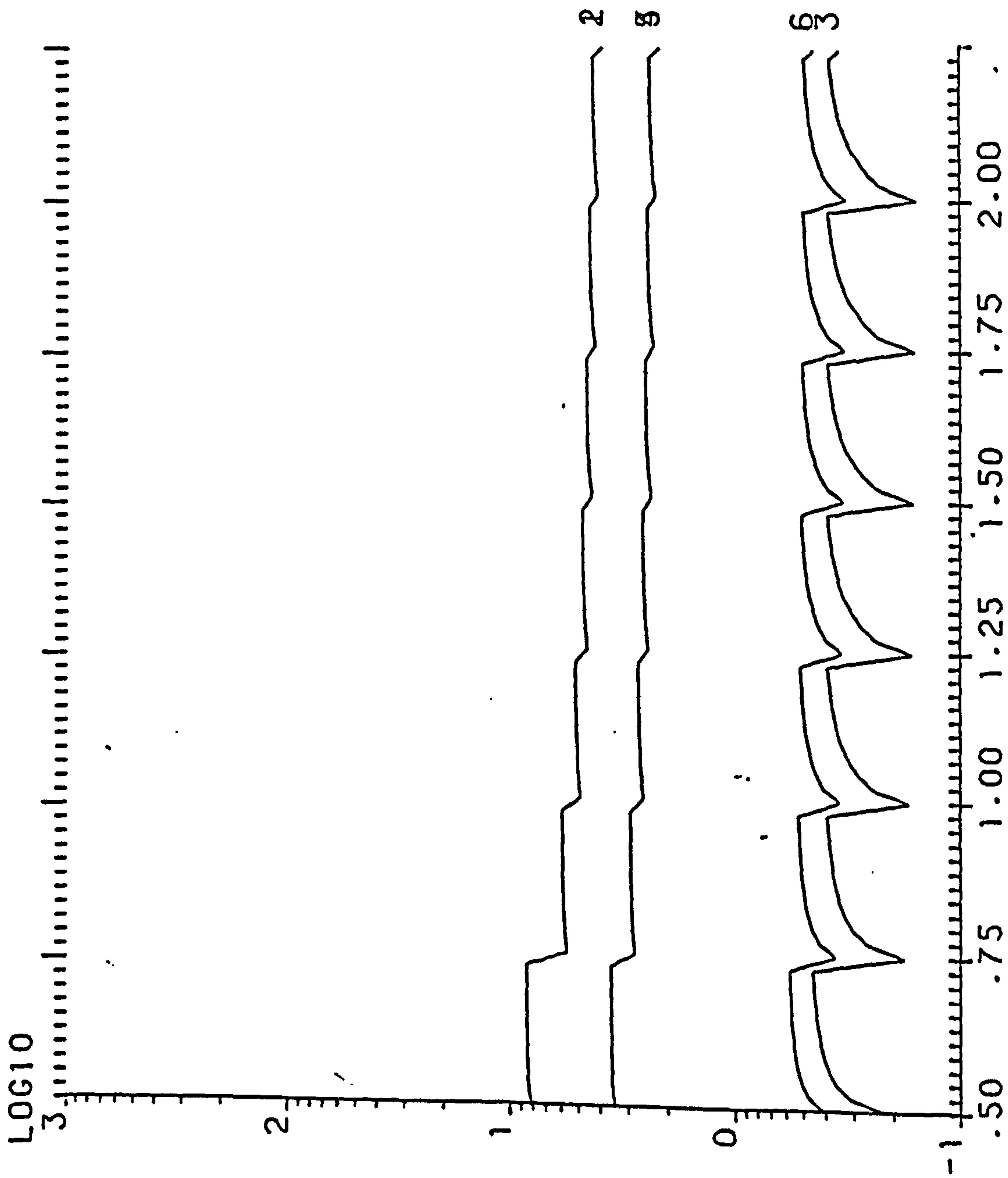

Y. EFFICIENCY W. THICKNESS= .12M W. ORIENTATION=112.50

WD= 4M HD1= 4M HD2= 4M HOUSE T.=2.0 ST.

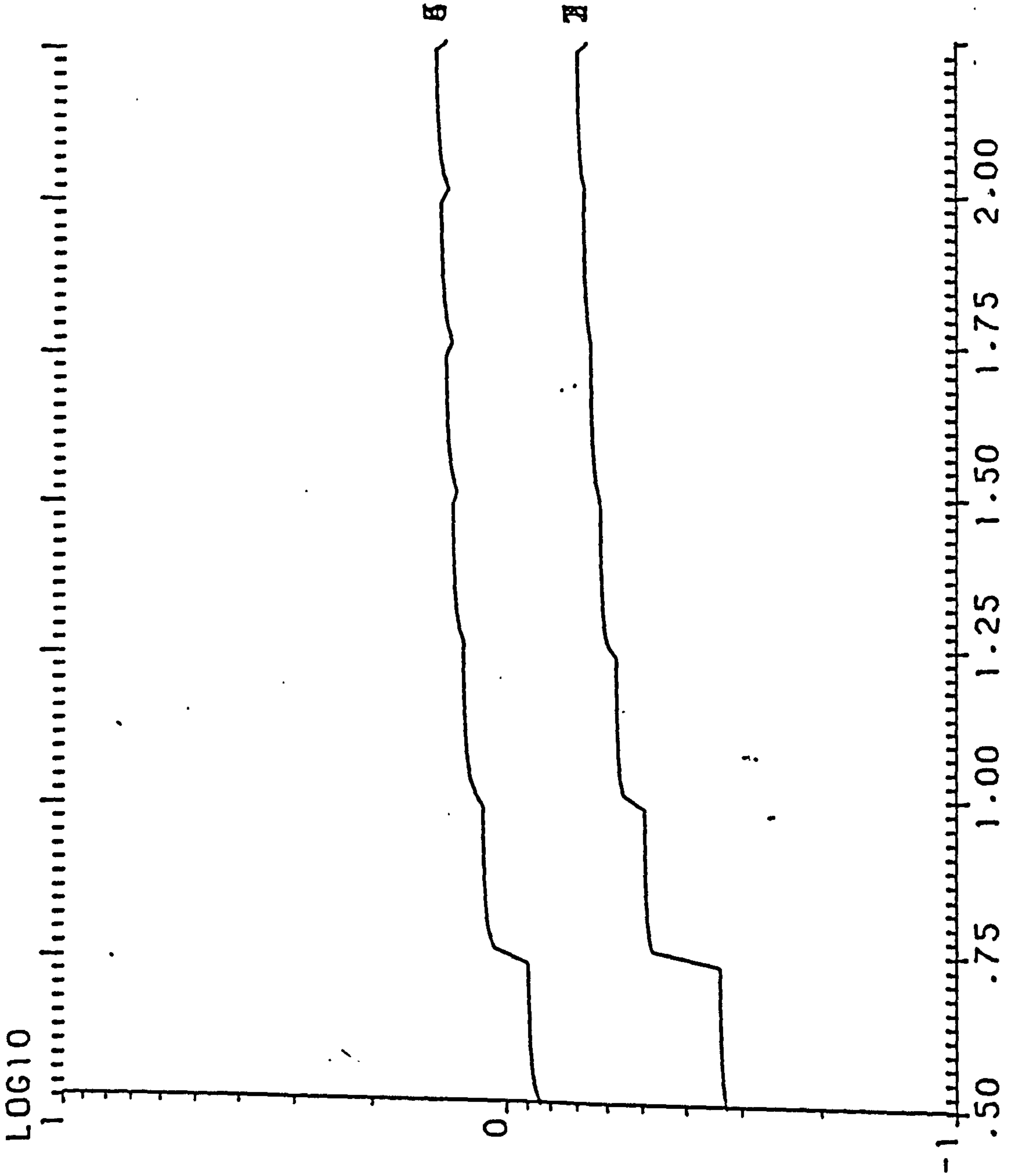

S. EFFICIENCY W. THICKNESS= .12M W. ORIENTATION=112.50  
 WD= 4M HD1= 4M HD2= 4M HOUSE T.=2.0 ST.

LOG10  
3

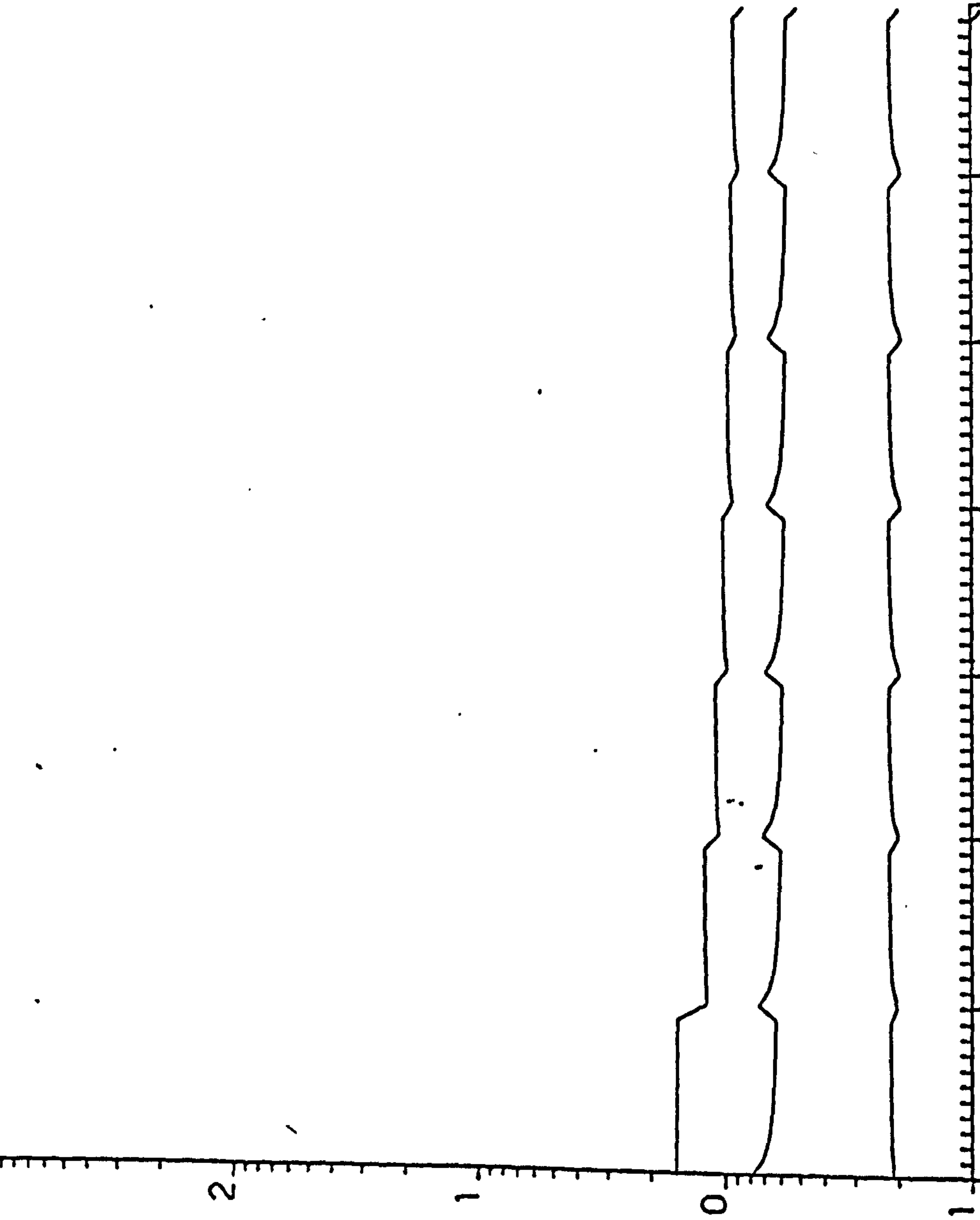

-1  
.50 .75 1.00 1.25 1.50 1.75 2.00 3

Y. EFFICIENCY W. THICKNESS= .12M W. ORIENTATION=135.00

WD= 4M HD1= 4M HD2= 4M HOUSE T.=2.0 ST.



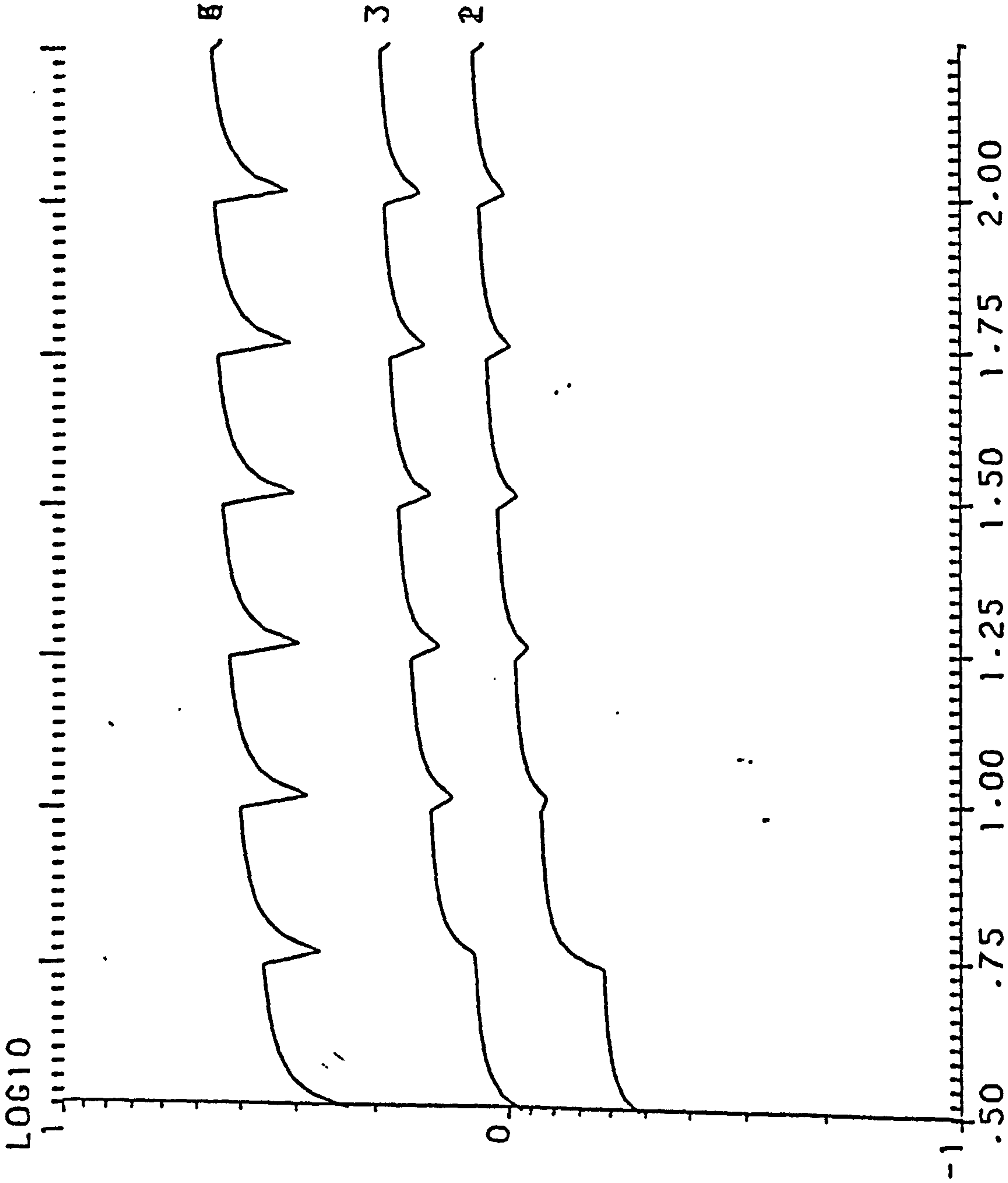

S. EFFICIENCY W. THICKNESS= .12M W. ORIENTATION=135.00

WD= 4M HD1= 4M HD2= 4M HOUSE T.=2.0 ST.

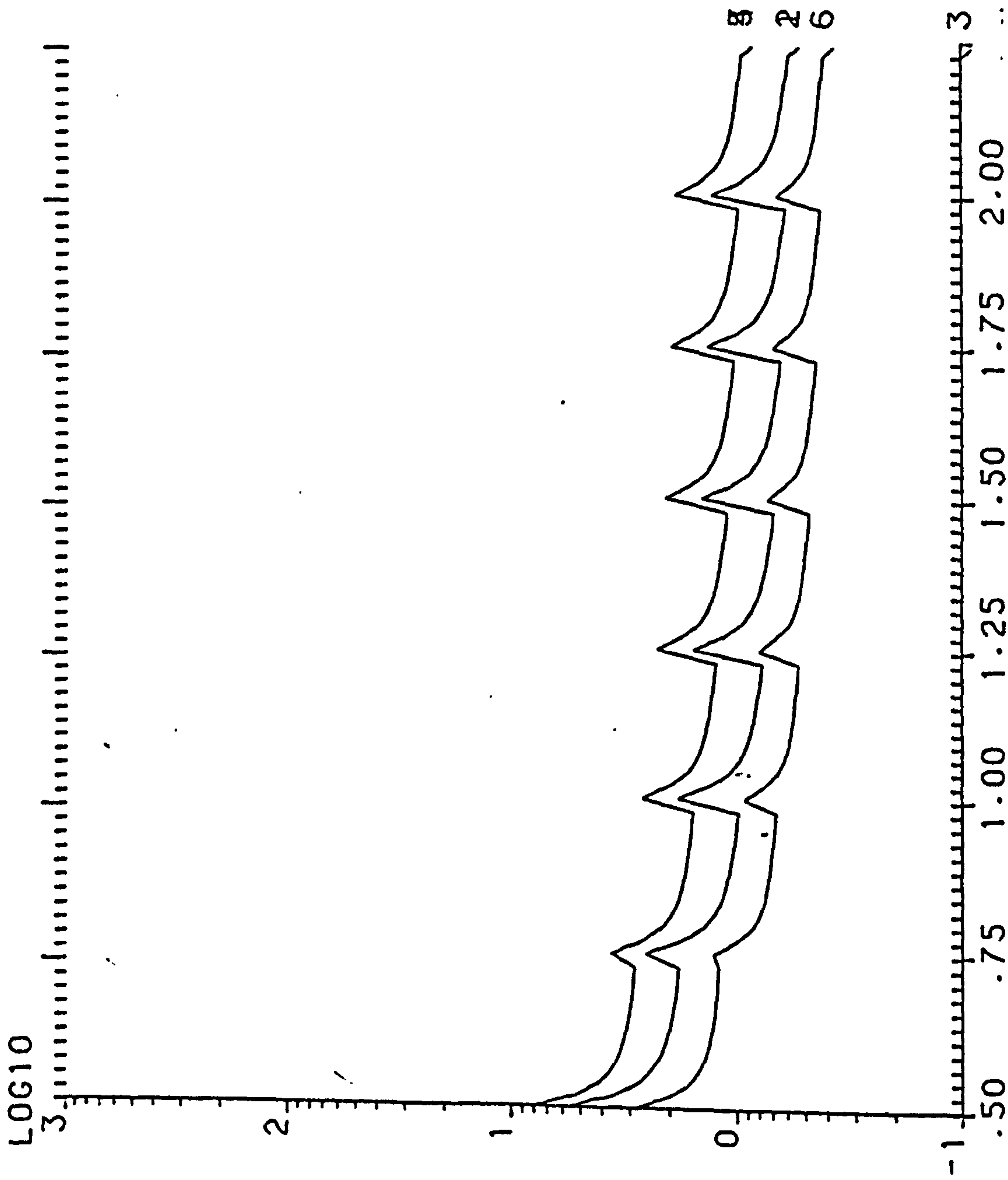

Y. EFFICIENCY W. THICKNESS= .12M W. ORIENTATION=157.50

WD= 4M HD1= 4M HD2= 4M HOUSE T.=2.0 ST.

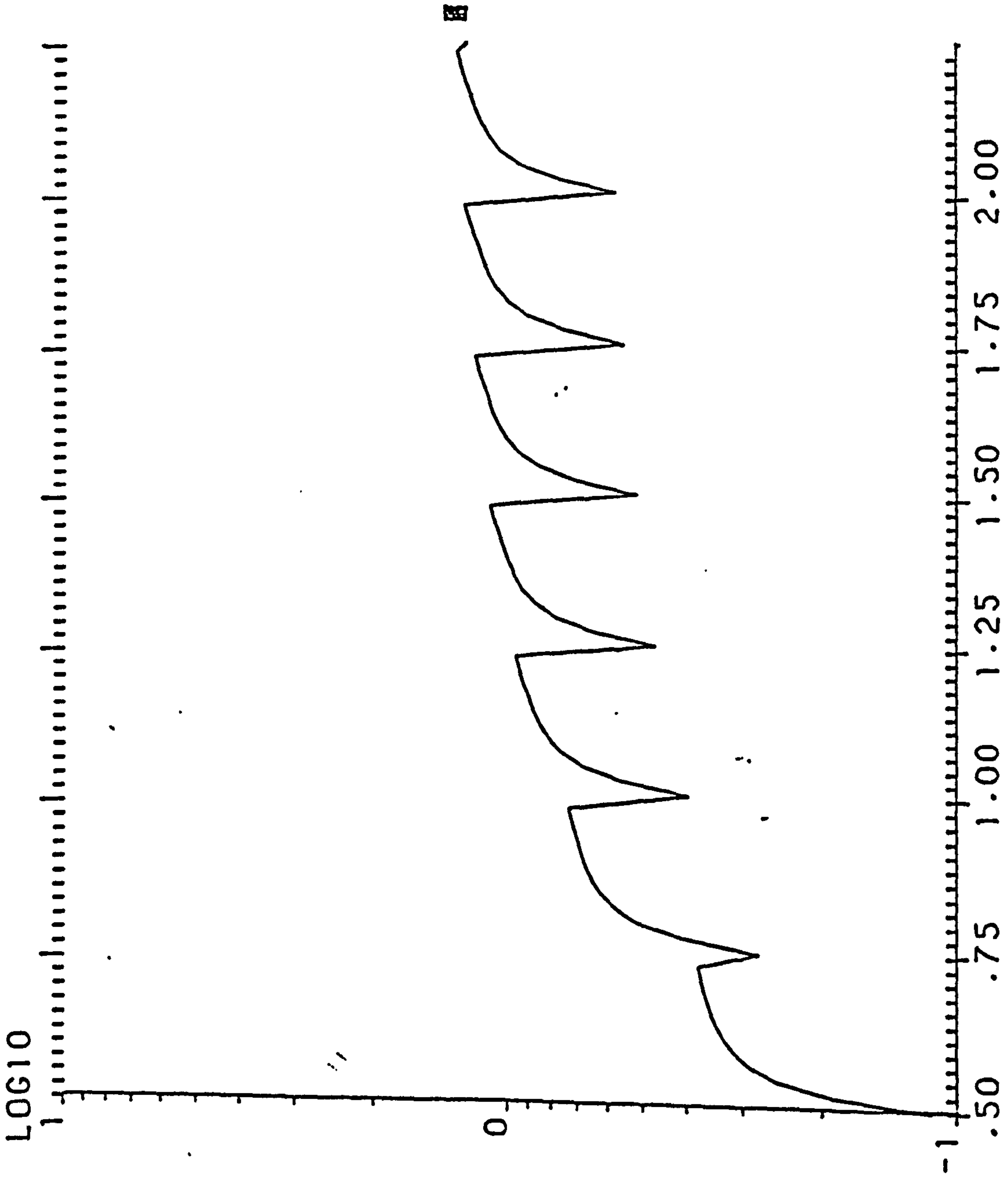

S. EFFICIENCY W. THICKNESS= .12M W. ORIENTATION=157.50

WD= 4M HD1= 4M HD2= 4M HOUSE T.=2.0 ST.



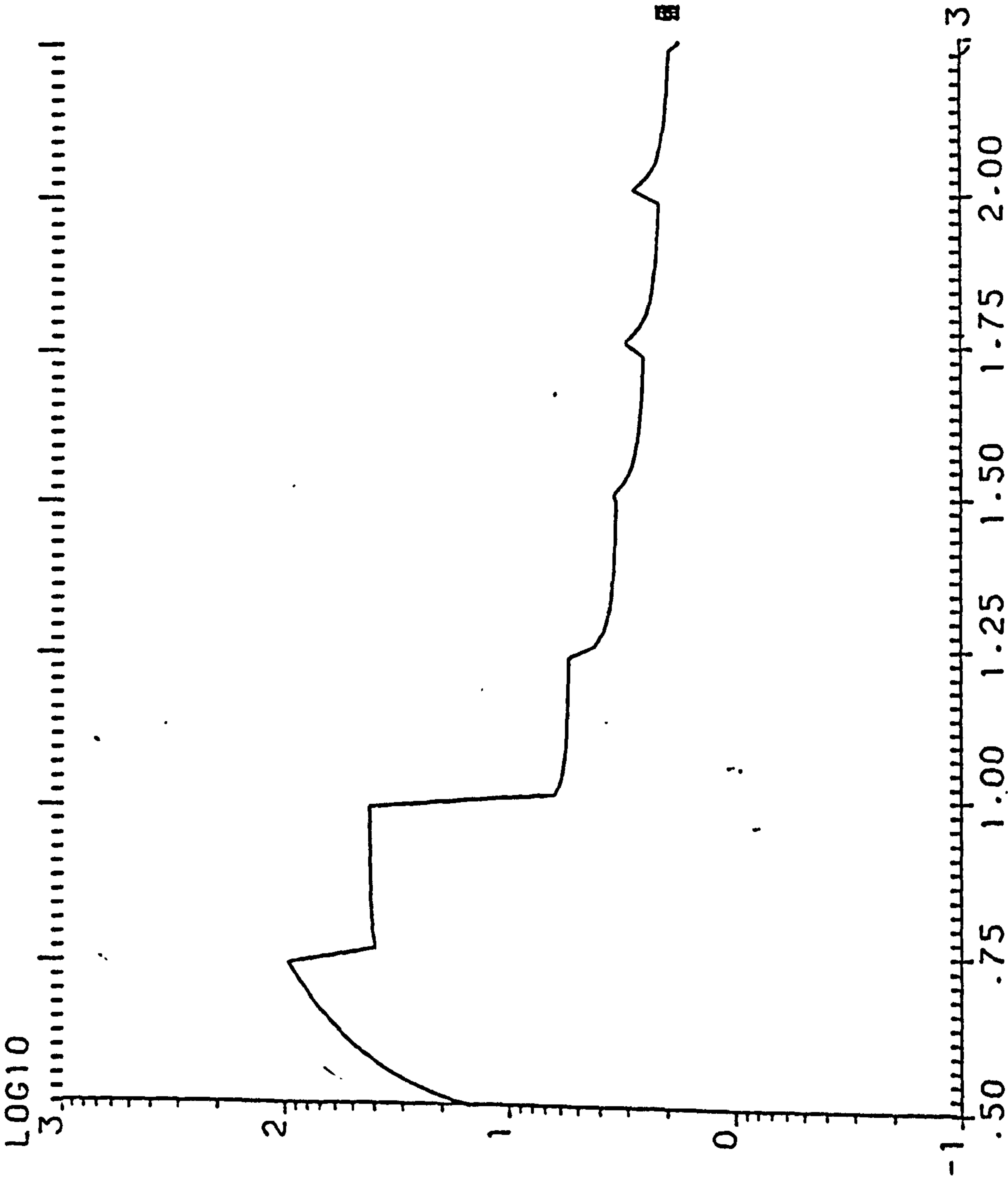

Y. EFFICIENCY W. THICKNESS= .12M W. ORIENTATION=180.00

WD= 4M HD1= 4M HD2= 4M HOUSE T.=2.0 ST.

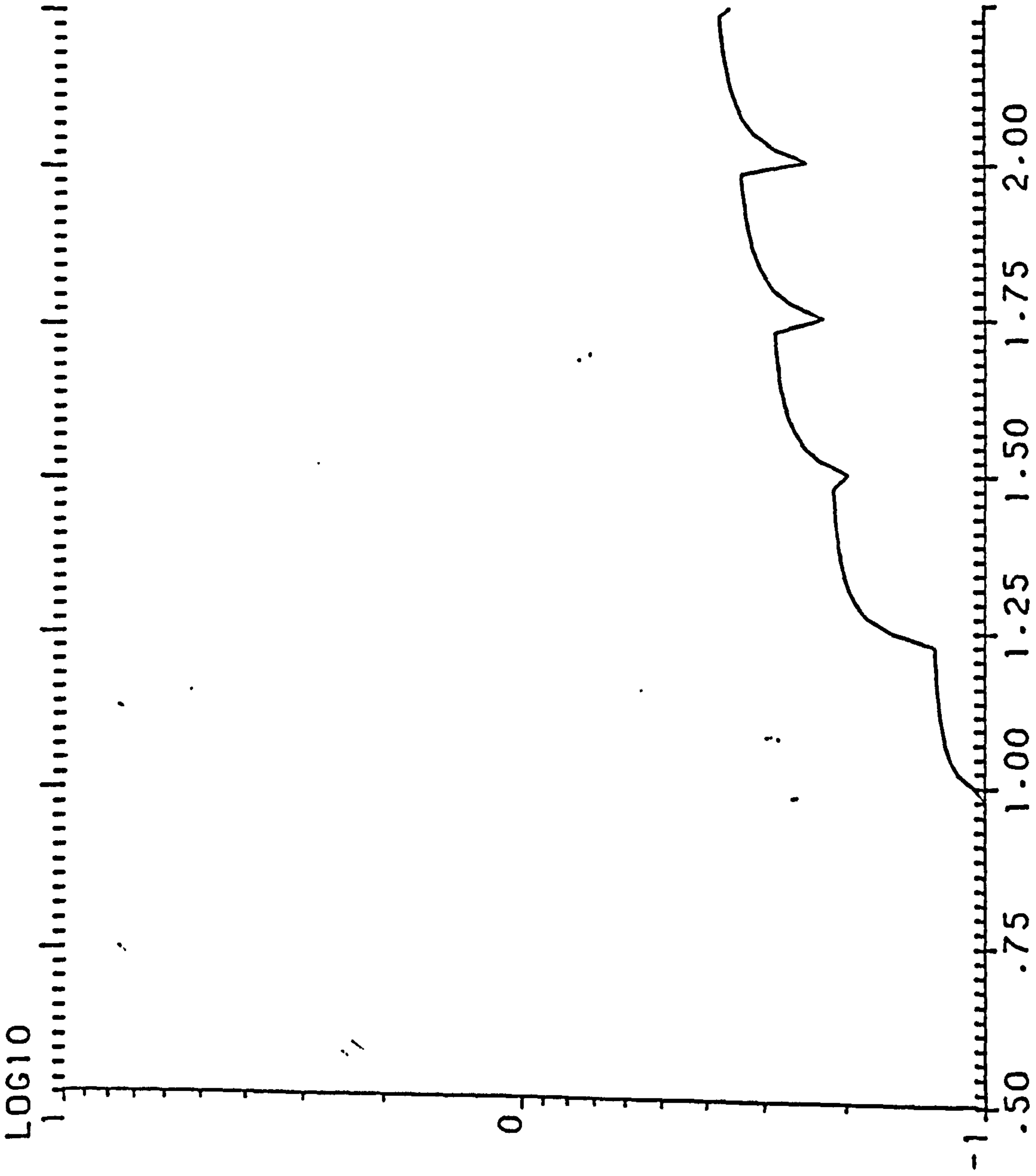

S. EFFICIENCY W. THICKNESS= .12M W. ORIENTATION=180.00

WD= 4M HD1= 4M HD2= 4M HOUSE T.=2.0 ST.



LOG10

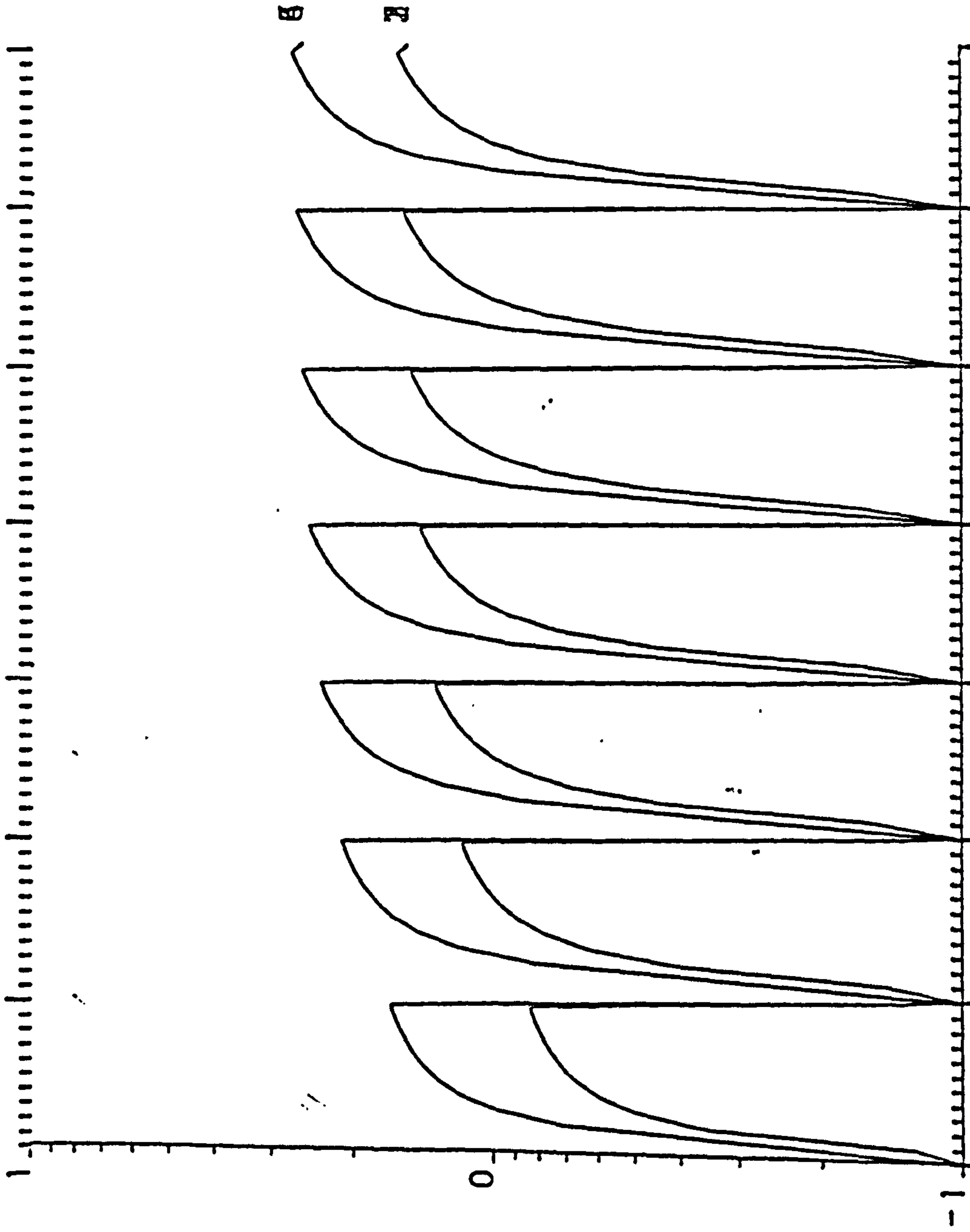

S. EFFICIENCY W. THICKNESS= .24M W. ORIENTATION= .00

WD= 4M HD1= 4M HD2= 4M HOUSE T.=2.0 ST.

LOG10  
1  
0  
-1

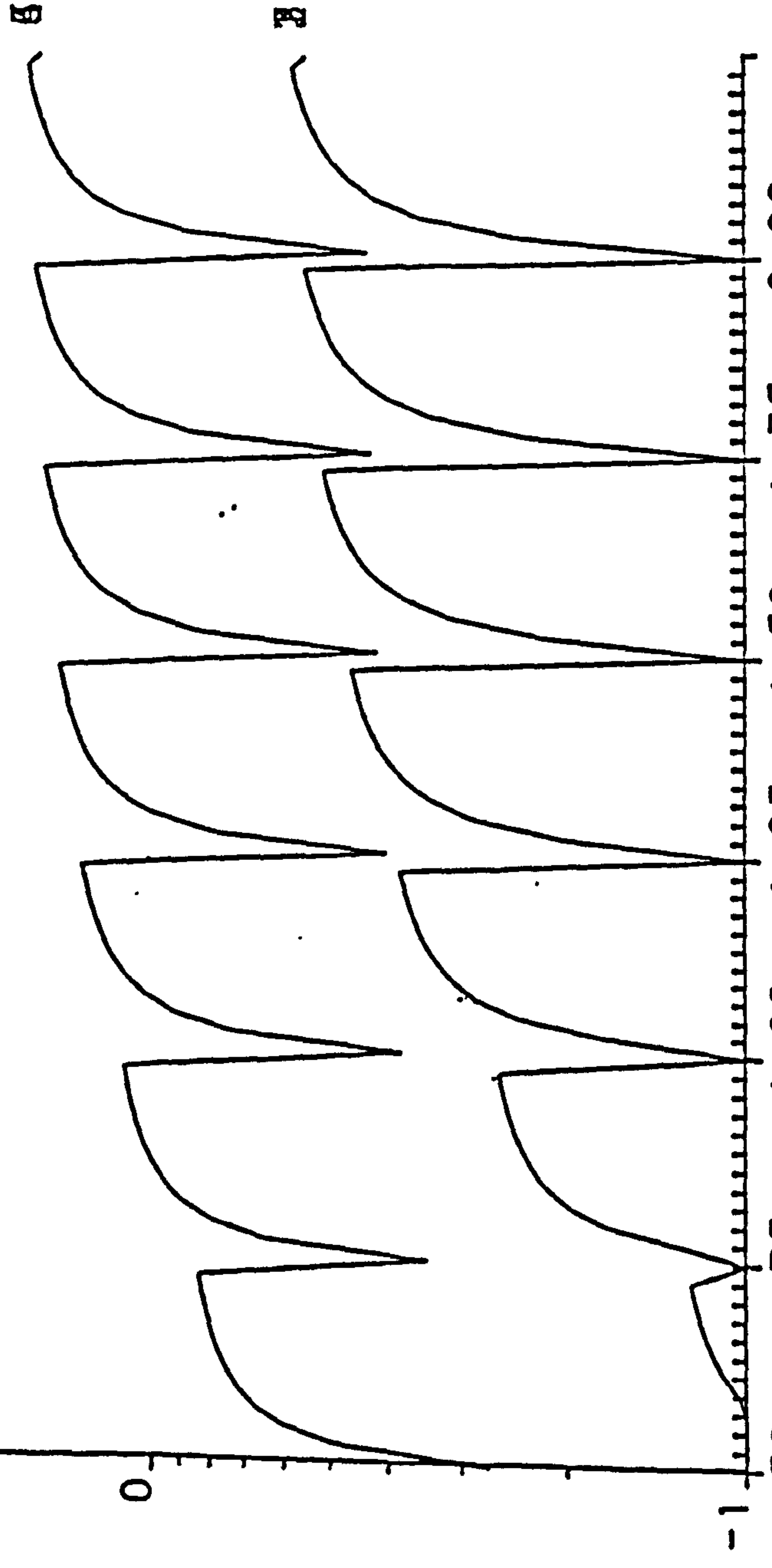

S. EFFICIENCY W. THICKNESS= .24M W. ORIENTATION= 22.50

WD= 4M HD1= 4M HD2= 4M HOUSE T.=2.0 ST.

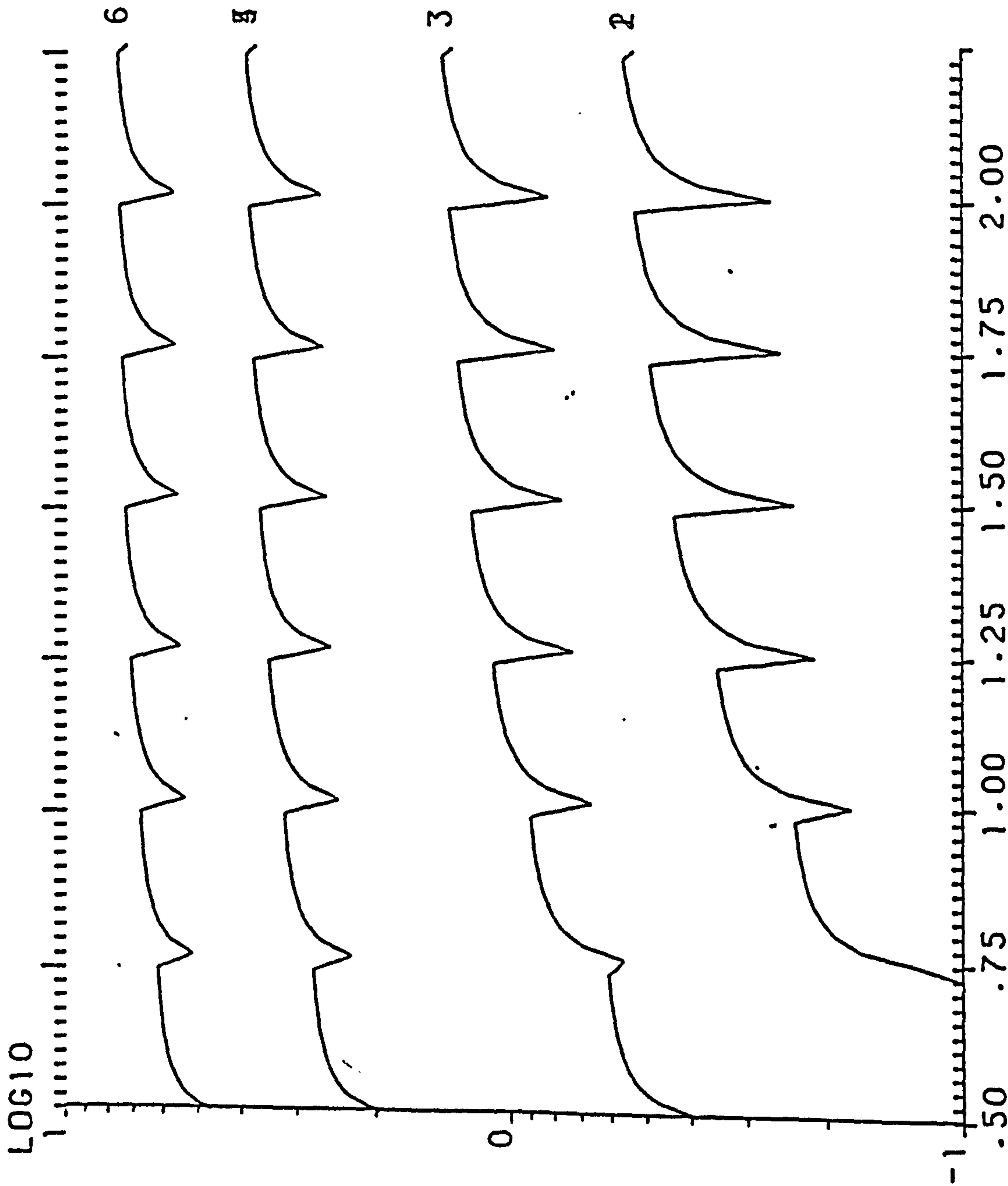

S. EFFICIENCY W. THICKNESS= .24M HD2= 4M HOUSE T.=2.0 ST.  
 W. ORIENTATION= 45.00



WD= 4M HD1= 4M HD2= 4M HOUSE T.=2.0 ST.

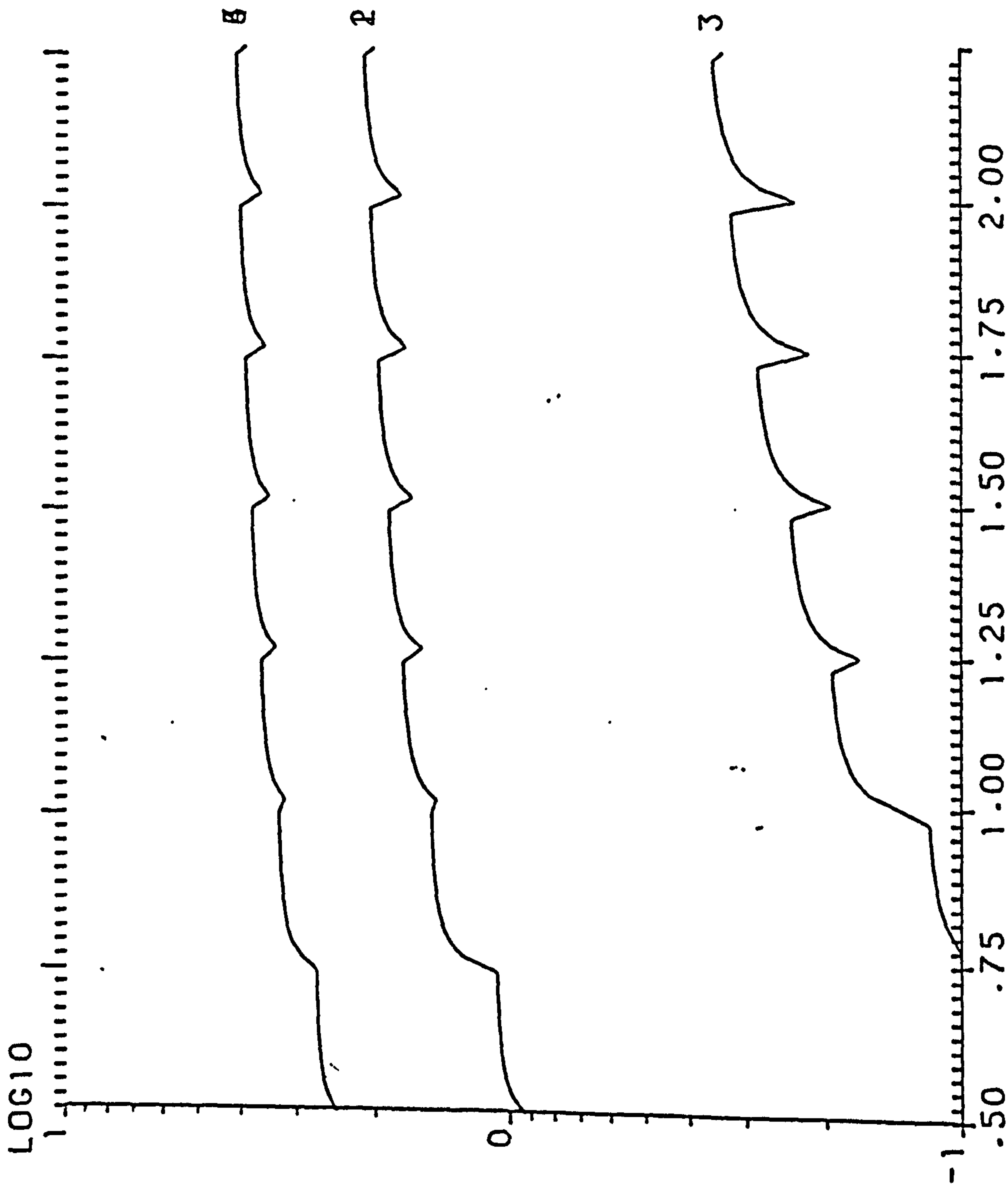

S. EFFICIENCY W. THICKNESS= .24M W. ORIENTATION= 67.50  
 WD= 4M HD1= 4M HD2= 4M HOUSE T.=2.0 ST.

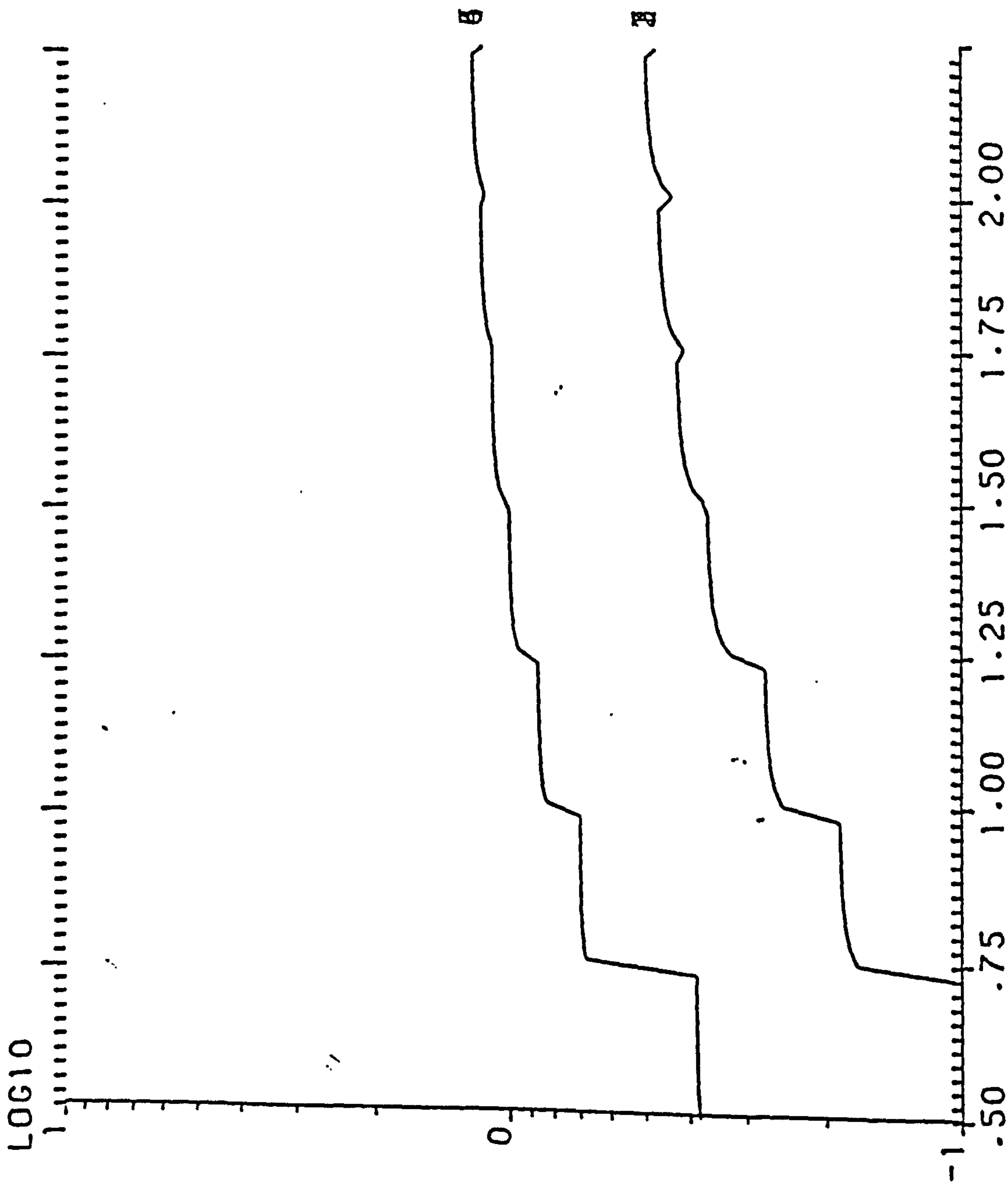

S. EFFICIENCY W. THICKNESS= .24M W. ORIENTATION= 90.00  
 WD= 4M HD1= 4M HD2= 4M HOUSE T.=2.0 ST.



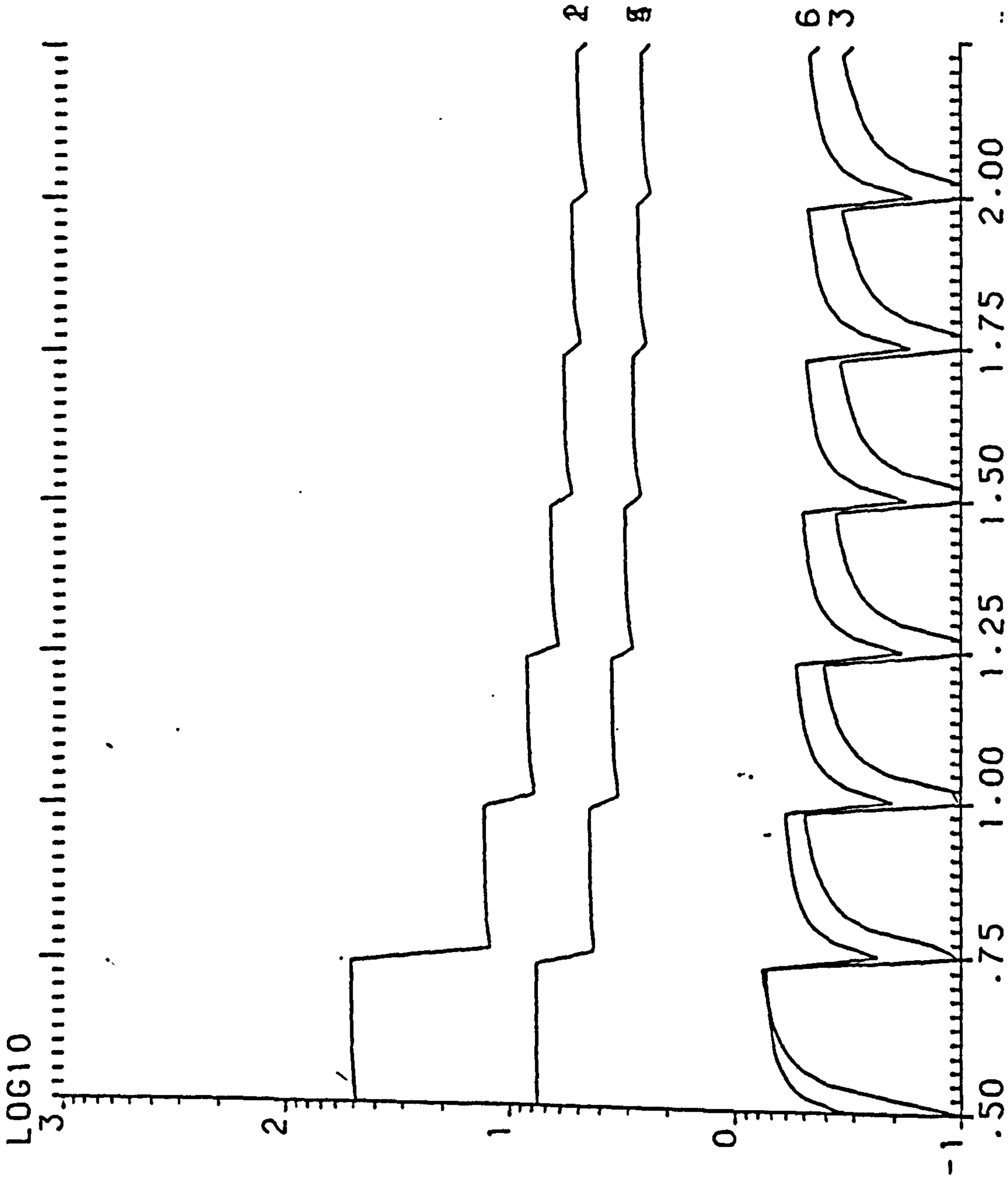

Y- EFFICIENCY W. THICKNESS= .24M W. ORIENTATION=112.50

WD= 4M HD1= 4M HD2= 4M HOUSE T.=2.0 ST.

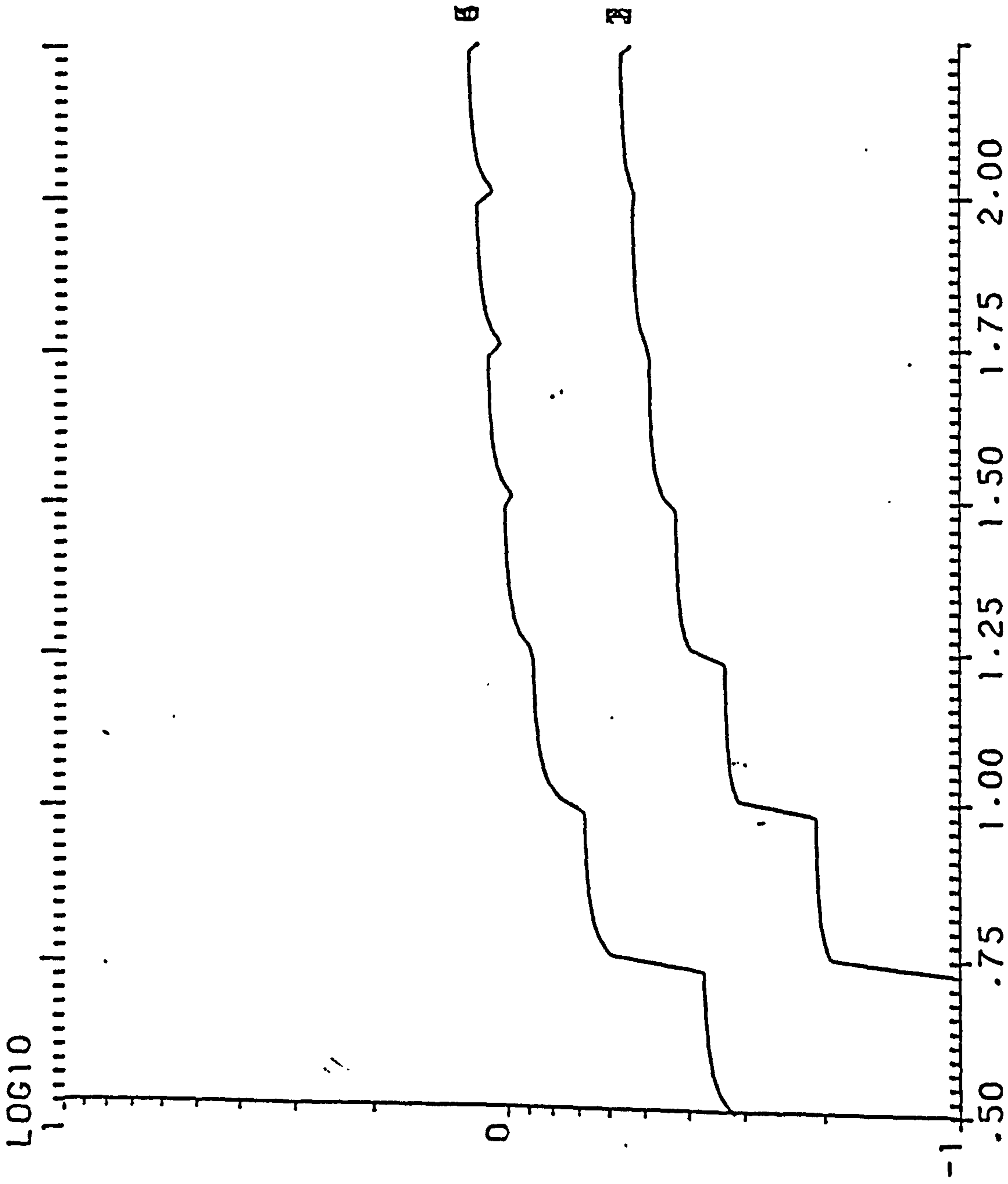

S. EFFICIENCY W. THICKNESS= .24M HD2= 4M HOUSE T.=2.0 ST.  
 W. ORIENTATION=112.50

WD= 4M HD1= 4M

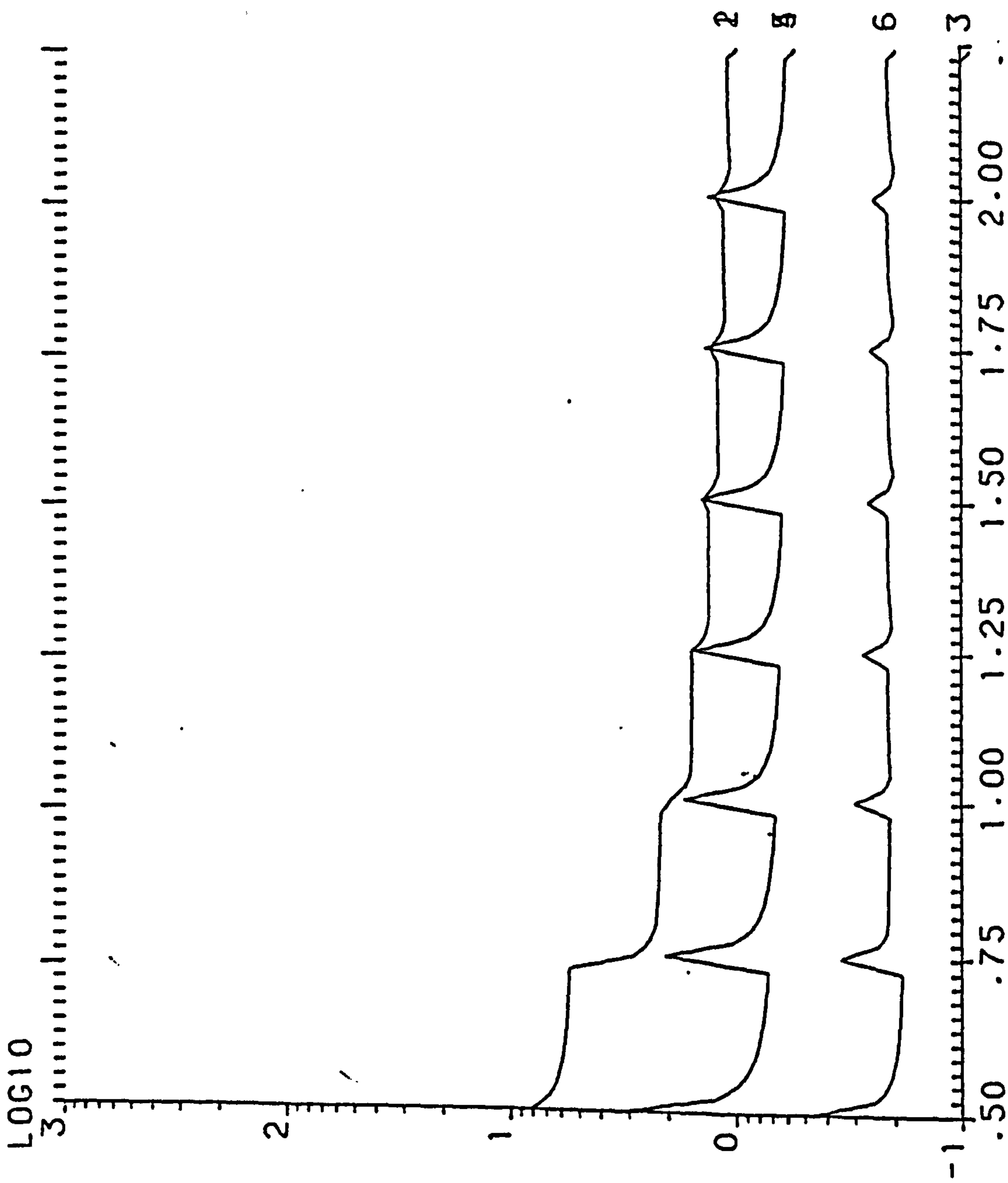

Y. EFFICIENCY W. THICKNESS= .24M W. ORIENTATION=135.00

WD= 4M HD1= 4M HD2= 4M HOUSE T.=2.0 ST.

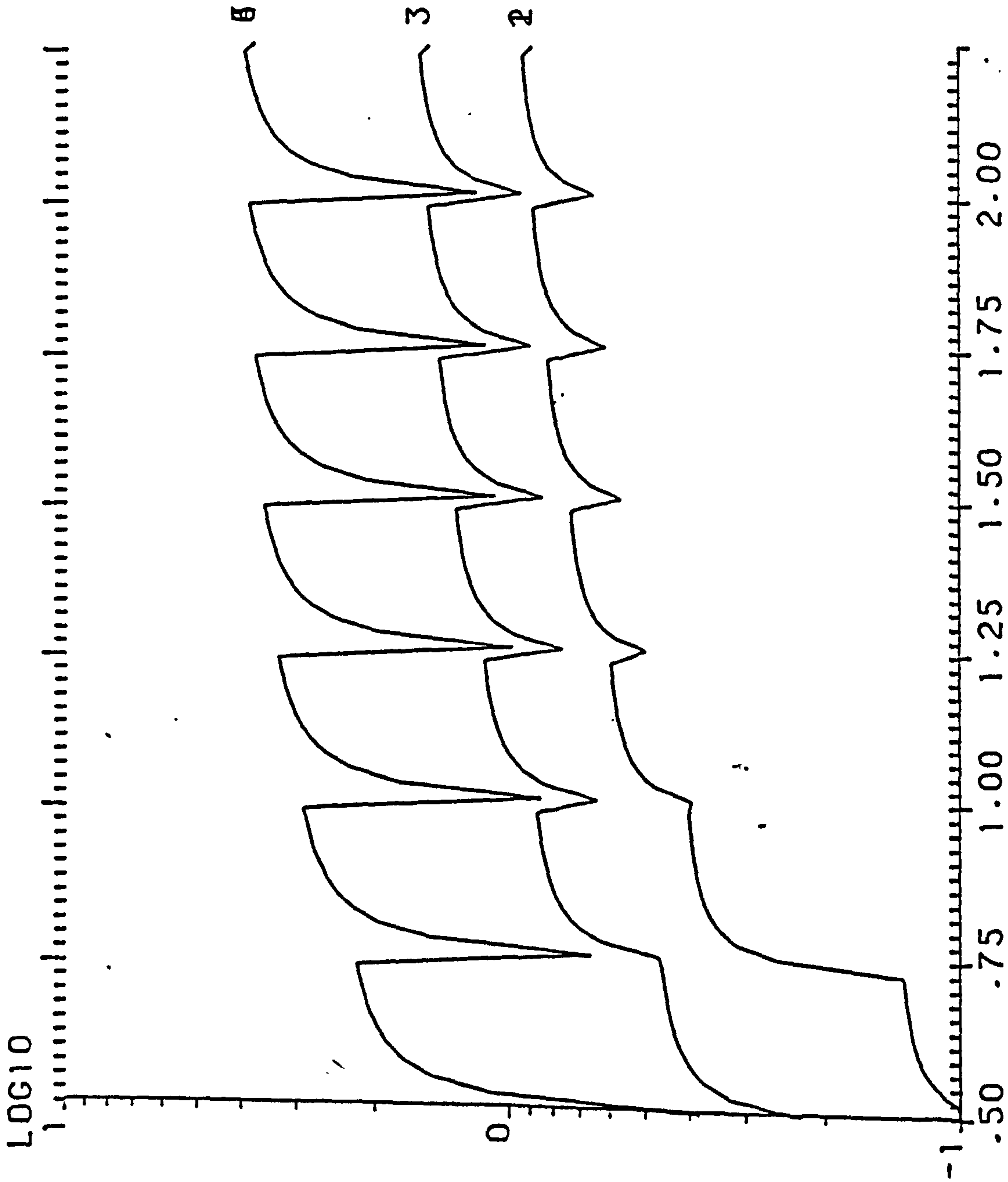

S. EFFICIENCY W. THICKNESS= .24M HD2= 4M HOUSE T.=2.0 ST.  
 W. ORIENTATION=135.00

WD= 4M HD1= 4M



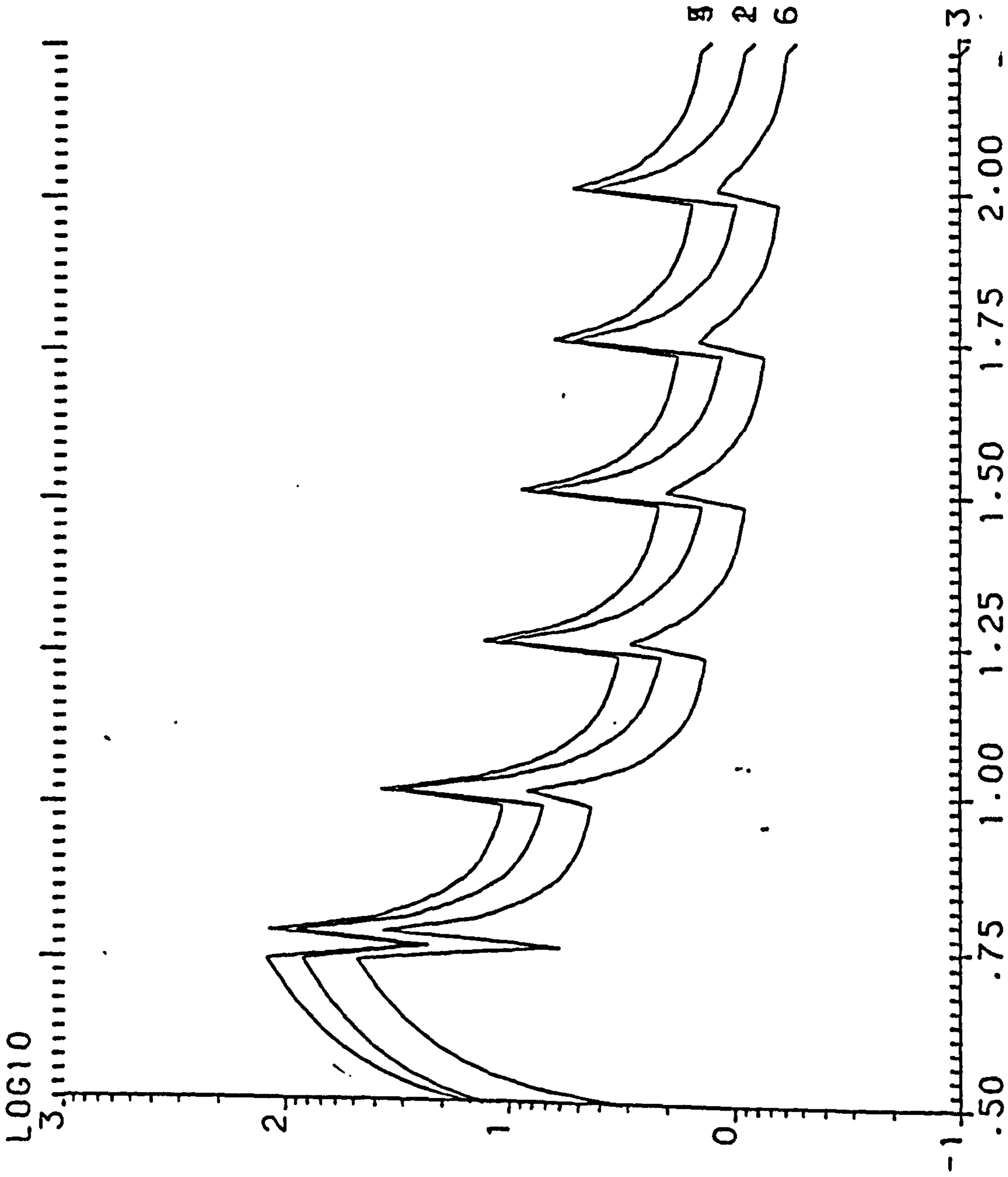

Y. EFFICIENCY W. THICKNESS= .24M W. ORIENTATION=157.50

WD= 4M HD1= 4M HD2= 4M HOUSE T.=2.0 ST.



LOG10

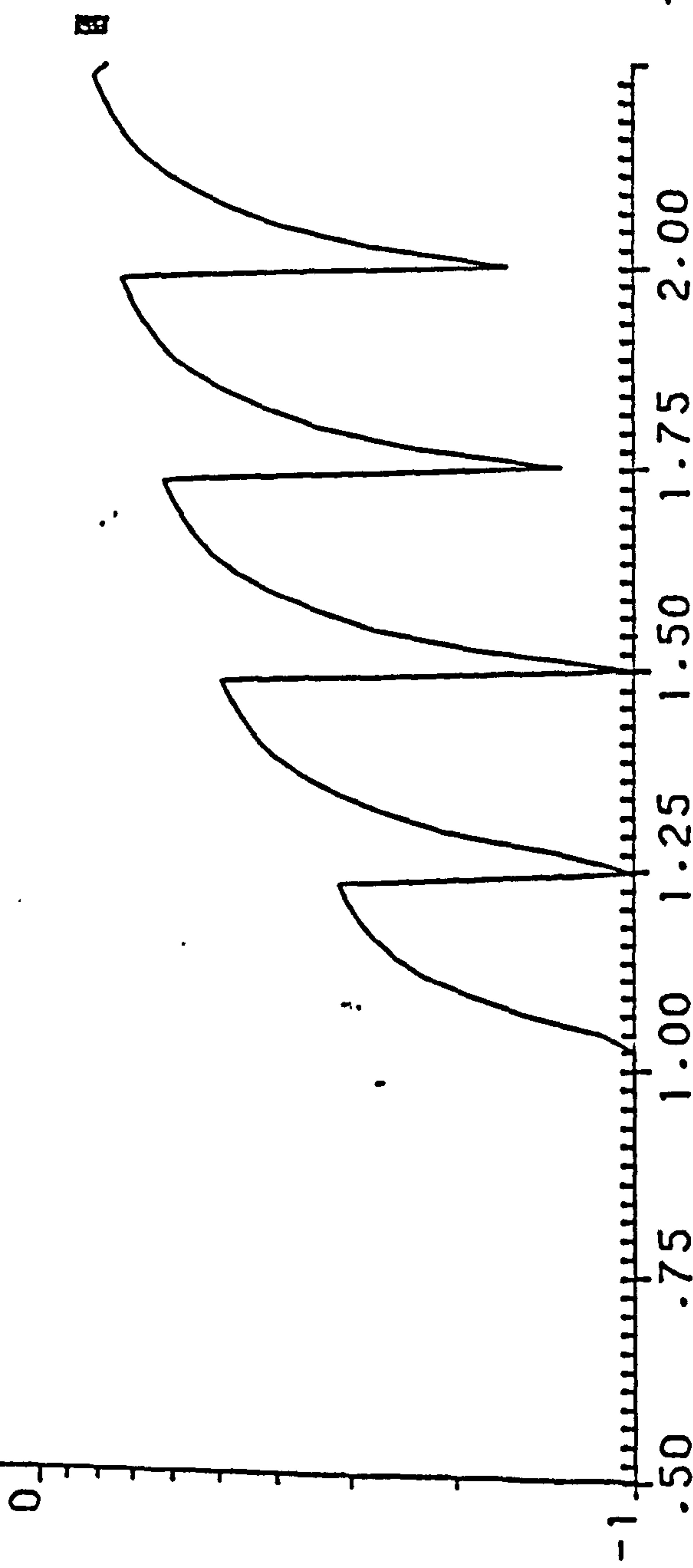

S. EFFICIENCY W. THICKNESS= .24M W. ORIENTATION=157.50

WD= 4M HD1= 4M HD2= 4M HOUSE T.=2.0 ST.

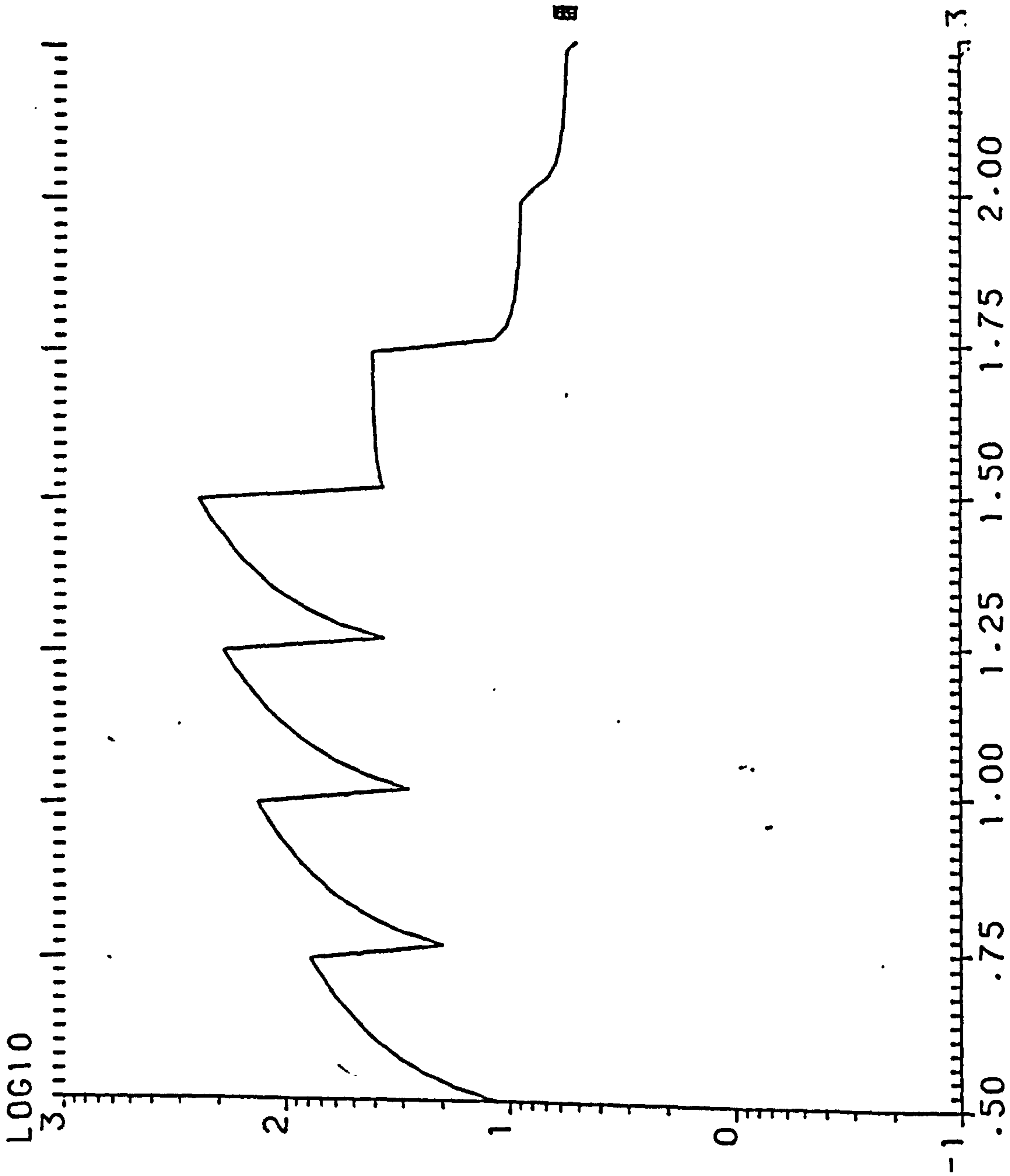

Y. EFFICIENCY W. THICKNESS= .24M W. ORIENTATION=180.00  
WD= 4M HD1= 4M HD2= 4M HOUSE T.=2.0 ST.

LOG10  
1

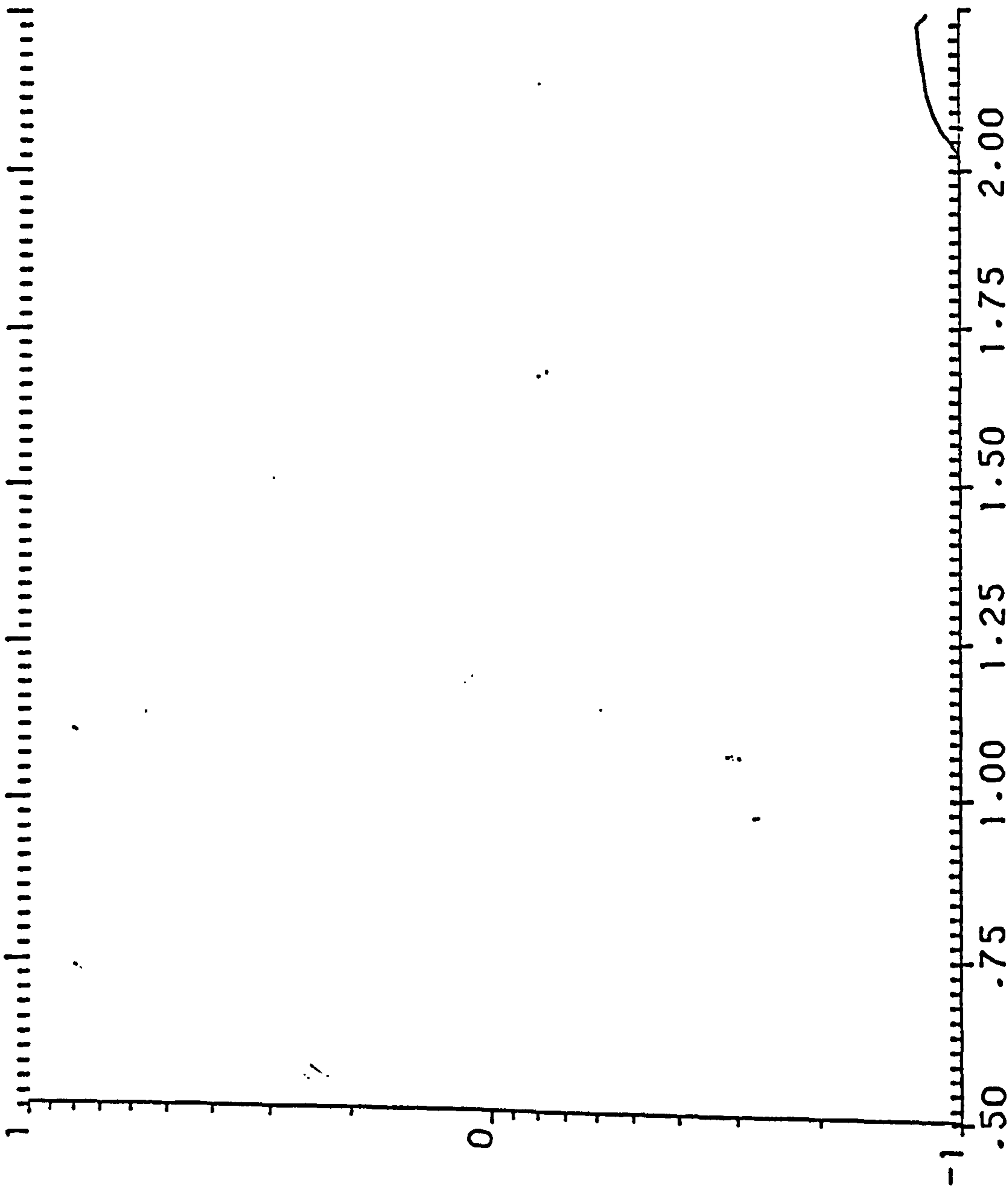

S. EFFICIENCY W. THICKNESS= .24M W. ORIENTATION=180.00

WD= 4M HD1= 4M HD2= 4M HOUSE T.=2.0 ST.

LOG10

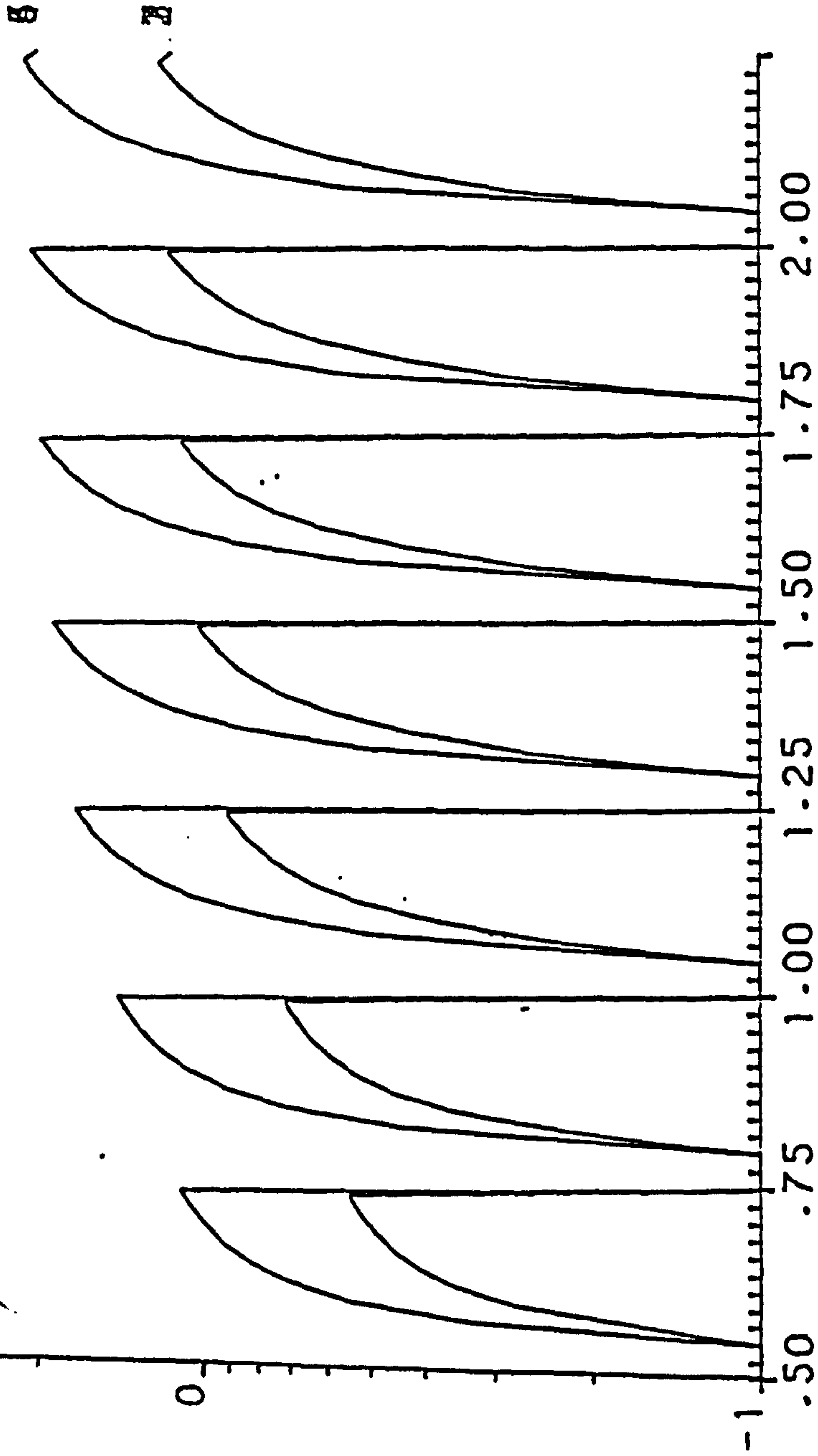

S. EFFICIENCY W. THICKNESS= .36M W. ORIENTATION= .00

WD= 4M HD1= 4M HD2= 4M HOUSE T.=2.0 ST.

LOG10  
1  
0  
-1

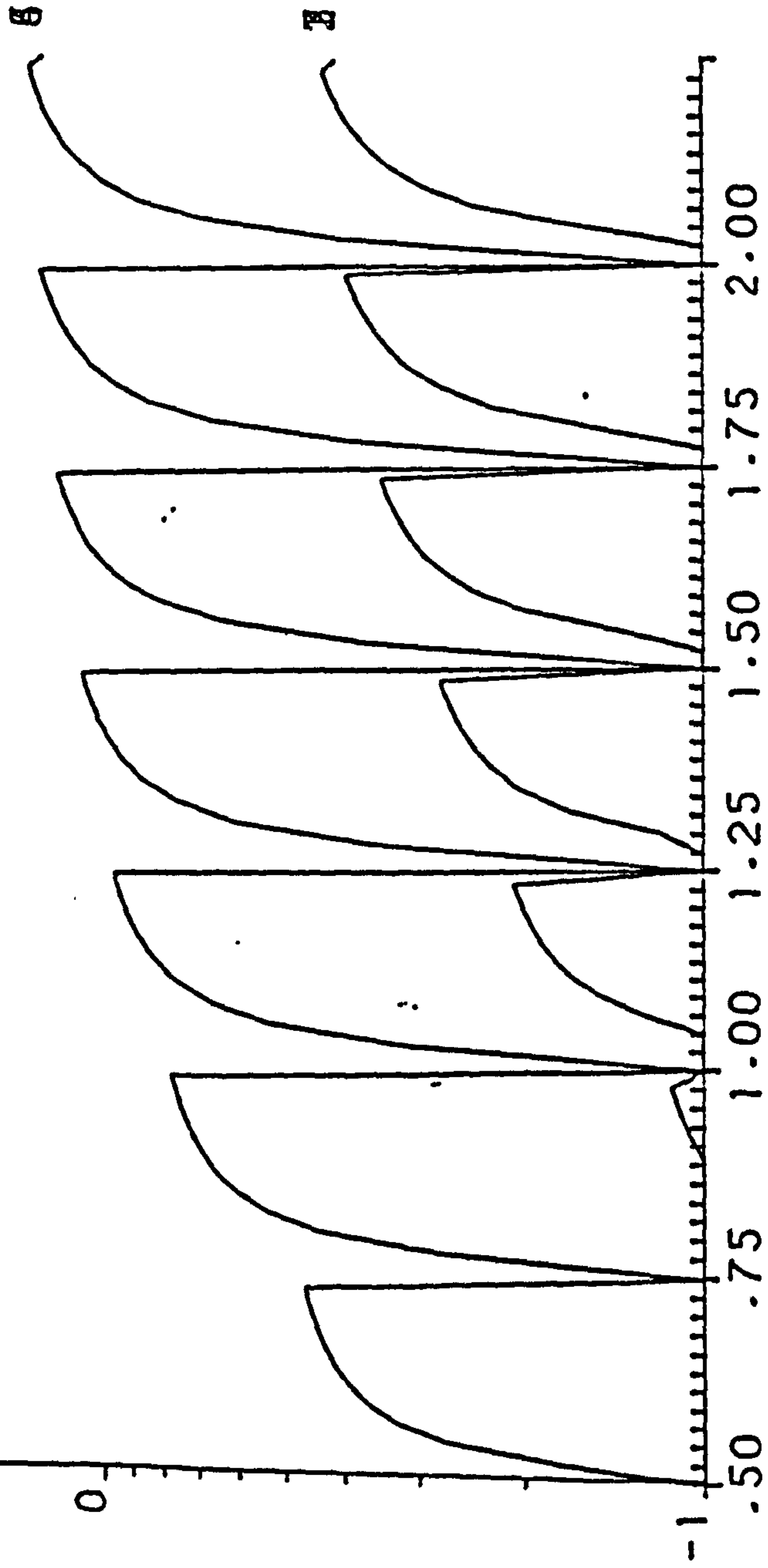

S. EFFICIENCY W. THICKNESS= .36M W. ORIENTATION= 22.50

WD= 4M HD1= 4M HD2= 4M HOUSE T.=2.0 ST.



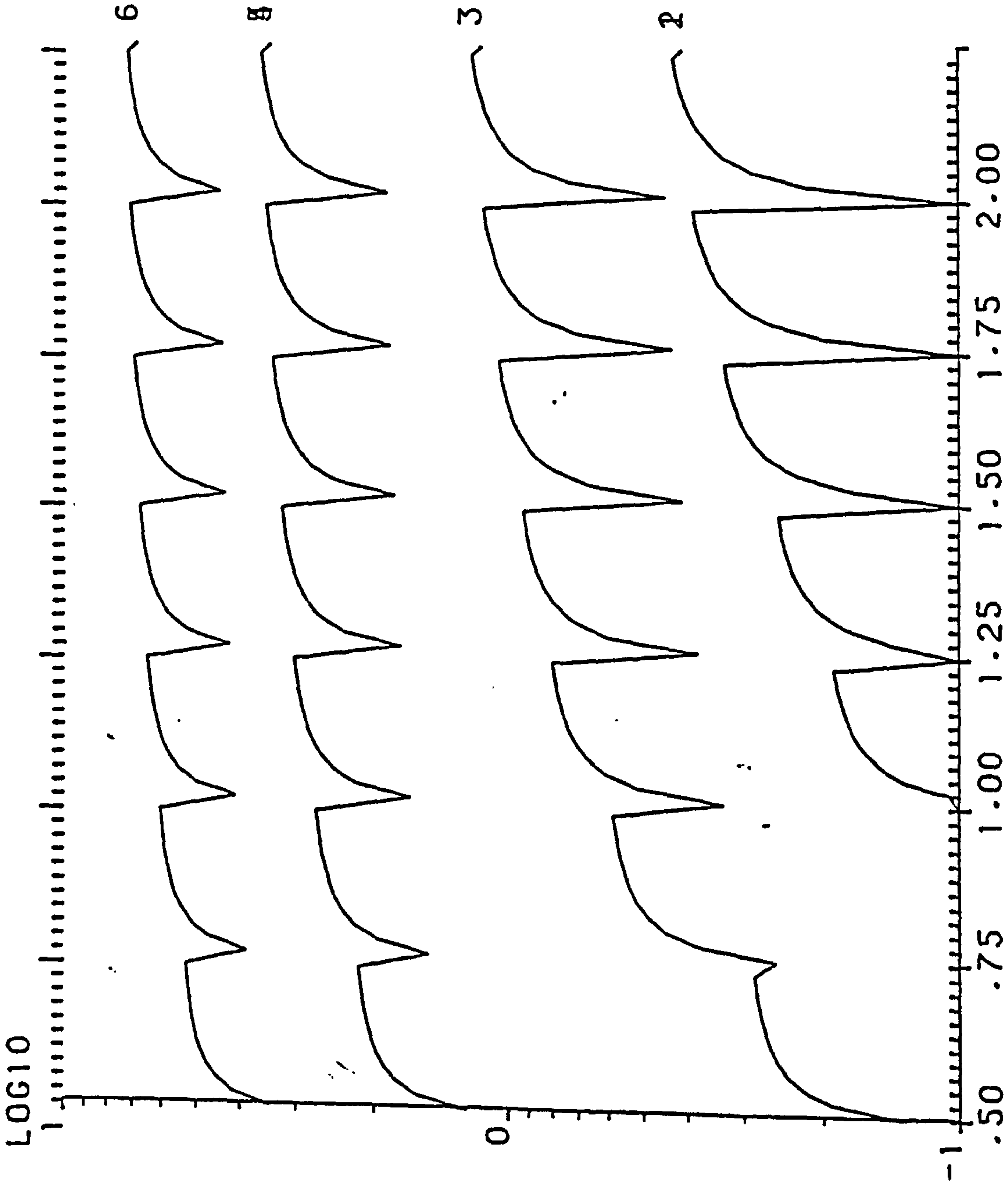

S. EFFICIENCY W. THICKNESS= .36M W. ORIENTATION= 45.00  
 WD= 4M HD1= 4M HD2= 4M HOUSE T.=2.0 ST.

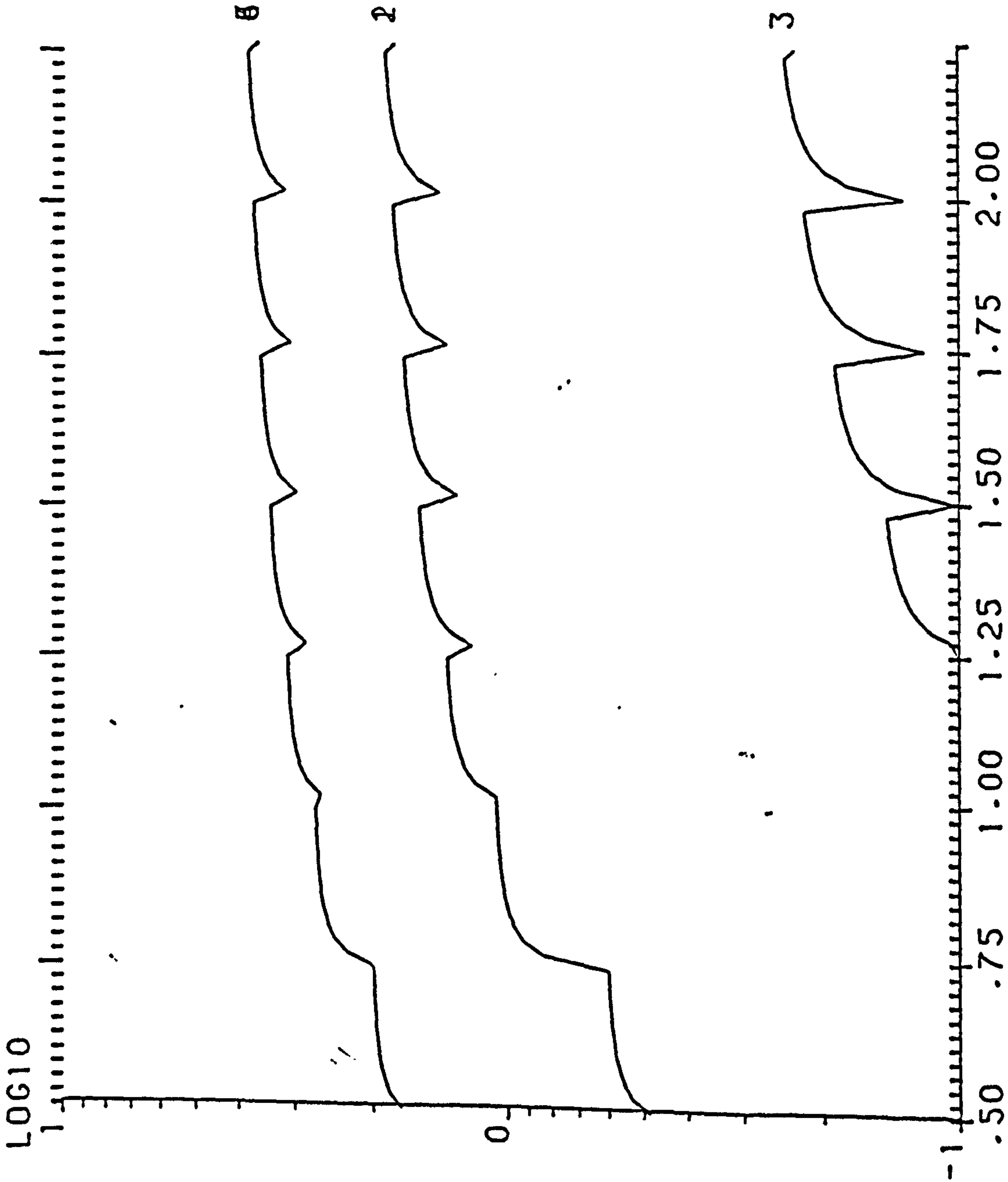

S. EFFICIENCY W. THICKNESS= .36M W. ORIENTATION= 67.50

WD= 4M HD1= 4M HD2= 4M HOUSE T.=2.0 ST.

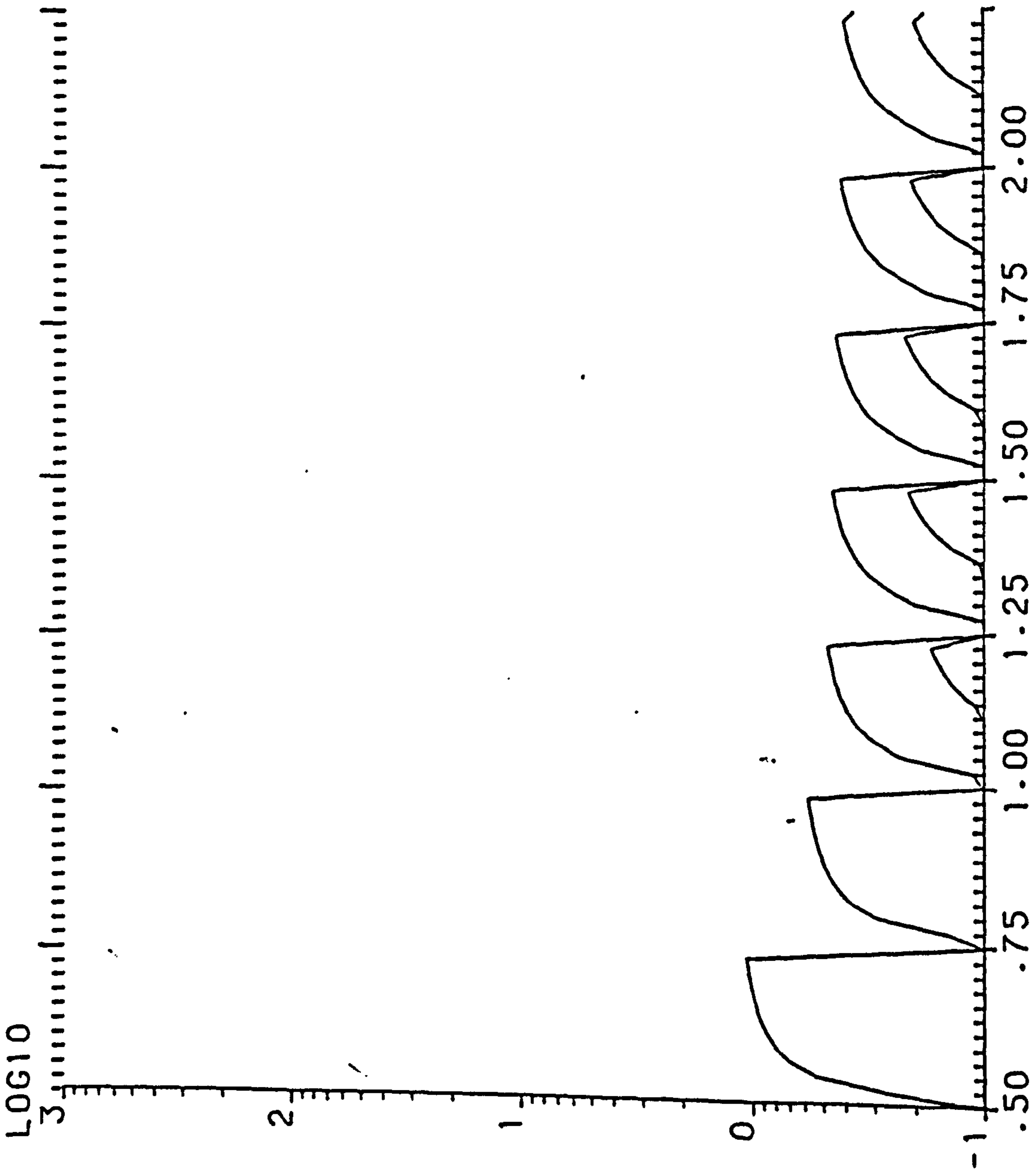

Y. EFFICIENCY W. THICKNESS= .36M W. ORIENTATION= 90.00  
WD= 4M HD1= 4M HD2= 4M HOUSE T.=2.0 ST.

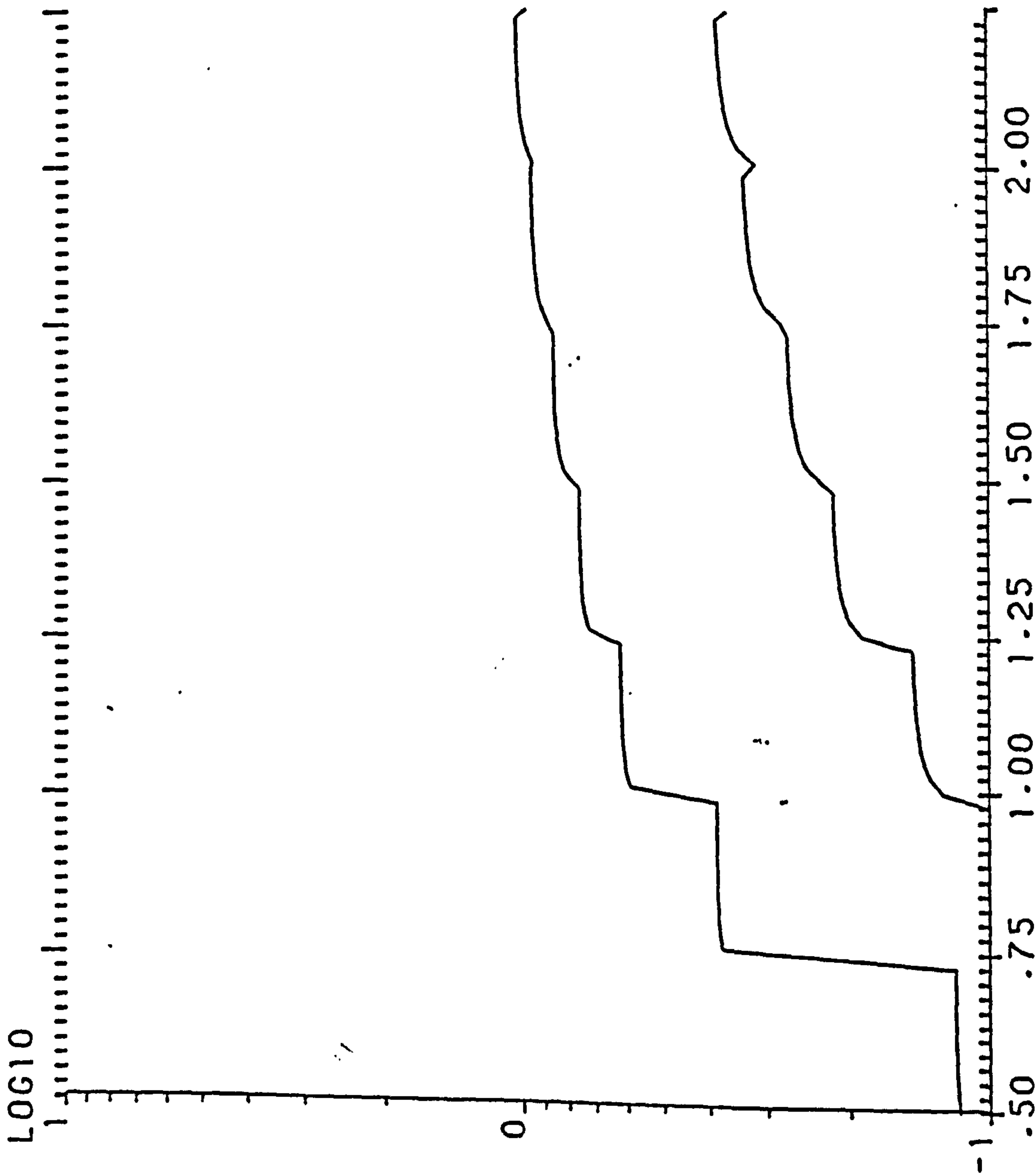

S. EFFICIENCY W. THICKNESS= .36M W. ORIENTATION= 90.00

WD= 4M HD1= 4M HD2= 4M HOUSE T.=2.0 ST.



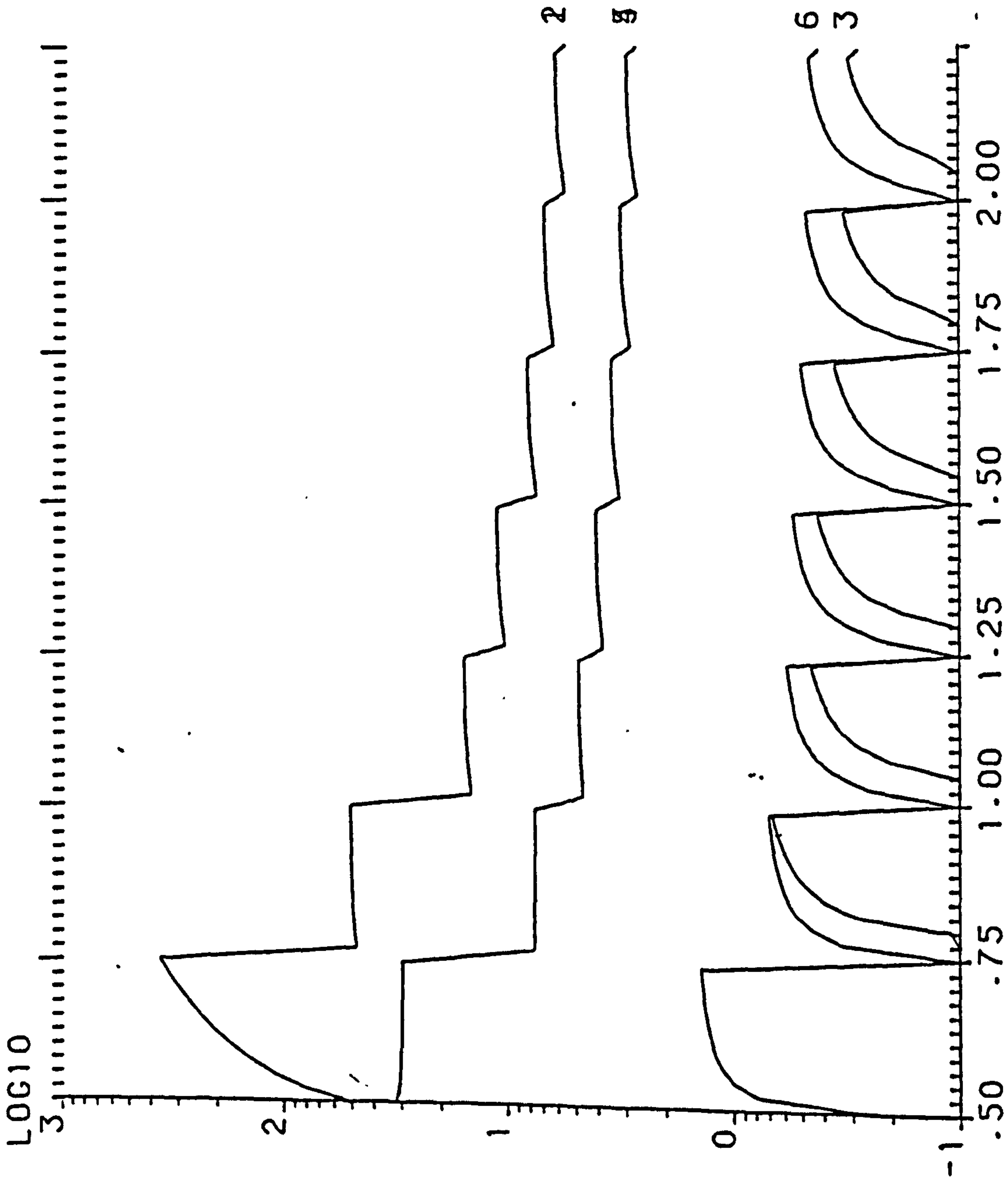

Y. EFFICIENCY W. THICKNESS= .36M W. ORIENTATION=112.50

WD= 4M HD1= 4M HD2= 4M HOUSE T.=2.0 ST.



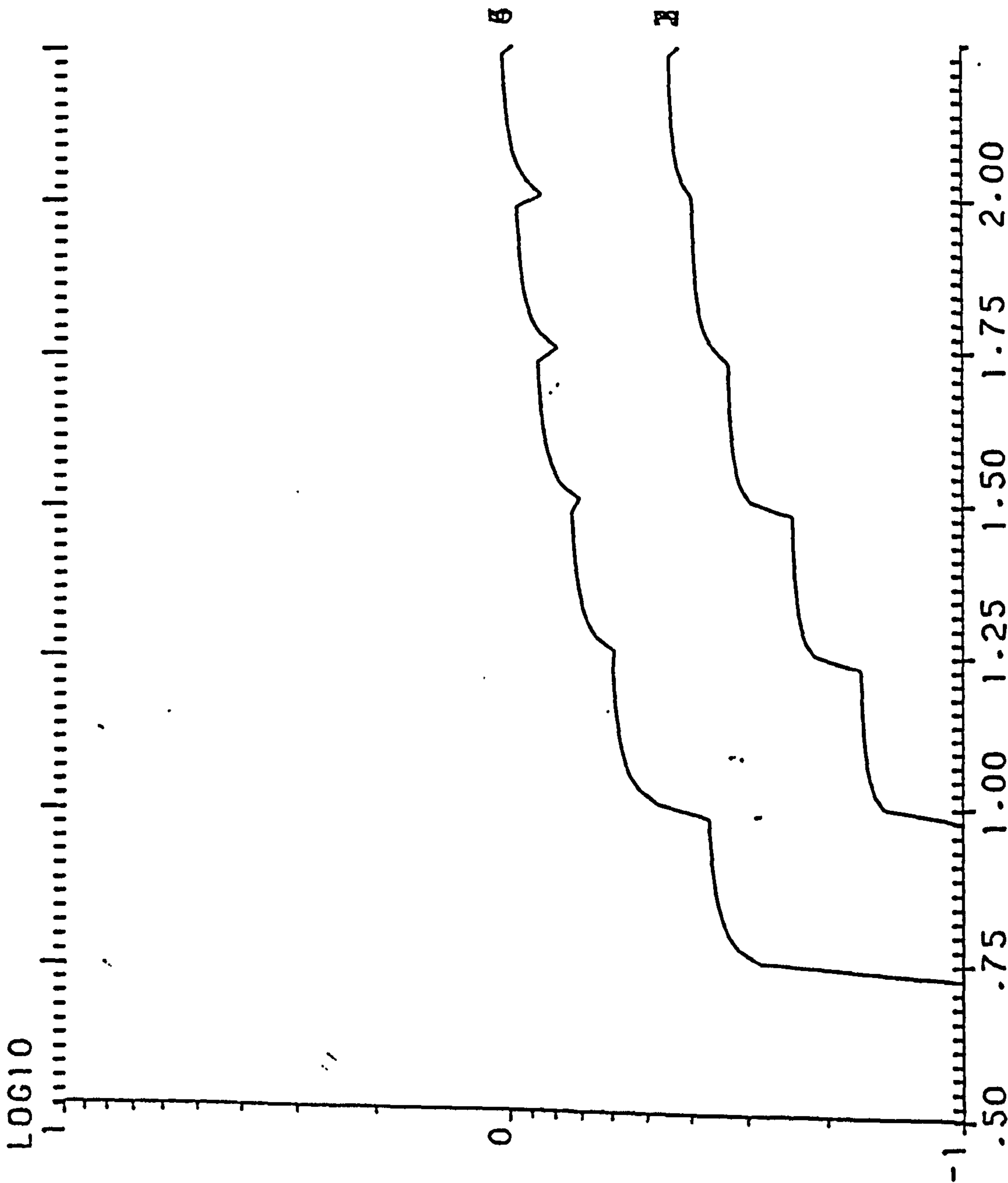

S. EFFICIENCY W. THICKNESS= .36M W. ORIENTATION=112.50

WD= 4M HD1= 4M HD2= 4M HOUSE T.=2.0 ST.

LOG10  
3

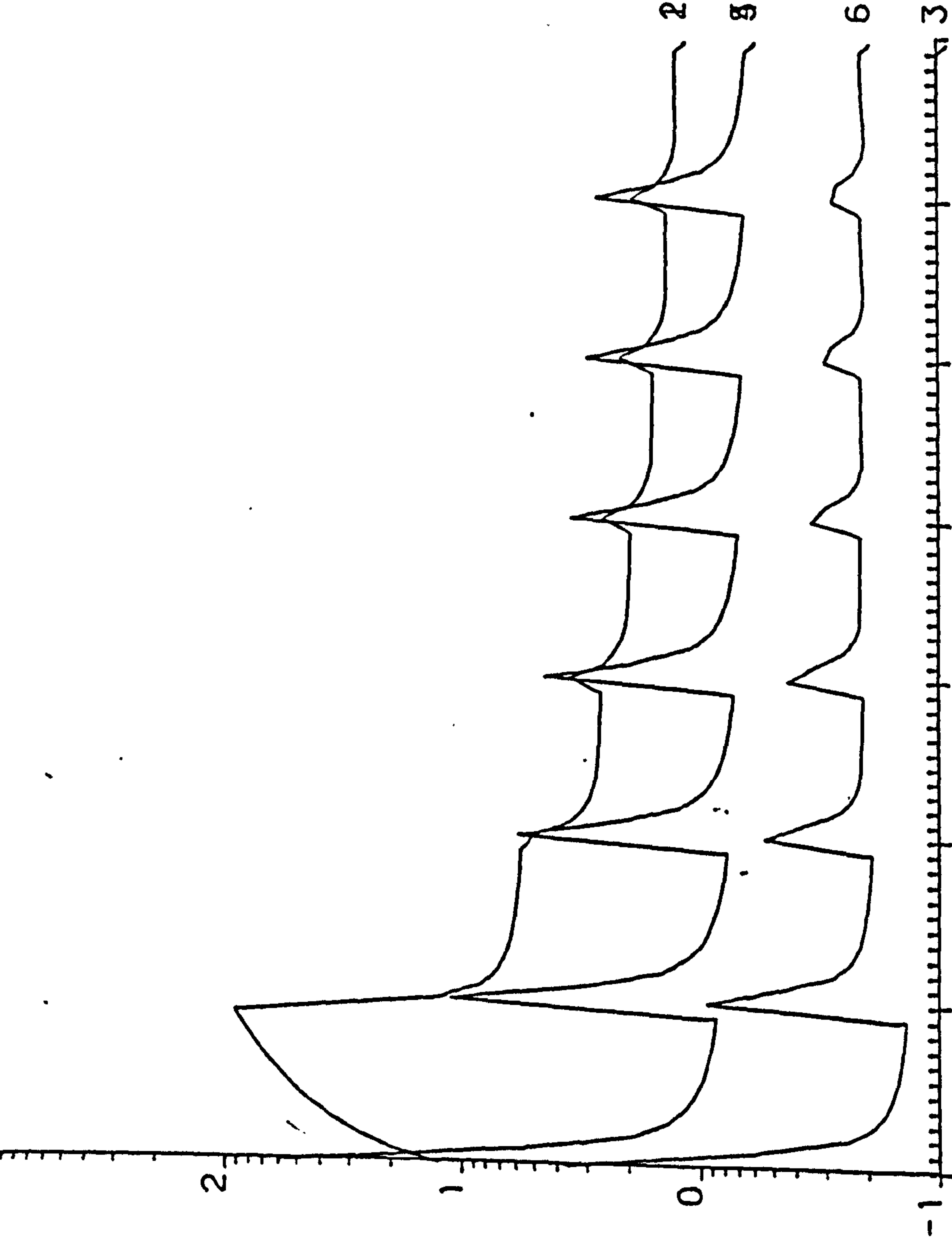

Y. EFFICIENCY W. THICKNESS= .36M W. ORIENTATION=135.00

WD= 4M HD1= 4M HD2= 4M HOUSE T.=2.0 ST.

LOG10

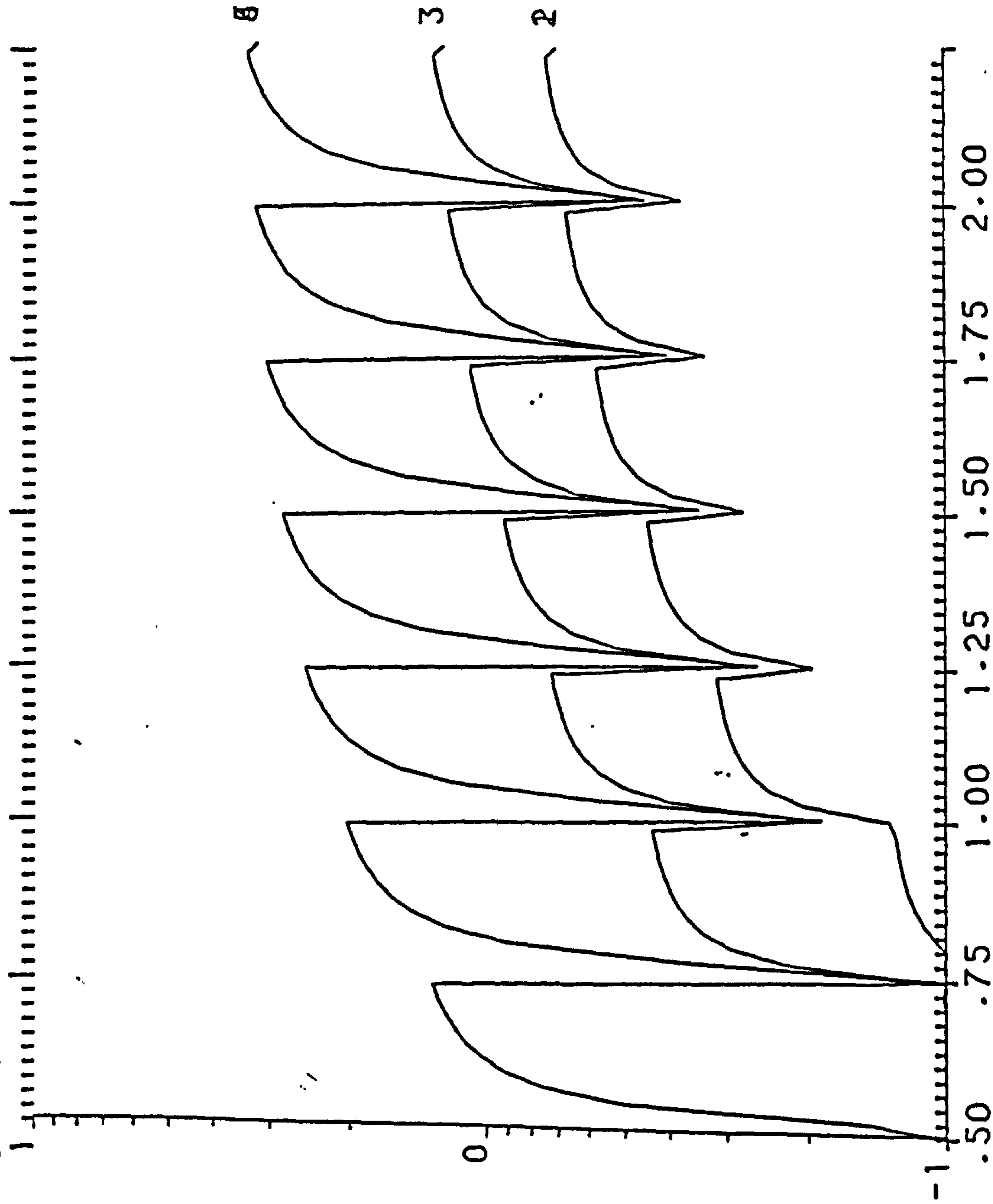

S. EFFICIENCY W. THICKNESS= .36M W. ORIENTATION=135.00

WD= 4M HD1= 4M HD2= 4M HOUSE T.=2.0 ST.

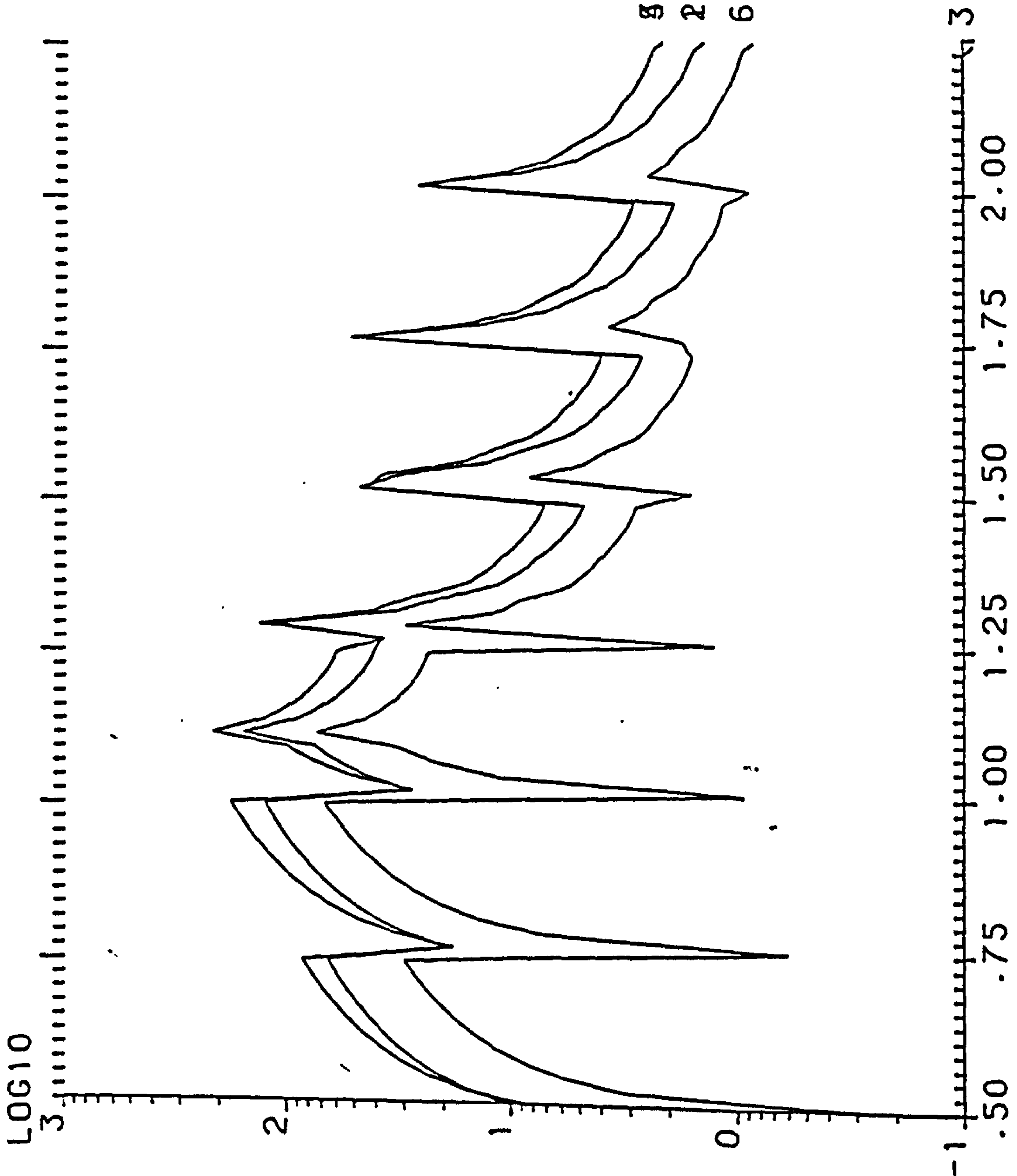

Y. EFFICIENCY    W. THICKNESS=    .36M    W. ORIENTATION=157.50  
WD= 4M    HD1= 4M    HD2= 4M    HOUSE T.=2.0 ST.

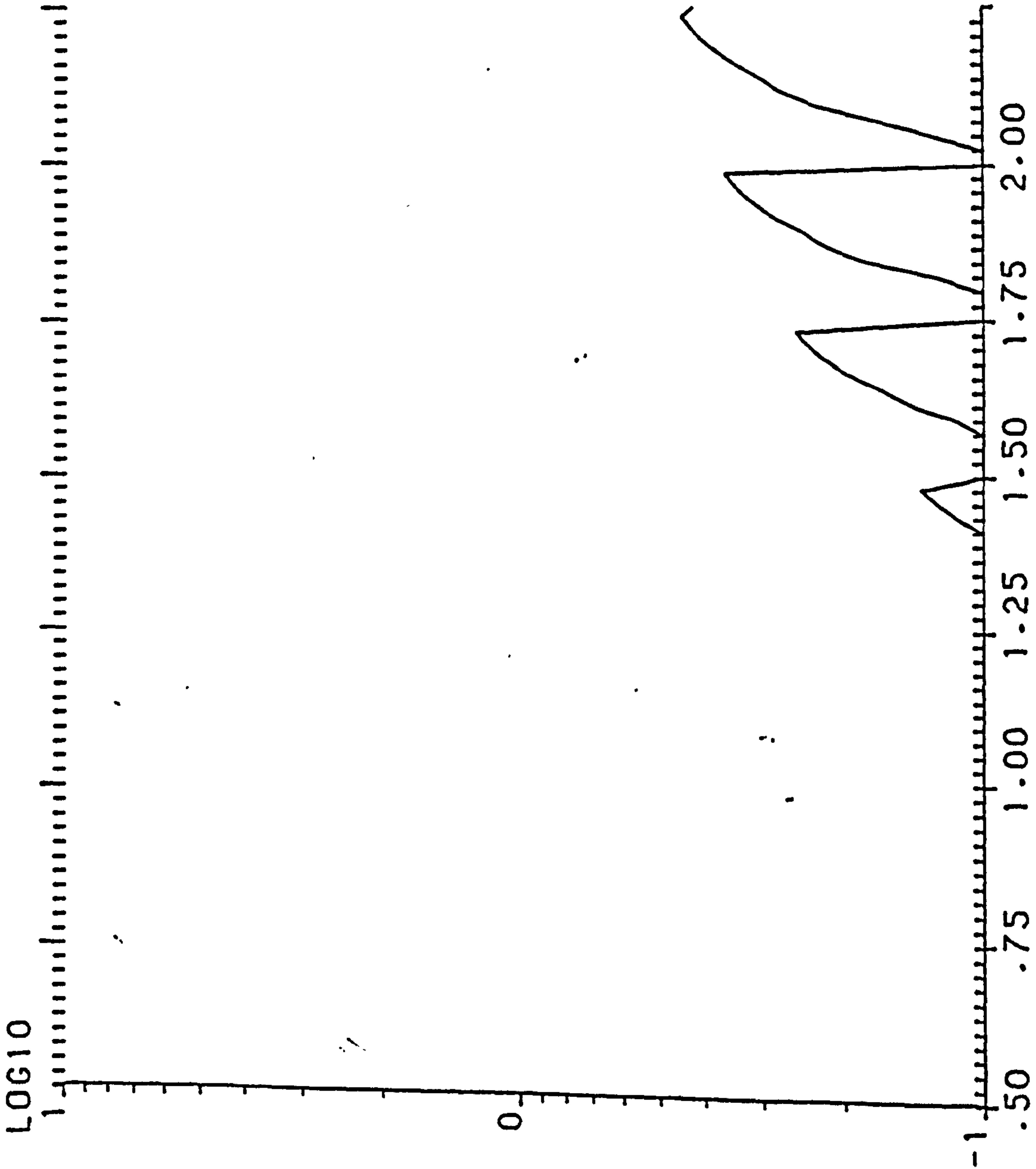

S. EFFICIENCY W. THICKNESS= .36M W. ORIENTATION=157.50

WD= 4M HD1= 4M HD2= 4M HOUSE T.=2.0 ST.



LOG10

1

0

-1

.50

.75

1.00

1.25

1.50

1.75

2.00



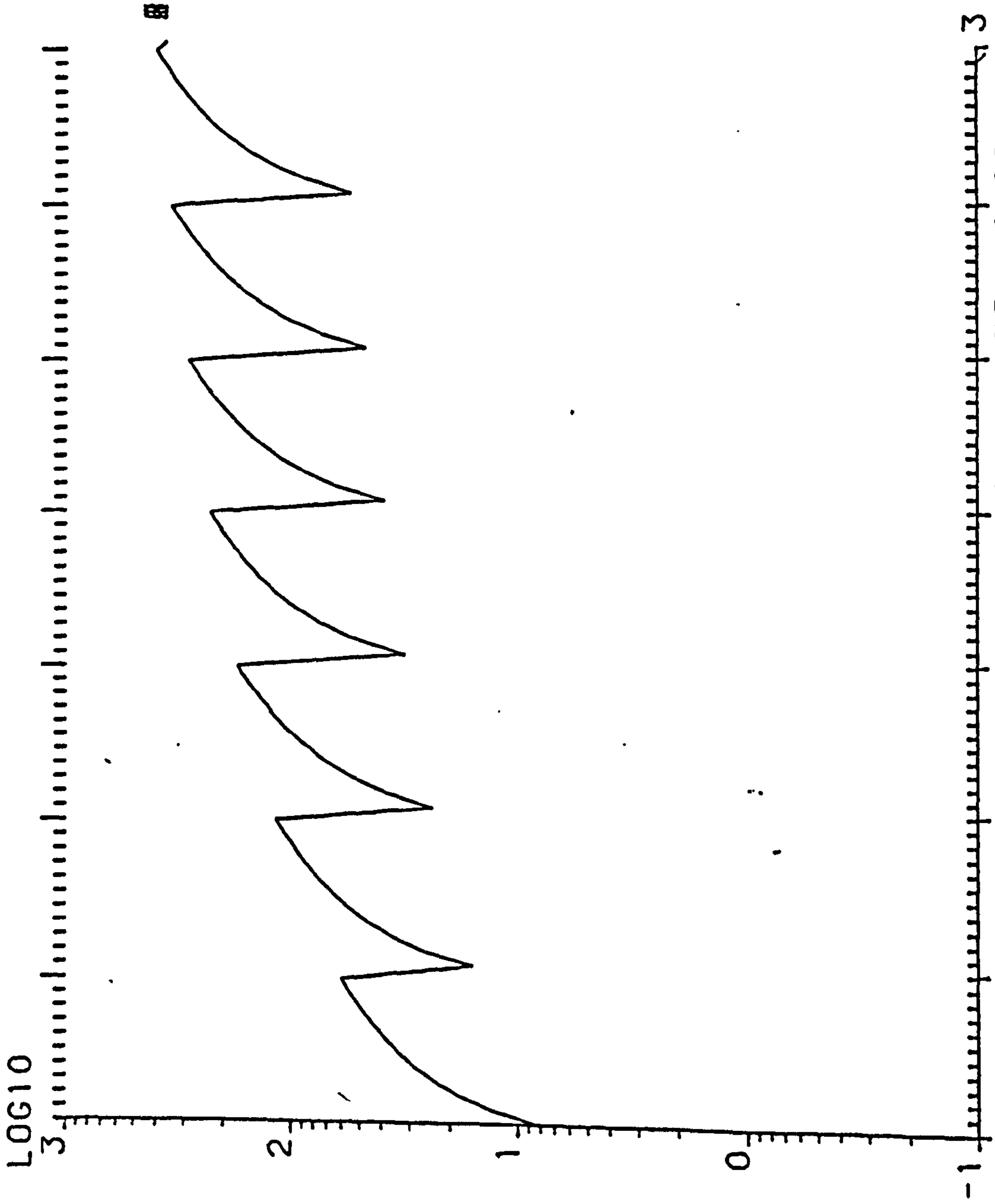

Y. EFFICIENCY W. THICKNESS= .36M W. ORIENTATION=180.00  
WD= 4M HD1= 4M HD2= 4M HOUSE T.=2.0 ST.

LOG10  
1

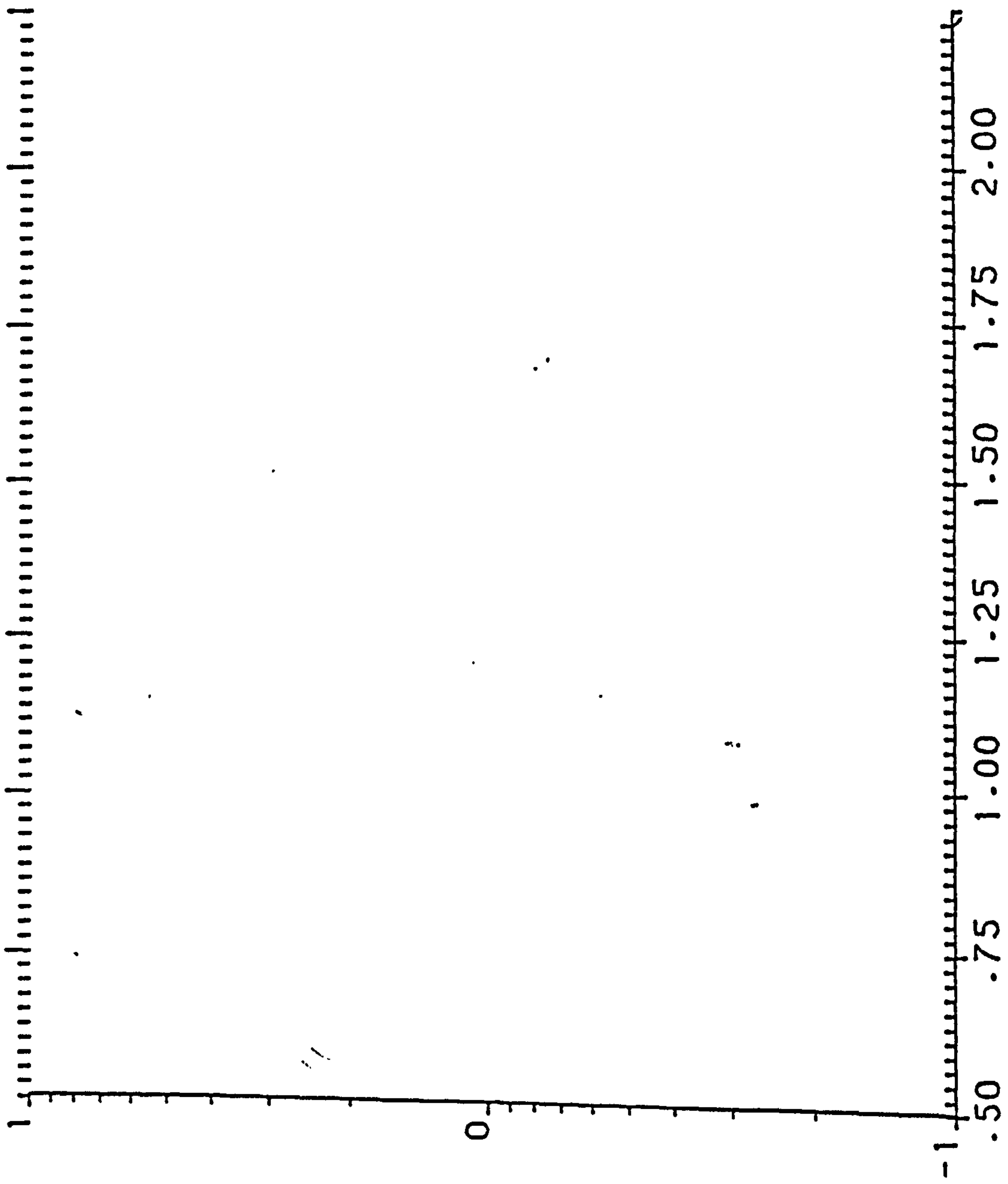

S. EFFICIENCY W. THICKNESS= .36M W. ORIENTATION=180.00  
 WD= 4M HD1= 4M HD2= 4M HOUSE T.=2.0 ST.



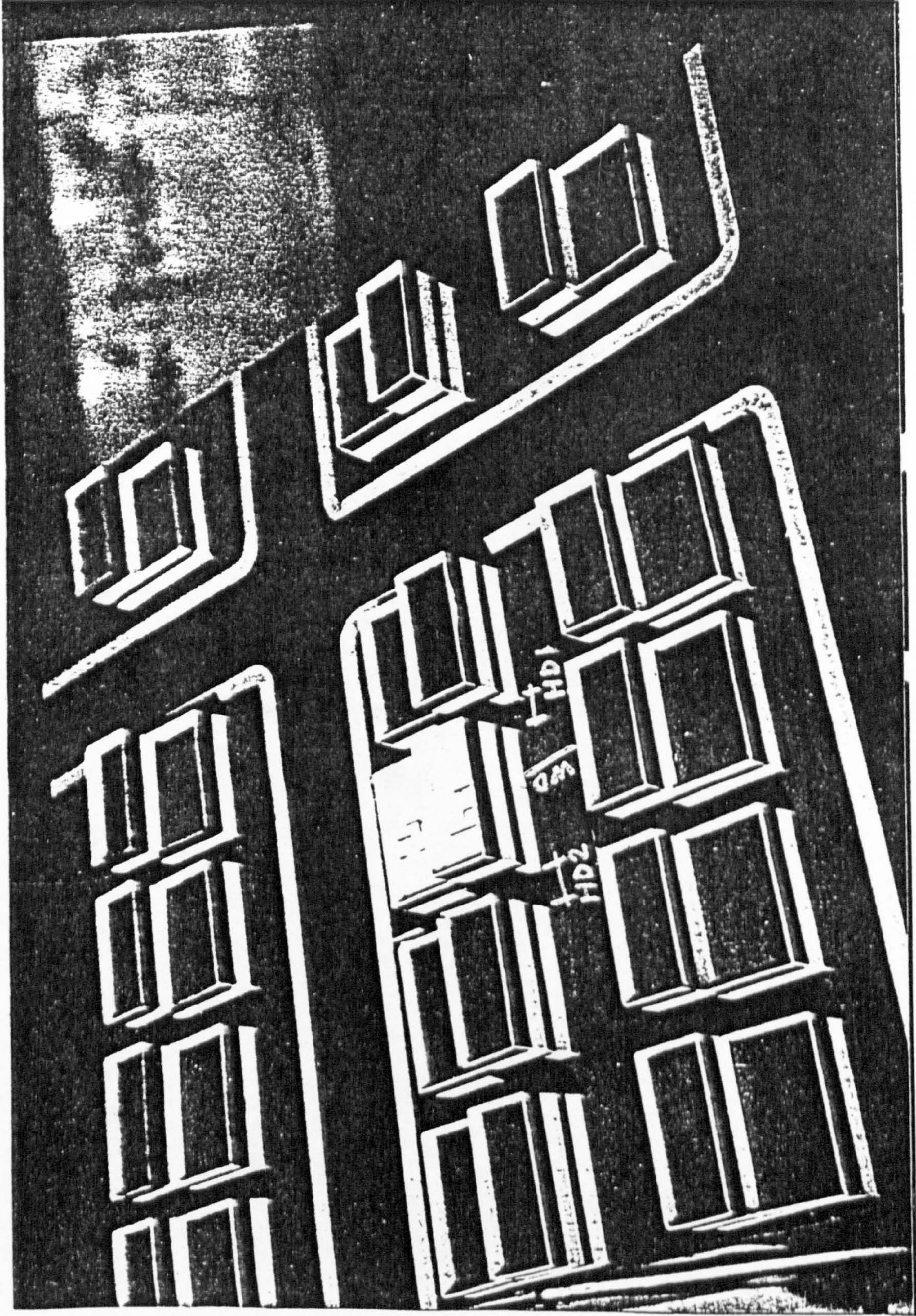

Model showing interhouse distances



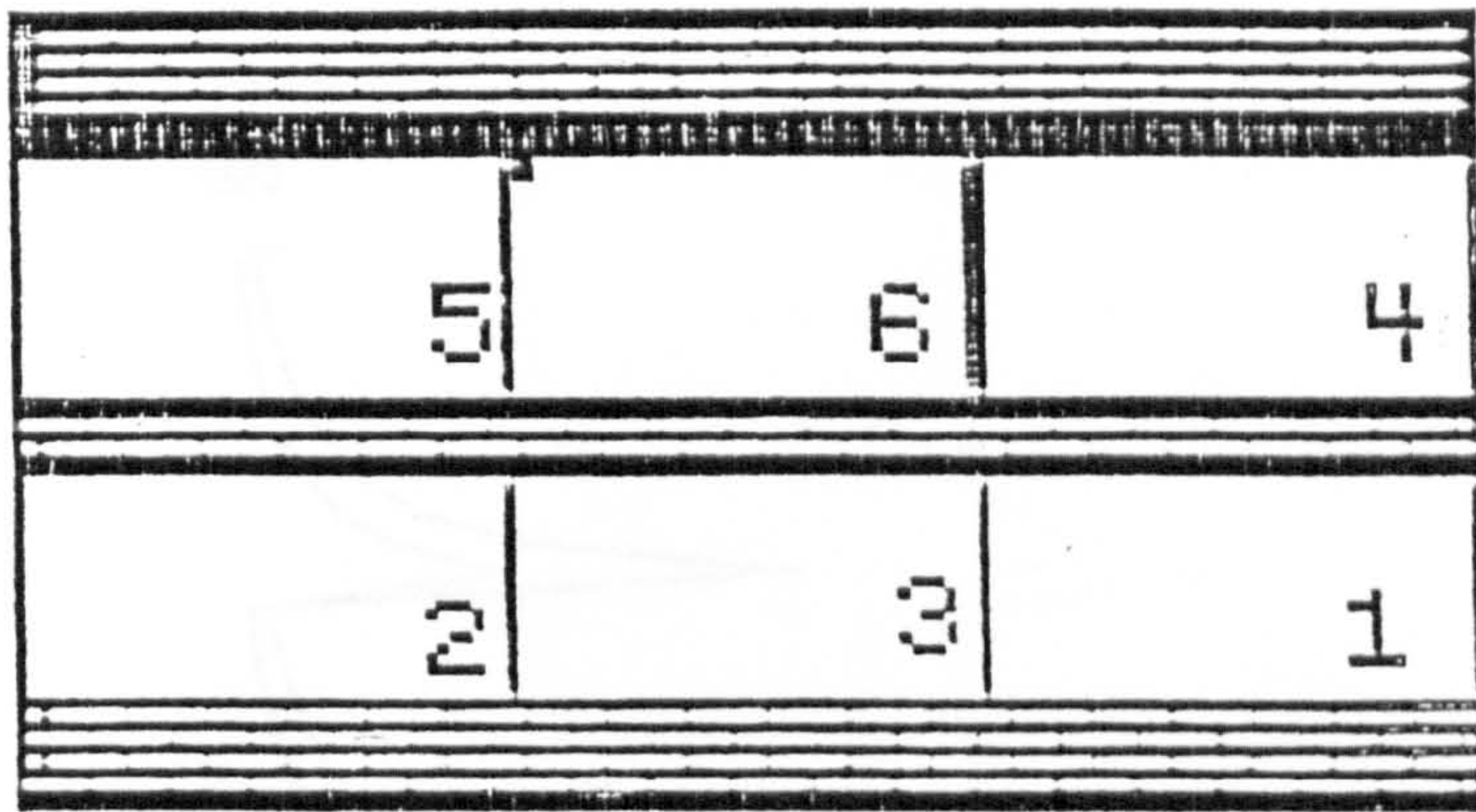

Key diagram showing the location  
of window data and the position  
of the corresponding curve  
Back Wall  
2 Storey



01610

EFFICIENCY W. THICKNESS

0.58 0.75 1.00 1.25 1.50

MD= 611 MD1= 111 MD2= 117

LOG10

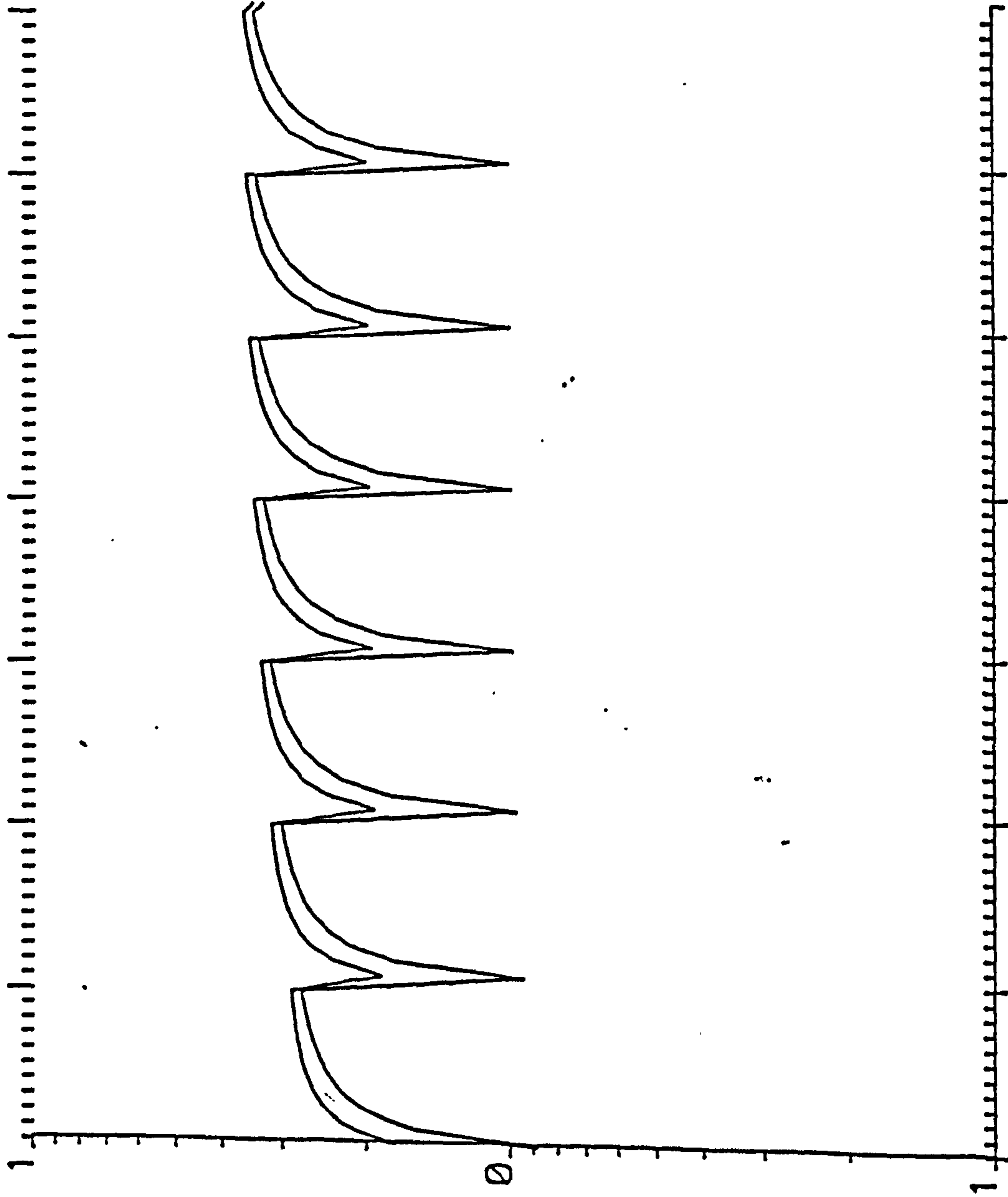

0.8

0

-1

.50 .75 1.00 1.25 1.50 1.75 2.00

S. EFFICIENCY W. THICKNESS= .12M W. ORIENTATION= .00

WD= 6M HD1= 1M HD2= 1M HOUSE T.=2.0 ST.





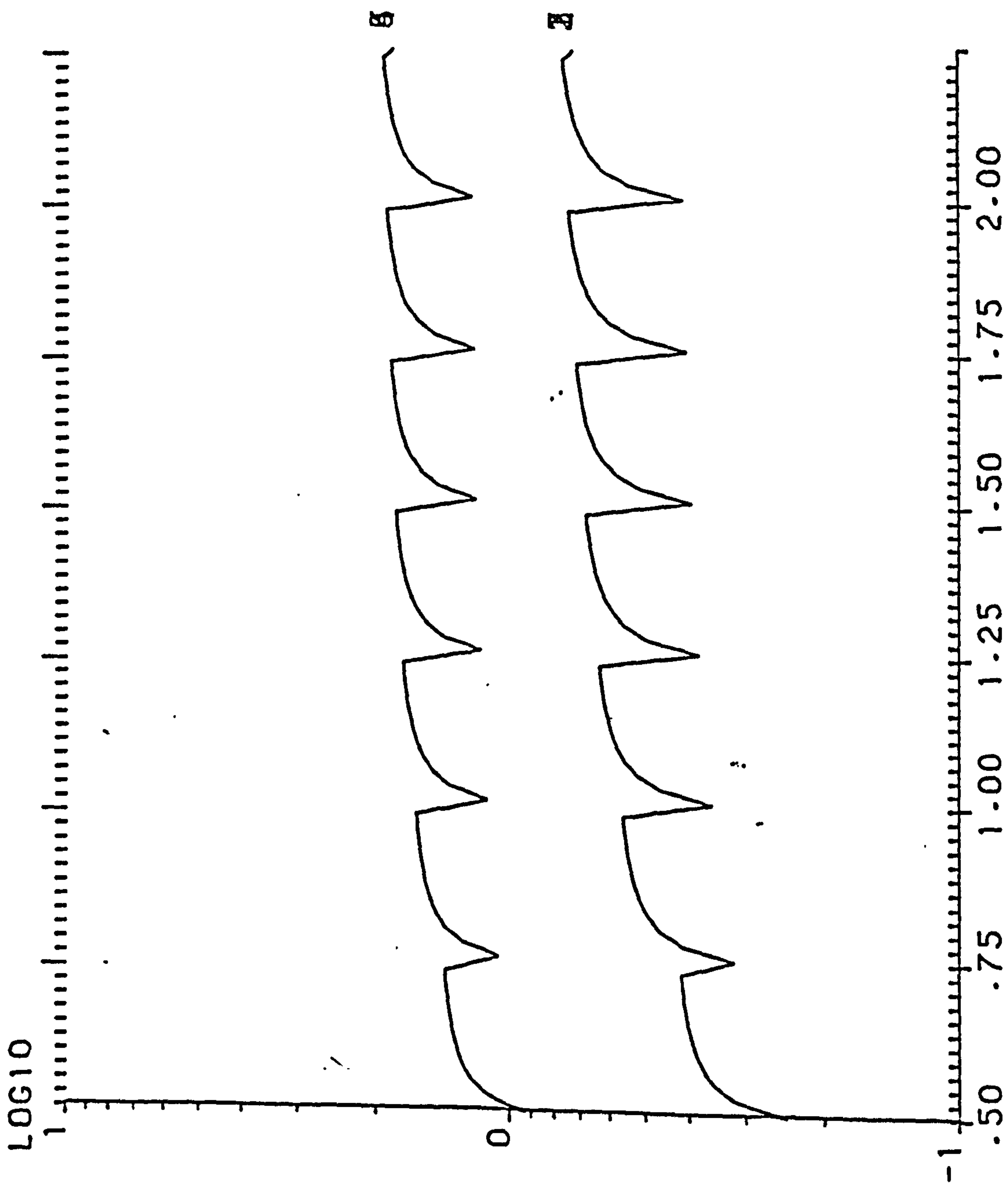

S. EFFICIENCY W. THICKNESS= .12M HD2= 1M HOUSE T.=2.0 ST.  
 W. ORIENTATION= 22.50



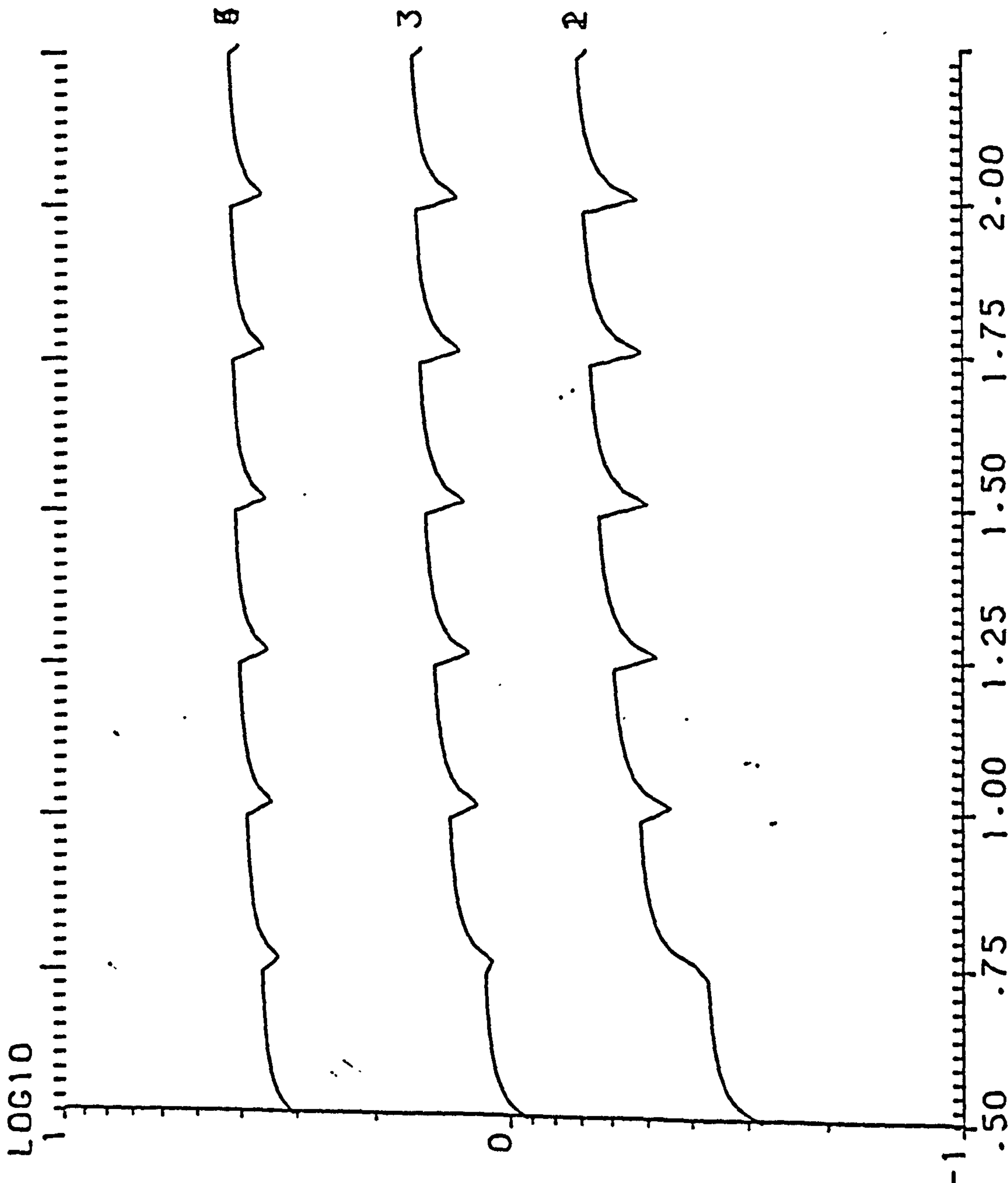

S. EFFICIENCY W. THICKNESS= .12M W. ORIENTATION= 45.00

WD= 6M HD1= 1M HD2= 1M HOUSE T.=2.0 ST.



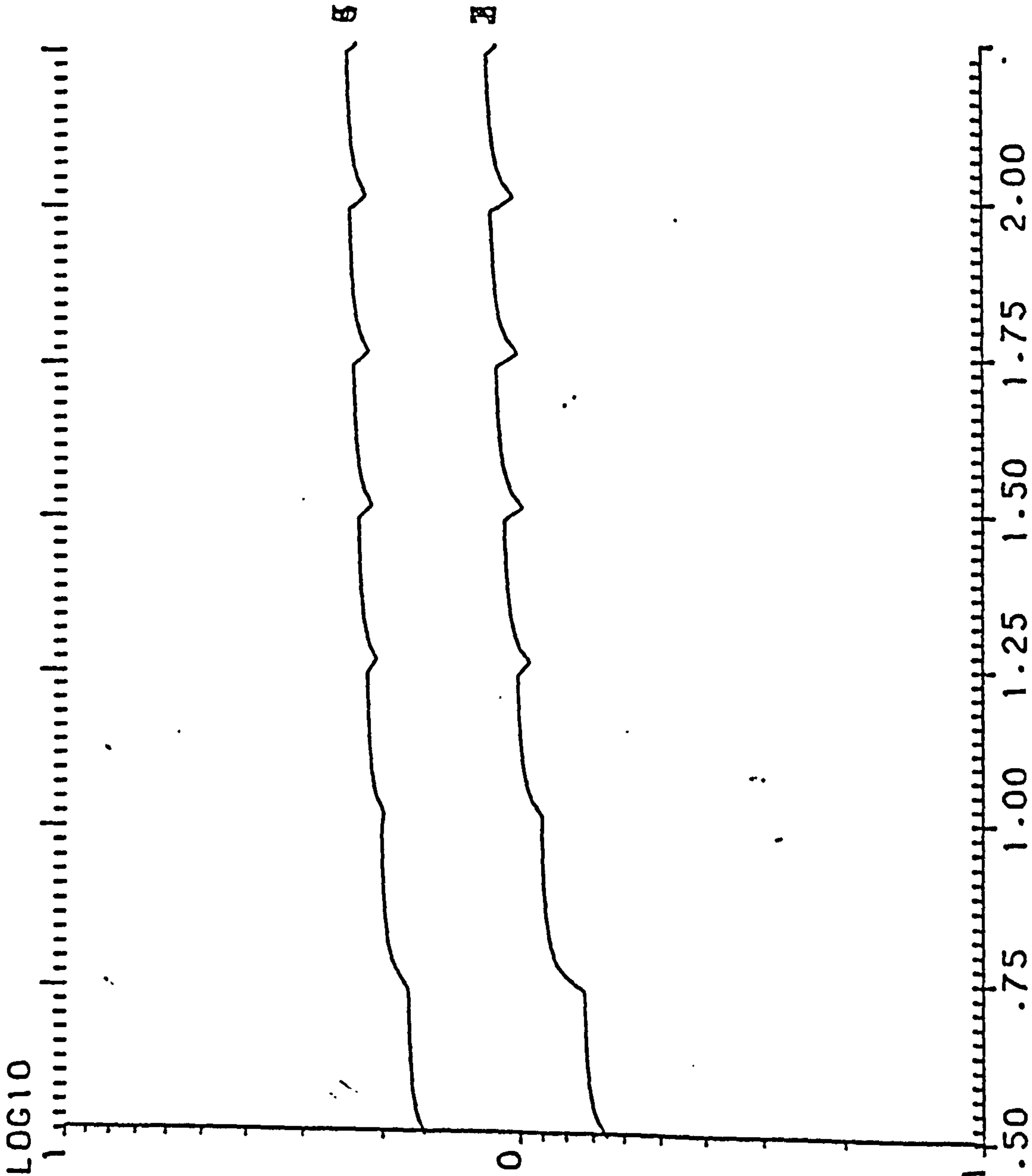

S. EFFICIENCY W. THICKNESS= .12M W. ORIENTATION= 67.50  
 WD= 6M HD1= 1M HD2= 1M HOUSE T.=2.0 ST.



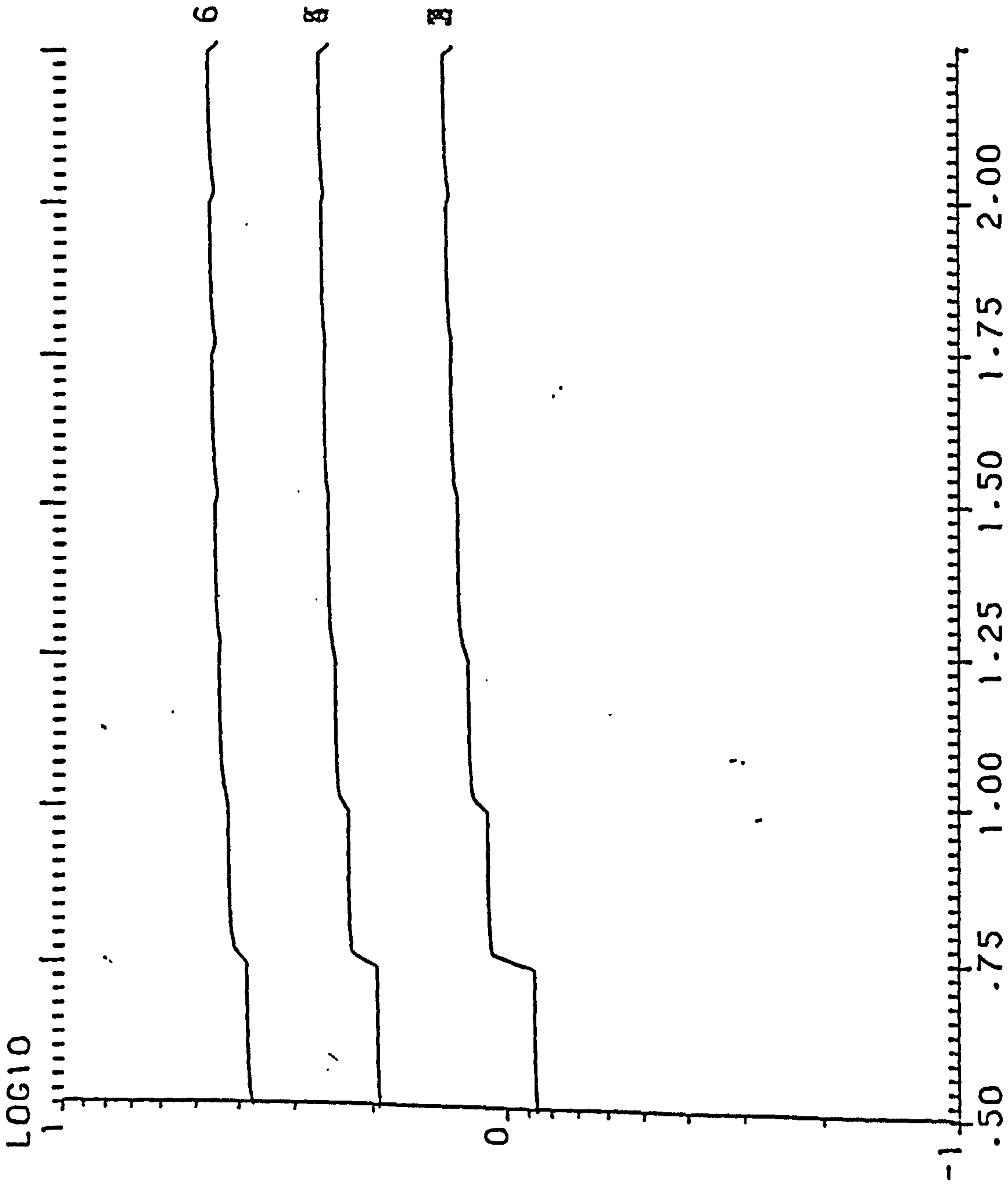

S. EFFICIENCY W. THICKNESS = .12M W. ORIENTATION = 90.00  
 WD = 6M HD1 = 1M HD2 = 1M HOUSE T. = 2.0 ST.

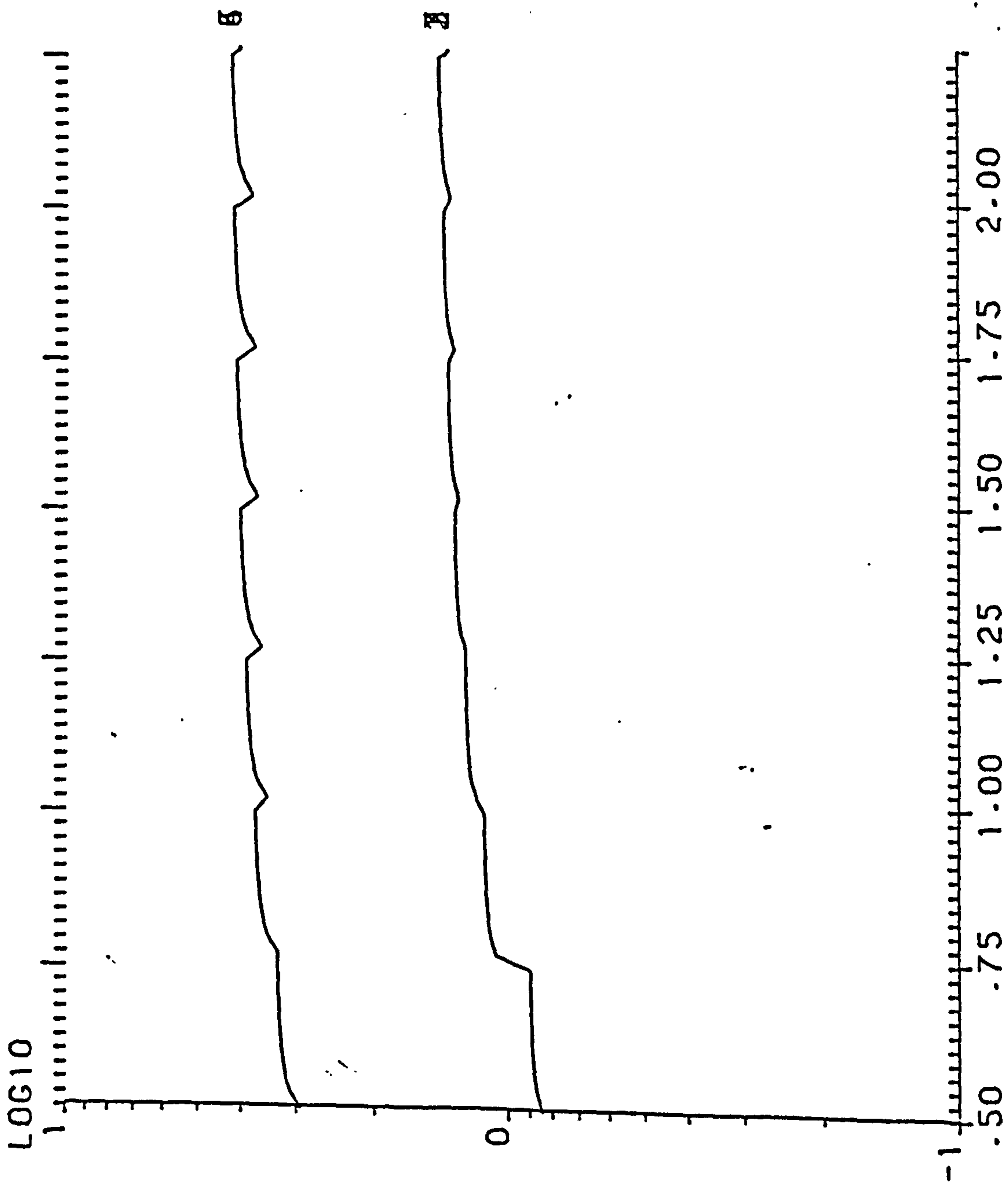

S. EFFICIENCY W. THICKNESS= .12M W. ORIENTATION=112.50  
 WD= 6M HD1= 1M HD2= 1M HOUSE T.=2.0 ST.



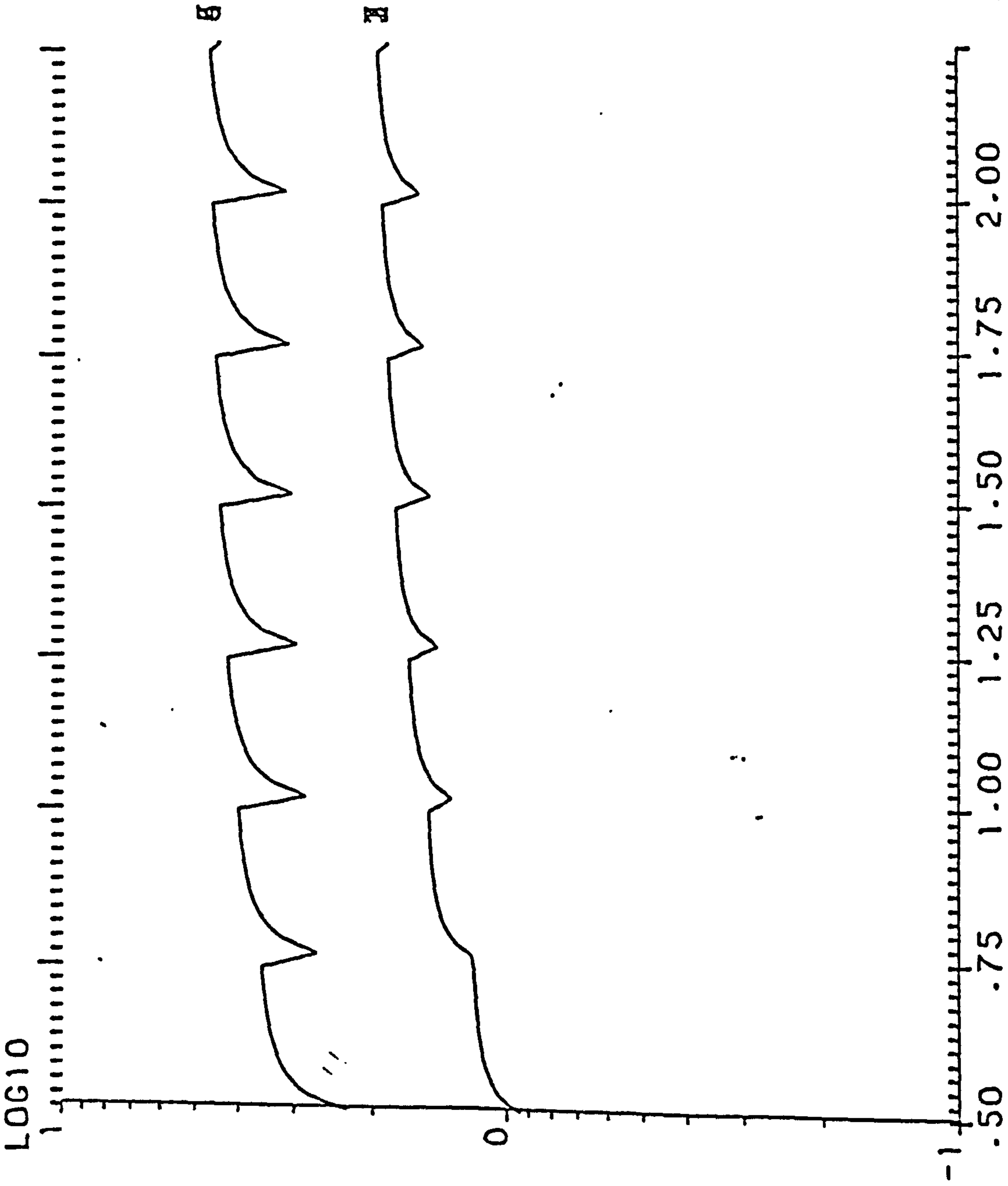

S. EFFICIENCY W. THICKNESS= .12M W. ORIENTATION=135.00

WD= 6M HD1= 1M HD2= 1M HOUSE T.=2.0 ST.



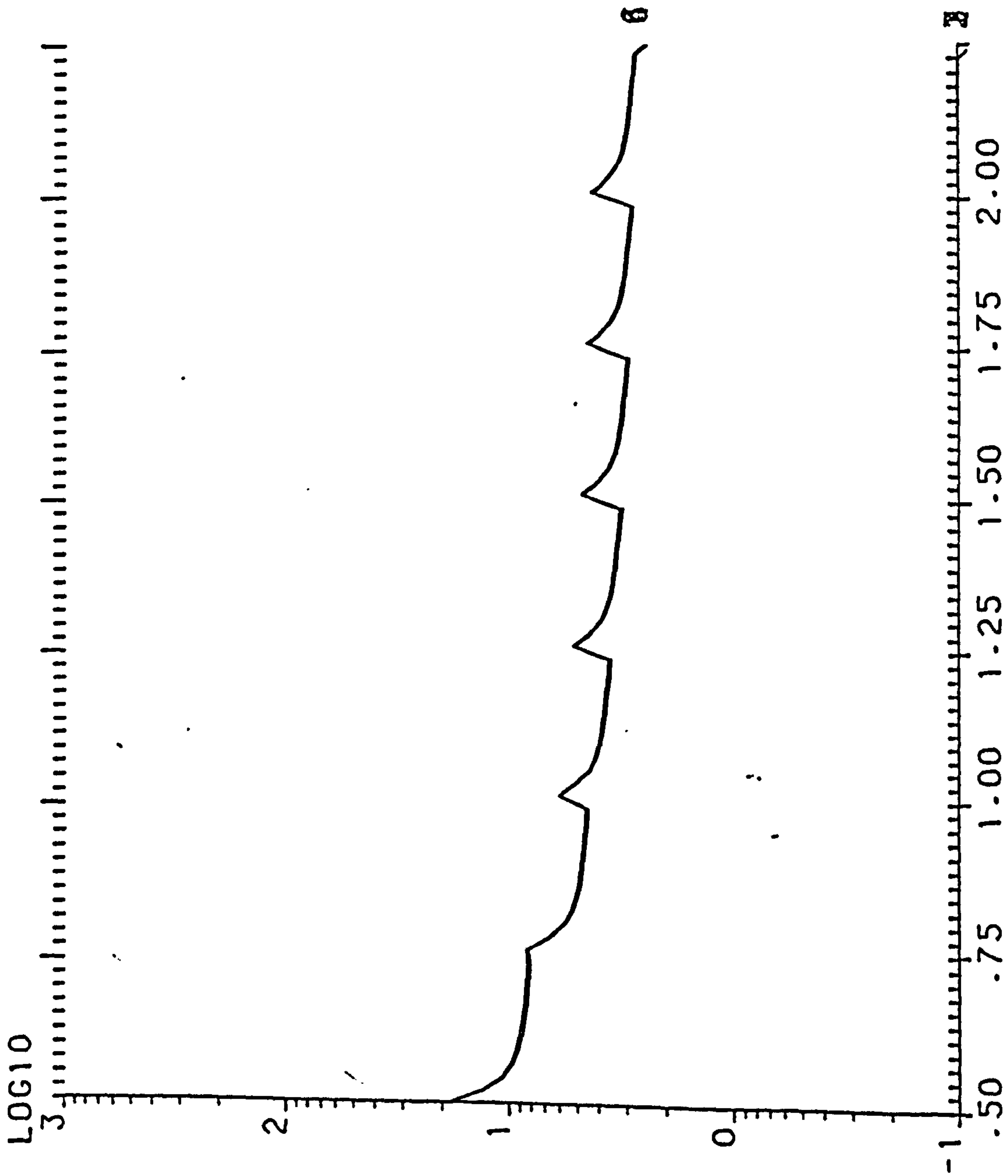

Y. EFFICIENCY W. THICKNESS= .12M W. ORIENTATION=157.50

WD= 6M HD1= 1M HD2= 1M HOUSE T.=2.0 ST.

LOG10

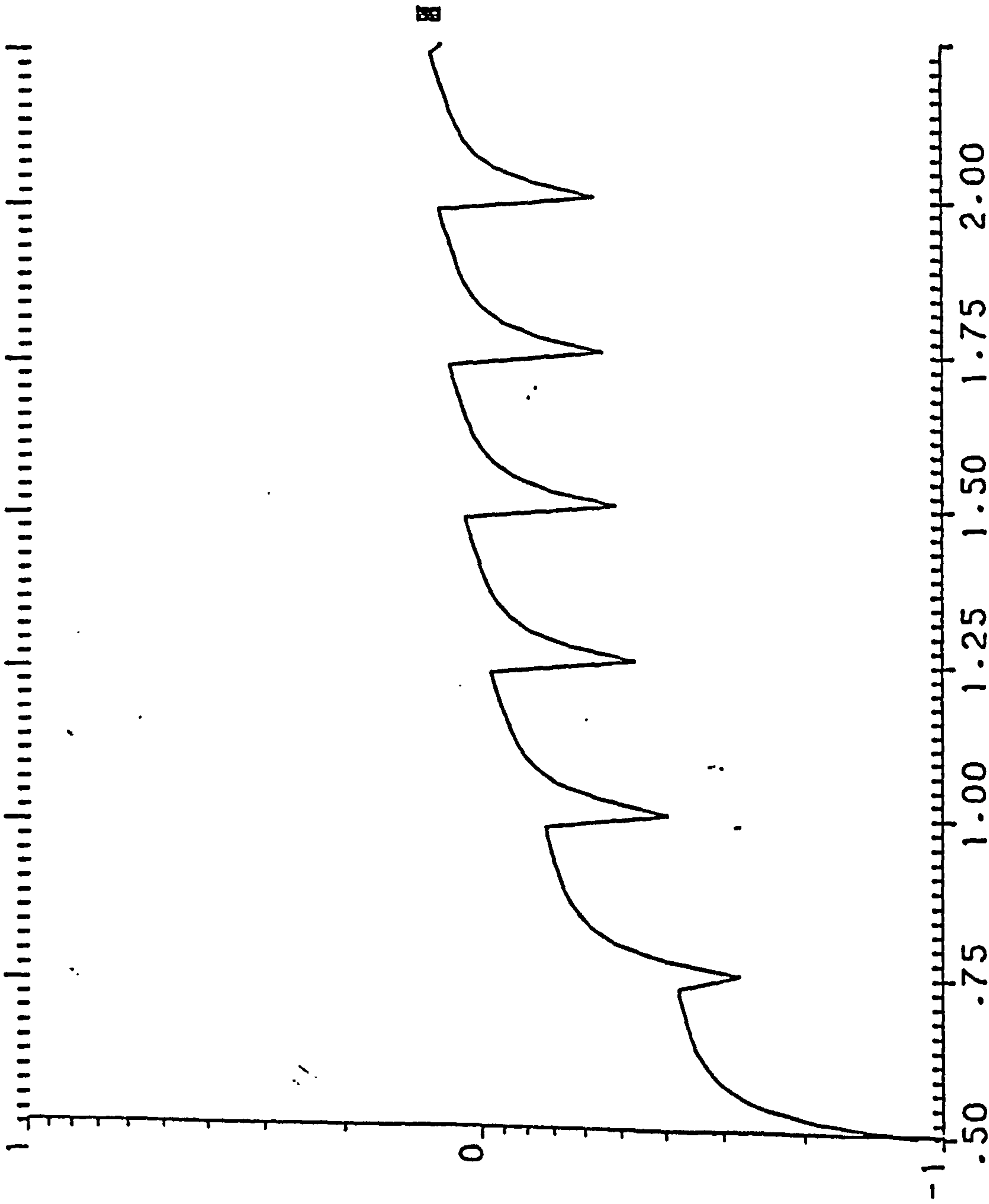

S. EFFICIENCY W. THICKNESS= .12M W. ORIENTATION=157.50

WD= 6M HD1= 1M HD2= 1M HOUSE T.=2.0 ST.

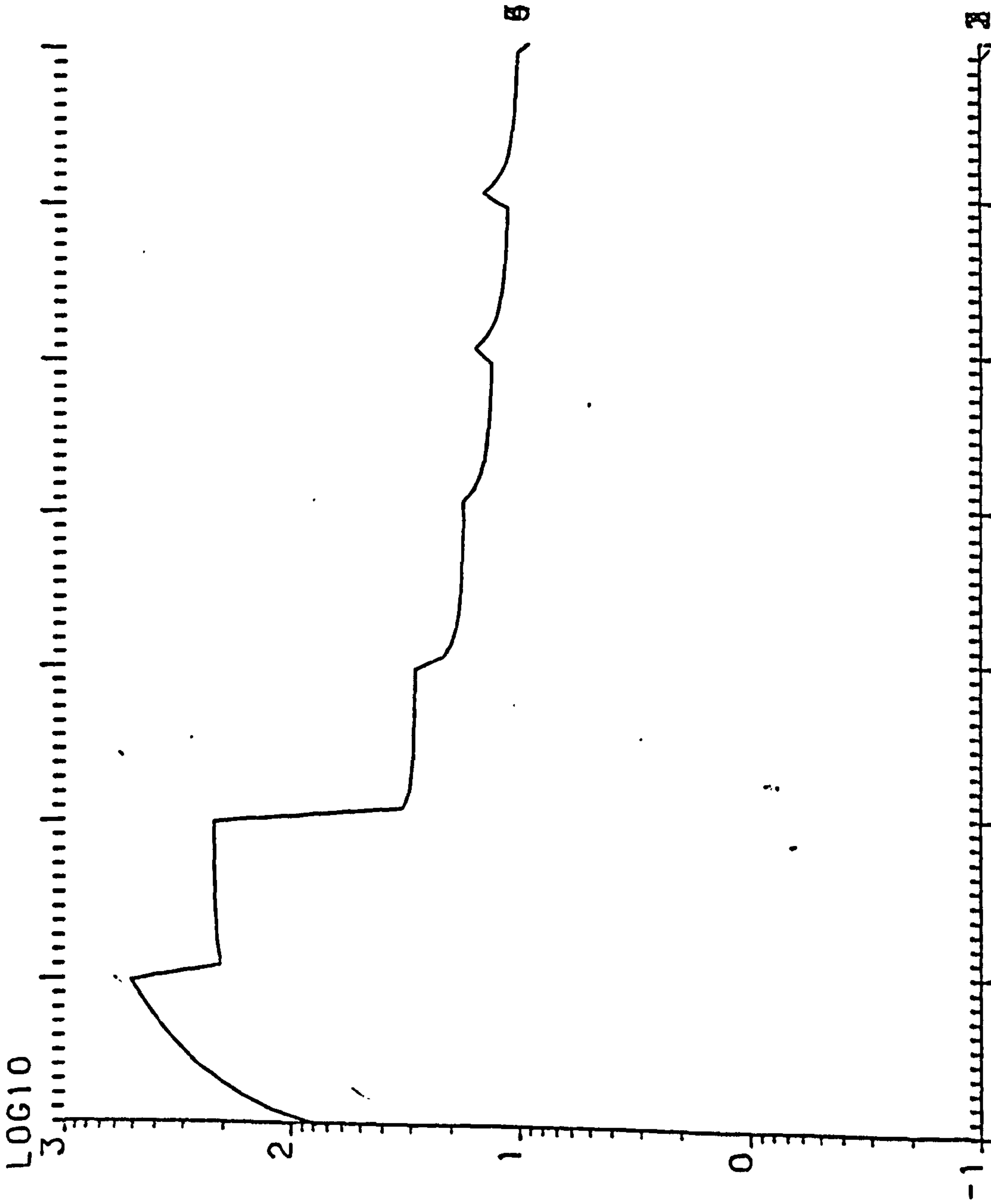

Y. EFFICIENCY W. THICKNESS= .12M W. ORIENTATION=180.00  
WD= 6M HD1= 1M HD2= 1M HOUSE T.=2.0 ST.

LOG10  
1  
0  
-1

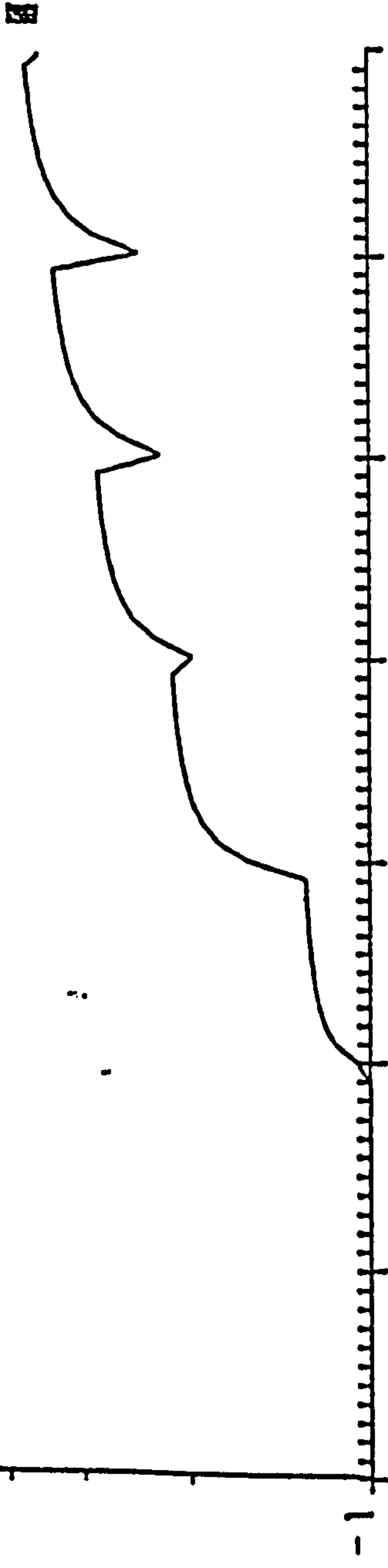

S. EFFICIENCY W. THICKNESS= .12M W. ORIENTATION=180.00

WD= 6M HD1= 1M HD2= 1M HOUSE T.=2.0 ST.



LOG10

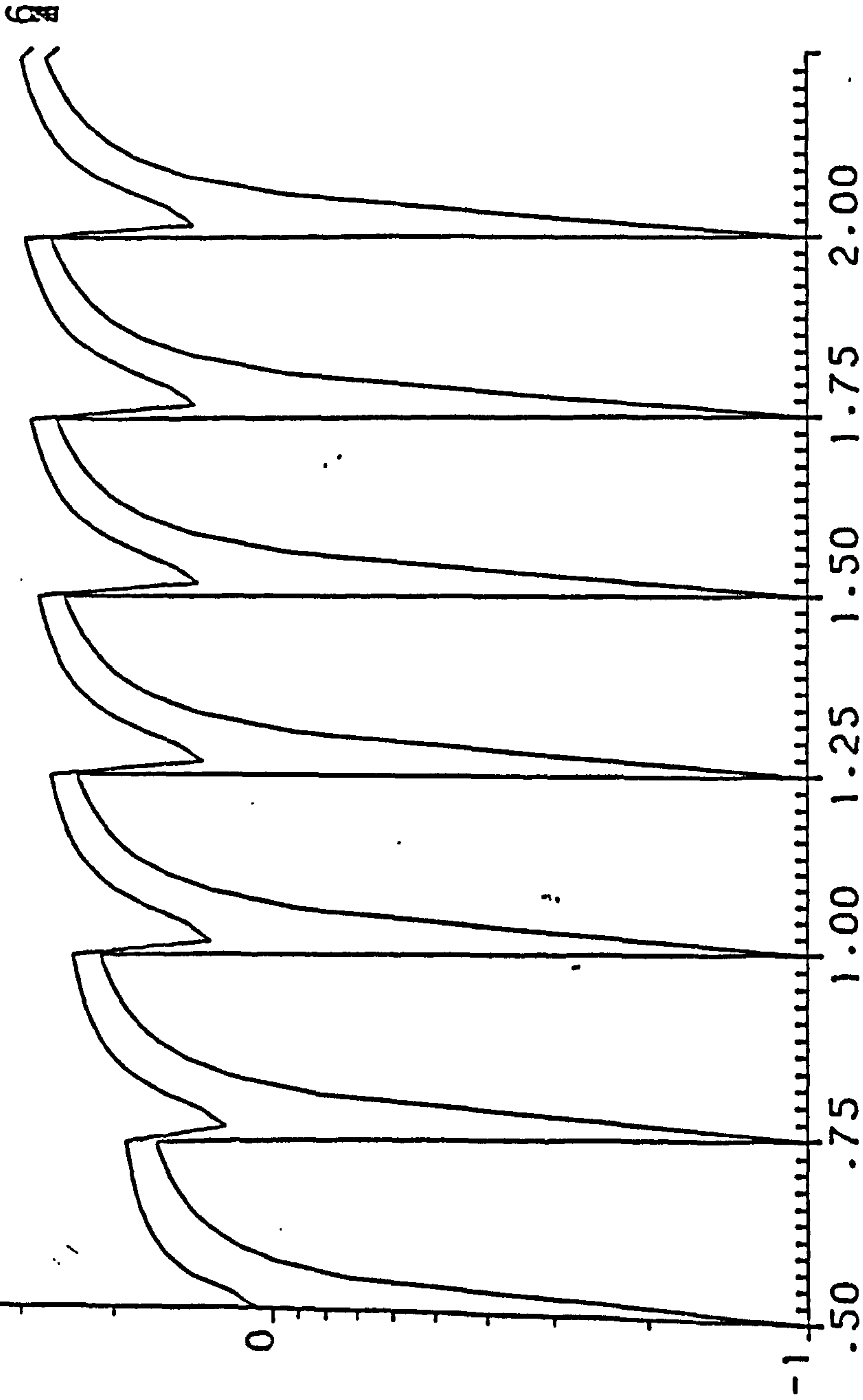

S. EFFICIENCY W. THICKNESS= .24M W. ORIENTATION= .00

WD= 6M HD1= 1M HD2= 1M HOUSE T.=2.0 ST.

LOG10

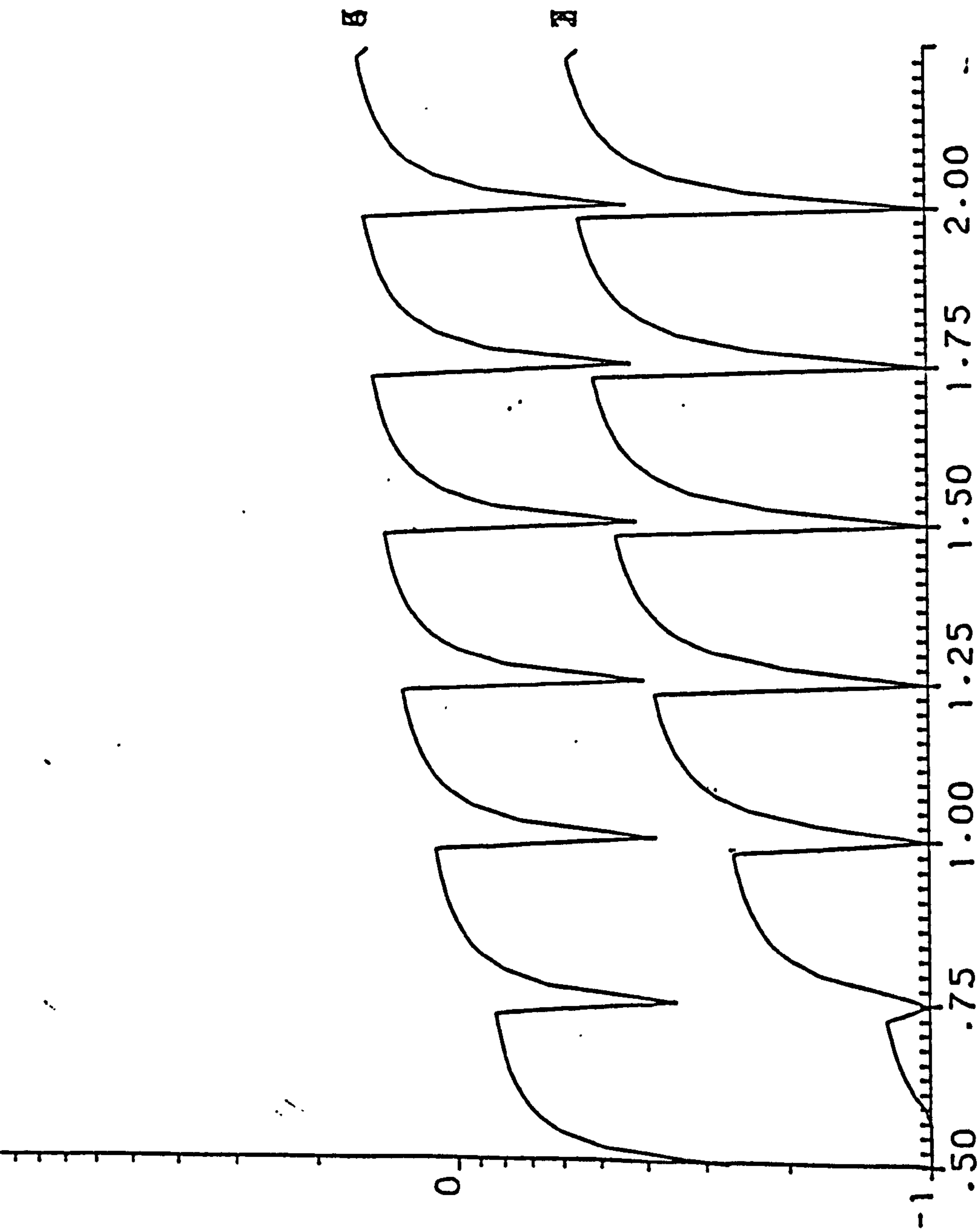

S. EFFICIENCY W. THICKNESS= .24M W. ORIENTATION= 22.50

WD= 6M HD1= 1M HD2= 1M HOUSE T.=2.0 ST.



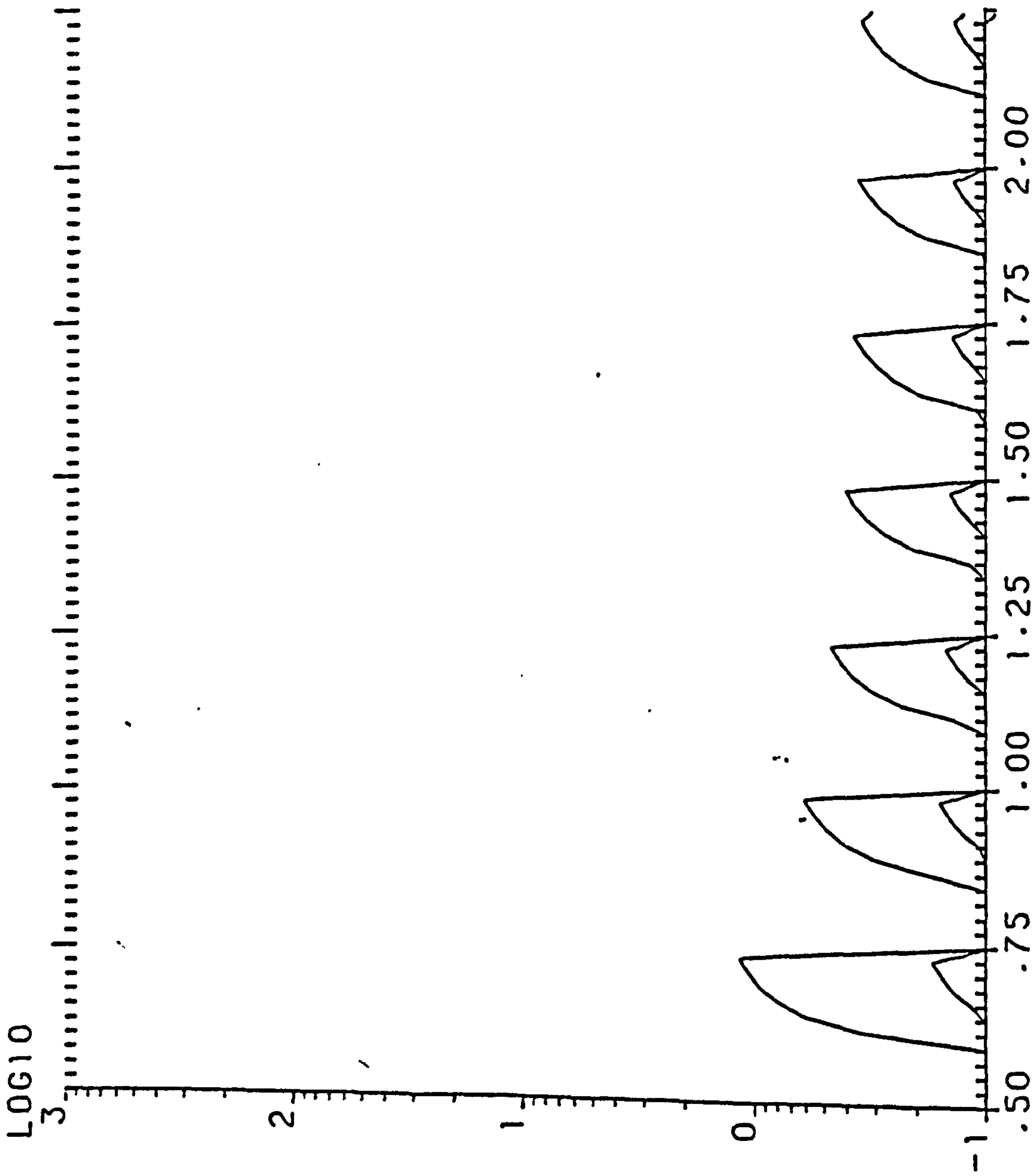

Y. EFFICIENCY W. THICKNESS= .24M W. ORIENTATION= 45.00

WD= 6M HD1= 1M HD2= 1M HOUSE T.=2.0 ST.

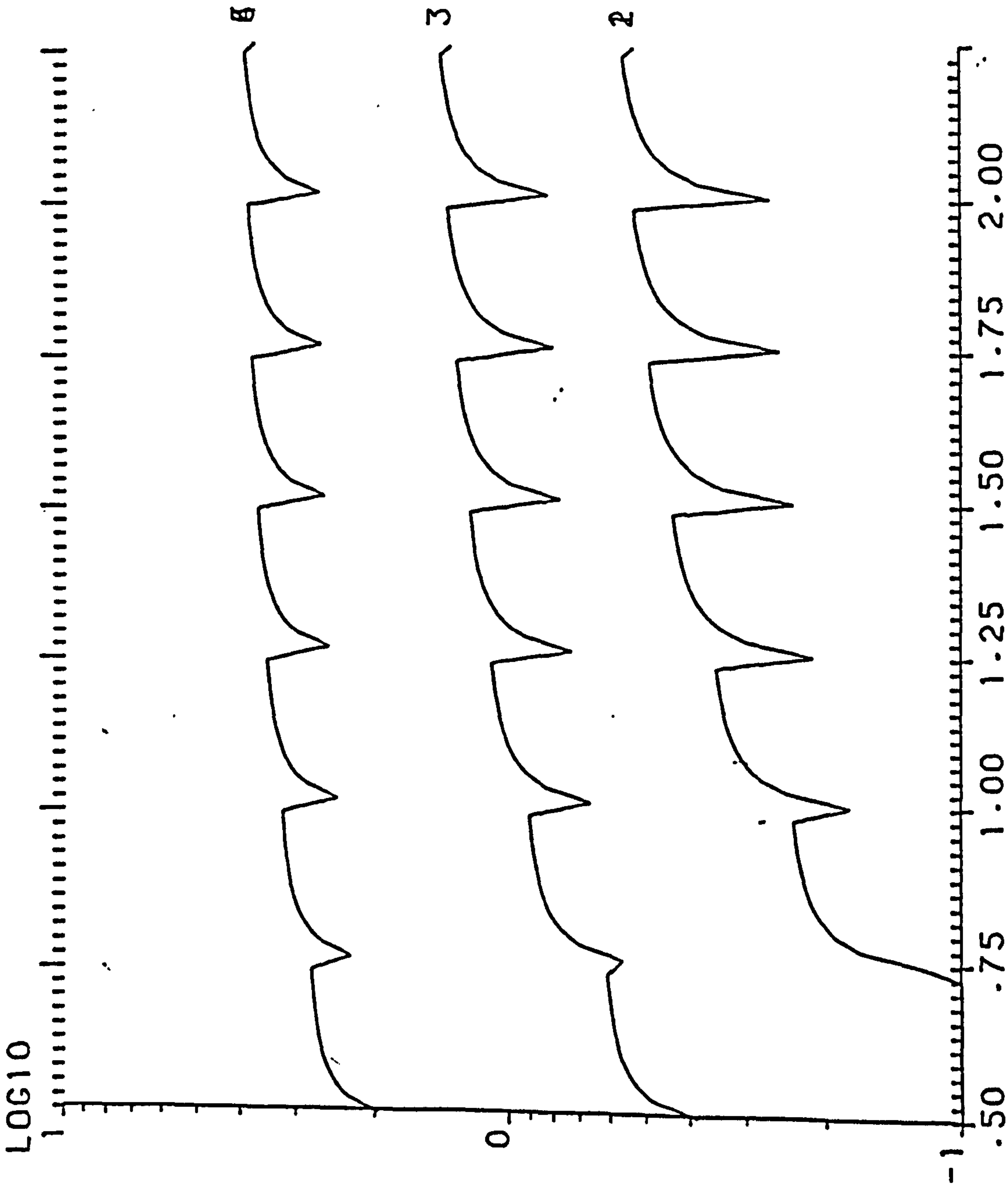

S. EFFICIENCY W. THICKNESS= .24M W. ORIENTATION= 45.00

WD= 6M HD1= 1M HD2= 1M HOUSE T.=2.0 ST.



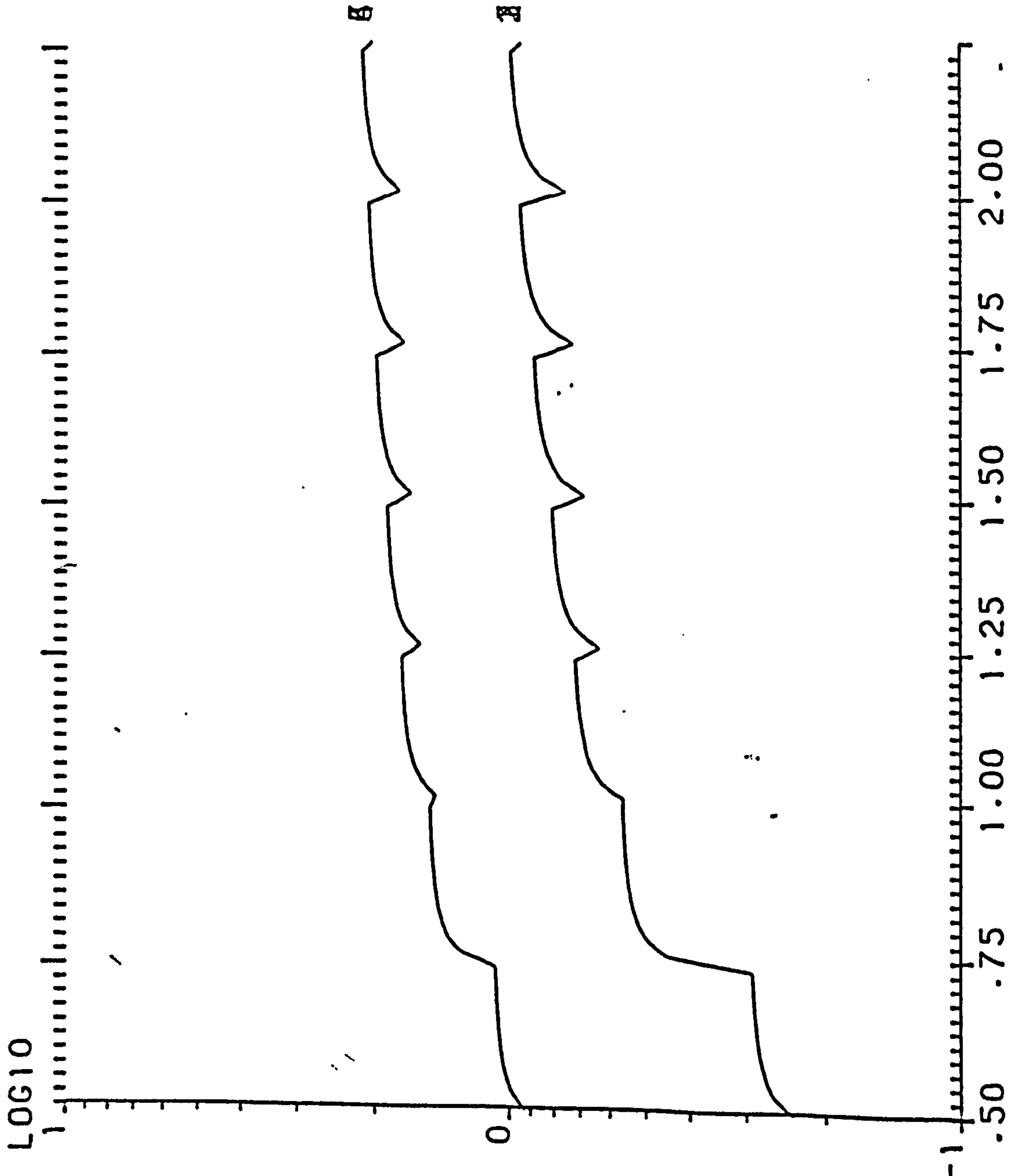

S. EFFICIENCY W. THICKNESS= .24M W. ORIENTATION= 67.50  
 WD= 6M HD1= 1M HD2= 1M HOUSE T.=2.0 ST.



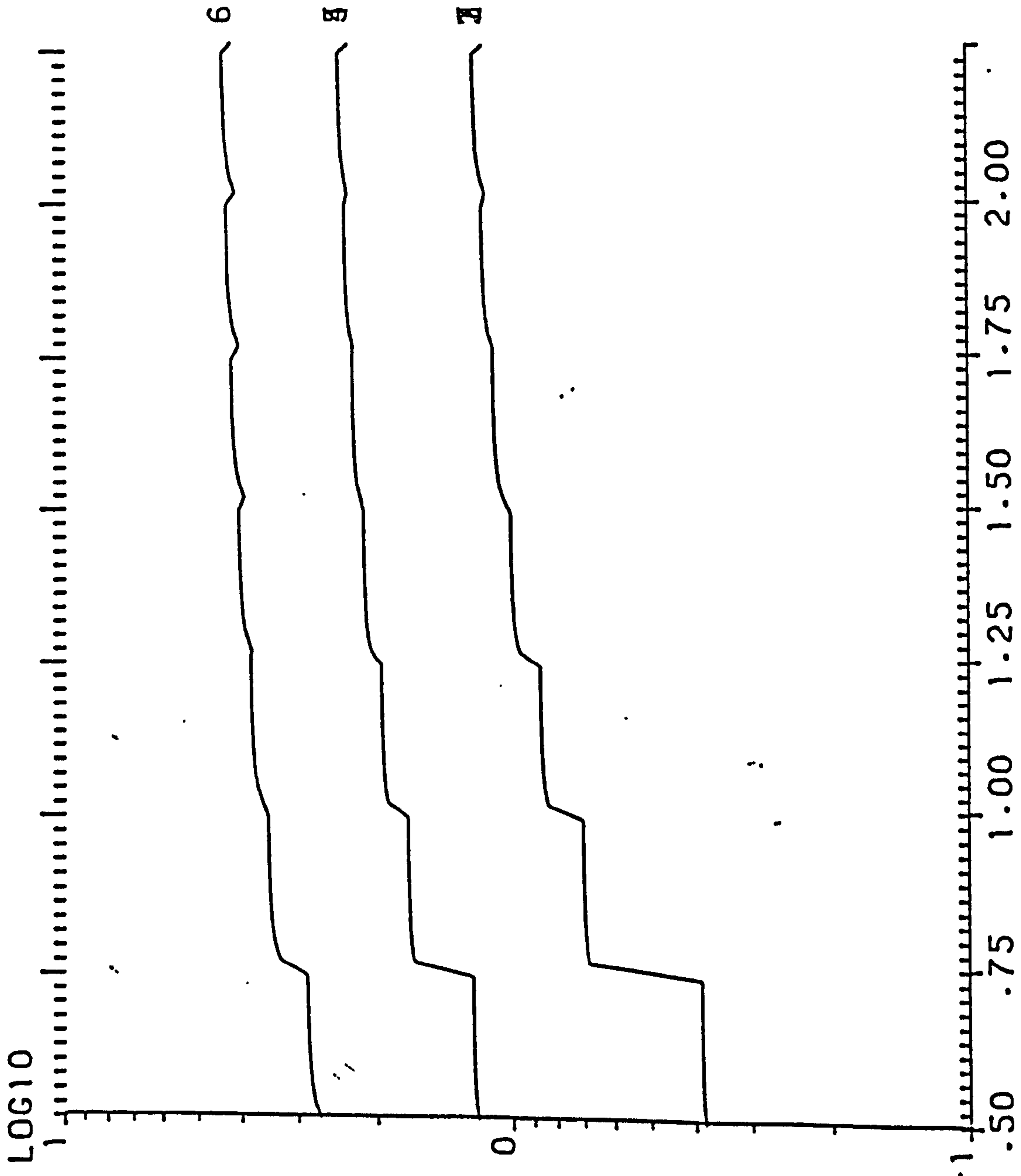

S. EFFICIENCY W. THICKNESS = .24M W. ORIENTATION = 90.00  
 WD = 6M HD1 = 1M HD2 = .1M HOUSE T. = 2.0 ST.

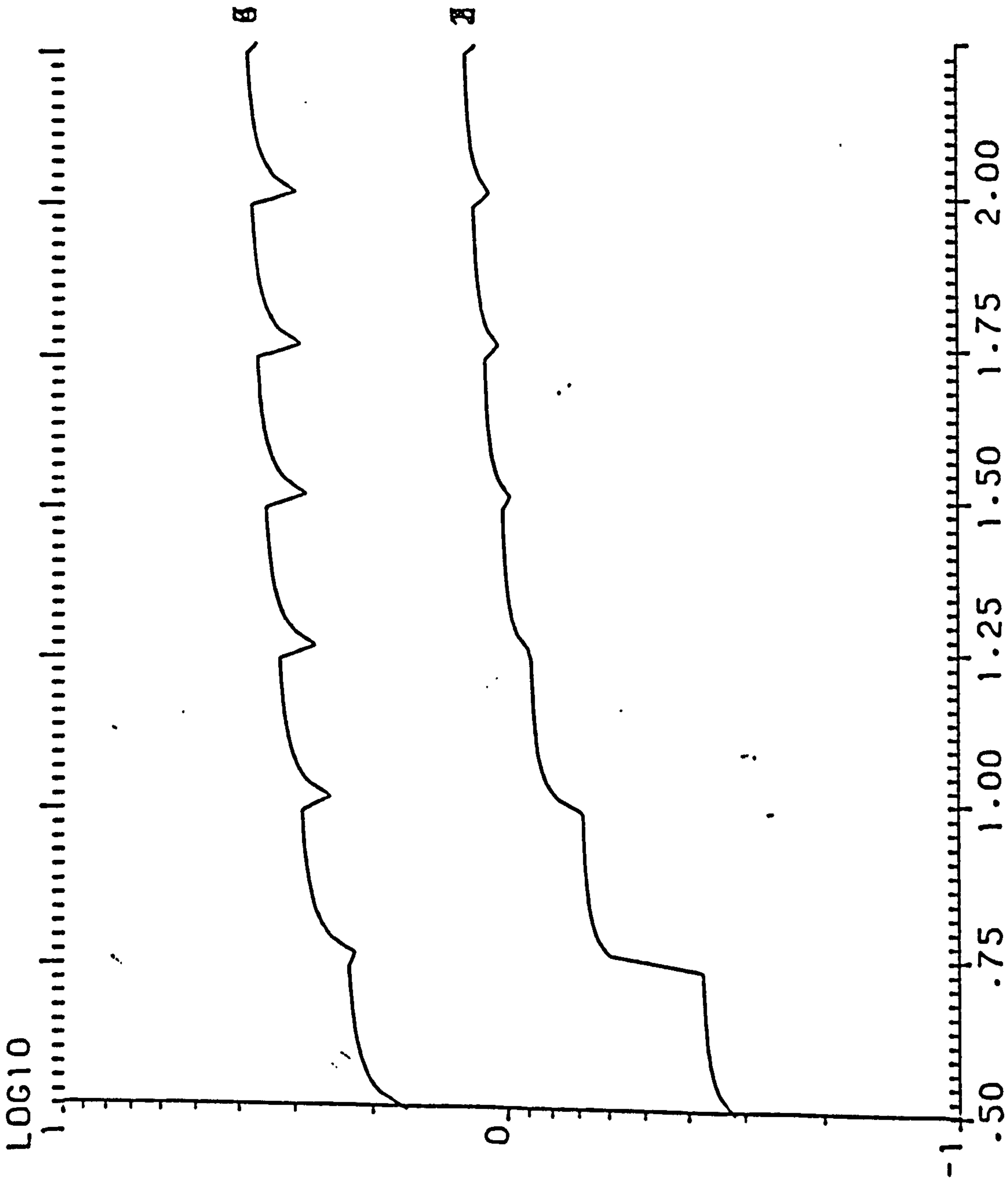

S. EFFICIENCY W. THICKNESS= .24M W. ORIENTATION=112.50

WD= 6M HD1= 1M HD2= 1M HOUSE T.=2.0 ST.

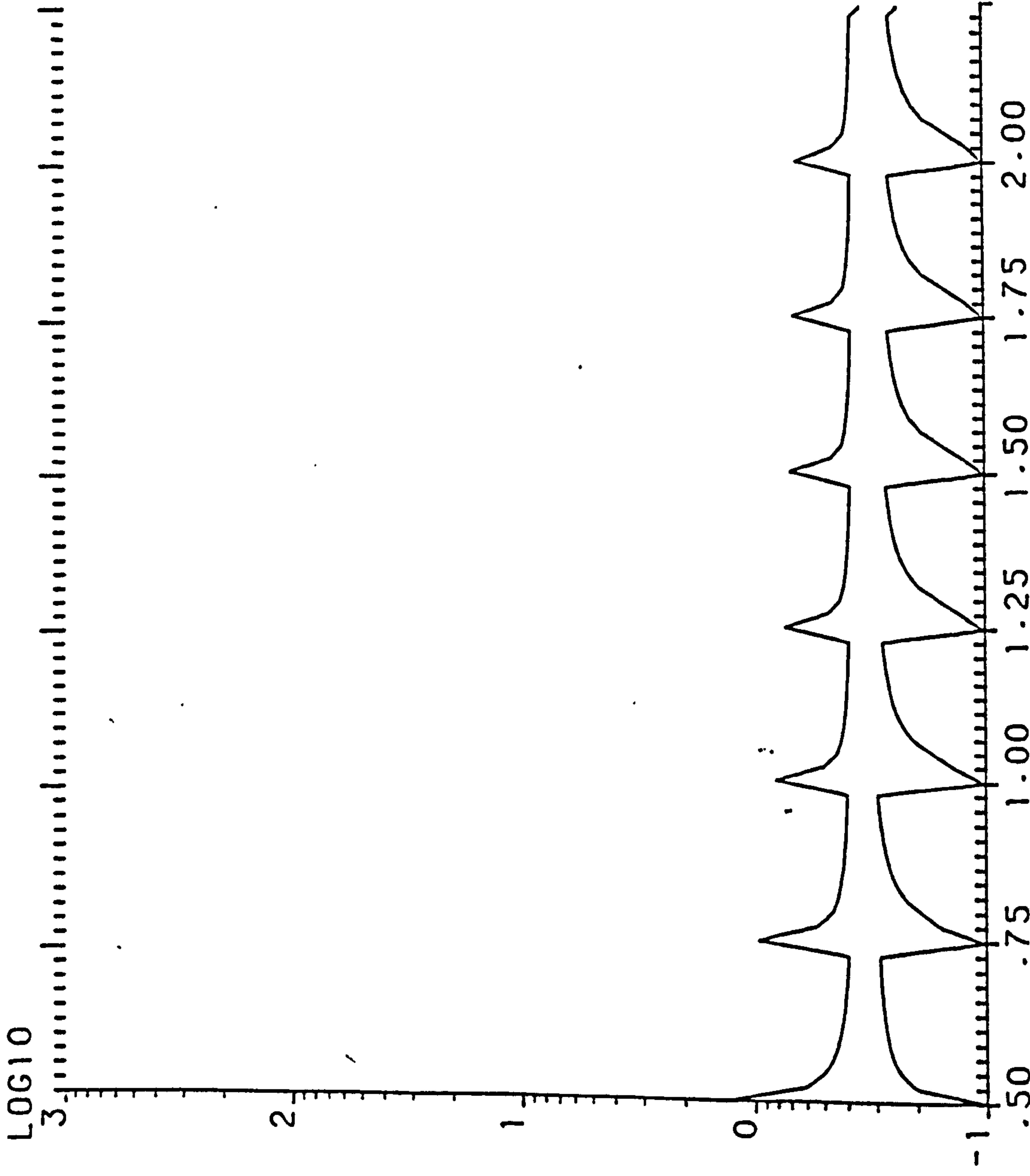

Y. EFFICIENCY W. THICKNESS= .24M W. ORIENTATION=135.00

WD= 6M HD1= 1M HD2= 1M HOUSE T.=2.0 ST.

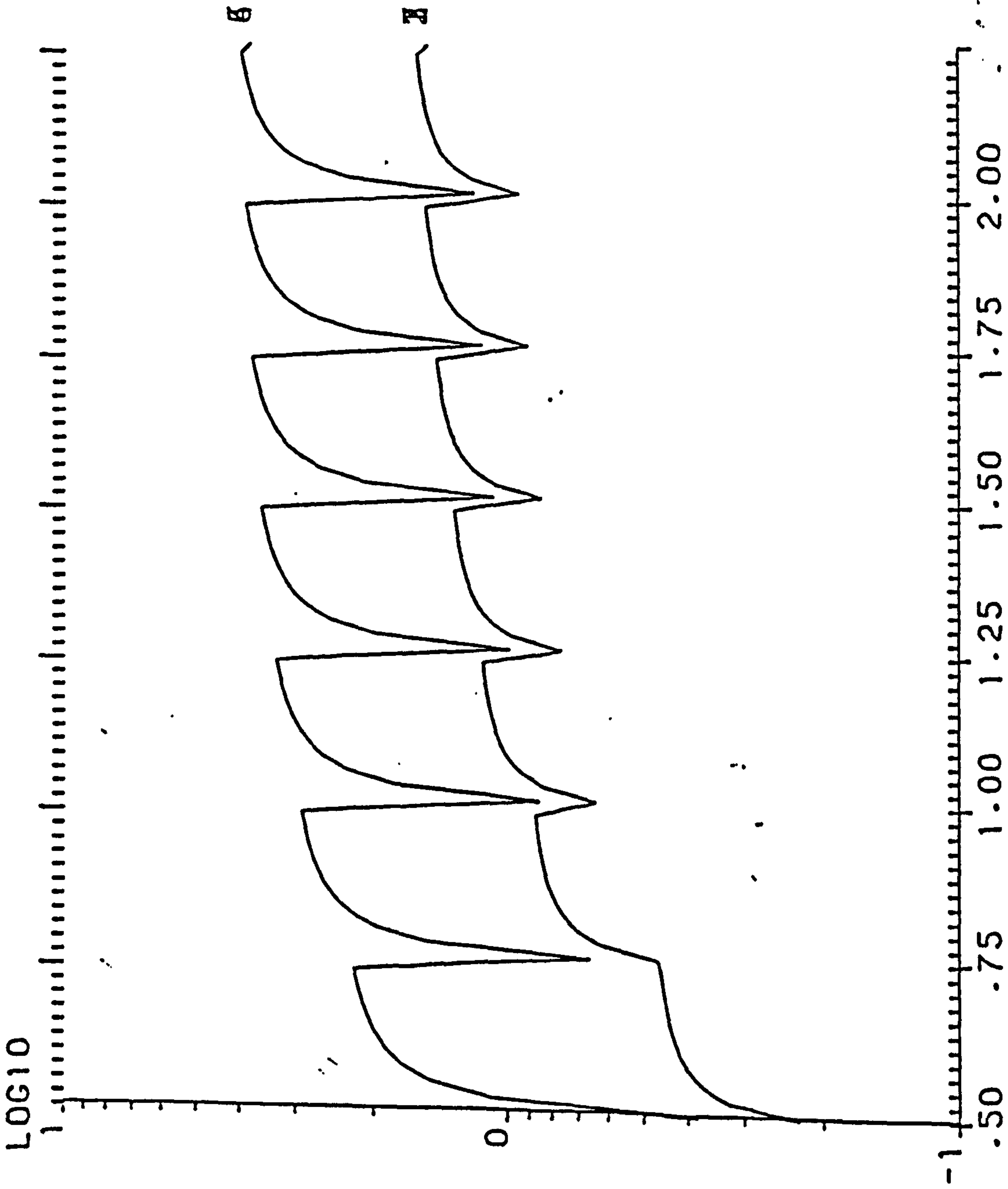

S. EFFICIENCY W. THICKNESS= .24M W. ORIENTATION=135.00

WD= 6M HD1= 1M HD2= 1M HOUSE T.=2.0 ST.

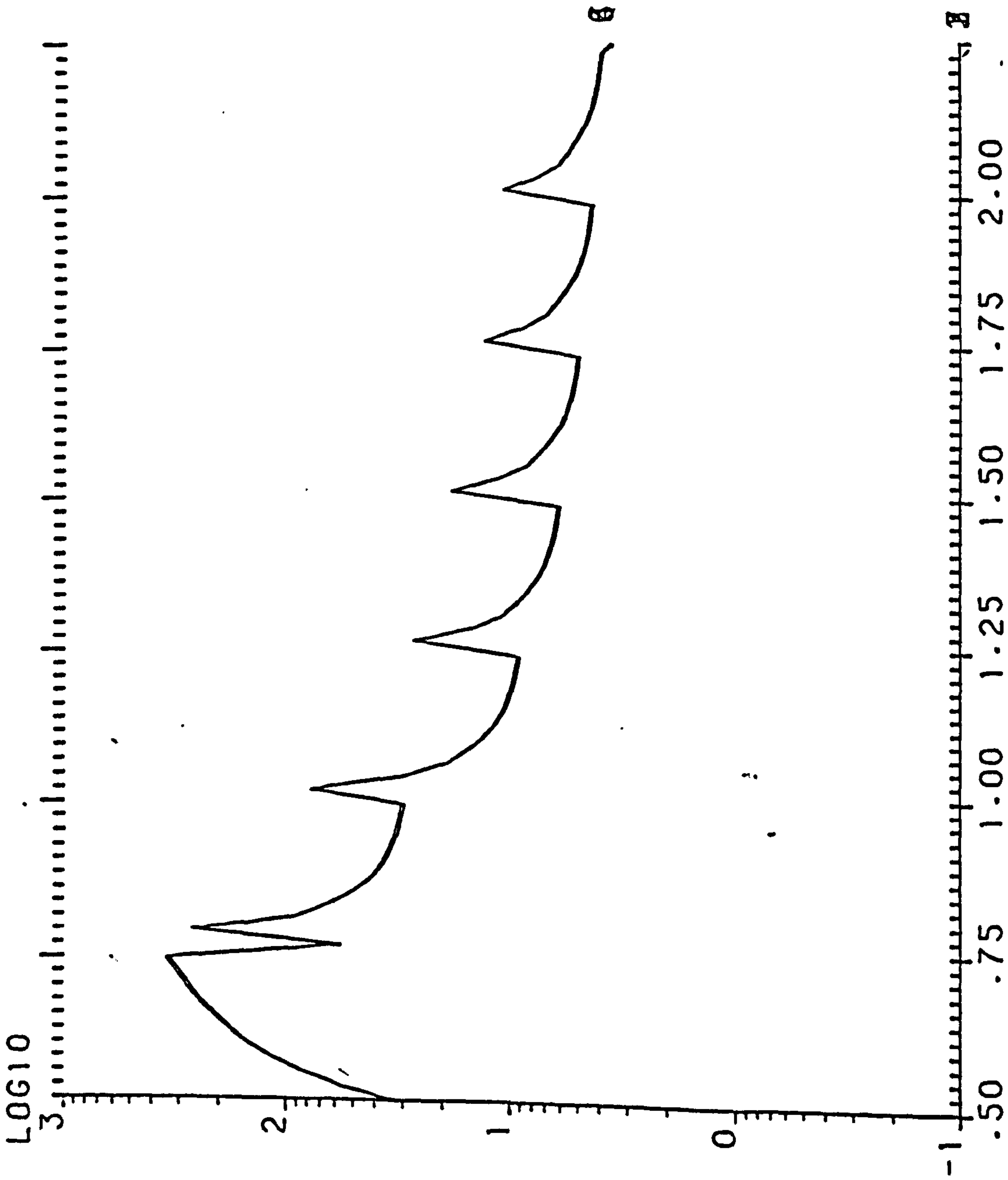

Y. EFFICIENCY W. THICKNESS= .24M W. ORIENTATION=157.50

WD= 6M HD1= 1M HD2= 1M HOUSE T.=2.0 ST.



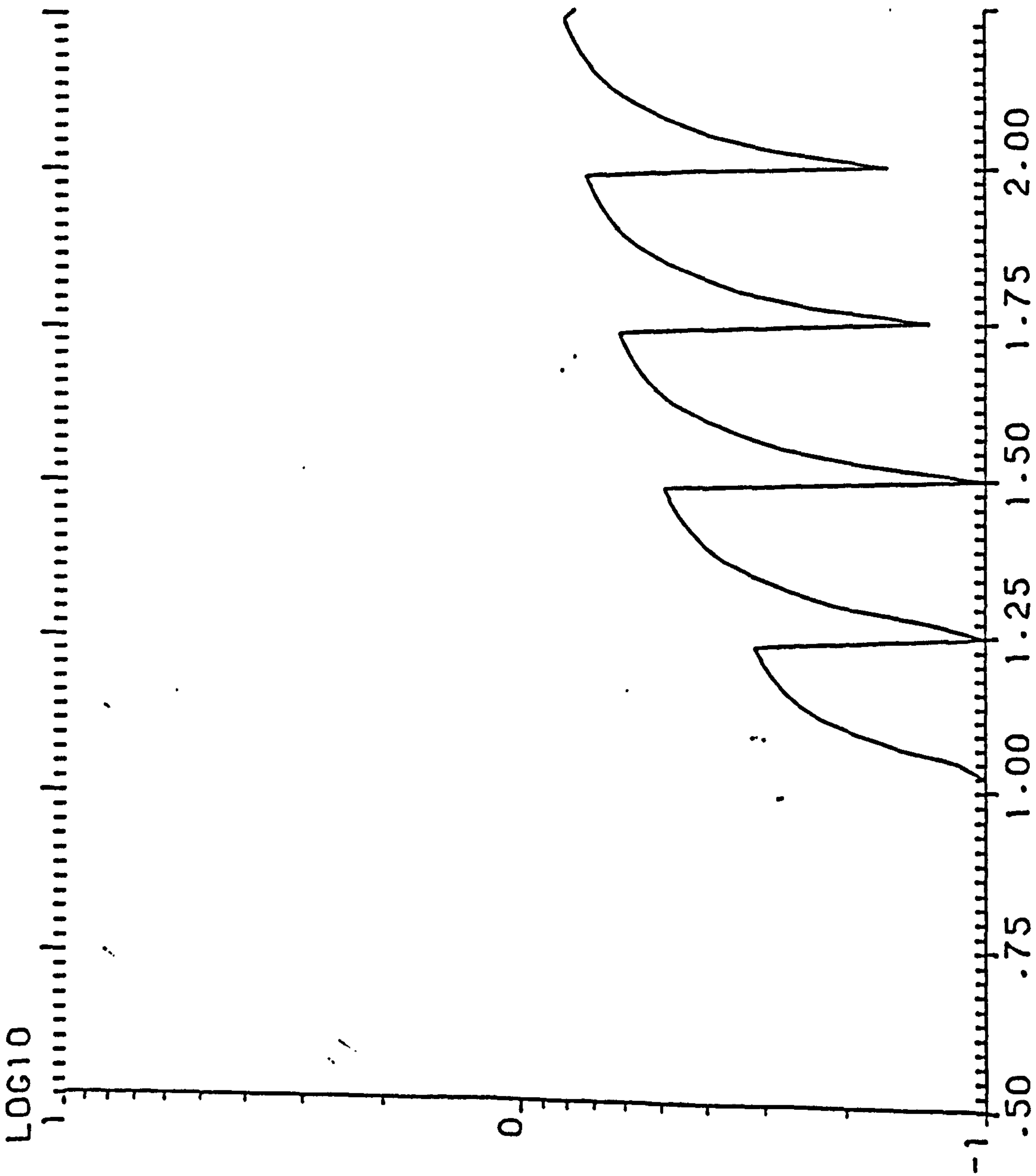

S. EFFICIENCY W. THICKNESS= .24M W. ORIENTATION=157.50

WD= 6M HD1= 1M HD2= 1M HOUSE T.=2.0 ST.

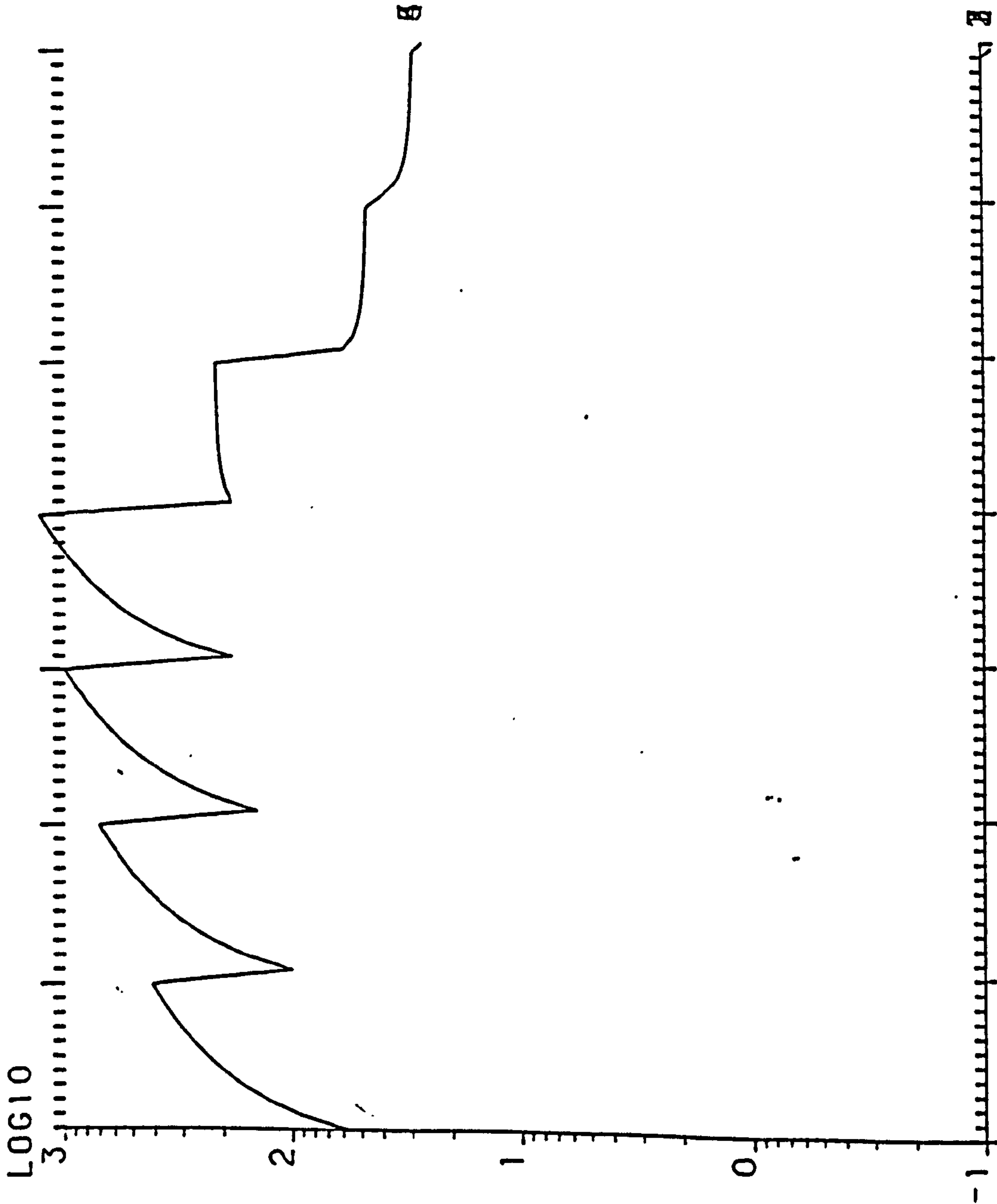

Y. EFFICIENCY W. THICKNESS= .24M W. ORIENTATION=180.00  
WD= 6M HD1= 1M HD2= 1M HOUSE T.=2.0 ST.

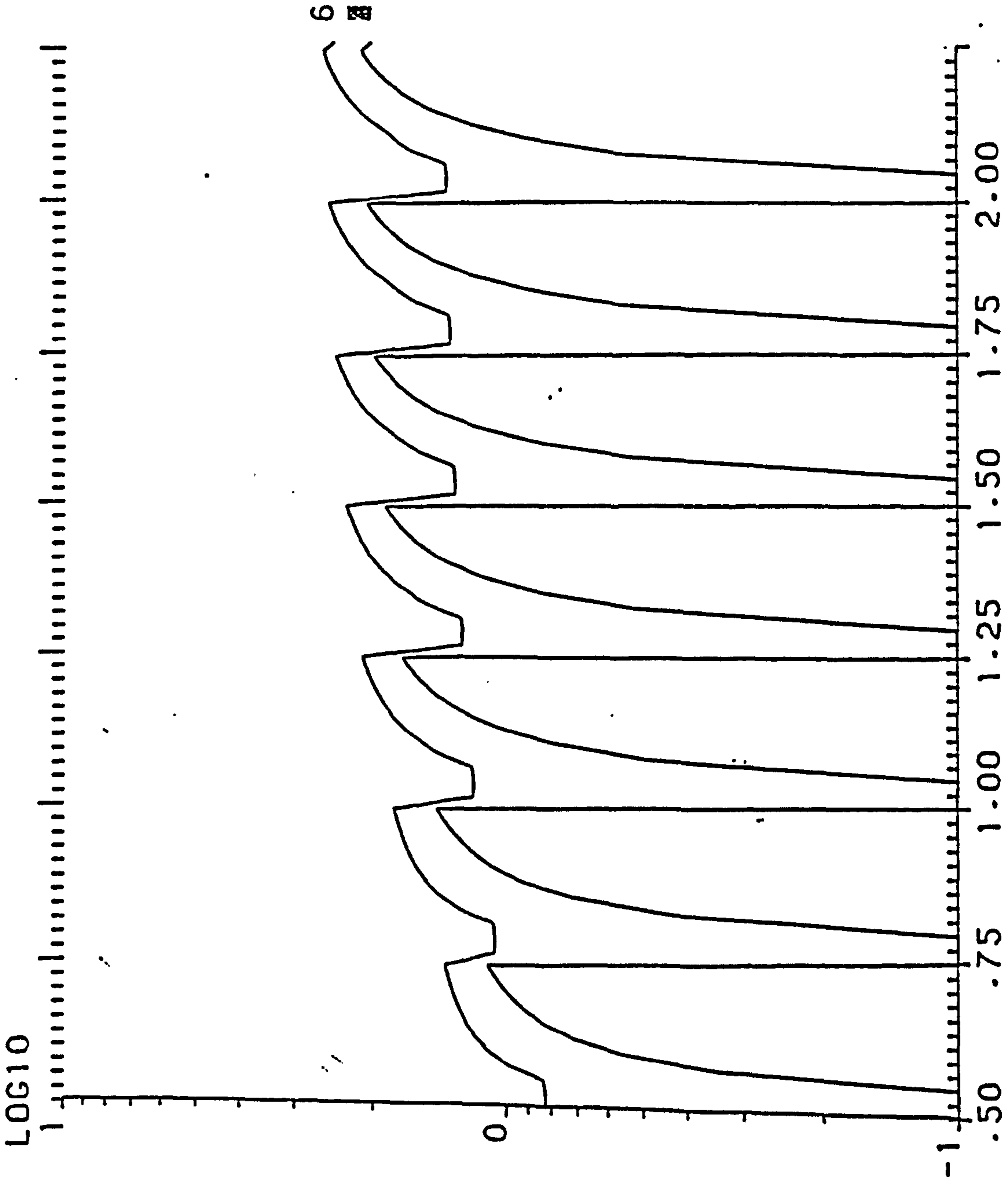

S. EFFICIENCY W. THICKNESS= .36M W. ORIENTATION= .00

WD= 6M HD1= 1M HD2= 1M HOUSE T.=2.0 ST.



LOG10

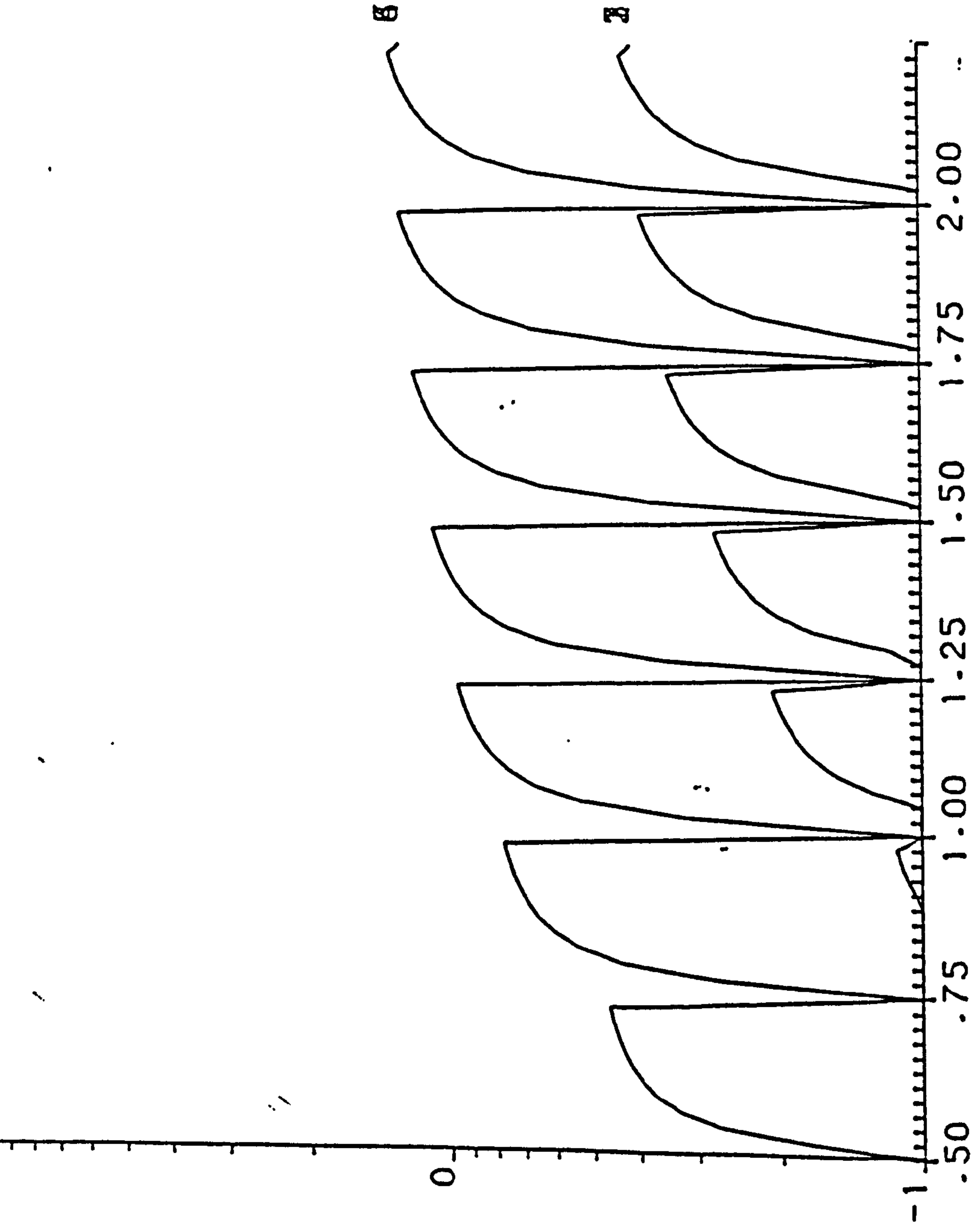

S. EFFICIENCY    W. THICKNESS= .36M    W. ORIENTATION= 22.50

WD= 6M    HD1= 1M    HD2= 1M    HOUSE T.=2.0 ST.

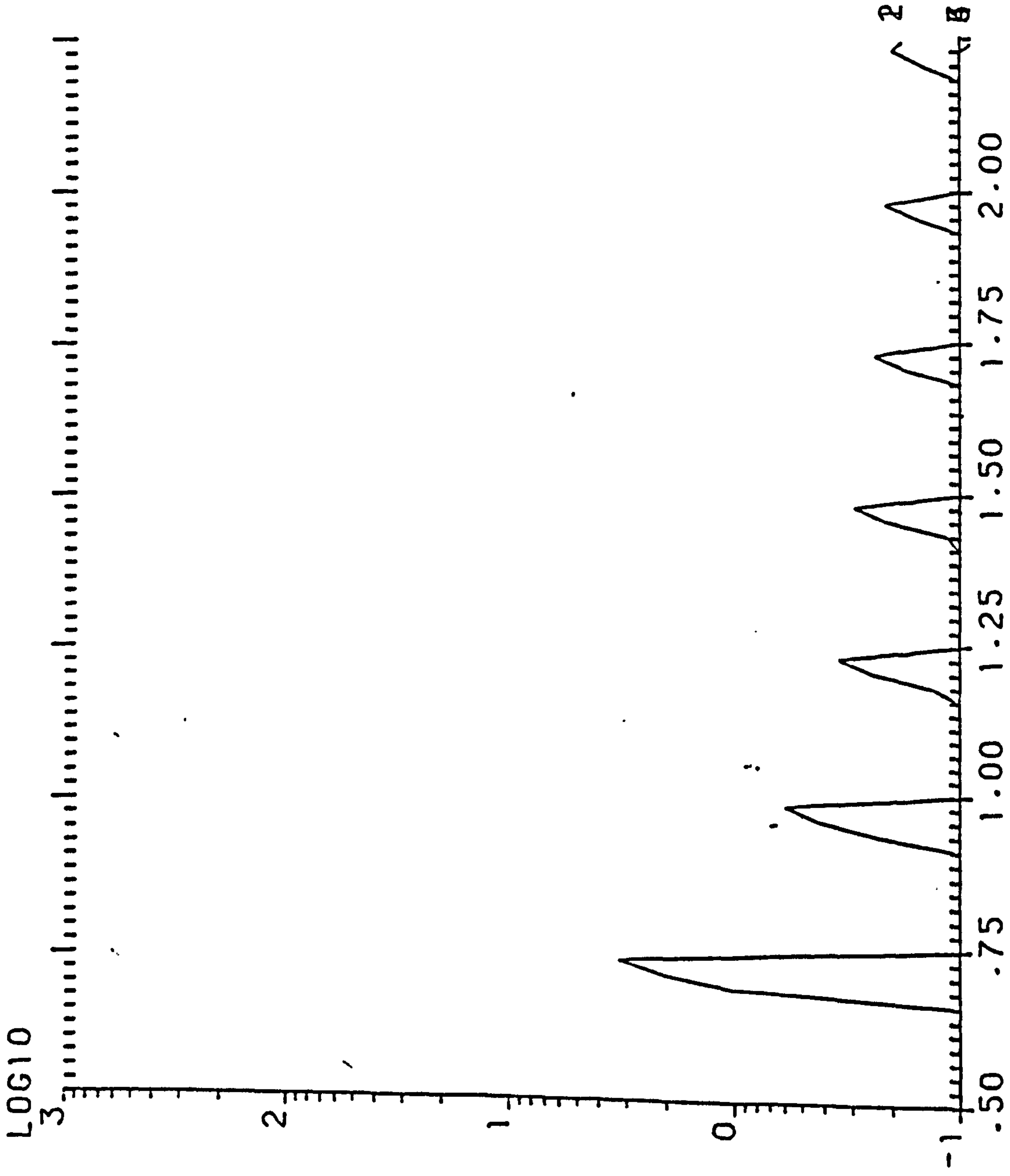

Y. EFFICIENCY W. THICKNESS= .36M W. ORIENTATION= 45.00

WD= 6M HD1= 1M HD2= 1M HOUSE T.=2.0 ST.



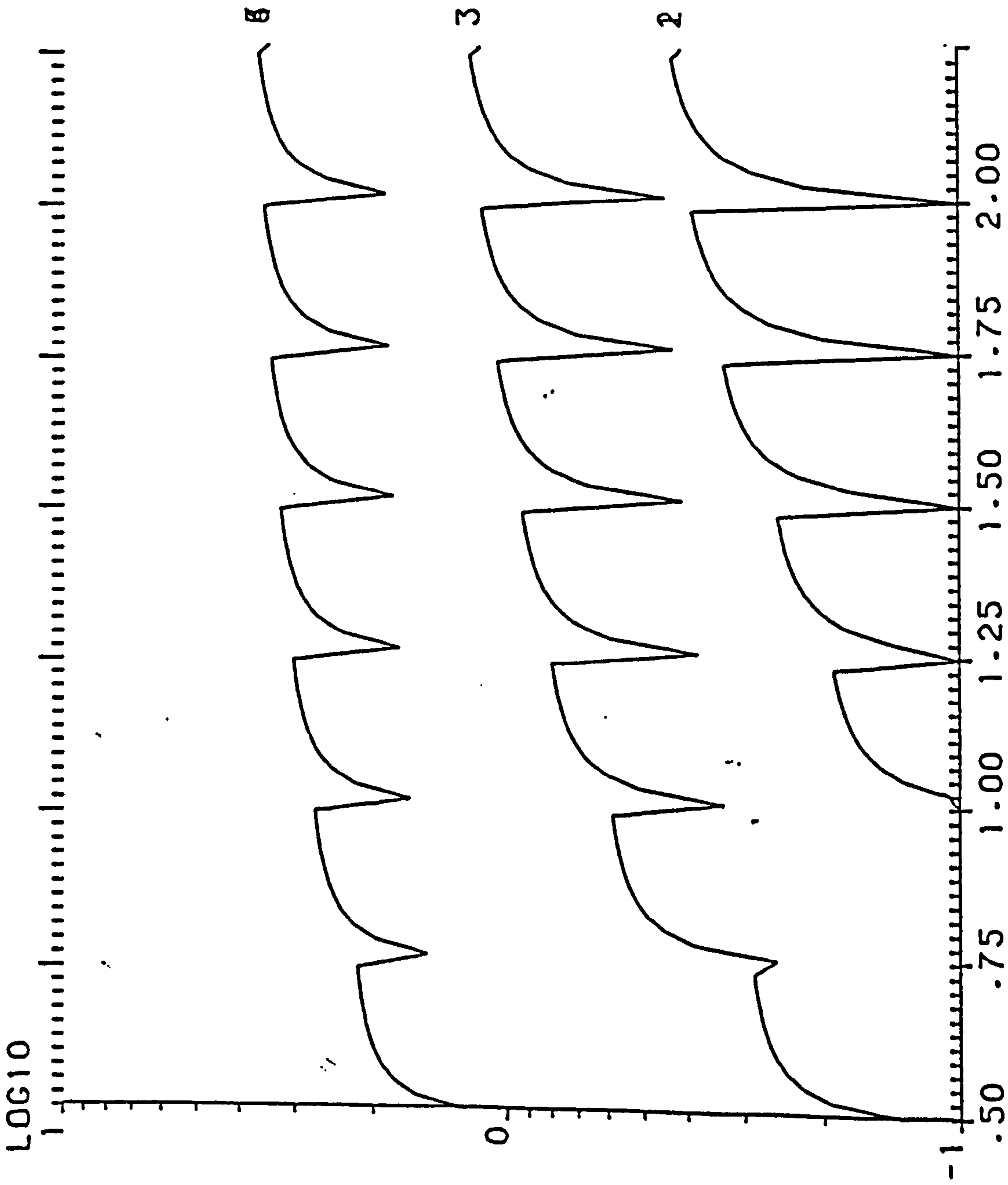

S. EFFICIENCY W. THICKNESS= .36M W. ORIENTATION= 45.00

WD= 6M HD1= 1M HD2= 1M HOUSE T.=2.0 ST.

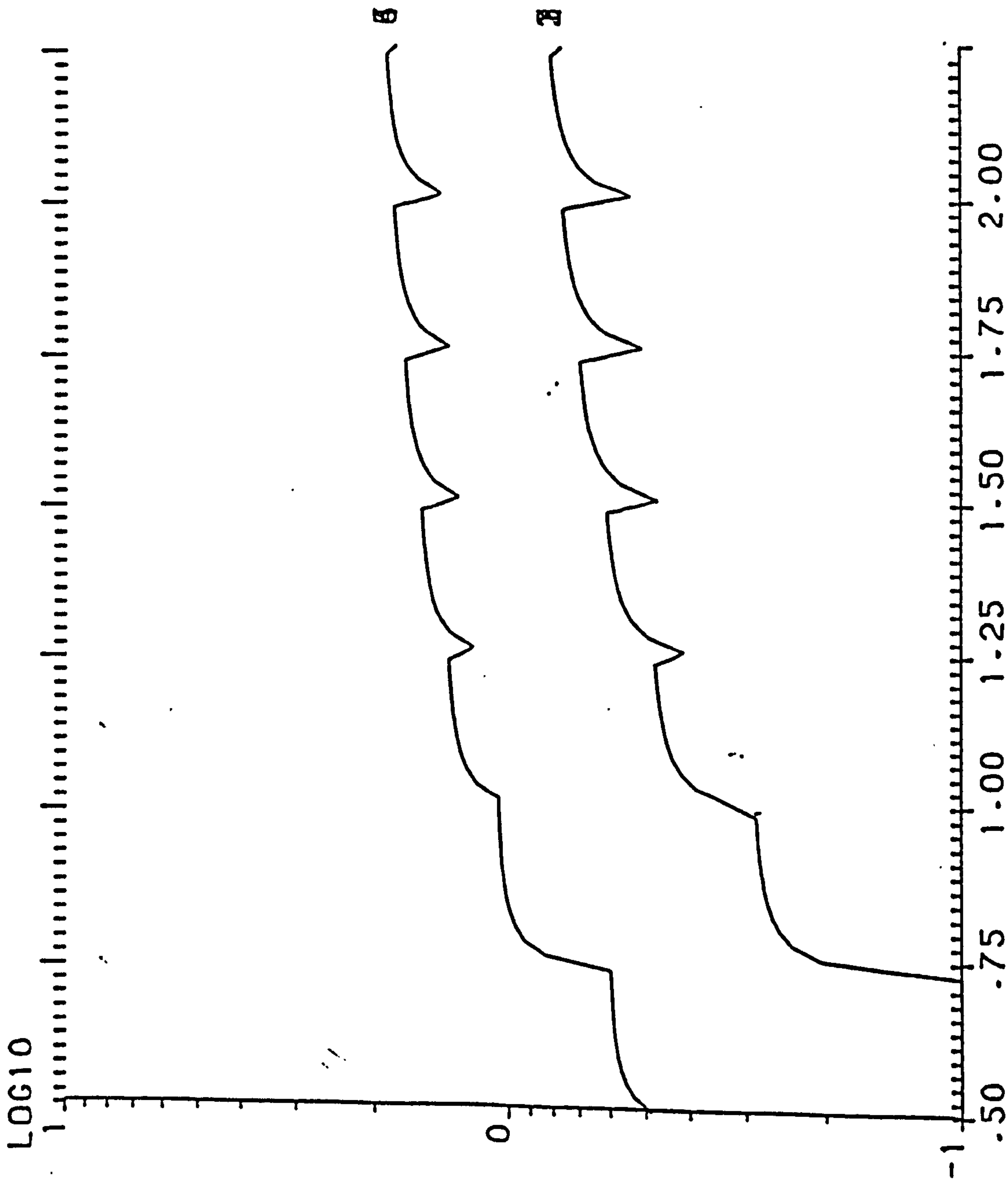

S. EFFICIENCY W. THICKNESS= .36M W. ORIENTATION= 67.50

WD= 6M HD1= 1M HD2= 1M HOUSE T.=2.0 ST.

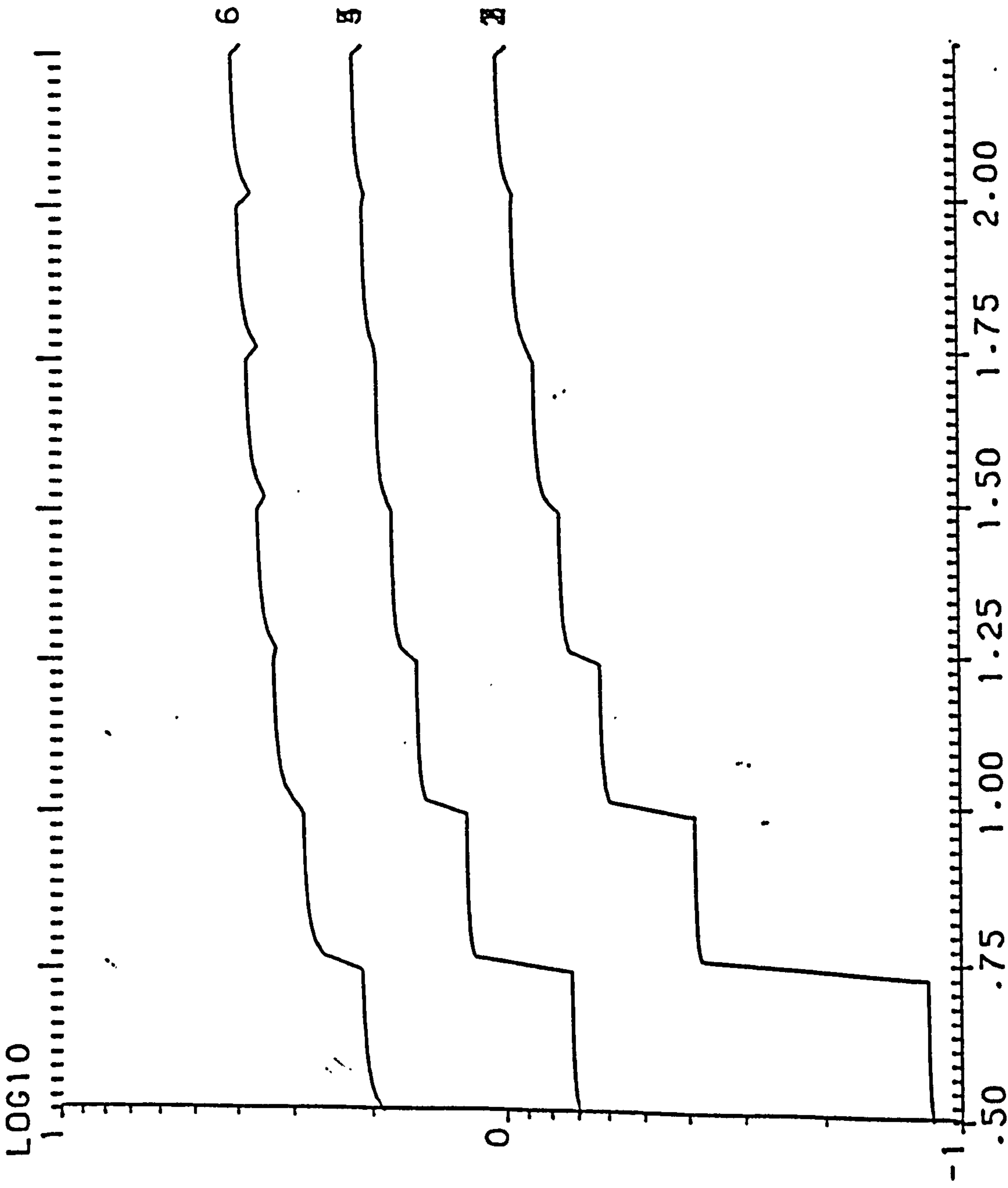

S. EFFICIENCY W. THICKNESS= .36M W. ORIENTATION= 90.00

WD= 6M HD1= 1M HD2= 1M HOUSE T.=2.0 ST.



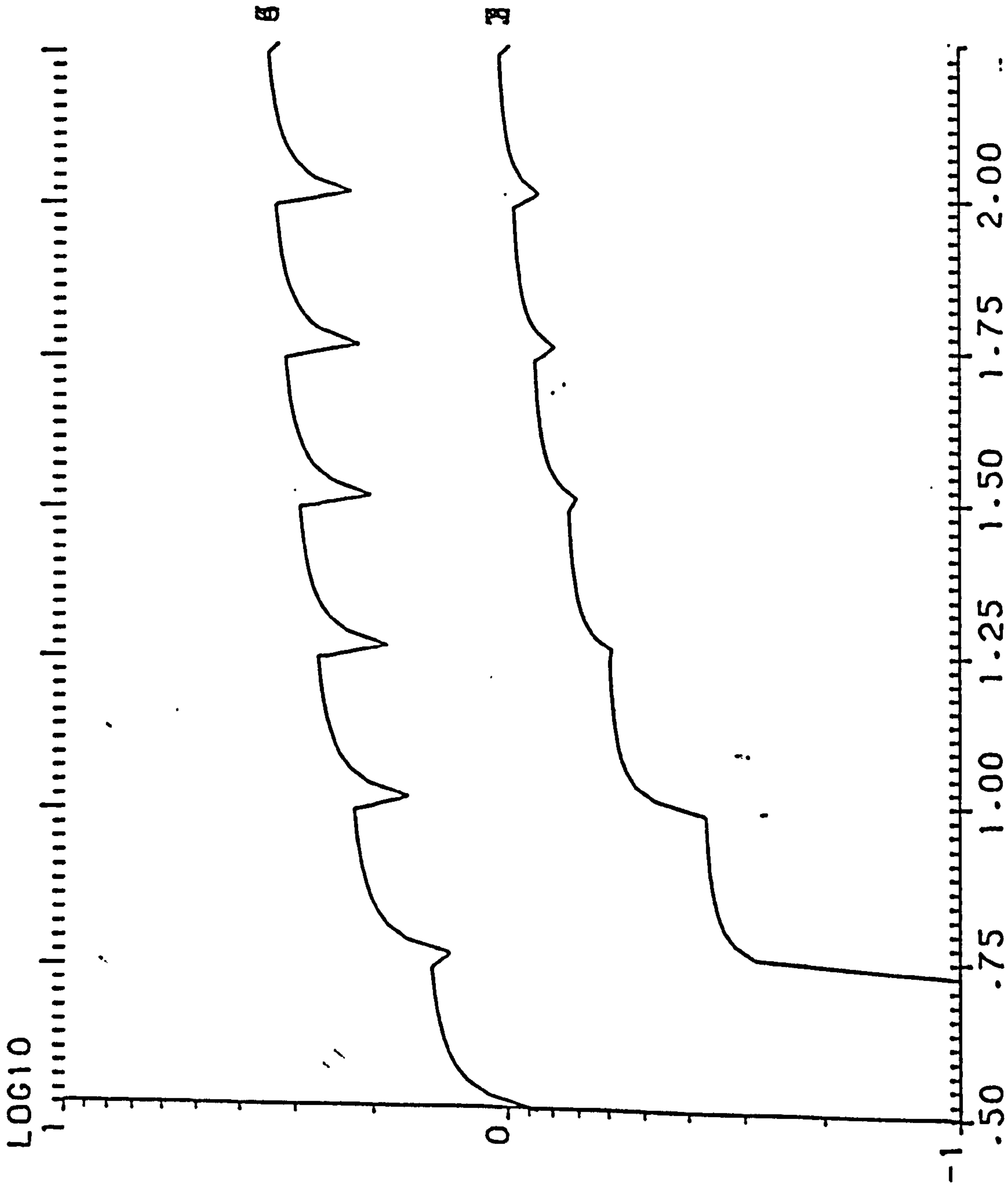

S. EFFICIENCY W. THICKNESS= .36M W. ORIENTATION=112.50

WD= 6M HD1= 1M HD2= 1M HOUSE T.=2.0 ST.



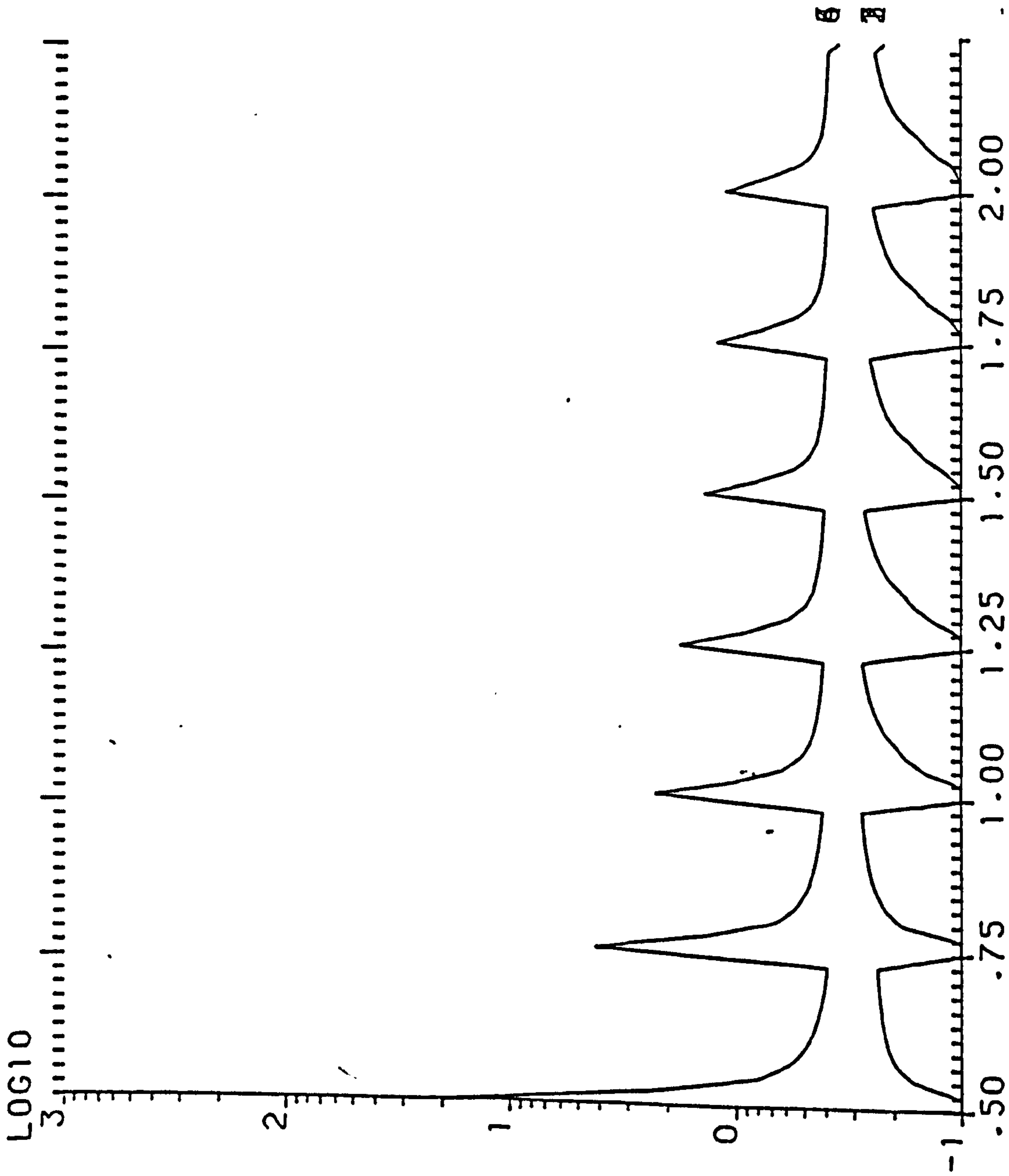

Y. EFFICIENCY W. THICKNESS= .36M W. ORIENTATION=135.00

WD= 6M HD1= 1M HD2= 1M HOUSE T.=2.0 ST.



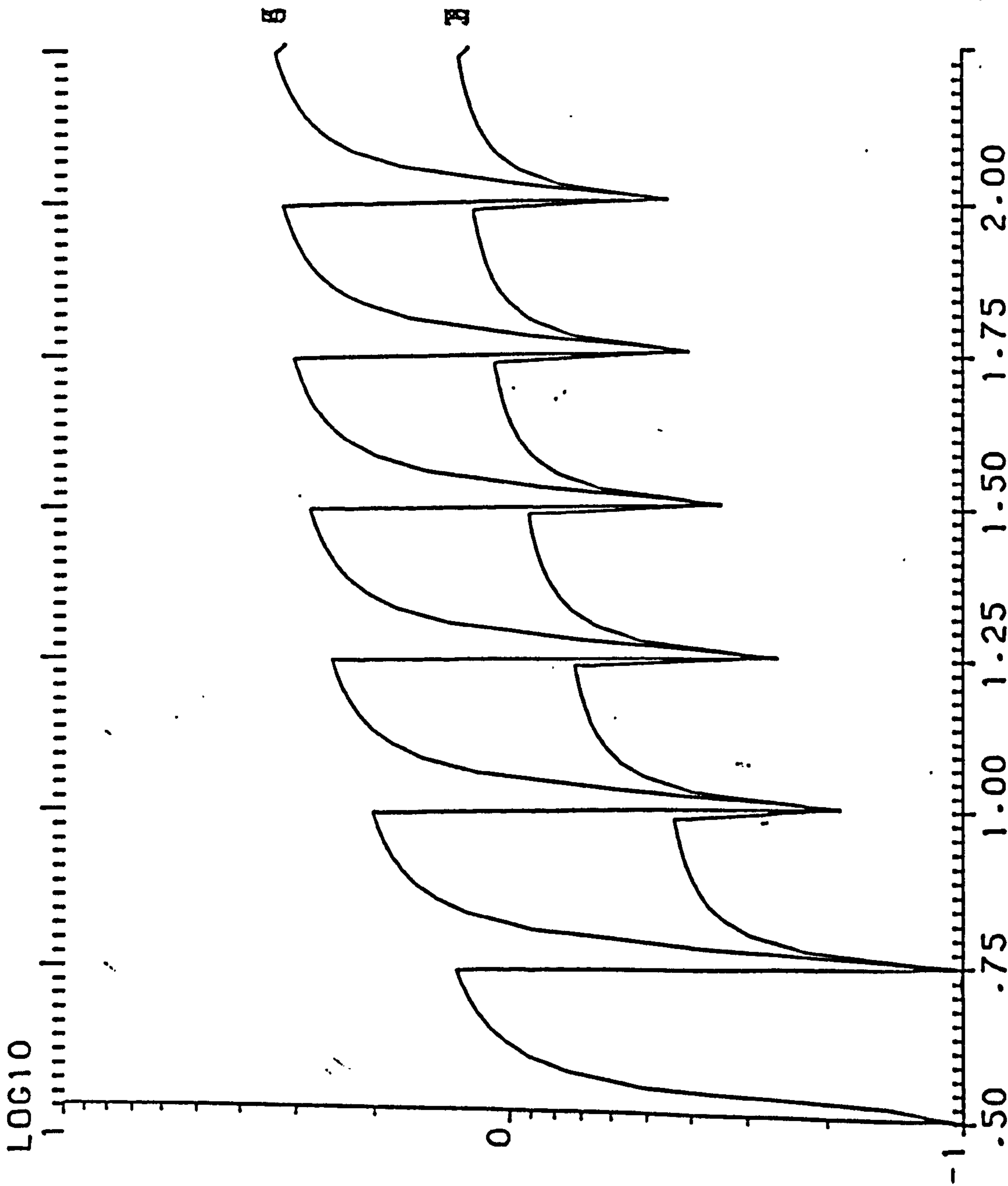

S. EFFICIENCY W. THICKNESS= .36M W. ORIENTATION=135.00

WD= 6M HD1= 1M HD2= 1M HOUSE T.=2.0 ST.

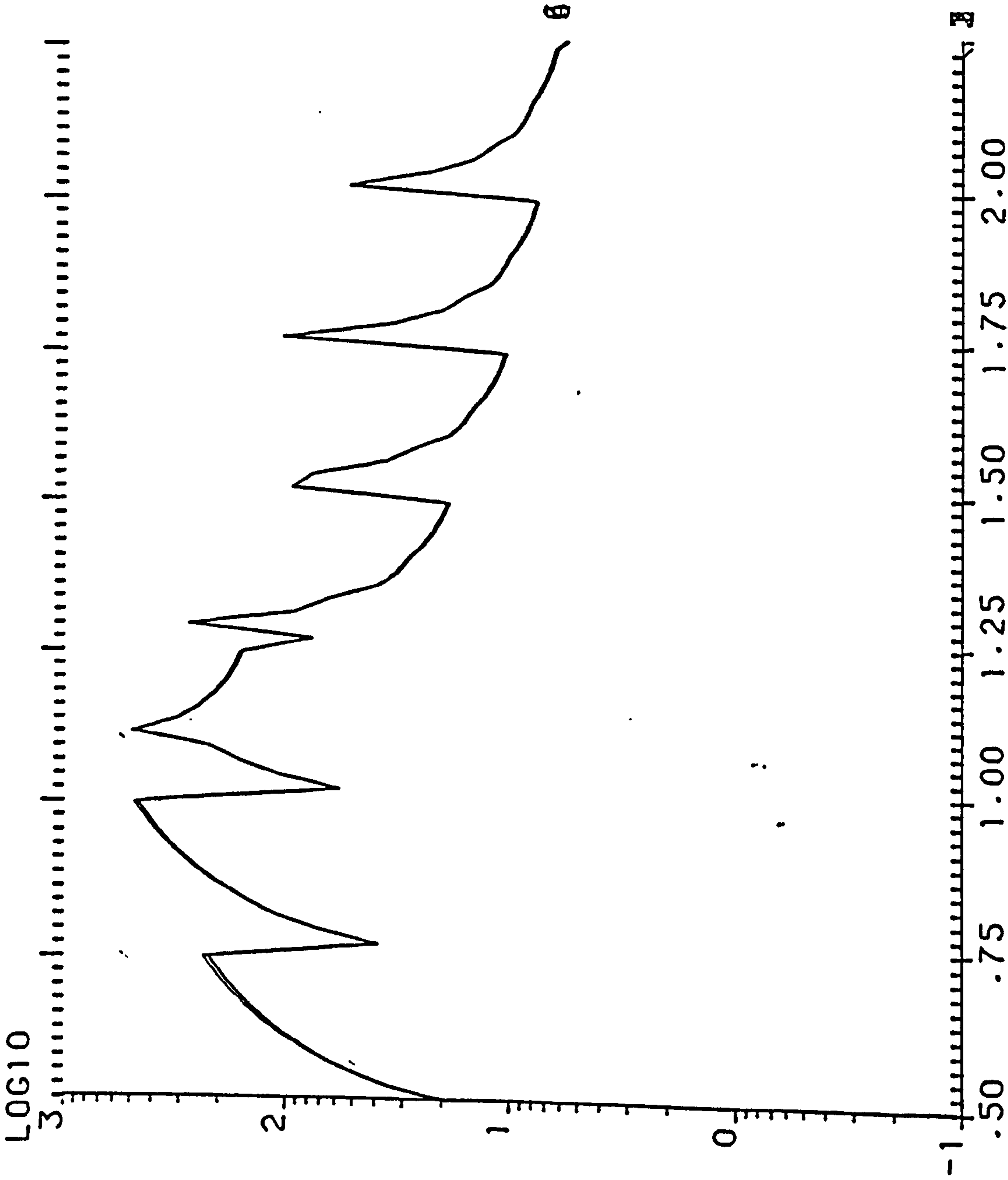

Y. EFFICIENCY W. THICKNESS= .36M W. ORIENTATION=157.50

WD= 6M HD1= 1M HD2= 1M HOUSE T.=2.0 ST.

LOG10

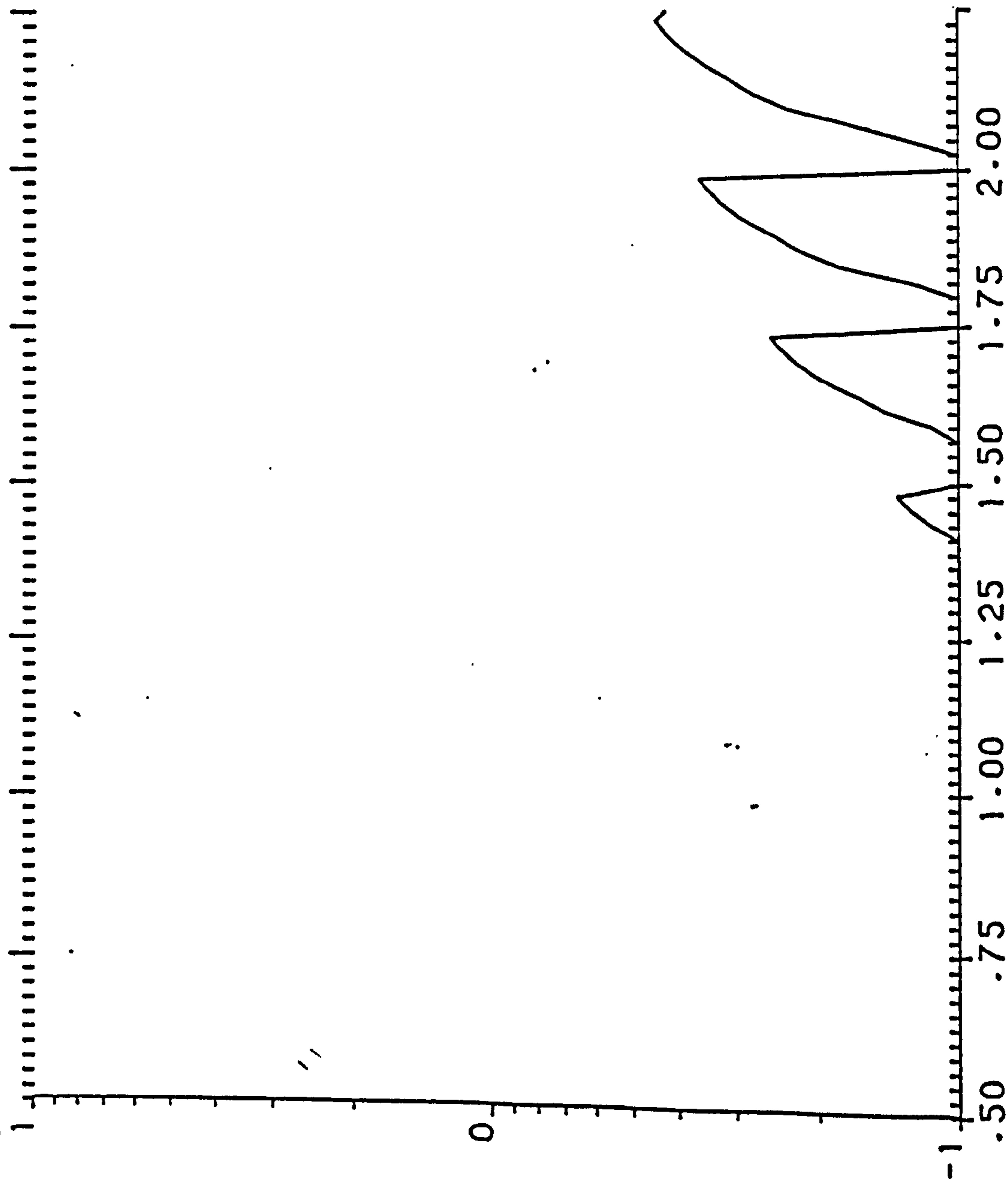

S. EFFICIENCY W. THICKNESS= .36M W. ORIENTATION=157.50

WD= 6M HD1= 1M HD2= 1M HOUSE T.=2.0 ST.

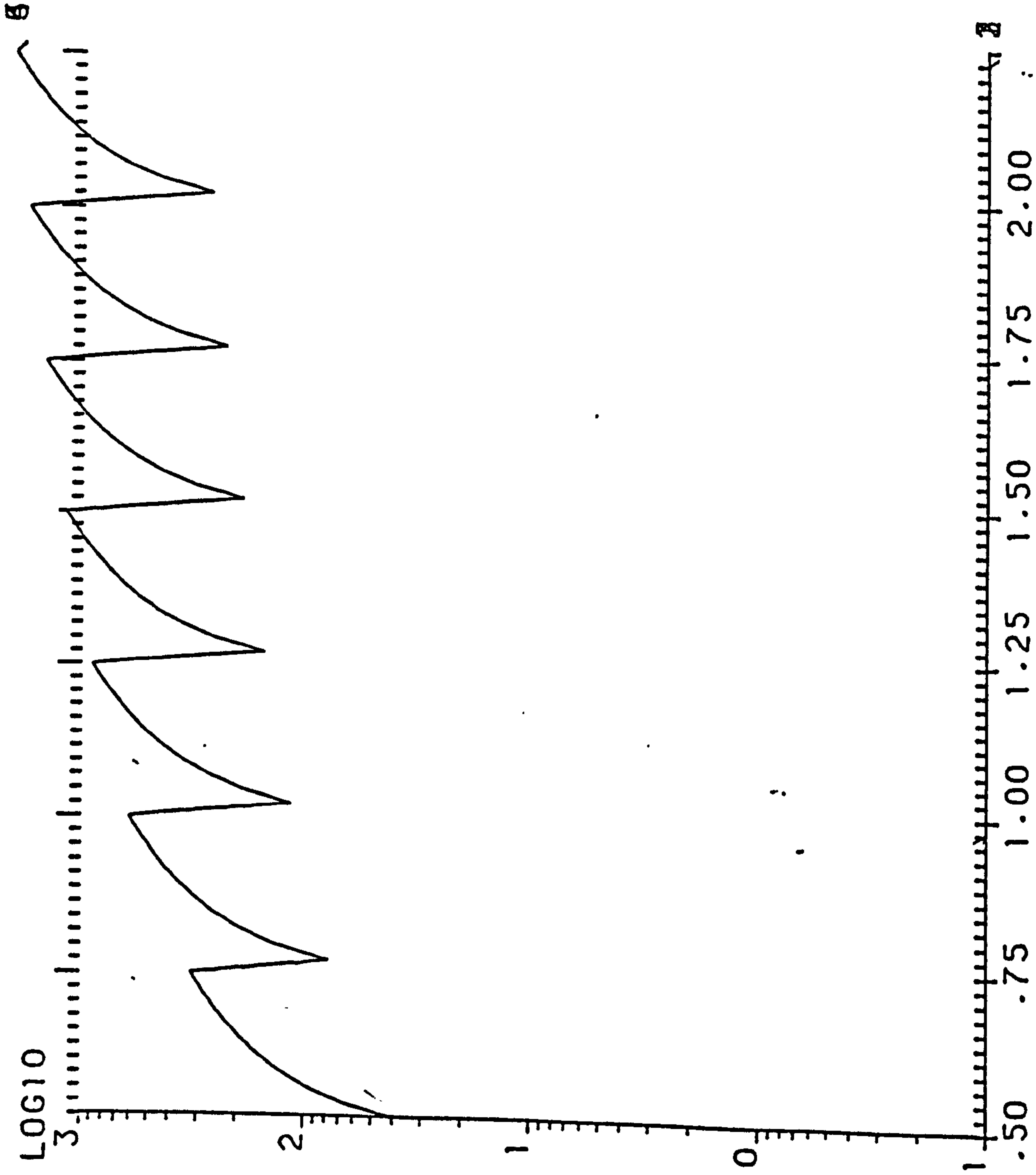

Y. EFFICIENCY W. THICKNESS= .36M W. ORIENTATION=180.00  
WD= 6M HD1= 1M HD2= 1M HOUSE T.=2.0 ST.

LOG10  
1  
0  
-1

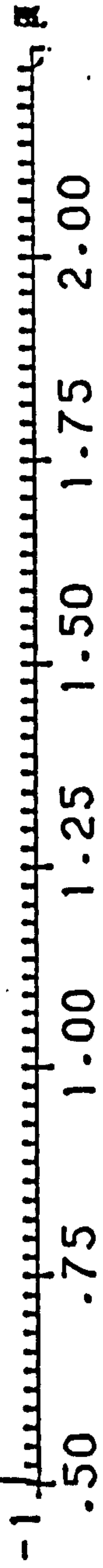

S. EFFICIENCY    W. THICKNESS= .36M    W. ORIENTATION=180.00

WD= 6M    HD1= 1M    HD2= 1M    HOUSE T.=2.0 ST.



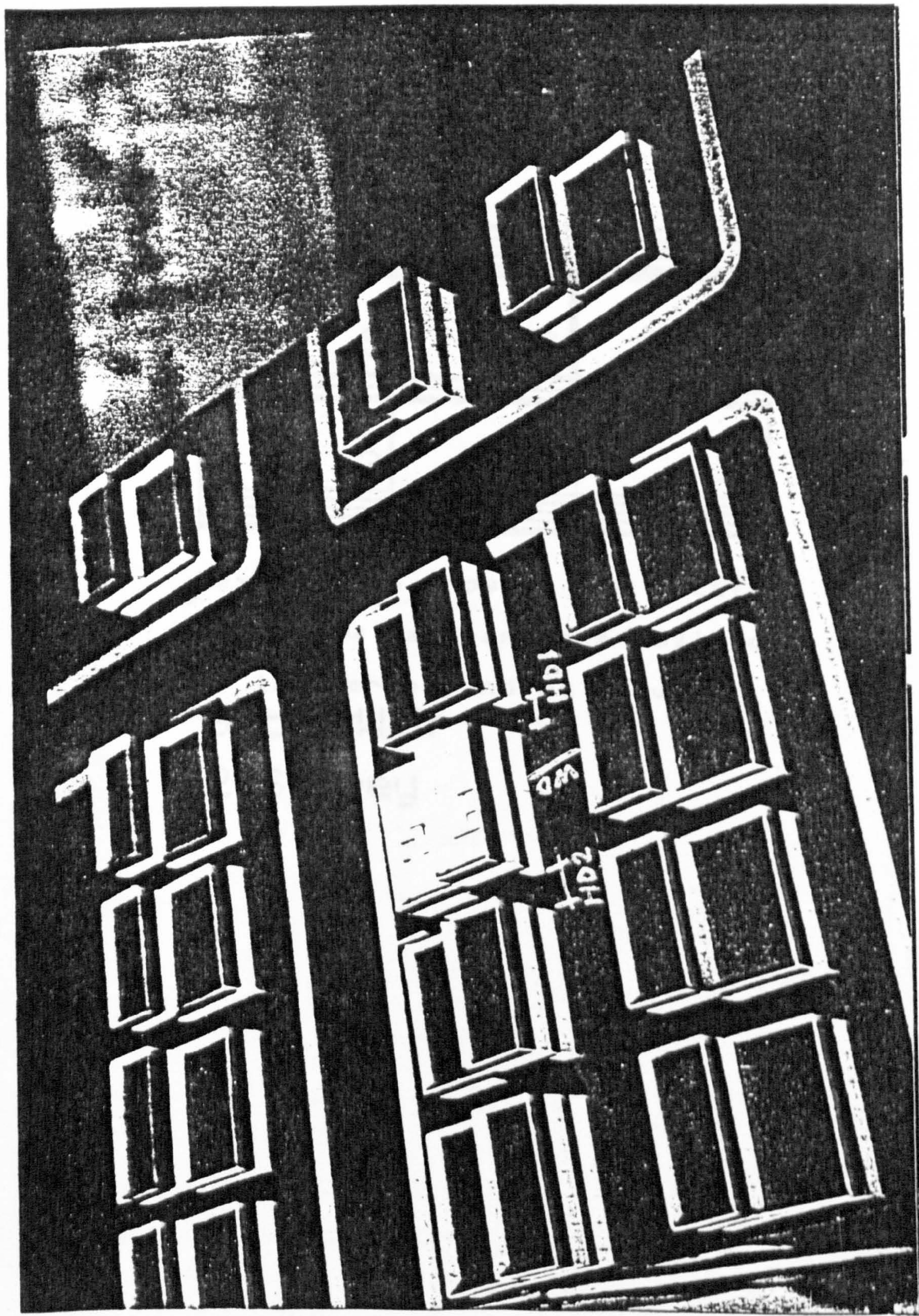

Model showing interhouse distances



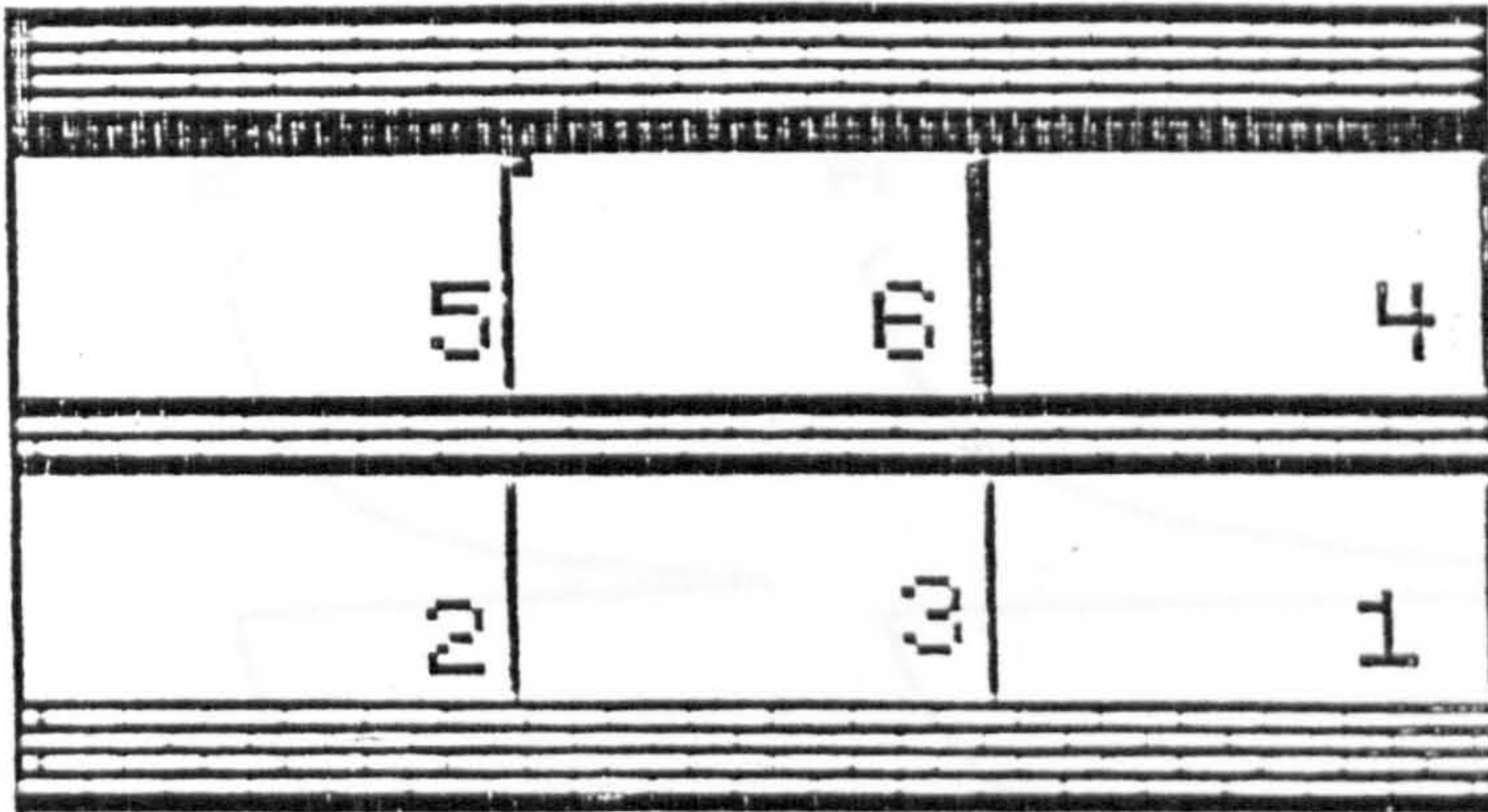

Key diagram showing the location  
of window data and the position  
of the corresponding curve  
Back Wall  
2 Storey

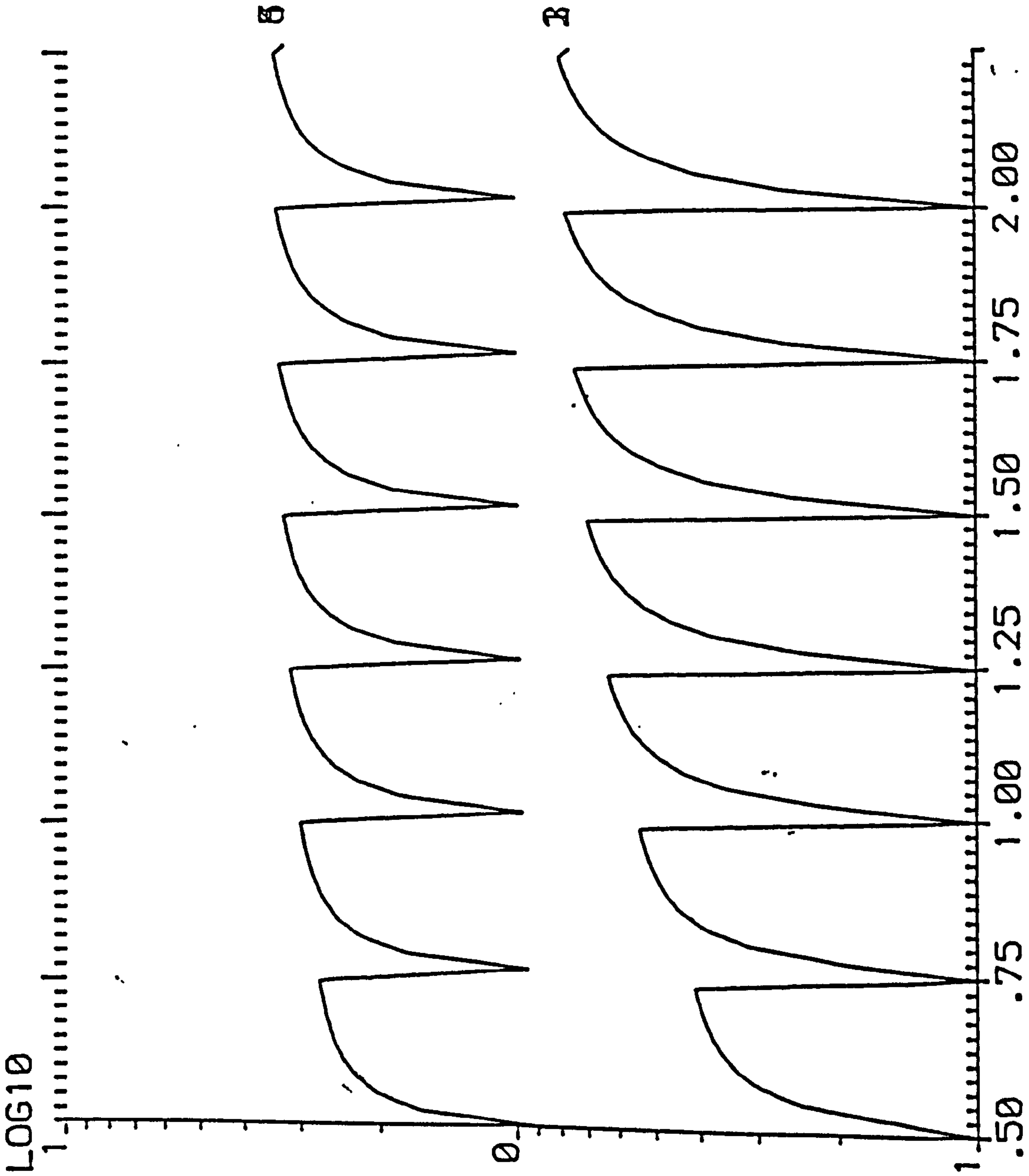

S. EFFICIENCY W. THICKNESS= .12M W. ORIENTATION= .00

WD= 8M HD1= 2M HD2= 2M HOUSE T.=2.0 ST.

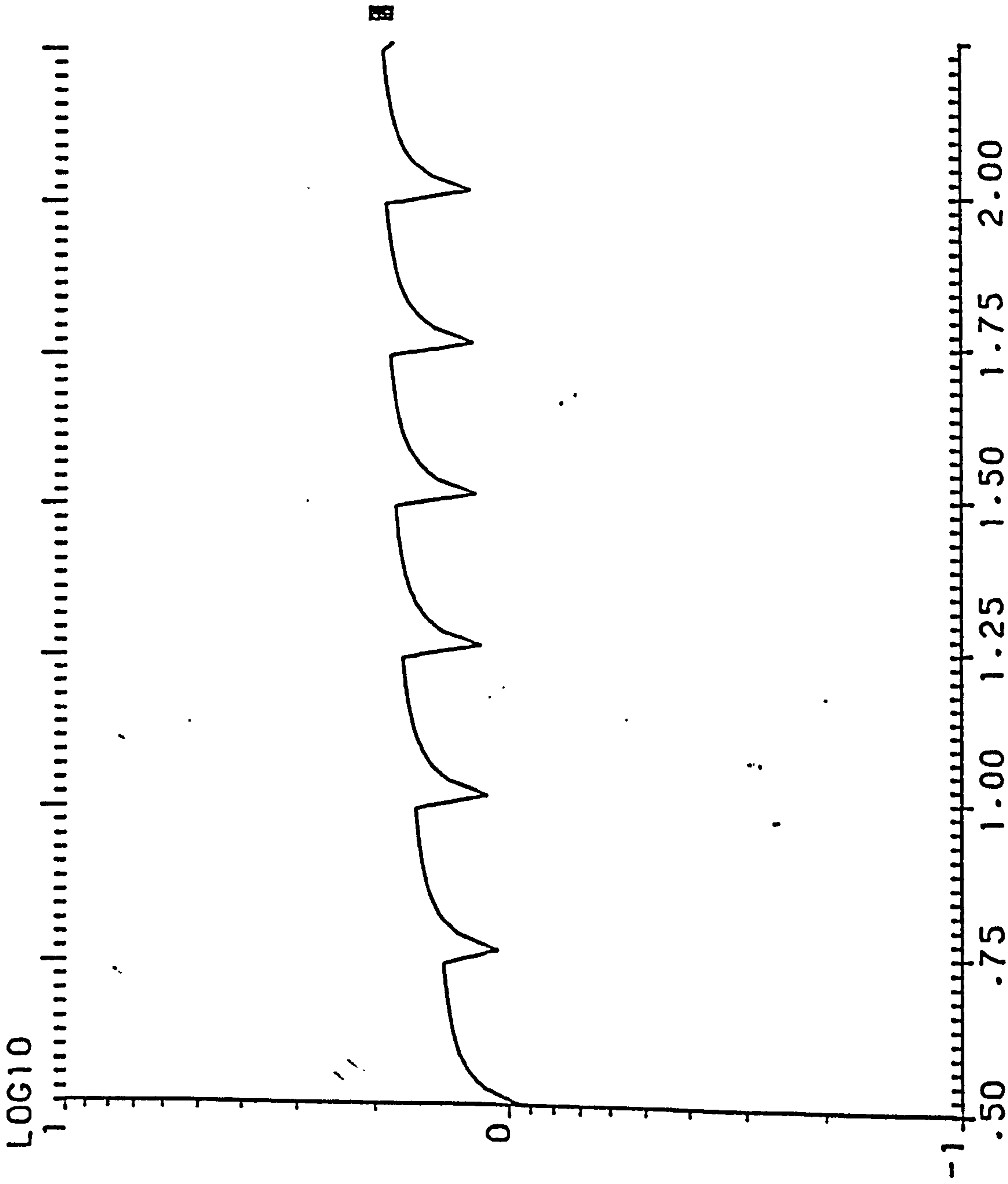

S. EFFICIENCY W. THICKNESS= .12M W. ORIENTATION= 22.50

WD= 8M HD1= 2M HD2= 2M HOUSE T.=2.0 ST.



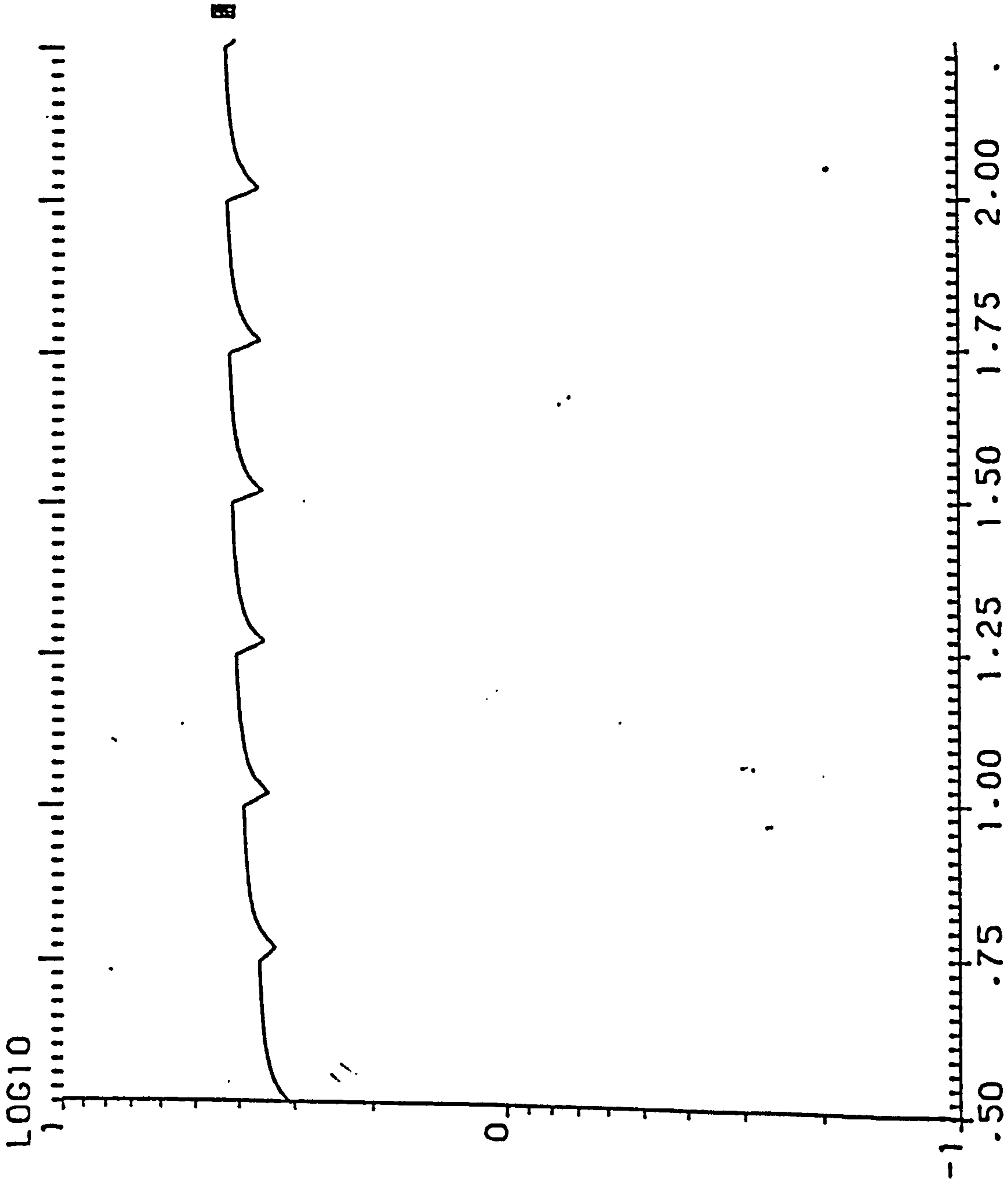

S. EFFICIENCY W. THICKNESS= .12M W. ORIENTATION= 45.00  
 WD= 8M HD1= 2M HD2= 2M HOUSE T.=2.0 ST.



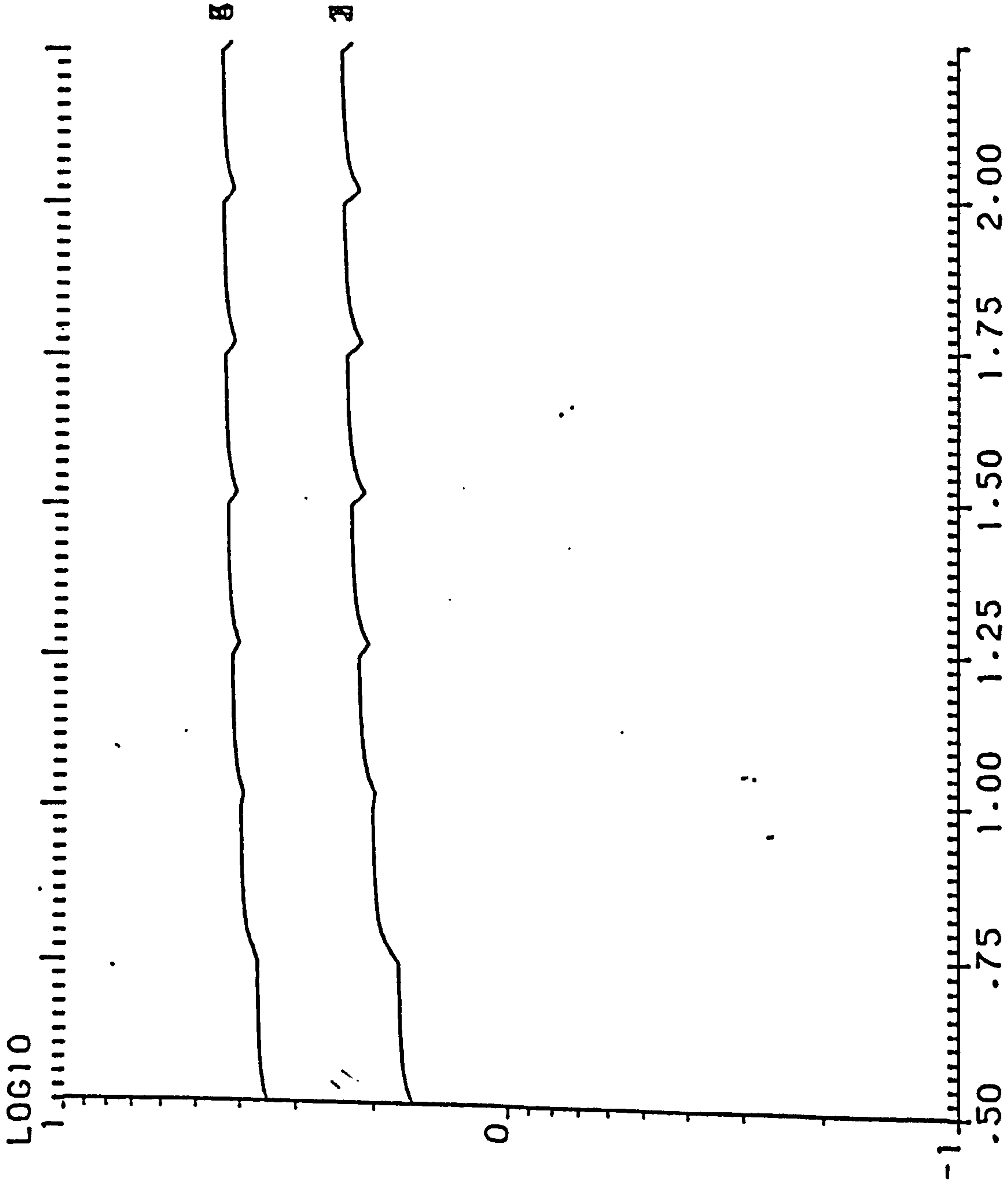

S. EFFICIENCY W. THICKNESS= .12M W. ORIENTATION= 67.50

WD= 8M HD1= 2M HD2= 2M HOUSE T.=2.0 ST.



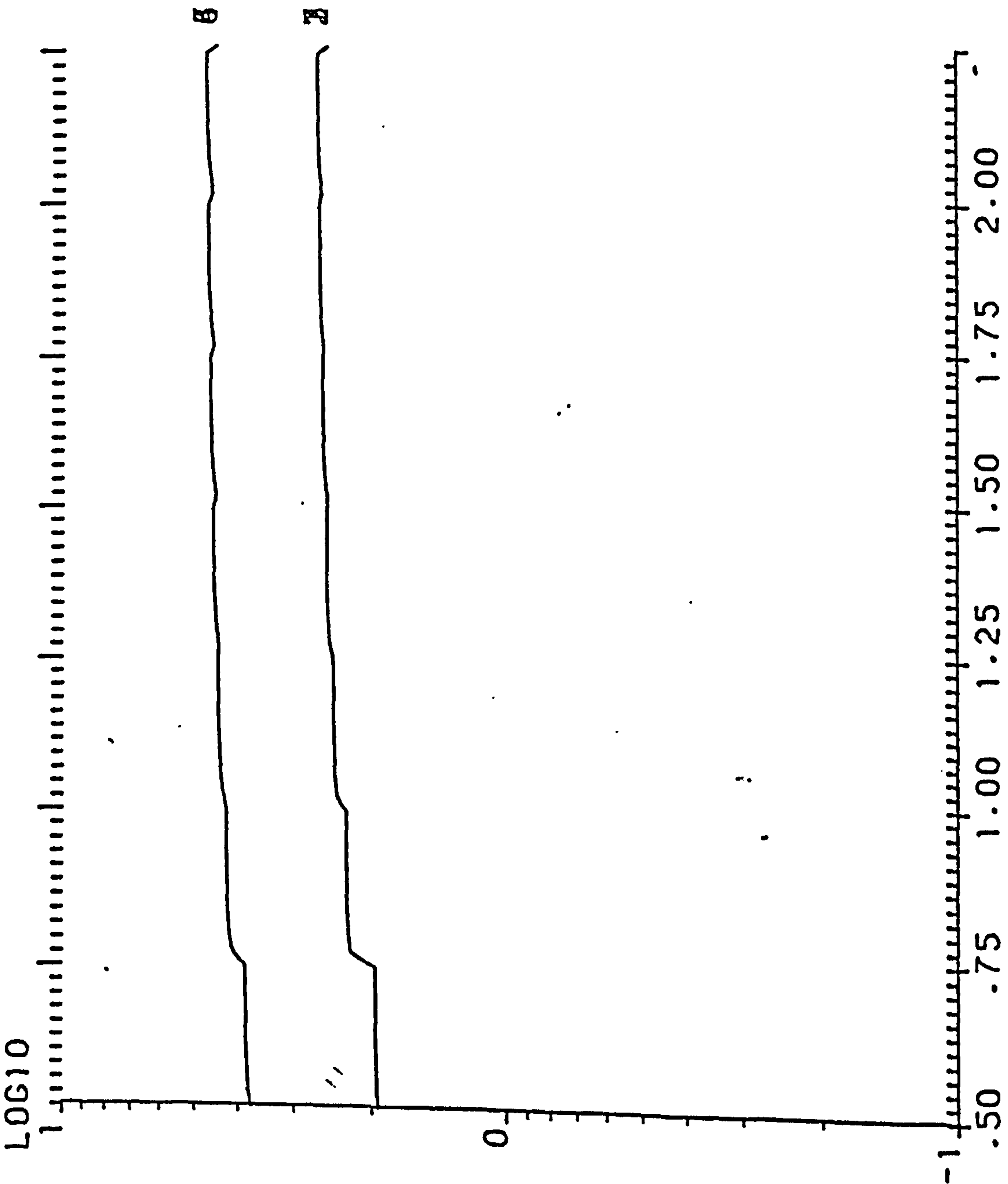

S. EFFICIENCY W. THICKNESS= .12M W. ORIENTATION= 90.00  
 HD1= 2M HD2= 2M HOUSE T.=2.0 ST.  
 WD= 8M



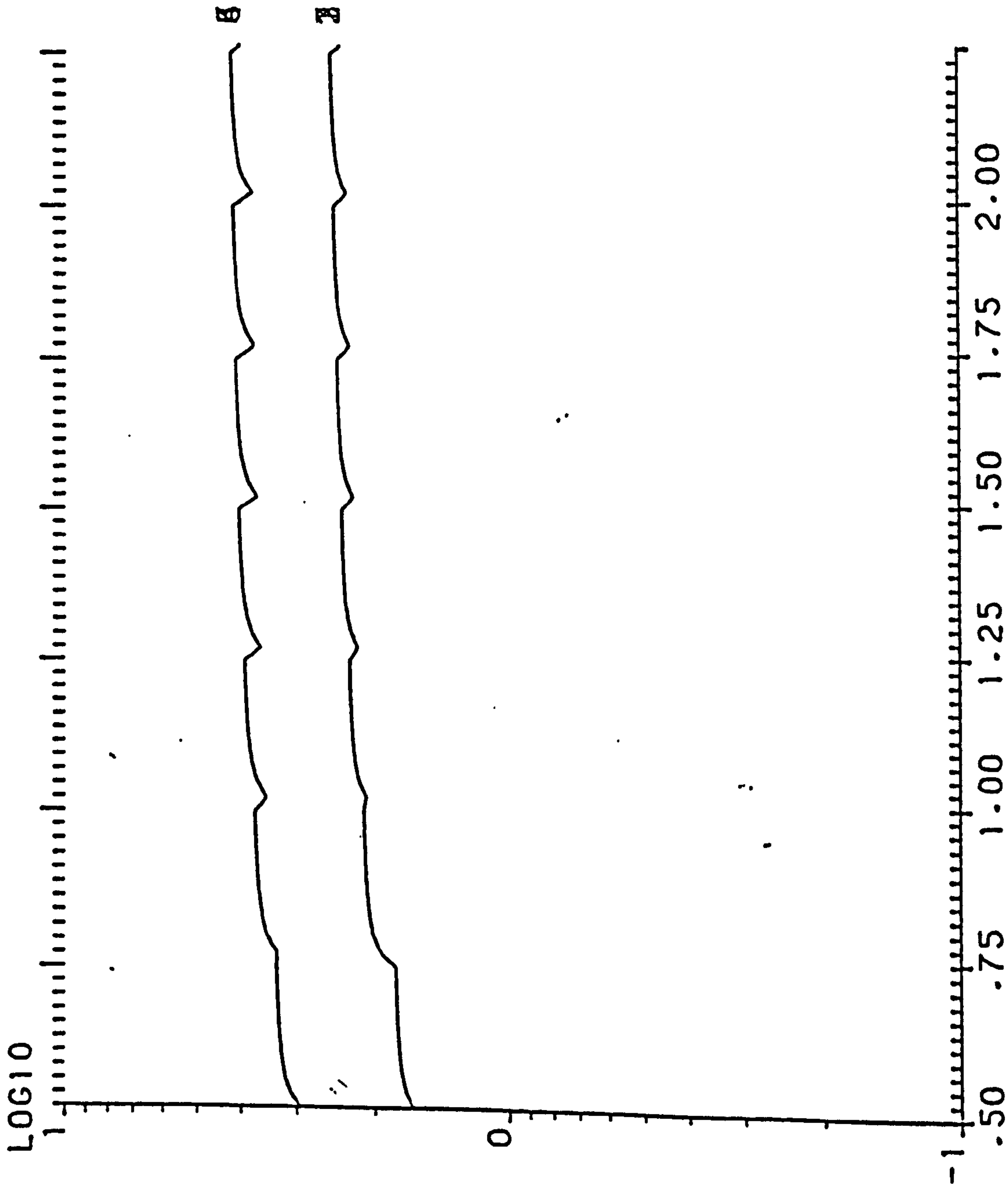

S. EFFICIENCY W. THICKNESS= .12M W. ORIENTATION=112.50

WD= 8M HD1= 2M HD2= 2M HOUSE T.=2.0 ST.



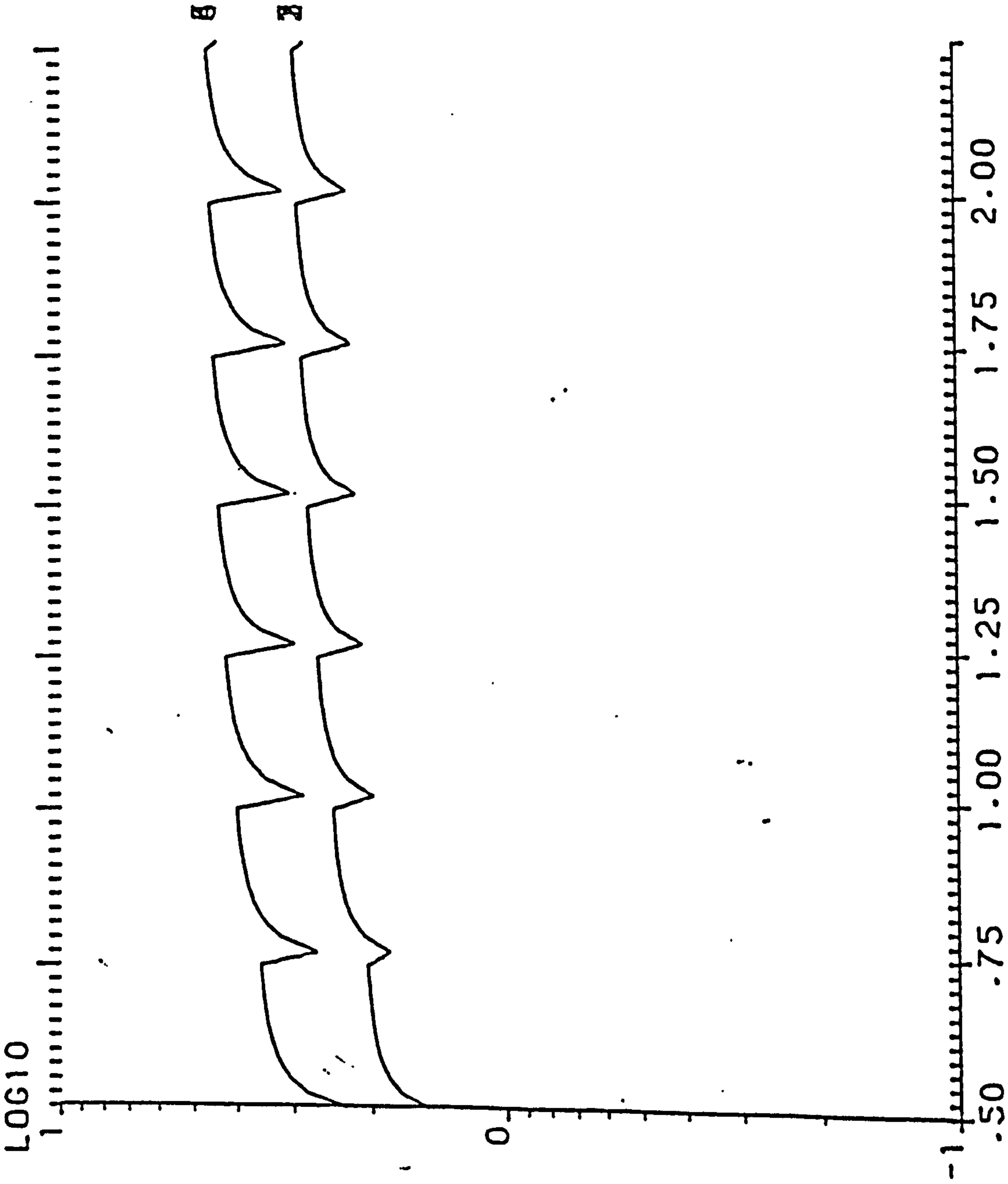

S. EFFICIENCY W. THICKNESS= .12M W. ORIENTATION=135.00

WD= 8M HD1= 2M HD2= 2M HOUSE T.=2.0 ST.

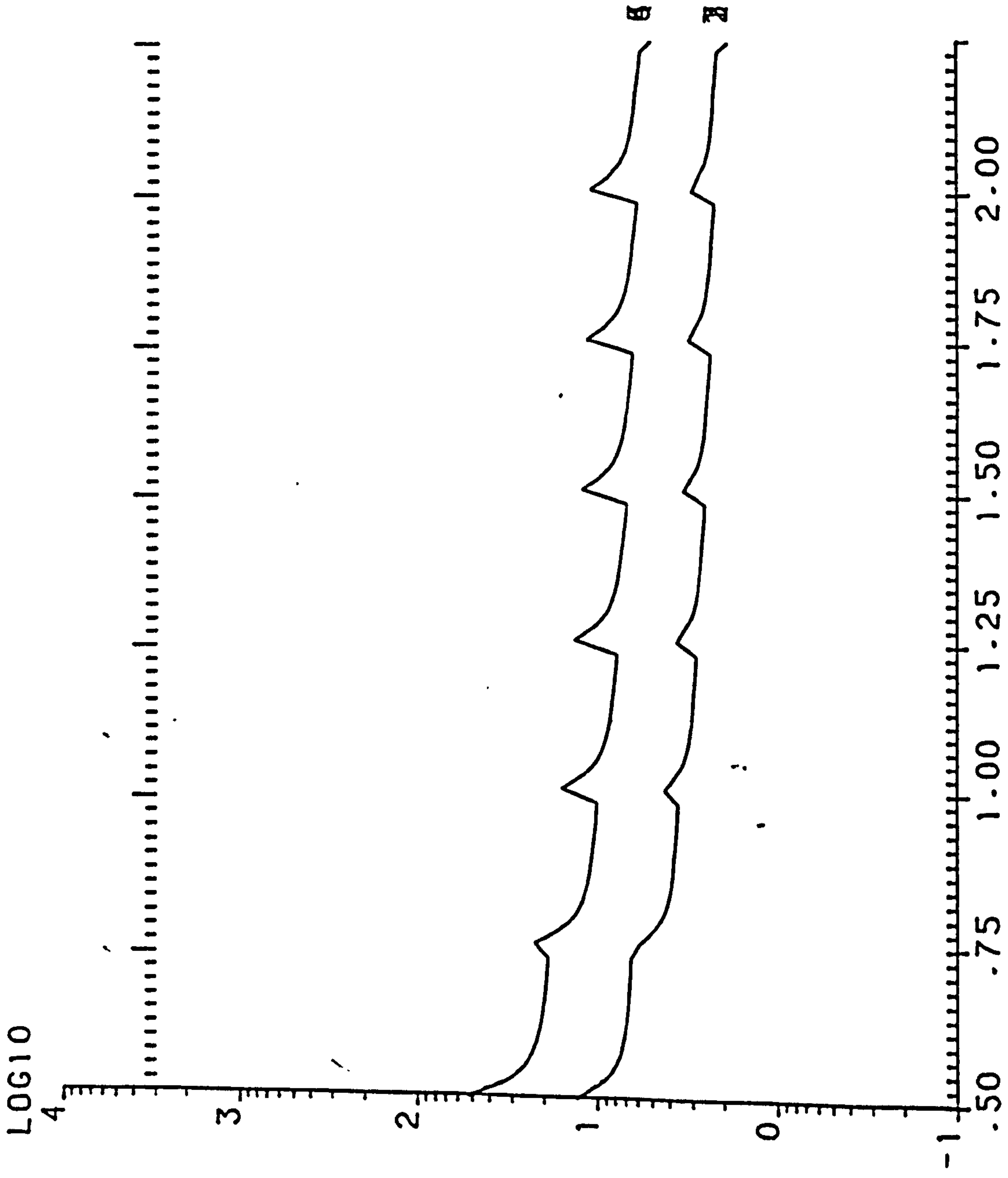

Y. EFFICIENCY W. THICKNESS= .12M W. ORIENTATION=157.50

WD= 8M HD1= 2M HD2= 2M HOUSE T.=2.0 ST.



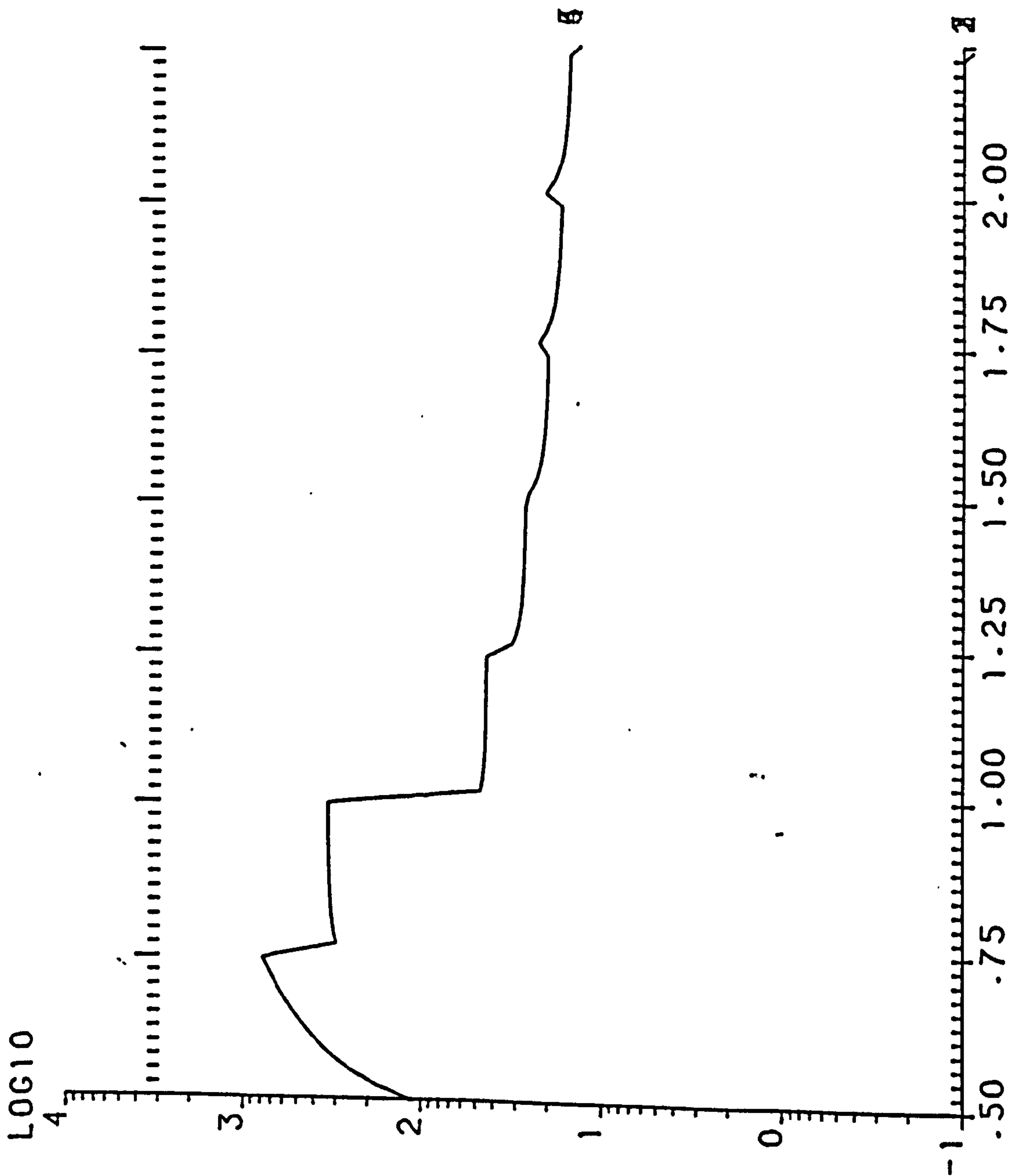

Y. EFFICIENCY W. THICKNESS= .12M W. ORIENTATION=180.00

WD= 8M HD1= 2M HD2= 2M HOUSE T.=2.0 ST.

LOG10  
1  
0  
-1

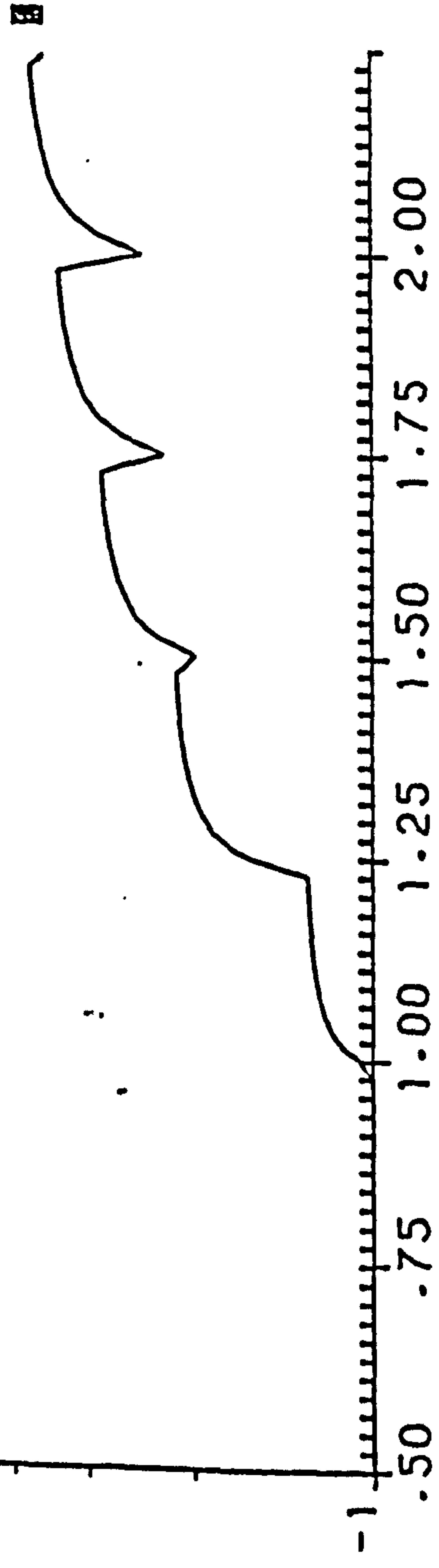

S. EFFICIENCY W. THICKNESS= .12M W. ORIENTATION=180.00

WD= 8M HD1= 2M HD2= 2M HOUSE T.=2.0 ST.

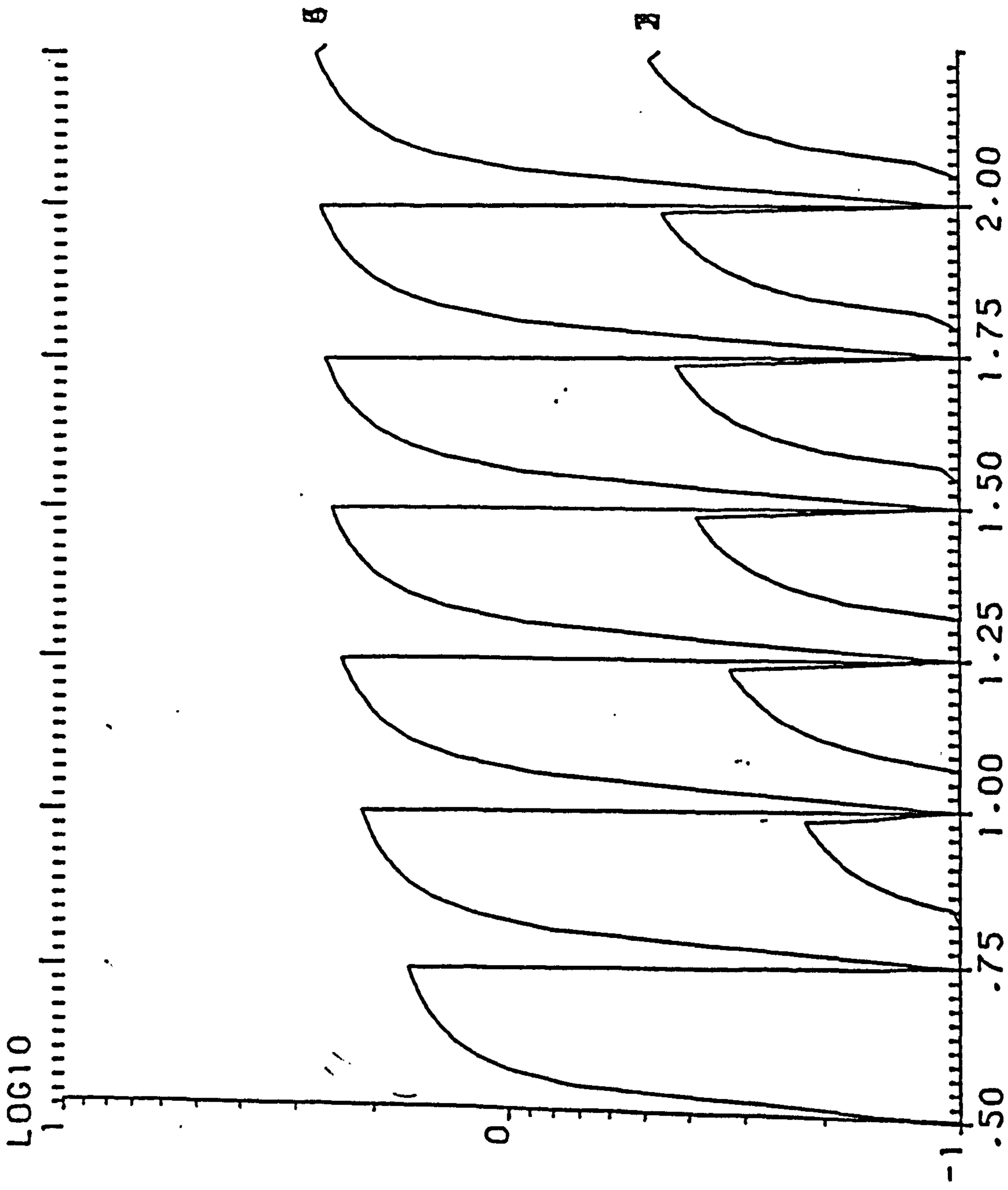

S. EFFICIENCY W. THICKNESS= .24M W. ORIENTATION= .00

WD= 8M HD1= 2M HD2= 2M HOUSE T.=2.0 ST.



LOG10

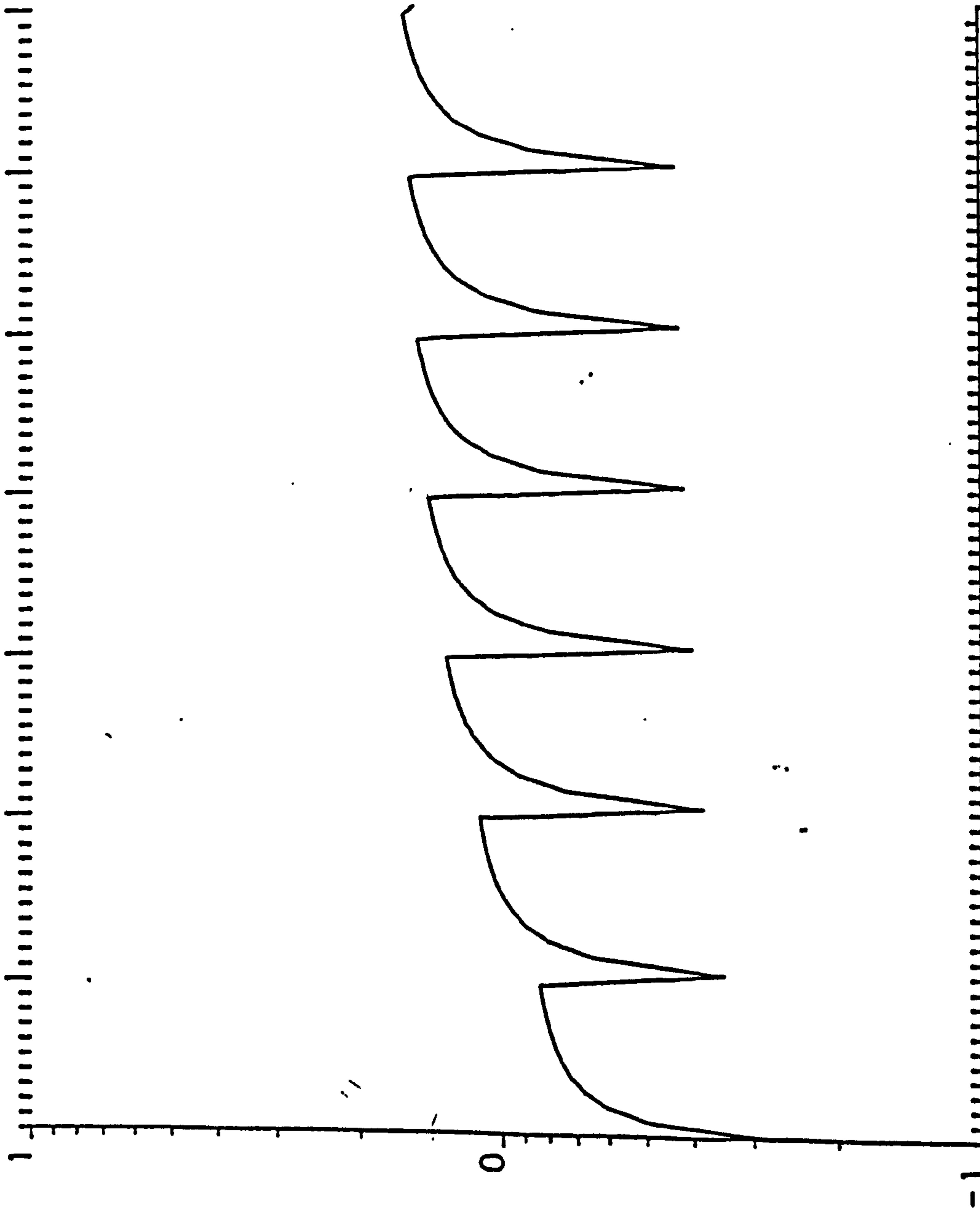

S. EFFICIENCY W. THICKNESS= .24M W. ORIENTATION= 22.50

WD= 8M HD1= 2M HD2= 2M HOUSE T.=2.0 ST.



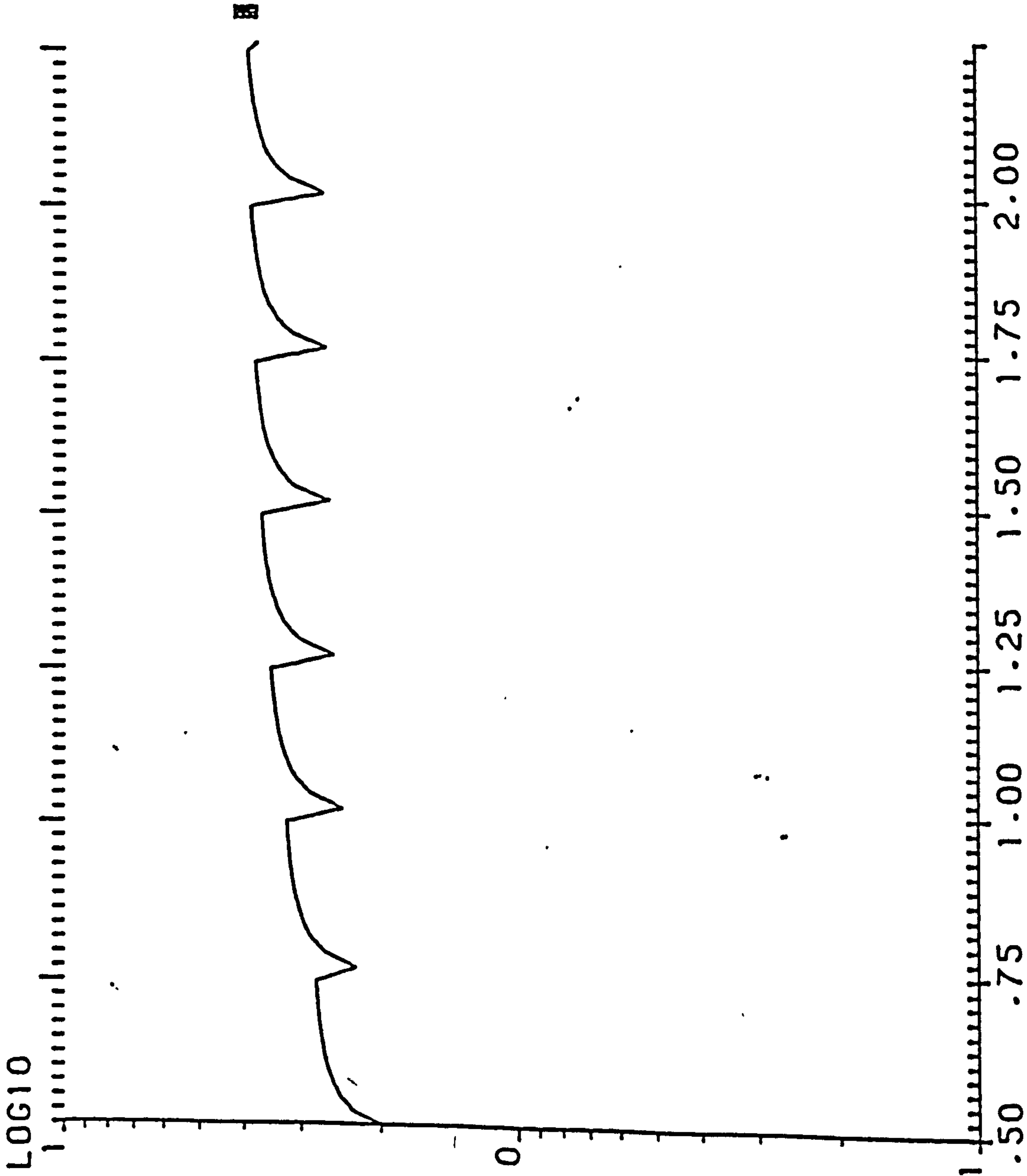

S. EFFICIENCY W. THICKNESS= .24M HD2= 2M HOUSE T.=2.0 ST.  
 WD= 8M HD1= 2M W. ORIENTATION= 45.00



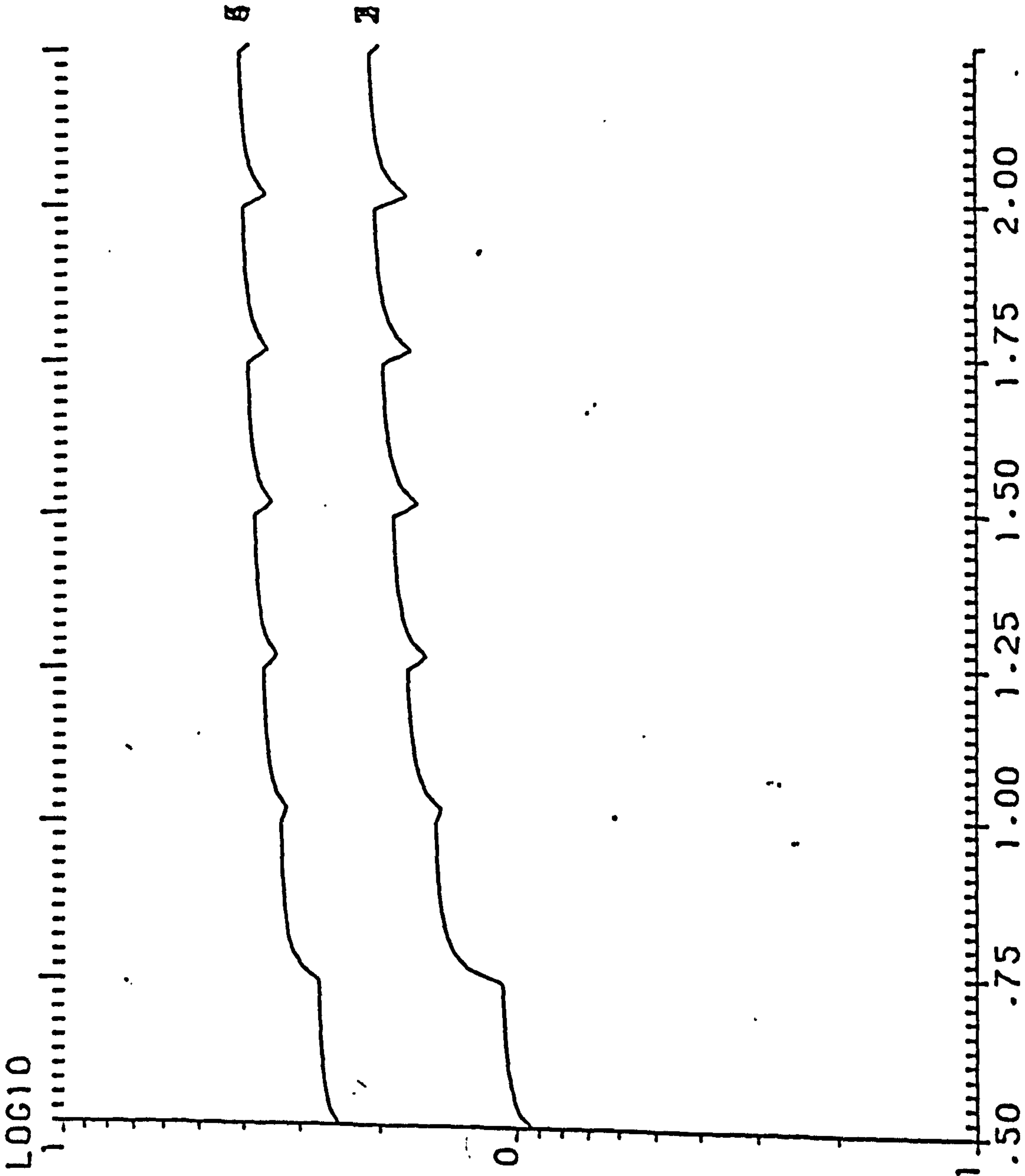

S. EFFICIENCY W. THICKNESS= .24M W. ORIENTATION= 67.50  
 WD= 8M HD1= 2M HD2= 2M HOUSE T.=2.0 ST.

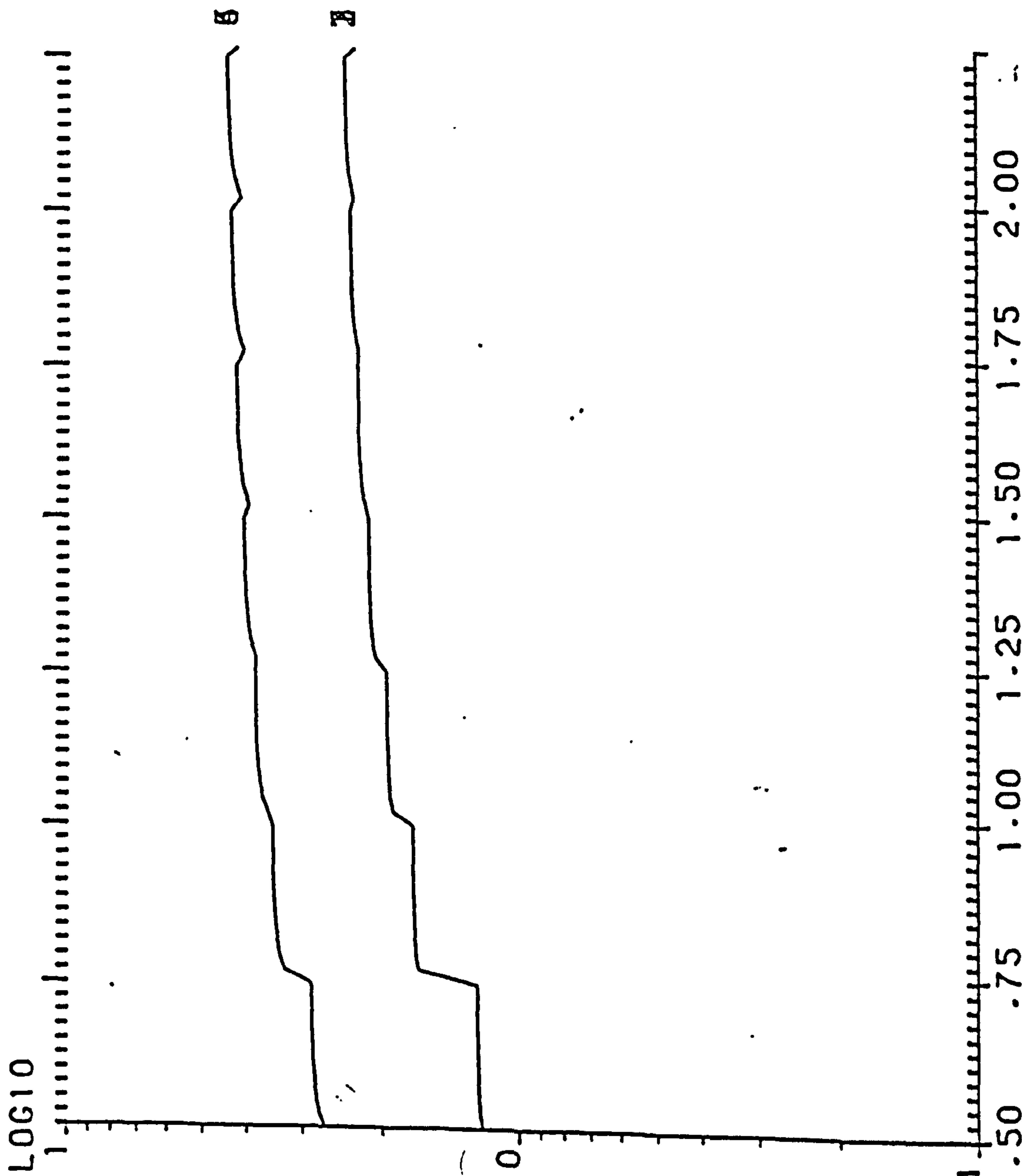

S. EFFICIENCY W. THICKNESS = .24M HD2 = 2M HOUSE T. = 2.0 ST.

WD = 8M HD1 = 2M



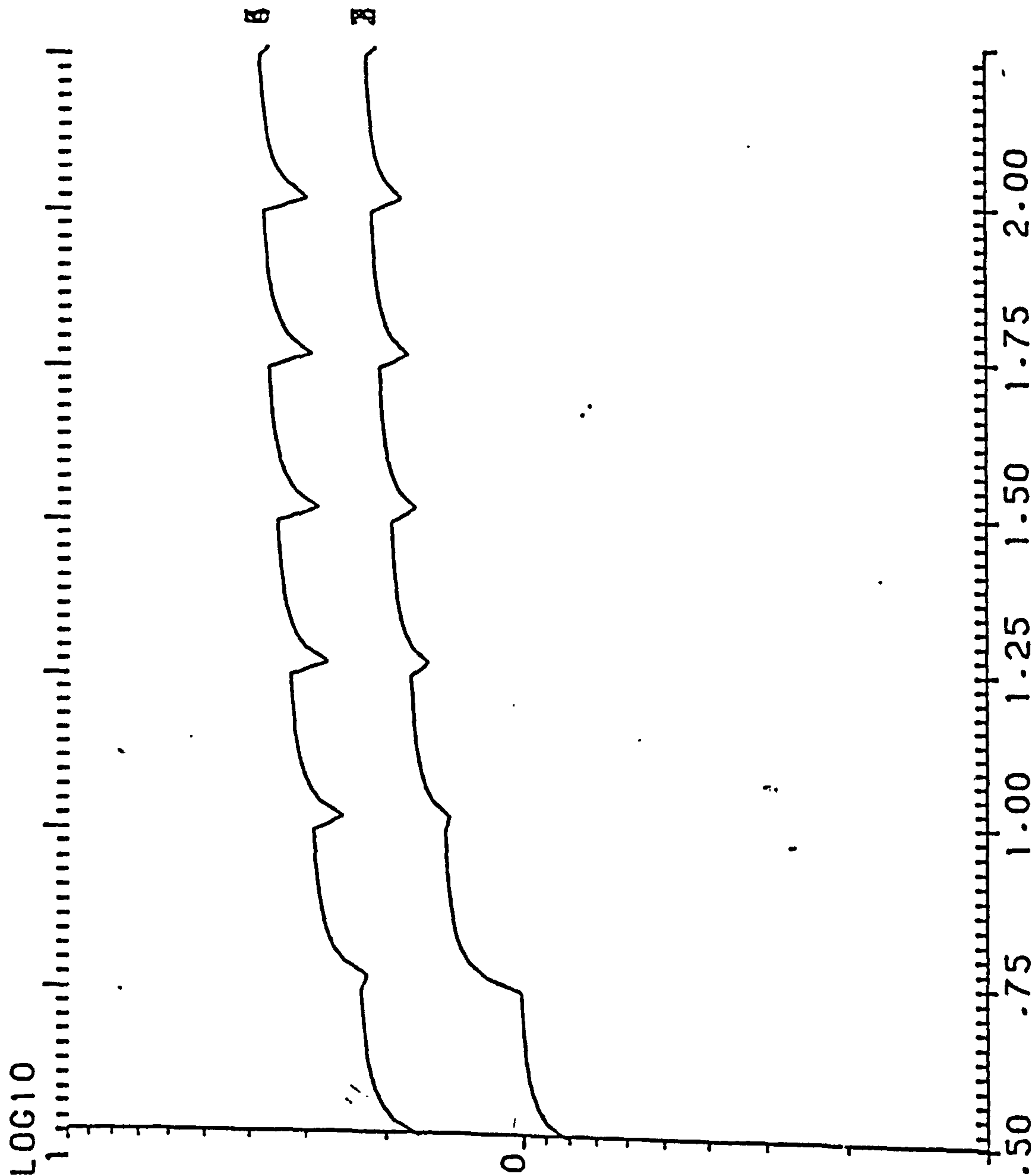

S. EFFICIENCY W. THICKNESS= .24M HD2= 2M HOUSE T.=2.0 ST.  
 W. ORIENTATION=112.50

WD= 8M HD1= 2M



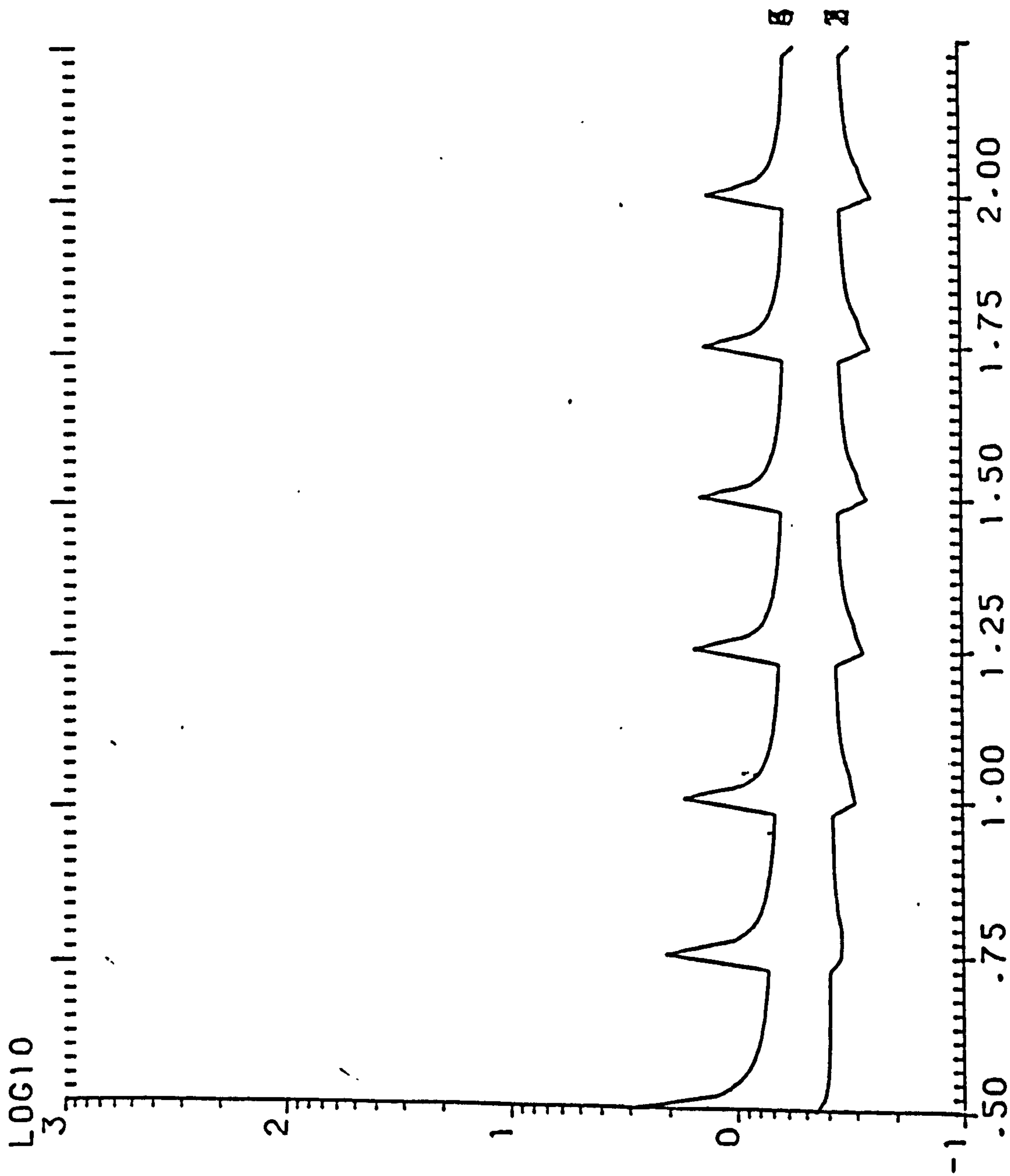

Y. EFFICIENCY W. THICKNESS= .24M W. ORIENTATION=135.00

WD= 8M HD1= 2M HD2= 2M HOUSE T.=2.0 ST.

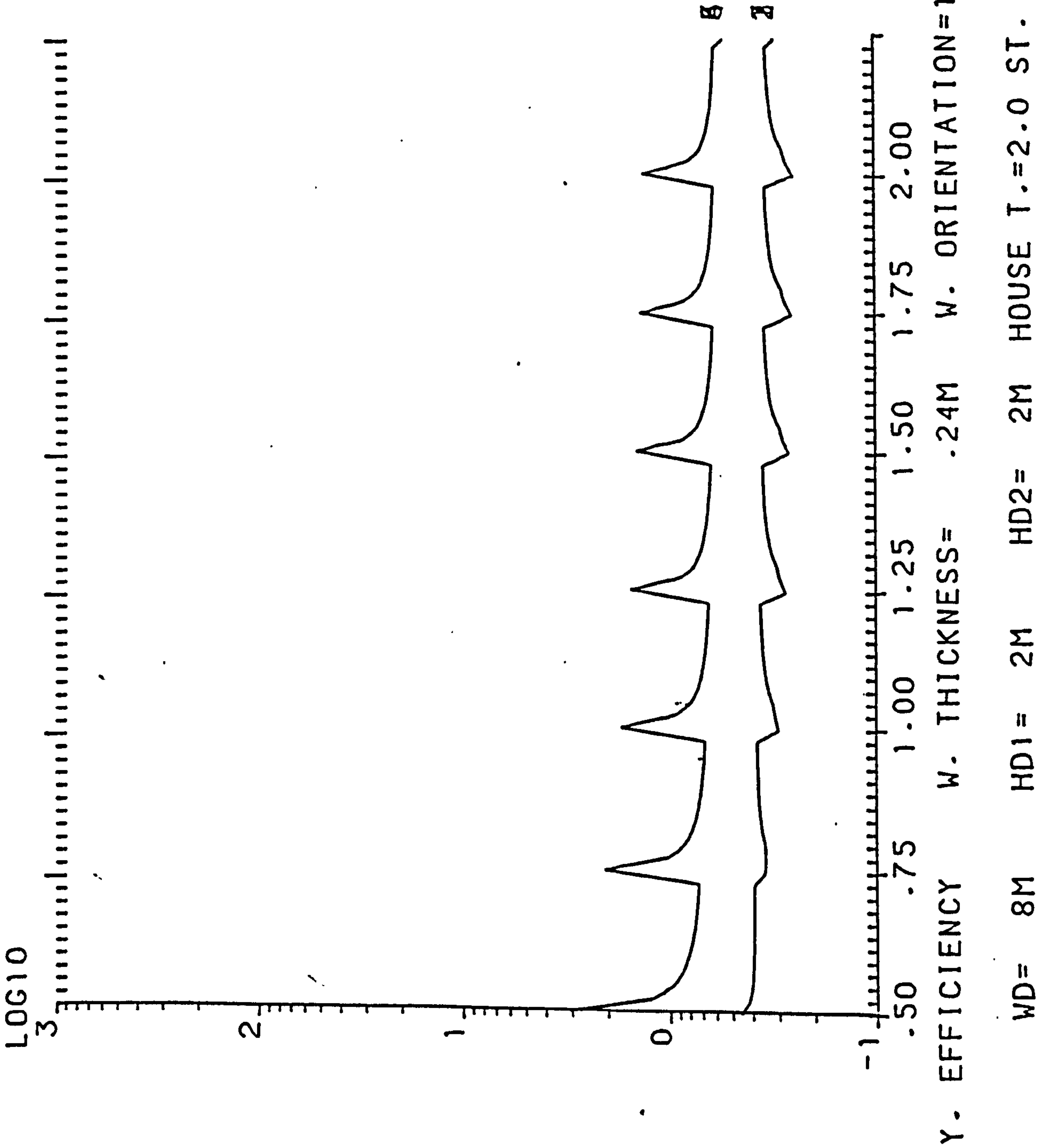



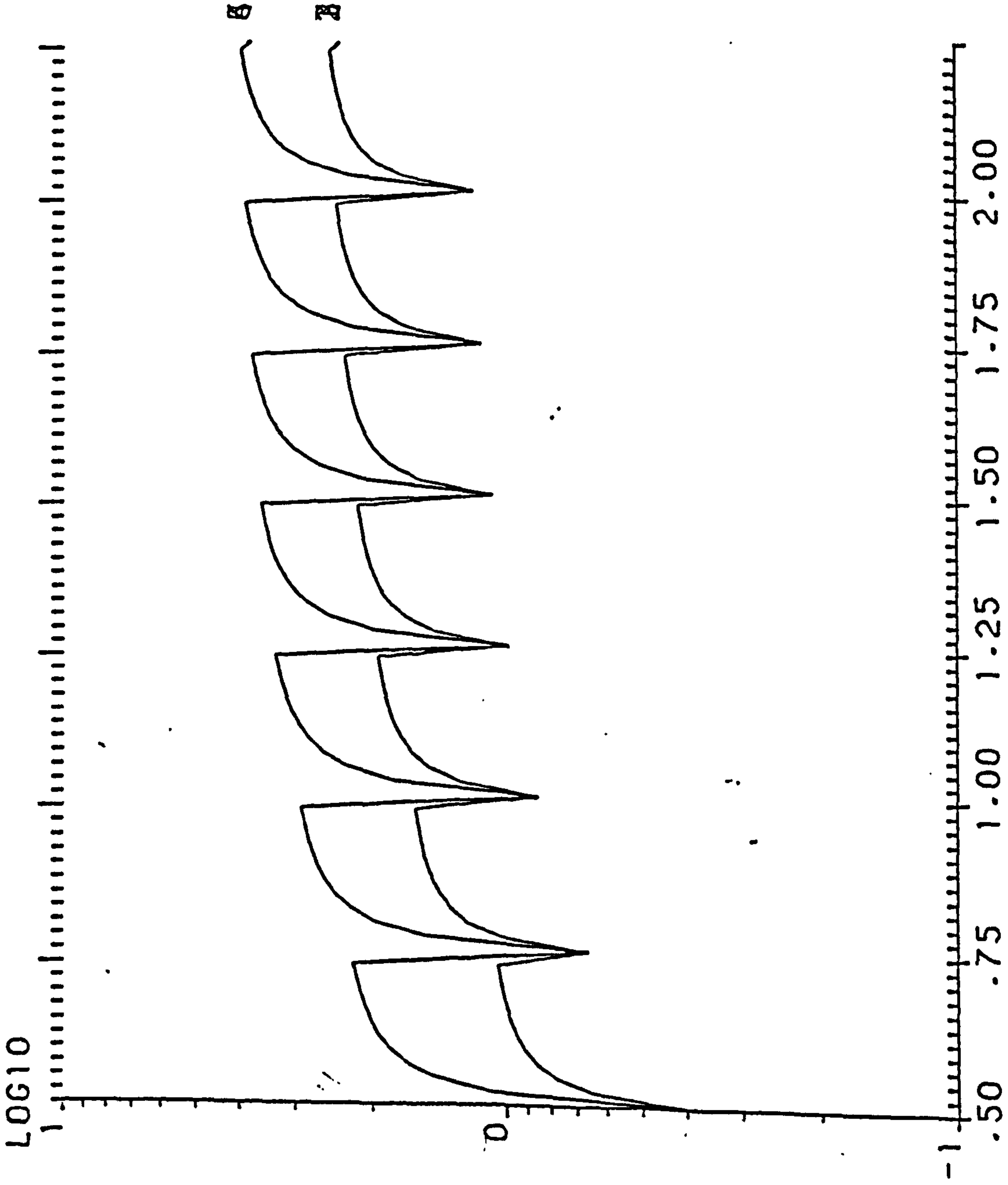

S. EFFICIENCY W. THICKNESS= .24M HD2= 2M HOUSE T.=2.0 ST.  
 W. ORIENTATION=135.00

WD= 8M HD1= 2M



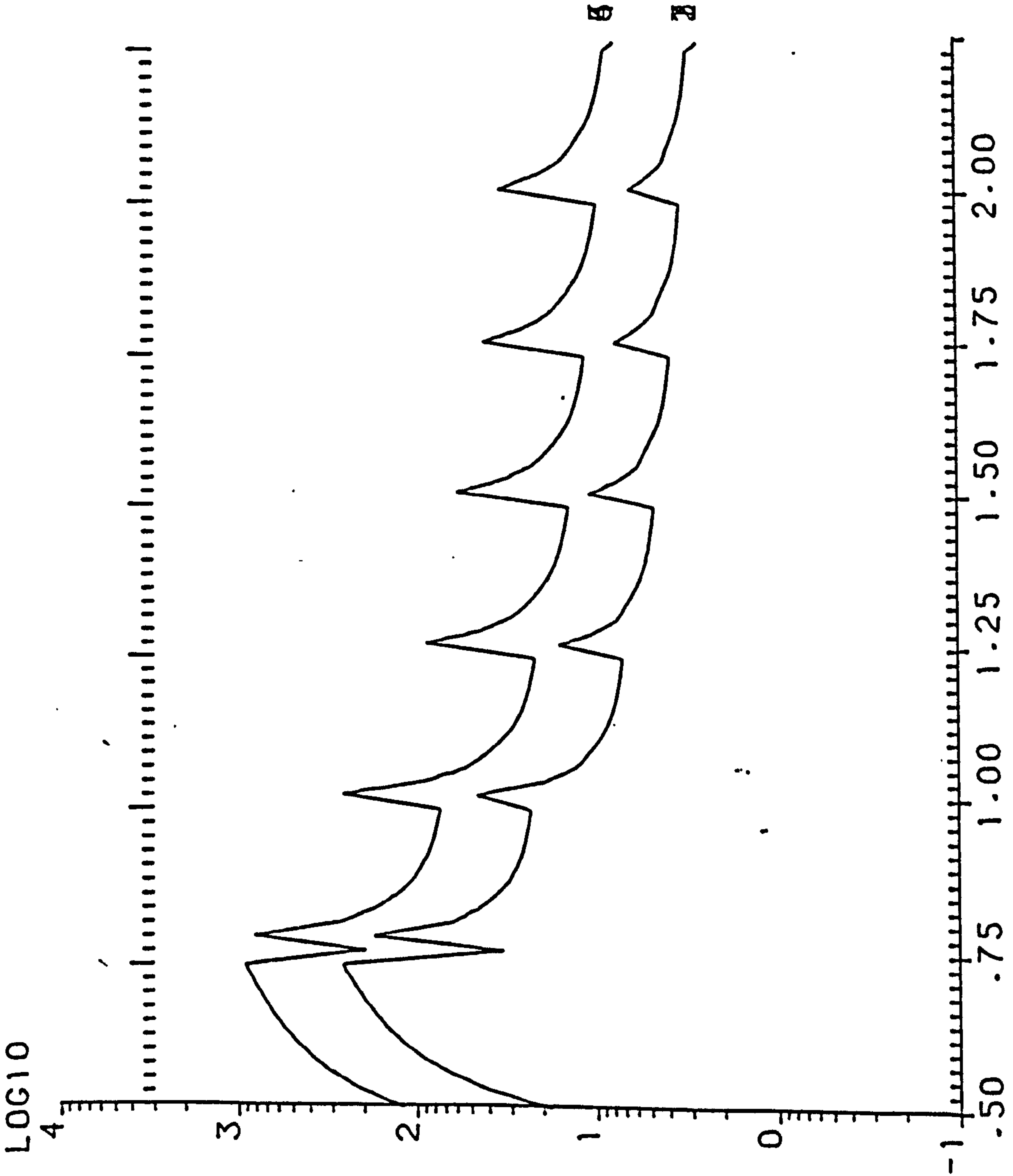

Y. EFFICIENCY W. THICKNESS= .24M W. ORIENTATION=157.50  
WD= 8M HD1= 2M HD2= 2M HOUSE T.=2.0 ST.

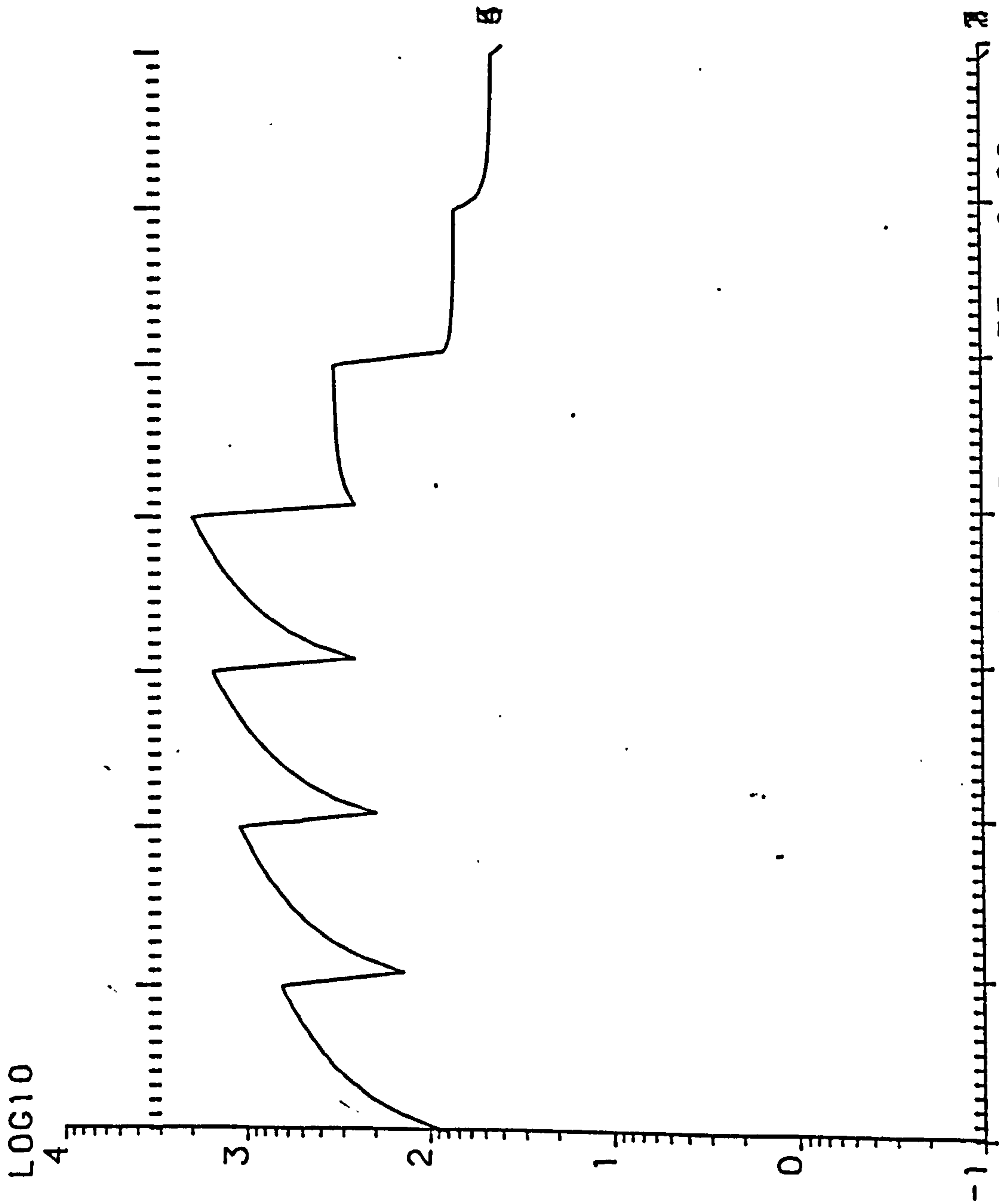

Y. EFFICIENCY W. THICKNESS= .24M W. ORIENTATION=180.00

WD= 8M HD1= 2M HD2= 2M HOUSE T.=2.0 ST.

LOG10  
1  
0  
-1

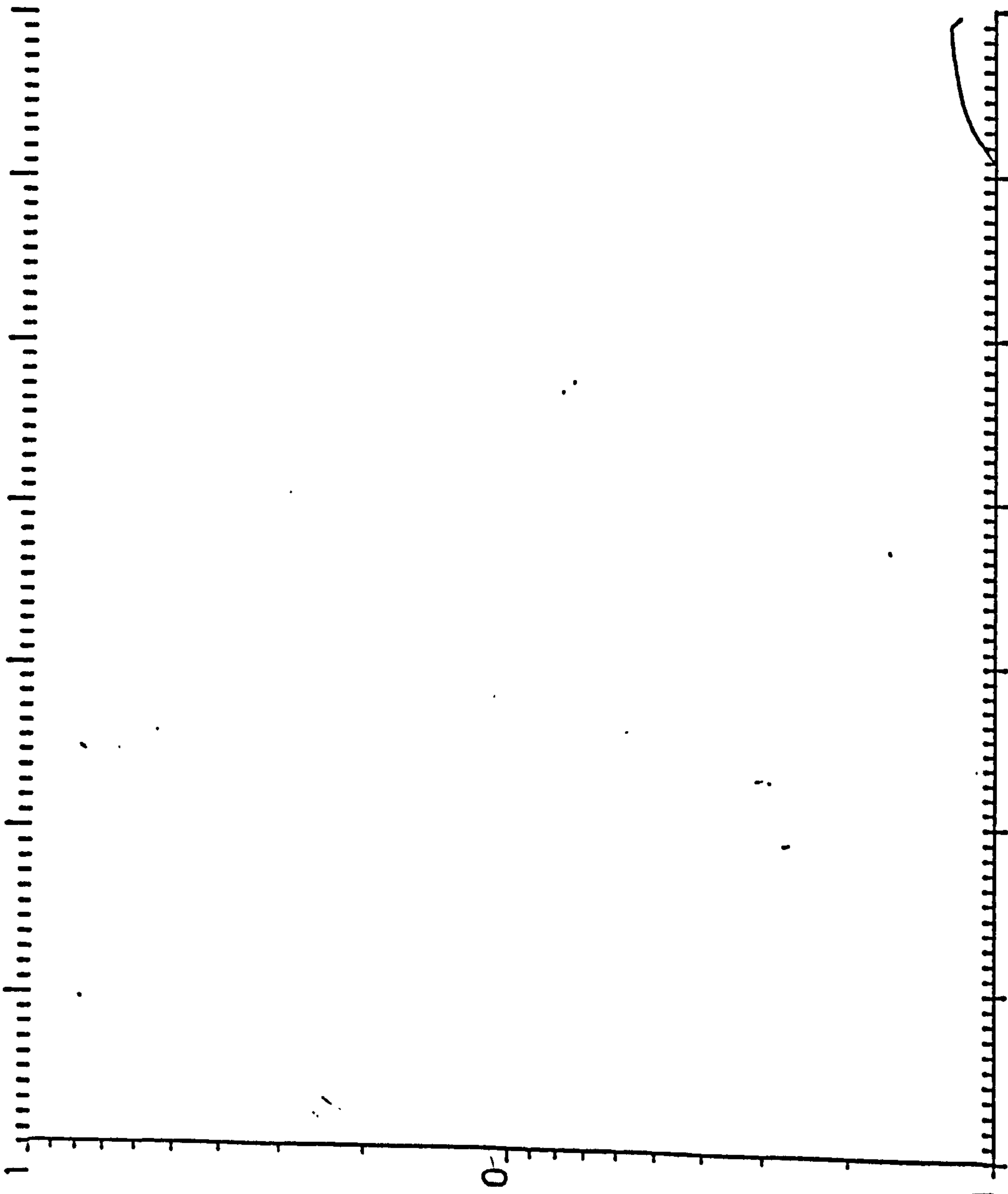

S. EFFICIENCY  
 W. THICKNESS = .24M  
 W. ORIENTATION = 180.00

WD = 8M  
 HD1 = 2M  
 HD2 = 2M  
 HOUSE T. = 2.0 ST.



LOG10

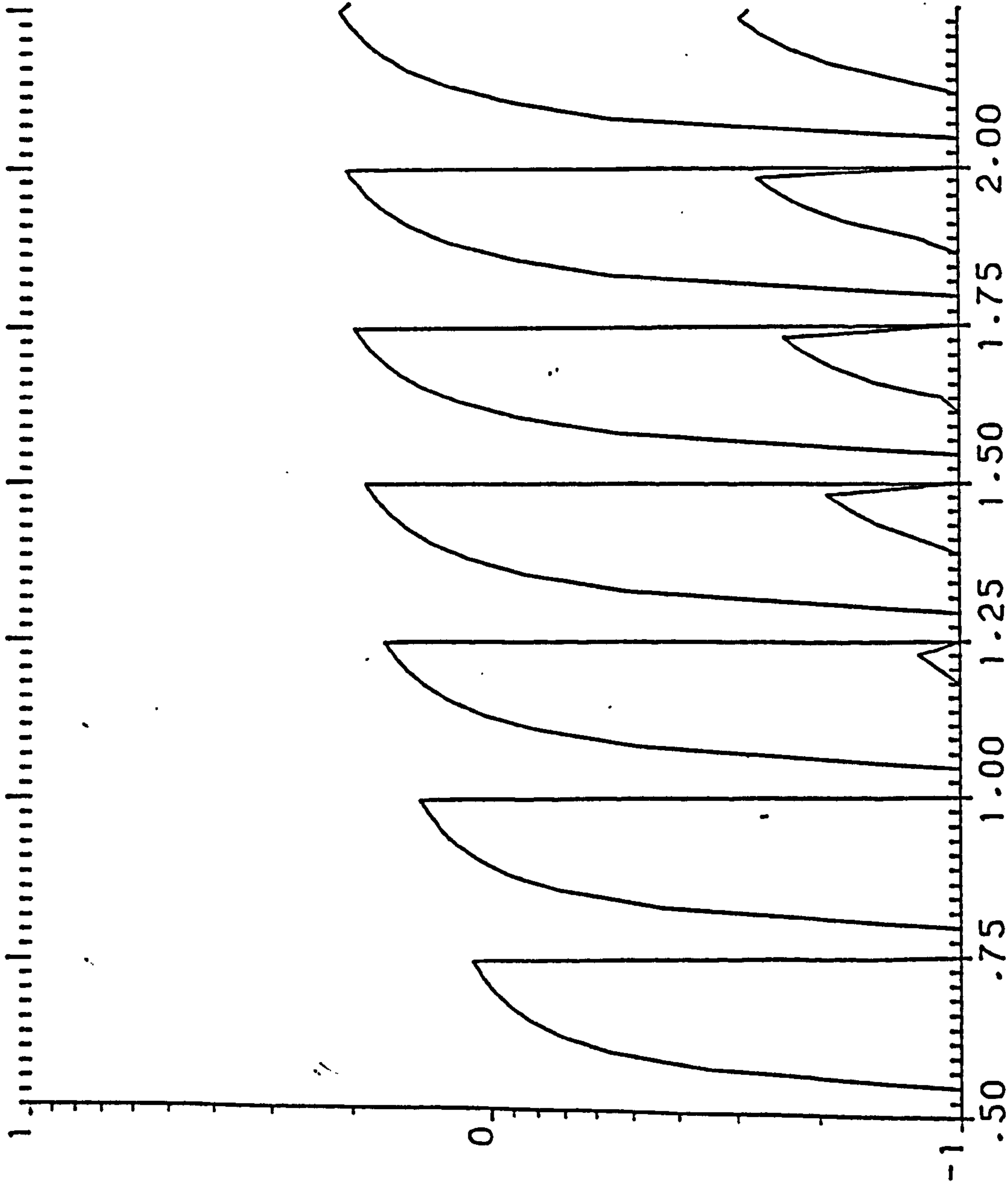

S. EFFICIENCY W. THICKNESS= .36M W. ORIENTATION= .00

WD= 8M HD1= 2M HD2= 2M HOUSE T.=2.0 ST.



LOG10

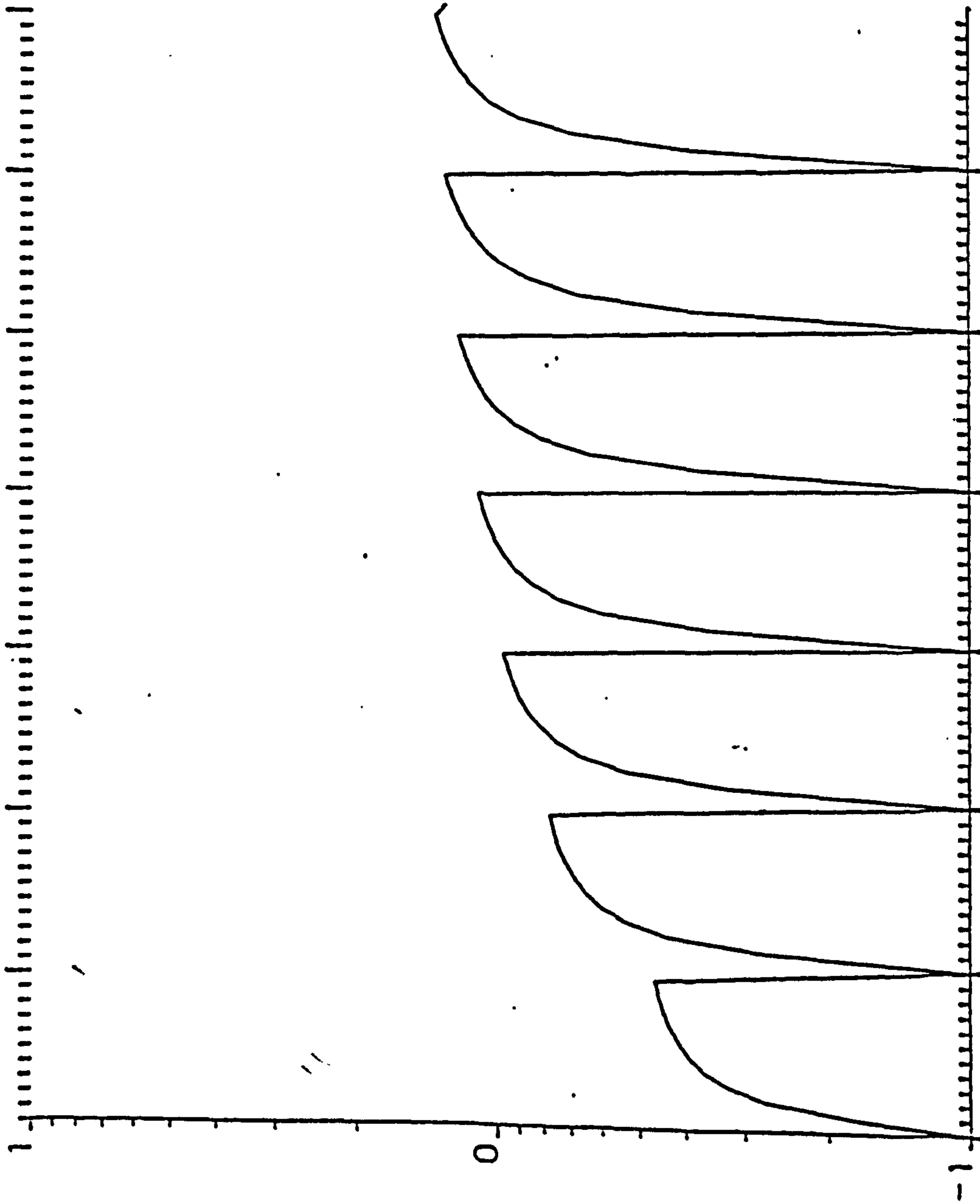

S. EFFICIENCY W. THICKNESS= .36M W. ORIENTATION= 22.50

WD= 8M HD1= 2M HD2= 2M HOUSE T.=2.0 ST.

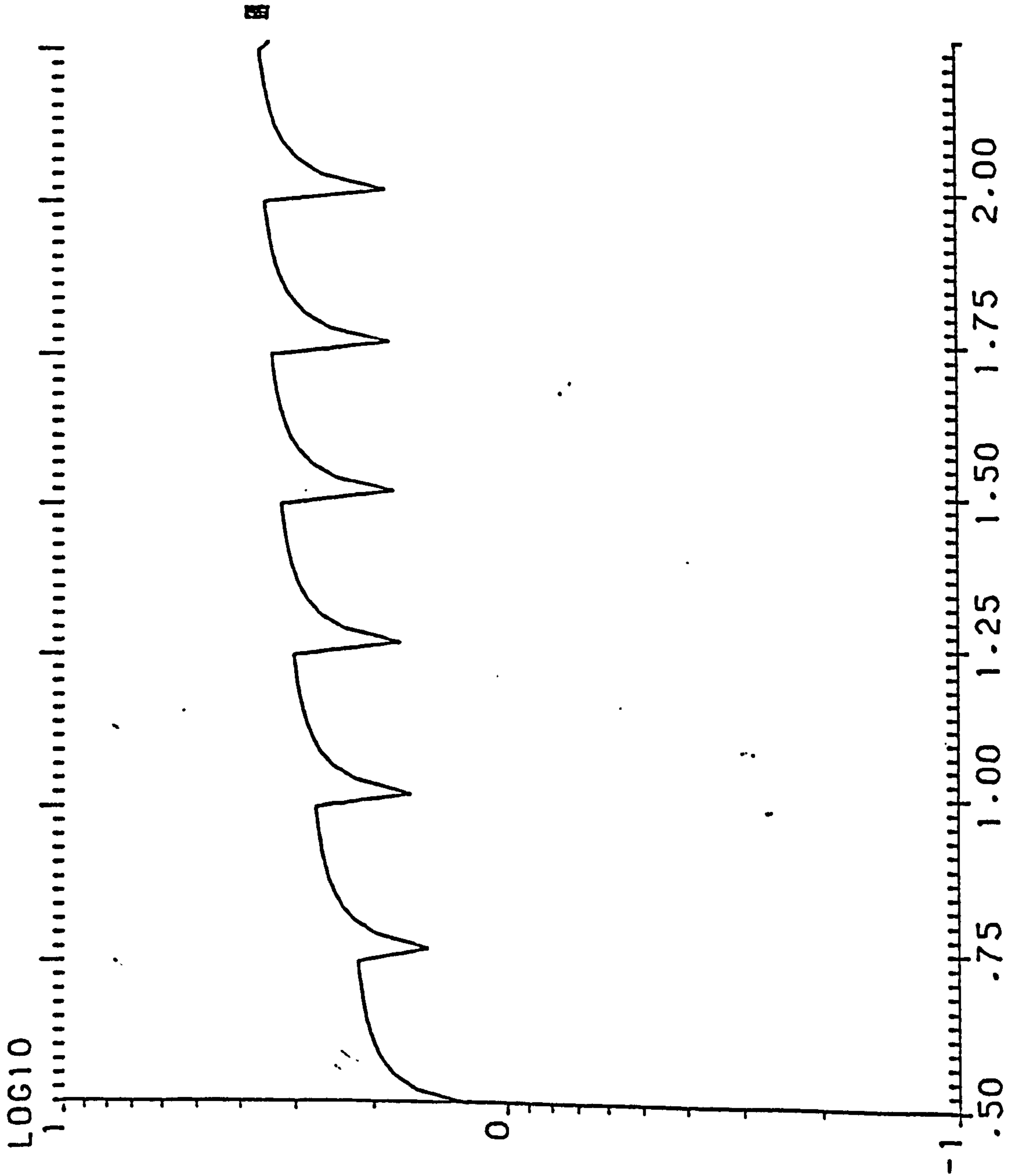

S. EFFICIENCY W. THICKNESS= .36M W. ORIENTATION= 45.00  
 WD= 8M HD1= 2M HD2= 2M HOUSE T.=2.0 ST.

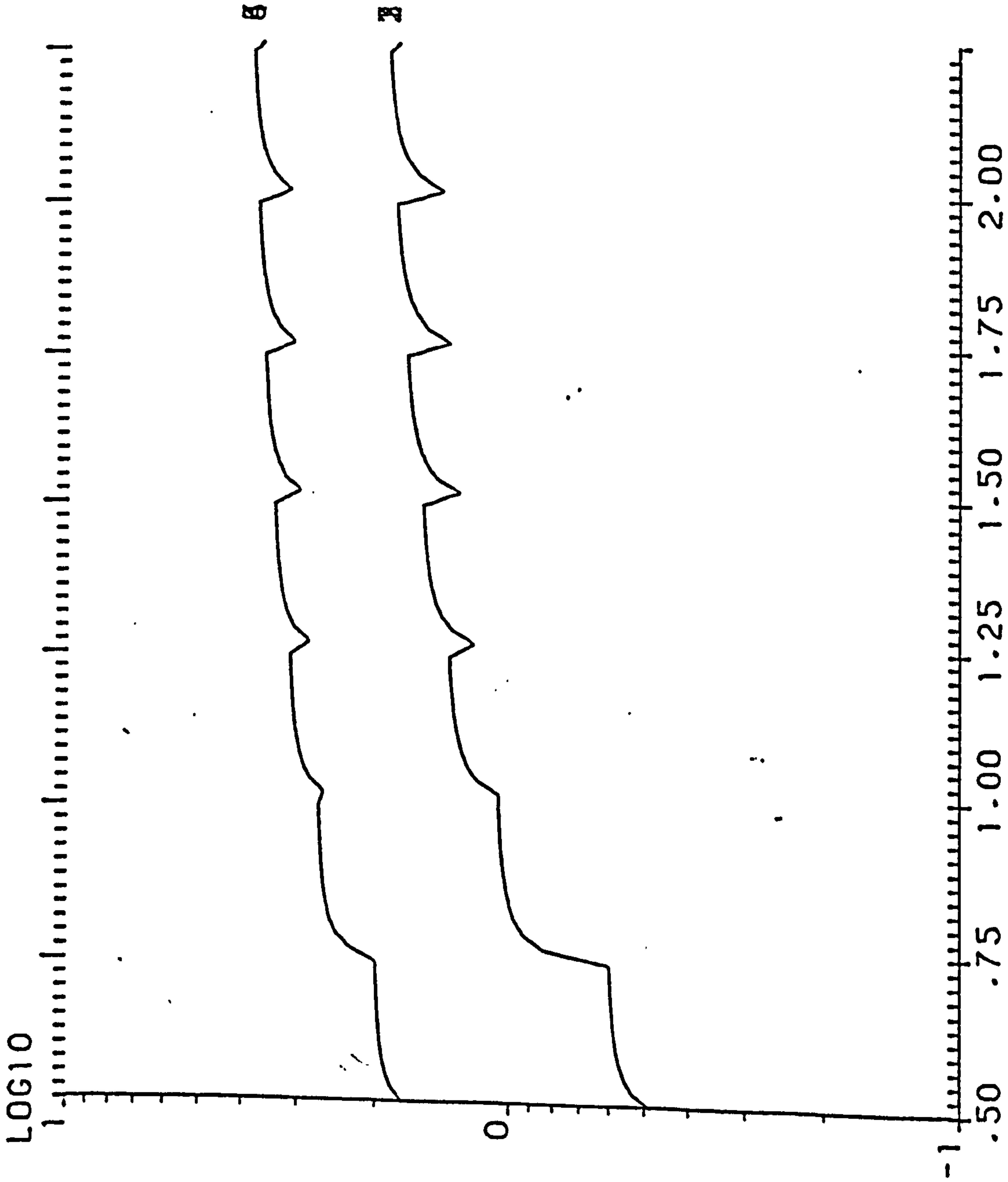

S. EFFICIENCY W. THICKNESS= .36M W. ORIENTATION= 67.50

WD= 8M HD1= 2M HD2= 2M HOUSE T.=2.0 ST.



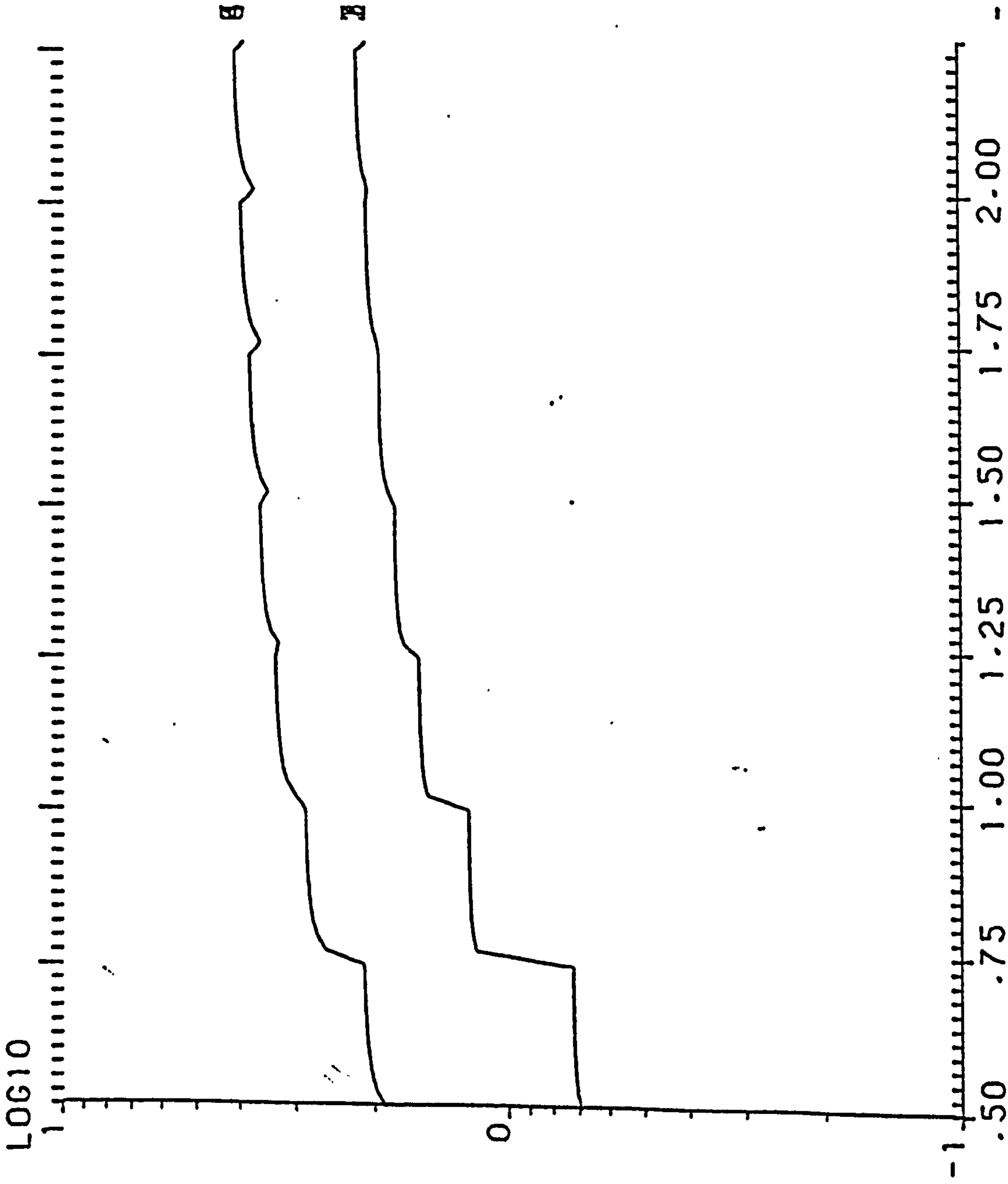

S. EFFICIENCY W. THICKNESS= .36M W. ORIENTATION= 90.00

WD= 8M HD1= 2M HD2= 2M HOUSE T.=2.0 ST.



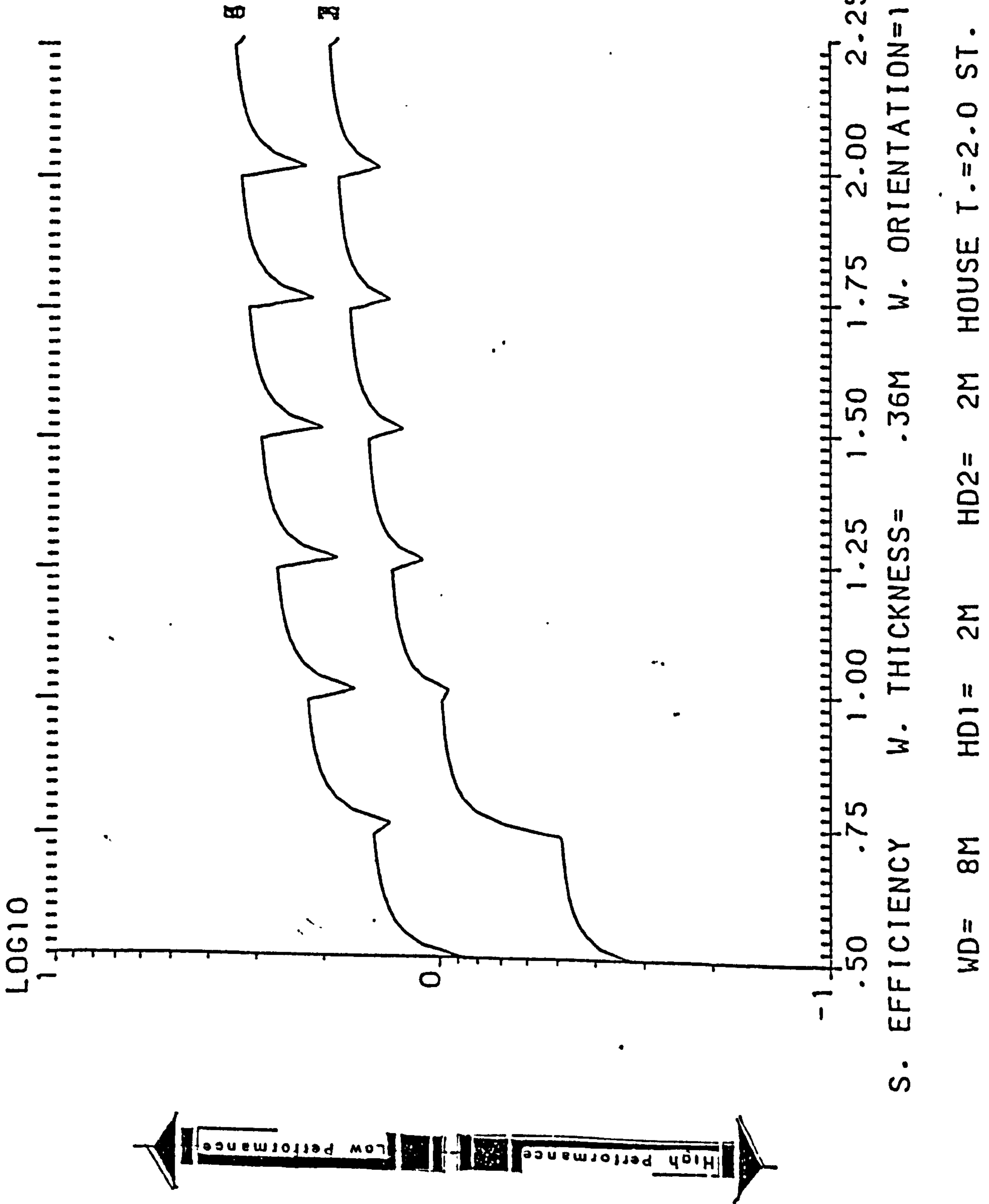



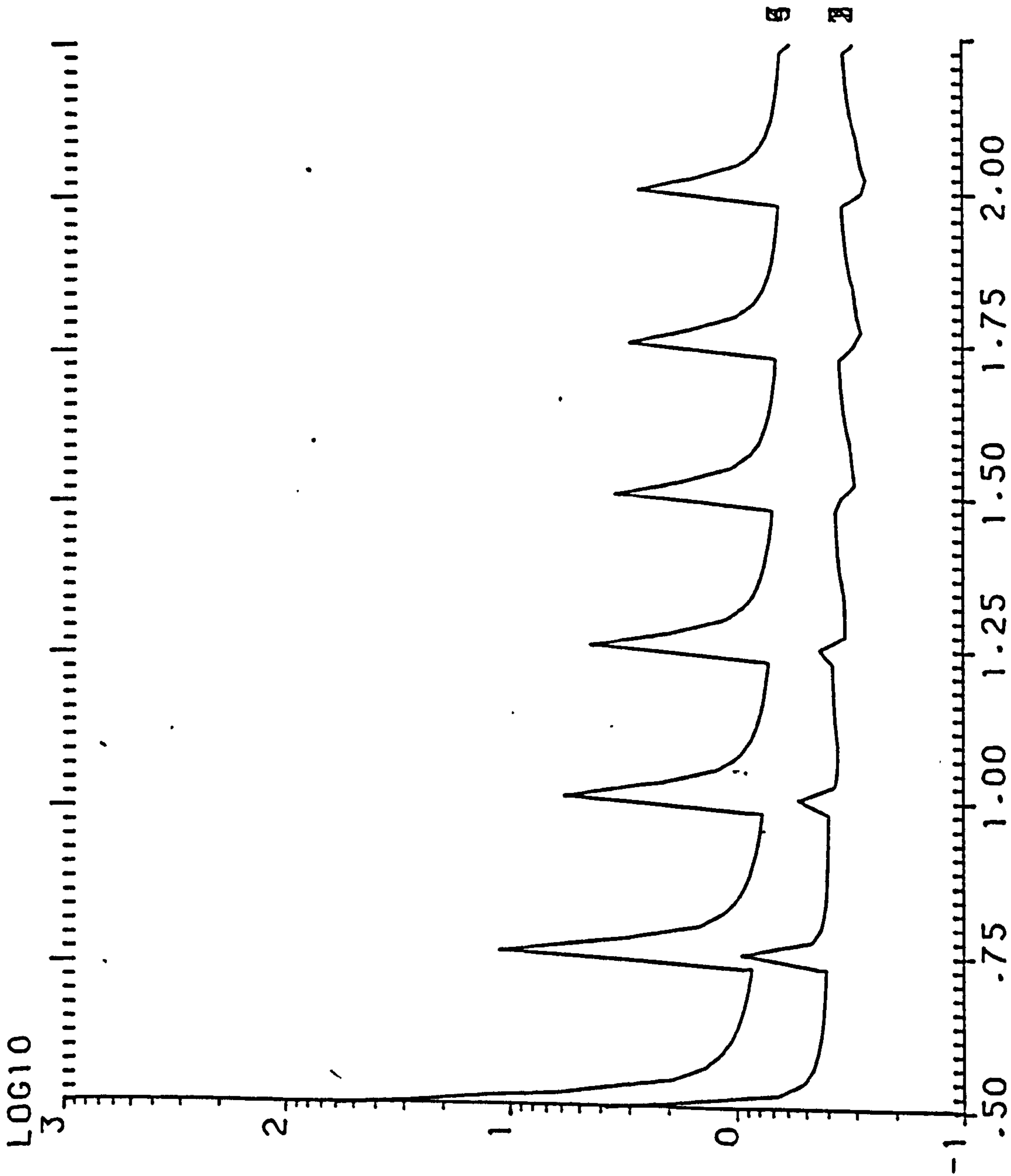

Y. EFFICIENCY W. THICKNESS= .36M W. ORIENTATION=135.00  
WD= 8M HD1= 2M HD2= 2M HOUSE T.=2.0 ST.

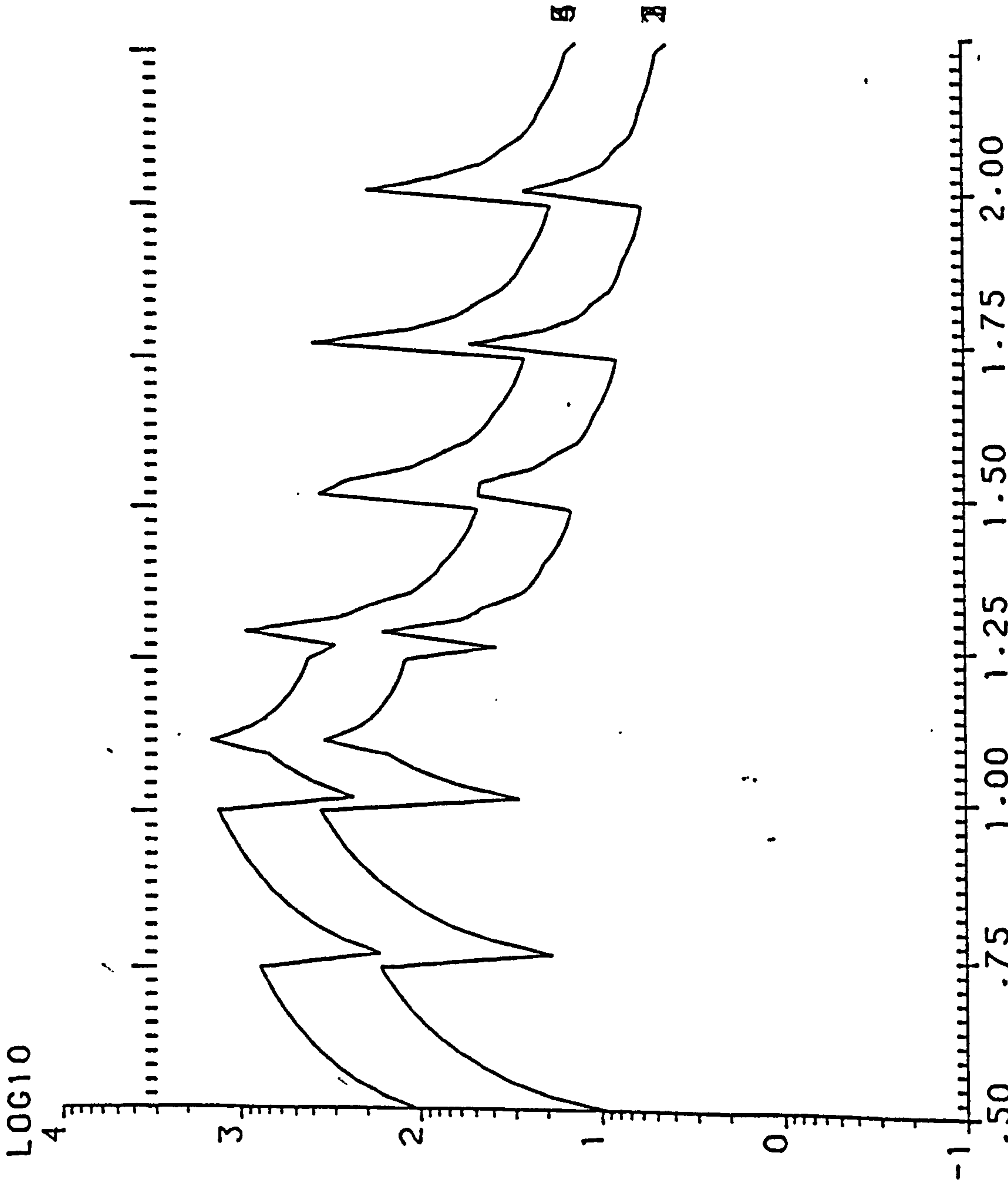

Y. EFFICIENCY W. THICKNESS= .36M W. ORIENTATION=157.50

WD= 8M HD1= 2M HD2= 2M HOUSE T.=2.0 ST.

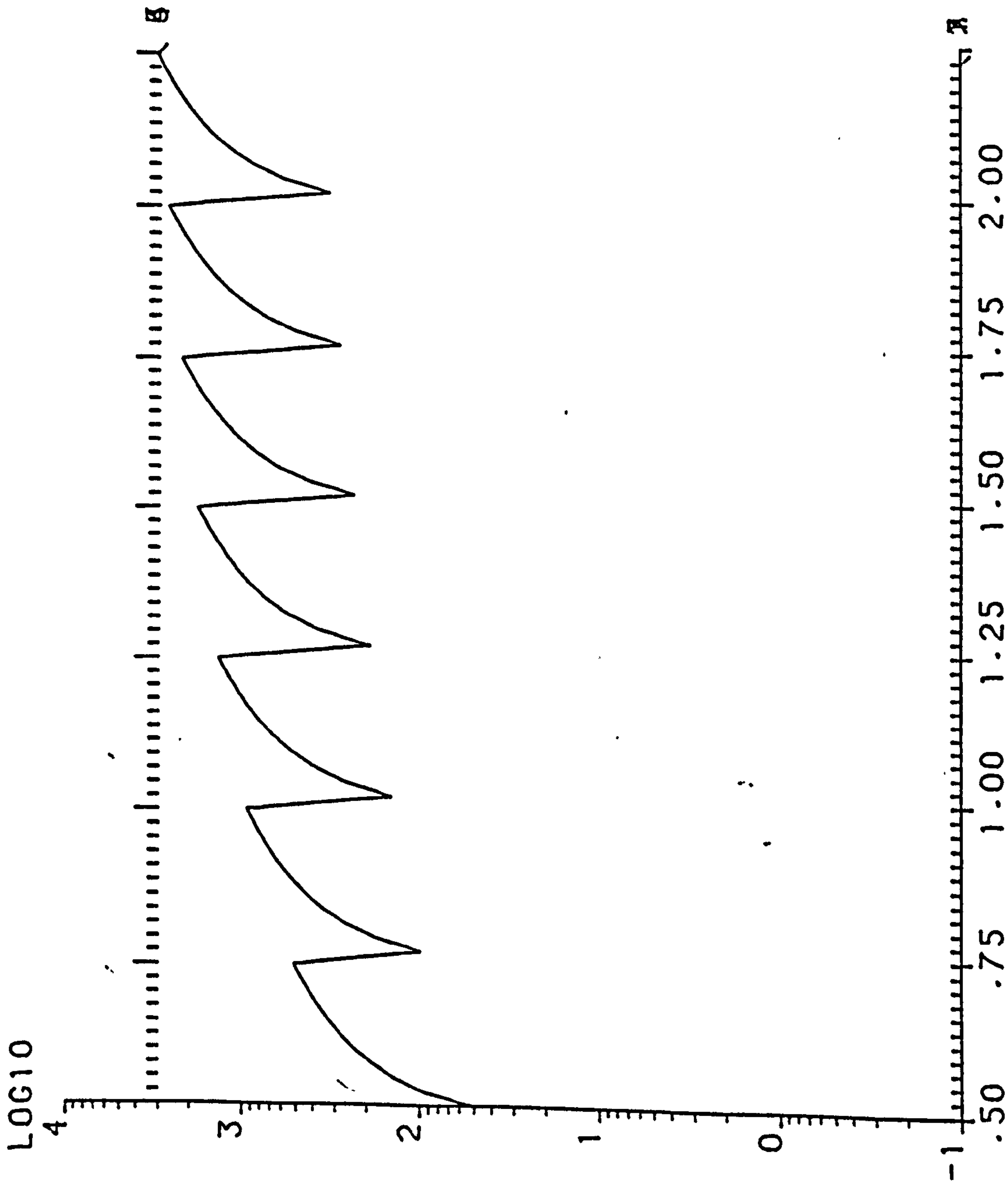

Y. EFFICIENCY W. THICKNESS= .36M . W. ORIENTATION=180.00

WD= 8M HD1= 2M HD2= 2M HOUSE T.=2.0 ST.



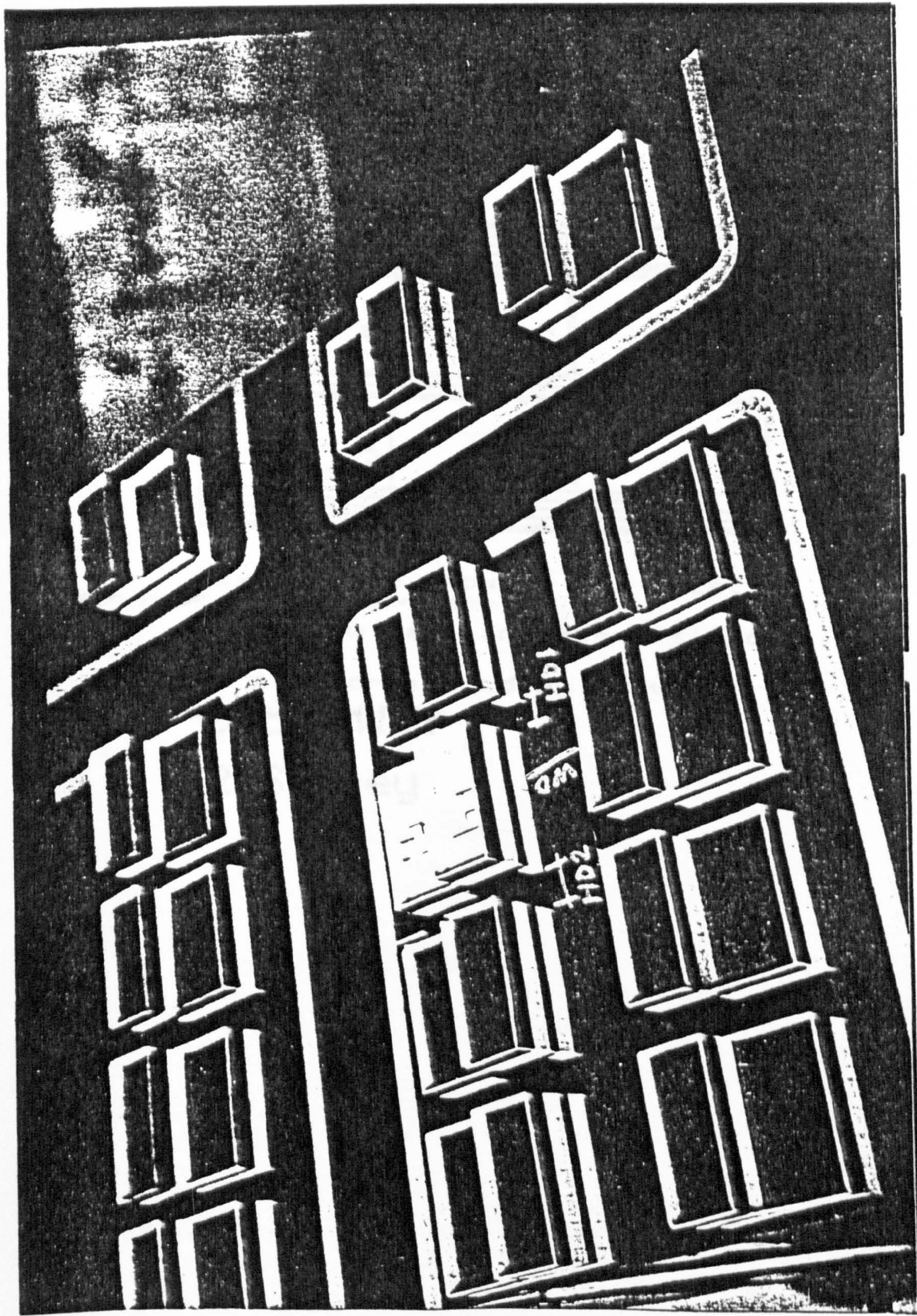

Model showing interhouse distances



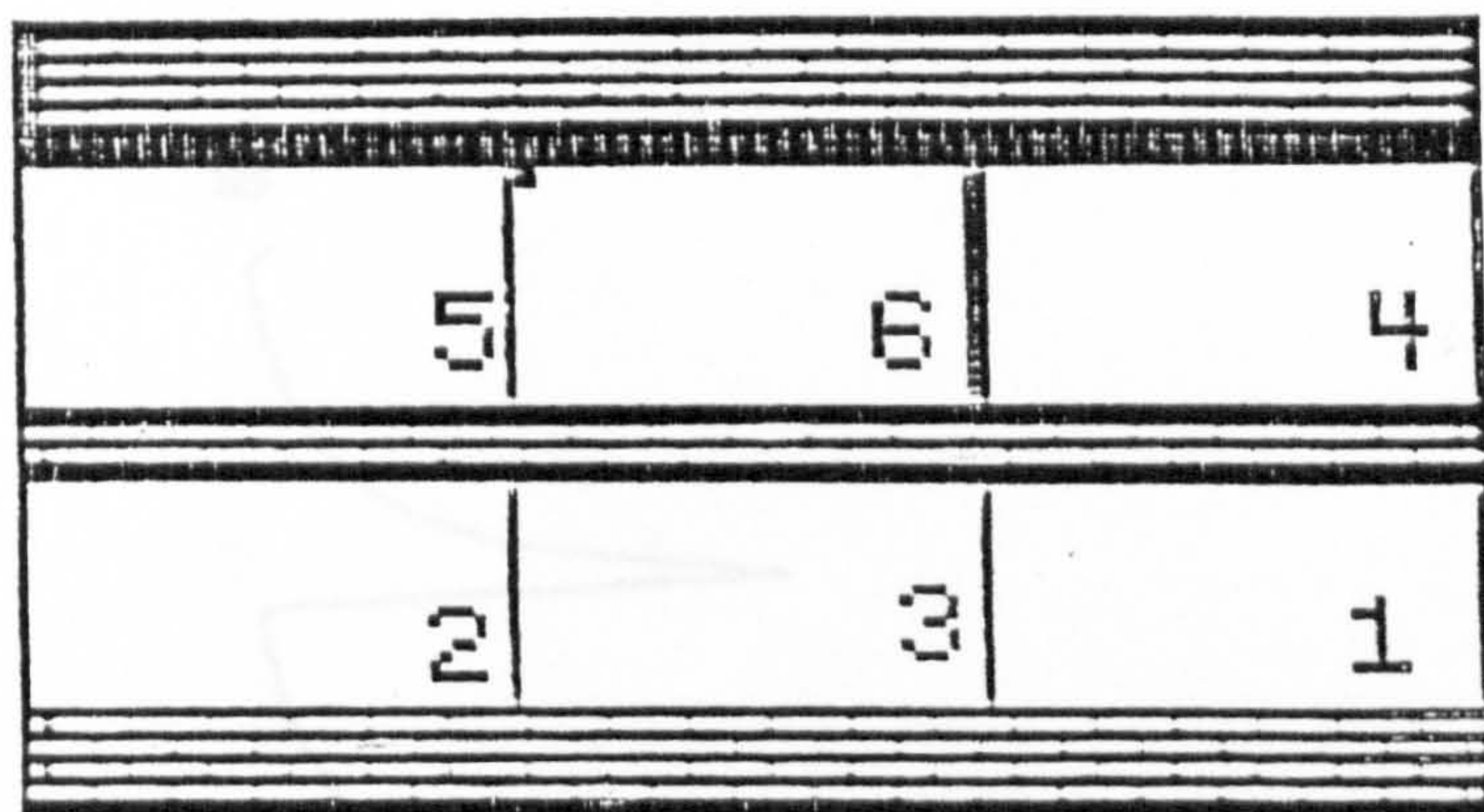

Key diagram showing the location  
of window data and the position  
of the corresponding curve  
Back Wall  
2 Storey

50 0.75 1.00 1.25 1.50 1.75 2.00  
S. EFFICIENCY W. THICKNESS= .12M W. ORIENTATION= .80  
WD= .12M HD1= .3M HD2= .3M HOUSE T.=2.0 ST.



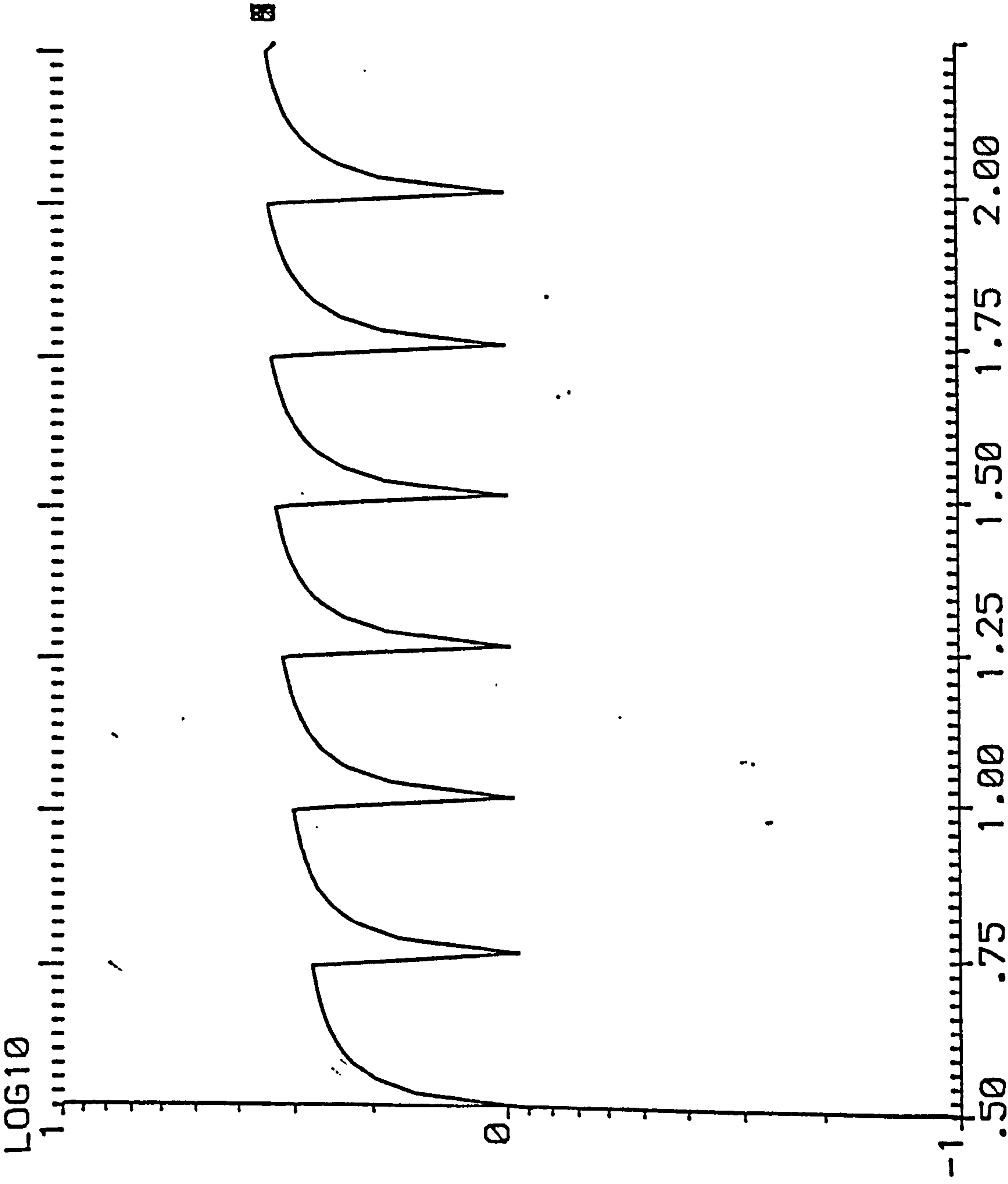

S. EFFICIENCY W. THICKNESS= .12M W. ORIENTATION= .00

WD= 12M HD1= 3M HD2= 3M HOUSE T.=2.0 ST.



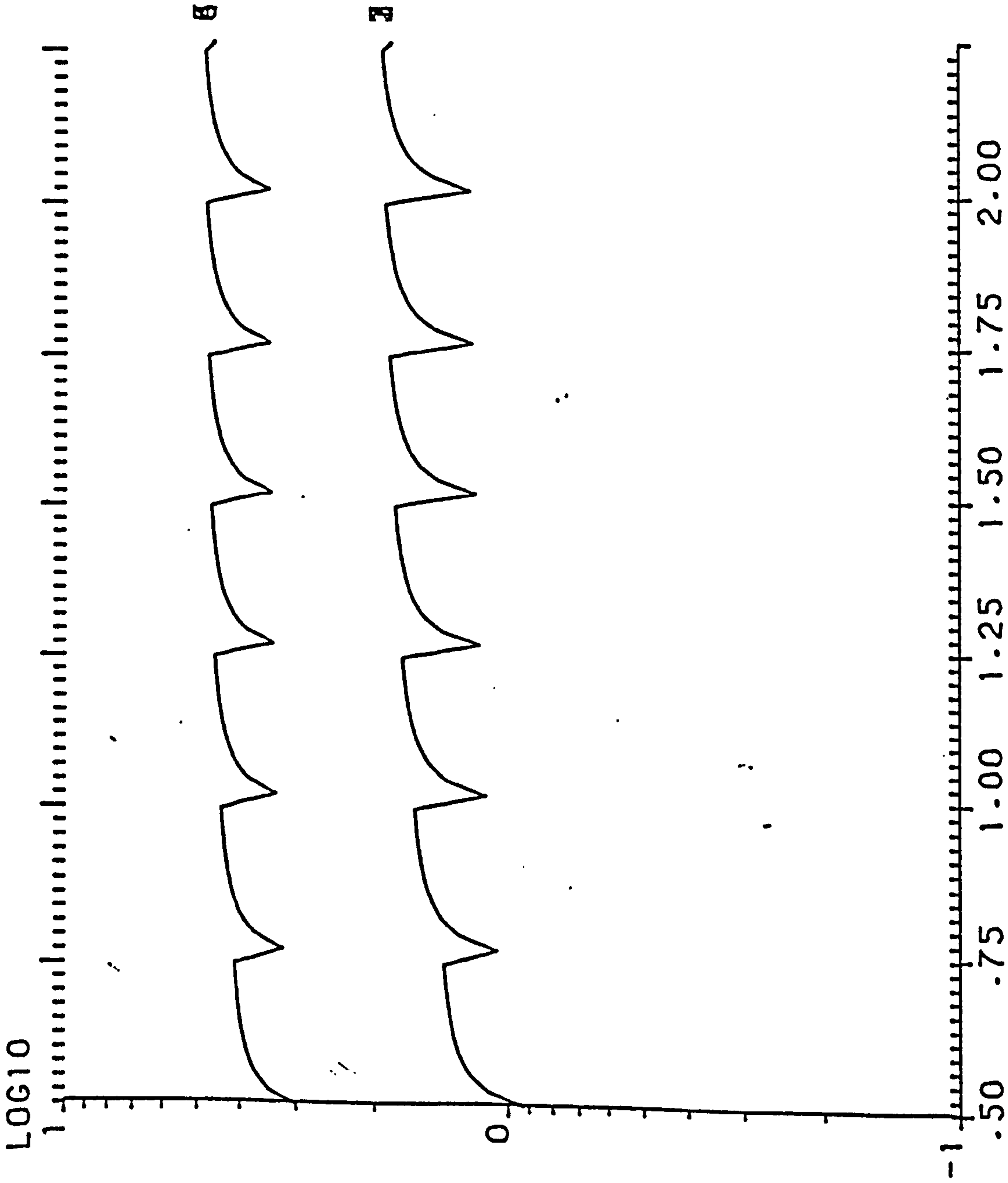

S. EFFICIENCY W. THICKNESS = .12M HD2 = 3M HOUSE T. = 2.0 ST.

WD = 12M HD1 = 3M HOUSE T. = 2.0 ST.

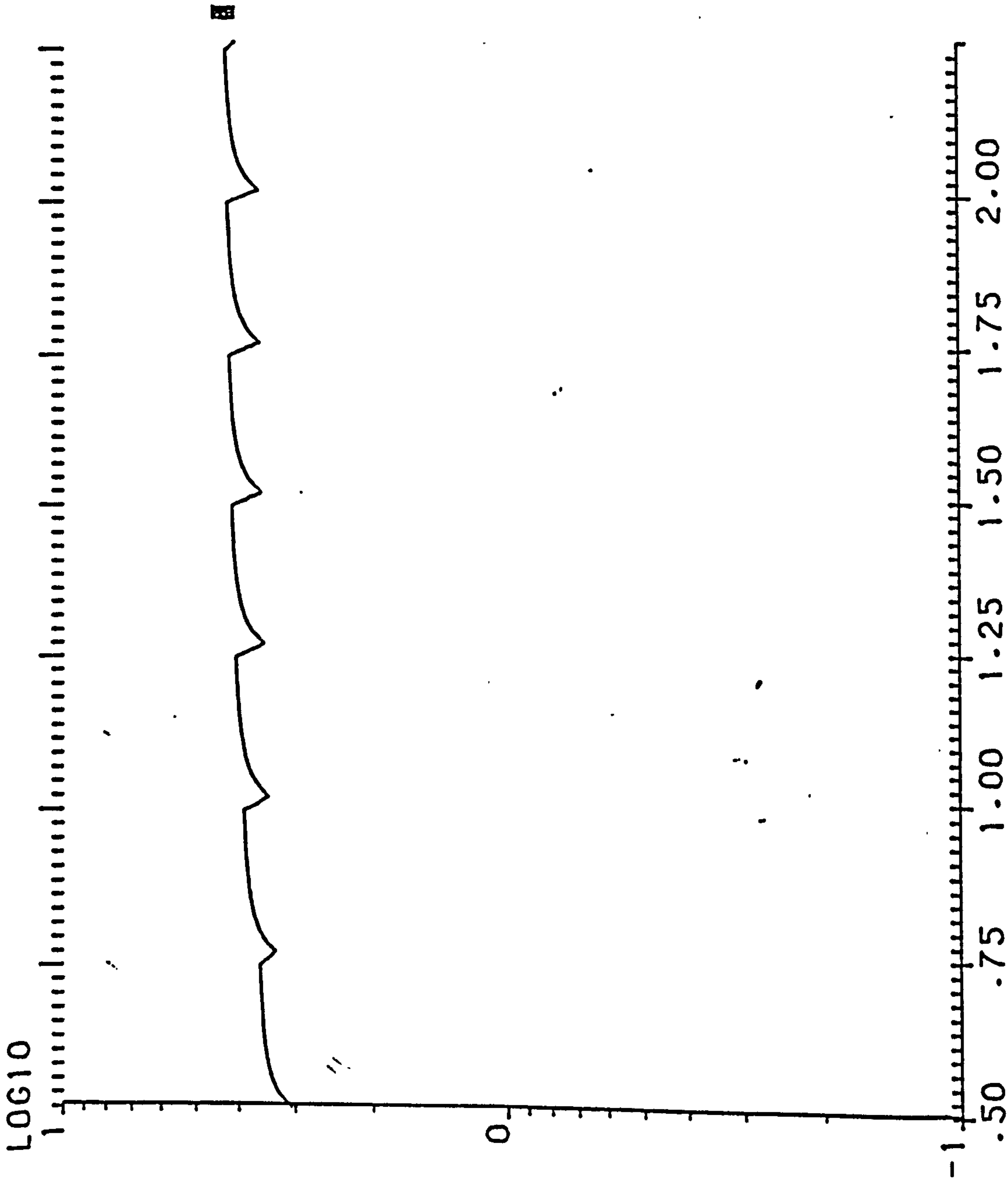

S. EFFICIENCY W. THICKNESS= .12M W. ORIENTATION= 45.00

WD= 12M HD1= 3M HD2= 3M HOUSE T.=2.0 ST.



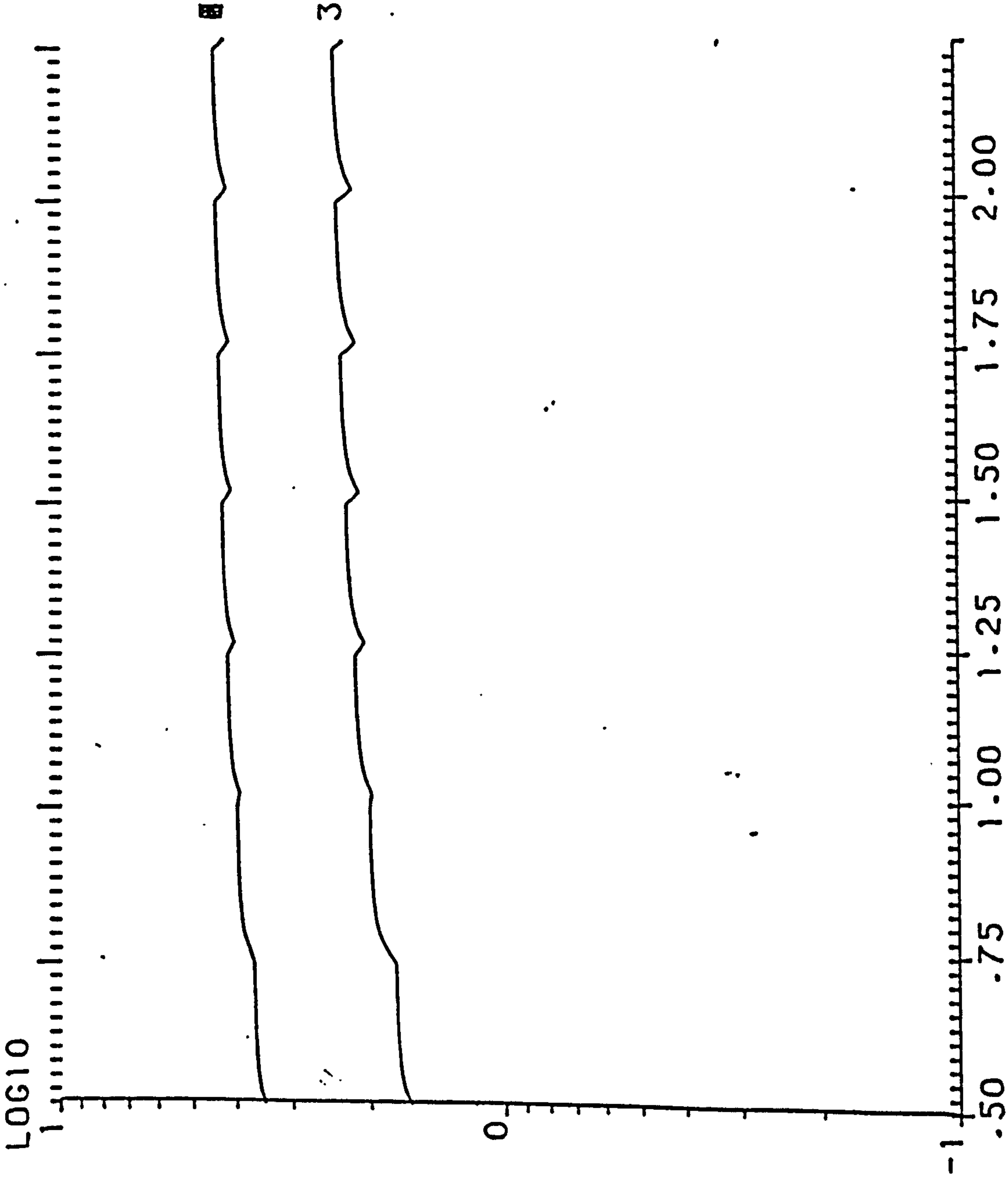

S. EFFICIENCY W. THICKNESS = .12M HD2 = 3M HOUSE T. = 2.0 ST. W. ORIENTATION = 67.50

WD = 12M HD1 = 3M

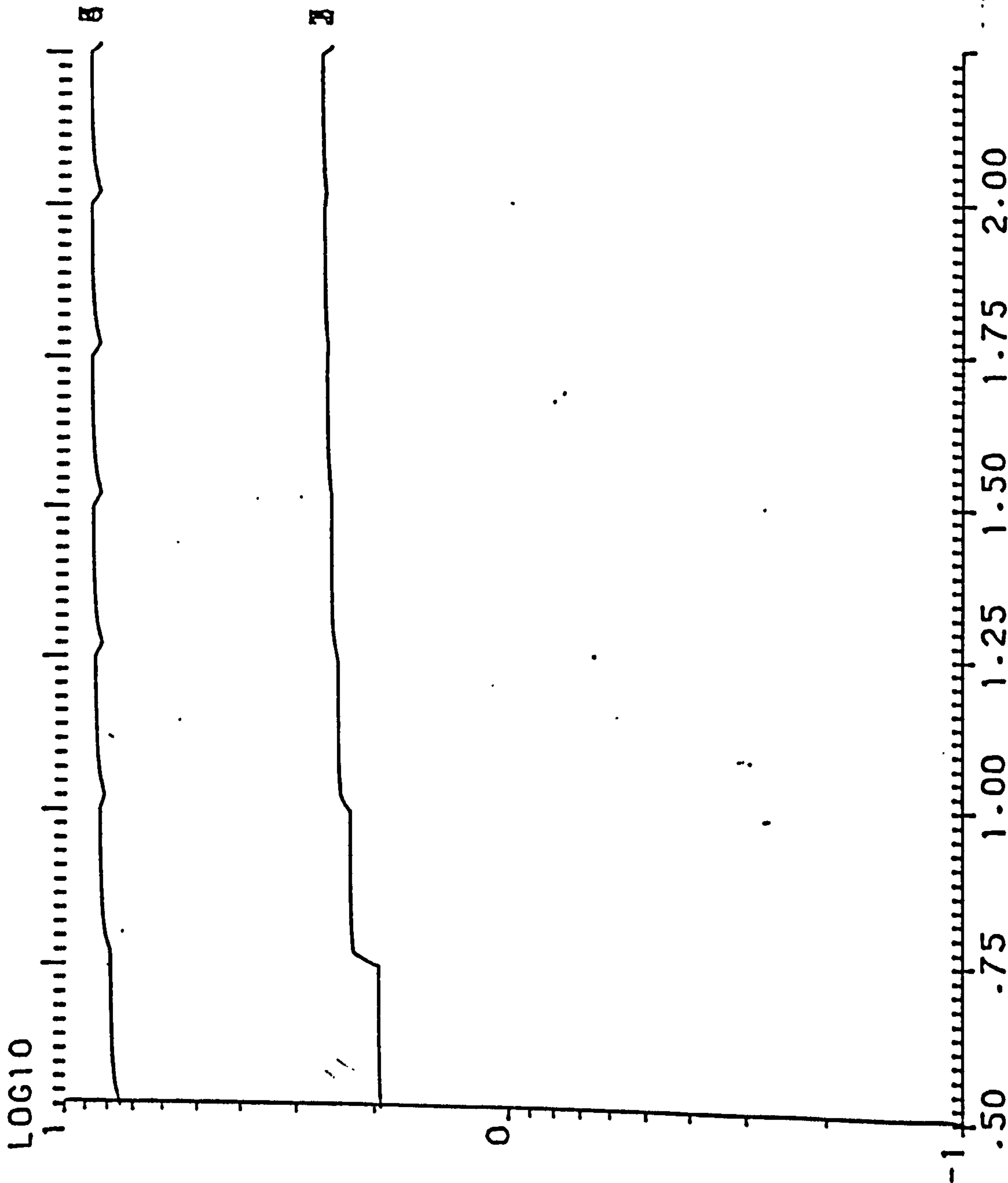

S. EFFICIENCY W. THICKNESS= .12M HD2= 3M HOUSE T.=2.0 ST.  
 W. ORIENTATION= 90.00



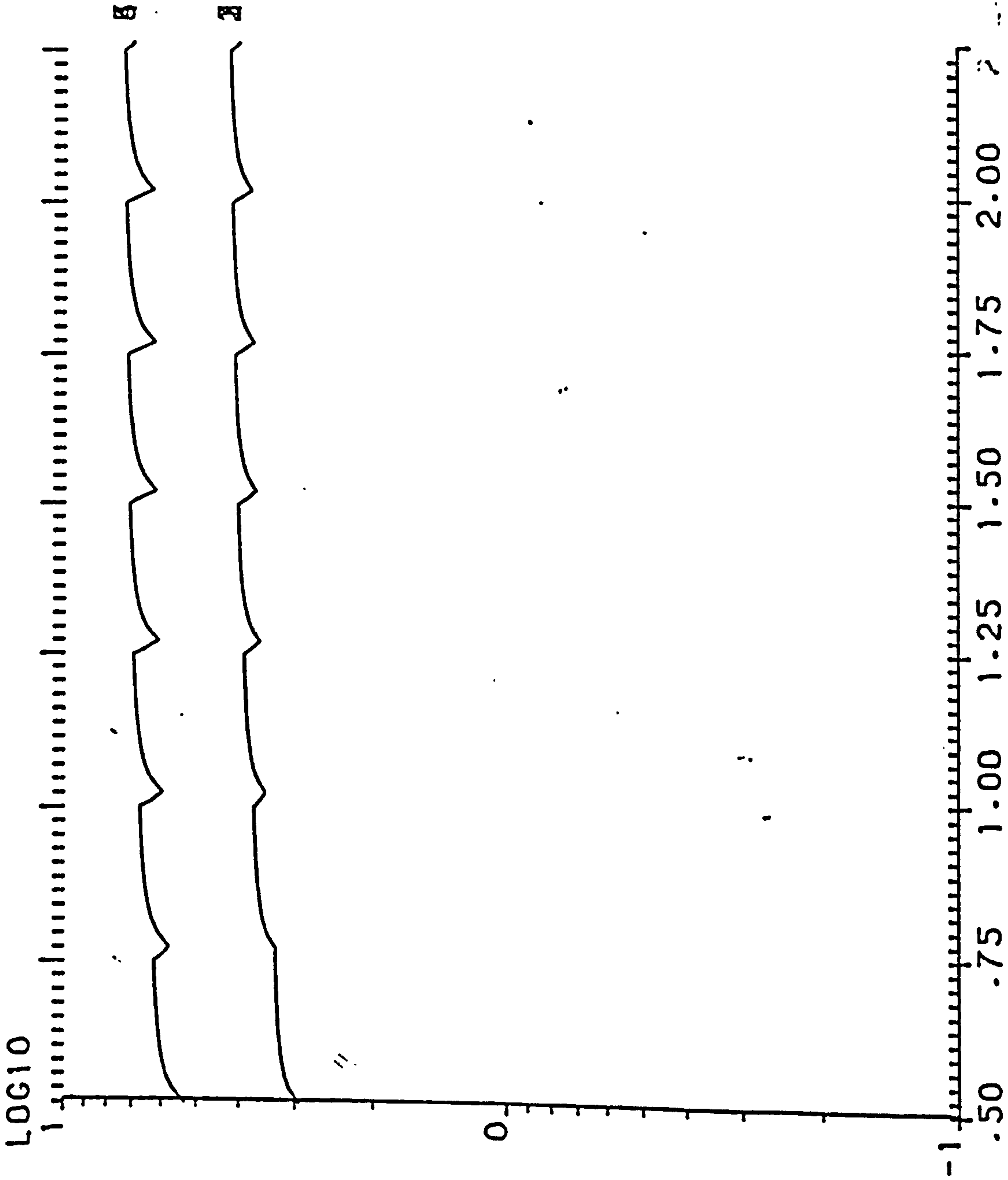

S. EFFICIENCY W. THICKNESS= .12M HD2= .3M HOUSE T.=2.0 ST.  
 W. ORIENTATION=112.50

WD= 12M HD1= 3M

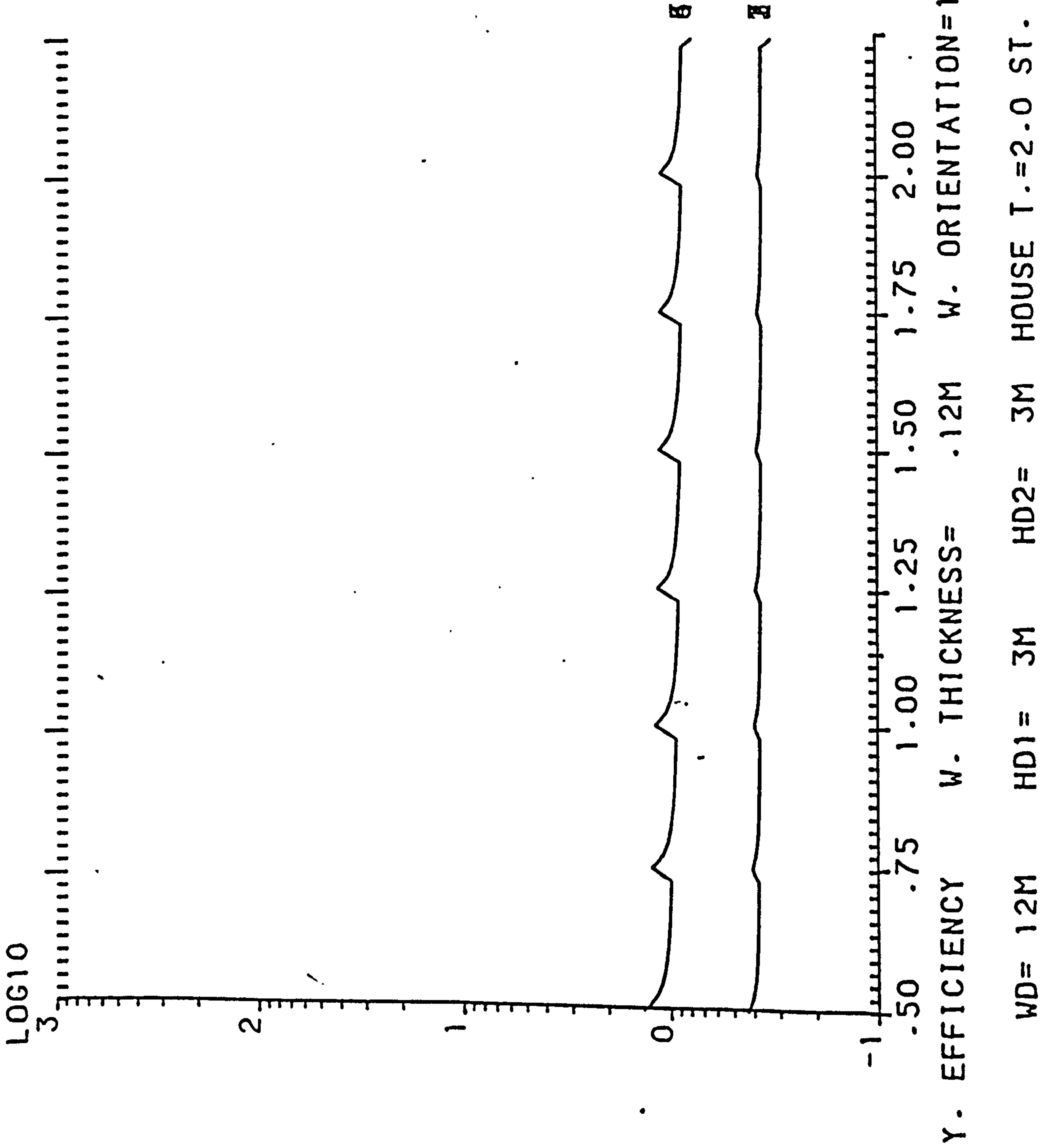

W. ORIENTATION=135.00

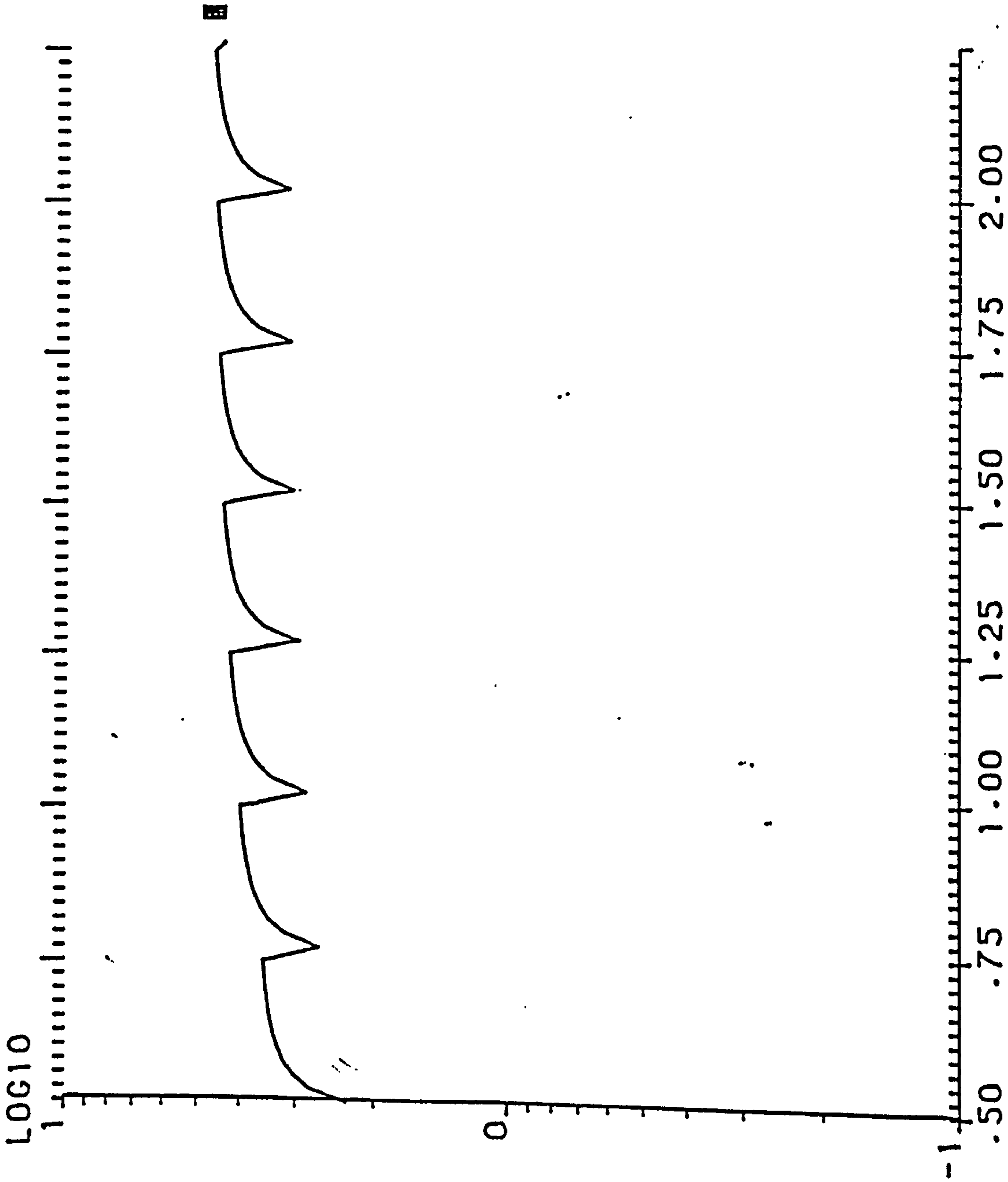

S. EFFICIENCY W. THICKNESS= .12M W. ORIENTATION=135.00

WD= 12M HD1= 3M HD2= 3M HOUSE T.=2.0 ST.

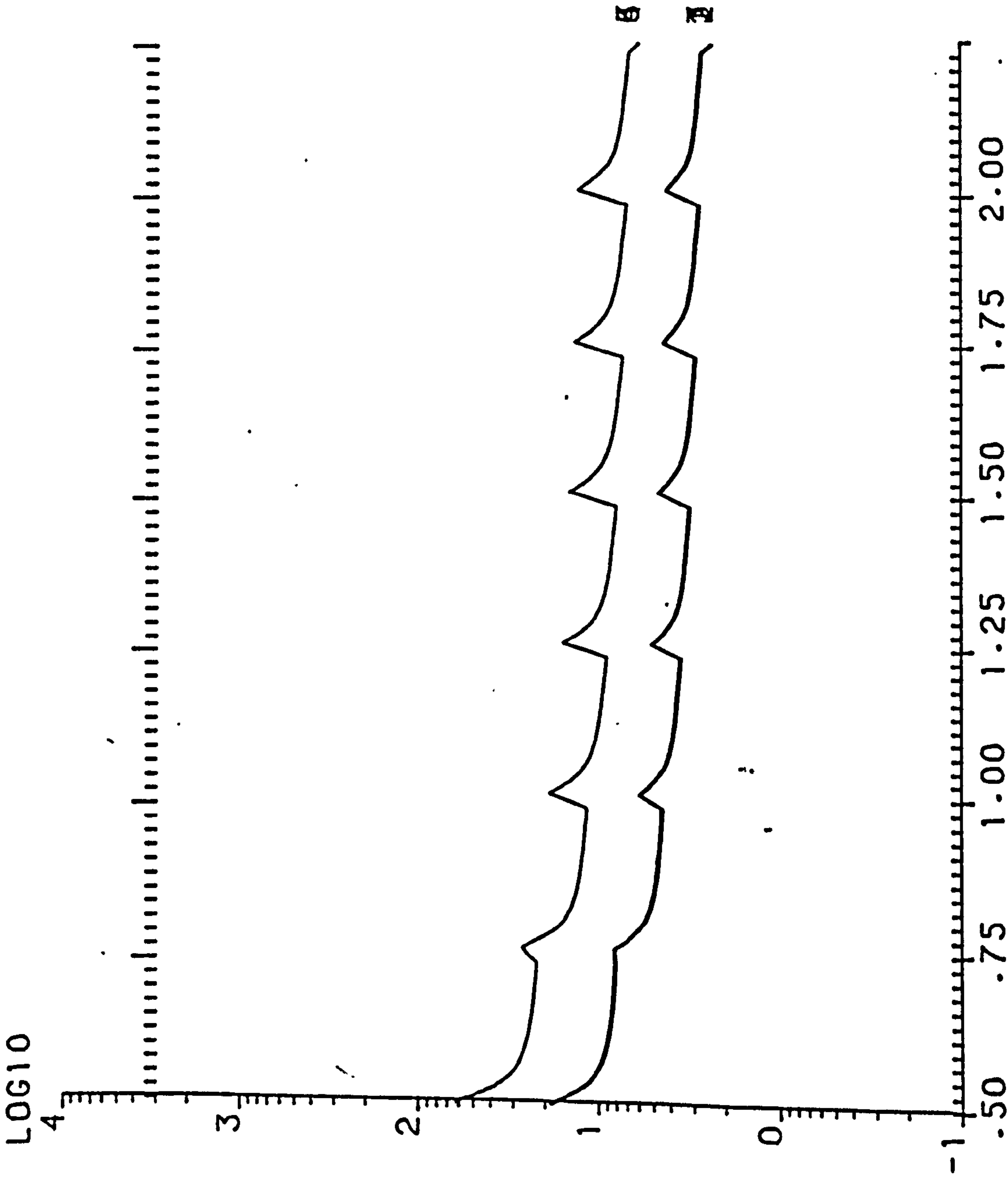

Y. EFFICIENCY W. THICKNESS= .12M W. ORIENTATION=157.50

WD= 12M HD1= 3M HD2= 3M HOUSE T.=2.0 ST.

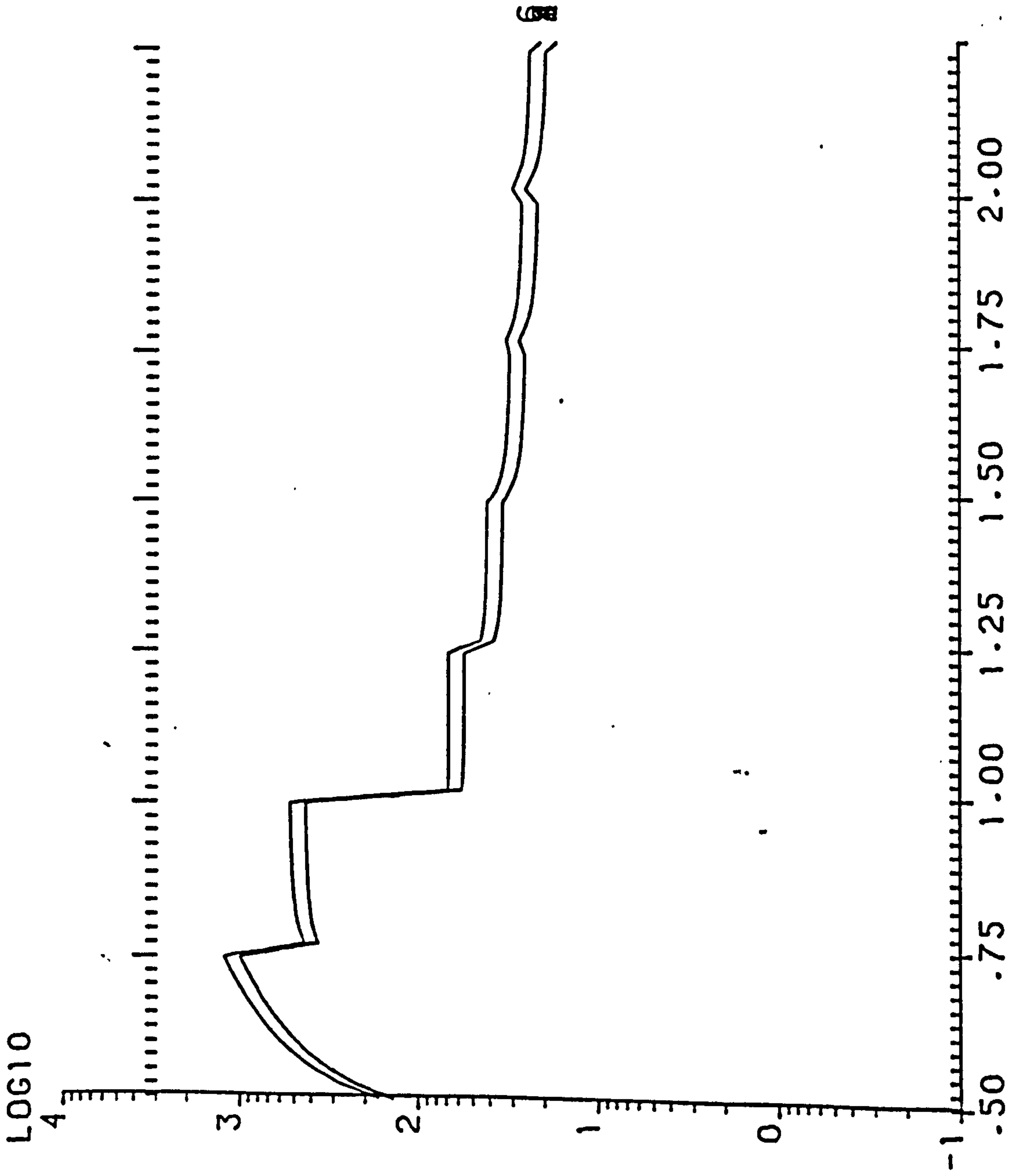

Y. EFFICIENCY W. THICKNESS= .12M W. ORIENTATION=180.00  
WD= 12M HD1= 3M HD2= 3M HOUSE T.=2.0 ST.



LOG10  
1  
0  
-1

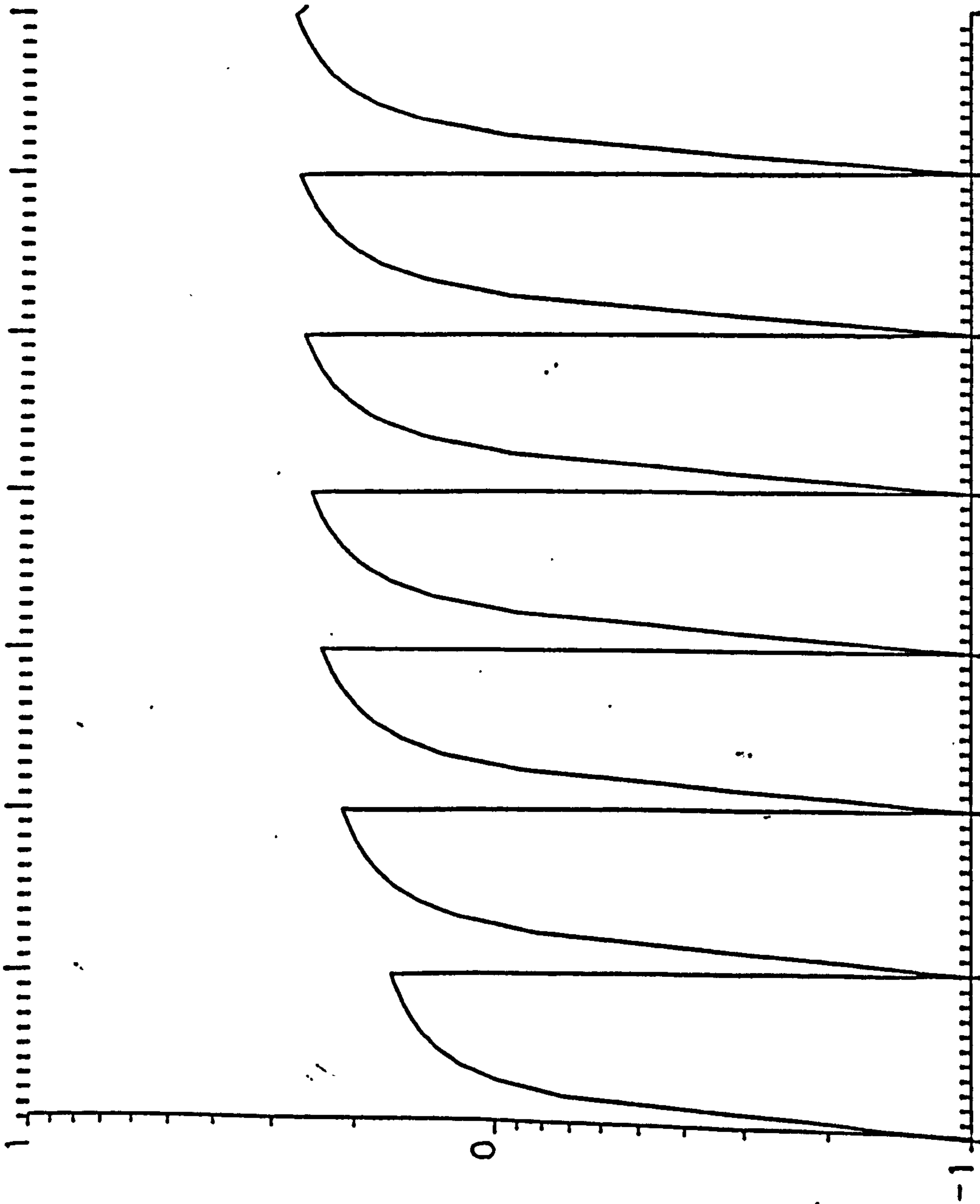

S. EFFICIENCY W. THICKNESS= .24M W. ORIENTATION= .00

WD= 12M HD1= 3M HD2= 3M HOUSE T.=2.0 ST.



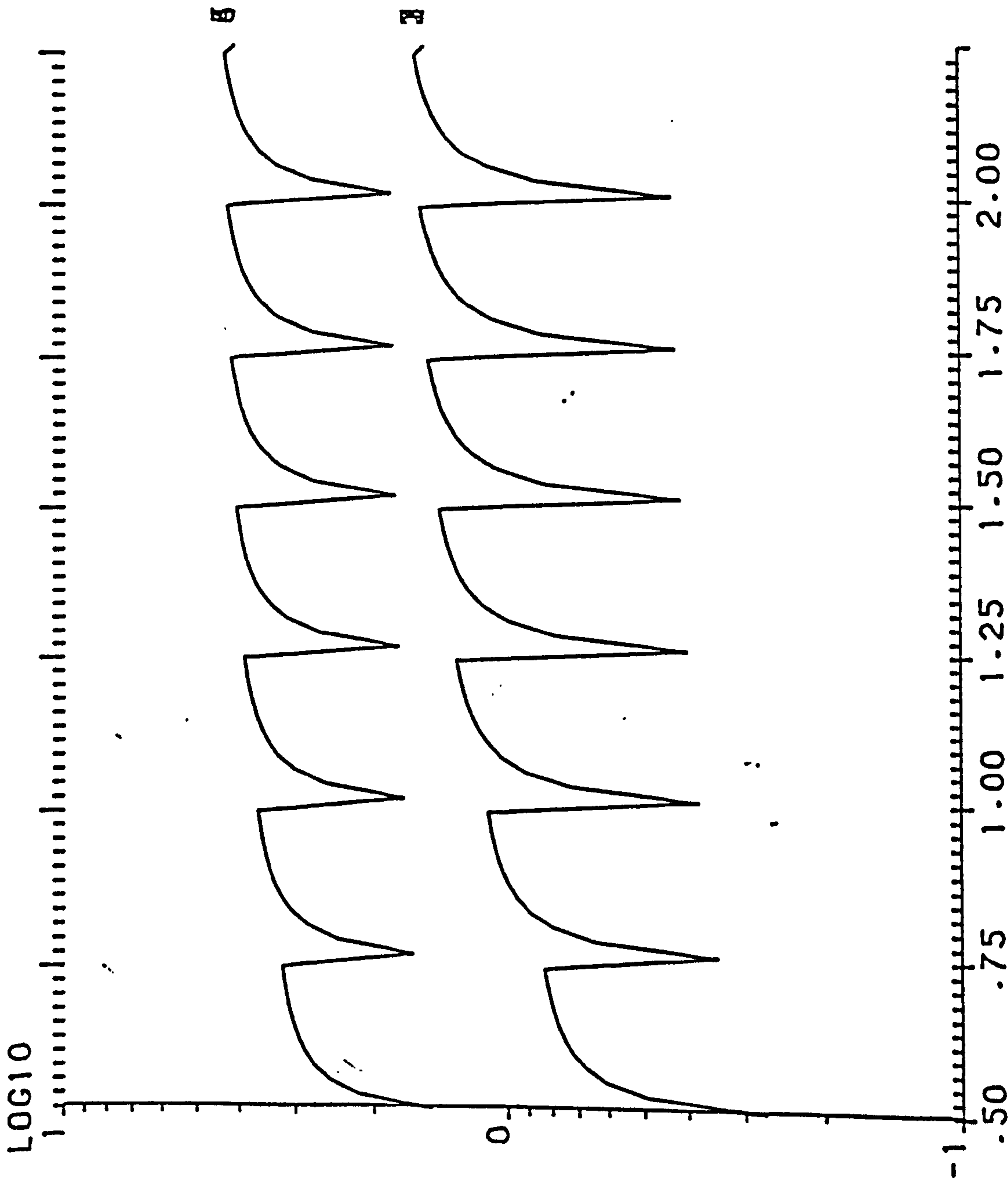

S. EFFICIENCY    W. THICKNESS= .24M    HD2= 3M    HOUSE T.=2.0 ST.  
 W. ORIENTATION= 22.50

WD= 12M    HD1= 3M

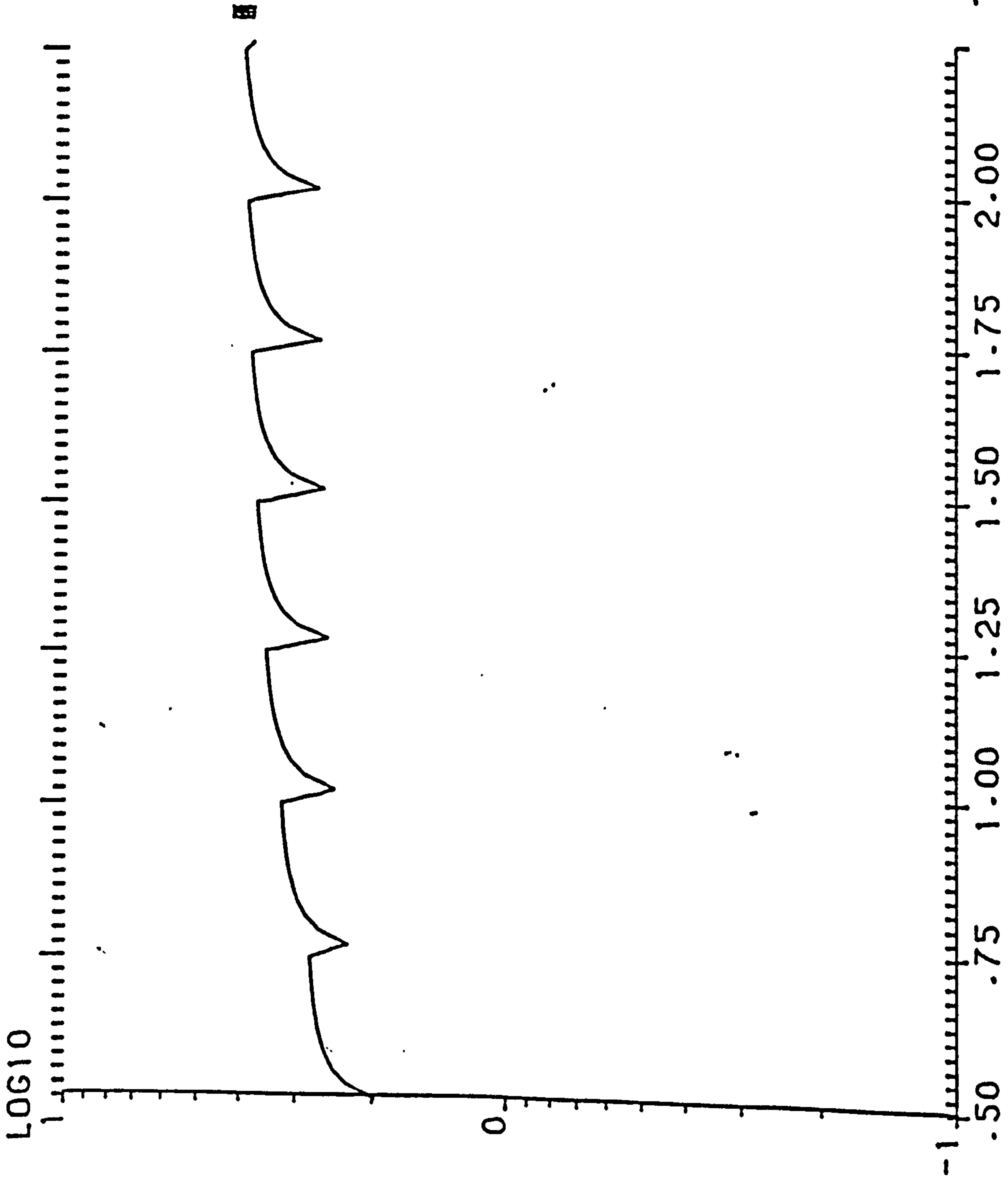

S. EFFICIENCY W. THICKNESS= .24M W. ORIENTATION= 45.00

WD= 12M HD1= 3M HD2= 3M HOUSE T.=2.0 ST.

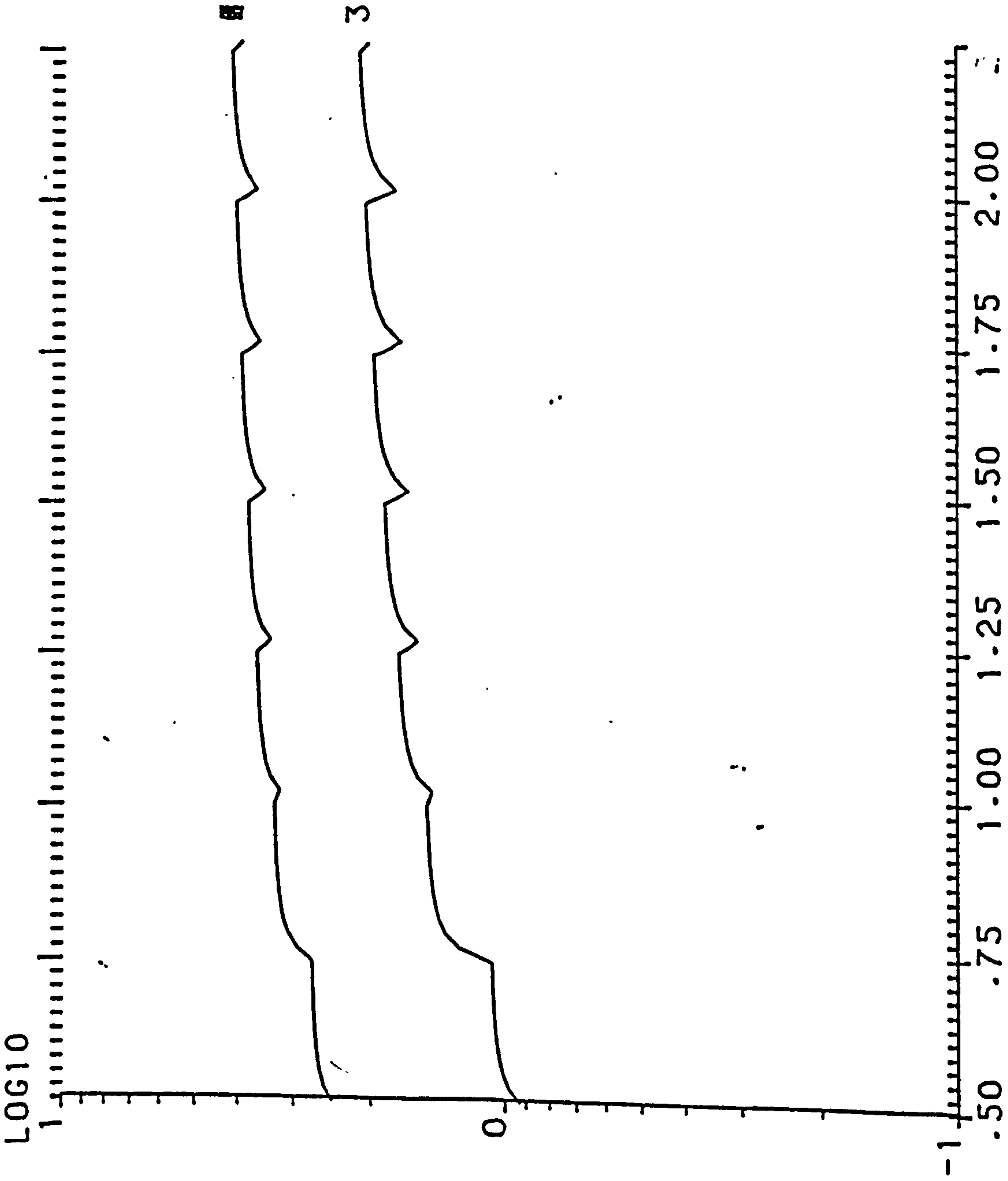

S. EFFICIENCY W. THICKNESS= .24M HD2= 3M HOUSE T.=2.0 ST.  
 WD= 12M HD1= 3M W. ORIENTATION= 67.50

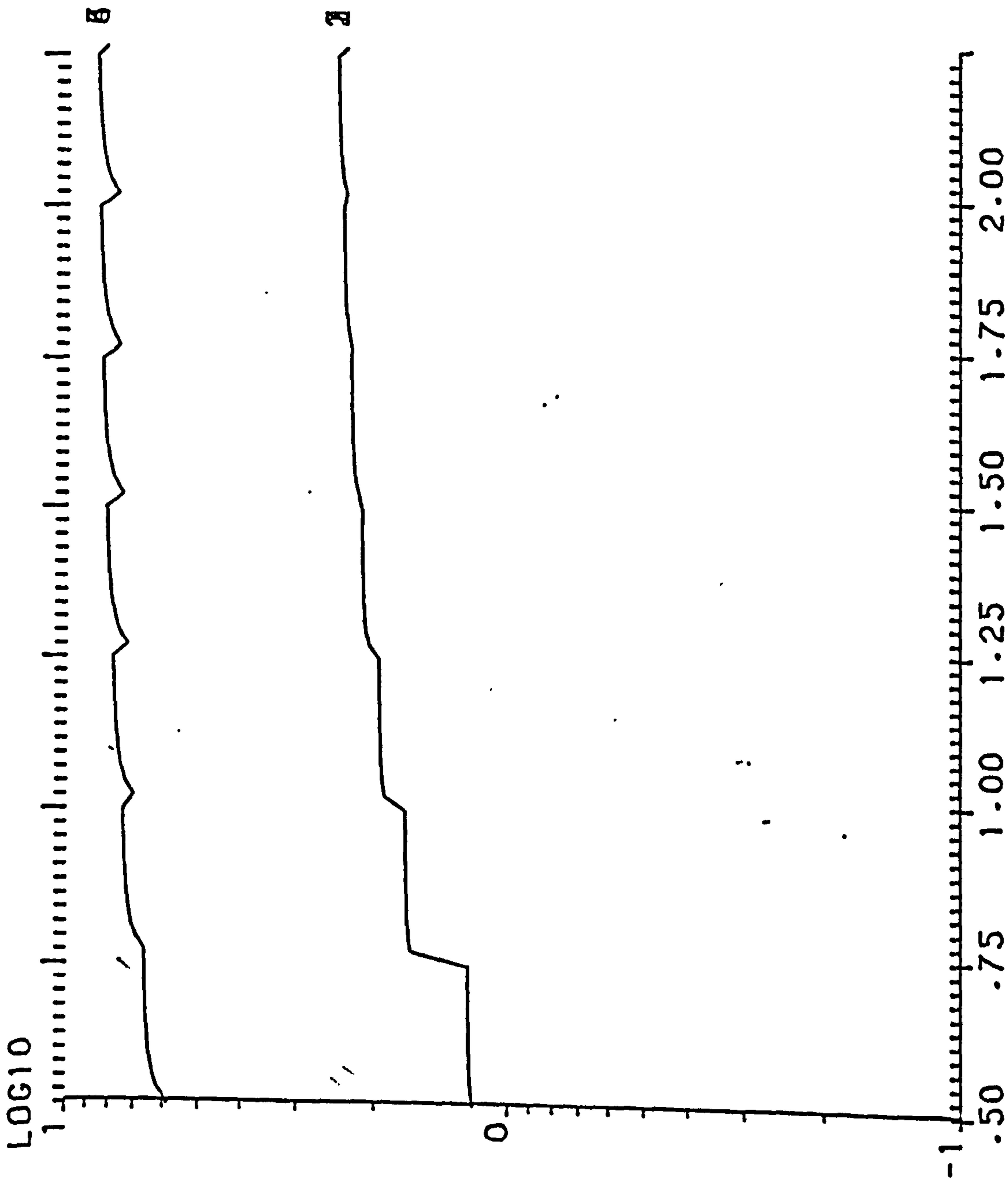

S. EFFICIENCY W. THICKNESS= .24M W. ORIENTATION= 90.00

WD= 12M HD1= 3M HD2= 3M HOUSE T.=2.0 ST.



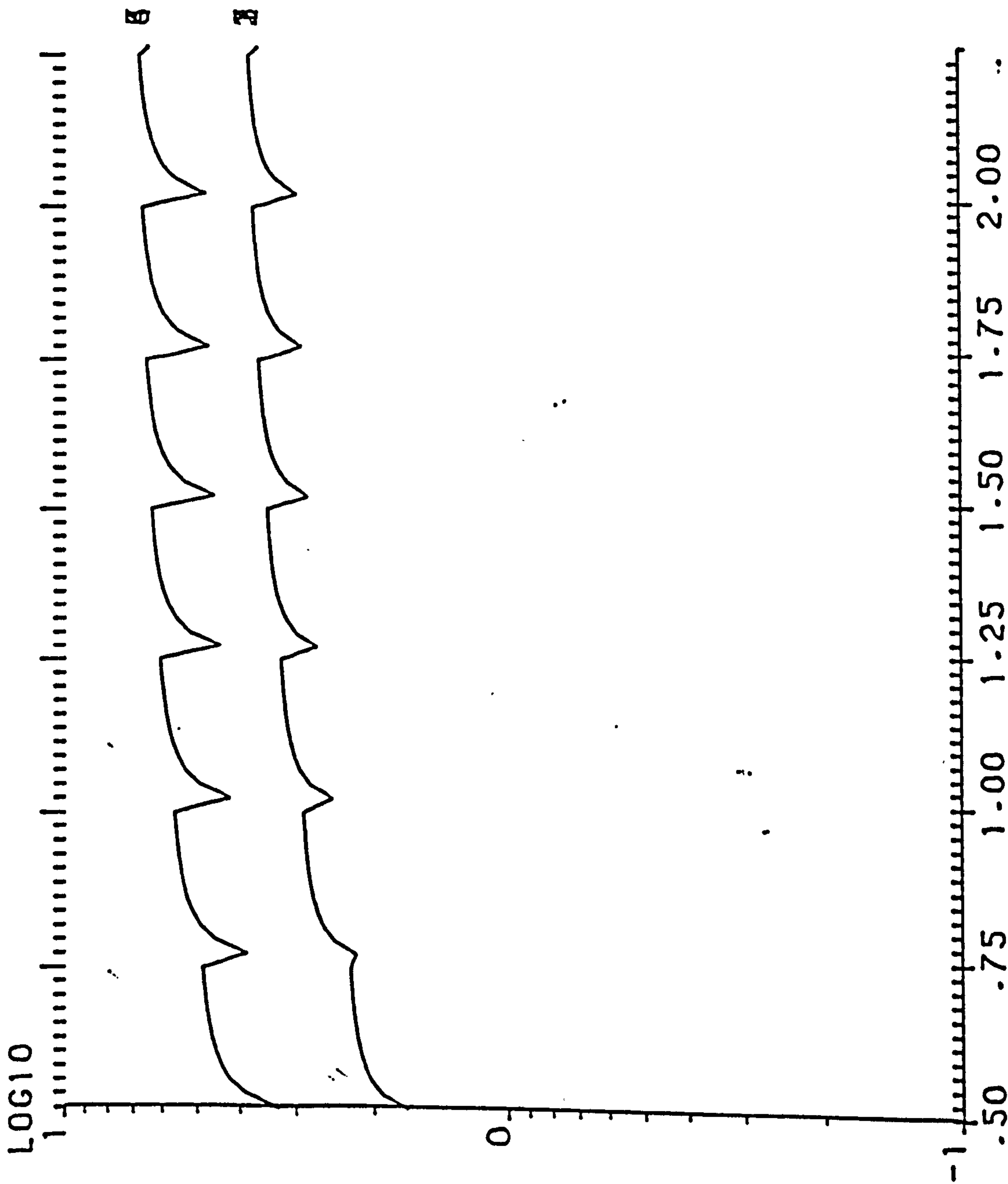

S. EFFICIENCY W. THICKNESS= .24M W. ORIENTATION=112.50  
 HD1= 3M HD2= 3M HOUSE T.=2.0 ST.  
 WD= 12M

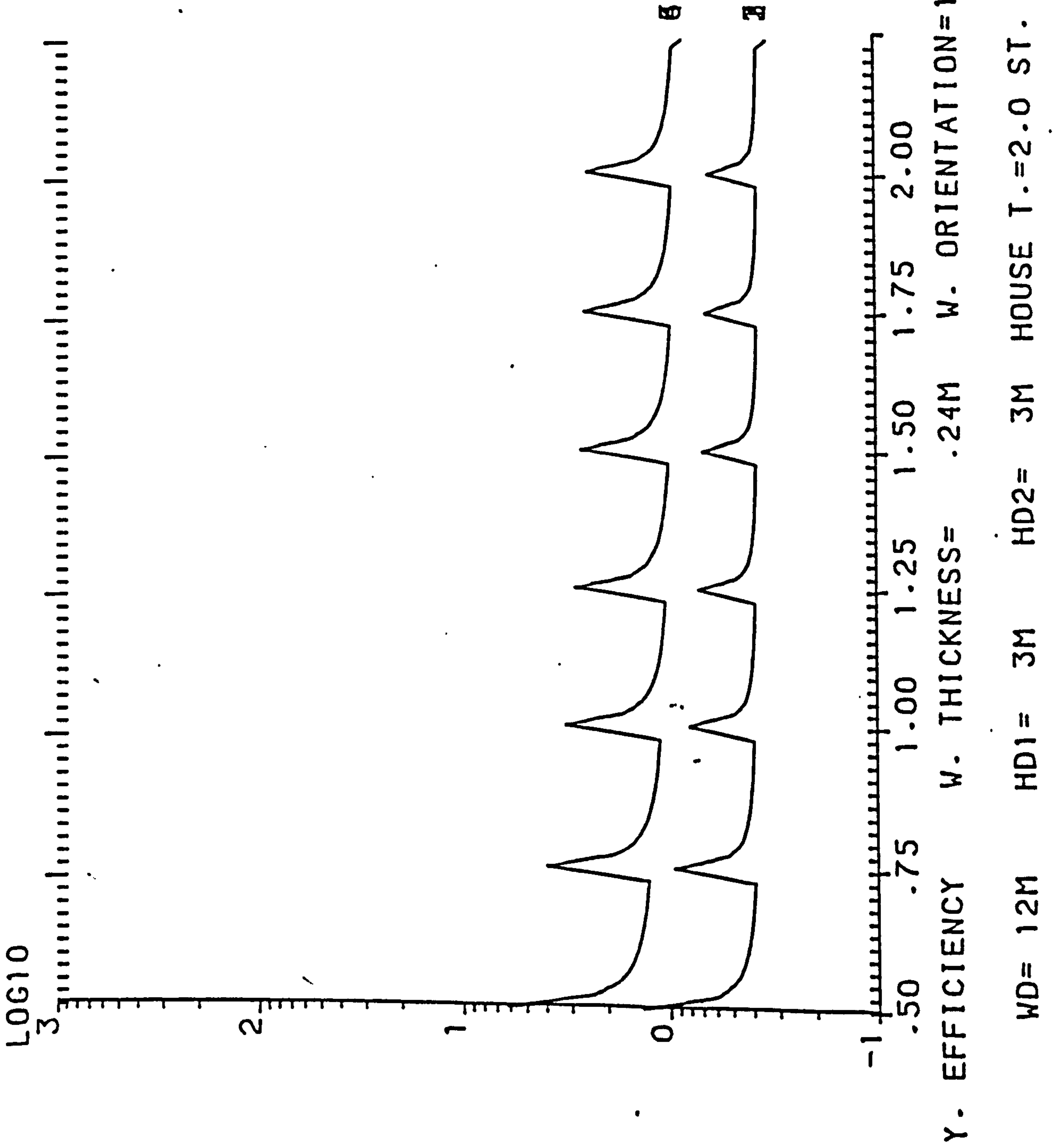

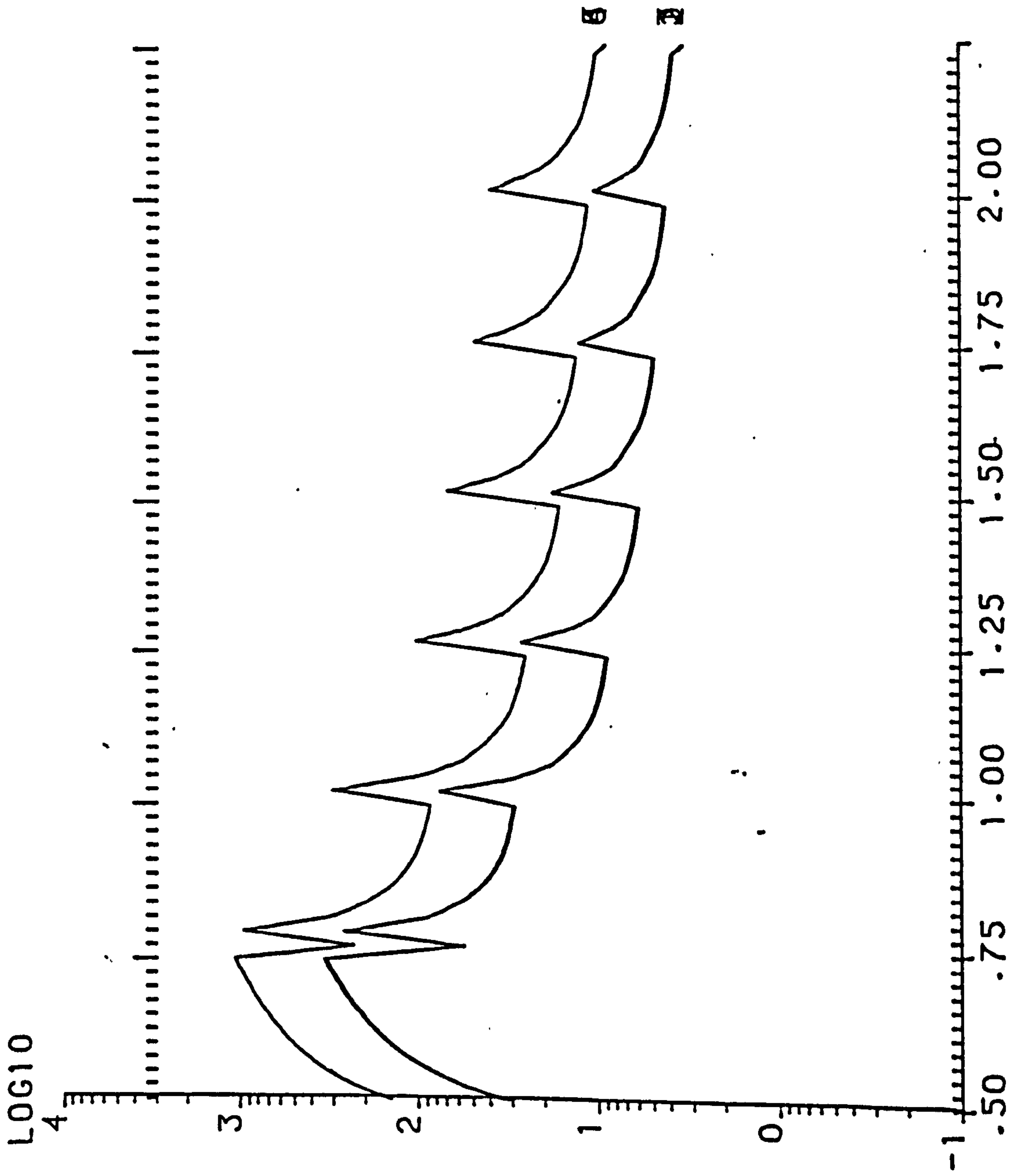

Y. EFFICIENCY W. THICKNESS= .24M W. ORIENTATION=157.50  
WD= 12M HD1= 3M HD2= 3M HOUSE T.=2.0 ST.

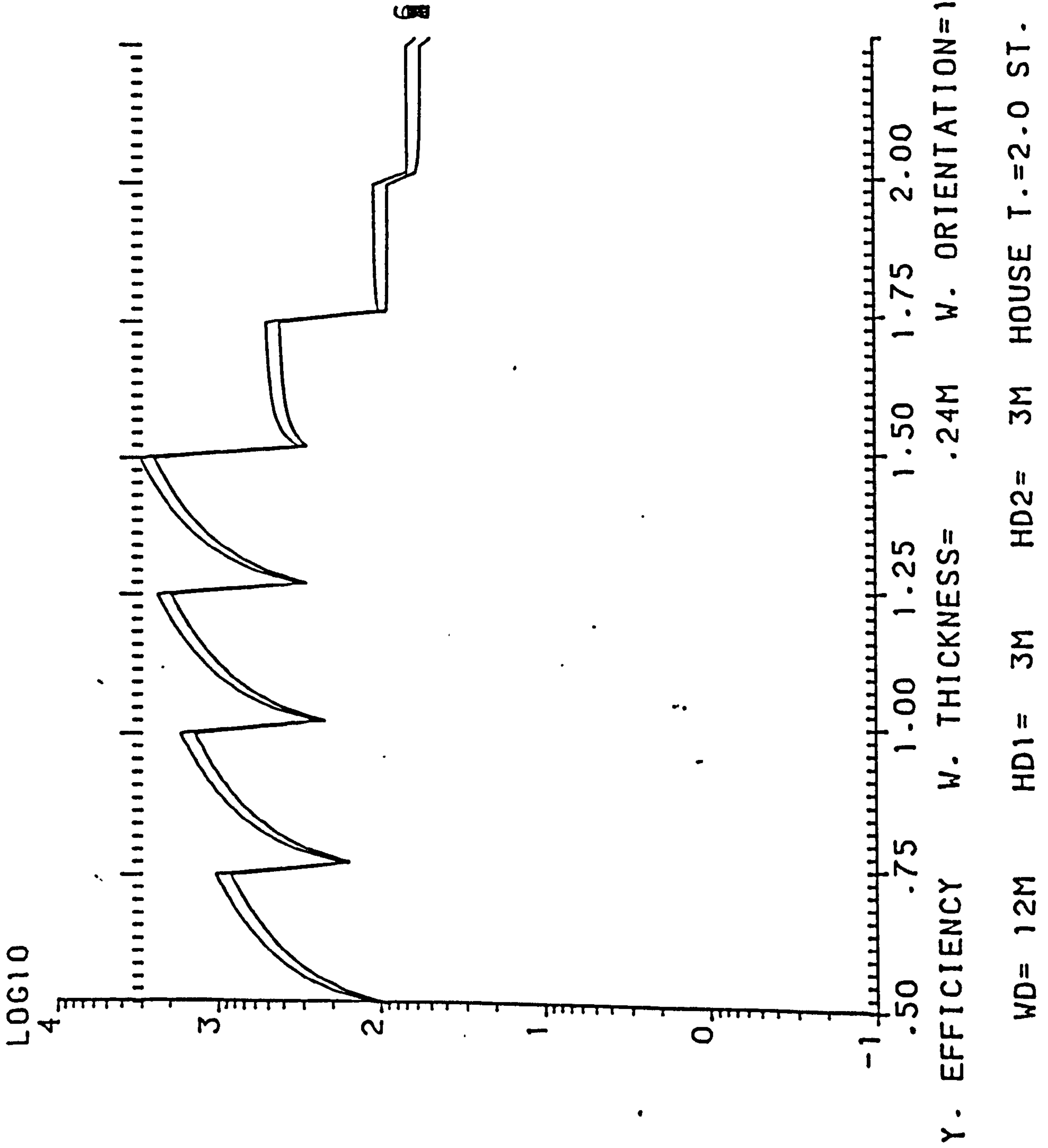

LOG10

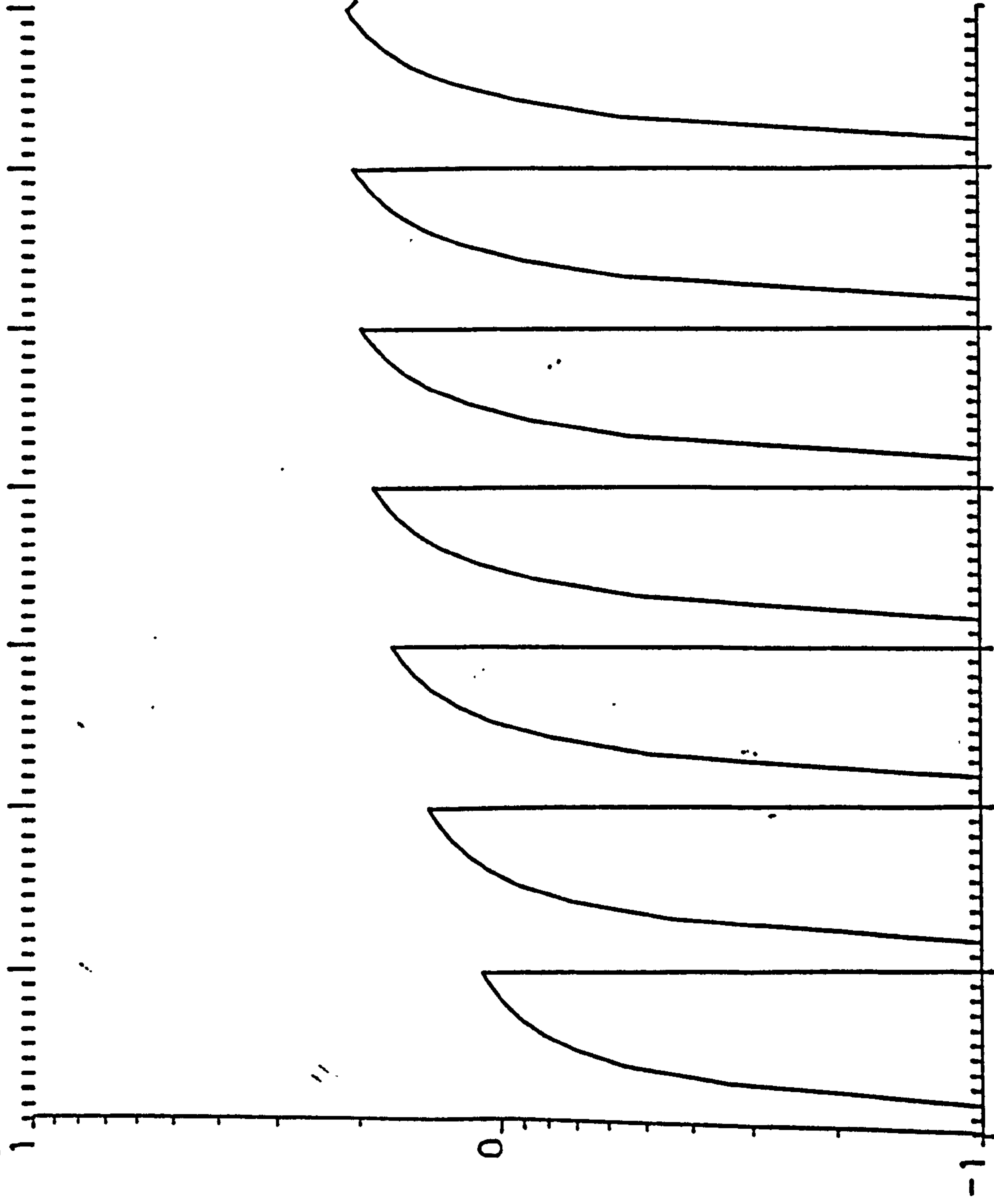

S. EFFICIENCY W. THICKNESS= .36M W. ORIENTATION= .00

WD= 12M HD1= 3M HD2= 3M HOUSE T.=2.0 ST.





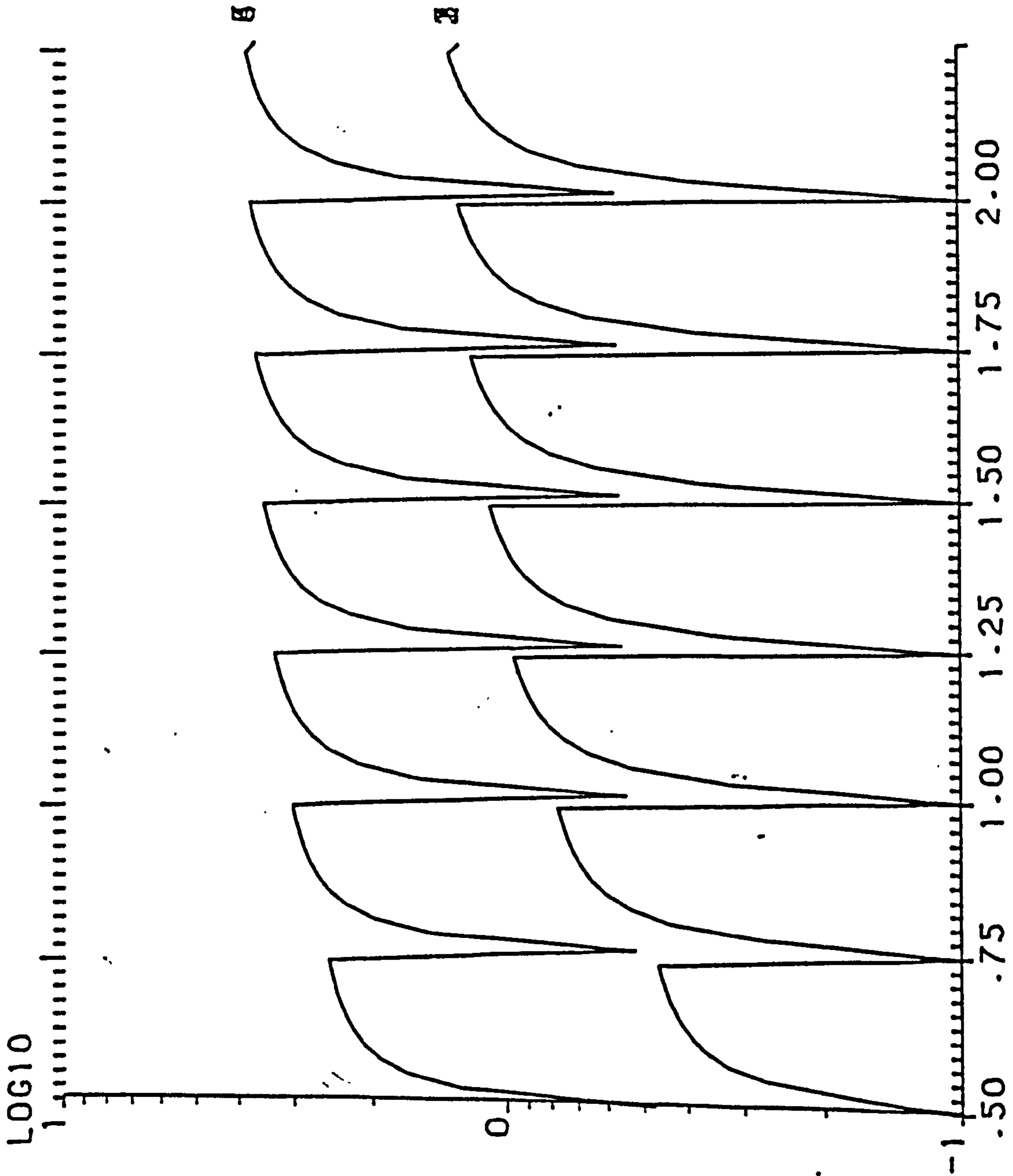

S. EFFICIENCY    W. THICKNESS=    .36M    HD2=    3M    HOUSE T.=2.0 ST.  
 WD= 12M    HD1=    3M

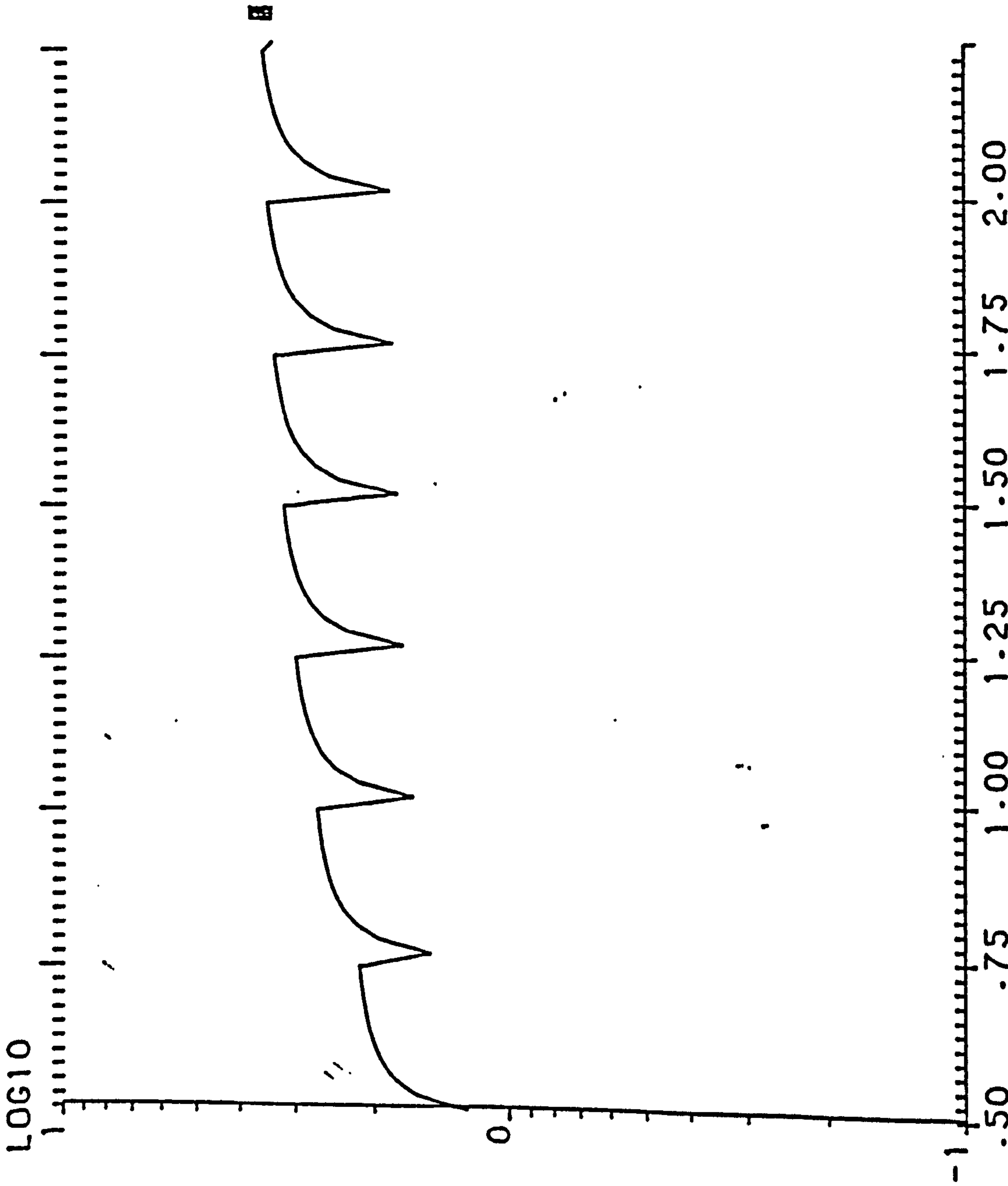

S. EFFICIENCY W. THICKNESS= .36M W. ORIENTATION= 45.00

WD= 12M HD1= 3M HD2= 3M HOUSE T.=2.0 ST.

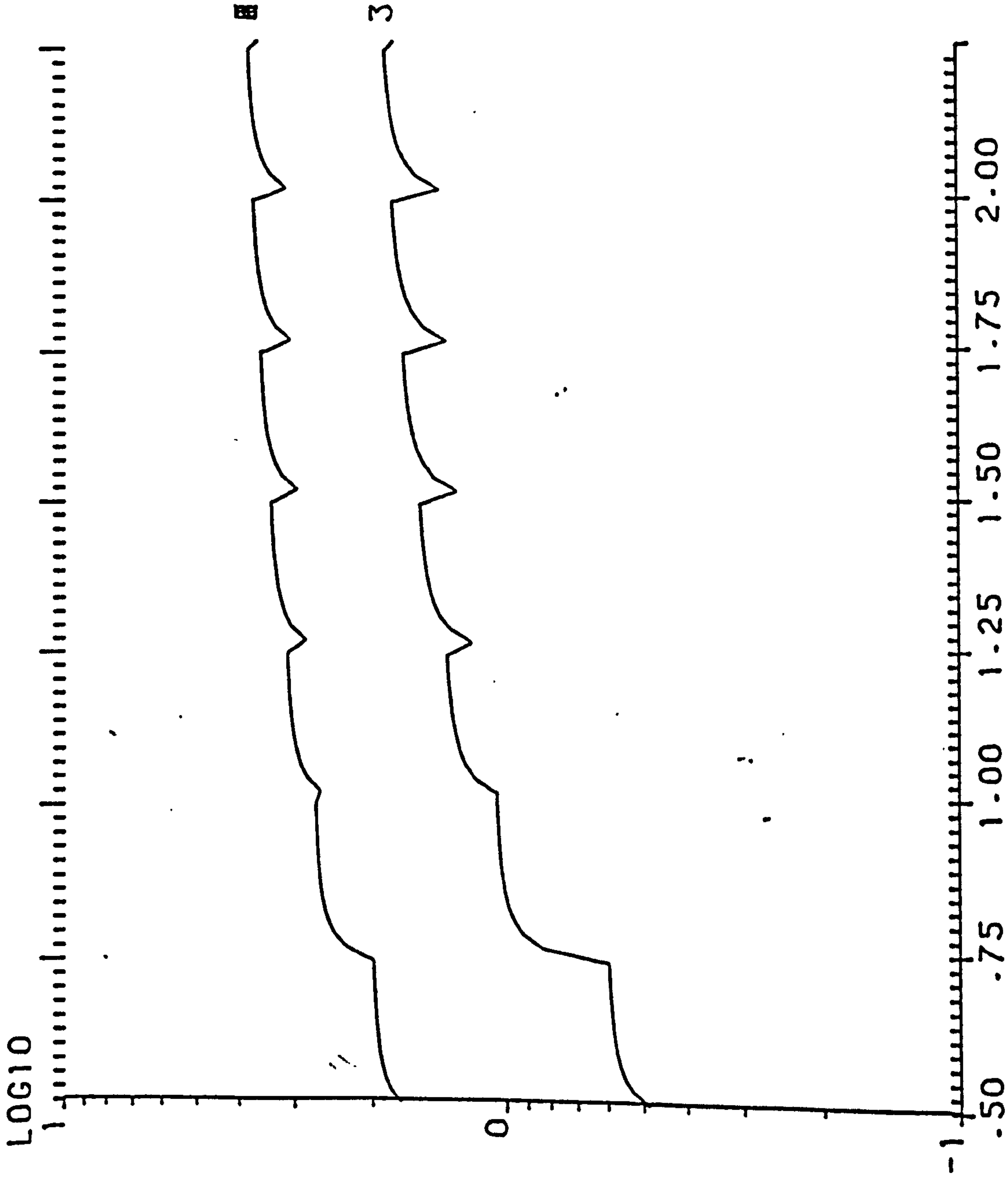

S. EFFICIENCY W. THICKNESS= .36M W. ORIENTATION= 67.50

WD= 12M HD1= 3M HD2= 3M HOUSE T.=2.0 ST.



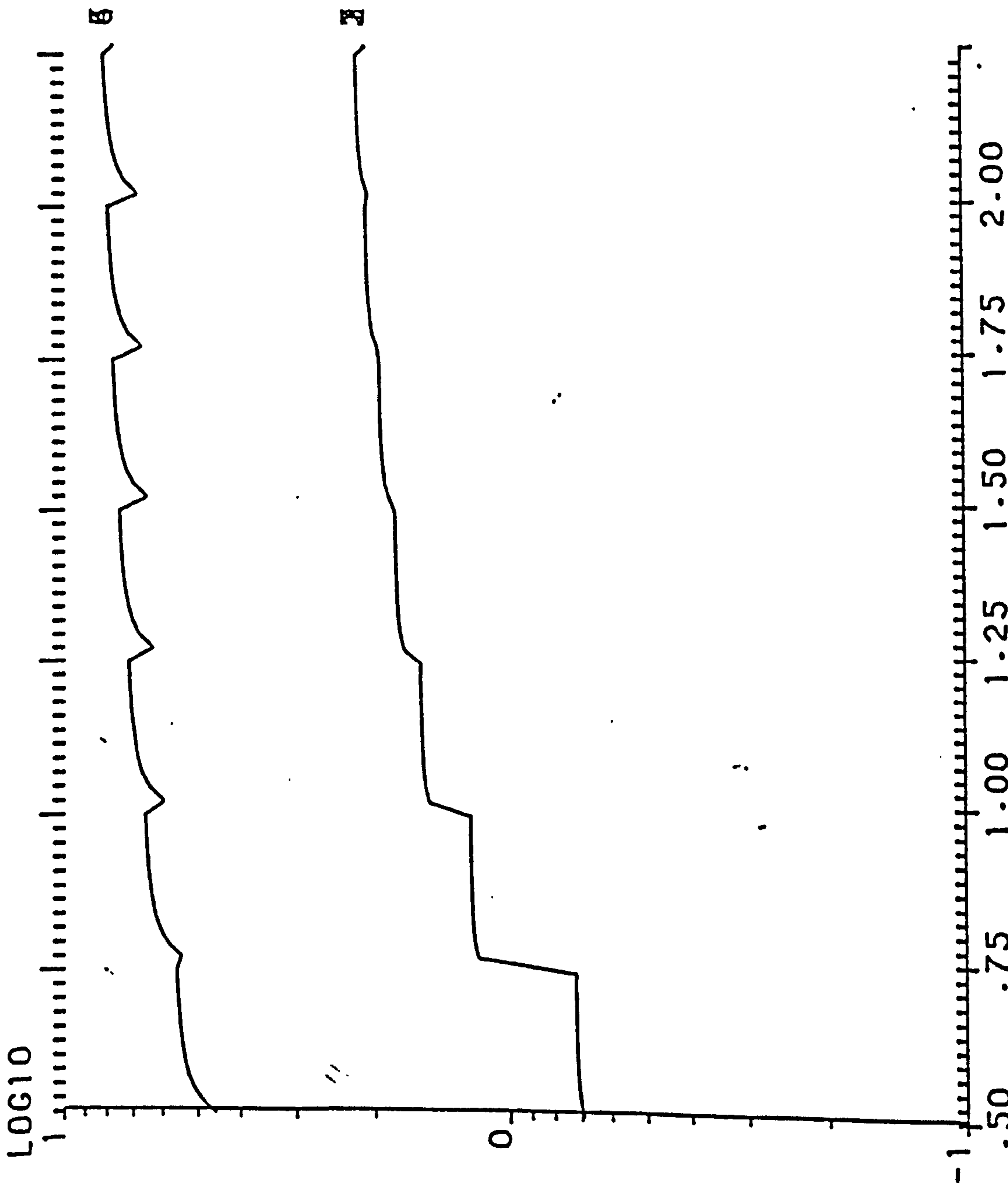

S. EFFICIENCY W. THICKNESS= .36M HD2= 3M HOUSE T.=2.0 ST.  
 W. ORIENTATION= 90.00

WD= 12M HD1= 3M

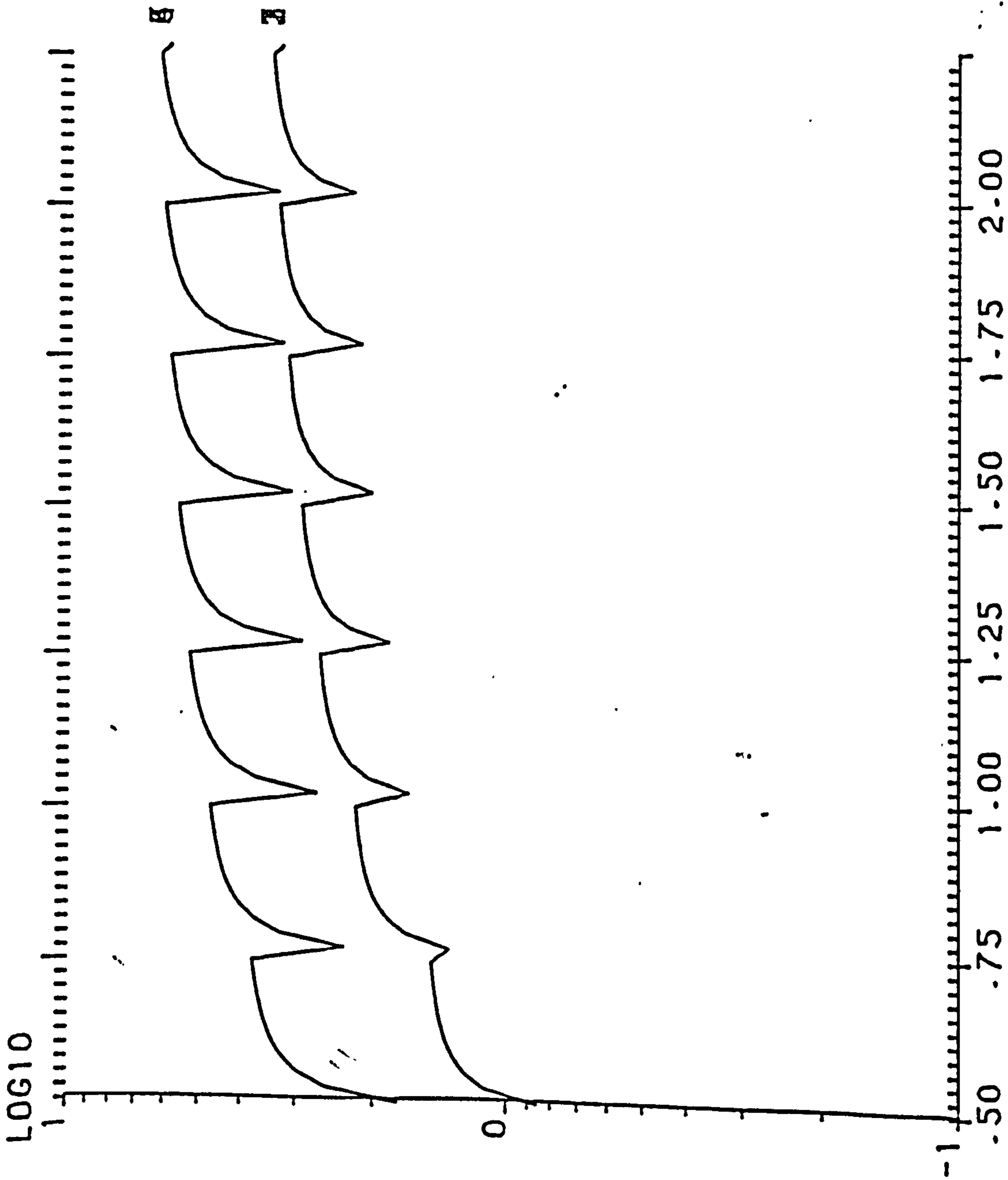

S. EFFICIENCY W. THICKNESS= .36M W. ORIENTATION=112.50

WD= 12M HD1= 3M HD2= 3M HOUSE T.=2.0 ST.



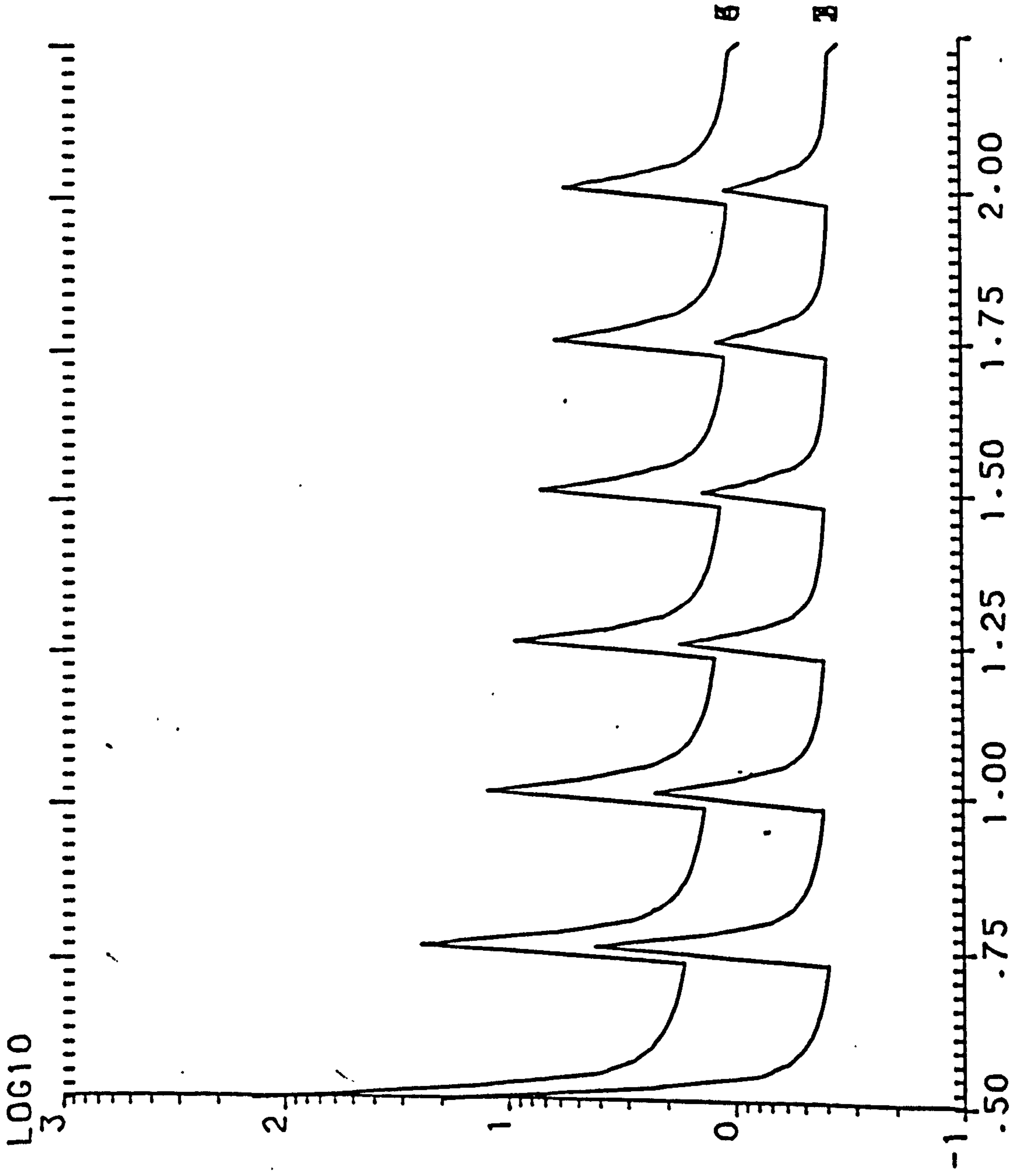

Y. EFFICIENCY W. THICKNESS= .36M W. ORIENTATION=135.00

WD= 12M HD1= 3M HD2= 3M HOUSE T.=2.0 ST.

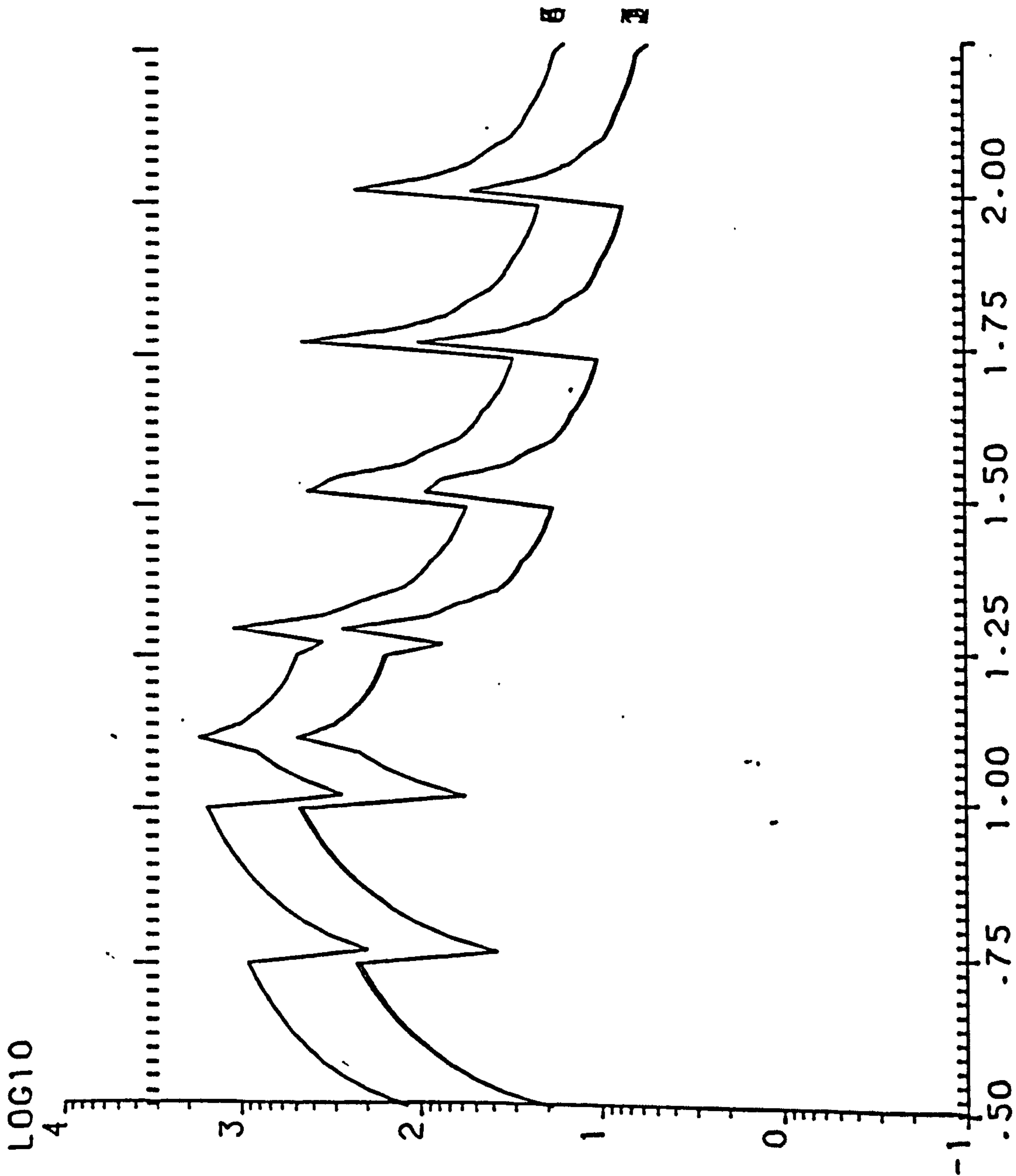

Y. EFFICIENCY W. THICKNESS= .36M W. ORIENTATION=157.50

WD= 12M HD1= 3M HD2= 3M HOUSE T.=2.0 ST.

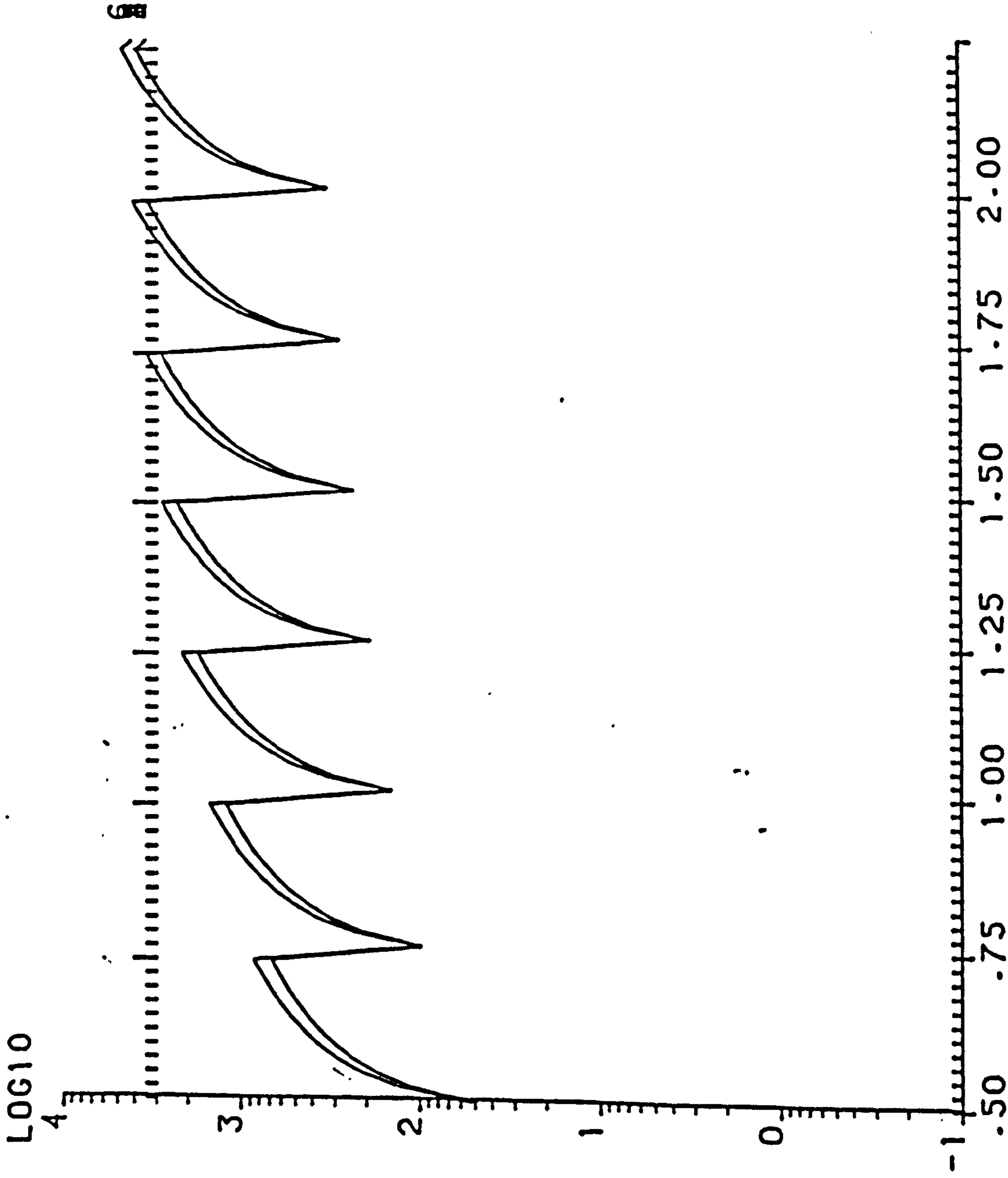

Y. EFFICIENCY W. THICKNESS= .36M W. ORIENTATION=180.00

WD= 12M HD1= 3M HD2= 3M HOUSE T.=2.0 ST.



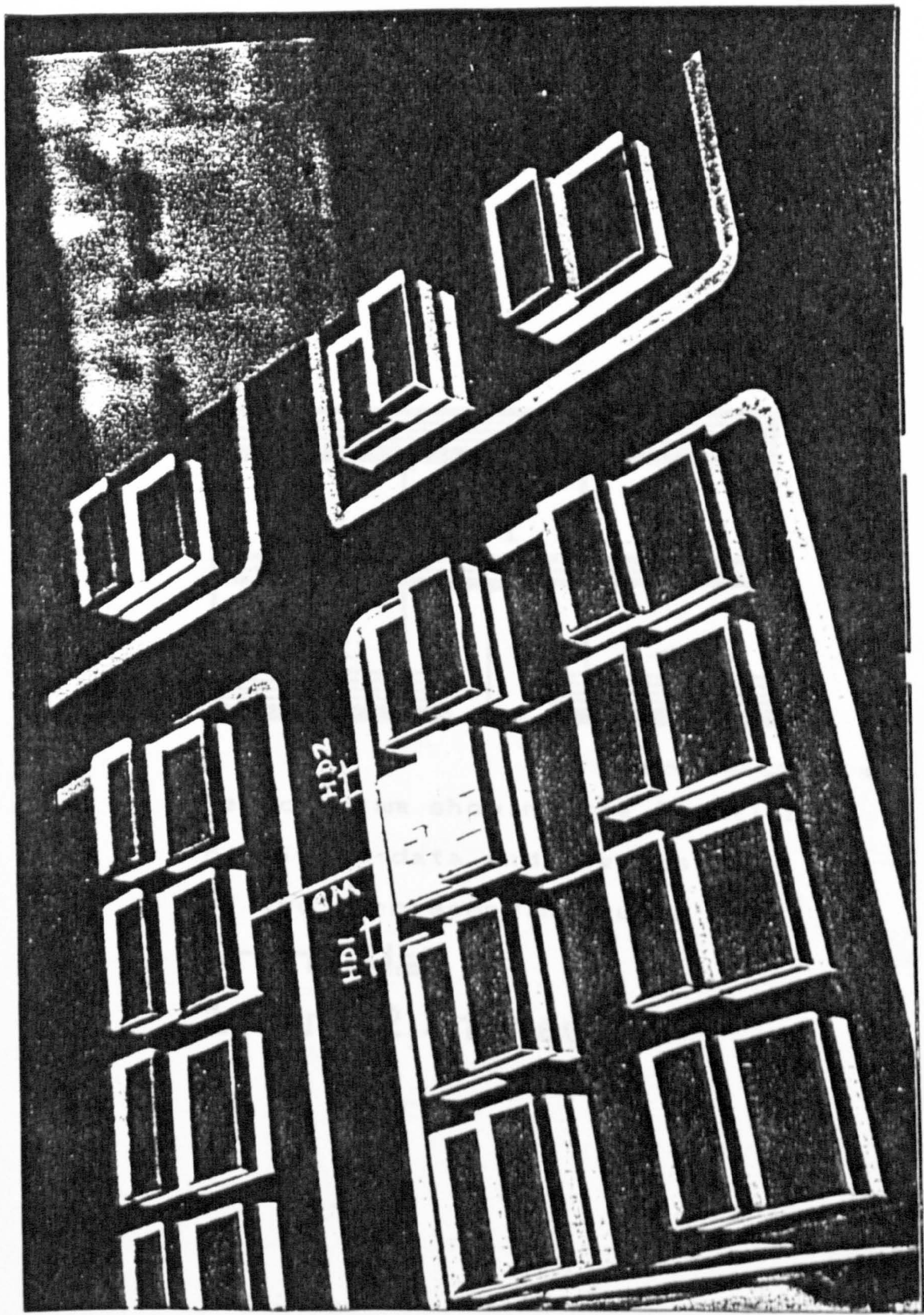

Model showing interhouse distances



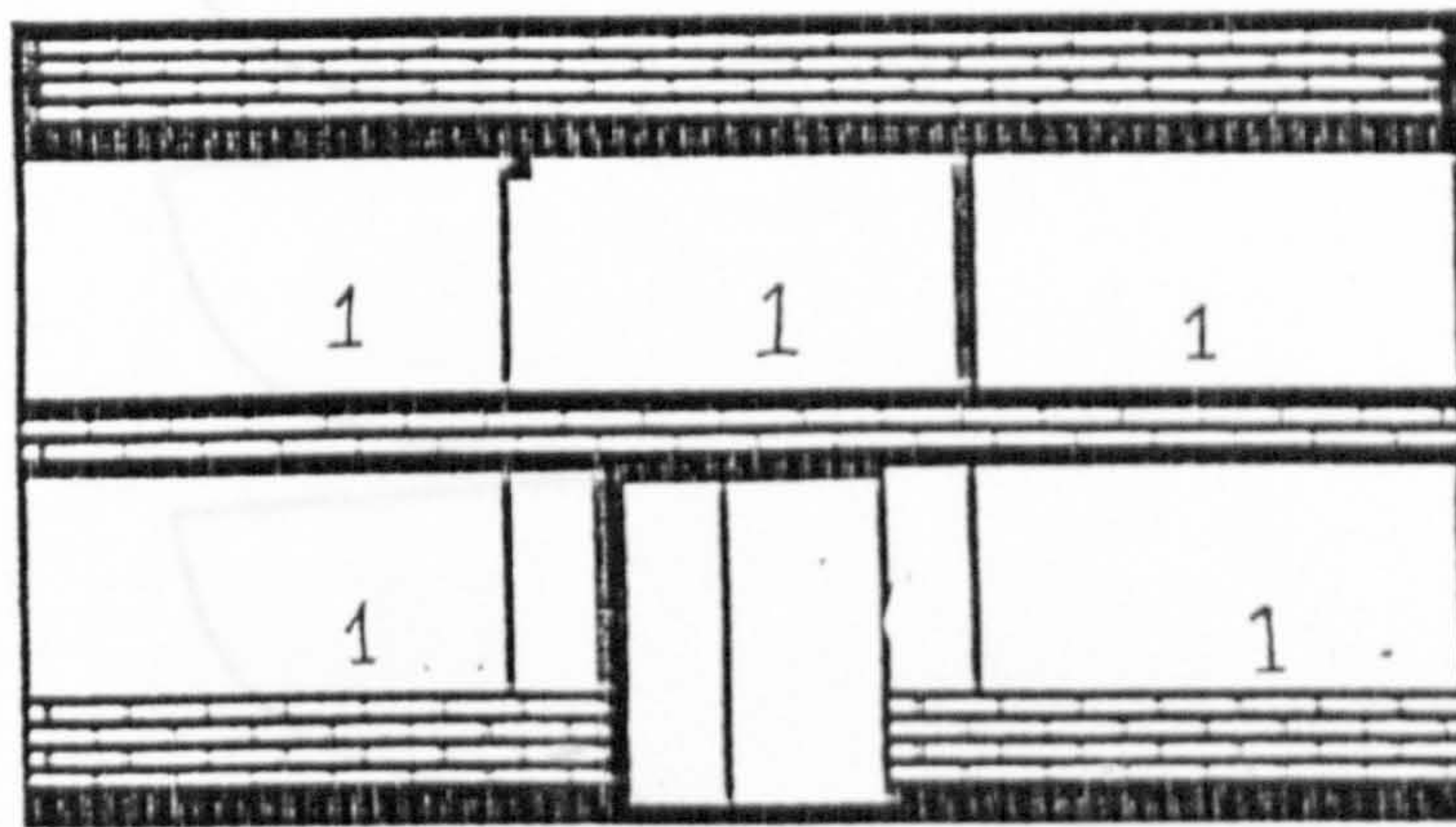

Key diagram showing the location of window data and the position of the corresponding curve

Front Wall

1 Or 2 Storey

LOG10

5. EFFICIENCY W. THICKNESS 1.2M W. ORIENTATION 30  
 NO= 22M NO1= 3M NO2= 3M HOUSE 1.2.0 ST.



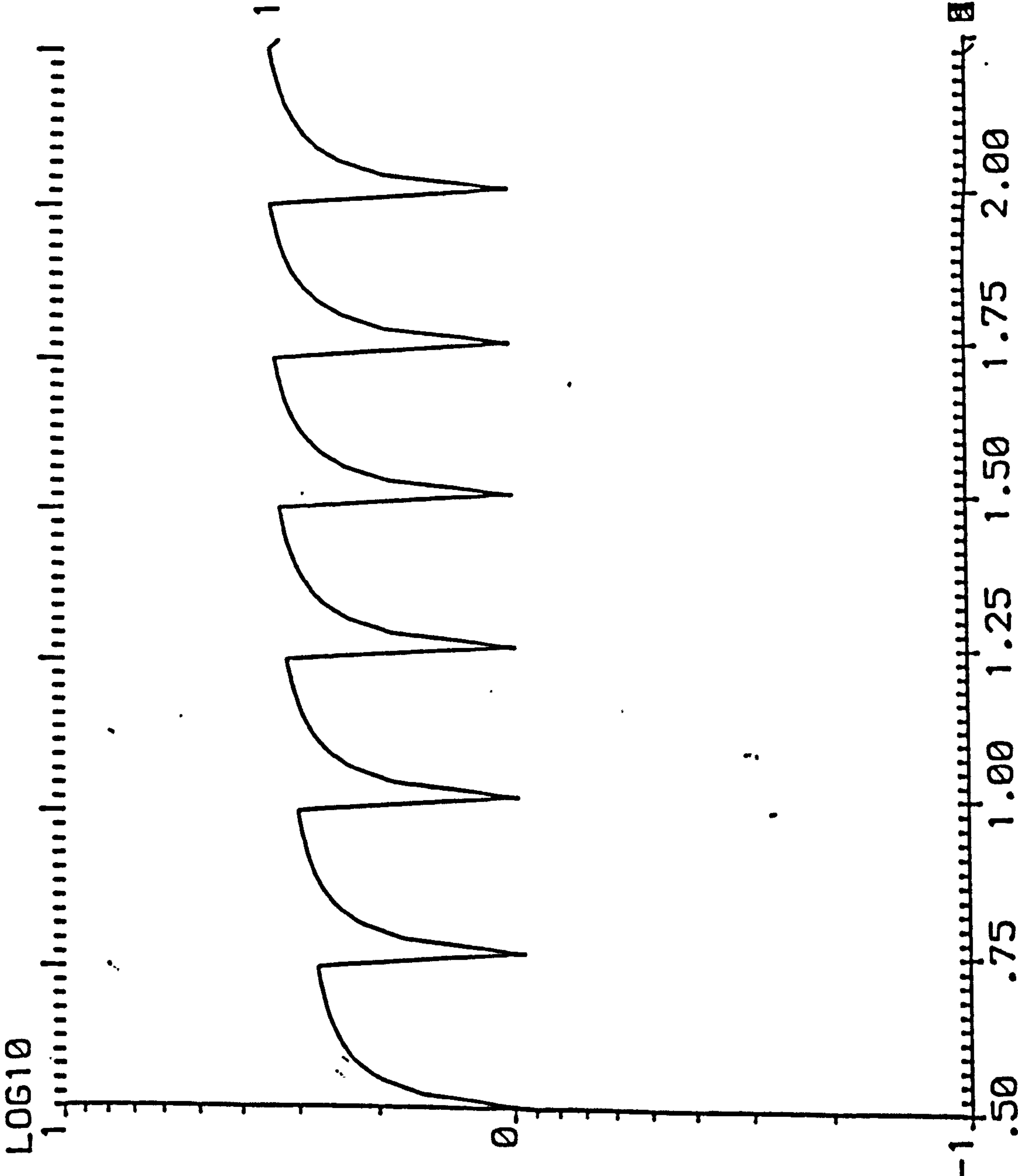

S. EFFICIENCY W. THICKNESS= .12M W. ORIENTATION= .00

WD= 22M HD1= 3M HD2= 3M HOUSE T.=2.0 ST.

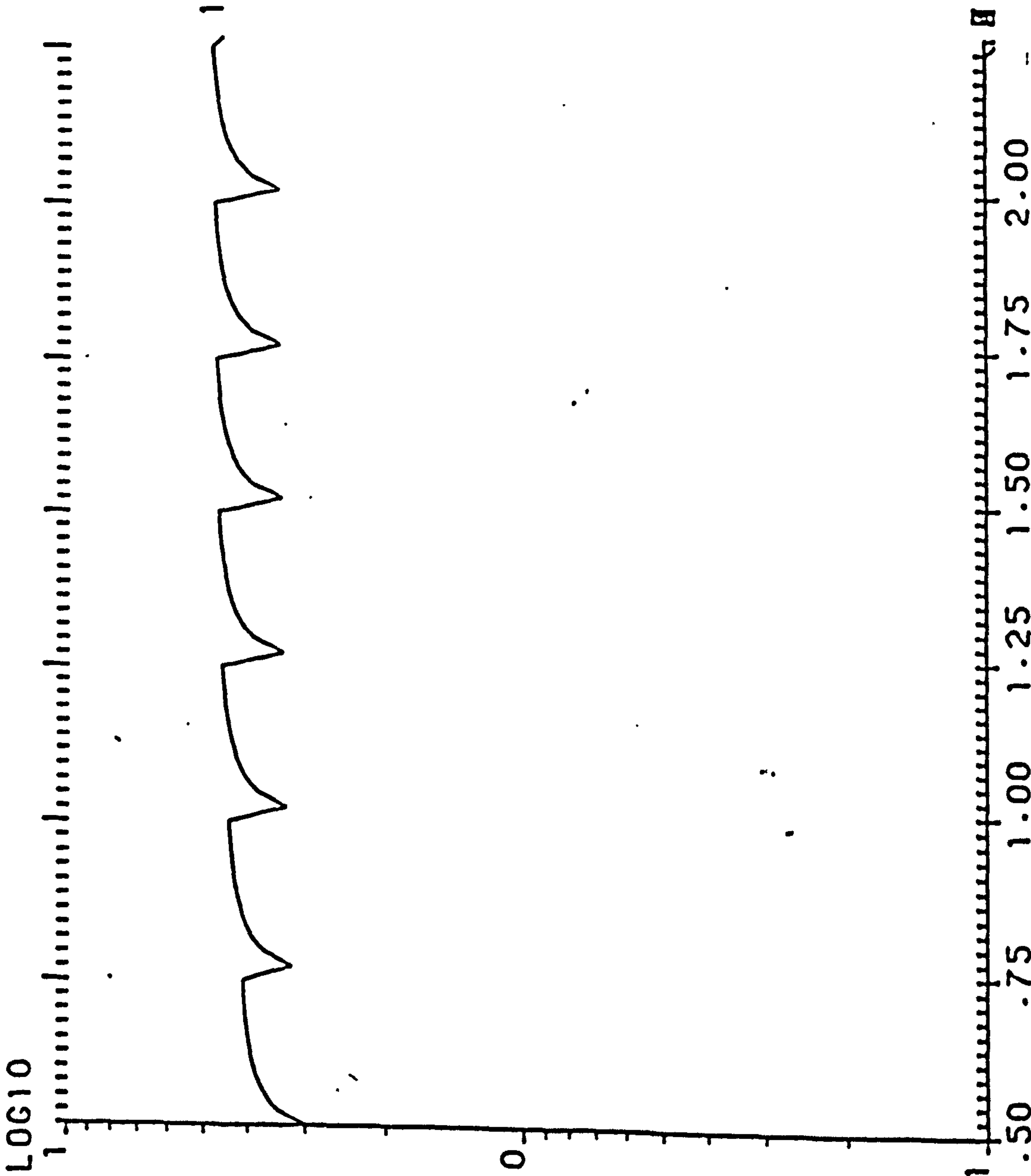

S. EFFICIENCY W. THICKNESS= .12M HD2= 3M HOUSE T.=2.0 ST.

WD= 22M HD1= 3M

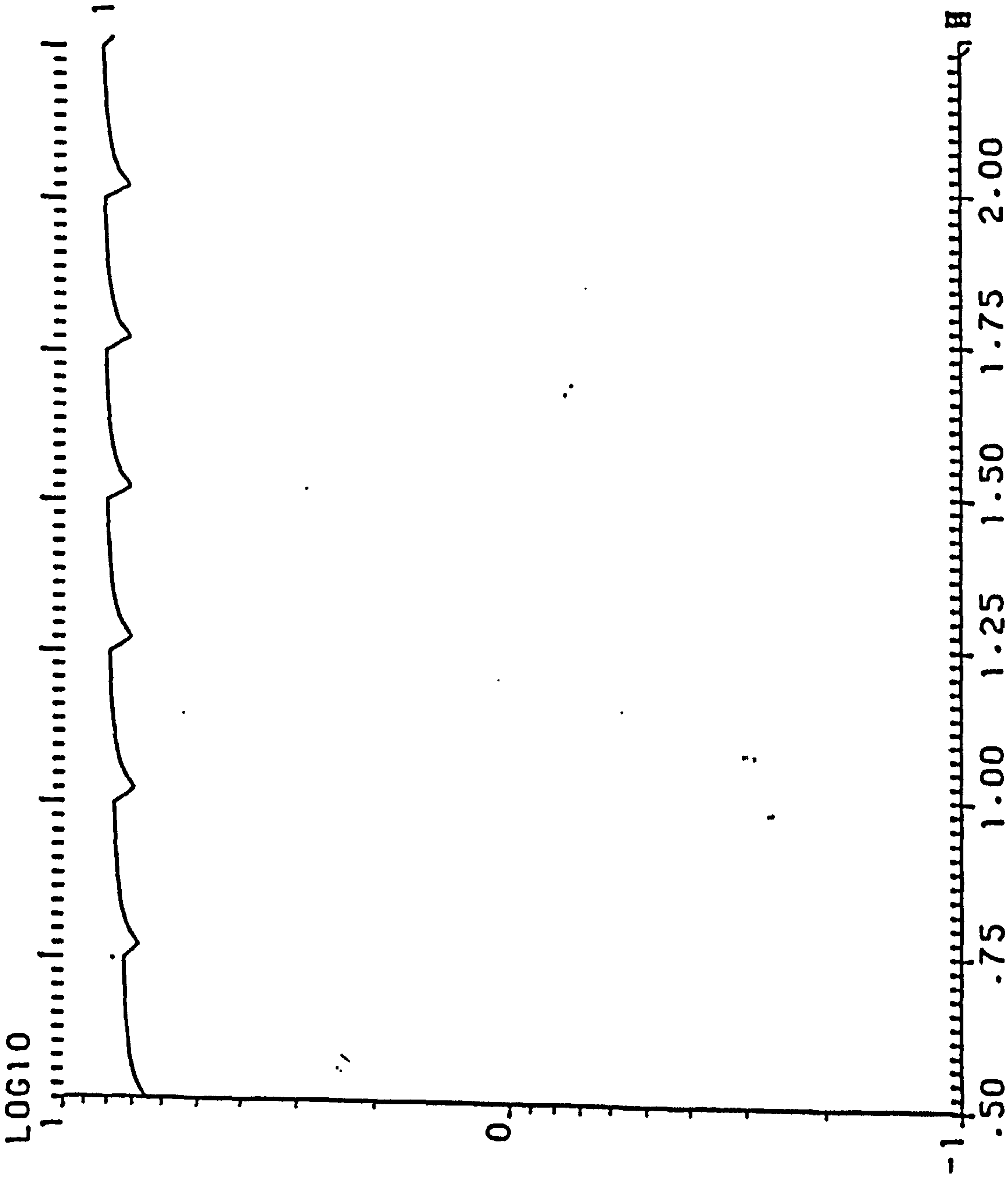

S. EFFICIENCY W. THICKNESS= .12M HD2= 3M HOUSE T.=2.0 ST.  
 W. ORIENTATION= 45.00

WD= 22M HD1= 3M



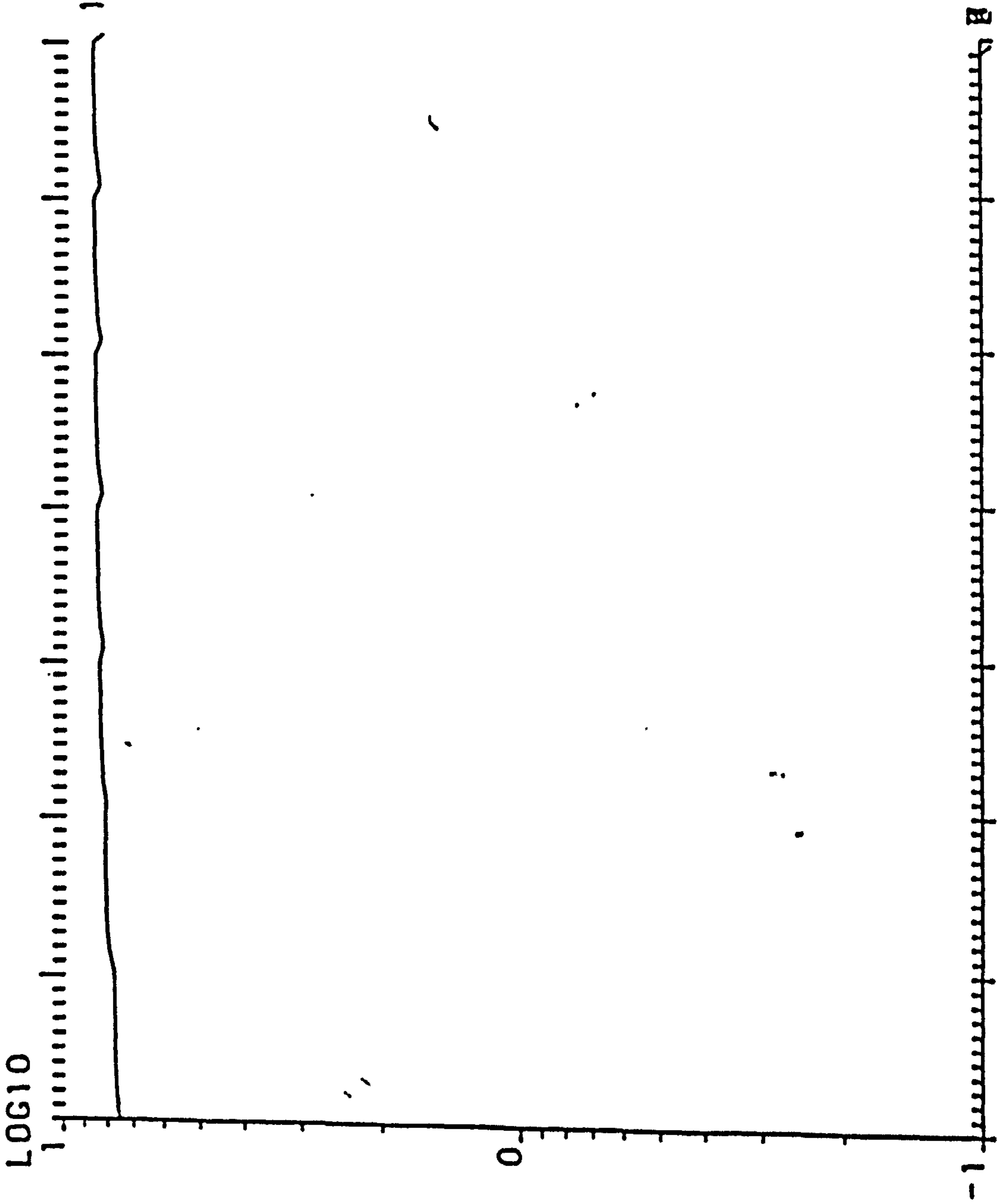

S. EFFICIENCY W. THICKNESS= .12M HD2= 3M HOUSE T.=2.0 ST.  
 WD= 22M HD1= 3M

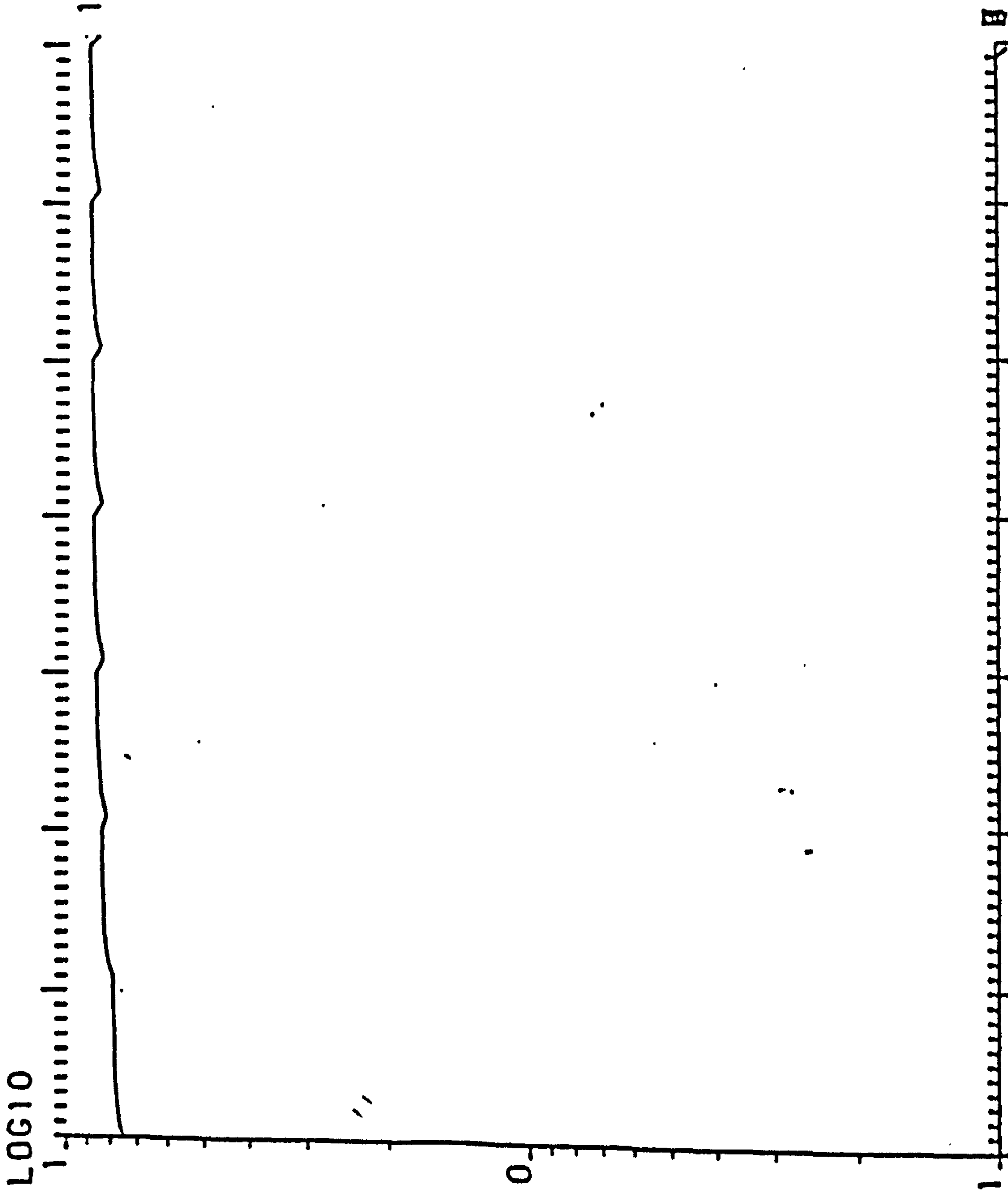

S. EFFICIENCY    W. THICKNESS=    .12M    HD2=    3M    HOUSE T.=2.0 ST.  
 W. ORIENTATION= 90.00  
 WD= 22M    HD1=    3M



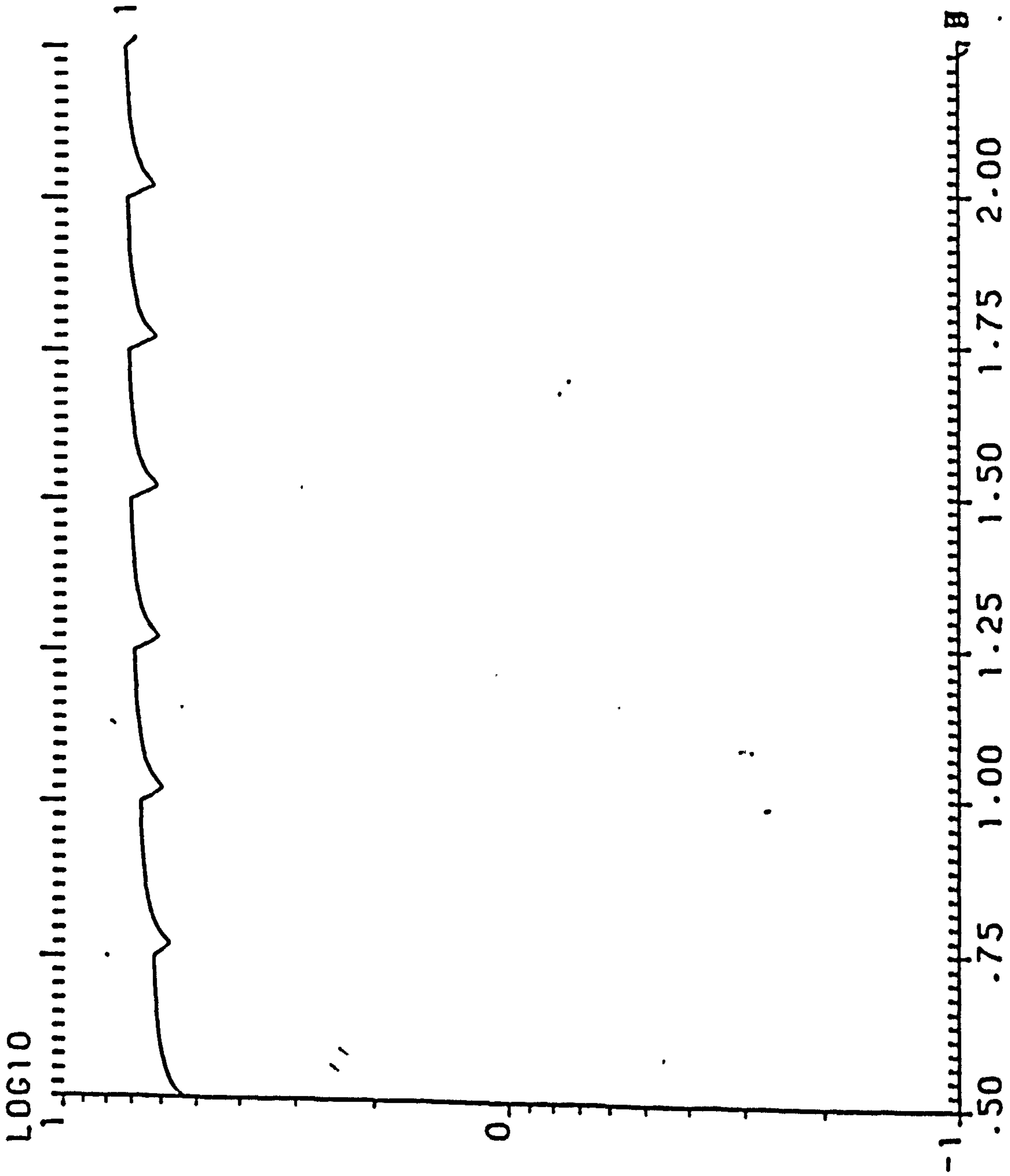

S. EFFICIENCY W. THICKNESS= .12M HD2= 3M HOUSE T.=2.0 ST.  
 WD= 22M HD1= 3M



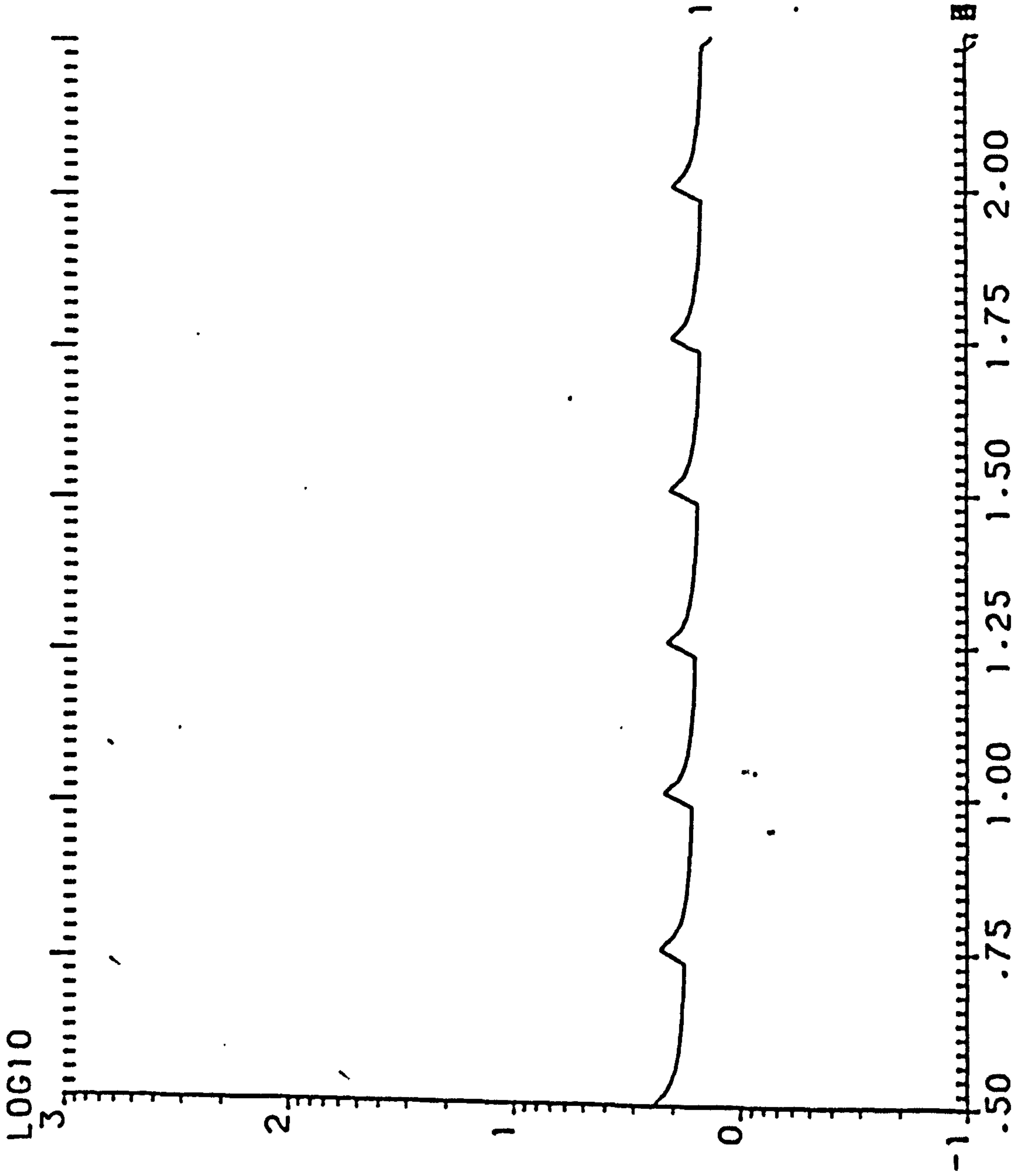

Y. EFFICIENCY W. THICKNESS= .12M W. ORIENTATION=135.00

WD= 22M HD1= 3M HD2= 3M HOUSE T.=2.0 ST.

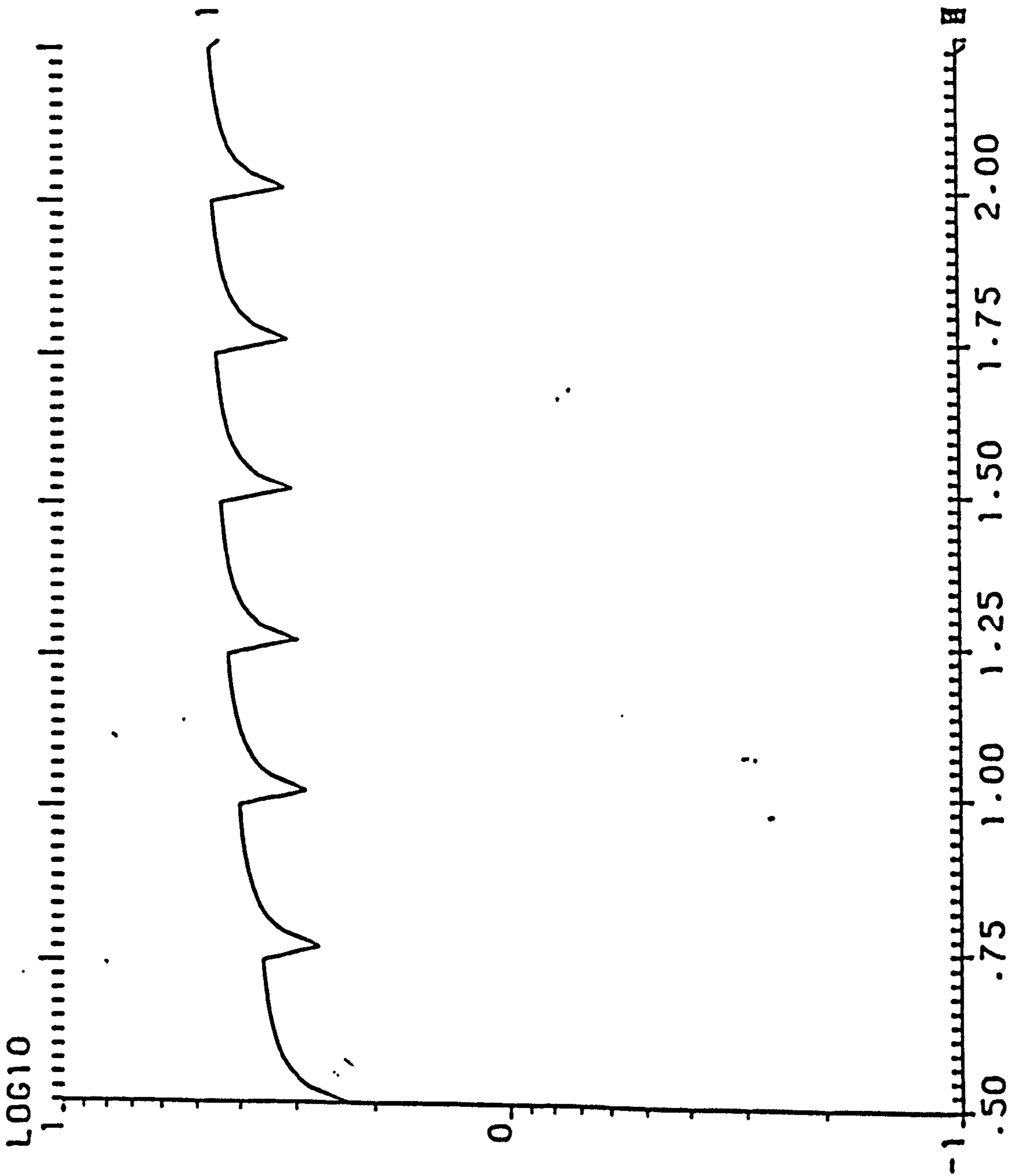

S. EFFICIENCY W. THICKNESS= .12M W. ORIENTATION=135.00

WD= 22M HD1= 3M HD2= 3M HOUSE T.=2.0 ST.

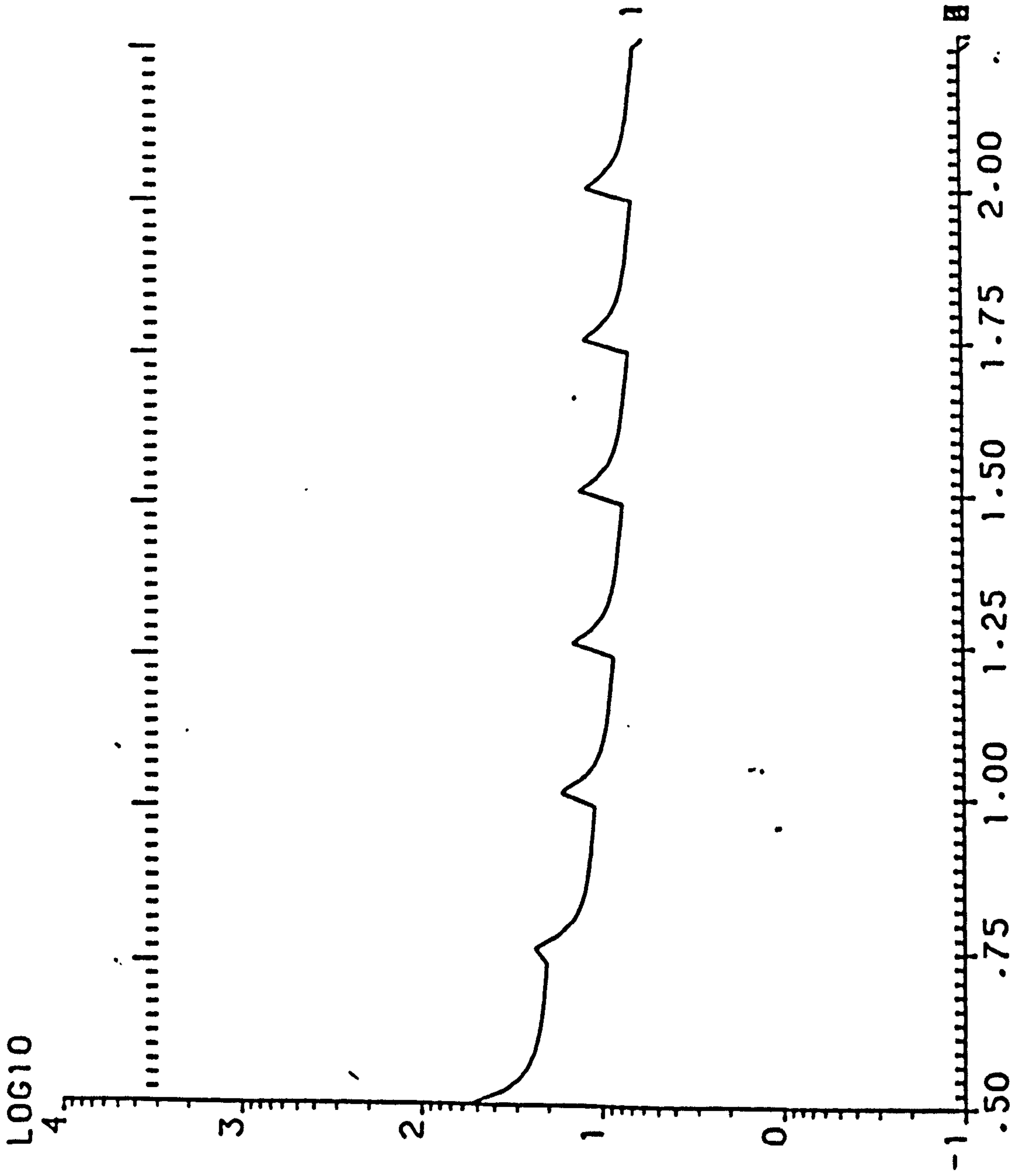

Y. EFFICIENCY W. THICKNESS= .12M W. ORIENTATION=157.50

WD= 22M HD1= 3M HD2= 3M HOUSE T.=2.0 ST.

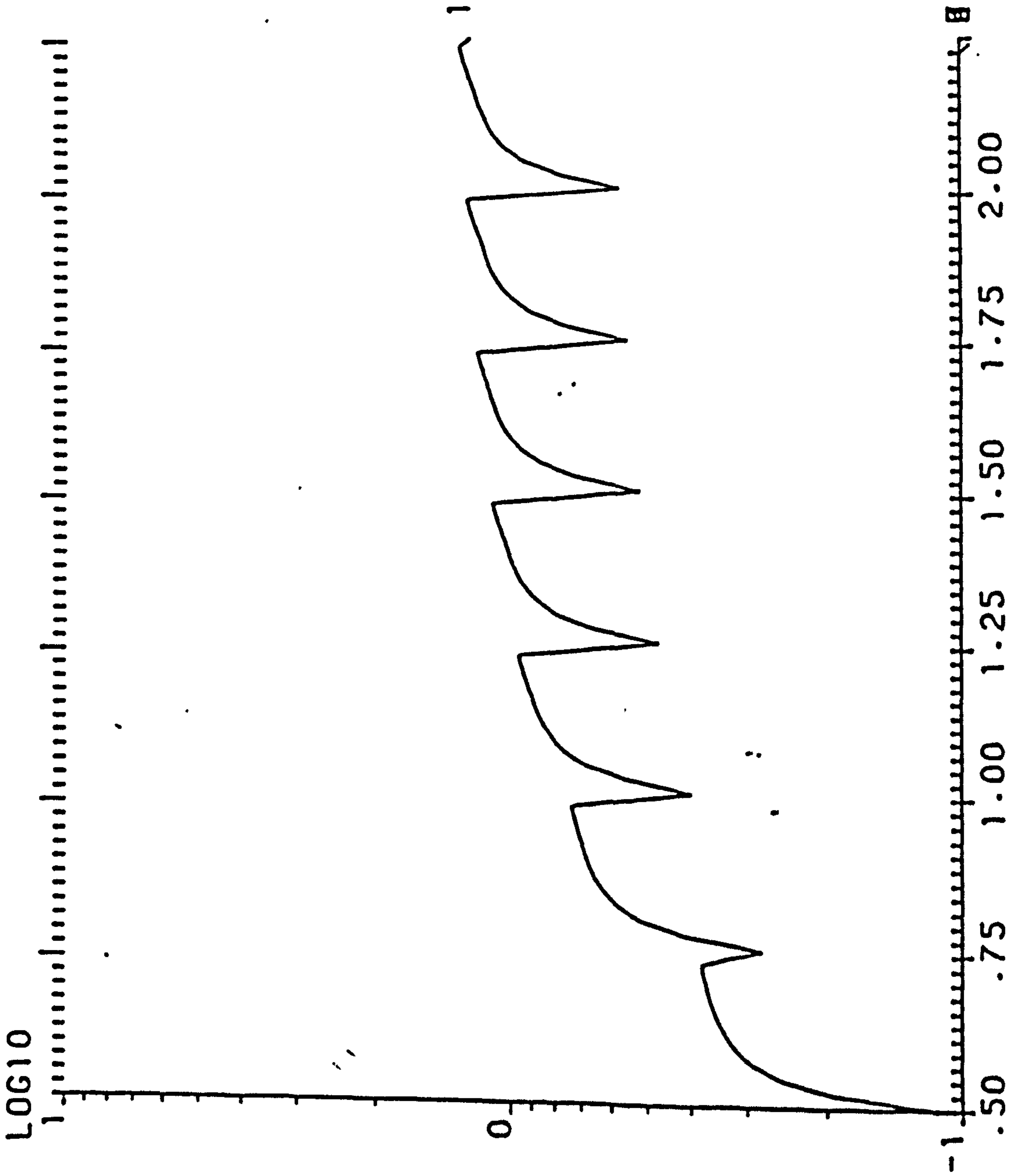

S. EFFICIENCY W. THICKNESS= .12M W. ORIENTATION=157.50

WD= 22M HD1= 3M HD2= 3M HOUSE T.=2.0 ST.





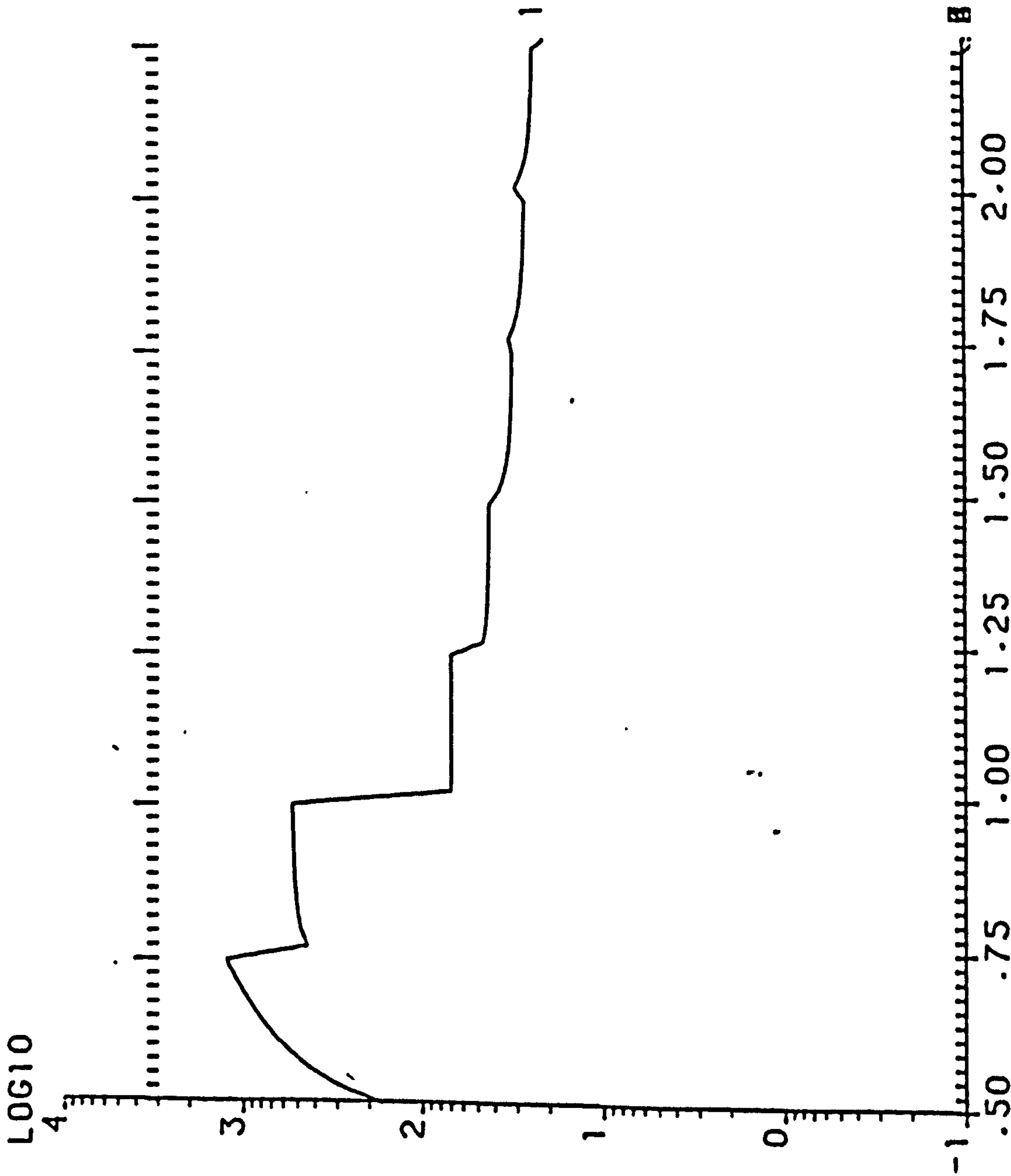

Y. EFFICIENCY W. THICKNESS= .12M W. ORIENTATION=180.00  
WD= 22M HD1= 3M HD2= 3M HOUSE T.=2.0 ST.

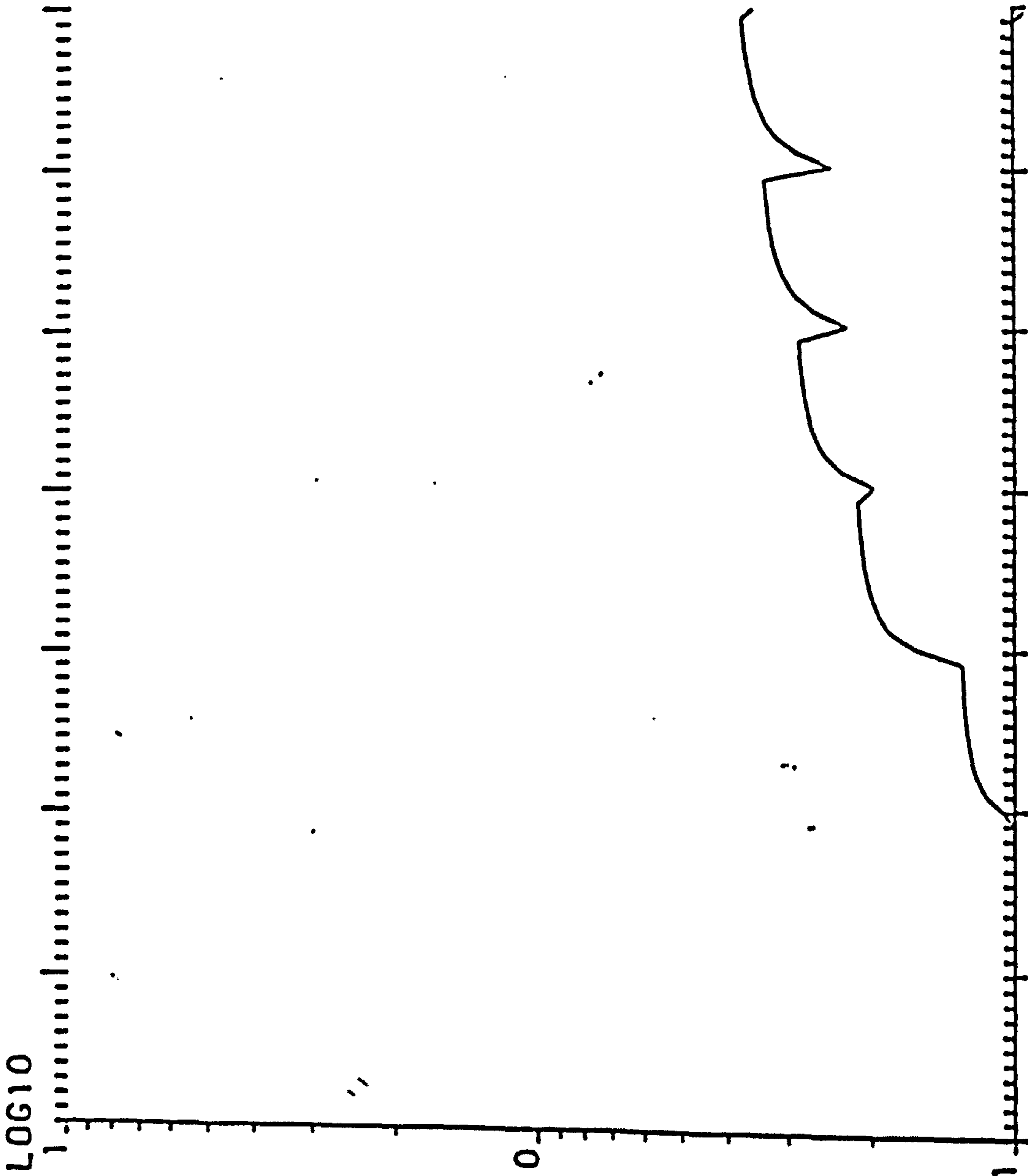

S. EFFICIENCY W. THICKNESS= .12M W. ORIENTATION=180.00

WD= 22M HD1= 3M HD2= 3M HOUSE T.=2.0 ST.



LOG10

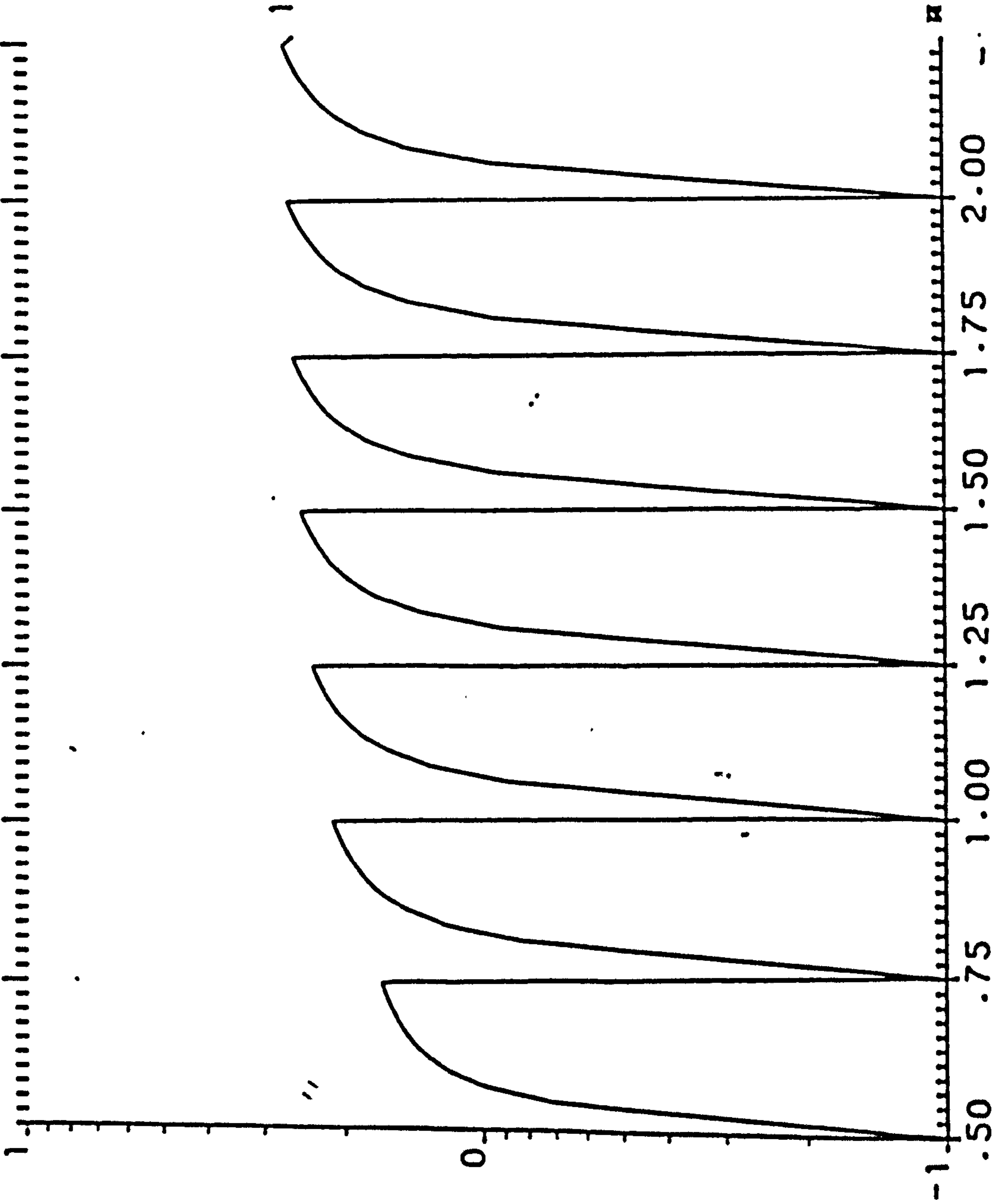

S. EFFICIENCY W. THICKNESS= .24M W. ORIENTATION= .00

WD= 22M HD1= 3M HD2= 3M HOUSE T.=2.0 ST.



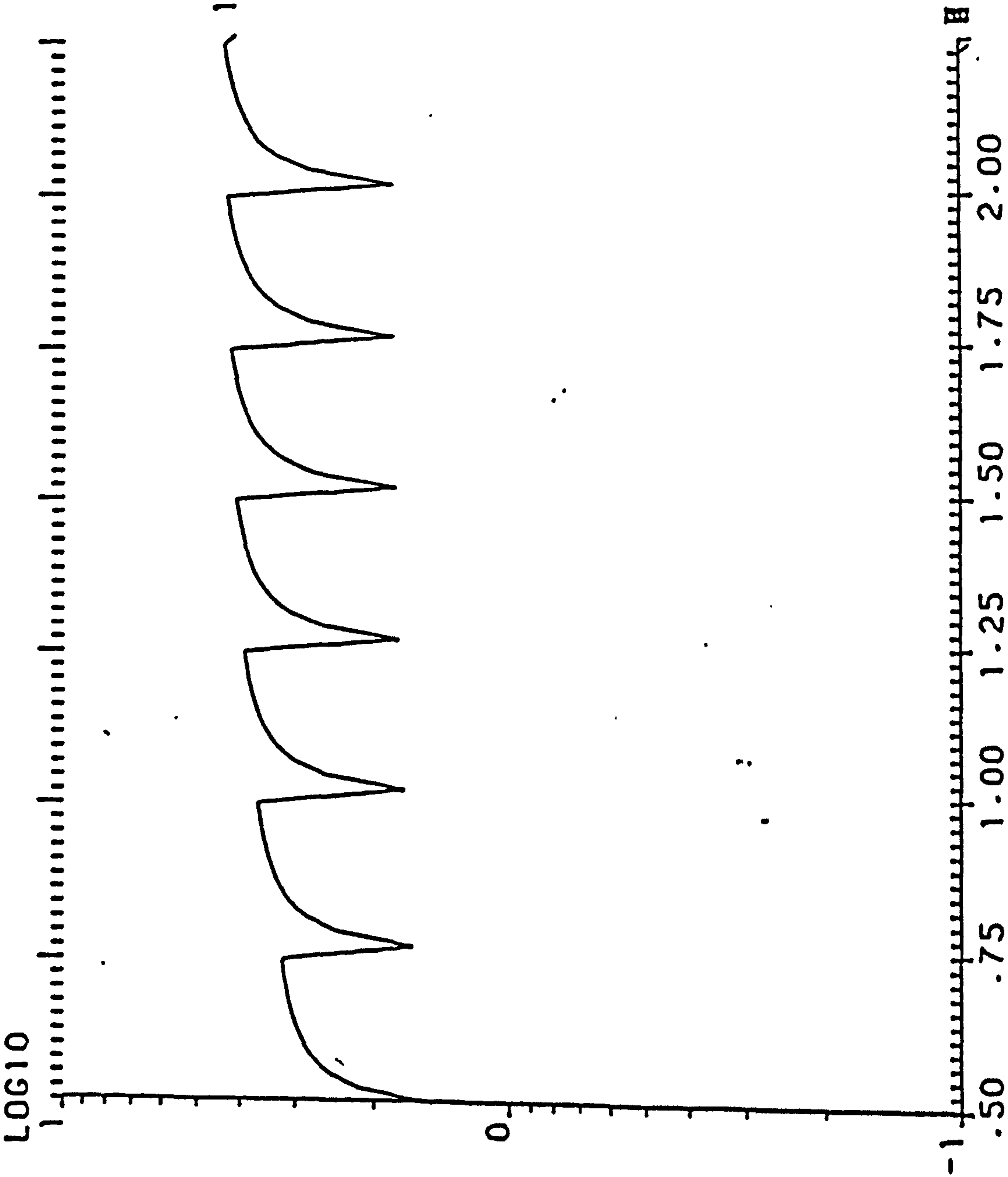

S. EFFICIENCY    W. THICKNESS= .24M    HD2= 3M    HD1= 3M    HOUSE T.=2.0 ST.  
 W. ORIENTATION= 22.50

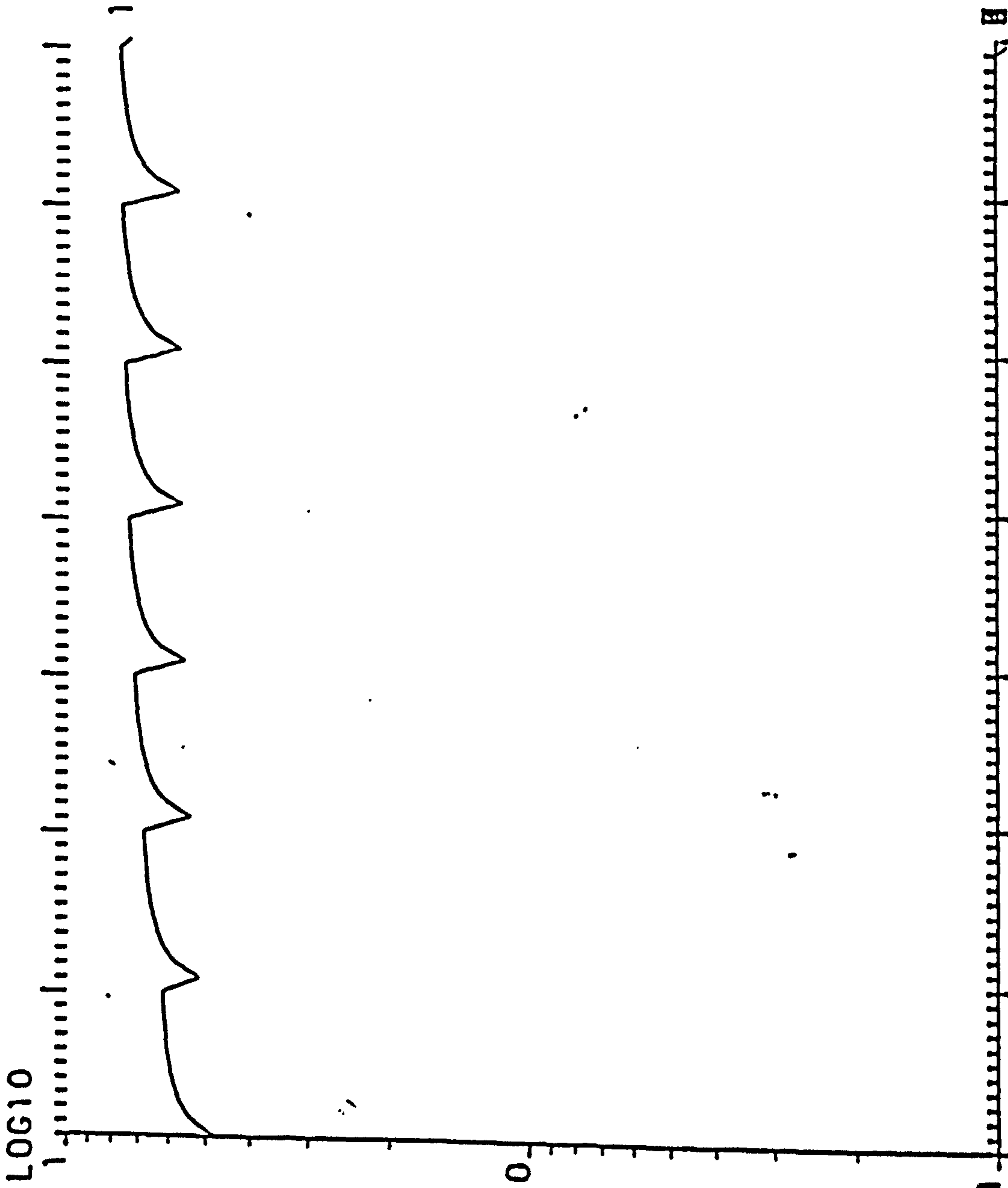

S. EFFICIENCY    W. THICKNESS= .24M    HD2= 3M    HOUSE T.=2.0 ST.  
 W. ORIENTATION= 45.00  
 WD= 22M    HD1= 3M



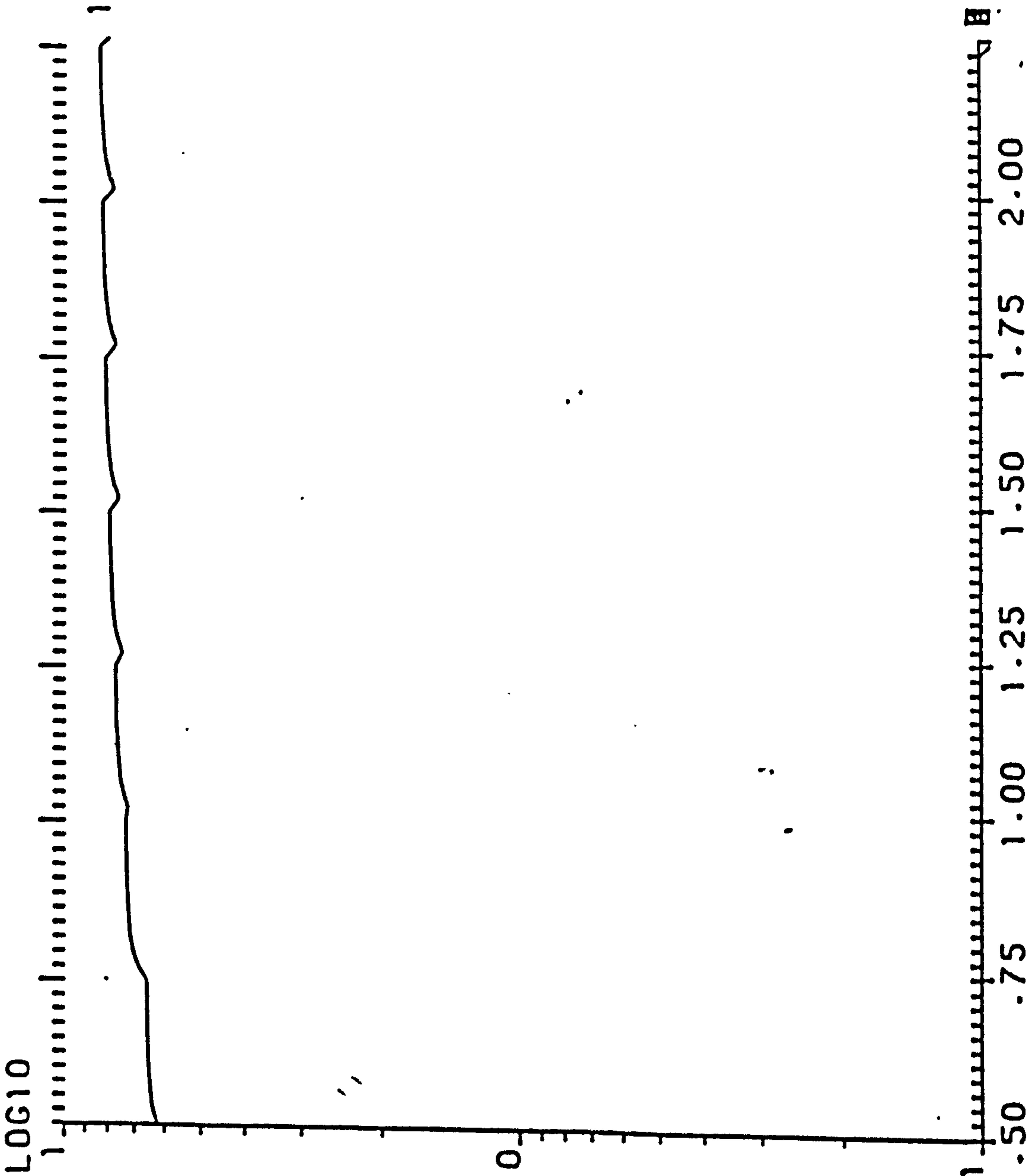

S. EFFICIENCY W. THICKNESS= .24M W. ORIENTATION= 67.50

WD= 22M HD1= 3M HD2= 3M HOUSE T.=2.0 ST.



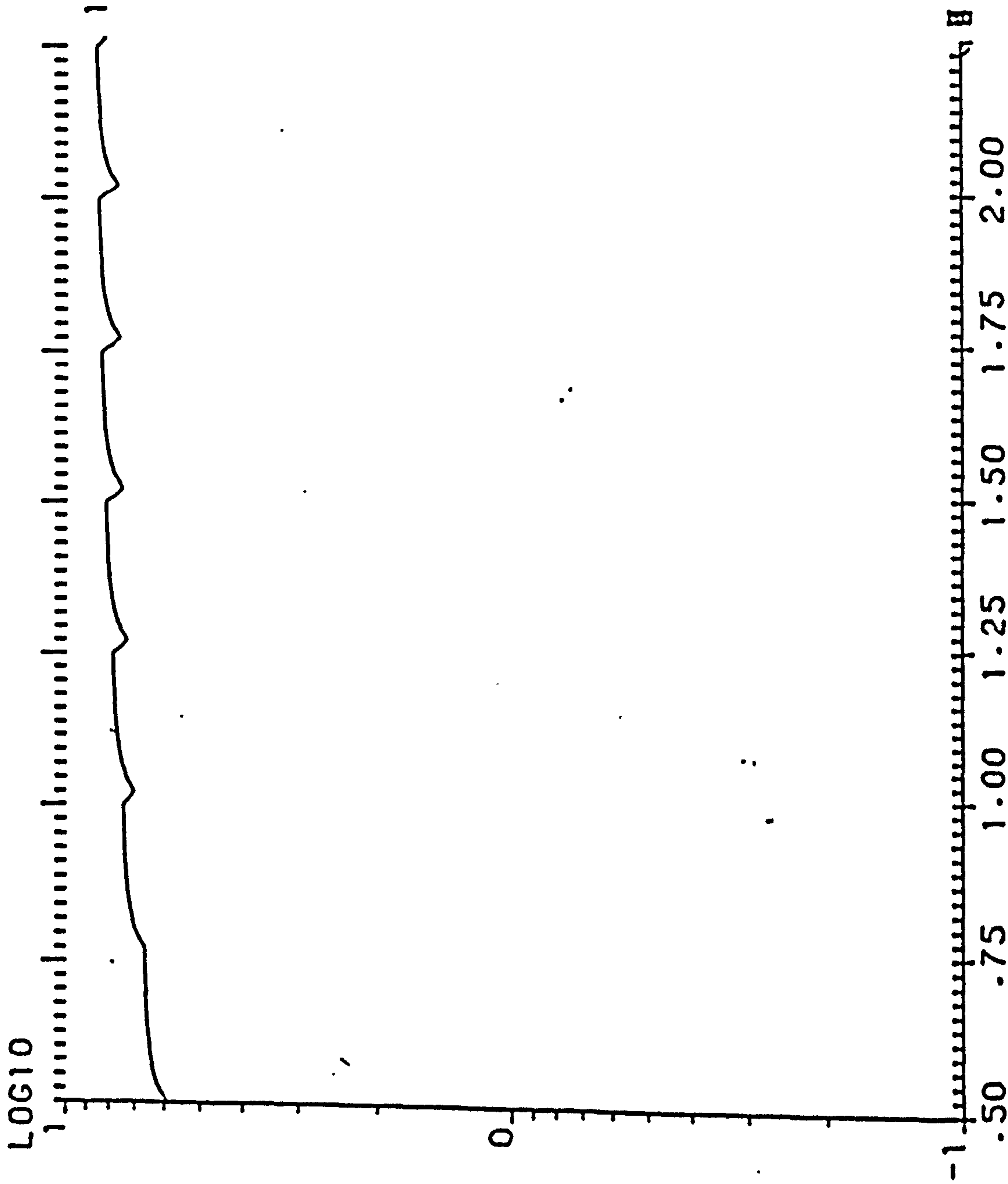

S. EFFICIENCY W. THICKNESS= .24M HD2= 3M HOUSE T.=2.0 ST.

WD= 22M HD1= 3M



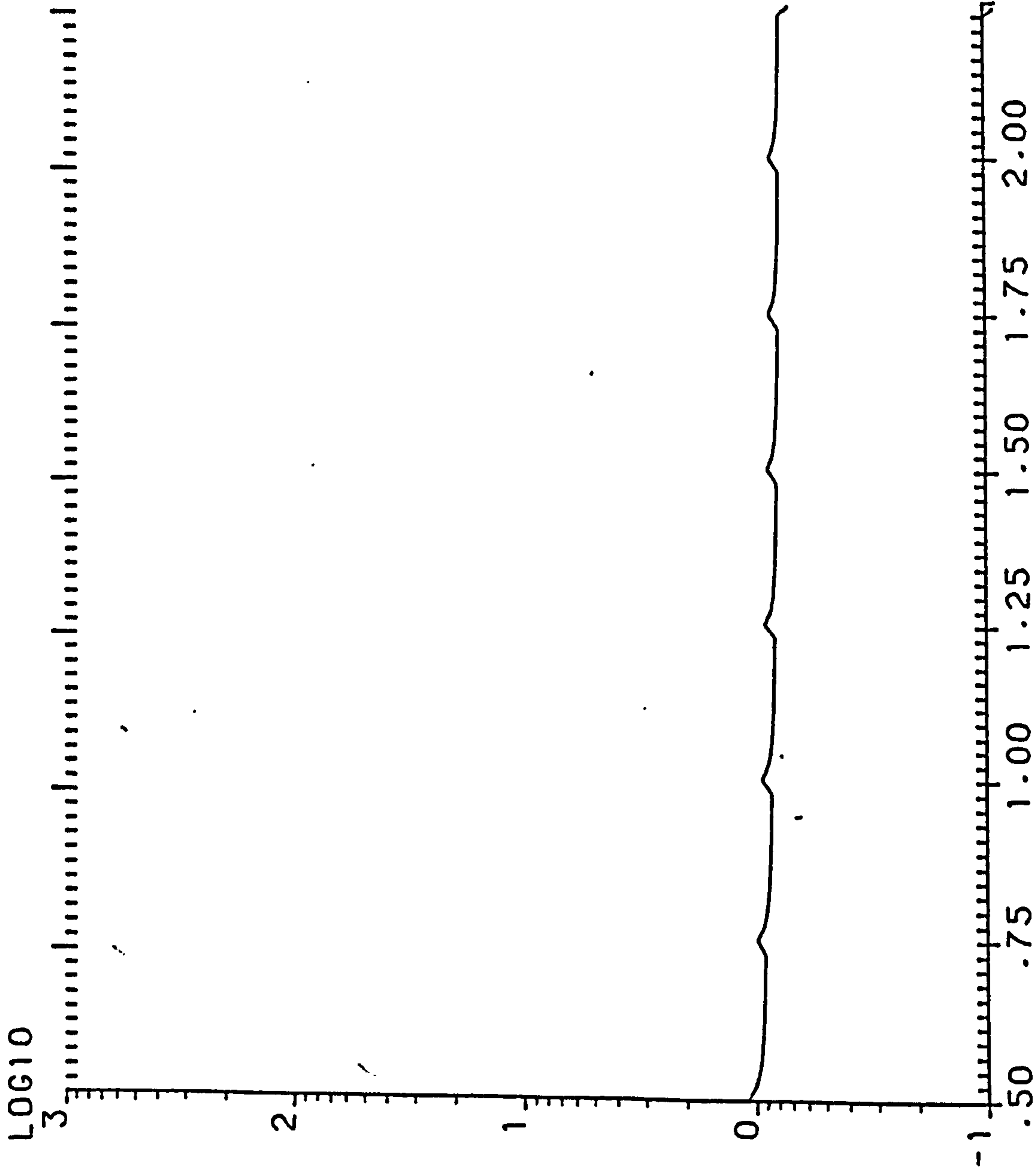

Y. EFFICIENCY W. THICKNESS= .24M W. ORIENTATION=112.50

WD= 22M HD1= 3M HD2= 3M HOUSE T.=2.0 ST.

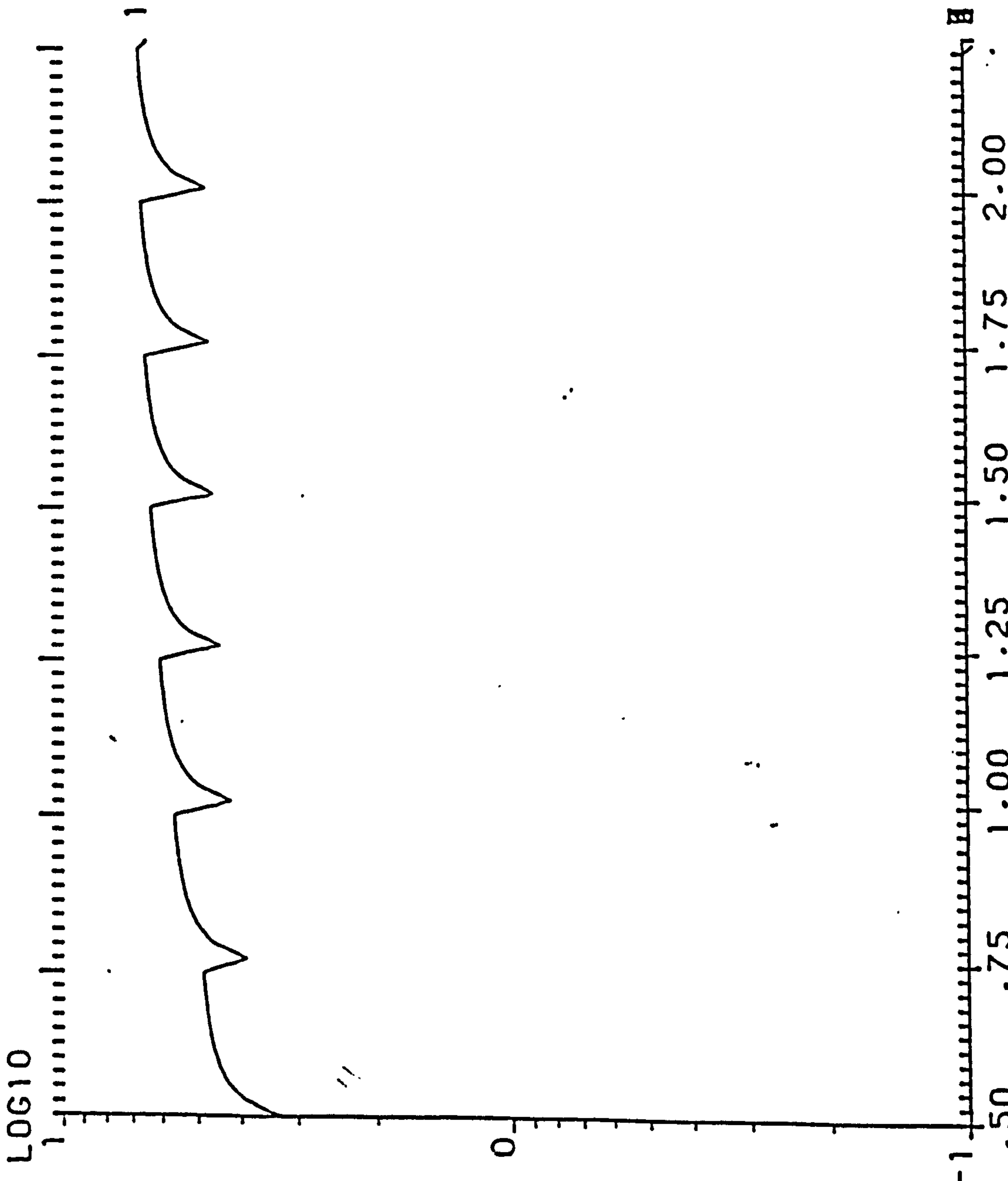

S. EFFICIENCY    W. THICKNESS=    .24M    W. ORIENTATION=112.50  
 WD= 22M    HD1= 3M    HD2= 3M    HOUSE T.=2.0 ST.



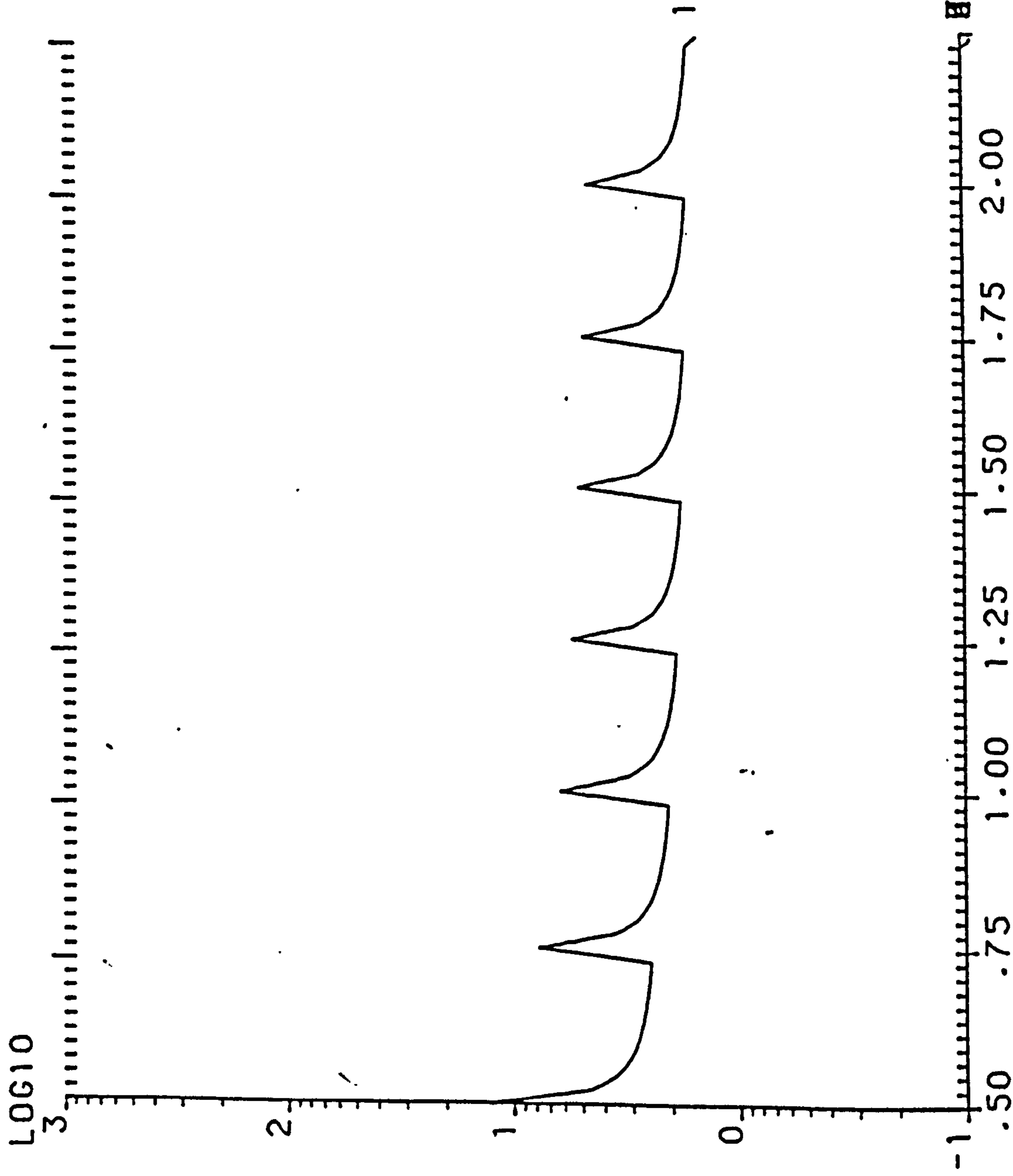

Y. EFFICIENCY W. THICKNESS= .24M W. ORIENTATION=135.00

WD= 22M HD1= 3M HD2= 3M HOUSE T.=2.0 ST.



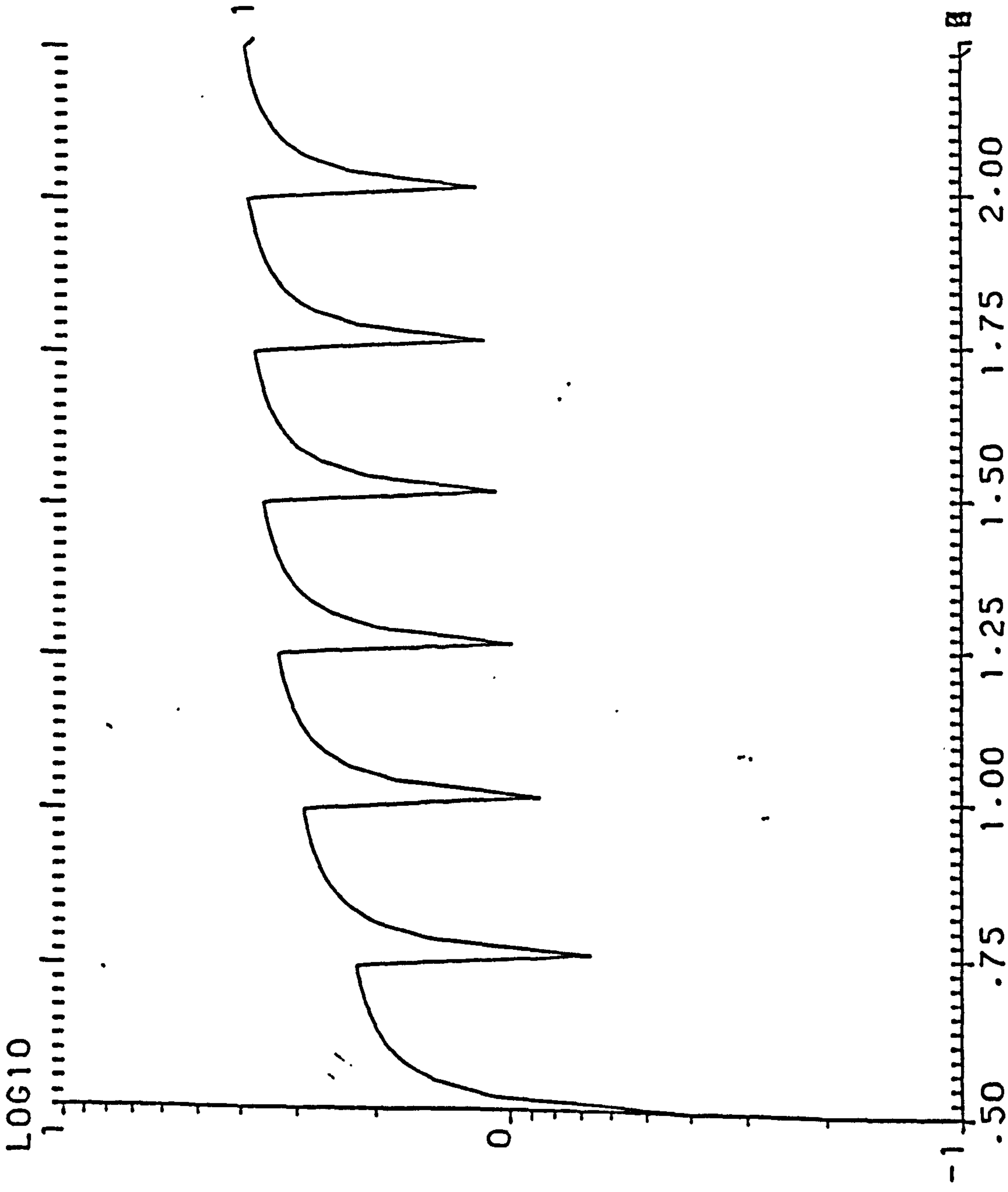

S. EFFICIENCY W. THICKNESS= .24M HD2= 3M HOUSE T.=2.0 ST.  
 WD= 22M HD1= 3M W. ORIENTATION=135.00



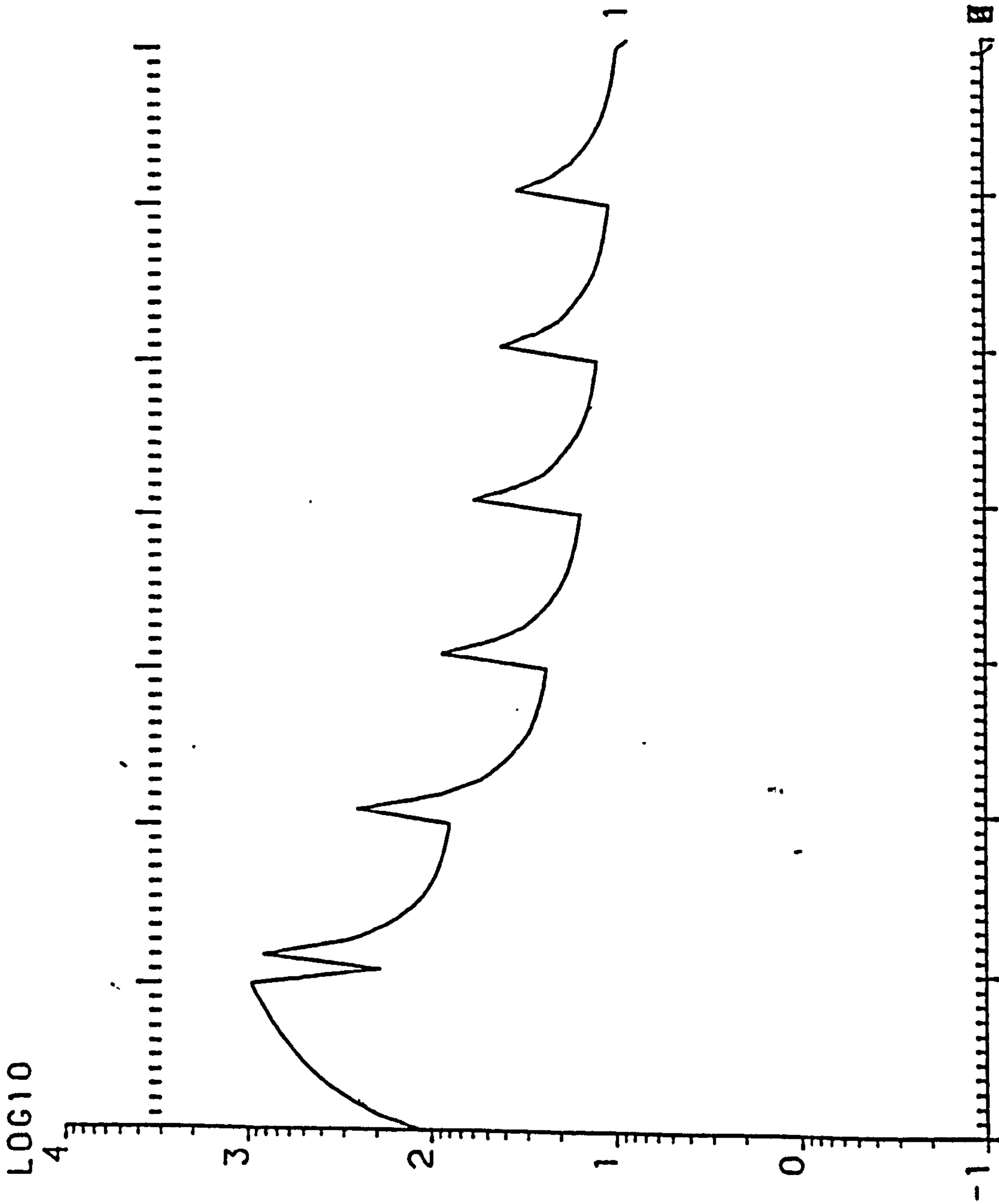

Y. EFFICIENCY W. THICKNESS= .24M W. ORIENTATION=157.50

WD= 22M HD1= 3M HD2= 3M HOUSE T.=2.0 ST.

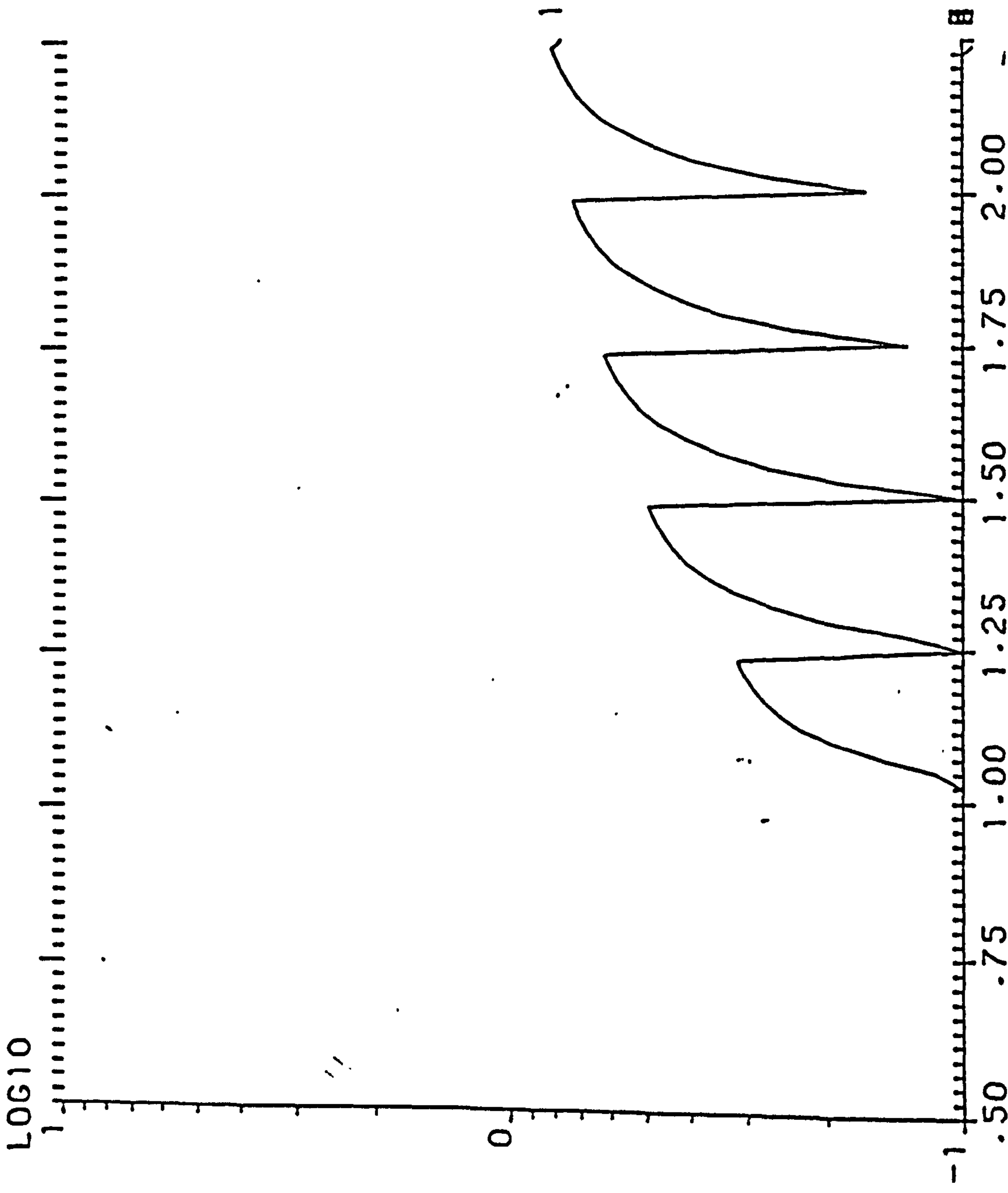

S. EFFICIENCY W. THICKNESS= .24M HD2= 3M HOUSE T.=2.0 ST.

WD= 22M HD1= 3M HD2= 3M HOUSE T.=2.0 ST.



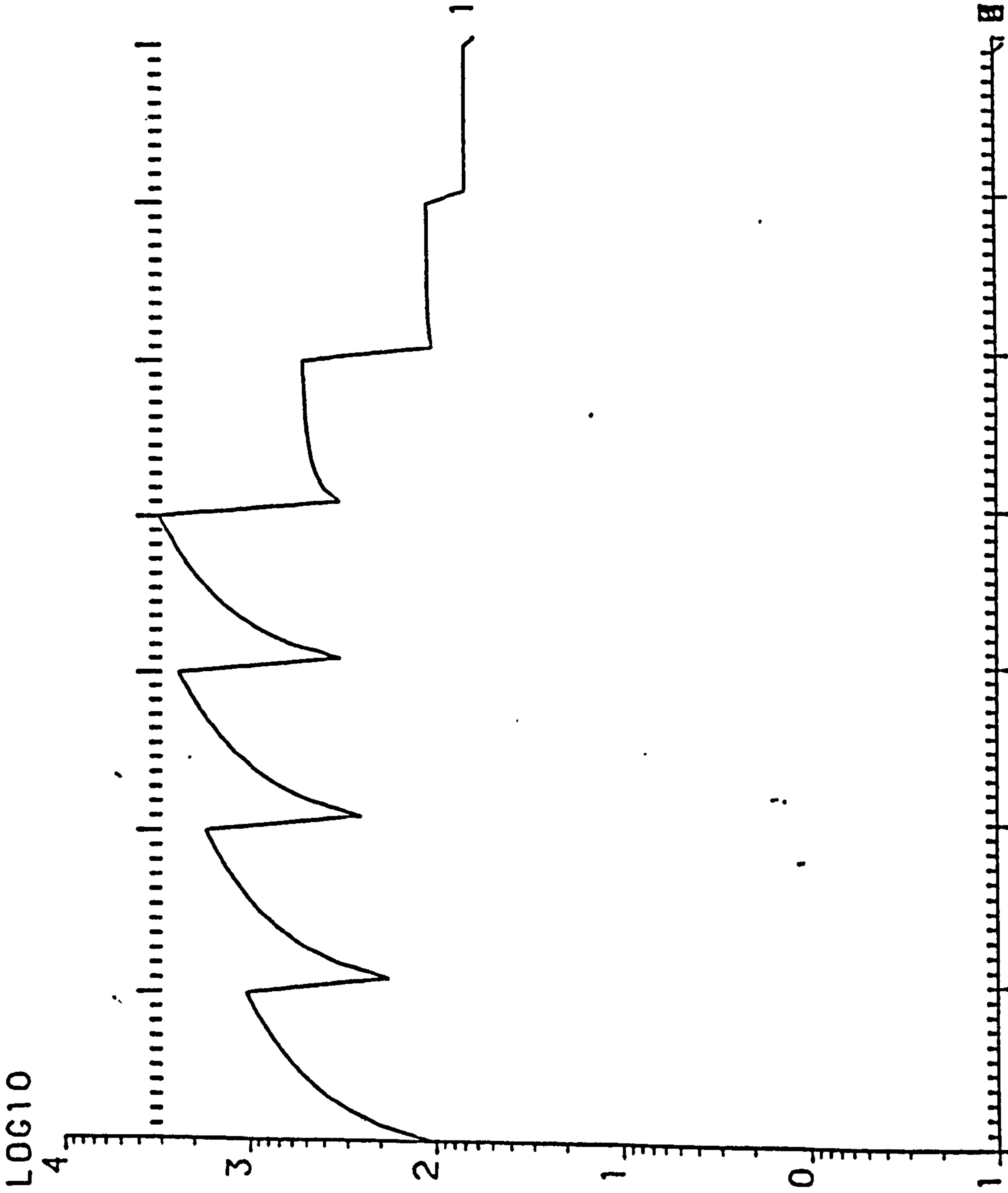

Y. EFFICIENCY W. THICKNESS= .24M W. ORIENTATION=180.00  
WD= 22M HD1= 3M HD2= 3M HOUSE T.=2.0 ST.

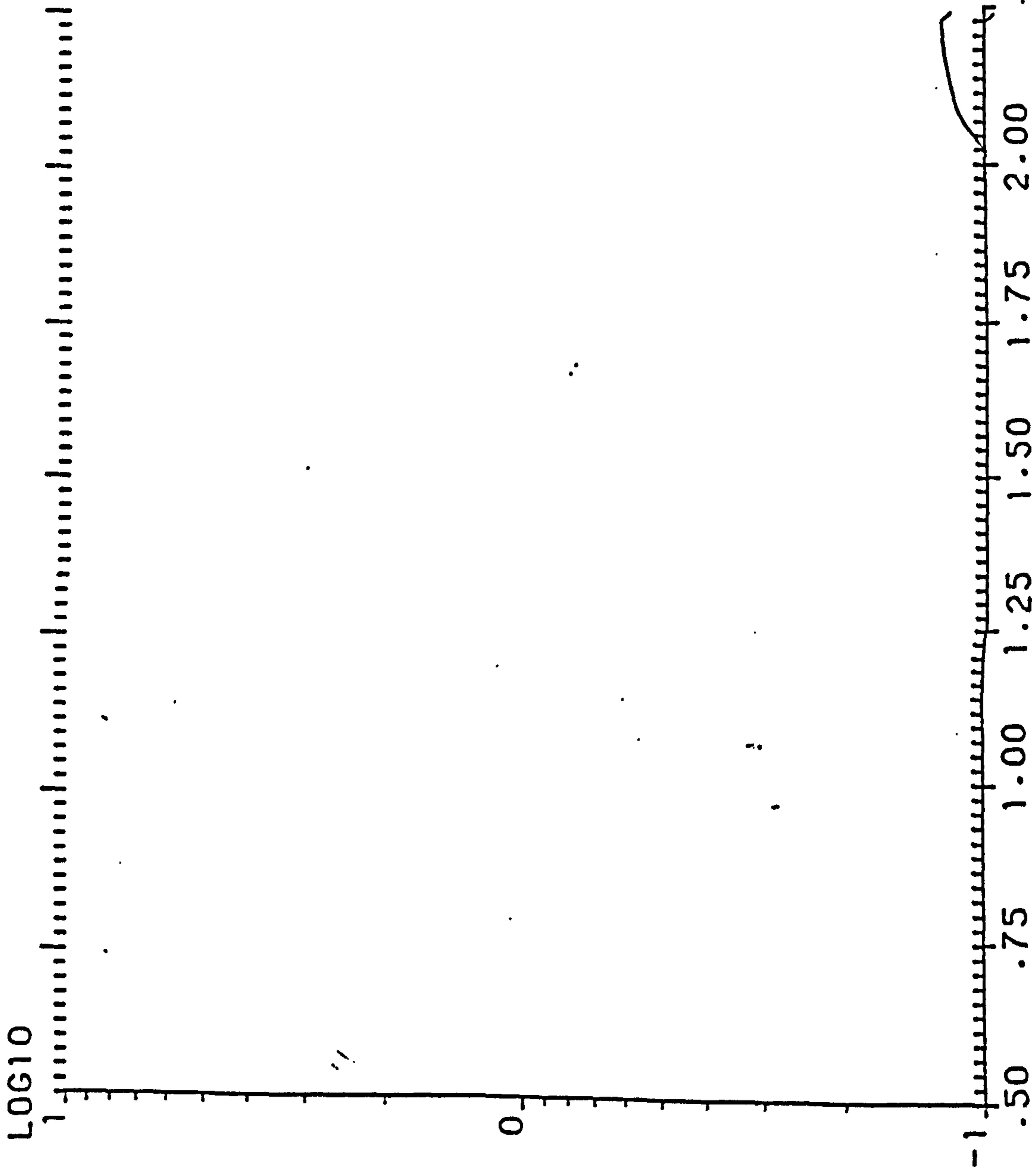

S. EFFICIENCY W. THICKNESS= .24M W. ORIENTATION=180.00

WD= 22M HD1= 3M HD2= 3M HOUSE T.=2.0 ST.





LOG10  
1  
0  
-1

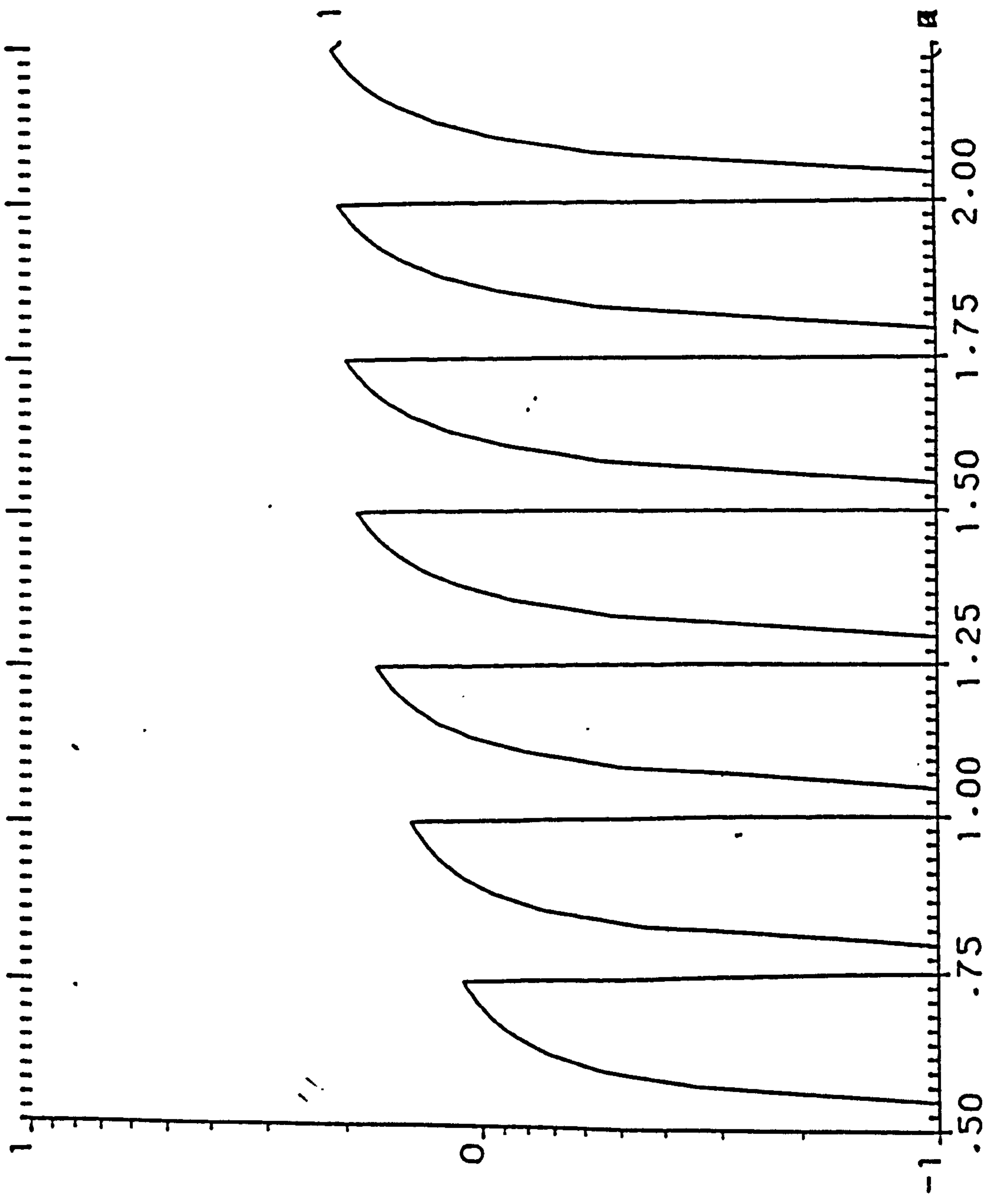

S. EFFICIENCY W. THICKNESS= .36M W. ORIENTATION= .00

WD= 22M HD1= 3M HD2= 3M HOUSE T.=2.0 ST.



LOG10  
1

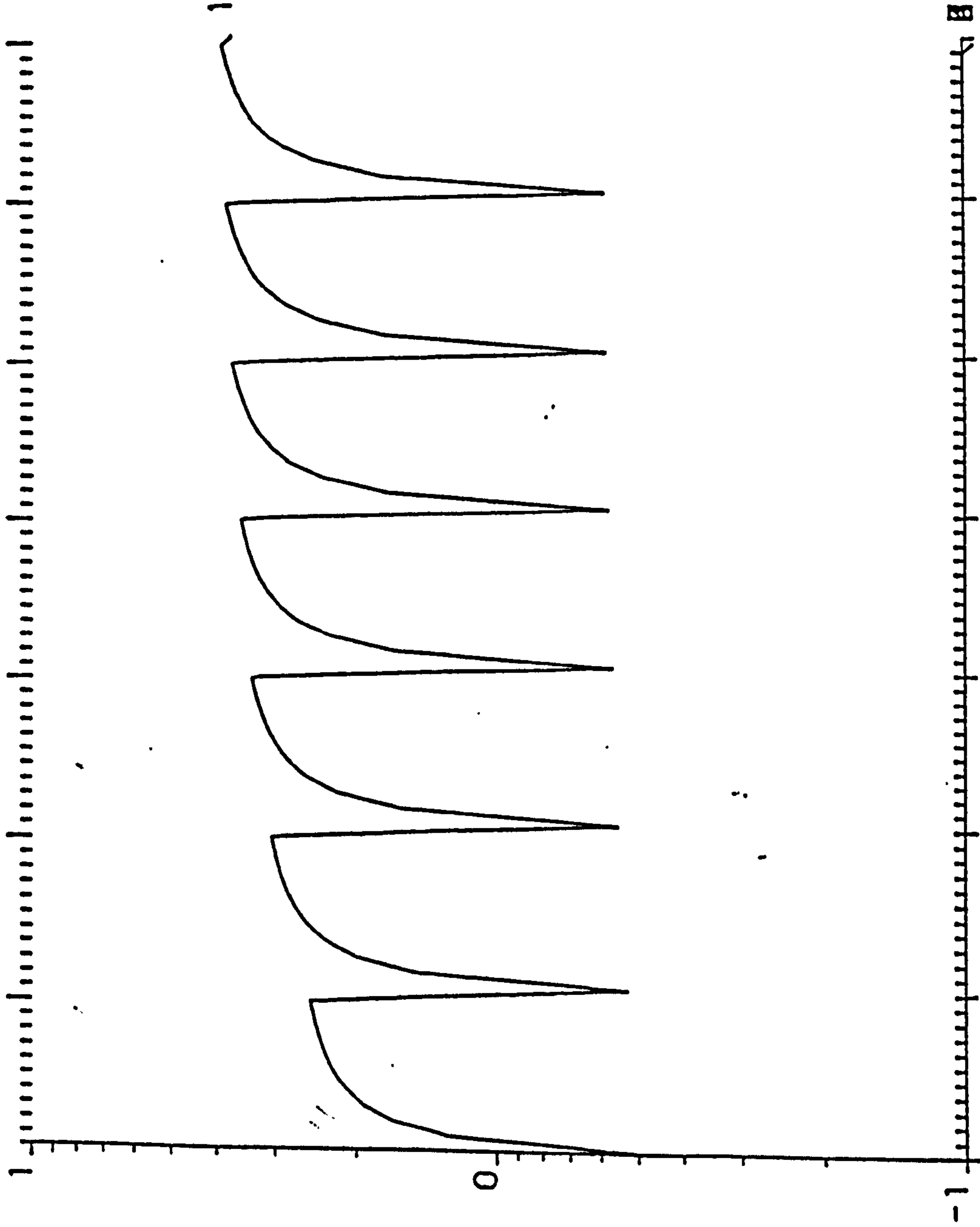

-1  
 .50 .75 1.00 1.25 1.50 1.75 2.00  
 S. EFFICIENCY W. THICKNESS= .36M W. ORIENTATION= 22.50  
 WD= 22M HD1= 3M HD2= 3M HOUSE T.=2.0 ST.

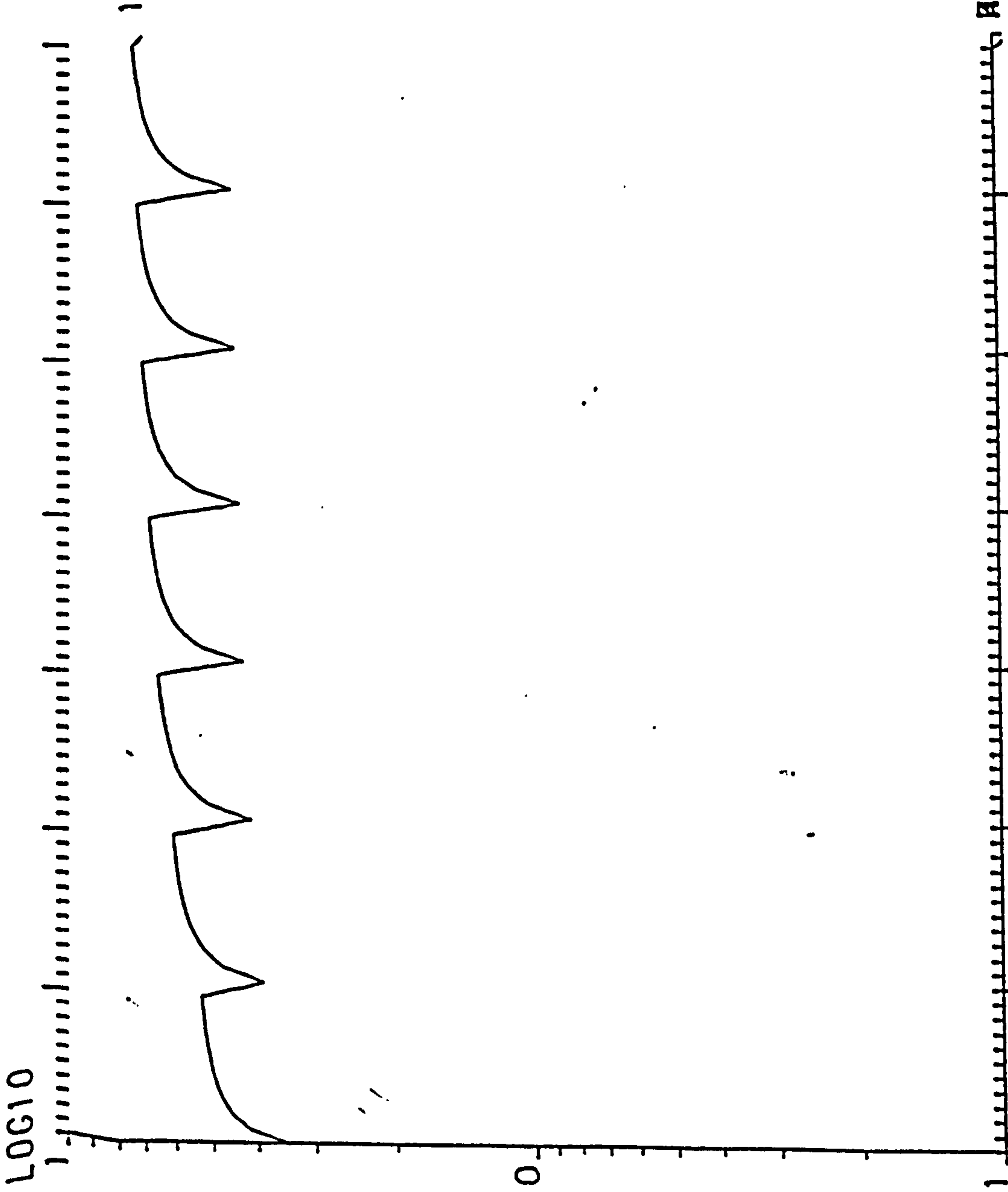

S. EFFICIENCY W. THICKNESS= .36M W. ORIENTATION= 45.00  
 HD1= 3M HD2= .3M HOUSE T.=2.0 ST.  
 WD= 22M

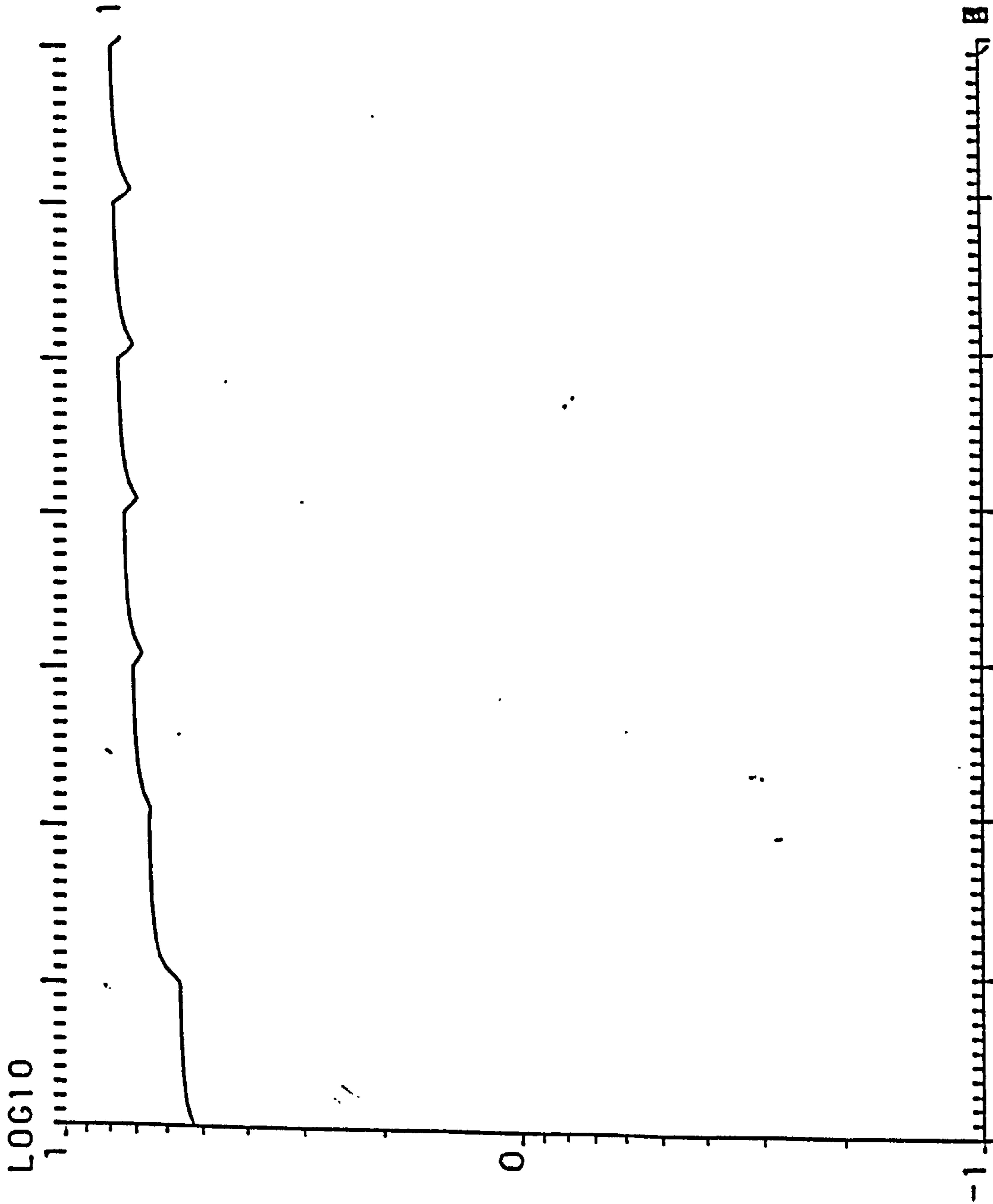

S. EFFICIENCY W. THICKNESS= .36M HD2= 3M HOUSE T.=2.0 ST.  
 W. ORIENTATION= 67.50

WD= 22M HD1= 3M

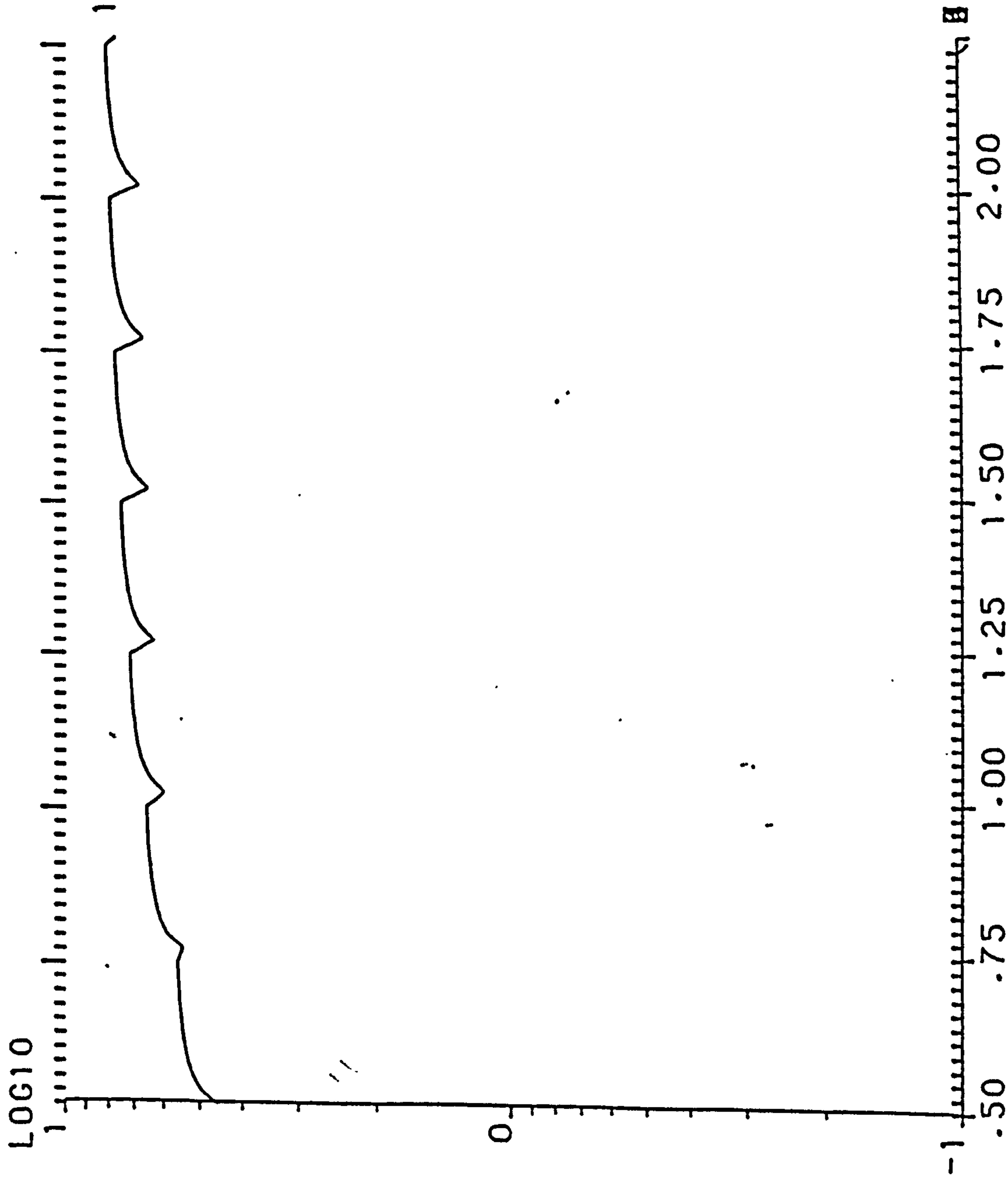

S. EFFICIENCY W. THICKNESS= .36M W. ORIENTATION= 90.00

WD= 22M HD1= 3M HD2= 3M HOUSE T.=2.0 ST.



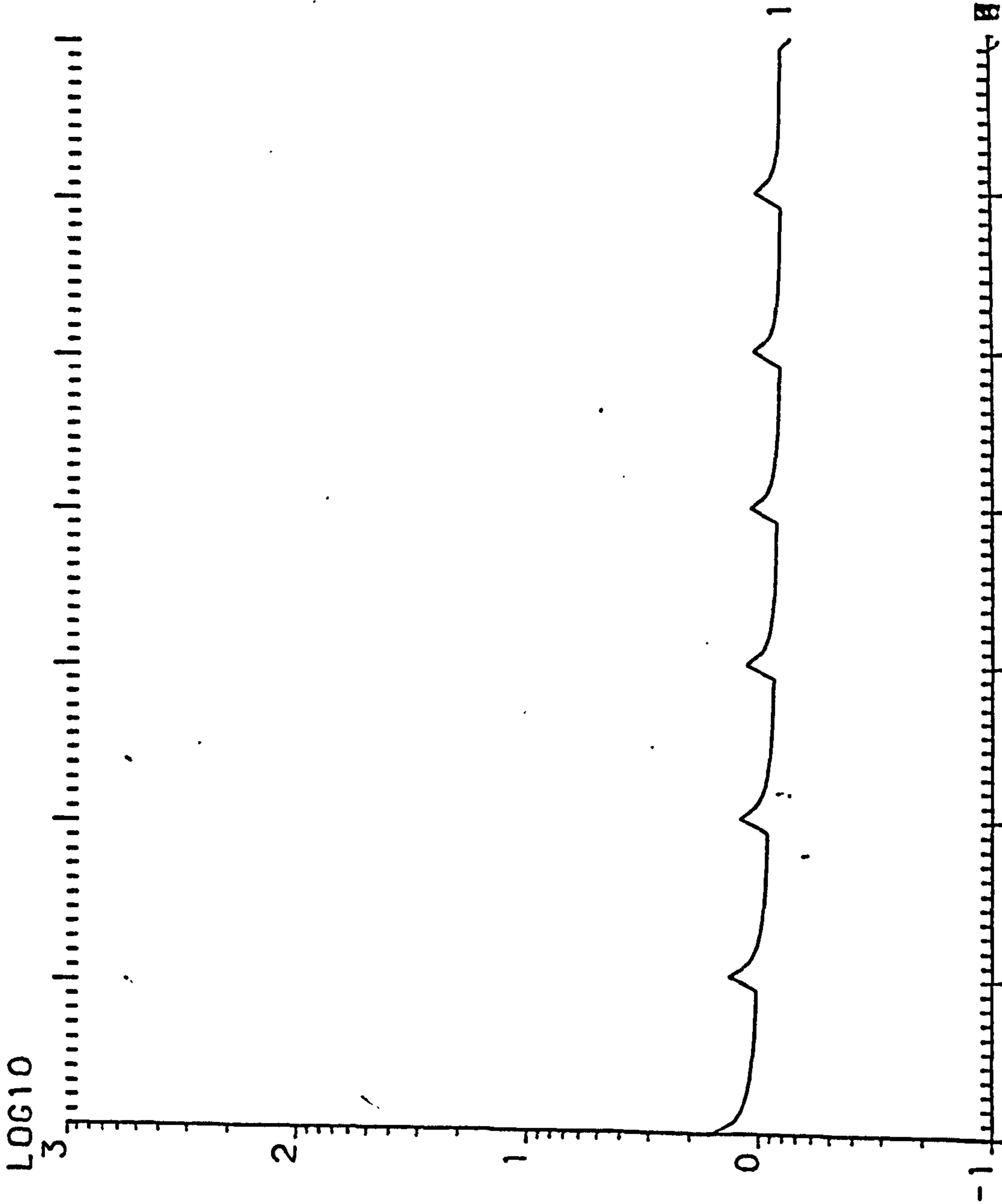

Y. EFFICIENCY W. THICKNESS= .36M W. ORIENTATION=112.50

WD= 22M HD1= 3M HD2= 3M HOUSE T.=2.0 ST.

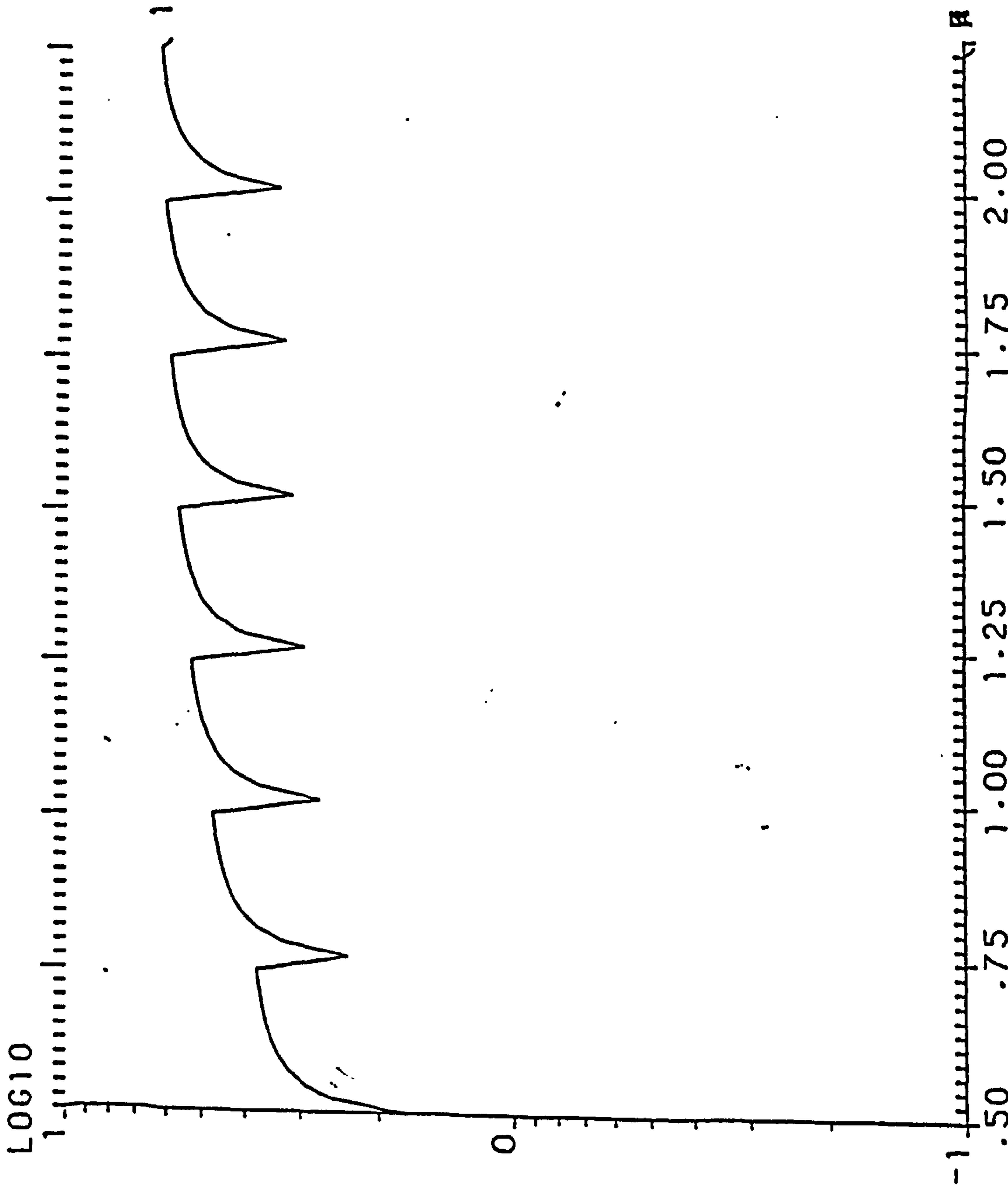

S. EFFICIENCY W. THICKNESS= .36M W. ORIENTATION=112.50  
 HD1= 3M HD2= 3M HOUSE T.=2.0 ST.  
 WD= 22M

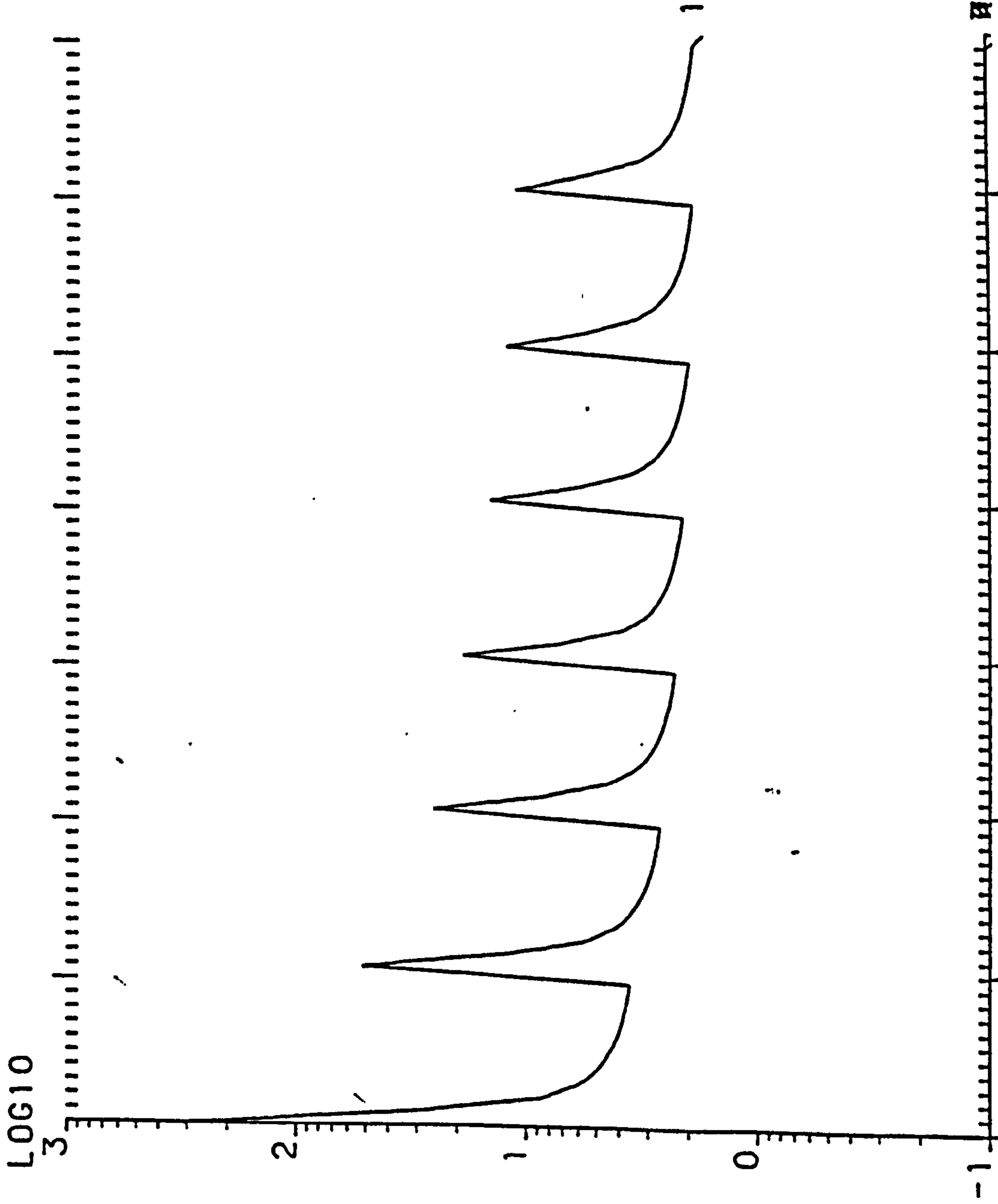

Y. EFFICIENCY W. THICKNESS= .36M W. ORIENTATION=135.00  
WD= 22M HD1= 3M HD2= 3M HOUSE T.=2.0 ST.

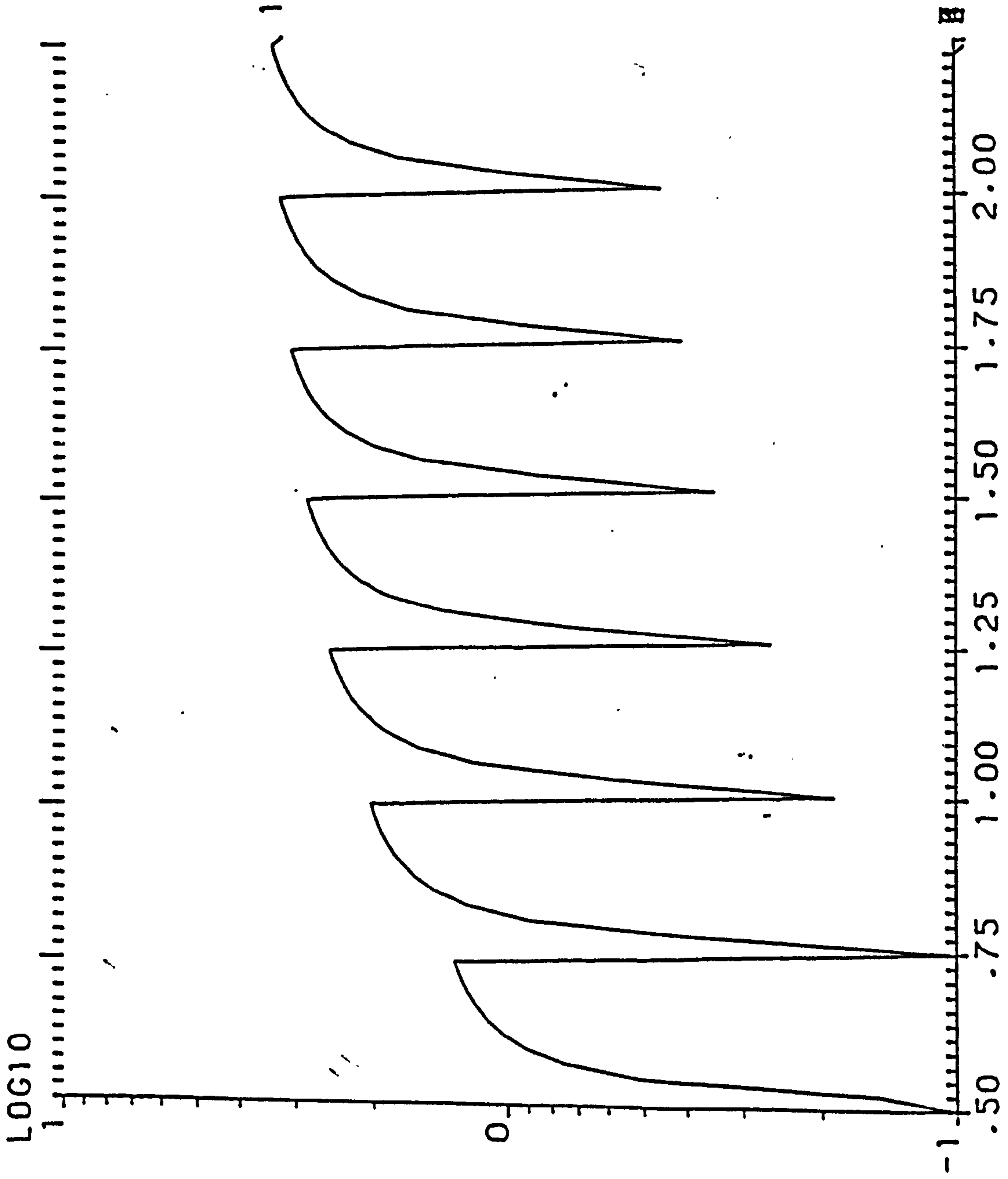

S. EFFICIENCY W. THICKNESS= .36M W. ORIENTATION=135.00

WD= 22M HD1= 3M HD2= 3M HOUSE T.=2.0 ST.

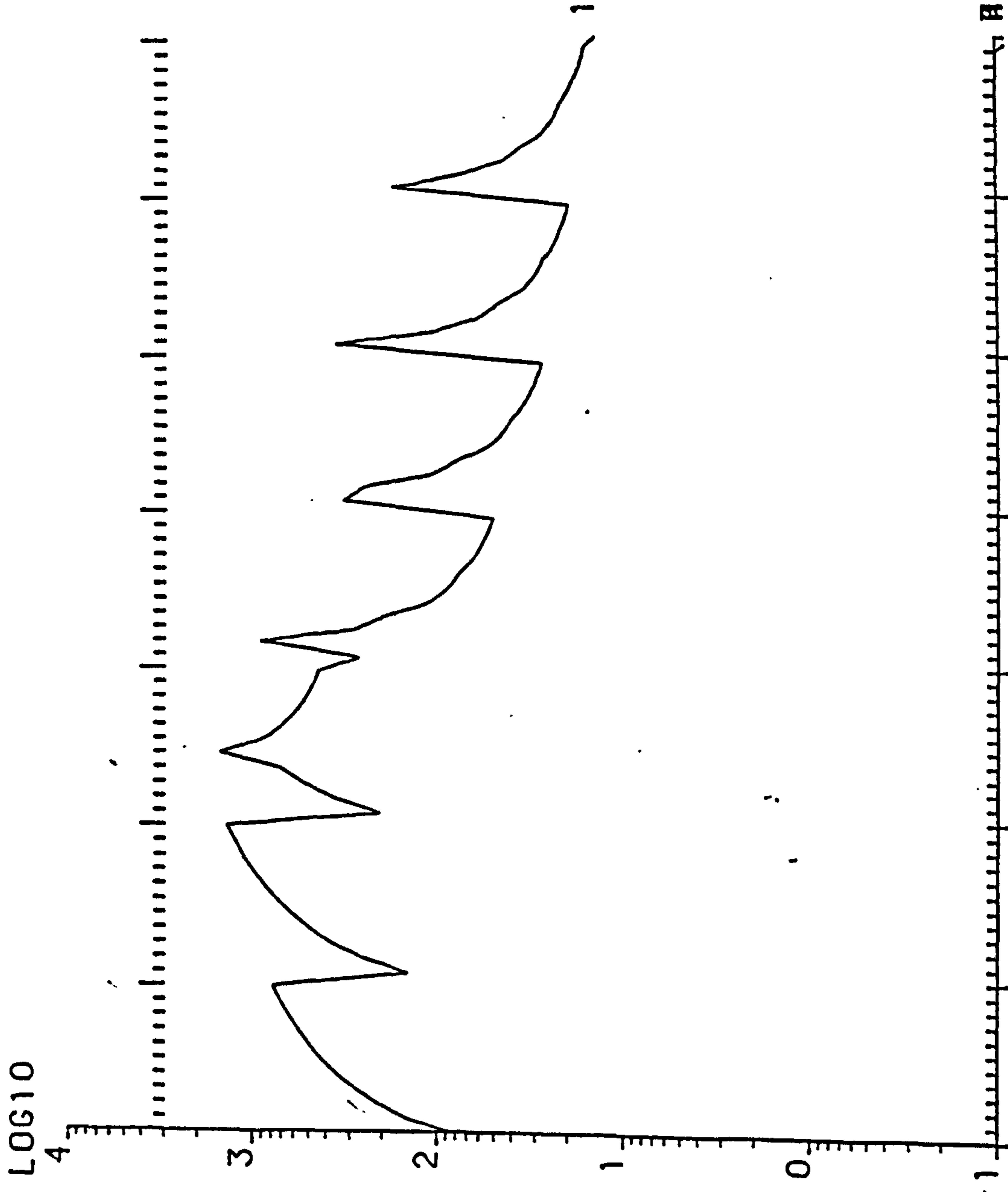

Y. EFFICIENCY W. THICKNESS= .36M W. ORIENTATION=157.50  
WD= 22M HD1= 3M HD2= 3M HOUSE T.=2.0 ST.



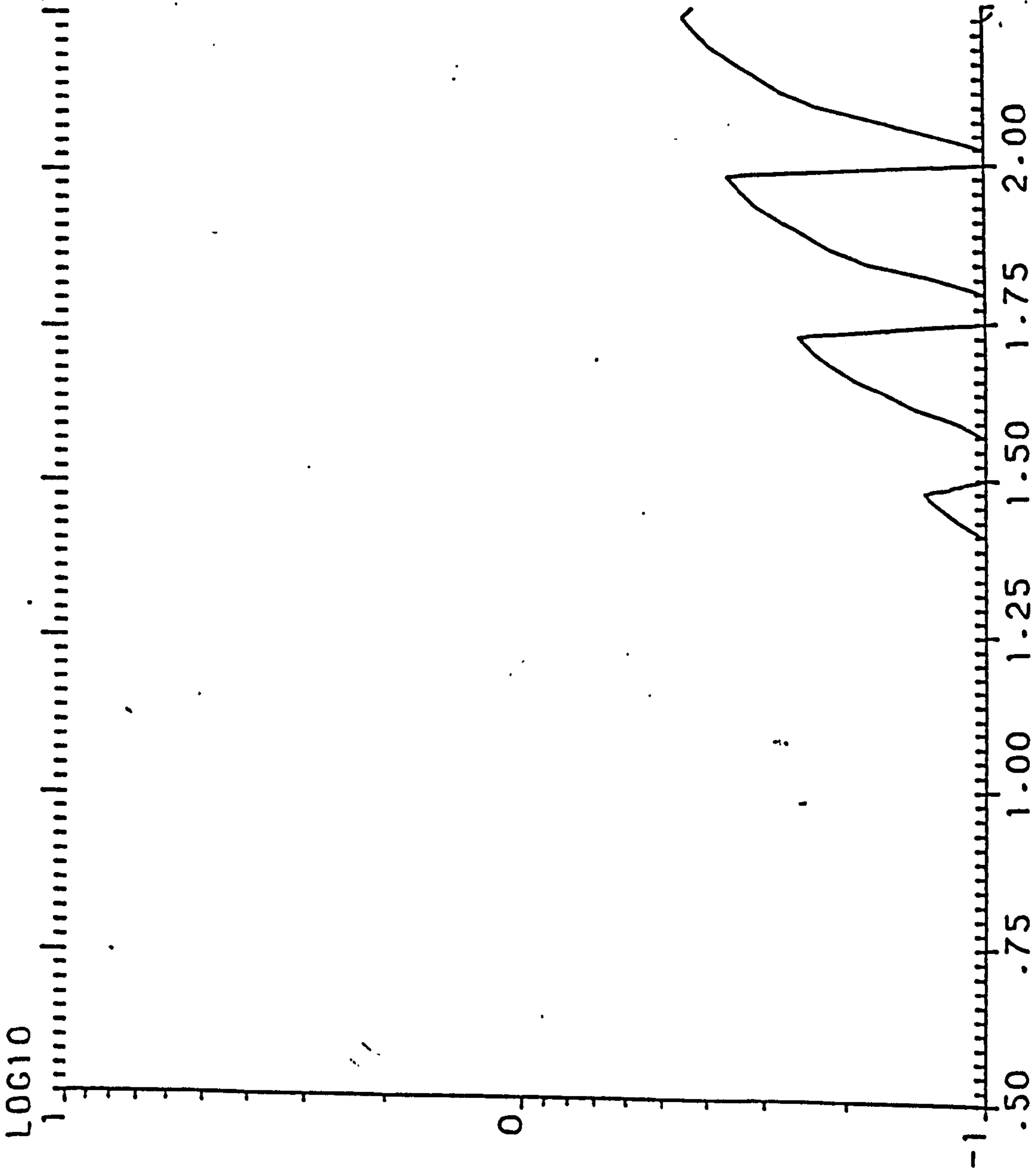

S. EFFICIENCY W. THICKNESS= .36M W. ORIENTATION=157.50

WD= 22M HD1= 3M HD2= 3M HOUSE T.=2.0 ST.



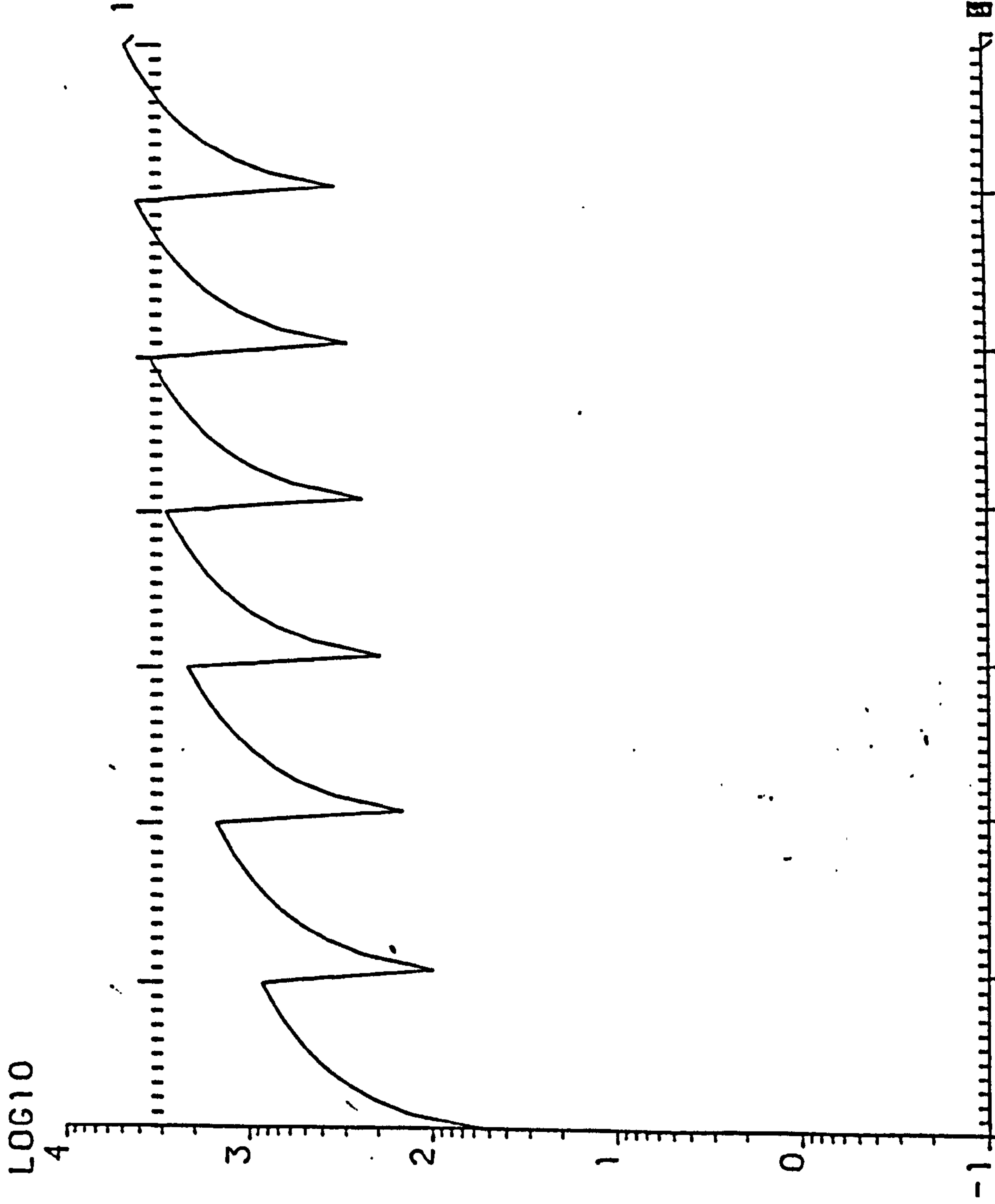

Y. EFFICIENCY W. THICKNESS= .36M W. ORIENTATION=180.00  
WD= 22M HD1= 3M HD2= 3M HOUSE T.=2.0 ST.

LOG10  
1

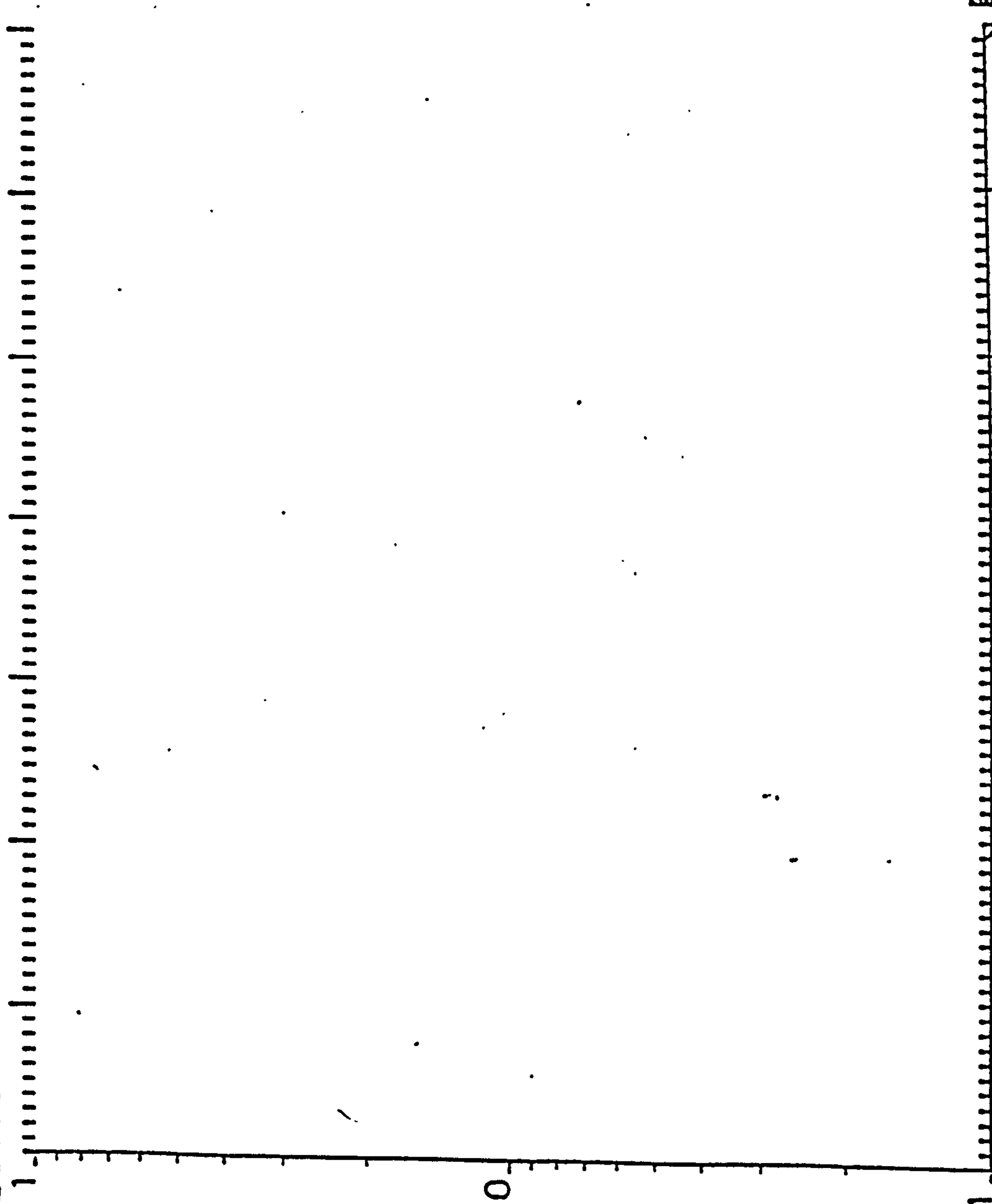

-1

.50 .75 1.00 1.25 1.50 1.75 2.00  
 S. EFFICIENCY W. THICKNESS= .36M W. ORIENTATION=180.00

WD= 22M HD1= 3M HD2= 3M HOUSE T.=2.0 ST.



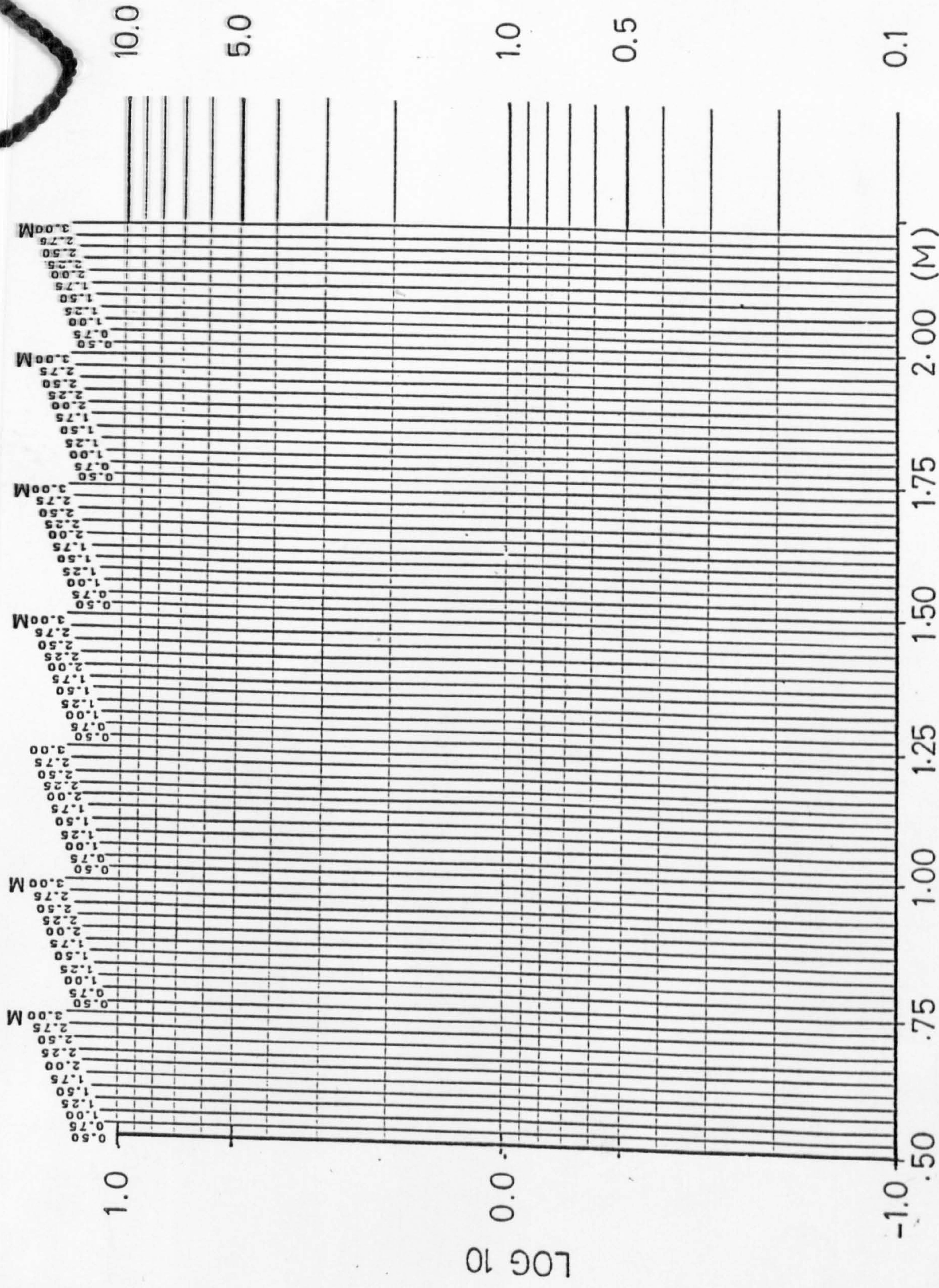

S. EFFICIENCY    W. THICKNESS =    M    W. ORIENTATION =  
 WD = M    HD1 = M    HD2 = M    HOUSE T. =



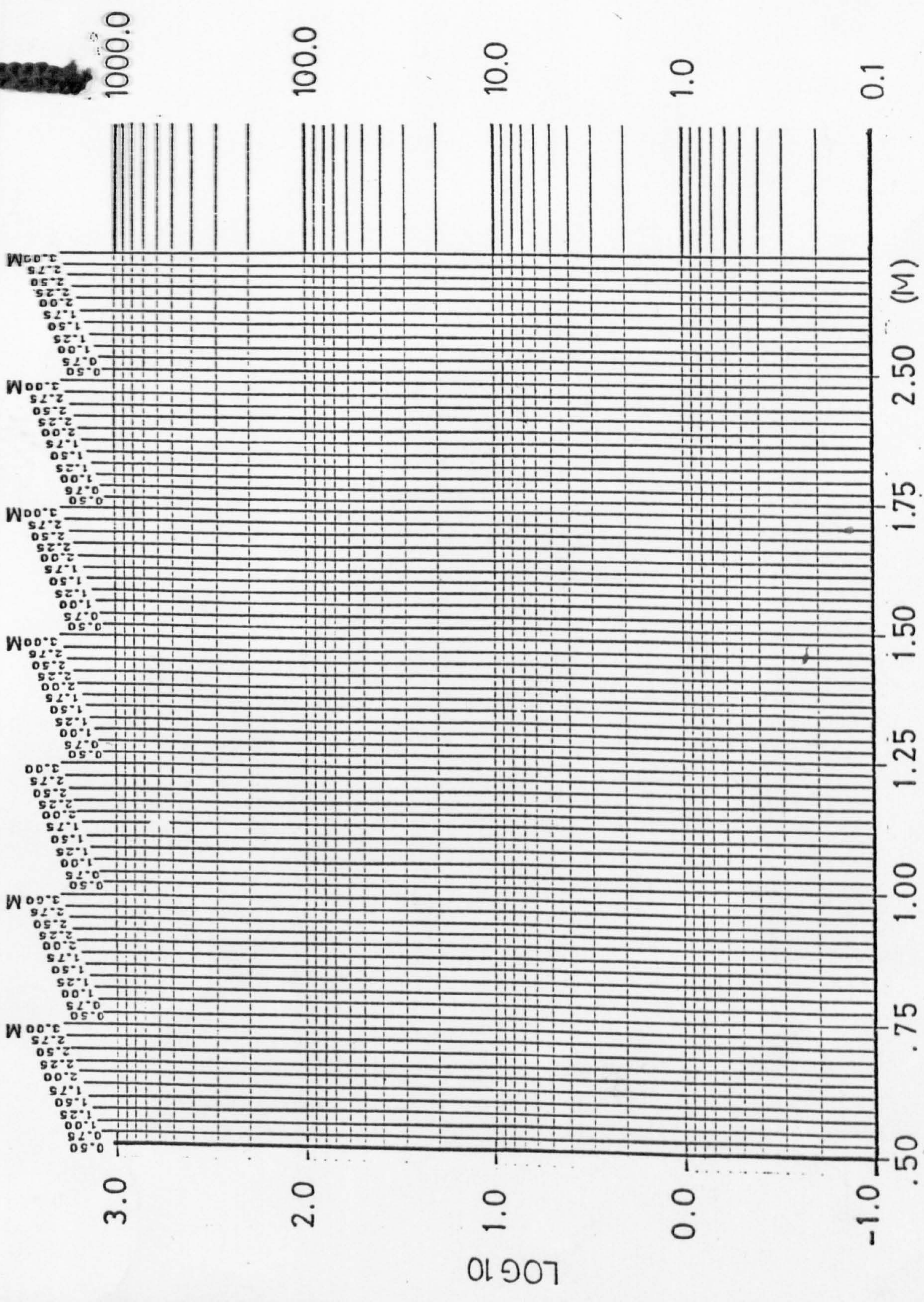

Y. EFFICIENCY    W. THICKNESS =    M    W. ORIENTATION =  
 WD =    M    HD1 =    M    HD2 =    M    HOUSE T. =    ST.



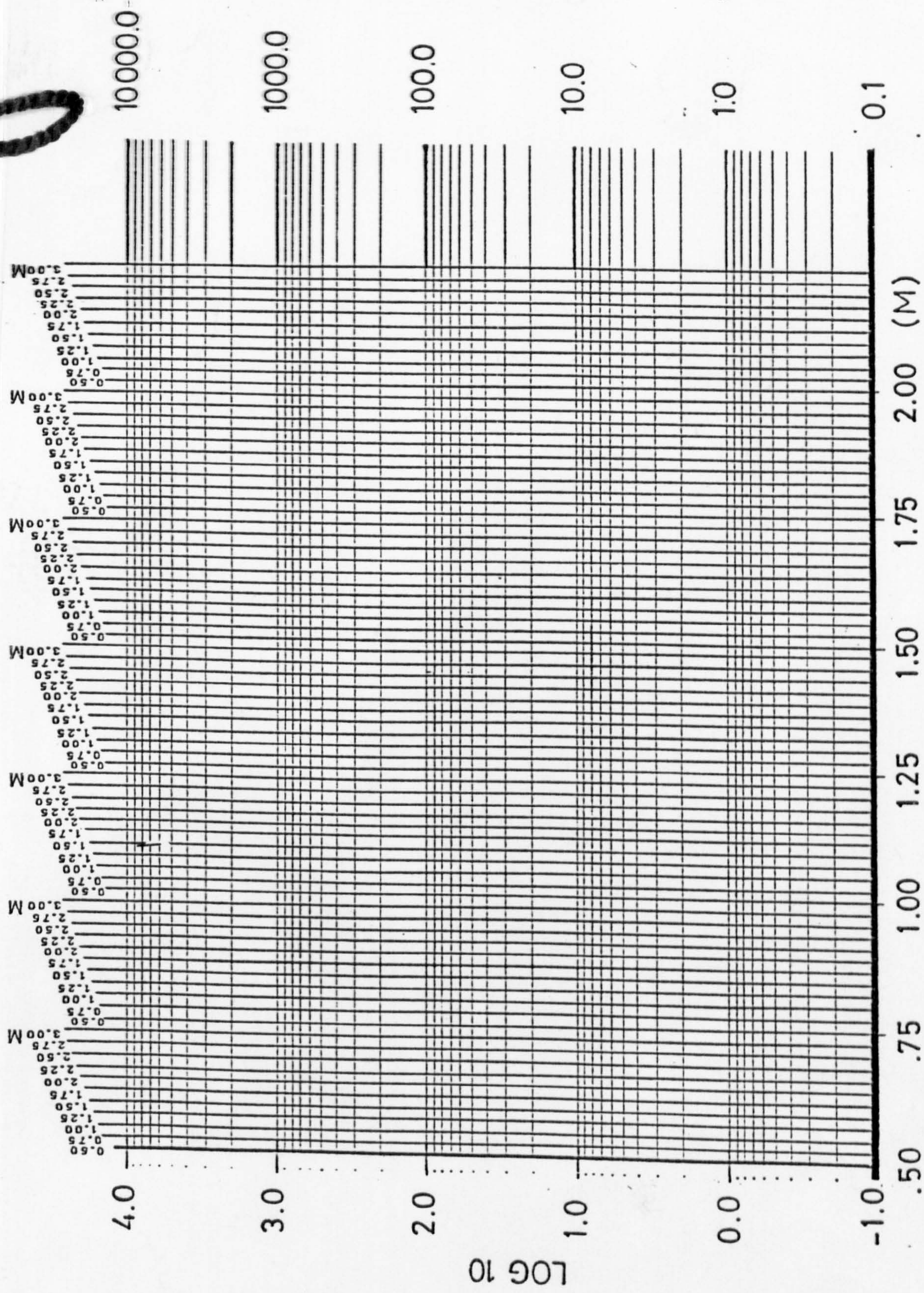

Y: EFFICIENCY, W. THICKNESS = .36M W. ORIENTATION = 180.00  
 WD = 12M HD1 = 3M HD2 = 3M HOUSE T. = 2.0 ST.