



**Biomechanical and
Neurophysiological Investigation
of Insect Tympanal Organs**

Hannah M. Moir

**Submitted for the degree of Doctor of Philosophy,
August, 2012**

**Centre for Ultrasonic Engineering
Department of Electronic and Electrical Engineering
University of Strathclyde**

This thesis is the result of the author's original research. It has been composed by the author and has not been previously submitted for examination which has led to the award of a degree.

The copyright of this thesis belongs to the author under the terms of the United Kingdom Copyright Acts as qualified by University of Strathclyde Regulation 3.50. Due acknowledgement must always be made of the use of any material contained in, or derived from, this thesis.

Signed:

Date:

The thesis work has been published in part and is also under review for publication. The candidate carried out all the experimental work and contributed to all data analysis and writing of the manuscripts.

Signed:

Date:

Abstract

Investigating how insects receive sound via the structure of their auditory organs could inspire new, more sensitive, acoustic sensor systems to be developed, where the insect hearing organs that have previously been documented are believed to be more sensitive than any man-made devices that can currently be made. Firstly though, the structure and functioning of the biological inspiration, insect tympanal hearing organs, have to be more fully understood.

This Thesis research firstly investigated the biomechanical properties of the tympanal membrane of various species and orders of insect using laser Doppler vibrometry. The results were then compared between species, including the different structures and also the membrane mechanics. This chapter results highlights the different structures and also the range of frequencies that each species is tuned to. By comparing the tympanal organs shape and the mechanics on the membrane surface caused by the received sound waves hopefully this can be applied to future membrane design.

Some species of insect have been found to have active hearing characteristics, in order to understand the functioning of these hearing organs these were investigated using different methods to previous studies to try and identify the origin of the active hearing. In previous studies these characteristics were recorded acoustically from the tympanal organs of a number of species. The current study aimed to record the vibration created by the emissions through the membrane this was investigated in both locust and moth tympanal organs. No active hearing characteristics were recordable on the surface of the membrane.

Finally both laser vibrometry and electrophysiology recordings were used to investigate very high frequency sensitivity of a moth hearing organ. The findings have greatly extended the known range of hearing in insects. The moth hearing organ is capable of receiving and processing frequencies up to 300 kHz with a very simple tympanal organ. This discovery could inspire smaller and simpler designs of transducers at ultrasonic frequencies. Overall this thesis work demonstrates the

amazing sensitivity of the insect tympanal organs and takes steps toward further understanding of the auditory processing in insect tympanal organs.

Acknowledgments

Firstly I would like to thank my supervisor Dr. James Windmill for all his support, patience and guidance throughout my PhD, I could not have wished for a better supervisor.

I wish to thank the other members of Insect World, Dr. Joe Jackson, Dr. Shira Gordon, and David Mackie for all their help and useful discussions. In particular to Dr. Joe Jackson who provided help, guidance, for putting out fires, and for lots of equations written on bits of paper.

I would also like to thank the rest of CUE in particular the other reading roomers and researchers who have become great friends and who were a brilliant support in some of the tougher times of the PhD.

My thanks also goes to Dr. Peter Fraser, my honours year project supervisor for encouraging me to continue in academia and for recommending me for this PhD.

I would also like to thank Prof. James Fullard, who sadly died 2 years ago, who was extremely welcoming and gave me the opportunity to spend time in his lab. Thanks also goes to his lab members, all the people I spent the summer with at QUBS, Matt, Nav, Line and James, for having the patience to teach me the moth dissection techniques and all other aspects of electrophysiology and for such a great summer on the lake.

Finally my thanks to my family for all of their love and support; most of all to Andy for all his love and reassurance.

This thesis research was supported by a studentship from the Engineering and Physical Sciences Research Council, (EPSRC, UK).

Table of Contents

Chapter 1: Introduction

1.1 Introduction	2
1.2 Sound Principle	3
1.2.1 Sound waves	3
1.2.2 Monopoles and Dipoles.....	4
1.2.3 Sound Attenuation	5
1.2.4 The Decibel.....	6
1.2.5 Membrane mechanics.....	6
1.3 Structure and Composition of tympanal organs	8
1.3.1 Chordotonal organs	10
1.3.2 Scolopidial cells.....	11
1.4 Evolution of Insect Auditory Systems	13
1.5 Bats echolocation calls.....	14
1.6 Orthopteran Hearing	16
1.6.1 Morphology	16
1.6.2 Use of hearing.....	18
1.7 Lepidopteran Hearing	19
1.7.1 Morphology	19
1.7.2 Sound production.....	21
1.8 Aims of Present Work.....	22
1.8.1 Laser Doppler vibrometry of insect tympanal membranes	22
1.8.2 Investigating active hearing characteristics in insects tympanal organs ..	23
1.8.3 Very high frequency hearing sensitivity in a moth.....	23

Chapter 2: Experimental Methods

2.1 Animals	25
2.1.1 Locusts	25
2.1.2 Moths.....	25
2.1.2i Pyralidae.....	25
2.1.2ii Crambidae	26
2.1.3 Green Lacewings	27
2.2 Sound recording and production.....	27
2.2.1 Microphone.....	27
2.2.2 Loudspeakers	28
2.2.4 Ultrasonic transducers	29
2.2.4i Structure of transducer and powering equipment.....	29
2.2.4iii Transducer output – sound pulses recording.....	31
2.3 Laser Doppler vibrometry	33
2.4 Electrophysiology	35
2.4.1 Dissection techniques.....	35
2.4.2 Electrophysiology experimental equipment.....	39
2.5 Statistics	40
2.6 LabVIEW Software	40

Chapter 3: Laser Vibrometry of Insect Tympanal Membranes

3.1 Introduction	42
3.1.1 Laser Doppler vibrometry	42
3.1.2 Locusts	43
3.1.3 Moth Tympanal Organs	44
3.1.3i Galleria mellonella.....	44
3.1.4ii Plodia interpunctella	45

3.1.3iii <i>Ostrinia nubilalis</i>	48
3.1.5 Lacewings	49
3.2 Materials and Methods	52
3.3 Results	54
3.3.1 Locust results	54
3.3.1i <i>Schistocerca gregaria</i> and <i>Locusta migratoria</i>	54
3.3.2 <i>Galleria mellonella</i> results	56
3.3.2i Laser scans	56
3.3.2ii Transect graphs	57
3.3.2iii Tuning curves	59
3.3.3 <i>Plodia interpunctella</i> results	61
3.3.3i Laser scans	61
3.3.3ii Transect graphs	63
3.3.3iii Tuning curve graphs	64
3.3.4 <i>Ostrinia nubilalis</i> results	65
3.3.4i Laser scans	65
3.3.4ii Transect graphs	68
3.3.5 Green Lacewing results	70
3.3.5i Laser scans	70
3.3.5ii Transect graphs	70
3.4 Discussion	73
Chapter 4: Investigation into the presence of DPOAEs in insect tympanal mechanical membrane motion	
4.1 Introduction	80
4.1.1 Locust tympanal organ morphology	81
4.1.2 Greater wax moth tympanal organ structure	81

4.1.3 Distortion-product Otoacoustic Emissions (DPOAEs).....	82
4.1.4 DPOAEs in invertebrate hearing organs	83
4.2 Experimental Set Up.....	86
4.2.1 Animals	86
4.2.2 Mechanical and Acoustic Measurements	86
4.2.2i Locust experiments	87
4.2.2ii Greater wax moths experiments	88
4.2.3 Locust Single Shot Experiments.....	88
4.2.4 Carbon dioxide induced hypoxia	89
4.2.5 DPOAE SPL Calculations and Experiments.....	90
4.2.6 Altering body temperature of locusts.....	92
4.2.7 Spiracle blocking experiments.....	92
4.3 Results.....	93
4.3.1 Laser Vibrometry scans.....	93
4.3.1i Locusts	93
4.3.1ii Greater wax moth	93
4.3.2 Locust Single-shot results	96
4.3.3 Locust CO ₂ experiments.....	99
4.3.4 Investigation into temperature and presence of DPOAEs.....	101
4.3.5 Blocking Spiracle.....	103
4.3.6 High SPL Intensity Experiments	105
4.4 Discussion	108
Chapter 5: Ultra high frequency response in the greater wax moth	
5.1 Introduction	115
5.1.1 Tympanal hearing organs of the greater wax moth	116
5.1.2 Sound production and communication.....	118

5.2 Materials and Methods.....	120
5.2.1 Animals	120
5.2.2 Laser Vibrometry	120
5.2.3 Electrophysiology	121
5.2.4 Simultaneous recording of laser vibrometry and electrophysiology	124
5.2.5 Sound production using the air coupled ultrasound transducer.....	124
5.3 Results.....	125
5.3.1 Laser vibrometry results.....	125
5.3.1i Laser vibrometry scans	125
5.3.2 Electrophysiology results	131
5.4 Combined Laser and neural measurements.....	135
5.5 Discussion and Future Work	136
Chapter 6: Conclusions and Future Work	
6.1 Tympanal Membrane Mechanics	142
6.2 DPOAEs in insect tympanal organs	143
6.3 High frequency hearing in moths	144
6.4 Overall Conclusions.....	146
References	
Appendices	
Appendix 1: LabVIEW Software Programs	ii
A.1.1 Locust DPOAE data recording	iii
A1.2 Locust DPOAEs Analysis	v
A1.3 Greater wax moth electrophysiology recording and analysis.....	vii
A1.4 Laser Vibrometry and Electrophysiology combined experiments.....	x
Appendix 2: Greater wax moth experiments	xii
A2.1 Dorsal dissection technique	xii

A2.2 Making electrodes	xiii
A2.3 Etching electrodes	xv
A2.4 Saline solution – Spider Ringer	xvi
A2.5 Combined Laser and Electrophysiology experiments – summing amplifier	xvii
A2.6 Greater wax moth laser vibrometry graphs	xviii
Appendix 3 – Published Work	xix

List of Illustrative Materials

Figures

Chapter 1	Page
1.1 Sound wave	3
1.2 Monopole and dipole	4
1.3 Vibration of a simple circular membrane	7
1.4 Location of known insect tympanal organs	9
1.5 a) Chordotonal organ structure, b) Scolopidial cell structure	11
1.6 Locust tympanal organ	17
1.7 Internal view of the locust tympanal organ.	18
1.8 Structure of a Noctuid moth tympanal organ	20
Chapter 2	
2.1 Genitalia of <i>G. mellonella</i>	26
2.2 Structure of a loudspeaker	28
2.3 Structure of an ultrasonic air-coupled transducer	30
2.4 Equipment used to power the ultrasonic transducer	30
2.5 Power output of the transducer	31
2.6 Recording of start of a sound pulse	32
2.7 Internal workings of the laser Doppler vibrometer	33
2.8 Thoracic segments of <i>G. mellonella</i>	36
2.9 First step of moth dissection	37
2.10 Second step of moth dissection	38
2.11 Third step of moth dissection	39
Chapter 3	
3.1 Internal view of Müller's organ of <i>S. gregaria</i>	44
3.2 Tympanal membranes of <i>G. mellonella</i>	45
3.3 Tympanal membrane photographs of <i>P. interpunctella</i>	47
3.4 The tympanal membrane of <i>O. nubilalis</i>	49
3.5 Tympanal organ of the green lacewing	50
3.6 General set up of the experimental equipment	52

3.7 Laser vibrometry scans of <i>S. gregaria</i> and <i>L. migratoria</i>	55
3.8 Laser vibrometry scans of <i>G. mellonella</i>	56
3.9 Transect line graphs, <i>G. mellonella</i>	58
3.10 Investigation of up-tuning in <i>G. mellonella</i>	60
3.11 Displacement graph of individual <i>P.interpunctella</i>	61
3.12 Laser vibrometry scan results of <i>P.interpunctella</i>	62
3.13 Transect line graphs of <i>P.interpunctella</i>	63
3.14 Investigation of up-tuning of <i>P.interpunctella</i>	64
3.15 Displacement graph of the tympanal membrane of <i>O. nubilalis</i>	66
3.16 Laser vibrometry scans of <i>O. nubilalis</i>	67
3.17 Transect line graphs of <i>O. nubilalis</i>	69
3.18 Laser vibrometry scans of green lacewing	71
3.19 Transect line graphs of green lacewing	72
Chapter 4	
4.1 Tympanal membrane surface of <i>S. gregaria</i>	81
4.2 The tympanal organ of <i>G. mellonella</i>	82
4.3 Previously acoustically recorded DPOAEs	84
4.4 DPOAEs Laser vibrometer scans of both locust species	94
4.5 DPOAEs laser vibrometry scans of <i>G. mellonella</i>	95
4.6 Displacement graphs of <i>S. gregaria</i> at different point of the membrane	97
4.7 Waterfall plots of the three species investigated	98
4.8 CO ₂ experiments single-shot results of <i>S. gregaria</i> and <i>L. migratoria</i>	99
4.9 CO ₂ experiments scan results of <i>S. gregaria</i>	100
4.10 Temperature experiments, single-shot results of <i>L. migratoria</i>	102
4.11 Spiracle blocking experiments, frequency spectrum	103
4.12 Spiracle blocking experiments, laser vibrometry scans of <i>S. gregaria</i>	104
4.13 High SPL single-shot recordings of <i>S. gregaria</i>	106
4.14 High SPL laser vibrometry scan results	107
Chapter 5	
5.1 Ventral side of a male <i>G. mellonella</i>	116
5.2 The paired tympanal membrane of <i>G. mellonella</i>	117
5.3 Tymbal of <i>G. mellonella</i>	119
5.4 Areas of the membrane scanned with the laser vibrometer	121

5.5	Equipment set up of electrophysiology experiments	123
5.6	Laser vibrometry scans of <i>G. mellonella</i>	126
5.7	Displacement curve calculation for the full width half maximum	127
5.8	Displacement graph of individual <i>G. mellonella</i> over 50 – 500 kHz	129
5.9	Average membrane displacements	130
5.10	Examples of electrophysiological recordings	132
5.11	High frequency electrophysiology recordings	133
5.12	Threshold curve of the average auditory nerve response	134
5.13	Simultaneous recording experiments results	135
Appendix 1		
A1.1	Locust DPOAEs recording data	iii
A1.2	Locust DPOAEs splitting recorded data	v
A1.3	Moth electrophysiology recording data	vii
A1.4	Moth electrophysiology data analysis	ix
A1.5	Moth Combined experiments	x
Appendix 2		
A2.1	Glass capillary electrodes	xiii
A2.2	Insulated wire with soldered electrode	xiv
A2.3	Equipment set up used to etch the tungsten electrodes	xv
A2.4	Electrical circuit of the summing amplifier	xvii
A2.5	<i>G. mellonella</i> displacement graphs at 70 and 80 dB SPL	xviii
Tables		
Chapter 1		
Table 1.1	Sound attenuation	5
Chapter 2		
Table 2.1	Loudspeakers used in thesis research	29
Chapter 3		
Table 3.1	Summary of species investigated tympanal organ characteristics	51

Glossary

Crista acustica	Is part of some insect species hearing organ, the sensory cells are arranged in parallel and the cells are known to show tonotopy.
Electrophysiology	Recording the electrical activity of neural synapses through electrodes.
Exteroreceptor	Mechanoreceptors that monitor the external forces, such as sound and wind.
Proprioreceptor	Mechanoreceptors that monitor the internal forces, such as breathing and limb movements.
Scolopidial cell	Cells which make up the mechanoreceptors in insect hearing organs.
Tonotopic	Spatial arrangement of hearing cells that show frequency discrimination, for example in the mammalian cochlea where different areas are sensitive to certain frequencies of sound.
Tracheal tissue	Tissue that is part of the respiration system in insects.
Tymbal	A corrugated area of insect cuticle that is used to produce sound.

Chapter 1: Introduction

1.1 Introduction

Tympanal organs are characterised by having a membrane, backed by a cavity for resonance (usually air-filled, but liquid filled in the lacewing organ), and attaching to the membrane the auditory receptor cells. The size of the tympanal organs and also their sensitivity can currently not be replicated in a man-made product. Some of the limitations that are found in transducer design and output are the minimum size of the whole device whilst maintaining the sensitivity, other problems are also found in the output of frequencies by the transducer and also the range of frequencies received, transducers generally have a narrow bandwidth (McSweeney and Wright, 2008). The characteristics of insect hearing that would be beneficial to replicate to man-made devices include, the size and also the range of frequencies that the device is sensitive to, whereas some insects are found to be sensitive to a large bandwidth, for example the work shown in chapter 5. Insect hearing organs have been found to be capable of incredible sound processing despite their relatively simple composition (Yack, 2004). One study has shown how the tympanal ears of *Ormia ochracea*, a parasitic fly which uses the hearing sense to find cricket hosts, has inspired development of a directional microphone (Miles and Hoy, 2006), the current research aims for a similar outcome, contributing to the knowledge in the hope that the tympanal organ of insects as biological inspiration hopefully in the future acoustic emitters and detectors can be replicated with increased sensitivity with simple structure. Only by investigating and fully understanding the structure and functioning of insect ears can this replication be attempted. This chapter will provide a brief background on tympanal hearing organs. Firstly, the principle of sound shall be briefly discussed.

1.2 Sound Principle

1.2.1 Sound waves

Sound can be defined as any form of vibration through a fluid substrate such as air or water. The vibration causes the particles of the medium to be displaced temporarily, this affects the particles in the vicinity and causes them to be displaced too and a wave of disturbance thus occurs propagating the sound. As sound is a wave, frequency and wavelength are associated with the created sound. Sound waves are longitudinal. The frequency, f , of the sound is how many times the air particles oscillate in a second; (Hz). The wavelength, λ , can be calculated from the frequency, using the equation:

$$\lambda = \frac{c}{f}$$

[1.1]

where c is the speed of sound, which changes due to the medium that the sound is travelling through, and also the temperature of that medium.

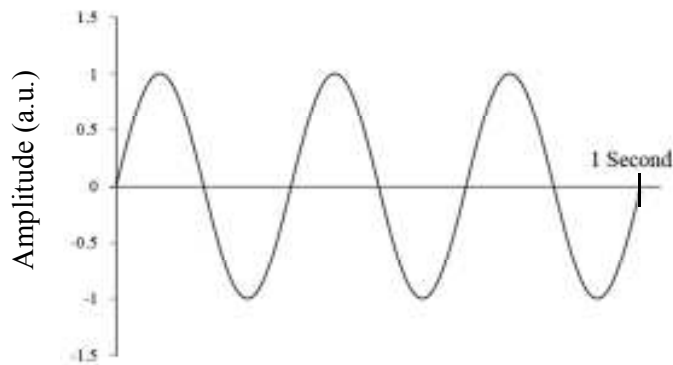

Figure 1.1 Shows an example of a sound wave, at 3 Hz.

$$T = \frac{1}{f}$$

[1.2]

where T = time and f = frequency. The wavelength is the distance over which the wave cycle completes. The velocity of sound is a constant value depending on temperature and the medium the sound is travelling through. In room temperature (23 °C), in air, the speed of sound is 343 ms^{-1} . Knowing this and the frequency of the sound the wavelength can be calculated as:

$$V = f\lambda$$

[1.3]

where v = velocity of the sound, f = frequency and λ = wavelength.

1.2.2 Monopoles and Dipoles

The sound source can be either a monopole or a dipole. When a sound is a monopole the sound is radiated out in all directions in an equal manner. In a dipole source there are two monopoles of equal strength beside one another out of phase and the sound cancels each other out in places so that the sound is not radiated equally in all directions (Fig. 1.2).

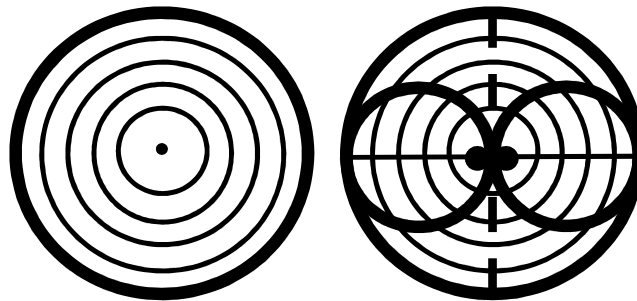

Figure 1.2 Diagram of monopole, left, and dipole, right, sound source.

An example of monopoles in insects that produce sound would be cicadas, the sound radiates from an eardrum on the side of the abdomen; cicadas are the one of the loudest insects known, producing sounds from tymbals at levels up to 110 dB SPL (Young, 1990). A dipole sound source example would be the wings in flight of fruit flies (Bennet-Clark, 1998).

1.2.3 Sound Attenuation

Sound attenuates in air; however the extent of its attenuation is dependent on a number of factors. It is proportional to the distance the sound travels, and also the viscosity of the medium that the sound travels through. Other factors include whether the medium itself is travelling, for example in windy conditions, and also the density and pressure of the medium (Bennet-Clark, 1998). The attenuation of sound in terms of attenuation of intensity and pressure for different modes of sound propagation are summarised in Table 1.1.

Mode of propagation	Attenuation of Sound Intensity (W m^{-2}) ^a	Attenuation of Sound Pressure (N m^{-2}) ^b	Attenuation in dB per doubling of distance
Spherical spreading (in free field)	Intensity $\propto (1/\text{distance})^2$ (plus viscous losses)	Pressure $\propto 1/\text{distance}$ (plus viscous losses)	>6 dB
Circular spreading (in a disc of medium)	Intensity $\propto 1/\text{distance}$ (plus viscous losses)	Pressure $\propto \sqrt{(1/\text{distance})}$ (plus viscous losses)	>3 dB
Linear propagation (along a tube or rod)	Only viscous losses	Only viscous losses	>0 dB

^aIntensity = sound pressure x particle velocity

^bIntensity \propto sound pressure squared

Table 1.1 Sound attenuation due to different modes of propagation. The sound fields in this thesis do not deal with particle velocity but sound pressure, the sound attenuation is included here for completeness, taken from Bennet-Clark, 1998.

1.2.4 The Decibel

Sound pressure is caused by the air particle oscillation. When the air particles are moved by the sound wave in a medium, forces act upon them, namely elastic and inertial forces. The air particles are pushed together by the sound wave which creates an area of compression. The air particles move back causing an area of rarefaction. Sound pressure level (SPL) is measured in decibels, (dB), and a microphone is used to quantify this in air or a hydrophone in water. The sound level pressure is “the number of decibels relative to a reference sound pressure” (Michelsen and Larsen, 1985). The decibel scale is a logarithmic measurement of sound pressure level. Both sound levels in Pascals and decibels are used in this thesis as units. Sound pressure measured in Pascals can be converted to decibels using the equation:

$$dB = 20 \log_{10} \frac{P}{P_0}$$

[1.4]

Where P is the sound amplitude measured and P_0 is the reference sound amplitude, which for standard sound pressure levels is 20 μ Pa. Decibels can then be converted back to Pascals using:

$$P = P_0 10^{\frac{dB}{20}}$$

[1.5]

1.2.5 Membrane mechanics

Tympanal organs receive sound caused by the displacement of a membrane, like humans do through the ear drum. The particle displacement caused by the sound wave vibrates the membrane. These different modes are variable by the frequency of the sound and the structure of the membrane, the modes of vibration of a homogenous membrane are shown below (Fig. 1.3). At lower frequencies the

membrane moves as one, behaving comparably to a simple driven oscillator (a – c) but at higher frequencies the vibrations of the membrane changes due to the phase lag of the incoming sound and the resonance of the membrane. The tympanal membranes of the insect species investigated in this study do not have homogenous membranes however. The locust tympanal membrane is one very good example where the membrane is separated into two thickness and due to this a travelling wave arises on the membrane (Windmill et al, 2005). Different thicknesses of membranes will have different resonances, lower frequency for thicker membranes and higher frequencies for thinner membranes, the membrane will also oscillate at a higher amplitude at the harmonics of the resonant frequency (Michelsen, 1971b).

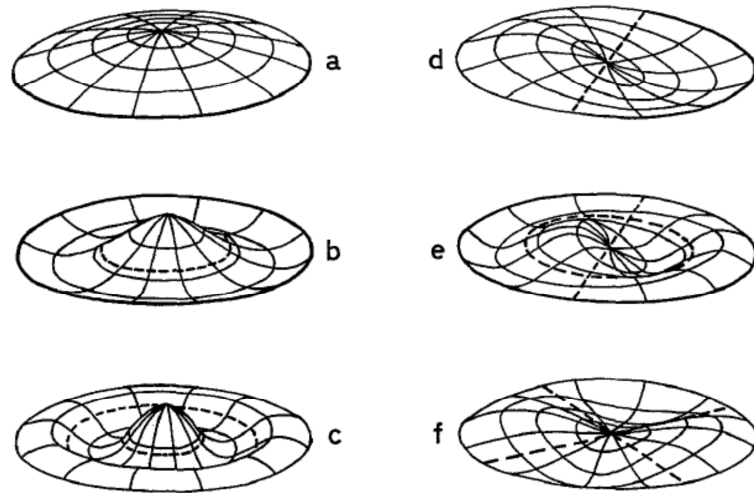

Figure 1.3 Different modes of vibration of a simple circular membrane at low frequencies (a-c) and at higher frequencies (d-f), taken from Michelsen, 1971b.

1.3 Structure and Composition of tympanal organs

Insects were once thought to rely mainly on the visual sense due to the large size of the compound eyes and also the size of the area of the brain which processes the visual information. However it is now known that insects rely as much if not more in some species on auditory information in the environment, particularly the insects which fly at night (Hoy, 1998). Acoustic reception in insects has been found to be very important in some aspects of their lives, examples include: predator detection, attracting and detecting mates, or for detection of hosts and various other social interactions (Yack, 2004). There are four main types of auditory organs found in insects, Trichoid sensilla, Johnston's organs, Subgenual organs, and Tympanal organs, (Yack, 2004). This thesis will concentrate solely on tympanal organs.

A tympanal organ can be characterised by three features, a thinning of the cuticle somewhere on the body forms the tympanal membrane, which vibrates in response to the sound waves received, similar to human ear drums. This membrane is backed by an air filled cavity for resonance of the sound, the majority of known tympanal organs are air-backed; however there is an exception of the green lacewing where the tympanal organ is fluid backed (Miller, 1970). Finally the presence of a chordotonal organ which is made up of a number of auditory receptor cells, scolopidia, attach to the membrane, these cells are mechanoreceptors and transduce the mechanical energy of the membrane displacement into neural synapses which are then transferred to the brain, (Fullard and Yack, 1993; Hoy and Robert, 1996; Hoy, 1998; Yager, 1999; Miller and Surlykke, 2001). The location of known tympanal hearing organs varies greatly depending on species and can be found in different location even when the species are the same order (Fig. 1.4) (Hoy and Robert, 1996; Miller and Surlykke, 2001).

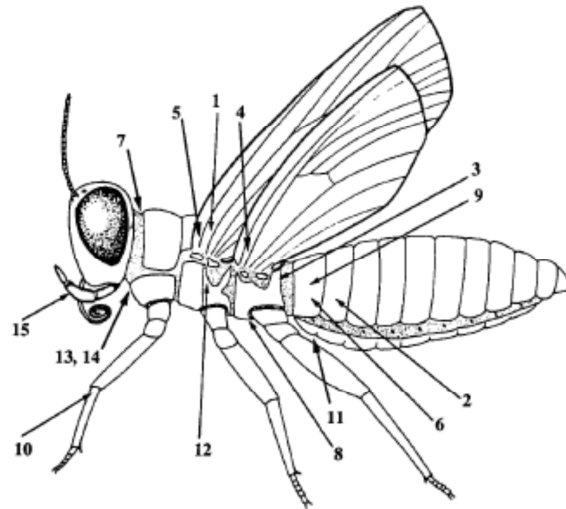

Figure 1.4 Location of known insect tympanal organs, taken from Hoy and Robert (1996), identifies the diverse locations on a generalised body of an insect.

Tympanal hearing organs are pressure receivers, in comparison to antennal hearing organs which are particle velocity detectors. Tympanal organs receive incoming pressure changes of far-field sounds, whereas the antennal hearing organs detect near field sounds (Hoy, 1998). The tympanal organs are paired structures; as are all mammalian ears, this is to distinguish the directionality of the sound (Hoy, 1998). There is one notable exception amongst insect tympanal organs, and that is the cyclops ear of Mantids, although this has also been shown to possess directional sensitivity and is in fact two tympanic membranes side by side (Yager, 1999).

The mechanics of the membrane of some insect tympanal organs has been found to be extremely complex, see chapter 4 for further discussion; and it has also been suggested that the chordotonal organs of some tympanal organs may possess complex oscillations (Breckow and Sippel, 1985). The tympanal organs were always previously thought to function passively (Yager, 1999), as opposed to being active like human hearing. However the presence of acoustically recordable characteristics of active hearing raised the possibility of insects having active hearing (Kössl et al., 2008), although how this characteristic is generated by the tympanal organ remains unknown, see Chapter 5 for further discussion. It should be noted that there are known examples of insects which do possess active hearing, the mosquito is one very

good example where the antennal hearing organ has been shown to amplify low level sounds (Göpfert and Robert, 2001; Jackson and Robert, 2006).

Insects are known to use their hearing organs for various purposes depending on species, the range of frequencies received by the organs is very broadband in terms of frequency over 150 kHz (Yack, 2004), although this has since been found to be even larger from the current thesis work (see Chapter 6). The range of sound intensities that insects are capable of detecting is also large, over 100 dB (Yack, 2004). This is due to the wide range of purposes of hearing within tympanate insect species. Despite the large structural and morphological differences in insect auditory organs they are all similar in the respect that all contain chordotonal organs (Eberl, 1999; Yager, 1999; Mason and Faure, 2004; Yack, 2004). Chordotonal organs and the cellular components of the tympanal organs will be discussed further in the following section.

1.3.1 Chordotonal organs

Chordotonal organs are a type of mechanoreceptor that is unique to Insecta and Crustacea. It should be noted that they are not exclusively sound sensing but are also found in have various roles in the sensory systems of insects and crustaceans and can sense external or internal stimuli, exteroceptors and proprioceptors respectively (Field and Matheson, 1998). Chordotonal organs are generally found at the appendicular joints and at inter-segmental joints and therefore many insect tympanal organs are located there, adapted from previous chordotonal organs, therefore the majority of known insect tympanal organs are found on the thorax and abdominal segments (Hoy, 1998). The tympanal membrane transduces the mechanical movement caused by pressure change due to sound waves received by the ear into nerve impulses. The process of mechanotransduction, on a molecular level, is not very well understood and there remains much to be learnt (Eberl, 1999; Yack, 2004). What is well known is the cellular structure of chordotonal organ which shall be described in greater detail in the following section.

1.3.2 Scolopial cells

The chordotonal organ can be broken down (Fig. 1.5a), firstly by individual scolopial cells, there is one or more present in each chordotonal organ of the tympanal organ of insects. Scolopial organs are classified as being a mechanoreceptor inside the body where they detect mechanical stress (Keil, 1997). Scolopial cells are made up of four types of cells in a linear manner (Yack, 2004) (Fig. 1.5b).

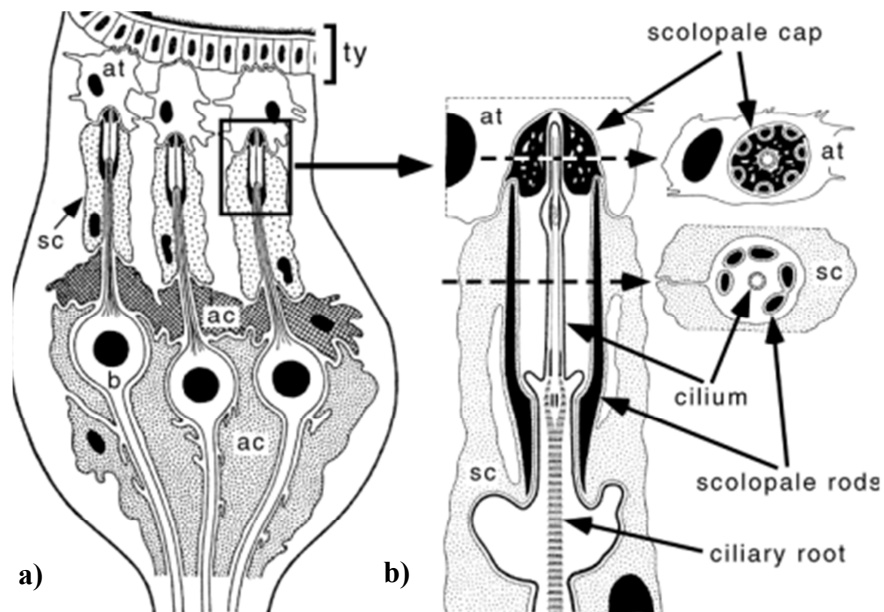

Figure 1.5 a) is a cross section through a chordotonal organ taken from Yager, 1999, which was adapted from Gray, 1960, of a locust chordotonal organ; where ac = accessory cells, b = bipolar sensory cells, at = attachment cells, sc = scolopale cell and ty = tympanum. **b)** shows an individual scolopial cell from **a)** and the cellular structure of the scolopial cell with various parts of the cells shown in a different view.

The four cells types which make up a scolopial organ are:

- 1: one bipolar sensory neuron, although there can be up to four.
- 2: a scolopale cell this envelopes the dendrite
- 3: one or more attachment cells

4: a glial cell also called a Schwann cell connecting to the scolopale cell (Hoy and Robert, 1996; Yack, 2004).

Scolopidia are divided into two types, type 1 and 2, depending on the kind of ciliary segment of the sensory cell dendrite; all tympanal hearing organs possess scolopidia which are type 1 (Yack, 2004).

The information processed by the hearing organ is related to the number of scolopodial cells found in the hearing organ, for example insects which use the hearing sense for complex courtship calls such as species of Orthoptera have many more scolopodial cells, than for example Notodontid moths which possess only one auditory cell for the detection of bats (Yager, 1999; Yack, 2004).

The molecular mechanism of transduction in the scolopodial cells, how the received mechanical energy is converted into a nerve synapse, is not well known or understood (Yack, 2004). One suggestion is that there are ion channels that are activated by the mechanical forces due to the membrane stretching in tympanal membranes, causing the cilium to be stretched, this is the suspected site of the active hearing found in *Drosophila* (Göpfert and Robert, 2003), this is due to research using *Drosophila* mutants which alter the cellular structure of the chordotonal organ (see Eberl, 1999 for a review).

1.4 Evolution of Insect Auditory Systems

Insect tympanal hearing organs are known to have evolved in seven orders out of the 27 known insect orders, and within these orders have evolved at least 19 times independently (Yager, 1999). All tympanal hearing organs in insects are known to have evolved from pre-existing chordotonal organs (Yager, 1999; Stumpner and von Helversen, 2001). However, there is a difference in the timing of the evolution in different orders of insects, some orders are thought to have evolved hearing organs for intra-specific auditory communication, such as crickets and cicadas and these hearing organs appeared 200 or more million years before the appearance of echolocating bats, the other main reason for insect hearing evolution (Stumpner and von Helversen, 2001). There is a recent example where the song of an extant Jurassic species of Katydid from 165 million years ago, which was recreated using the wing structure of the fossil (Gu et al., 2012), showing that there was acoustic communication used before bats. Other insects which possess ears such as the mantises, moths, lacewings and beetles evolved due to the appearance of echolocating bats which are their main predator, these insects were not thought to possess hearing sense prior to the evolution of bats (Stumpner and von Helversen, 2001).

There are examples in the insect orders which evolved due to bats that also use intra-specific communication and vice versa, the insects which primarily used hearing for intra-specific communication now also detect bats (Stumpner and von Helversen, 2001). There is however a marked difference in the sensitivities of the two groups, bat detecting ears are very sensitive to ultrasonic frequencies, whereas the ears which are for intra-specific communication are lower in frequency, tuned to the frequency of the call produced by its peers, these insects also require acute recognition of temporal aspect of the calls and also need to accurately detect directionality of the source of the sound (Stumpner and von Helversen, 2001).

One of the main reasons that insects evolved hearing organs and also one of the main reasons for the continuing adaptations found are bats and their hunting calls. Here a brief background will be provided of bats and their hunting calls.

1.5 Bats echolocation calls

Bats have evolved in an extremely specialised niche, flying and also hunting at night, this has provided them with an advantage over other mammals and they are very successful with over 900 species known. Bats appeared 50 million years ago and caused a new predation pressure for the existing insects (Hoy, 1992; Stumpner and von Helversen, 2001; Neuweiler, 2003). Bats use echolocation, which is the production of ultrasonic sounds emitted through the mouth or nostrils and the received echoes by the bats' ears builds up a picture of the surrounding environment, bats also use echolocation to detect and hunt prey (Neuweiler, 1984). The bats echolocation abilities are so effective at 'seeing' that they can hunt in total darkness (Neuweiler, 1984). The hunting calls of bats have special characteristics, for effective hunting when the bats are scanning the environment the calls are spaced far apart, and then when an insect is detected the sound pulses become more frequent, allowing homing in on the prey and then just before the item is captured the pulses produced are rapid. These three phases of the echolocation are known as the search, approach and terminal phases (Griffin, 1960).

The type of echolocation call used by different species of bat is due to the different obstacles that different environments cause, for example bats which hunt in large open spaces will have different echolocation calls to bats which hunt in forest areas (Neuweiler, 1984). Calls can be frequency-downward-modulated sweeps (FM) which can contain a broad frequency spectrum, or can also contain long pure tone calls, known as constant-frequency (CF) sounds as well as FM components (Neuweiler, 1984). However, this is a very broad characterisation and the actual calls of bats, a group which has over 900 known species, can vary greatly, for instance some bats do not use echolocation at all to capture prey and some have also been found to occupy other niches, for example fruit bats (Neuweiler, 1990). Echolocation calls are species specific and as such can be used to identify bats from sound

recordings (Fenton and Bell, 1981). The highest known echolocation calls in terms of frequency are produced by gleaning bats which capture prey from surfaces not in the air (Neuweiler, 1984; Neuweiler, 1990), the calls of these bats are known to have frequencies up to 212 kHz (Fenton and Bell, 1981) and are inaudible to a species of moth (Faure et al., 1993). Some species of bats are also known to call at very low frequencies out with that of moth hearing (Fullard, 1998).

The two orders of insects investigated in the thesis, Orthoptera and Lepidoptera, shall be discussed in more detail in the following sections, although more detail of each species will be provided in the introduction of the relevant chapters.

1.6 Orthopteran Hearing

Orthoptera are one of the most conspicuous insects which produce sound, as many species are known to stridulate using their wings or legs (Hoy et al., 1989). They use the sounds produced to communicate intra-specifically and so have evolved hearing organs to detect the sounds emitted by others as well as possibly detecting predators. The auditory organs of locusts and grasshoppers are the most studied out of all insects, (Yack, 2004) and therefore the structure and functioning of the hearing organ is one of the most understood. The species of Orthopteran investigated in this thesis are *Schistocerca gregaria* and *Locusta migratoria*, which are locusts from the family Acrididae; more detail about the hearing organs of these species shall be provided in the following section. These are commercially available species which were able to be ordered year round.

1.6.1 Morphology

Locust auditory organs are located on the first abdominal segment under the wing on either side of the insect. The membrane is kidney shaped and the size of the membrane is roughly 2.5 x 1.5 mm (Michelsen, 1971). The tympanal membrane is divided by two regions of different thickness and these areas are separated by the folded body (Fig. 1.6). Behind the membrane is the Müller organ, the chordotonal organ, through which 60 - 80 scolopidia sensory cells are attached to the membrane (Michelsen, 1971). The cells are grouped together in four separate regions, a-d, and these attach at different points on the membrane (Gray, 1960), (Fig. 1.7). The a- and b- cells attach to the folded body and are sensitive to frequencies between 6.7 - 8 kHz, the c-cells attach to the styliform body and are sensitive between 2 - 3.5 kHz and the d-cells attach at the pyriform vesicle and are sensitive to frequencies above 12 kHz (Michelsen, 1971a).



Figure 1.6 The locust, *Schistocerca gregaria*, tympanal organ taken from Windmill et al, 2008, showing the location on the animal, upper scale bar is 12 mm, and the surface of the tympanal membrane, outlined in dashed blue line, the attachment regions of the receptor cells has been highlighted; the high frequency cells, (d-cells), in green on the pyriform vesicle and the low frequency cells, (a-c cells), in red along the folded body, the lower scale bar is 200 μm .

It was originally noticed that the locust hearing organ possessed frequency discrimination due to the groups of cells having different frequency sensitivity ranges (Michelsen, 1971a), however it was not understood how this was achieved by the organ until the travelling wave on the membrane was discovered (Windmill et al., 2005). Using micro-scanning laser vibrometry the membrane mechanics could be measured accurately, the membrane was found to react to different frequencies such that the incident sound creates waves that travel on (or in) the membrane, and so the sound's energy is transferred to frequency specific areas of the membrane where the mechanoreceptor neurons are located (Windmill et al., 2005), further discussion of the membrane mechanics can be found in chapter 4.

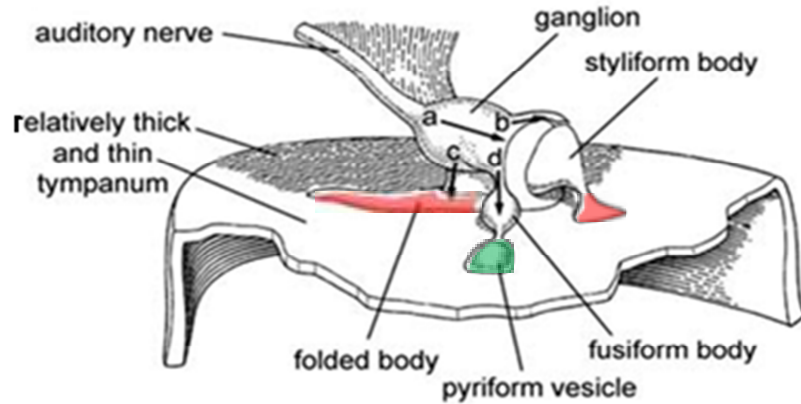

Figure 1.7 The internal view of the locust tympanal organ. The regions of the sensory cell attachment are highlighted with the low frequency receptor attachments (a-c cells) in red along the folded body, and the high frequency receptor attachment (d cell) in green, (modified from Möckel et al, 2007).

1.6.2 Use of hearing

The auditory organ of the locust is quite complex compared to other insect orders, gauging by the number of scolopidial cells present (Michelsen, 1971). The reason for this complexity has been suggested for intra-specific communication, where the songs can be complex, they use the intra-specific communication in mating rituals and also in aggression (Hoy et al., 1989). The details of the intra-specific communication however remains poorly understood, and there is also suggestion that locusts may use the hearing sense for bat detection also (Miller and Surlykke, 2001). Flying locusts have also been found to change flight direction when bat echolocation is played, indicating bat evasive behaviour and so the hearing sense may also be used for this (Robert, 1989; Dawson et al., 2004). There is also mention of communication as the locusts are swarming (Haskell, 1957). There remains much to be understood about the role sound plays in the locust life cycle.

1.7 Lepidopteran Hearing

The structure of the hearing organ of moths has been known for a long time initially described by Eggers in 1919; however the role of this structure was not known and it was not until the work by Roeder in the 1950's and 1960's which firmly linked the tympanal hearing organs of moths with their predators, echolocating bats (Roeder and Treat, 1957). In Roeder and Treat's famous studies they established a firm relationship between moth hearing capabilities and the bats that predate on them by using a variety of experimental techniques thoroughly investigating the auditory organ and the behavioural aspects of the moths.

Acoustic information has since also been found to be an important aspect of other parts of the life cycle, the larval stages of some species of Lepidoptera have been found to produce and also detect sound, they use this sound production for territorial purposes and also for predator defense (Yack et al., 2001; Bura et al., 2011; Guedes et al., 2012). However the tympanal organs of the adults of the order are investigated only in this thesis and the structure and functioning of these are further discussed in the following sections.

1.7.1 Morphology

The hearing organs of moths and butterflies are located in diverse parts of the body depending on species, such as on the metathorax, abdominal segments or as altered head appendages (Spangler, 1988a). Tympanal hearing organs are currently thought to be around half of species of Lepidoptera (Fullard, 1998), this is calculated from the assumption that all species of Noctuidae possess ears. The shape of the tympanal membrane differs between species (Spangler, 1988), as does the number of receptor cells from as little as one auditory receptor cell per tympanal organ (Surlykke, 1984), up to four in some species (Spangler, 1988a). Auditory cells are numbered by sensitivity, so A1 is the most sensitive then A2 and so on (Roeder, 1974). All known moth hearing organs also possess an apparently non-auditory B-cell (Treat and Roeder, 1959), the role of this cell is not known, there has been a great deal of

speculation, the majority of authors think it may be vestigial (Yack and Fullard, 1993; Fullard, 1998). The B cell has a constant firing rate of 10-20 Hz and the rate is not thought to be affected with acoustic stimulus, the size of the B cell spike is generally larger than the A cell spikes (Lechtenberg, 1971). The B cell attaches to the Bügel of the tympanal organ at the back of the tympanal cavity (Fig. 1.8).

Even though the solely bat detecting moths are very simple in structure they are still known to have brilliant sensitivity for detecting hunting bats. Noctuid moths, which possess 2 A-cells, are known to have different evasive behaviour (Roeder, 1966a). This is dependent on the intensity of the sound and is due to the auditory cells having different thresholds (Roeder, 1965; Roeder, 1966b). Therefore a closer and louder bat will trigger both A1 and A2 cells and the moth will carry out more extreme action to avoid being eaten, folding the wings and dropping out of the sky. Than if the bat is further away and quieter and possess less of a risk, the moth will change flight direction (Payne et al., 1966).

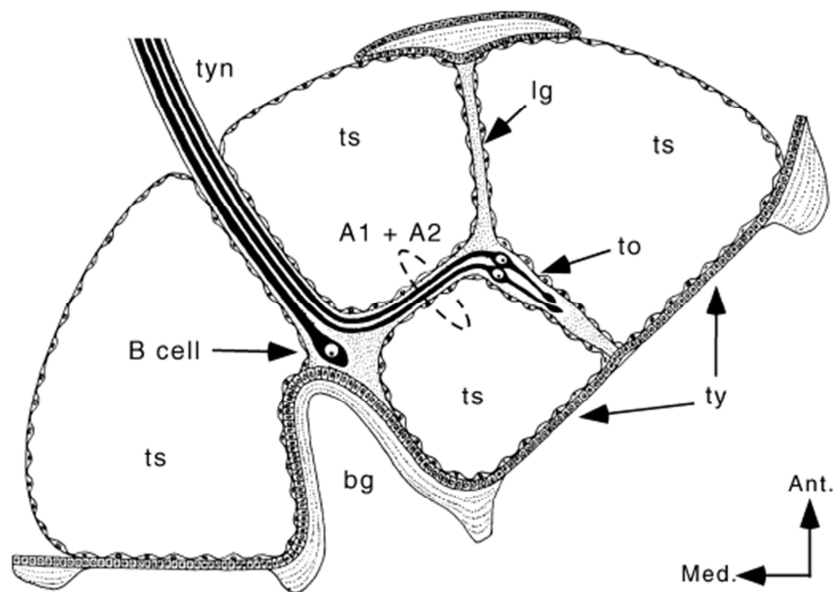

Figure 1.8 The structure of a noctuid moth tympanal organ, taken from Yager (1999), through a cross sectional view; where tyn = tympanal nerve, ts = tracheal sacs, to = tympanal organ, lg = ligament, ty = tympanal membrane, and bg = Bügel, which is a part of cuticle. The A cells A1 and A2 are shown as is the B cell which attaches to the Bügel.

1.7.2 Sound production

In some species of moths the hearing sense has also been exploited to include another use; the moths use sound production as courtship calls using it for mate attraction and detection (Conner, 1999). There are also known examples of moths producing warning or bat echolocation blocking clicks (Fullard et al., 1994; Ratcliffe and Fullard, 2006). The body locations of the sound producing structures are as diverse as the locations of the tympanal organs (Conner, 1999). Intra-specific communication was first discovered in the Galleriinae moth group (Spangler, 1988), and has been described in 3 families of Lepidoptera: Pyralidae, Arctiidae, and Noctuidae, with other families also suggested to use ultrasonic courtship (Conner, 1999). The moths that use intra-specific communication also need to retain the ability to detect bats. Moths also use sound production for defence; this has been shown in the family Arctiidae, the ultrasonic pulses produced by tymbals appear to startle the bats, there is also some work done on the pulses actually blocking the echolocation calls of the bats (see Conner, 1999 for a review). More recently Crambidae species have also been found to ‘whisper’ ultrasonic courtship calls, with specialised scales on the wings (Nakano et al., 2009a).

1.8 Aims of Present Work

Insect hearing organs have previously been found to be capable of incredible sound processing despite their relatively simple composition and also size; insect hearing sensitivity ranges up to frequencies of 150 kHz and sound levels of 100 dB SPL (sound pressure level) (Yack, 2004). This sensitivity, especially the sound level capability range has to date not been matched in a man-made product. By investigating and fully understanding the structure and functioning of insect ears this can be attempted. Using the tympanal organ of insects as biological inspiration hopefully in the future acoustic emitters and detectors can be replicated with increased sensitivity with simple structure. The first step in doing this is to fully understand just how the insects hearing organs are capable of such amazing sensitivity in terms of sound intensity and also frequency range. This is the aim of the current thesis research; a large volume of work has been previously done on insect auditory organs however there are still gaps in the knowledge. With new technology available now the hearing organs can be investigated using different techniques and so a more definite picture of characterising the organs can be carried out. In the present work this was done using laser Doppler vibrometry techniques and also electrophysiology to investigate the functioning of various species of tympanic organs of insects.

1.8.1 Laser Doppler vibrometry of insect tympanal membranes

The mechanics of tympanal membranes is investigated in a number of species using laser Doppler vibrometry. The tympanal membrane is the first point of detection of the sound and as such it is required to be effective at this. Using a micro-scanning laser Doppler vibrometer to measure the mechanics of a number of species of insect tympanal organ, more could be learnt of how the insects process incoming sound. A number of species which had not been previously investigated using laser vibrometry are shown and discussed (Chapter 3).

1.8.2 Investigating active hearing characteristics in insects tympanal organs

Distortion product otoacoustic-emissions (DPOAEs) are a characteristic of active hearing processes in hearing organs. These were found to be acoustically recordable from a number of species of insect tympanal organs (Kössl et al., 2008). DPOAEs are generated in the ears of animals when two tones of different frequency are applied, it is not known where the distortion is created in the tympanal ears of insects. The current research aimed to record the emission on the tympanal membrane of locusts and also a species of Pyralidae moth. The emissions were previously found to be sensitive to various physiological modifications, the current research also investigated the effect of different physiology modifications to try and identify the site of emission of the DPOAEs. No emissions were ever found on the membrane of any insect species tested (Chapter 4).

1.8.3 Very high frequency hearing sensitivity in a moth

The mechanics of the tympanal membrane of the greater wax moth (*Galleria mellonella*) were investigated using laser Doppler vibrometry, the displacement of the attachment point of the receptor cells was found to be still above 1 nm when the frequency of the sound applied was 150 kHz and at 90 dB SPL (Chapter 4). This then led to the use of a custom built ultrasonic transducer to produce the sound so that frequencies above the limit of commercially available loudspeakers could be applied as acoustic stimulus to the moth tympanal membrane. The results showed that the mechanics of the attachment point were still large up to 300 kHz. Previous studies have suggested that the moth responded both mechanically on the membrane (Spangler and Takessian, 1983), and also by observations of behavioural responses to very high ultrasound, >200 kHz, (Spangler, 1984b). To identify if the moths were still detecting sound pulses up to 300 kHz, electrophysiology of the auditory nerve was carried out (Chapter 5).

Chapter 2:

Experimental Methods

This chapter gives an overview of the methods used in the studies described in the following chapters, more detail of the relevant methods of some experiments can also be found in chapters 3, 4 and 5.

2.1 Animals

The insect species investigated in the current work was heavily reliant on the insects which could be purchased from commercial outlets as it was not possible to collect insects outdoors, primarily due to the location. The insects chosen could be ordered year round and were mostly able to be kept in the laboratory with the exception of the green lacewings. A second factor involved was the consideration of using ultrasonic hearing insects, such as the majority of the moth species investigated.

2.1.1 Locusts

The locusts were obtained from Blades Biological Ltd. (Cowden, UK), both *Schistocerca gregaria* and *Locusta migratoria* were investigated, due to both species being readily available and also the hearing organ is one of the best understood and most studied in these species. The locusts were kept in a tank at room temperature and were kept on a photoperiod of 12 hours provided by a fluorescent lamp. The insects were fed organic lettuce and provided with water. To prepare the locusts for experimentation the wing was trimmed using scissors ensuring that the tympanal organ was exposed whilst ensuring the cut was not made too high up to cause a larger amount of hemolymph to be bled. The locusts were otherwise unharmed and were then restrained using Blu-tac.

2.1.2 Moths

2.1.2i Pyralidae

Two species of Pyralidae moths were investigated; the greater wax moth, *Galleria mellonella* and the Indian meal moth, *Plodia interpunctella*. Greater wax moths were obtained from Livefood UK (Somerset, UK). The Indian meal moths were obtained

through eBay. Both species of moth arrived in the larval stage, the larvae were transferred to a Tupperware container covered with insect mesh and sealed with a rubber band. The moths were given dried fruit and allowed to pupate and emerge to adults. The containers were kept in an incubator to regulate temperature and humidity, lights inside the incubator provided a 12 hour photoperiod. The adult moths do not feed and so no food or water was needed. To prepare the moths for experimentation they were refrigerated to immobilise them, they were then restrained using staples placed into a plasticine block, securing the wings and abdomen. To expose the tympanal membranes for laser vibrometry measurements the mesothoracic segment was held back using a bent staple. The legs were also removed so not to obstruct the tympanal membranes. The moths were sexed by their genitalia (Fig. 2.1), and the females of both species being slightly larger in body size.



Figure 2.1 The genitalia of the greater wax moth with the female on the left and the male on the right, the male has a squarer shape whereas the female is more pointed and the protruding ovipositor is visible with the orientation shown. The other moths investigated also had similar genitalia.

2.1.2ii Crambidae

The European corn borer moth, *Ostrinia nubilalis* was also investigated. The moths were kindly provided by Dr. Sergine Ponsard at Université P. Sabatier in Toulouse, France. The moths arrived as pupae and were treated as has been previously described for the Pyralidae moths above. The adult moths were provided with sugar water. The same procedure as described for Pyralid moths was carried out for preparing them for experimentation.

2.1.3 Green Lacewings

Green lacewings, *Chrysopa carnea*, were obtained from Gardening Naturally (Cirencester, UK). The green lacewings arrived in the larval stage. The larvae are incredibly cannibalistic and so the majority of the larvae had to be separated and kept in individual vials. The larvae were fed a variety of food including *Drosophila*, both the adult flies and the larvae. The larvae had problems at all stages of development and the survival rate was very low. There were only 3 adults which successfully emerged. The adults were immobilised by refrigeration and then restrained to a plasticine block using paper strips to secure the delicate wings.

2.2 Sound recording and production

This section details how the sound was detected and recorded, using a microphone, and also how the acoustic stimulus was produced using various types of loudspeakers and also transducers. Transducers are devices that convert one type of energy into another, for example loudspeakers are a type of transducer, they convert electrical energy into mechanical that produces sound, as are microphones which do to the opposite, converting the energy of the membrane displacement into an electrical energy value.

2.2.1 Microphone

The sound level in all experiments apart from some of the ultrasound measurements in chapter 5, was measured using a calibrated microphone coupled to a preamplifier (Brüel & Kjær, microphone: 4138, preamplifier: Nexus 2690; Nærum, Denmark). The microphone frequency sensitivity ranged from 6.5 Hz to around 140 kHz. The microphone was a pressure receiver as opposed to a particle velocity microphone and so was therefore directional and so care had to be taken to the microphone placement in the experiments, especially at higher frequencies.

The microphone was calibrated using a B&K calibrator, which emitted a 1 kHz tone at 94 dB SPL or 1 Pa. The calibrator holds the microphone at a certain distance

at all times from the sound source. This provides consistency. The microphone recording can then be analysed using an oscilloscope or the laser Doppler vibrometer reference channel to ensure that the sound level being received by the microphone is accurate.

2.2.2 Loudspeakers

Loudspeakers are electro-acoustic transducers, they all have a generally similar structure (Fig. 2.2). To produce the sound the electrical input is applied through the lead wires and this causes a vibration of the diaphragm due to a magnetic field created by the electrical current in the voice coil generating a mechanical force which moves the coil back and forth, the faster the diaphragm is vibrated the higher the frequency of the sound produced. In the experiments the loudspeakers were driven with an audio amplifier (Sony, TA-FE570; Tokyo, Japan) and function generators (Tektronix, Dual Channel-AFG 3102; Bracknell, UK) and (TTI Instruments, TGA12102; Huntingdon, UK). Various loudspeakers were used in the experiments included due to requiring different frequency spectrums; the types of loudspeakers used are summarised in Table 2.1.

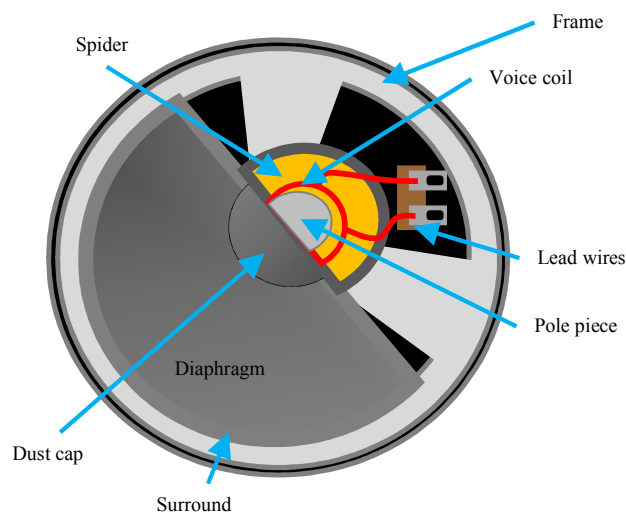

Figure 2.2 A generalised structure of a loudspeaker.

Model	Make	Frequency range
4" speakers	Maplin	1-20 kHz
ST50 Super-tweeter	Tannoy	20-100 kHz
Air Motion Transformer	Heil	0.028-23 kHz

Table 2.1 Summarises the different makes and models of loudspeakers used and their frequency range that they are capable of producing.

2.2.4 Ultrasonic transducers

2.2.4i Structure of transducer and powering equipment

Ultrasonic transducers are used for a variety of purposes. One example is in non-destructive testing which uses transducers to test equipment for cracks by applying ultrasonic sound waves and inspecting the echoes that are returned. Others include application in the medical industry for imaging purposes (Leighton, 2007). The structure and the various components equates to the frequency spectrum that the transducer produces.

The frequencies that needed to be produced for the experiments of Chapter 5 went above the limit of commercially available loudspeakers and so therefore a custom built ultrasonic transducer was used (Whiteley et al, 2010). The transducer was capable of producing frequencies between 50 kHz – 1 MHz. Other equipment was needed to power the transducer (Fig. 2.4) in comparison to the loudspeakers, including a high voltage power supply, the frequencies used were produced using a function generator (Tektronix, Dual Channel AFG 3102, Bracknell, UK) and passed to the transducer.

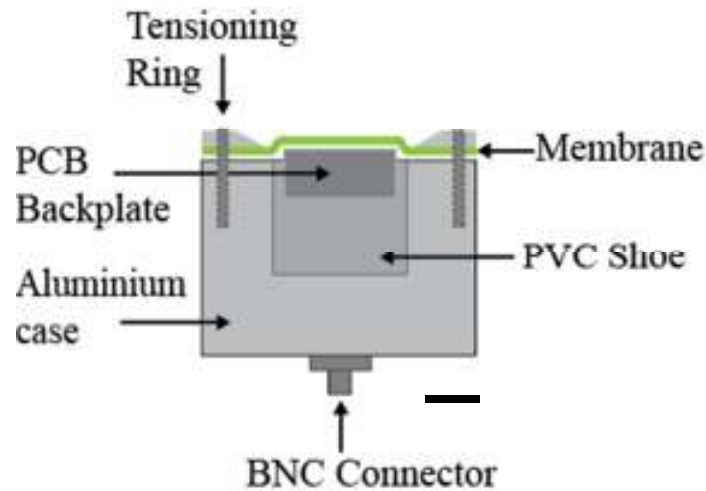

Figure 2.3 Shows the structure of the ultrasonic air-coupled transducers used in Chapter 5. Scale bar is 10mm, for further details of the transducer design please see Whiteley et al, 2010.

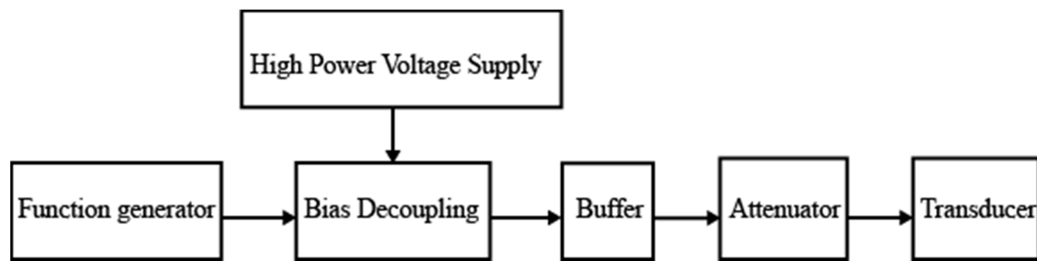

Figure 2.4 The equipment used to power the ultrasonic transducer.

2.2.4ii Power output of the ultrasonic transducer

The output of the transducer was recorded in various ways to confirm the sound level output over the frequencies tested as the microphone used could not confirm the sound pressure levels above 140 kHz. The voltage applied to the transducer controlled the power output. For the electrophysiology and laser experiments the voltage applied was 5 V_{pp}, this input produced a sound level of 90 dB SPL. This was confirmed using the microphone to record the sound level at 10 kHz intervals between 50-120 kHz (Fig. 2.5). As the transducer output was measured to be linear

after 100 kHz (Whiteley et al, 2010), the sound level above 140 kHz was therefore known.

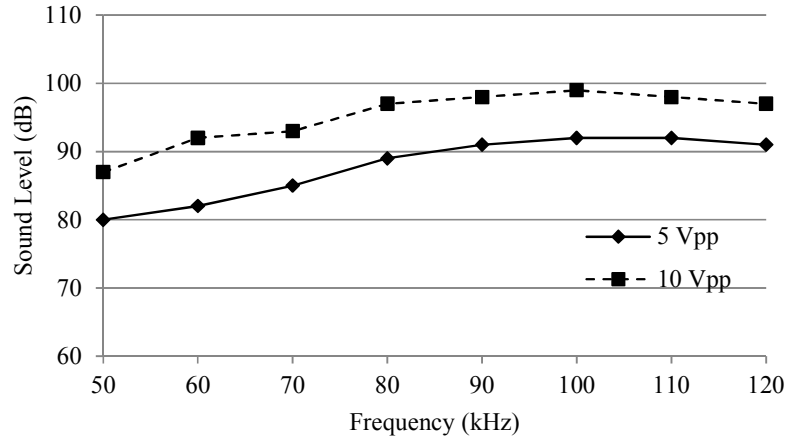

Figure 2.5 Graph of the sound output of the transducer in dB SPL over frequencies 50 – 120 kHz measured with a microphone when the transducer is driven with different voltage inputs, 5 and 10 Vpp (peak to peak) using the function generator.

2.2.4iii Transducer output – sound pulses recording

To rule out extra artefacts being introduced with the sound pulses produced by the transducer the start of the sound pulse was recorded to investigate if the signal was clean. Artefacts may be produced that have lower frequency components, which in turn may cause the auditory organ to react. Using two transducers, one to produce the sound and one to detect it, sound pulses of various frequencies were recorded. In all recordings the sound pulse was a clean sine wave confirming that no extra artefacts were being produced (Fig. 2.6).

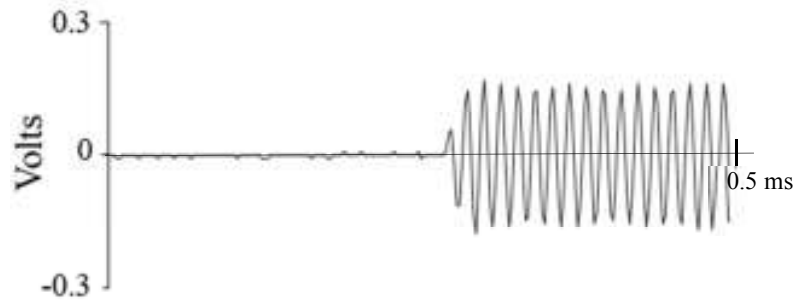

Figure 2.6 Start of a sound pulse used in moth electrophysiology experiments, recorded using a second transducer, the units the sound pulse were measured in was volts. The sine wave recorded showed no extra frequencies were being created due to artefacts. This was the same for the range of frequencies tested. The above example is a 200 kHz sound pulse.

2.3 Laser Doppler vibrometry

The laser Doppler vibrometer is an instrument that is used to measure the vibration of an object; the system uses the principle of the Doppler effect. The Doppler effect is where the frequency of the wave e.g. sound is affected by the position of the sound being emitted and also where the sound is received. A good explanation of the Doppler effect is to think of an ambulance moving towards a stationary person, the sound changes as the ambulance approaches, passes and moves away from the person. The vibrometer emits a laser beam which hits the surface of the object to be measured; the laser spot focussed on the surface of the object has a diameter of 1 μm . The light is scattered and the light reflected back is received through the laser system 'head', such that the velocity of the object can be quantified, and the displacement of the object due to the vibration calculated, as measured from the reflected light (Fig. 2.7).

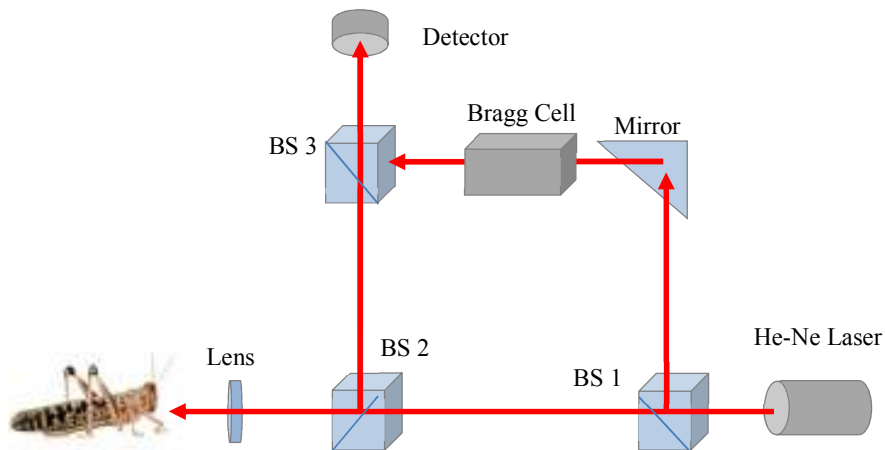

Figure 2.7 Shows the internal workings of the laser Doppler vibrometer; modified from Polytec Vibrometry Basics. The helium-neon laser (He-Ne laser), produces the laser light which is then split by the first of the beam-splitters (BS 1). One beam is directed to the detector which is used as a constant the other beam is the measuring beam which is focussed on the object, the difference between the measuring beam and the constant beam can then be calculated to give a value for the vibration of the measured object.

The laser vibrometer uses two light beams, one a reference beam and one a measurement beam, to quantify the test object's velocity. The helium neon laser beam is split into two by a beamsplitter (BS1); the measurement beam is then passed through another beamsplitter (BS2) before being focused on the measurement object. The beam reflected from the measurement object is then merged with the reference beam again by another beamsplitter (BS3). The Bragg cell shifts the reference laser light frequency by 40 MHz so that the direction of the vibration of the object be it towards or away from the vibrometer can be distinguished; as the light wave received back from the object will be less than 40 MHz if away from the vibrometer or more than 40 MHz for movement towards the vibrometer. The laser vibrometer can be used to scan a whole area or it can be used to record the vibration at a specific point on the object. The scans of the object can be animated and used to visually reconstruct the data recorded of the objects vibration. For more information on the workings of the laser Doppler vibrometer please see the Polytec website: <http://www.polytec.com/us/solutions/vibration-measurement/basic-principles-of-vibrometry/>.

Application of the laser Doppler vibrometer can be extremely varied for example in acoustics research and for non-destructive testing in the aviation industry. The laser Doppler vibrometer is a very accurate measurement of the vibration of an object and can measure vibration down to pm (picometre). The laser beam of the vibrometer does not affect the insect and the method is a good non-contact and non-invasive way of recording the mechanics of the tympanal membranes of insect auditory organs.

2.4 Electrophysiology

Another method to investigate the auditory sensitivity of insects used in this thesis was through extracellular electrophysiology. Electrophysiology records the nerve activity, in this case the auditory nerve. Electrophysiology was one of the methods of investigation carried out on the greater wax moths (Chapter 5). This section provides an overview of the techniques and equipment used in the experiments. Extracellular electrophysiology was carried out where the insect had to be dissected in order to expose the auditory nerves before the nerve is hooked using a tungsten electrode which transfers the electrical synapse of the nerve so that it can be recorded, the dissection technique used on the moths shall be described in more detail in the following section.

2.4.1 Dissection techniques

This dissection is written for Noctuid moths whereas the moths which were investigated using electrophysiology in this thesis are Pyralid moths. Where the dissection differs it shall be clearly stated.

The moth is placed in a vial in the refrigerator to immobilise it for around 5 minutes. The legs can then be removed by carefully pulling them or by cutting them. The moth's wings are then spread out onto a plasticine block which is shaped like a wedge, the head on the larger end of the wedge, this helps with the dissection. If the moth is large a groove for the body can be made in the plasticine. Restrain the wings using staples in a plasticine block and also the abdomen using a bent staple. Another bent staple is used to pull back the first set of legs which should be angled so as the moth is stretched to expose the thorax (Fig. 2.8). The head is then covered with a small strip of plasticine so as to reduce the external sensory stimulus being processed by the moth. Scales from the metathorax of Noctuids and both the meta and mesothorax of Pyralidae are removed using a blunted paintbrush or the end of a twisted kim wipe. The leg stumps can also be trimmed back with scissors if they are particularly large.

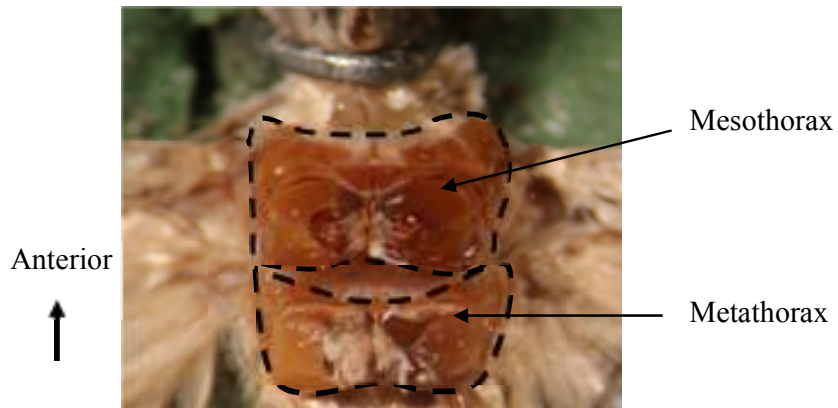

Figure 2.8 A restrained greater wax moth, with the thoracic segments highlighted.

Using scissors the ventral cuticle and associated muscles are removed, shallow snips of the scissors around the join of the muscle tissue which is darker in colour to the sides, along the top of the muscles care needs to be taken so as not to sever the ganglion as it quite near the surface. A cut is then made up the central line where the flight muscles meet taking care again not to cut too deep (Fig. 2.9). Using tweezers the two now flaps are raised and the tissue joining the base of the muscles to the mesothoracic segment is torn. The flight muscles are pulled back gently and small shallow snips of the scissors down the side to remove as much as possible do the same for the other side. If the moth being prepared is a Pyralid then the mesothoracic segment is also removed, this is done by cutting shallowly down the centre of the join of the muscles similar to the metathoracic segment. One side is then gently pulled to the side cutting as more of the sides of the muscle are exposed (Fig. 2.10).

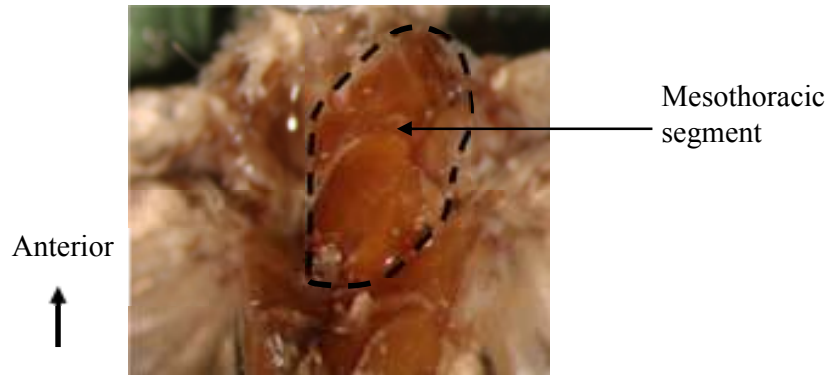

Figure 2.9 One side of the metathoracic segment removed, the other side next to be removed is outlined in a dashed line.

A small drop of saline is now added to the preparation (Saline instructions can be found in Appendix: Section A2.4). In both types of moths there is a cuticle which is between the two body segments for support, this can sometimes be removed along with the muscles but if it is not then it is now carefully removed as it covers part of the nerve. In some moths there is the digestive tract this should be removed if it is in the path of the nerves along with any tracheal tissue, which is identified as being very white and opaque in contrast to the nerves. If this causes the cavity to become messy with debris it can be cleaned by rinsing with saline and remove the moisture with a kim wipe before filling again with saline. Two tracheal tracks of tissues lie over the auditory nerve and serve as a good marker; these should be carefully removed with small tweezers if they are in the way of gaining access to the nerve. These are identifiable by the very white appearance as the nerve itself is almost transparent.

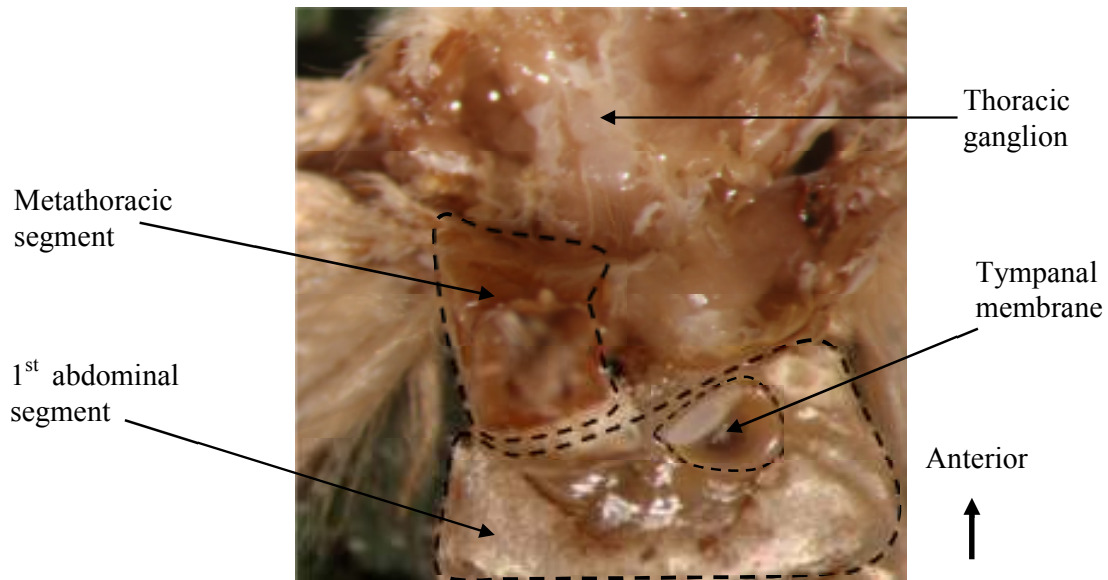

Figure 2.10 One side of the metathoracic segment has been removed, the tympanal membrane on this side is now visible, as well as the thoracic ganglion.

The reference electrode should now be placed in the abdomen. The nerve electrode is guided with a micro-manipulator and once the nerve is successfully hooked the saline in the cavity is drained using a kim wipe (Fig. 2.11). It is then checked by applying sound stimulus to see if there is nerve activity and therefore the nerve is correctly hooked. If there is no neural activity then add saline to the preparation again and hook the nerve again. Once the nerve is hooked correctly apply Vaseline from a syringe around the electrode being very careful not to knock the nerve, this will help to prevent desiccation. Another technique for dissection the dorsal approach is described in the appendix as this was not used in the current study of the greater wax moth.

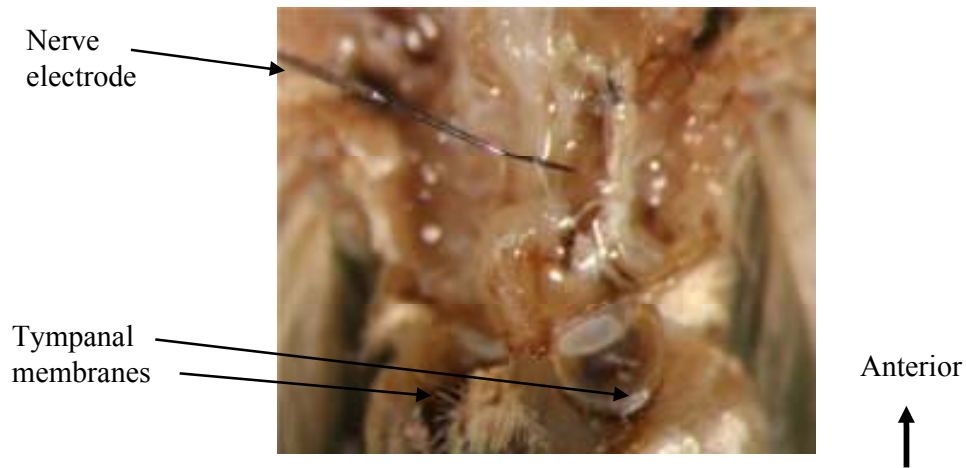

Figure 2.11 All thoracic segments have been removed and the nerve which is hooked on the tungsten electrode is visible as are both tympanal membranes.

2.4.2 Electrophysiology experimental equipment

In the current study the development of the experimental set up went through many changes. This was mainly due to noise problems, predominantly from electrical noise of 50 Hz which is produced in the buildings electrical mains. Some of this could be filtered using software after it had been recorded. However some of the amplifiers used especially one which was built in house caused too much background 50Hz mains noise on the signal that at low nerve activity the recordings could not be analysed. Using a DAM50 amplifier purchased from WPI overcame these problems.

Once the auditory nerve is hooked successfully, the nerve is lifted slightly so the electrical current that runs along the nerve can be detected by the electrode; a reference electrode is also inserted usually into the abdomen providing the difference and also grounding. The electrical signal is amplified and can then be transferred to an oscilloscope where it is assessed this also shows the sound pulses. Also a sound proof outer box covering the anti-vibration table was built and lined with acoustical foam and this did help to reduce the overall noise floor of the recordings. For further details of the experimental set up used see Chapter 5.

The recordings of the auditory nerve could then be analysed and from the results the threshold could be identified. The threshold is the lowest sound level that elicits neural activity of a particular criteria, for example in the moth auditory nerve

output the neural threshold is normally identified from the presence of 2 or more A cells spikes (Jackson et al., 2010). There can be different methods of analysis of the neural response, known as offline and online audiograms, in online analysis monitors the neural spikes and notes when the threshold criteria set is applied, in the offline method the neural train is recorded for each sound level and the data is analysed afterwards. The offline method has been shown to be more reliable than the online method as biases can be introduced through human error (Jackson et al., 2010). The current electrophysiology study used the offline analysis method to produce the audiograms (Chapter 5: Section 5.3.2).

2.5 Statistics

Statistical analysis of data was carried out using a number of different software programs including Minitab (Version 15) and also (IMB SPSS Statistics 20). The data was initially sorted and collated using Excel 2007 and then all the data sets investigated were firstly tested for normality and then either parametric or non-parametric tests were used depending on the results of the normality test, Townend, 2002, was referred to for choosing the appropriate statistical test and also for interpretation of the results. More details of the statistical tests and the results can be found in the results sections of the appropriate chapters.

2.6 LabVIEW Software

LabVIEW was used to write software for both data collection and also analysis where there was not another software program suitable as the amount of data could be very large. Dr's. James Windmill and Joe Jackson, wrote the majority of the programs which I am very grateful for. LabVIEW (**L**aboratory **V**irtual **I**nstrumentation **E**ngineering **W**orkbench; versions. 8.5.1 and also 2011; National Instruments, Austin, TX), and also a data acquisition card (National Instruments, BNC-2110 and USB-6251) were used. All the LabVIEW programs built throughout this thesis are shown in Appendix 1 and more detail on the role of the program in the appropriate chapter methods sections.

Chapter 3:
Laser Vibrometry of Insect Tympanal
Membranes

3.1 Introduction

Insect tympanal membranes, despite their small size and simple structure, have been found to be capable of very sophisticated sound processing. Using new techniques such as laser Doppler vibrometry it is now possible to record the mechanical vibrations of the membrane non-invasively to a very high resolution. This has provided a greater understanding of the functioning of the tympanal organs of many species of insect at the first stage of sound reception in the hearing organ. The aim of the current work was to investigate various insect species which differed in the reason for the hearing sense and also one species which had not previously been investigated with laser vibrometry. It is hypothesised that different species and orders of insect will differ in their membrane mechanics. In this chapter the membrane mechanics of locust, various moth species and also green lacewing tympanal organs are investigated and compared.

3.1.1 Laser Doppler vibrometry

Laser interferometry as a tool for characterising insect tympanal membrane motion has been used for some time. However, the resolution of the early technology was not very good, allowing only simple measurements to be carried out such as the displacement of the tympanal membrane of moths (Spangler and Takessian, 1983), locusts (Michelsen, 1971b) and bushcrickets (Michelsen and Larsen, 1978). With advances in technology the quality and accuracy of available laser vibrometry has increased and now displacements as small as 5 pm on an insect tympanal membrane can be detected (dependent on frequency). Also, the tympanal surface can be scanned, combining a number of points in order to observe the movement of the entire membrane surface. This new technology also allows a natural response to incoming sound to be measured, where before high sound levels were required to gain a large enough response to be recorded (Breckow and Sippel, 1985). It is also a non-invasive procedure, generally, with the animal alive and alert during the entire experiments.

Using both the scanning and single-point recording methods of the laser vibrometer a number of different species and also orders of insect were investigated in this current chapter. A number of different loudspeakers and ultrasonic transducers were used due to the insects investigated possessing diverse hearing capabilities in terms of frequency sensitivity, (see Chapter 3: Table 3.1 for an overview). The results of each species shall be discussed and compared. A brief description of the insect species and the morphology and functioning of the tympanal membrane investigated follows; Table 3.1 provides a summary of the hearing characteristics of the insects.

3.1.2 Locusts

Locust auditory organs are located on the first abdominal segment under the wing on either side of the insect. The organs consist of a tympanal membrane and the Müller's organ, the chordotonal organ, through which 60 - 80 scolopidia sensory cells are attached to the membrane (Michelsen, 1971a). The locust tympanal membrane has two distinct thicknesses separated by the folded body, which runs down the membrane (Gray, 1960). The receptor cells attach to different points on the membrane via the Müller's organ and are known to have different frequency sensitivities (Michelsen, 1971a) (Fig. 3.1). As the sound is received on the tympanal membrane its energy is funnelled to the receptor cells due to an intrinsic travelling wave that arises on the membrane due to sound reception. The receptor cells are frequency specific and depending on the stimulus frequency the sound related vibration is transferred to the specific attachment point (Windmill et al., 2005).

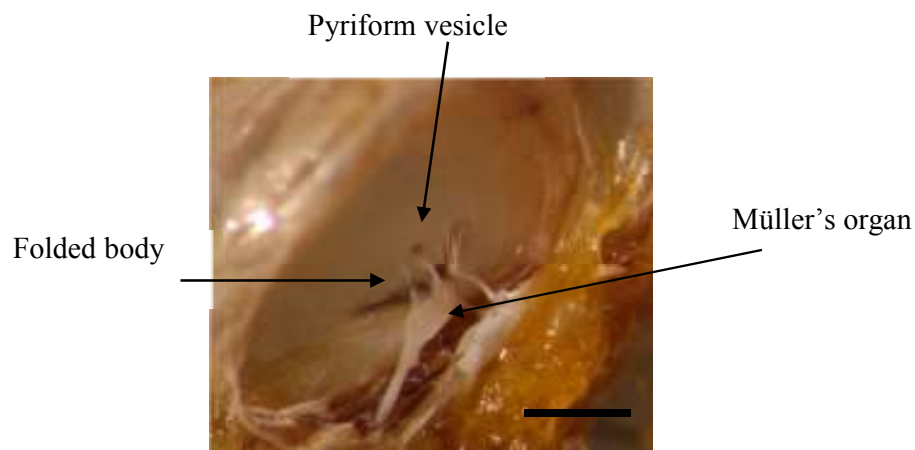

Figure 3.1 Internal view of the Muller's organ of *Schistocerca gregaria*, with the attachment points of the groups of the receptor cells (Photo taken by Dr. Shira Gordon). Scale bar = 0.5 mm.

Locusts use the hearing sense for intra-specific communication, where they communicate in mating rituals and also in aggression (Hoy et al., 1989). It has also been suggested that they can detect ultrasound and therefore use their hearing to avoid the predation of bats (Hoy et al., 1989; Robert, 1989; Miller and Surlykke, 2001). Both species used in this study, *Schistocerca gregaria* and *Locusta migratoria*, are known to have similar membrane characteristics (Windmill et al., 2005). A structural difference between the species is that *L. migratoria* have a cuticular flap that covers the lower part of the membrane.

3.1.3 Moth Tympanal Organs

The moth species studied are described in the following sections, divided into species

3.1.3i *Galleria mellonella*

Greater wax moths (*Galleria mellonella*) are of the family Pyralidae. All known hearing organs of Pyralid moths are on the first abdominal segment (Spangler, 1988a). The tympanal membrane of the moths has two distinct parts (Fig. 3.2), the membrane proper and the counter-tympanic membrane, with the attachment point of the receptor cells in the centre of the membrane proper (Mullen and Tsao, 1971a). Greater wax moths are also known to produce ultrasonic pulses; the males produce

sound using tymbals on the forewing attachment to attract mates. This sound has a peak frequency of 75 kHz (Spangler, 1986a). The moths are also known to show evasive behaviour to bat calls (Spangler, 1984b). There are four auditory cells A1-A4 and the non-auditory B cell; the previous known hearing range was 20 – 120 kHz (see Chapter 5), with the best response of the tympanal organ at the male calling frequency (Skals and Surlykke, 2000).

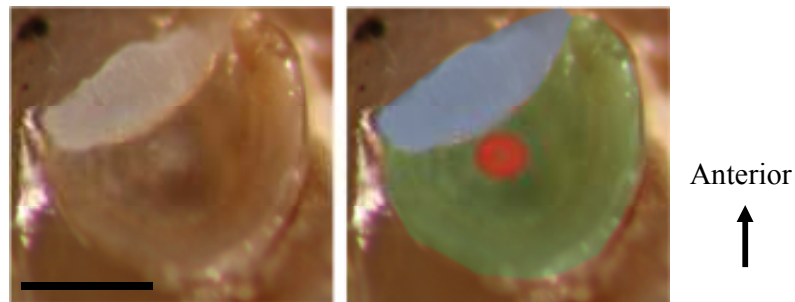

Figure 3.2 The tympanal membrane of the greater wax moth, *Galleria mellonella*. The paired tympanal organs are found on the first abdominal segment. The main areas of the membrane have been highlighted on the right side; the receptor cell attachment point is highlighted in red, with the membrane proper in green and the counter-tympanic membrane in blue. Scale bar = 0.25 mm.

3.1.4ii *Plodia interpunctella*

The Indian meal moth (*Plodia interpunctella*) is also from the family Pyralidae. The paired tympanal membranes are located on the first abdominal segment and have a similar structure to those of the greater wax moth (Mullen and Tsao, 1971b) (Fig. 3.3b). The tympanal organs are backed by only one air filled cavity (Mullen and Tsao, 1971b), in comparison to the three found in noctuid moths (Roeder and Treat, 1959). Little is known of the functioning of the auditory organ. No electrophysiology has been carried out as the moth is of such a small body size. The size of the membrane was measured using a microscope and camera with a scale microscopy slide (Fig. 3.3f); the approximate measurements of the membrane were 0.045 mm by 0.05 mm.

The male moths are known to produce sound for intra-specific communication; the sound is produced from a tymbal situated in front of the tegulae, similar to greater wax moth sound production. The sound has a frequency range between 50-70 kHz with a pulse interval of 14 -18 ms (Trematerra and Pavan, 1995). The moths are also shown to stop mating behaviour in response to bat like calls being played between frequencies of 40-50 kHz, suggesting that the frequency sensitivity range is between 40-70 kHz, encompassing both bat and males calls (Trematerra and Pavan, 1995). In the current study 15 individuals were investigated, n = 7 males and n = 8 females.

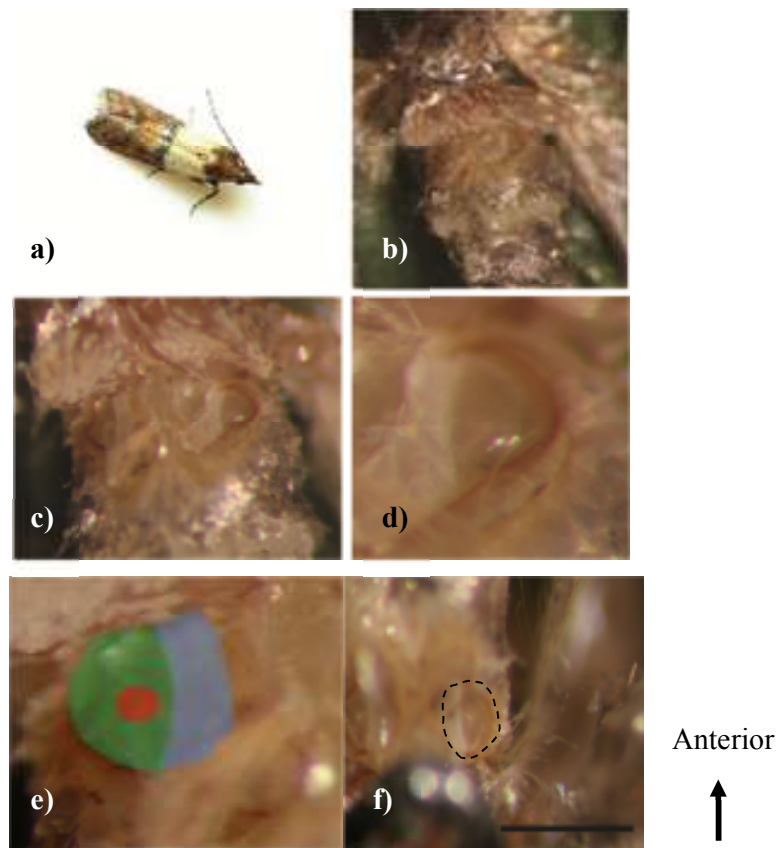

Figure 3.3 Tympanal membrane photographs of Indian Meal Moths, *Plodia interpunctella*, **a)** shows an adult moth. The tympanal organs are located on the first abdominal segment. **b)** the abdomen of the Indian meal moth with the metathoracic segment held back, showing the location of the tympanal membranes. **c)** and **d)** show the tympanal organ close up and **e)** shows how the membrane is structured, similarly to the greater wax moth which is a Pyralidae moth, with a membrane proper, the counter-tympanic membrane and the attachment point which is the opaque region near the centre of the membrane proper. The structure has been given the same colour coding, red: receptor cell attachment point, green: membrane proper and blue: counter-tympanic membrane. Scale photograph of the tympanal membrane, highlighted in a dashed line **f)**, where the scale bar is 0.1 mm. The orientation of the animal is shown apart from **a)**.

3.1.3iii *Ostrinia nubilalis*

The European corn borer moth (*Ostrinia nubilalis*) of the Crambidae family, have paired tympanal organs on the first abdominal segment (Agee, 1969) (Fig. 3.4). The moths are known to produce quiet courtship calls, the sound level is 46 dB SPL at 1 cm and has frequencies between 30 - 60 kHz (Takanashi et al., 2010). The ear was found to have two auditory receptor cells which had a threshold difference of 20 dB SPL, and a frequency sensitivity range between 14 – 100 kHz (Agee, 1969). A more recent study of the electrophysiology of the tympanal nerve confirmed this and from the best frequency was found to be between 40 – 45 kHz at 38 dB SPL, there was no difference between the sexes (Takanashi et al., 2010). In the current laser vibrometry study, 4 individuals were investigated, n = 2 males and n = 2 females.

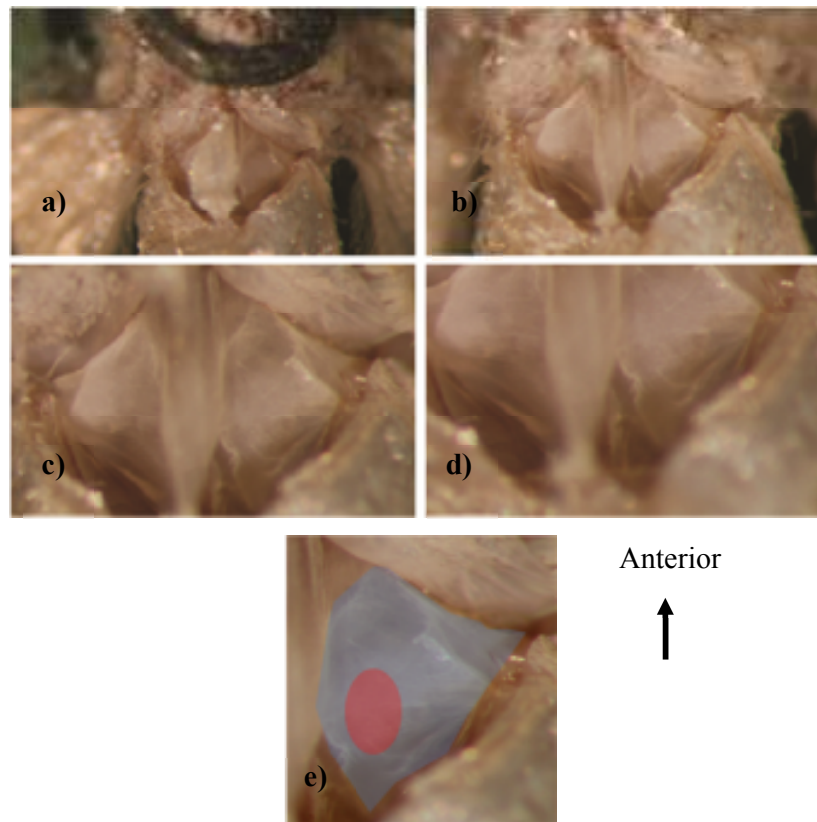

Figure 3.4 The tympanal membrane of *Ostrinia nubilalis*, the European corn borer moth. **a) - d)** shows the location and close up views of the membrane. Dividing the membranes was a thin piece of cuticle this was covered with scales as can be seen in **a)**, these were carefully removed so as to not obstruct the membrane. **e)** shows area of the membrane highlighted in blue with the approximate receptor cell attachment area in red.

3.1.5 Lacewings

Green lacewings (*Chrysopa carnea*) were first noticed to respond evasively to bat echolocation calls (Roeder, 1962) and it was derived from this observed behaviour that there may be an ultrasonic hearing organ. The tympanal hearing organ was discovered to be located on a wing vein (Miller and Macleod, 1966) (Fig. 3.5). Electrophysiological studies found that the hearing organ was sensitive to frequencies of 13 – 120 kHz, with the best sensitivity found to be between 30 – 60

kHz (Miller, 1971). The hearing organ structure is unusual in that the swelling behind the membrane is fluid filled in comparison to most insect tympanums which are air filled. It is not known why the organ is fluid filled and what function this provides. The surface of the membrane is known to have ripples, although it is not understood why this is the case as most other insect membranes are taut and smooth, although this may relate to it being fluid filled, and could indicate that the mechanics may differ. Unfortunately due to rearing difficulties described elsewhere only 2 individuals survived to adulthood and could be used for experimentation. One individual's results are shown in the results section.

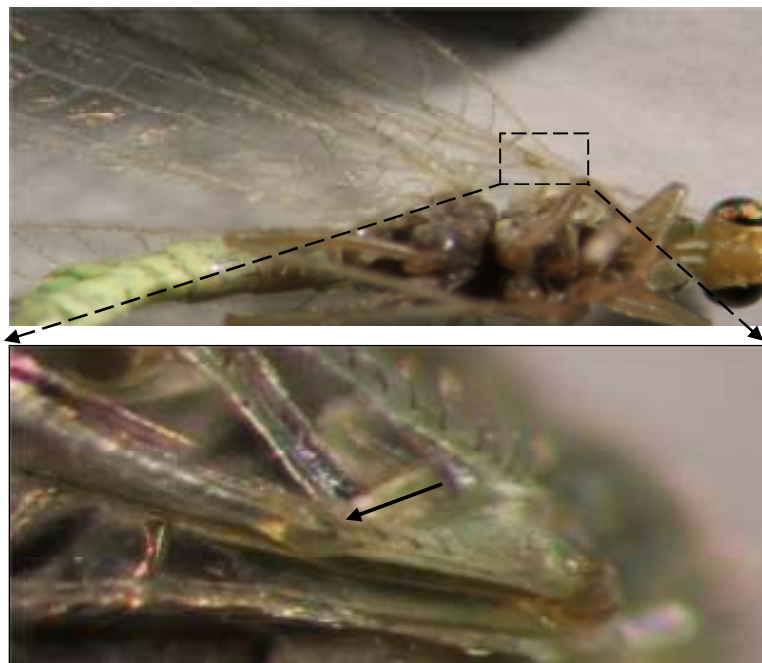

Figure 3.5 The location of the tympanal organ of a green lacewing on a wing vein and a second picture zoomed into the area of the tympanal membrane area on the vein. The small swelling is the bulla more clearly visible in lower photograph which shows the area in the dashed box magnified, an arrow highlights the hearing organ.

Species	Number of Scolopidia per ear	Reason for Hearing	Size of membrane	Frequency range	Best Frequency
Locusts (<i>Schistocerca gregaria</i> and <i>Locusta migratoria</i>)	60-80, Michelsen, 1971a	Bat detection and intra-specific communication, Miller and Surlykke, 2001	2.5 x 1.5 mm Michelsen, 1971a	1 – 40 kHz Michelsen, 1971a	a cells = 3.7 kHz b cells = 3.5 kHz c cells = 1.5, 2-3 and 8 kHz d cells = 12 kHz Michelsen, 1971a
Moths <i>Galleria mellonella</i>	4, Skals and Surlykke, 2000	Bat detection and intra-specific communication, Spangler, 1985	0.55 x 0.28 mm- males 0.65 x 0.35 mm- females Spangler and Takessian, 1983	20-300 kHz, - see Ch. 5	70-90 kHz (male calls frequency) Skals and Surlykke, 2000
<i>Plodia interpunctella</i>	? (Probably 4 as Pyalidae)	Intra-specific communication, probably also bat detection – Trematerra and Pavan, 1995	Approximately 0.045 mm by 0.05 mm – from scale photograph, Fig. 4.3f	40-70 kHz, Trematerra and Pavan, 1995	?- see discussion
<i>Ostrinia nubilalis</i>	2, Agee, 1969	Bat detection, Agee, 1969 and intra-specific communication, Takanashi et al., 2010	?	< 20-120 kHz – Agee, 1969	40-45 kHz – male calling – Takanashi et al., 2010
Green Lacewings (<i>Chrysopa carnea</i>)	28, Miller, 1971	Bat detection, Miller – 1966	0.6 mm, area of 0.02 mm ² Miller, 1970	13-120 kHz, Miller, 1971	30-70 kHz, Miller, 1975 – bats

Table 3.1 Overview of the insect species investigated in this chapter and their hearing capabilities.

3.2 Materials and Methods

All laser vibrometry experiments were carried out in the same laboratory. The restrained animal was placed on a custom made metal stand in front of the vibrometer's close-up head. The stand with the holder and the animal was moved so that the video feedback on the laser vibrometer computer system was in focus and in line with the tympanal organ. This allowed a constant check that the laser beam was directed to the correct part of the membrane at all times. The sound pressure level was measured using a calibrated microphone coupled to a preamplifier (Brüel and Kjær, Microphone: 4138, Preamplifier: Nexus 2690; Nærum, Denmark). The microphone was secured in the holder, and could be adjusted so that it was as close to the tympanal organ as possible. The vibration and displacements of the tympanal membrane were recorded using a micro-scanning laser Doppler vibrometer (Polytec PSV-300-F; Waldbronn, Germany) using a close up attachment head attached to the OFV-056 scanning head. Singular frequency sine waves were created using a function generator (Tektronix, Dual Channel-AFG 3102).

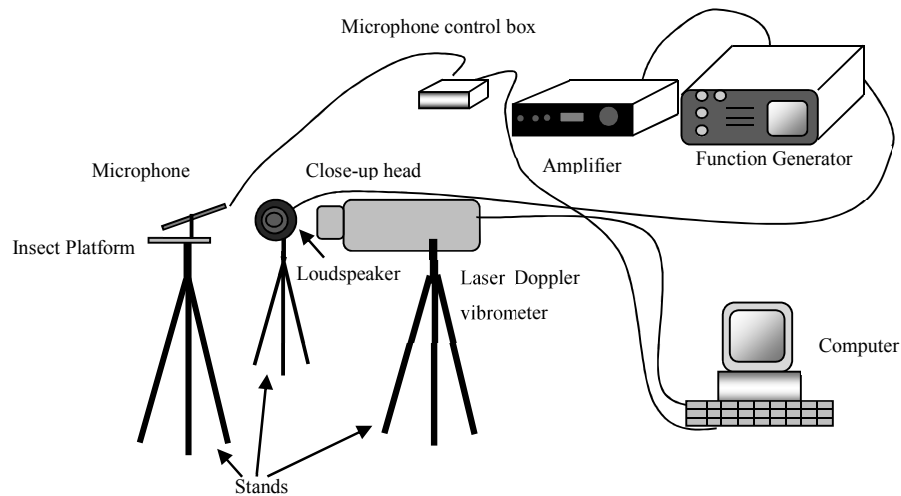

Figure 3.6 General set up of the experimental equipment used in the insect tympanal membrane mechanical investigations.

Different loudspeakers and acoustic transducers were used for their different frequency capabilities (see Chapter 2: Section 2.2.3). The sounds applied were either a single frequency sine wave or a periodic chirp using a function generator. The vibrometer software could also be used to create periodic chirps or single-frequency sine waves.

3.3 Results

The laser vibrometer scan videos of the various species from this chapter can be found on the flash disk included.

3.3.1 *Locust results*

The mechanics of the locust tympanum have been previously documented, (Windmill et al., 2005; Windmill et al., 2007). New laser vibrometry scans of the locust tympanum are included here for completeness and also as an introduction for Chapter 4.

3.3.1*i* *Schistocerca gregaria* and *Locusta migratoria*

The different groups of receptor cells attach to different points on the membrane, with the lower frequencies being funnelled to parts of the folded depending on frequency (Fig. 3.7a), whereas the higher frequencies are funnelled towards the pyriform vesicle (Fig. 3.7b). The travelling wave is known to be unidirectional and no backward movement of the wave is ever seen (Windmill et al., 2008). The membrane mechanics of the locusts are passive, as it was found in dead locusts (Windmill et al., 2005). The travelling wave is also found on the membrane for the other locust investigated, *Locusta migratoria*, although the folded is not fully visible at all points due to the cuticular flap on the scan shown and therefore the membrane behaviour of a higher frequency tone is shown, the travelling wave funneling to the pyriform vesicle (Fig. 3.7c).

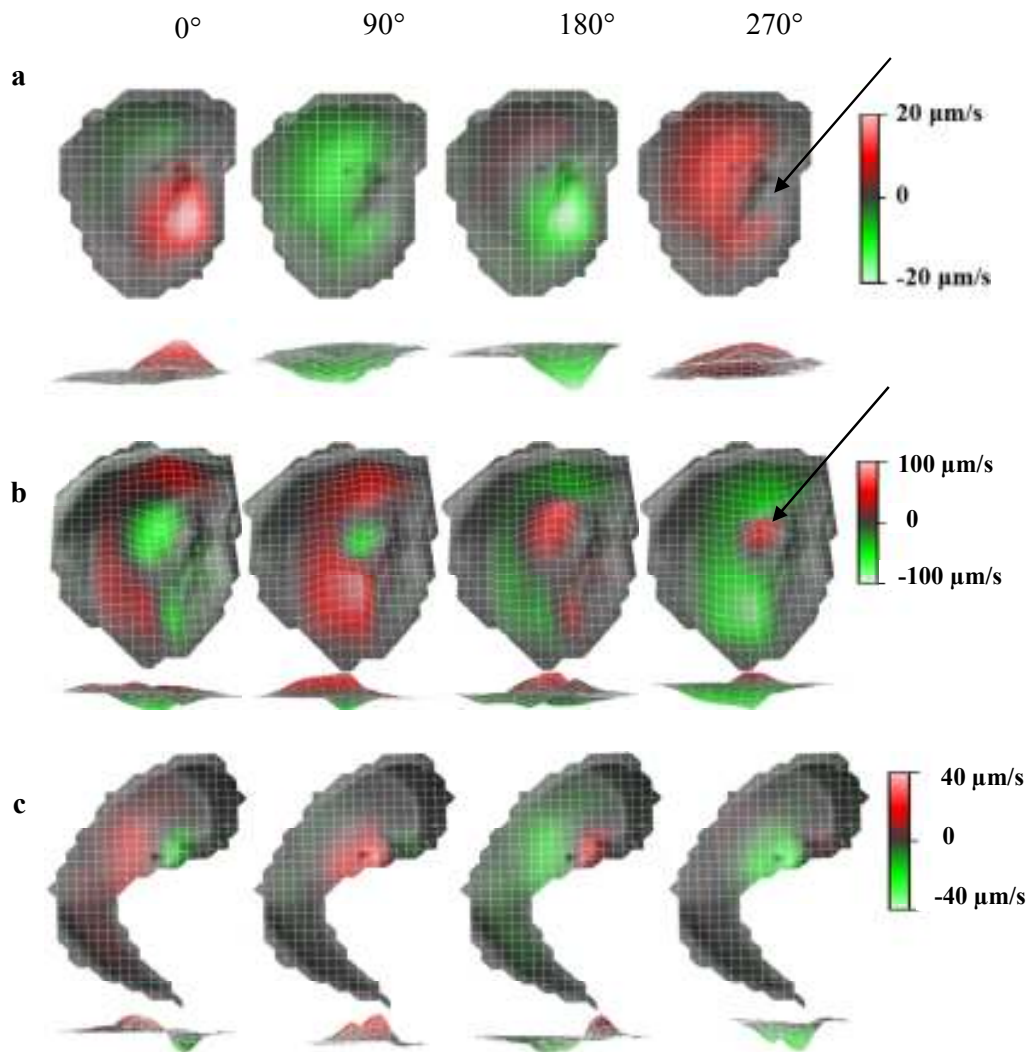

Figure 3.7 Laser vibrometry scans of *S. gregaria* and *L. migratoria*, showing the intrinsic travelling wave on the membrane. *S. gregaria* **a)** the sound stimulus was 3 kHz and the sound is funnelled to the folded body highlighted with an arrow and **b)** at 12 kHz showing the sound travelling to the pyriform vesicle also highlighted with an arrow. **c)** Laser vibrometry scan of *Locusta migratoria*, this species have a cuticular flap covering part of the membrane, the sound stimulus is 12 kHz and the sound is funnelled to the pyriform vesicle. All the units are in velocity ($\mu\text{m/s}$) where an outward deflection is shown in red and an inward as green. Four different phases of the oscillation cycle are shown as well as the side on view of the membrane below.

3.3.2 *Galleria mellonella* results

3.3.2i Laser scans

The results of the laser scans of the greater wax moth find similar mechanics to previously found results of the closely related lesser wax moth (Rodriguez et al., 2005), where at low frequencies the two parts of the membrane move out of phase with one another (Fig. 3.8a), and at higher frequencies the counter-tympanic membrane deflections are reduced and the receptor cell attachment point, roughly in the middle of the membrane, only is displaced (Fig. 3.8b). The membrane displacements are maximal around the male calling frequency for both sexes (Chapter 5, Fig. 5.12).

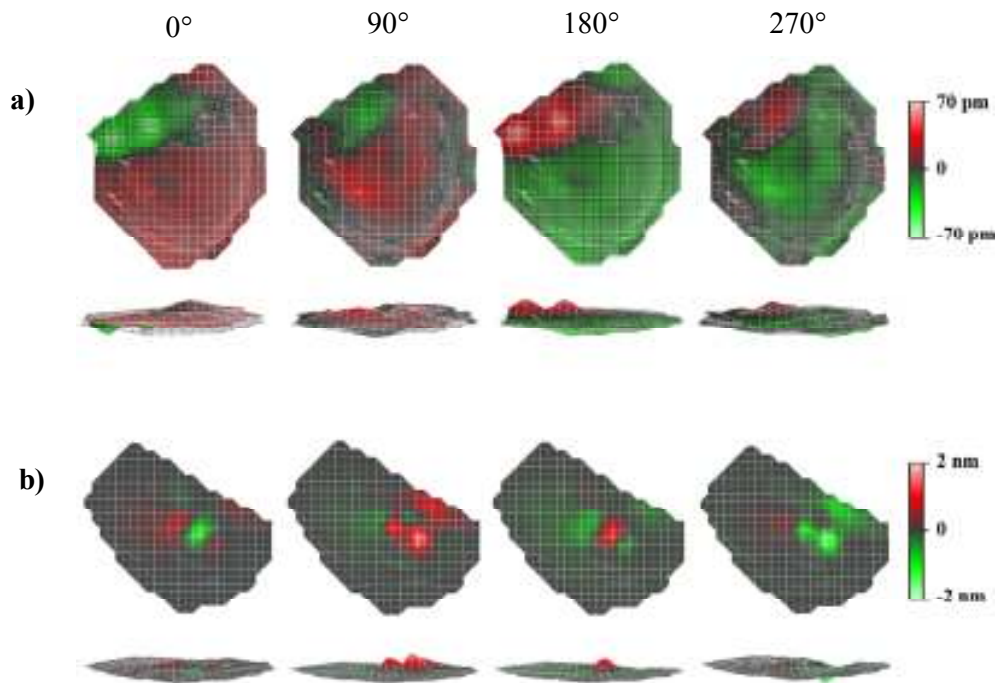

Figure 3.8 **a)** shows the deflections of the membrane of a greater wax moth when the tone applied was a 40 kHz pure frequency sound, the two parts of the membrane move out of phase with each other. **b)** shows the membrane behaviour at around the frequency of the male courtship calls of 80 kHz, the point of attachment of the receptor cells are displaced maximally at a value of 2 nm. Both part of the figure show the oscillation of the membrane over 4 phases of the oscillation cycle and also show the side on view of the membrane underneath.

3.3.2ii Transect graphs

The behaviour of the mechanics were investigated across a transect line of the membrane, this was done using the PSV (Polytec Scanning Vibrometer) software, known as a profile, the line was selected through the maximum point of deflection, the receptor cell attachment point (Fig. 3.9a). This was the same as the method previously used to investigate the mechanics of the locust tympanum (Windmill et al., 2008). The results gave a different view of the membrane behaviour but essentially confirmed what has already been discussed for the previous laser scans (Fig. 3.8). At lower frequencies the counter-tympanic membrane is also deflected along with the receptor cells, but as the frequency of the sound increase the deflections of the counter-tympanic membrane decrease. However at all frequencies the receptor cell attachment has the maximum membrane (Fig. 3.9b-d).

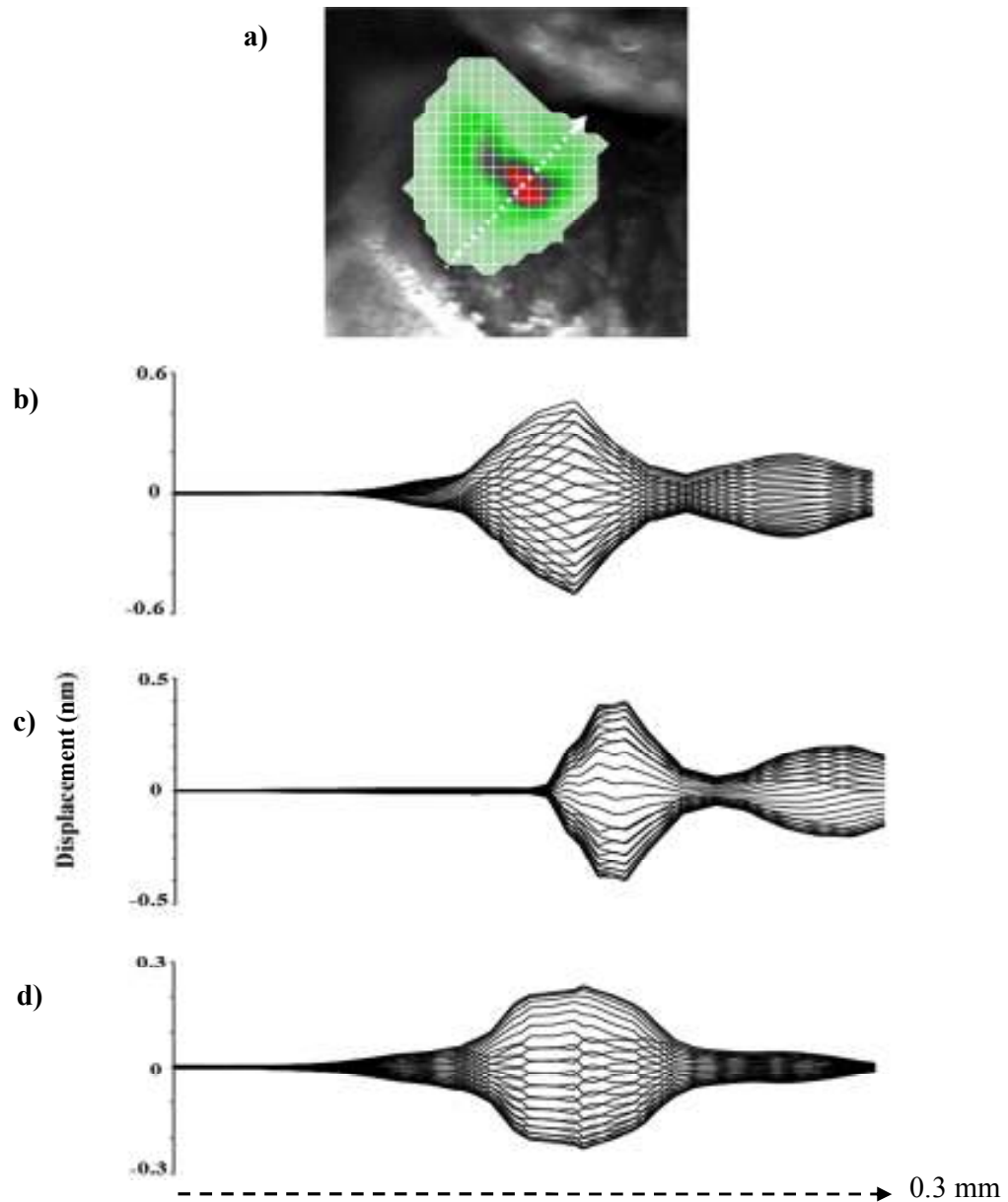

Figure 3.9 Shows the behaviour of the membrane of an individual *G. mellonella* across a selected transect line shown in **a**). The displacement in nanometres (nm) across this line of the membrane is shown for different frequencies investigated, **b**) 30 kHz, **c**) 80 kHz and **d**) 200 kHz, for different phases between -150° to $+150^{\circ}$ combined. The results show that the attachment point in the centre of the membrane moves maximally at all frequencies with the counter-tympanic membrane moving less as the frequency increases.

3.3.2iii Tuning curves

In a species of Noctuid, *Noctua pronuba*, evidence of up tuning has been shown, this is where at low sound level, 20 dB SPL, the membrane displacements are maximal at 40 kHz, but at higher sound level, 55 dB SPL, the membrane ‘tunes up’ to have maximal membrane displacements at 70-80 kHz. This change in membrane sensitivity, believed to be related to predation risk, disappeared if the animal was dead (Windmill et al., 2006). The greater wax moth was also investigated to see if they also possess this phenomenon. A periodic chirp between frequencies of 50-300 kHz was applied at a low sound level and then at a higher sound level, controlled by the voltage applied to the transducer, approximately 50 dB SPL at low levels and 90 dB SPL at high levels, although this cannot be measured accurately with the microphone, partly due to the frequencies applied and also due to the microphone measurements not being accurate over a range of frequencies. These sound levels were applied whilst scanning the receptor cell attachment point. The frequency spectrum in displacement is plotted; however no evidence of ‘up-tuning’ was seen in this species of moth with the frequency curves at both sound levels being similar apart from the difference in the curve at around 260 kHz, the reason for this is not known as little is known of the use of the hearing sense at these frequencies (Fig. 3.10).

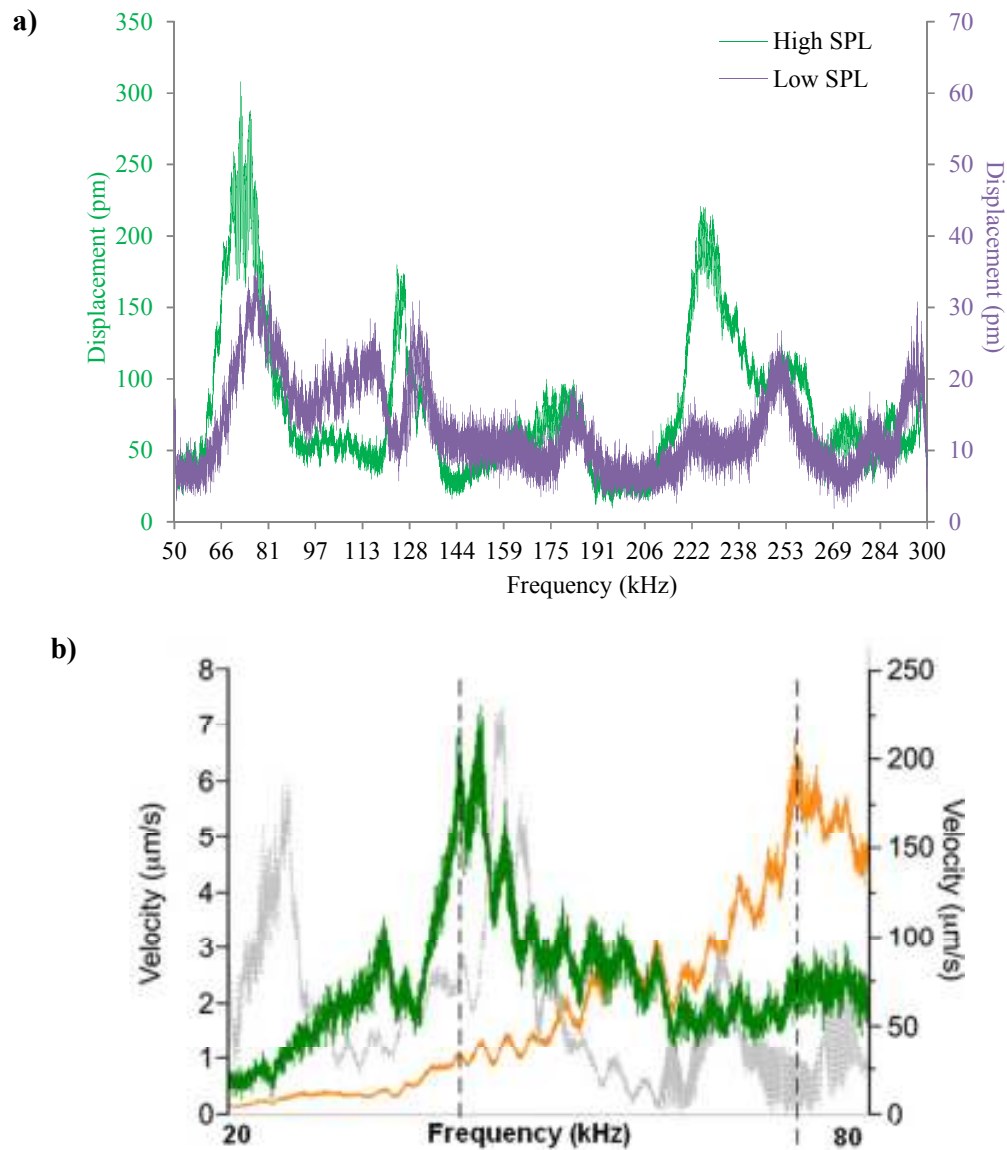

Figure 3.10 a) Displacement of the receptor cells attachment point of a greater wax moth between 50-300 kHz at a low and high sound pressure levels. Green represents the displacement at the higher sound level, the left axis and purple is the membrane displacement over low sound pressure levels, right axis. There is no up-tuning at higher sound pressure levels as was found for another moth species (Windmill et al., 2006). **b)** taken from Windmill et al, 2006, shows the up-tuning of the results from a species of Noctuid moth. Where the green line is when the sound intensity is low and orange where the sound intensity is high, the grey trace shows the mechanics of the tympanum from a dead moth.

3.3.3 *Plodia interpunctella* results

3.3.3i Laser scans

The membrane displacement plotted over a frequency spectrum show that the membrane displacement is maximal between frequencies 70-90 kHz (Fig. 3.11), this is slightly higher than the previously recorded male call of 50 -70 kHz (Trematerra and Pavan, 1995). The results of the scans of the laser vibrometer show that the membrane mechanics for *Plodia interpunctella* were found to be similar to the greater wax moth (Section 3.3.2i). The laser scans also show a bigger displacement at 90 kHz than at 60 kHz, and the area that is displaced is also more coherent suggesting that the moth hearing is tuned higher than the recorded male call. The receptor cell attachment point is the largest point of deflection of the membrane at the frequencies tested (Fig. 3.12). The membrane is of a very similar structure as the greater wax moth and so this is not surprising (Fig. 3.3).

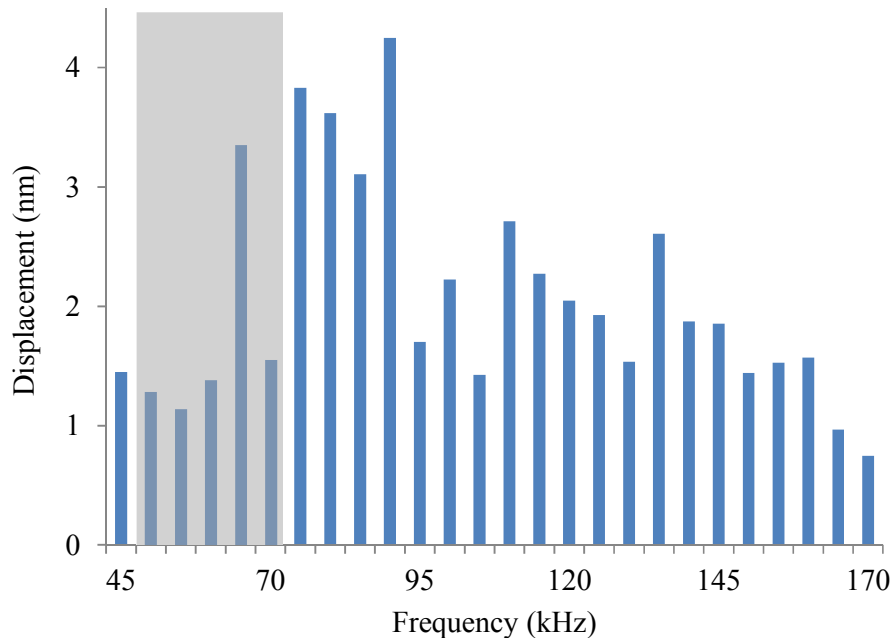

Figure 3.11 Shows the measured displacement of an individual male Indian meal moth at frequencies between 45-170 kHz, showing that the maximum displacement of the membrane does not occur around the sound of the male call, highlighted in grey but appears to be around 75 – 90 kHz. The sound level at all frequencies was 90 dB SPL.

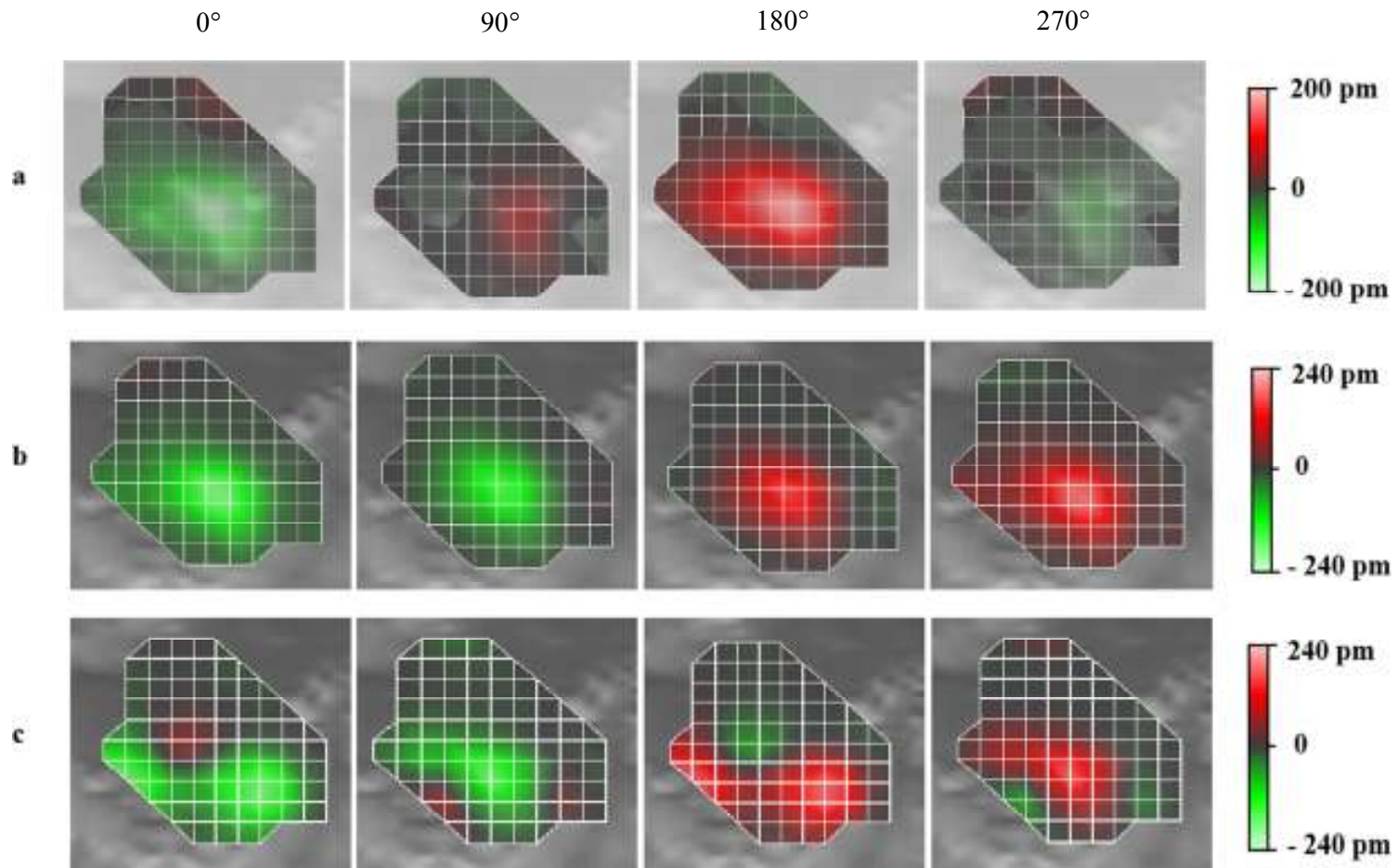

Figure 3.12 The laser scan results of the Indian meal moth, over 3 different frequencies: **a)** 60 kHz, **b)** 90 kHz and **c)** 140 kHz. The displacements are in picometres (pm) are shown for four different phases of the oscillation cycle. The sound levels of the scans were all at 90 dB SPL.

3.3.3ii Transect graphs

The membrane mechanics of the Indian meal moth were also investigated across a transect line of the membrane as has previously been described (Section 3.3.2iii); this was repeated over a number of different frequencies. The results confirmed the laser scans, the membrane moved maximally at the point of the receptor cell attachment point (Fig. 3.13).

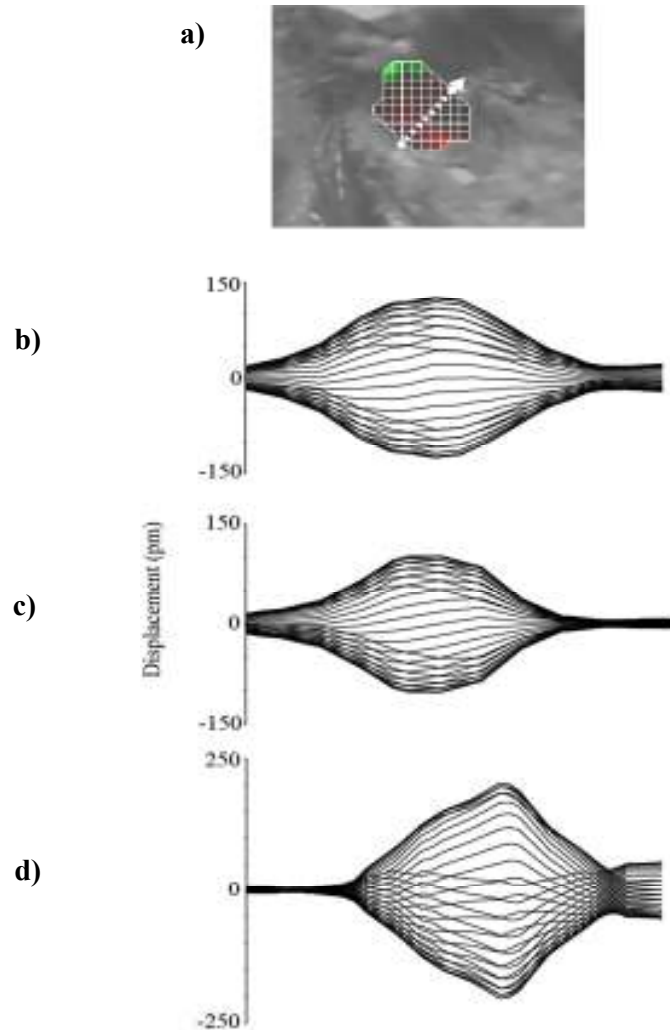

Figure 3.13 Shows the displacement of the membrane across the membrane of the line shown in **a)** at different frequencies of: **a)** 35 kHz, **b)** 90 kHz and **c)** 140 kHz. The sound level used for **c)** was 80 dB SPL and for **c)** and **d)** it was 90 dB SPL. The membrane is found to have a large area of deflection over the transect line measured at all frequencies shown.

3.3.3iii Tuning curve graphs

Membrane up-tuning was also investigated in the Indian meal moth, as was described in Section 3.3.3iii. However, as was found for the greater wax moth there was no evidence of up-tuning seen in this moth (Fig. 3.14). As both these moths are from the family Pyralidae, and not the Noctuidae where the up-tuning was seen previously (Windmill et al., 2006), this may be the explanation for the different result, due to the different uses of hearing between the groups of moths as Noctuids hearing sense is solely for bat detection (Spangler, 1988a). The displacement curve does however reflect the results previously found Section 3.3.3i, in that the largest displacement occurs between frequencies of 90-100 kHz, highlighted in grey on the graph (Fig. 3.14).

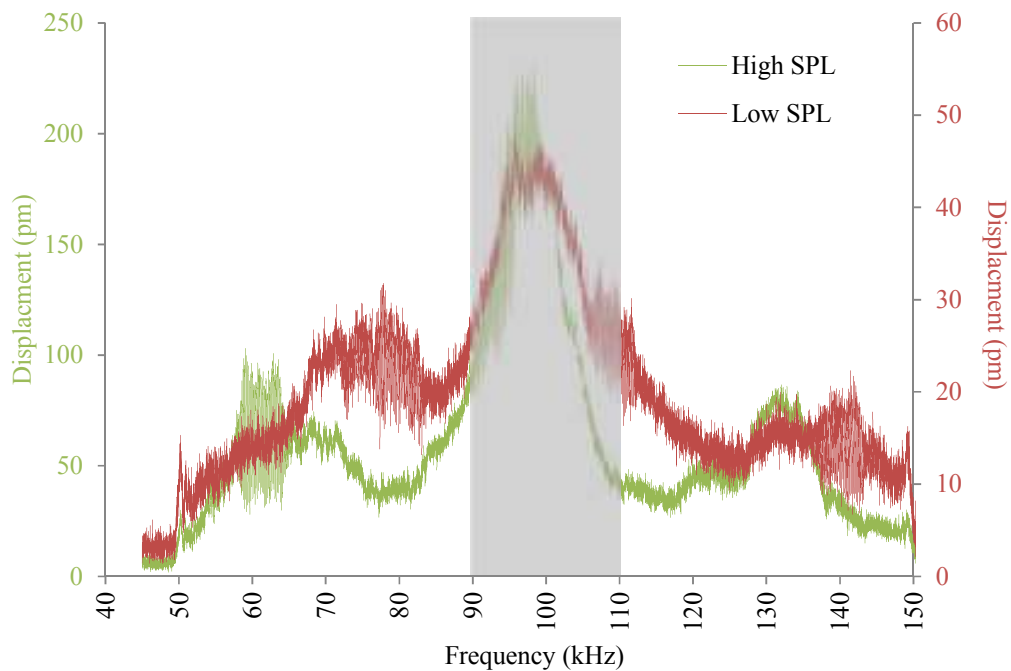

Figure 3.14 Displacement of the receptor cells attachment point of an Indian meal moth between 50-300 kHz at a low (red) and high (green) sound pressure levels. There is no up-tuning at higher sound pressure levels. The maximal displacement occurs at frequencies of 90-110 kHz, highlighted in grey.

3.3.4 *Ostrinia nubilalis* results

3.3.4i *Laser scans*

Much has been discovered recently of the sounds these moths and other very closely related species produce for courtship calls (Nakano et al., 2008; Nakano et al., 2009a; Nakano et al., 2009b; Takanashi et al., 2010). However the tympanal membrane mechanics of the moth or the other species have not been investigated before using laser vibrometry. The structure of the membrane is not as well described as for some other moth species, the membranes are two oval shaped, spaced closely together on the first abdominal segment (Fig. 3.4). The tympanal membranes were scanned as for the other moth species previously described, at various frequencies and sound levels. From the scan data the membrane mechanics could not be clearly defined as the results were not what was expected, the membrane moved maximally at frequencies lower, around 20 kHz (Fig. 3.15), than what is thought to be produced by the calls for courtship, between 40-45 kHz, (Nakano et al., 2008). The membrane mechanics were found to move maximally at the lower end on the inner side of the membrane (Fig 3.16), and from this it would be the most likely point of attachment of the receptor cells.

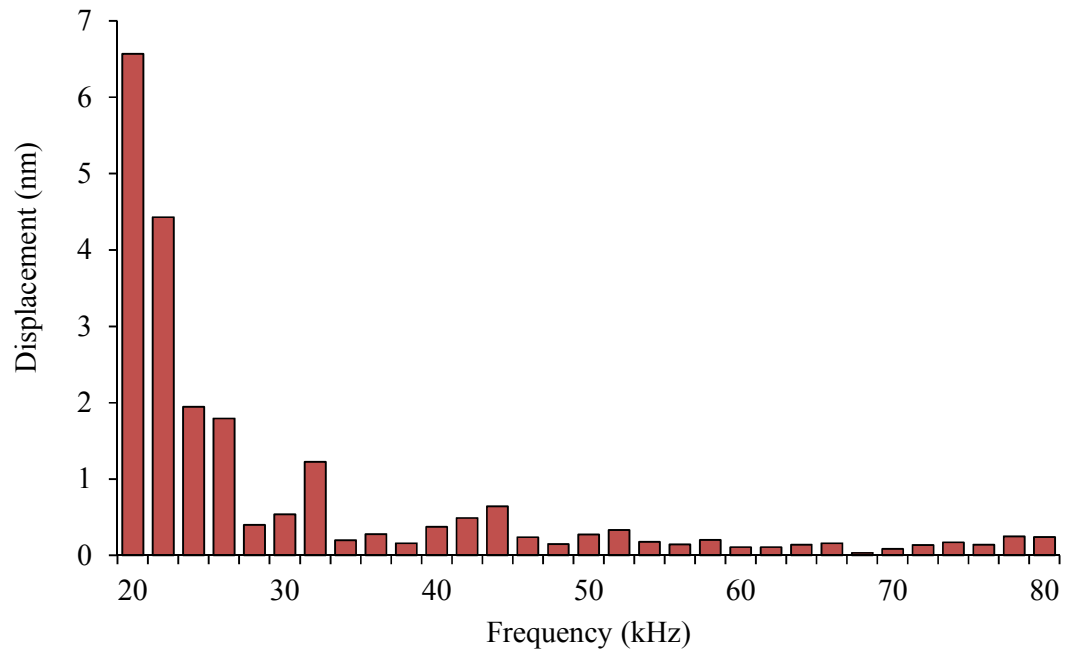

Figure 3.15 Displacement of the tympanal membrane of an individual European corn borer moth when sound pressure level is 80 dB SPL, the displacement of the maximal point of deflection of the scans is shown between 20 – 80 kHz.

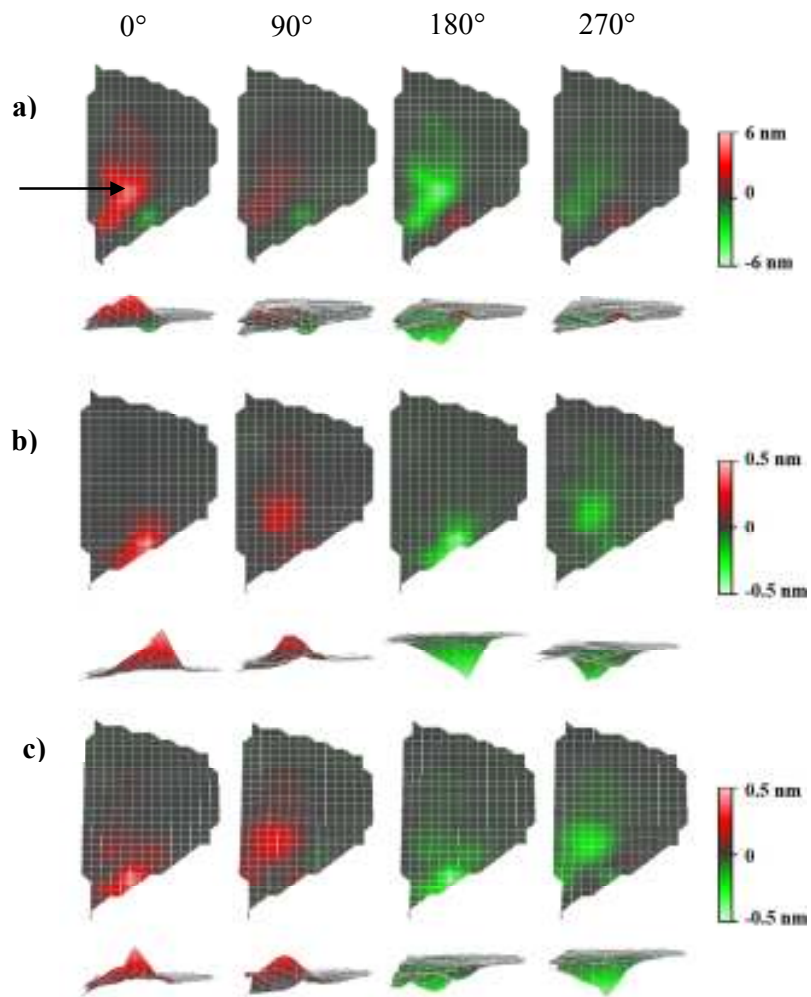

Figure 3.16 Shows the results of the laser vibrometry scans of a European corn borer moth. The frequencies tested were **a)** 20 kHz, **b)** 40 kHz and **c)** 80 kHz, at all frequencies shown the sound level was 80 dB SPL. The membrane movement is shown over four phases of the oscillation cycle and the lower part shows the side on view of the membrane at each phase. The maximal displacement is on the inner side of the membrane highlighted with an arrow in **a)**.

3.3.4ii Transect graphs

The membrane mechanics using transects across the membrane was investigated at different frequencies, 20, 40 and 80 kHz. The area of maximal displacement from the laser scan results (Fig 3.16) was the point through which the line was set in both the horizontal and vertical planes. From the graphs it can be seen that the displacement occurs over quite a large area of the membrane in both planes (Fig. 3.17). The nature of the attachment of the receptor cells is not known however and so the reason for this large area of displacement is unclear. The laser scan data showed that the membrane was maximally displaced at 20 kHz for that individual moth (Fig. 3.15), however the transect lines shown for another moth show that the membrane mechanics are marginally larger at 40 kHz than at 20 kHz and also the area of displacement is smaller (Fig 3.17).

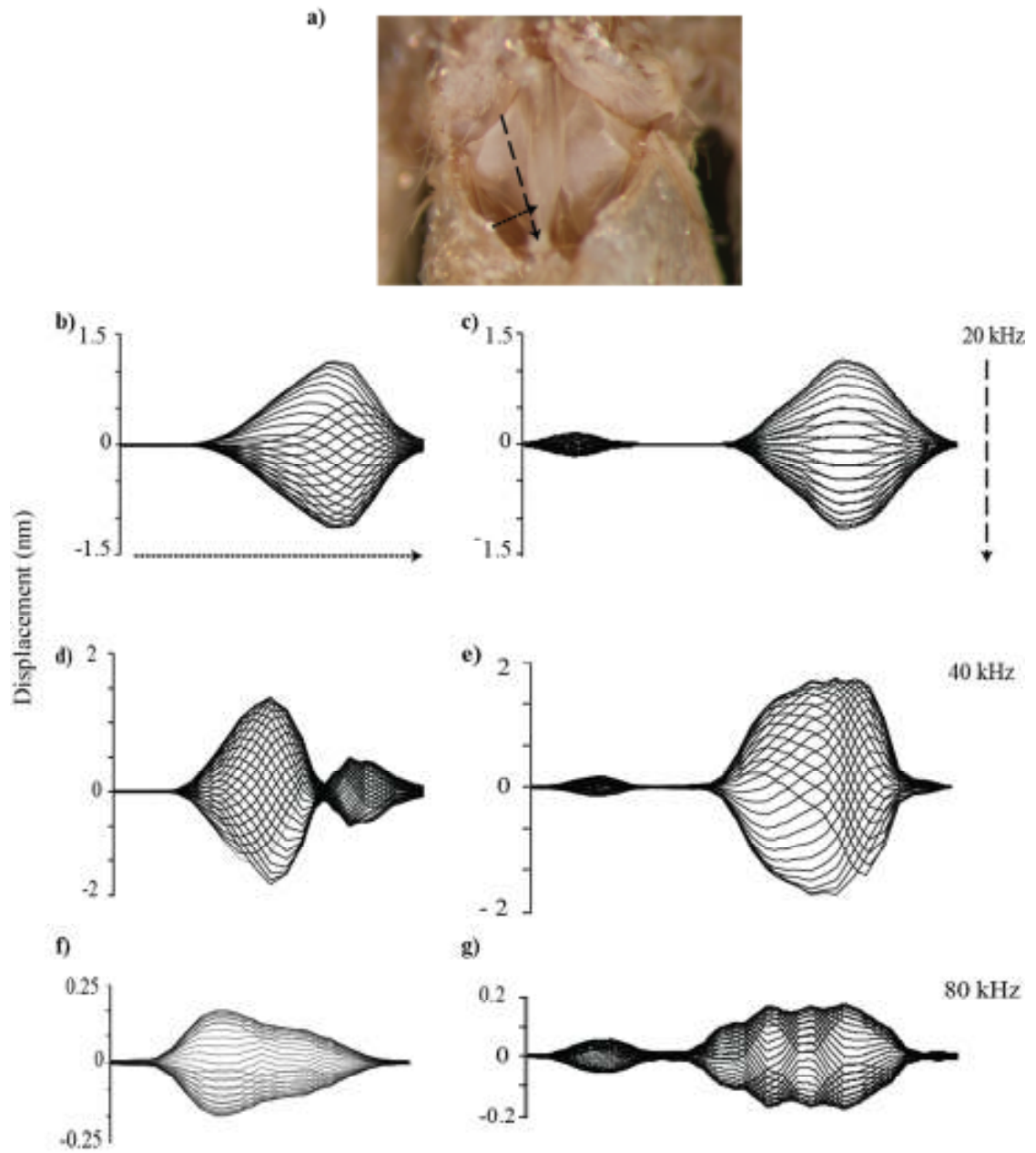

Figure 3.17 a) the tympanal membranes of the European corn borer moth, showing the transect lines chosen across the membrane. b) is the horizontal transect at 20 kHz and c) is the vertical result. d) and e) is the horizontal and vertical transect line at 40 kHz and f) and g) at 80 kHz. The sound level was at 80 dB SPL for all frequencies shown.

3.3.5 Green Lacewing results

3.3.5i Laser scans

The tympanal membrane of the green lacewing has not been investigated using laser vibrometry before. The attachment point of the receptor cells was not clear and therefore a large area of the wing vein of the lacewings investigated was selected to be scanned. The results showed that at the peak frequency of the bat echolocation calls, the reason why lacewings primarily hear is sharply tuned to this range of frequencies. The laser scans suggests that the receptor cells are attached at one point on the membrane (Fig. 3.18b, highlighted with an arrow). At other frequencies investigated the membrane surface was found to vibrate at all points scanned and there was not a coherent point of deflection (Fig. 3.18a and c).

3.3.5ii Transect graphs

As the mechanics of the green lacewing had not been previously investigated transect graphs of both horizontal and vertical directions (Fig. 3.19a) were plotted at various frequencies, through the point of maximal displacement found through the scan data (Fig. 3.18). The results of these graphs confirm that the membrane moves at one distinct point, most likely the receptor cell attachment point, in both directions at the best frequency, around 40-50 kHz (Miller, 1971), the surrounding area does not move as much (Fig. 3.19c and d). At the other frequency shown, 20 kHz all parts of the membrane move across the vertical line (Fig. 3.19b).

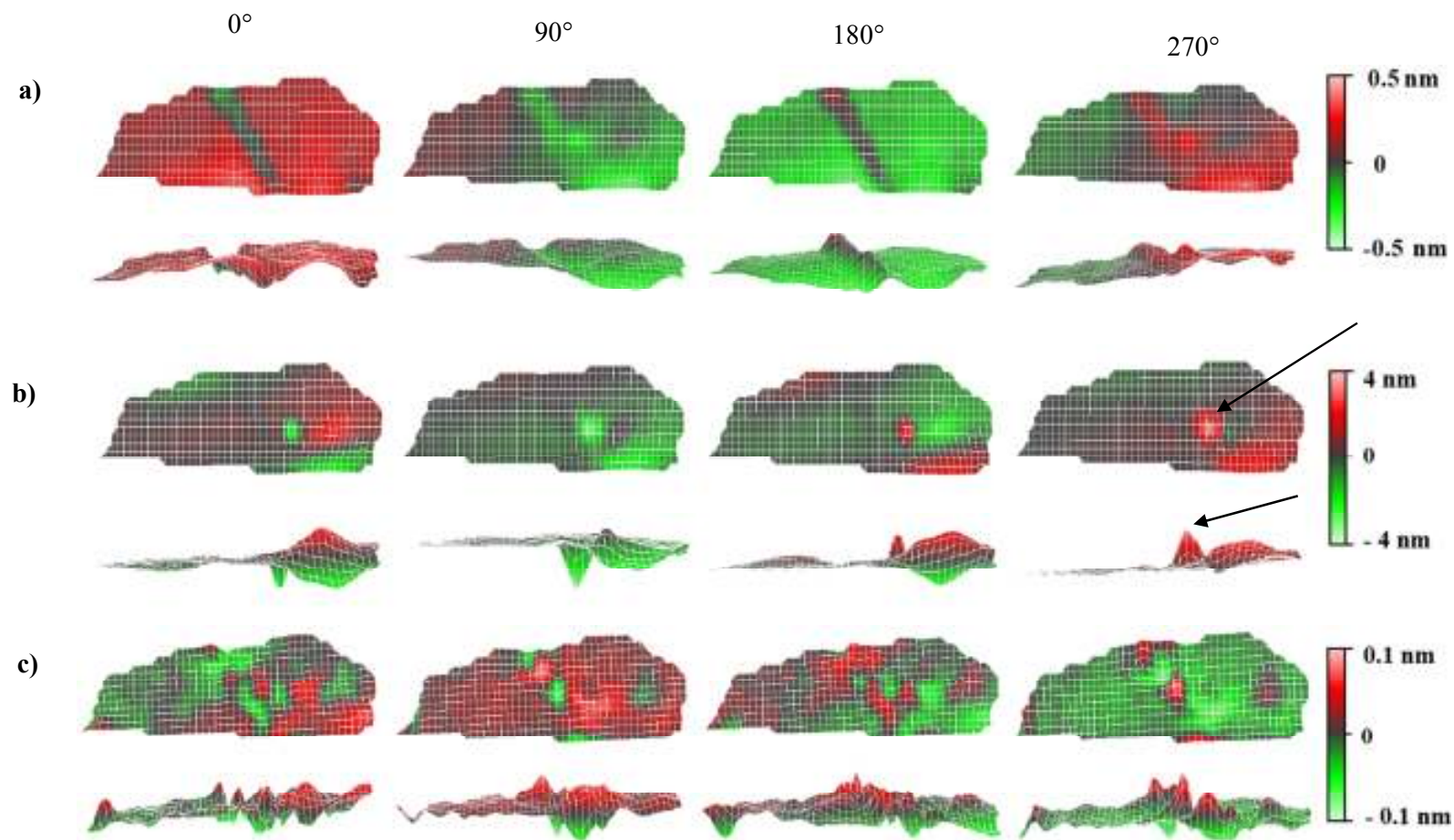

Figure 3.18 Laser vibrometry scans of a lacewing wing vein, the site of the tympanal organ. The frequencies tested were: **a)** 20 kHz, **b)** 50 kHz and **c)** 110 kHz. The scans shown are four different phases of the oscillation cycle and also the side on view of the membrane. The results of the scans found that the membrane is sharply tuned to the frequencies produced by bat echolocation calls **b)**, the possible receptor cell attachment point highlighted with an arrow, whereas at other frequencies the entire area scanned of the membrane is also displaced at the same level **a)** and **c)**.

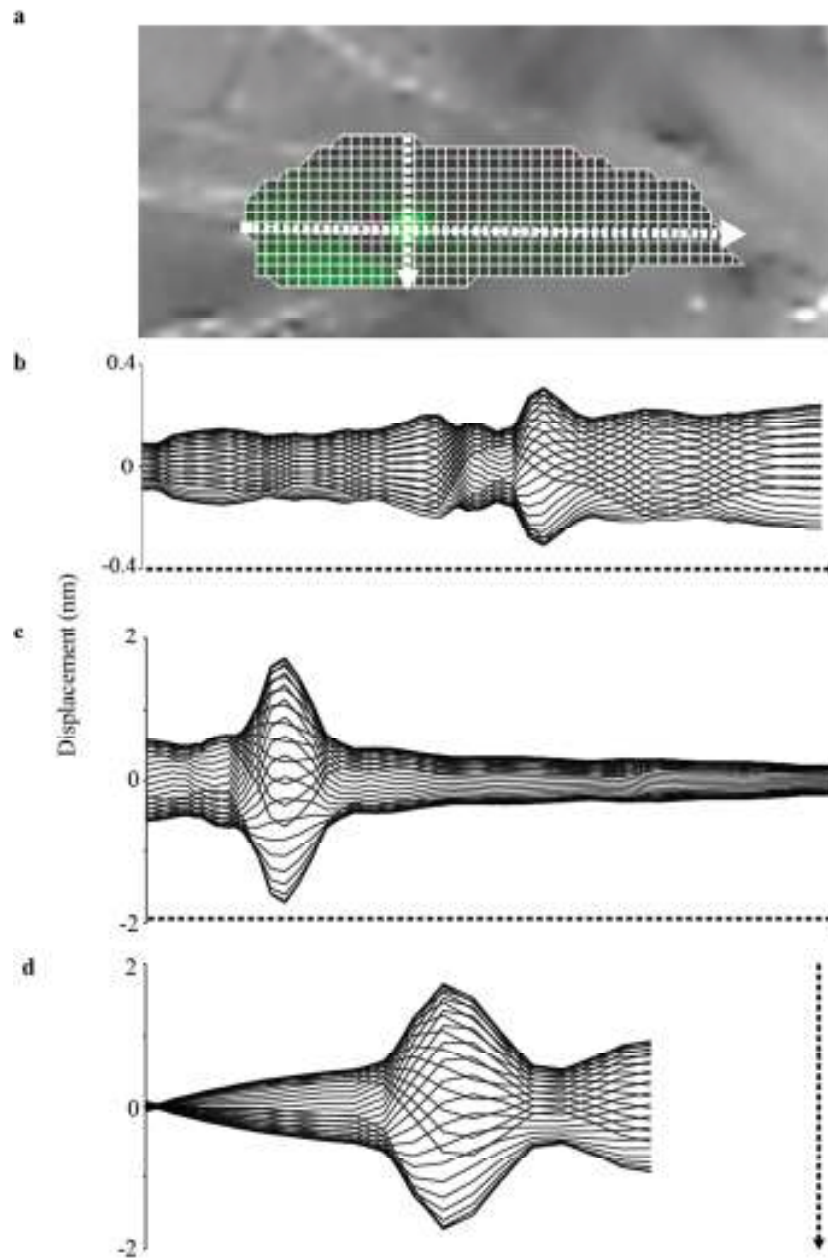

Figure 3.19 Displacement across both vertical and horizontal transect lines of the membrane. **a)** shows the lines selected, **b)** is the displacement over the line when the sound stimulus was 20 kHz, **c)** 50 kHz over the horizontal line and **d)** is the vertical line also at 50 kHz. The arrow on each graph identifies which direction the transect line is.

3.4 Discussion

The tympanal membrane of insect hearing organs is the first point that the sound is received. The shape and also the structure of the membrane is therefore important in effectively detecting and then processing the sound (Yager, 1999). The results found for the current chapter demonstrate how varied the tympanal membranes are of different insects, both in their structure and also in the membrane mechanics, and how each hearing organ is finely tuned to its own function. The tympanal membrane structure of insects vary in their complexity, for example some are known to have different thicknesses such as the locusts, and also the Pyralidae moths investigated in this Chapter, in comparison to the single uniform thickness of Noctuid moths tympanal membranes (Yager, 1999).

By using a laser Doppler vibrometer, information about the mechanics of insect hearing membranes has been discovered recently with more accurate measurements possible due to the advancement of the technology and resolution of the laser Doppler vibrometers. Early studies of the mechanics of tympanal membrane used various laser interferometry and holography techniques (Michelsen, 1971b; Michelsen and Larsen, 1978; Spangler and Takessian, 1983), other applied an electromagnetic stimulator to the surface of the membrane (Adams, 1972). Measurements using these techniques were not very accurate, but a rough idea of how the membrane behaved mechanically was created. The results of the electromagnetic stimulator showed that the membranes were displaced on the picometre level. More recent work using laser Doppler vibrometry confirmed this; using Noctuid moth species, which have 2 auditory cells, it was found that the minimum displacement required to elicit an A1 cell response was around 100 pm and for an A1 and A2 cell response it was 700 pm (Windmill et al., 2007). More recently in a species of Noctuid moth the tympanal neural response was found to be dependent on the displacement of the membrane, whereas the velocity of the displacement was not important, velocity altered with the frequency of the sound whereas displacement did not, the study also indicated that the dissection of the moths did not affect the tympanal mechanics (ter Hofstede et al., 2011).

Locust tympanal membrane mechanics were originally thought to be simple and move like a drum, (Michelsen, 1971b). The hearing organ was thought to possess

frequency discrimination for some time as the receptor cells were found to have different frequency ranges of sensitivity (Michelsen, 1971a), however it was not known how the tympanal organ processed the different frequencies. When laser Doppler vibrometry was used to investigate the membrane mechanics the membrane was found to have complex tonotopic travelling waves arising when sound was applied, these were funnelled to various points of receptor cell attachment on the membrane (Windmill et al., 2005) (Fig. 4.7) in both *S. gregaria* and *L. migratoria*. Since the discovery of locust tympanal membrane travelling waves other species have also been found to possess tonotopy, in another species of Orthopteran and also in a species of Hemiptera; travelling waves due to sound stimulus have also been shown on a tympanal membrane of a species of cicada (Sueur et al., 2006). However, another species of Cicada was not found to have a travelling wave and has a membrane that behaves like a drum (Sueur et al., 2008). In another species of the order Orthoptera the hearing organ of bushcrickets, the *crista acustica*, located on the leg, has been shown through laser vibrometry to possess a travelling wave which provides the organ with tonotopy (Udayashankar et al., 2012).

The hearing organs of locusts are thought to use sound for a number of reasons in their behaviour, including intra-specific communication, so therefore the hearing organ must be sensitive to a range of frequencies. To process the different sounds the locust has the largest number of scolopidial cells in comparison to the other insects investigated in this chapter (Table 3.1). Locusts were also previously shown to detect the ultrasonic echolocation calls of bats and change direction when flying (Robert, 1989; Dawson et al., 2004). Auditory nerve recordings showed that the locusts were capable of detecting frequencies up to 40 kHz (Michelsen, 1971a). Exactly what sounds and the structure of the sound produced by the locusts for communication, and in what behavioural context they are used is not very well understood. To understand the hearing organ more fully the intra-specific communication would need to be studied more thoroughly, including for example if any communication does occur acoustically when the locust are swarming as has previously been mentioned (Haskell, 1957).

The mechanics of the greater wax moth (*G. mellonella*) tympanal membrane were found to be similar to the closely related lesser wax moth membrane mechanics which were previously investigated (Rodriguez et al., 2005). The membranes move maximally

at the receptor cell attachment point with not much deflection over the rest of the membrane at high frequencies (Fig. 4.8b), however at low ultrasonic frequencies (20-40 kHz) the two parts of the membrane move out of phase from one another (Fig. 4.8a). The reason for this out of phase movement of the two parts of the membrane is not known. It is also not clear why the membrane has two different thicknesses, and if there is any role in sound processing. The receptor cell attachment point moves maximally over the frequencies investigated using the transect line analysis of the laser vibrometry scan, the rest of the surrounding membrane-proper is hardly displaced (Fig. 3.9). The collated displacement values across the frequencies tested found that the moth was not finely tuned to a narrow range of frequencies and was still sensitive to very high ultrasonic frequencies, between 50-300 kHz (see Chapter 5). The maximum displacements were found between frequencies of 70-90 kHz, which is the range of frequencies produced by the male's courtship call, this was found for both sexes (further discussed in Chapter 5: Section 5.3.1). The reason for this very broad range of frequency sensitivity is also discussed in another Chapter: (Chapter 5: Section 5.5).

The Indian meal moth (*P. interpunctella*) laser vibrometry scans were found to have similar membrane mechanics as the Greater wax moth (Indian meal moth: Fig. 4.8 and Greater wax moth: Fig. 3.12). Both species investigated are of the family Pyralidae and have similar tympanal membrane morphology (Figs. 3.2 and 3.3e). The membrane mechanics were investigated over a wide range of frequencies and also at different sound levels. From the laser vibrometry results the best frequency found in the mechanics was not the male calling frequency, (50-70 kHz), (Trematerra and Pavan, 1995), the mechanics appeared to be centred between 90-110 kHz, (Fig. 3.14 and 3.11). The reason for this is debateable as little is known of the sound production and behaviour of these moths. One possible reason may be that the sounds produced by these moths could actually be higher in frequency; however this is not clear and would require further investigation. Smaller insects are thought to produce higher frequency sounds (Bennet-Clark, 1998), this is seen in other Pyralidae moths, in the lesser and greater wax moth where the smaller lesser wax moth produces higher frequencies, lesser wax moths produces sounds of 100 kHz whereas the greater wax moth produces sounds around 70-90 kHz (Spangler, 1984; Spangler et al., 1984). Therefore it may be the even smaller Indian meal moth produces higher frequencies than the lesser wax moth. There

may also be other reasons why the membrane is seemingly tuned to a higher frequency as the moths also use the hearing sense for predator detection (Trematerra and Pavan, 1995). The hearing sensitivity of the moth has not been investigated through electrophysiology probably due to the very small size of the adults.

The analysis of the transect line of the Indian meal moth found that quite a large area of the membrane moved (Fig. 3.13), in comparison to the Greater wax moth transect line results (Fig. 3.9). It is not known why the area of maximum displacement appears to be larger. The resolution of the laser recordings may not be as high as the other insects due to the size of the moth. Also, the animal was not easily restrained and the membrane was not always easily visible on the PSV video feedback, the membrane was also difficult to focus on due to the size.

Previously the mechanical tuning of a Noctuid moth tympanal membrane was found to shift in resonance frequency at higher sound levels, suggested to be due to detecting the echolocation calls of bats better (Windmill et al., 2006). This was also investigated in two species of Pyralidae moths investigated in the current study; however there was no evidence found of up-tuning in either species investigated (Figs 3.10 and 3.14). One of the possible reasons for the lack of up-tuning is these moths have different purposes for the hearing sense. The species of Noctuid moth previously shown to up-tune, *Noctua pronuba*, is not thought to use intra-specific communication, (Conner, 1999) and the hearing range is centred around bat calling frequencies 40-80 kHz, with the up-tuning shifting from 40 to 70 kHz at higher intensities. In the case of Pyralidae moths the laser vibrometry of this chapter and also parts of chapter 5 have discussed the wide frequency sensitivity ranges of the moths. These species also have the dual purpose of intra-specific communication as well as bat detection, and thus it may not be beneficial for these moths to have up-tuning as the region of up-tuning could be around frequencies produced by the males of the species (Spangler, 1986a; Trematerra and Pavan, 1995).

The Crambidae species, *Ostrinia nubilalis*, the European corn borer moth, had not been previously investigated with laser vibrometry and little is known of the structure of the tympanal organ, although the sound that the moths produce for intra-specific communication has been well studied, (Nakano et al., 2008) and also of other closely related species (Nakano et al., 2009a; Nakano et al., 2009b; Takanashi et al., 2010). The

shape of the tympanal membrane differs to the shape of the Pyralid moths species also investigated; the membrane is oval shaped and appears to be of one uniform thickness (Fig. 3.4). From the laser vibrometry scan results there was not a distinct point of attachment point of the receptor cells (Fig. 3.16), in comparison the visible point of the Pyralidae moths (Fig. 3.2 and 3.3e). The maximum point of membrane displacement appears to be at the bottom of the membrane on the inner side (Figs 3.16 and 3.17) and it was at this point that the displacement was measured across frequencies between 20-80 kHz (Fig. 3.15). Laser vibrometry scans of the membrane at the courtship call frequency, 40-45 kHz (Nakano et al., 2008), found a membrane displacement of 0.5 nm (Fig. 3.16b) which is not nearly as large as at 20 kHz when it is displaced 6 nm (Fig. 3.16a); both frequencies were at a sound level of 80 dB SPL. At the general frequencies of echolocation calls of bats the membrane is hardly displaced (Fig. 3.15 and 3.16c), showing that the moths may mainly use the hearing sense in courtship communication, although in electrophysiology investigations the moths were still shown to be sensitive to higher frequencies (Agee, 1969; Takanashi et al., 2010). Some of the sound levels applied as acoustic stimulus were higher than the male call and so the membrane mechanics may not represent a realistic behaviour. Much still remains to be understood and the current results leave a lot of unanswered questions about the membrane mechanics in particular and the receptor cell attachment and the required displacement to elicit a neural response.

The hearing organ of the green lacewing (*C. carnea*), is so far unique in both its location, on a wing vein, and also in that the cavity backing it is fluid and not air-filled (Miller, 1971). The lacewings were shown to be very sensitive to the calls of bats, both behaviourally (Miller, 1975) and through neural recordings (Miller, 1971). Histology techniques found that parts of the membrane appeared to be rippled and was split into two areas, with the other a smooth surface. It was this smooth surface that when destroyed ablated the neural response and so appears to be the site of receptor cell attachment (Miller, 1971). Laser vibrometry had never previously been carried out on the tympanal membrane; the results found in the current study confirmed that the membrane was sharply tuned to the calls of echolocating bats, 40-50 kHz (Fig. 3.18b) and also showed that the membrane moved in one distinct point (Fig. 3.19). The other frequencies shown did not produce as a distinct a reaction on the membrane, over the

area scanned at all points the vibration was the similar even at the receptor cell point (Fig. 3.18 c and d). There was no evidence found of the rippled membrane from the current laser vibrometry scans and the effect it has on the sound reception. One possible reason may be related to the chemicals used previously to fix the membrane which could have caused the rippling; it would be useful therefore to repeat the histology of the lacewing tympanal organ and to also use the more recent techniques available such as electron microscopy, for example. Due to problems in rearing the larvae, the laser scans of the current study only used 2 animals, so much still remains to be investigated in lacewing membrane mechanics, such as if there is a gender difference or if there is another frequency band that the insects may use for intra-specific communication for example.

The majority of the species of the insect species investigated in this chapter are known to use their hearing sense for both bat detection and intra-specific communication (Table 3.1). The diversity in terms of structure and also size of the tympanal membranes gives an idea of how by hopefully applying this information to man-made transducer design it will be possible to provide the opportunity for more efficient and smaller man-made sensors, for example how the structure of the tympanal membrane dictates what frequency the tympanal hearing organ is tuned to may be one avenue to investigate in the future.

Chapter 4:
Investigation into the presence of
DPOAEs in insect tympanal
mechanical membrane motion

Part of this chapter has been published: Moir, H. M., Jackson, J. C. and Windmill, J. F.C., 2011, No evidence for DPOAEs in the mechanical motion of the locust tympanum, *Journal of Experimental Biology*, 214: 3165-3172.

4.1 Introduction

Otoacoustic emissions are a characteristic of active hearing, they are well known and studied in many species of animals hearing organs. Insect tympanal hearing organs were not thought of possessing active hearing, the discovery of distortion-product otoacoustic emission in the ears of locusts suggested that they do possess more sophisticated hearing than was originally thought (Kössl and Boyan, 1998b). However, the origin of the emissions is still not known despite many studies and also using different species of insect.

The aim of the current experiments was to investigate the vibration of the tympanal membrane using laser Doppler vibrometry in order to try and establish the origin of DPOAEs in insect tympanal organs. Two orders of insect were investigated, including two species of locust and also a Pyralid moth. The insect ears were stimulated with two tones whilst the velocity of the membrane was recorded with a laser Doppler vibrometer. Theoretically, if the tympanal membrane is the source of the DPOAEs, then their sound energy should cause a vibration of the membrane (or vice versa) and should thus be detectable with the laser Doppler vibrometer. Due to the exposed tympanal membrane of the insects tested the membrane mechanics are easily measurable. It was hypothesised that the attachment point of the receptor cells on the membrane would be the most likely location to detect the expected DPOAE deflection; as the site of the DPOAEs in locusts was previously speculated to be the locust Müller's organ or more specifically the cilia of the scolopidia (Kössl and Boyan, 1998a). Other experiments further investigated the presence of DPOAEs when the physiological state of the insect was altered by blocking the spiracles in the locusts, to increase internal body pressure, increasing and decreasing the body temperature of locusts and also inducing hypoxia using CO₂. The sound levels of the two-tones were also altered, increasing them to levels where large DPOAEs were previously emitted acoustically.

4.1.1 Locust tympanal organ morphology

The auditory organs of locusts are the most studied out of all insect species, it is therefore one of the most fully understood in terms of structure and functioning (Yack, 2004). Locust auditory organs are located on the first abdominal segment under the wing on either side of the insect. The organs consist of a tympanal membrane (Fig. 4.1) and the Müller's organ, the chordotonal organ, through which 60 - 80 scolopidia sensory cells are attached to the membrane (Gray, 1960; Michelsen, 1971a).



Figure 4.1 Tympanal membrane surface of *Schistocerca gregaria*, the attachment regions of the receptor cells has been highlighted; the high frequency cells, (d-cells), in green on the pyriform vesicle and the low frequency cells, (a-c cells), in red along the folded body.

4.1.2 Greater wax moth tympanal organ structure

Greater wax moths (*Galleria mellonella*), of the Pyralidae family, have paired tympanal membranes located on the first abdominal segment of the body. The membrane is divided into two parts; the counter-tympanic membrane and the membrane proper. The attachment point of the receptor cells is visible as an opaque dot in the centre of the membrane (Fig. 4.2). There are 4 auditory receptor cells, A1-A4. Hearing capabilities are ultrasonic as the tympanal organs function to serve bat detection, as well as being used in mating for pair formation (Skals and Surlykke, 2000; Jones et al., 2002). The receptor cells are thought to have different sensitivities to sound pressure level (Skals and Surlykke, 2000), like the noctuid moths, this is thought to allow the moth to

distinguish the closeness of the predator and take the appropriate evasive behaviour, for example if the A4 is firing this signals that the bat is very close by and a last ditch attempt to escape is carried out whereby the moth drops out of the sky to avoid predation (Roeder, 1974). Hearing also serves another purpose, as the males of the species produce trains of sound by means of tymbals, such that the moth produces clicks of 70-90 kHz (Spangler, 1986a). For a more detailed discussion of greater wax moth tympanal organs morphology and functioning see Chapter 5.

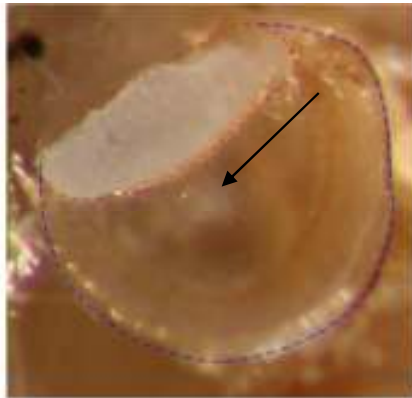

Figure 4.2 The tympanal organ of a female greater wax moth. The attachment point of the receptor cells is highlighted with an arrow. The two regions of the tympanal membrane are outlined; tympanal membrane proper (blue) and the counter-tympanic, opaque region (red).

4.1.3 Distortion-product Otoacoustic Emissions (DPOAEs)

Distortion-product Otoacoustic emissions (DPOAEs) are non-linear mechanical emissions produced by ears when two tones of distinct frequencies, f_1 and f_2 , are applied to the hearing organ of the animal investigated. Expected distortion products are various arithmetic combinations of the applied tones; with the $2f_1-f_2$ products having the highest intensity. DPOAEs were first discovered in human hearing by Kemp (1978), where people with normal hearing and others with cochlear deafness were tested and compared by stimulating the ear with clicks; Kemp found that there were extra sounds being produced after a delay, however, those with cochlear deafness did not produce these extra sounds. These results lead to speculation that these artefacts of the sound are

produced due to cochlear amplification processes in the ear. Since then much research has been carried out and it is now understood to be the (biomolecular) motor protein prestin in the outer hair cells of the vertebrate hearing that produces DPOAEs (Dallos, 2008).

The presence of DPOAEs is now used to assess the functioning and sensitivity of human hearing, as people with damaged hearing organs show a decrease in DPOAEs (Kummer et al., 1998; Kemp, 2002). DPOAEs have been shown to be producible in both mammalian ears and in many non-mammalian ears. A comparison of the structure of 4 non-mammalian ears showed that ears that did not possess cochlea were also capable of producing DPOAEs; of the animals tested the structure of the hearing organs all differed (Bergevin et al., 2008). This showed that DPOAEs can be generated through other ear structures. The presence of hair cell like auditory receptors and also a travelling wave were characteristics found to be important to DPOAE presence (Bergevin et al., 2008).

Within mammalian auditory organs the active mechanisms of the hair cells within the cochlea amplify low-level sounds. This is an example of active hearing; where the sound is conditioned by metabolic processes in the ear. One of the costs of this sensitive hearing is the extra distortion caused, i.e. Otoacoustic emissions. These emissions are evoked in a number of ways within mammalian hearing, such as by electrically stimulating the auditory organ - electrically evoked otoacoustic emissions (EEOAEs) – as well as the DPOAEs previously discussed. There are also spontaneous emissions (SOAEs), which can be produced in auditory organs spontaneously with no external sound stimulus. These have been described as the clearest evidence that a hearing organ possesses active hearing (Manley, 2001).

4.1.4 DPOAEs in invertebrate hearing organs

DPOAEs have more recently been found in invertebrate tympanal hearing organs, firstly in locust ears (Kössl and Boyan, 1998a; Kössl and Boyan, 1998b), but also in a number of other insect hearing organs such as moths (Coro and Kössl, 1998; Coro and Kössl, 2001; Kössl et al., 2007), and bushcrickets (Möckel et al., 2011). It is not understood how insect tympanal organs produce the DPOAEs (Kössl et al., 2008). All of these

previous experiments investigated DPOAE magnitude by recording the emission and applied sound with microphones in the near field using a closed set up (Fig. 4.3). In locust hearing organs, where most literature concerning insect DPOAEs can be found, the authors speculate that the DPOAEs are produced by Müller's organ (Kössl and Boyan, 1998a) as it has been previously shown to have complex oscillations when stimulated by sound (Breckow and Sippel, 1985). Other suggestions to the origin have also been put forward, such as the interaction between the thick and thin membrane (Kössl and Boyan, 1998a).

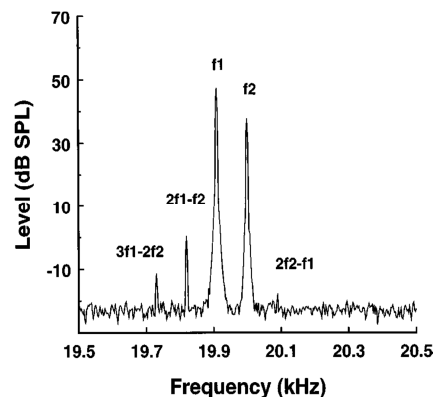

Figure 4.3 An example of expected DPOAEs which were recorded acoustically from a *Locusta migratoria* tympanal organ, taken from Kössl and Boyan, 1998. Where f_1 and f_2 are the tones applied and the other tones are the distortion products.

The production of DPOAEs in the locust ear also appeared to be affected by carbon dioxide (CO_2), which implied that the presence of DPOAEs is metabolically sensitive (Kössl and Boyan, 1998a). DPOAEs magnitude were also reduced due to ablation of the membrane, electrical stimulation, and also severing of the auditory nerve. However, the location of the DPOAEs' origin could still not be confirmed in the tympanal organ of *Locusta migratoria* (Möckel et al., 2011).

In moth tympanal organs, DPOAEs were recorded acoustically from noctuid and notodontid moths (Coro and Kössl, 1998; Kössl et al., 2007). The results suggested that moths also possess non-linear components of hearing due to the presence of DPOAEs. There was not an optimum ratio between f_1 and f_2 in comparison to the previous locust findings. Frequencies were tested between 5-50 kHz. Moth tympanal organs possess

less scolopidial cells than the locust; in the most extreme example, notodontid moths, there is only one receptor cell, and yet DPOAEs were found to be recordable acoustically (Kössl et al., 2007).

4.2 Experimental Set Up

4.2.1 Animals

The species investigated were adult male and female *S. gregaria*, *L. migratoria* and adult *G. mellonella*. Further details such as where the animals were obtained from, what conditions they were kept in and how they were prepared for experimentation can be found in Chapter 2: Section 2.1.

The locusts, *S. gregaria* and *L. migratoria*, were placed dorsal side up on a metal plate, on top of a stand. The locusts were restrained using Blu-Tack, (Bostik-Findley, Stafford, UK), ensuring that the tympanal organ was still exposed. The right tympanal organ was used in all experiments in order to keep the set up consistent. The tympanal organs of *L. migratoria* have a piece of cuticle covering the membrane; to overcome this obstacle the animal was angled such that the laser beam could reach the pyriform vesicle and the majority of the membrane.

The adult moths, *G. mellonella*, were pinned onto a plasticine block, with their wings and abdomen held back by staples, the mesothoracic segment was held back using a staple to expose the paired tympanal membranes on the first abdominal segment. The moths were then placed in front of the close up head on the insect holder; the moth had to be tilted slightly downwards to obtain a good view of the tympanal membrane on the video feedback. The right tympanal membrane was used for all moths tested as it was positioned nearest to the sound source.

4.2.2 Mechanical and Acoustic Measurements

The room where all of the experiments were carried out was kept at a constant temperature of 23 °C. The stand with the holder and the animal was moved so that the video feedback on the laser Doppler vibrometer computer system was in focus and in line with the tympanal organ. This allowed a constant check that the laser beam was directed to the correct part of the membrane at all times. The loudspeaker was directed towards the tympanal organ and the stand was kept at the same height throughout the experiments. The microphone was placed in the holder and adjusted so that it was as

close to the tympanal organ as possible, whilst not affecting the laser beam path to the tympanal membrane or being between the organ and the loudspeaker.

4.2.2i Locust experiments

The vibration of the locust tympanal membrane was recorded using a laser Doppler vibrometer, (Polytec PSV-300-F; Waldbronn, Germany) using a close up attachment head attached to the OFV-056 scanning head. The whole membrane was first scanned using a wideband chirp acoustic stimulus which ranged from 1-30 kHz generated using the PSV software. This was done to check that the membrane was functioning properly, was not damaged, and that the intrinsic travelling wave was present on the membrane (Windmill et al., 2005). The two tone DPOAEs experiments were then carried out. The sounds were generated using a function generator (Tektronix Dual Channel – AFG 3102); the sound stimulus of two distinct frequencies, f_2 and f_1 where $f_1 < f_2$ and the sound pressure of f_1 was always 10 dB SPL higher than f_2 , as in previous studies this elicited the highest $2f_1 - f_2$ distortion, (Kössl and Boyan, 1998a). The ratio of f_1/f_2 was previously found to be an important factor in DPOAEs, and the optimum ratio for locust DPOAEs was found to be between 1.1 and 1.4 (Kössl and Boyan, 1998a). The ratio of the frequency of f_1/f_2 was therefore altered, keeping f_2 constant and altering f_1 in 0.02 (ratio) increments. The sound was amplified using an amplifier (Sony TA-FE570; Tokyo, Japan) before it was passed onto the loudspeaker (Riesen, 4 inch speakers, Maplin Electronics, UK). The acoustic level of the two tones were measured using the microphone, (Bruel and Kjaer - Type: 4138, Nærum Denmark), placed as close as possible to the tympanal organ to ensure that the sound pressure level for each tone was correct. The microphone was also used to record the background noise in the room; this was measured before and after the experiments were carried out. The microphone was calibrated regularly throughout the experiments to check that it was functioning correctly. The membrane was then scanned whilst two tones of different frequency were used to stimulate the tympanal organ (f_1 and f_2). Some smaller areas were also scanned again at a higher resolution, namely the folded body and the pyriform vesicle, to try and identify if any distortion product related mechanical displacements in that particular area, where the receptor cells attach, occurred when stimulated acoustically by the two tones. An animation of the membrane's deflection could be produced using the PSV

software so that the vibration of the membrane at certain frequencies could be visualised.

4.2.2ii Greater wax moths experiments

The Greater wax moth DPOAE experiments used the same equipment as was previously described for the locust experiments apart from the loudspeaker that was used as the frequency range was in the ultrasonic range, (Tannoy, Supertweeter – ST50, Coatbridge, UK). Firstly the whole membrane was scanned whilst using a singular frequency of 70 kHz which was around the peak sensitivity found previously (Skals and Surlykke, 2000). This was done to identify the receptor cell attachment point due to it being the site of maximum displacement, Chapter 3: Section 3.3.2. A smaller area encompassing the attachment point was then selected and scanned whilst the two-tone stimulus was played. The sound pressure level of the two-tones in the experiments were always: $f_1 = 70$ dB SPL and $f_2 = 60$ dB SPL; frequencies between 40-120 kHz were used in 5 kHz steps of f_2 . This range is within the known hearing range of the greater wax moth (Skals and Surlykke, 2000). A ratio of 1.2 between f_1 and f_2 was chosen as it was previously found that the ratio was not a factor of the magnitude of the DPOAEs emitted in the moths (Coro and Kössl, 1998). This procedure was repeated using 10 moths of both sexes. Using the PSV software the displacement of the receptor cell attachment point could be analysed creating so called distortion audiograms (Kössl and Boyan, 1998a) and waterfall plots of the displacement over a frequency range were created in MATLAB (Version R2009b), to identify if there were significant displacements at the expected DPOAE frequency of $2f_1-f_2$. The background noise level and the magnitude of the expected DPOAE at $2f_1-f_2$ were also compared to see if they were statistically different. This was done using Minitab (Version 2011a).

4.2.3 Locust Single Shot Experiments

Using the laser Doppler vibrometer the laser point was moved over the membrane, as the animal was stimulated with two tones over a range of frequencies and the two-tone sound pressure levels, this measured the velocity at that point of the laser continuously. This was done in an attempt to detect any significant deflection at the expected $2f_1-f_2$

frequency on the membrane. This was initially carried out on a small number of locusts, where there did not appear to be any significant deflection points at the expected parts of the membrane, namely on the folded body and the pyriform vesicle; the receptor-cell attachment sites. As there was no detection of the expected DPOAEs the pyriform vesicle was then selected as the primary focus of these experiments as it is easily locatable on the membrane, ensuring that the recordings of all the individuals could be consistent. Also, the pyriform vesicle is known to be mechanically sensitive to a wide range of frequencies, and is a receptor-cell attachment site (Michelsen, 1971a). A LabVIEW program, (National Instruments, version 8.5.1) (Appendix 1: Section A1.1), was written to record the laser measurements over all the f_1/f_2 combinations. The program controlled the function generator, setting the correct frequency of the two-tones. The SPL of the two-tones were manually altered and monitored through the microphone output, such that when the levels were correct the velocity was recorded using a data-acquisition card (National Instruments, BNC-2110 and USB-6251). The velocity and the microphone signals were averaged 10 times. This was repeated for 15 individuals of both *L. migratoria* and *S. gregaria*. Waterfall plots of the data over the range of frequencies were created using MATLAB (R2009b), for individual locusts. The velocity of the pyriform vesicle at the frequency of $2f_1-f_2$ was selected and compared to the average noise floor, which was calculated by removing the velocity values of f_1 , f_2 and $2f_1-f_2$. Using Minitab (Version 15), the two values could be compared to see if there was any statistically significant difference between them.

4.2.4 Carbon dioxide induced hypoxia

Applying carbon dioxide to locusts induces hypoxia, which was previously found to reduce the magnitude of the expected DPOAEs (Kössl and Boyan, 1998a); this was suggested to be due to the fact that the process was physiologically sensitive. To investigate the membrane mechanics whilst inducing hypoxia using laser Doppler vibrometry, a container was built using glass microscope slides glued together and sealed by gluing strips of rubber to the joins. The laser beam was not affected by the glass and the vibration could be recorded accurately. The container was placed on the metal holder and adjusted so that the tympanal membrane was in focus. The sound

stimulus was created in the same way as previously described for the single shot experiments (Section 4.2.3i). Individual locusts, of both *S. gregaria* and *L. migratoria* were investigated; they were restrained using Blu-tac (Bostik-Findley, Stafford, UK). The container was then covered with cling film with the animal inside, a small hole was punctured into the cling film and CO₂ was applied, using a dispenser with a CO₂ canister. This was applied until the locust antenna became de-elevated, an indicator that was used previously as a signal of hypoxia (Kössl and Boyan, 1998a). The microphone was then moved so that it was as close to the tympanal membrane as possible; the microphone had to be moved as the application took place as CO₂ was found to affect the microphone function. The acoustic stimulus applied was a broadband periodic chirp and five different $f1/f2$ combinations; the vibration of the pyriform vesicle was recorded before, during and after CO₂ application using a single-shot recording of the laser vibrometer. The velocity of the pyriform vesicle in the three states could then be compared. Scans of the entire membrane were also carried out in all three states. This was repeated using 10 locusts of each species.

4.2.5 DPOAE SPL Calculations and Experiments

Two-tone experiments on locust tympanal organs in previously published work measured DPOAEs at levels up to and above 10 dB SPL (Kössl and Boyan, 1998a). It was calculated that the current experimental set up would be capable of recording the displacement of the membrane if the sound of such level was being emitted through the membrane. This was calculated using the Rayleigh Integral:

Where p (pressure) at a point R away from a surface $S = S(R_0)$ with the velocity of the surface v in a medium with density ρ and speed of sound c , (Benny et al., 2000):

$$p(R, t) = \frac{\rho}{2\pi\partial} \frac{\partial}{\partial t} \int_s \frac{v(R_0, t - \frac{R}{c})}{R} ds \quad [4.1]$$

A membrane oscillating at a specific frequency f , the velocity of the membrane can be described as:

$$v = v(R_0) \exp \left[i2\pi f \left(t - \frac{R}{c} \right) \right] \quad [4.2]$$

The pressure can therefore be independent of time and discretised for numerical calculation, such that absolute pressure P obeys:

$$P(R) = \frac{\rho A f}{N} \sum_i^N \frac{d(R_0) \exp \left[-\frac{2\pi R}{c} \right]}{R} \quad [4.3]$$

Where A is the area of the surface, N is the number of discretization points and d is the surface displacement.

It was calculated that at the frequencies used in the current experiments emission of a 10 dB SPL DPOAE would cause a membrane of size 2.2 – 1.5 mm (Stephen and Bennet-Clark, 1982), to be displaced by 12 pm, which is 4 times the current noise floor. The laser vibrometer was used to record single-shot recordings and scans of the membrane at f_1 and f_2 frequencies, and SPLs, that were previously found to elicit DPOAEs of 10 dB SPL in order to identify if there was a distinct point on the membrane from where the DPOAE sound was being emitted.

4.2.6 Altering body temperature of locusts

Altering the body temperature was found to alter the magnitude in some animals DPOAEs, this change was seen increasing and also decreasing the body temperature; however in some other animals the DPOAEs were not affected by temperature alterations (Bergevin et al., 2008). In locusts the neural response was found to increase at higher temperatures (Oldfield, 1988). To investigate if this would affect the appearance of DPOAEs, an ice pack to cool the locusts and then a heat lamp to raise the body temperature was used, changing the temperature from 18 °C to 30 °C. These could also be compared with the results recorded at room temperature of 23 °C. The laser vibrometer recorded scans and also single-shot recordings of the membrane as has been previously described. This was repeated for 5 individual *L. migratoria*, where the acoustic stimulus was; $f_1 = 12.25$ kHz and $f_2 = 12.5$ kHz with a SPL level of 50/40 dB SPL of f_1/f_2 respectively.

4.2.7 Spiracle blocking experiments

The same set up was used as previously described for the scans and single-shot experiments (Section 4.2.2). An initial scan of the membrane was carried out before the spiracle was blocked. Then, with the locust under a microscope the spiracle opening closest to the tympanal membrane was identified on the first abdominal segment; which are the largest spiracles. Using a syringe, petroleum jelly (Vaseline), was applied into the spiracle and the surrounding area. The right side spiracle only was blocked first, and then laser vibrometer measurements taken. Then, the other side spiracle was also blocked and the membrane was measured again. The acoustic stimulus was two tones of different frequencies; three different combinations were tested using 5 individuals; all the locusts used were adult *S. gregaria*. As locust tympanal membranes are backed by several air sacs, the purpose of the blocking of the spiracles was to alter the pressure behind the membrane to identify if the membrane tension altered the presence of DPOAEs. Both scans and single-point recordings using the laser vibrometer were carried out.

4.3 Results

Scan animations of the results can be found on the flash drive included.

4.3.1 Laser Vibrometry scans

4.3.1i Locusts

Accurate membrane deflections could be recorded using the laser Doppler vibrometer whilst the membrane was stimulated with two tones, in an open set-up, non-invasively. It was expected that the initial scans of the membrane would detect a distinct area of deflection, such as one of the attachment points of a group of receptor cells. However, the vibrometer scans of the membrane at the expected $2f_1-f_2$ DPOAE frequency did not find any coherent displacement of the membrane. This was also the case at all of the frequencies investigated in all individuals, $n = 15$ for both species tested, *S. gregaria* and *L. migratoria*. Altering the SPL of the applied two tones did not alter the membrane's behaviour at the DPOAE $2f_1-f_2$ frequency. At the frequencies of f_1 and f_2 the intrinsic travelling wave is observed (Windmill et al., 2005), funnelling the sound to the relevant receptor cells indicating that the membrane is functioning correctly (Fig. 4.4).

4.3.1ii Greater wax moth

Measurements of the entire membrane of greater wax moths also did not identify a DPOAE emission site through the membrane deflections recorded with the laser vibrometer (Fig. 4.5). At the expected $2f_1-f_2$ frequency the displacements of the receptor attachment point was not significantly different from the noise floor (Paired t-test, $P > 0.145$). This was the case for all combinations of f_1/f_2 frequencies tested from 40 – 120 kHz. The displacement at the frequencies of f_1 and f_2 showed that the membrane moved as was expected with maximal displacement on the attachment point of the receptor cells. The scans were carried out on 10 individuals of both sexes.

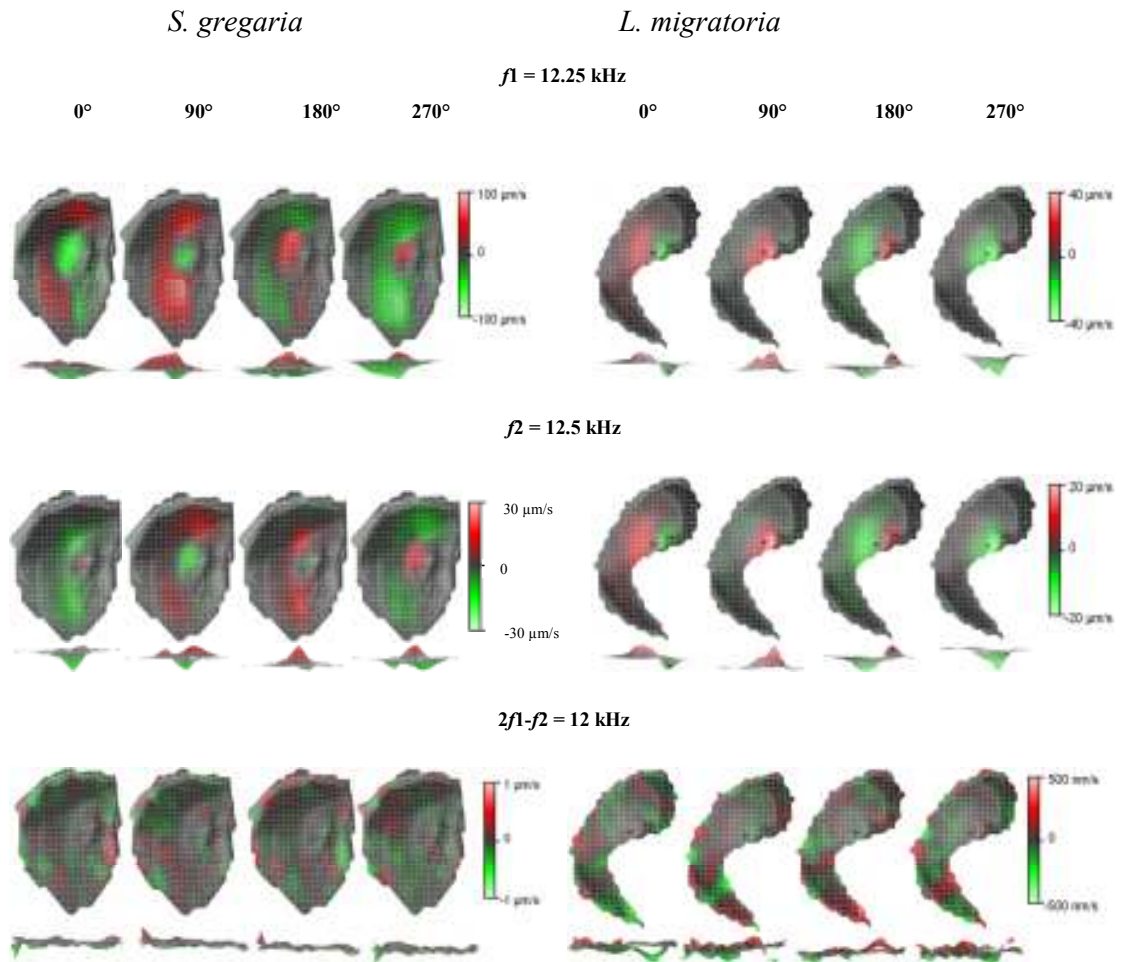

Figure 4.4 Membrane vibrometer scans of each locust species, when the membrane is stimulated with two tones $f_1 = 12.25$ kHz and $f_2 = 12.5$ kHz in different phases; the side view of the tympanum is also shown. The travelling wave can be seen on the membrane for f_1 and f_2 , but there are no coherent points of oscillation on the membrane at the expected DPOAE of $2f_1 - f_2 = 12$ kHz. The two-tone sound level was 45/55 dB SPL for f_2/f_1 .

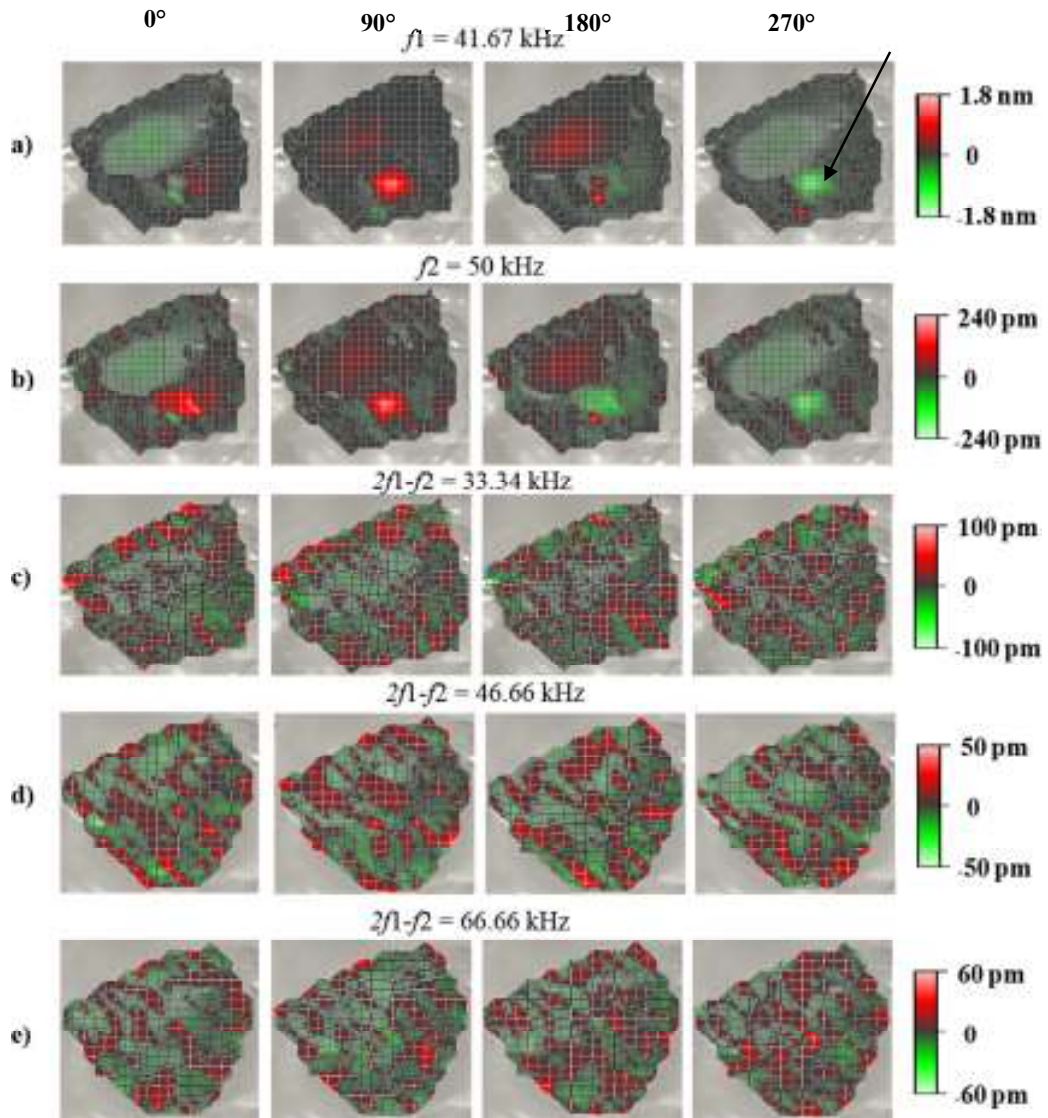

Figure 4.5 Membrane vibrometer scans of an individual greater wax moth, (*G. mellonella*), at 3 different combinations of two tone experiments, the frequencies are shown above. The $2f_1-f_2$ frequency is shown over 4 phases, where the sound pressure level was $f_1 = 70$ dB SPL and $f_2 = 60$ dB SPL. No coherent point of emission is found over the membrane at the expected $2f_1-f_2$ frequency shown for three different combinations of f_1/f_2 . The scans of f_1/f_2 are shown, and it can be seen that the membrane reacts as expected with the main deflection at the receptor cell attachment (indicated with arrow). The f_1 and f_2 frequencies for the **d)** and **e)** scans are: **d)** $f_1 = 58.33$ kHz and $f_2 = 70$ kHz and **e)** $f_1 = 83.33$ kHz and $f_2 = 100$ kHz.

4.3.2 Locust Single-shot results

The initial investigation of the expected points of deflection due to the emission of the DPOAEs, namely the receptor cell attachment points, did not find any relevant displacements at these points (Fig. 4.6). The vibration at the pyriform vesicle was then investigated over a greater number of frequency combinations of f_1 and f_2 . The single-point experiments did not find any significant difference between the velocity of the pyriform vesicle at $2f_1-f_2$ and the background noise floor of the velocity recordings (Paired t-test $P = >0.1$ $n=15$ for both *S. gregaria* and *L. migratoria*); the velocity of the pyriform vesicle for different f_2 and increasing ratios of f_1 are shown for both species (Fig. 4.7 a and b). The background noise floor was calculated as the average velocity over the recorded spectrum of 1 kHz to 30 kHz with f_1 , f_2 and $2f_1-f_2$ values removed for each ratio of f_1/f_2 and then averaged over the 15 recordings for each species.

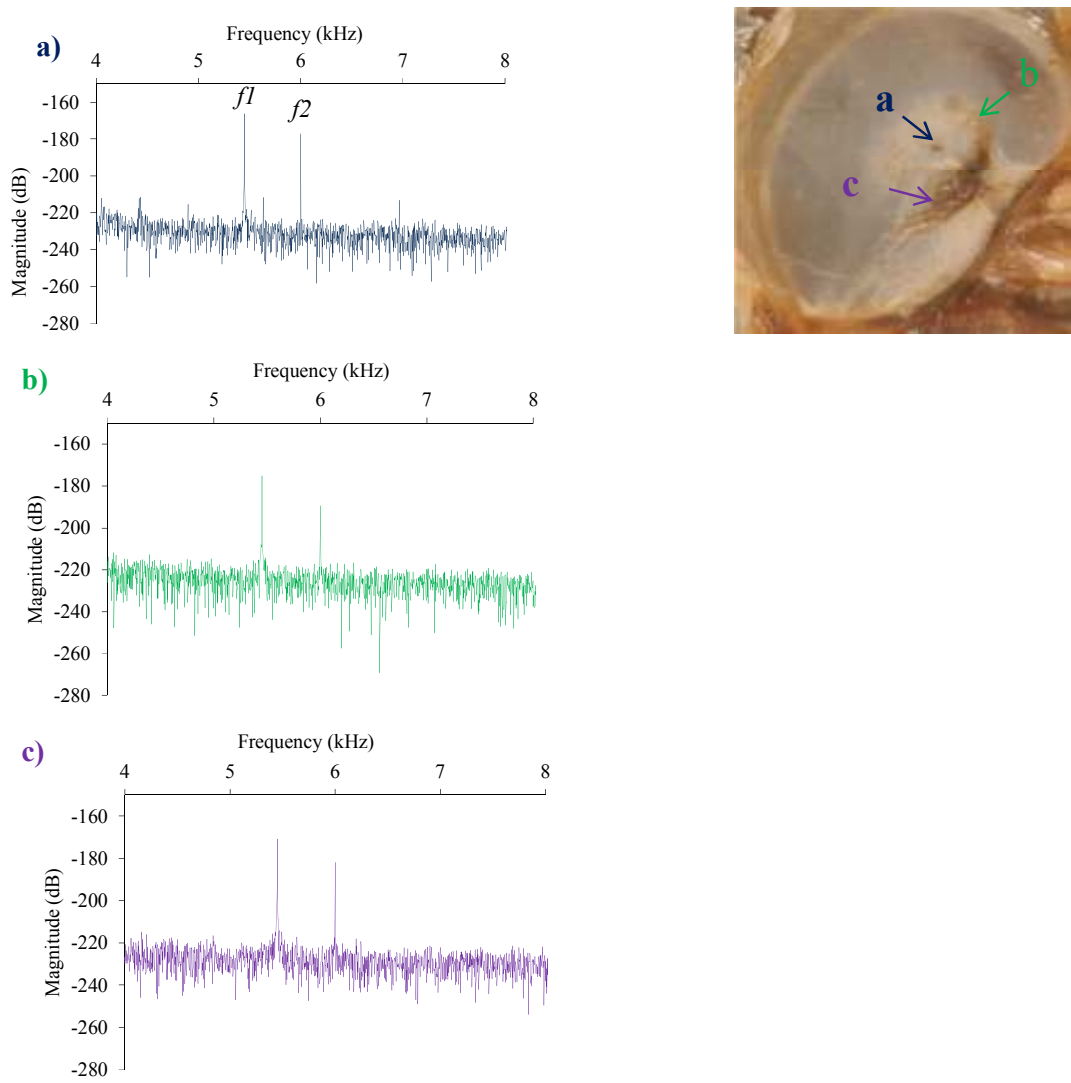

Figure 4.6 The membrane displacement at different points, colour coded. Three different points of attachment of the receptor cells were investigated; **a)** the pyriform vesicle, **b)** the styliform body, and **c)** the elevated process. The two tone acoustic stimulus applied was $f1 = 5.45$ kHz and $f2 = 6$ kHz where $f1 = 50$ dB SPL and $f2 = 40$ dB SPL. The displacement is shown in dB, no relevant displacement is found at any points, in relation to the expected DPOAEs frequency.

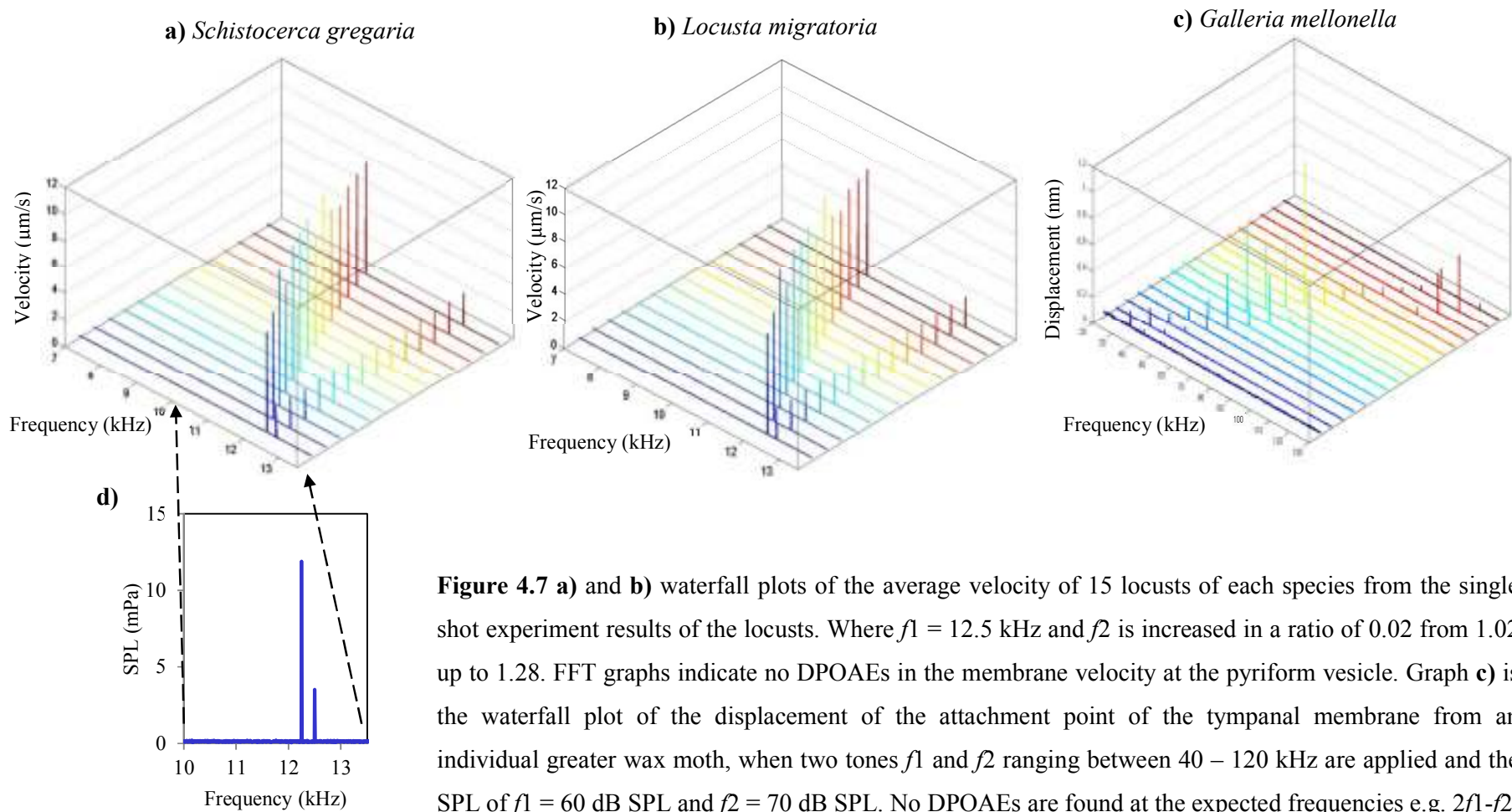

Figure 4.7 a) and b) waterfall plots of the average velocity of 15 locusts of each species from the single shot experiment results of the locusts. Where $f_1 = 12.5$ kHz and f_2 is increased in a ratio of 0.02 from 1.02 up to 1.28. FFT graphs indicate no DPOAEs in the membrane velocity at the pyriform vesicle. Graph c) is the waterfall plot of the displacement of the attachment point of the tympanal membrane from an individual greater wax moth, when two tones f_1 and f_2 ranging between 40 – 120 kHz are applied and the SPL of $f_1 = 60$ dB SPL and $f_2 = 70$ dB SPL. No DPOAEs are found at the expected frequencies e.g. $2f_1 - f_2$. Graph d), is the sound stimulus in mPa for the first f_1/f_2 combination of the waterfall plot for the locust single-shot experiments.

4.3.3 Locust CO₂ experiments

The experiments did not find any drastic or uniform alteration in the membrane behaviour when CO₂ was applied. Measurements of the membrane velocity were also carried out before and during CO₂ application to investigate if the induced hypoxia affected the velocity of the membrane at the f_1 and f_2 tones and also the $2f_1-f_2$ frequency (Figs. 4.8 and 4.9). It was found that the velocity of f_1 , f_2 and $2f_1-f_2$ did not significantly change in any of the recordings in either of the species (two-sample Kolmogorov-Smirnov test $P = >0.1$, $n=10$ for both *S. gregaria* and *L. migratoria*).

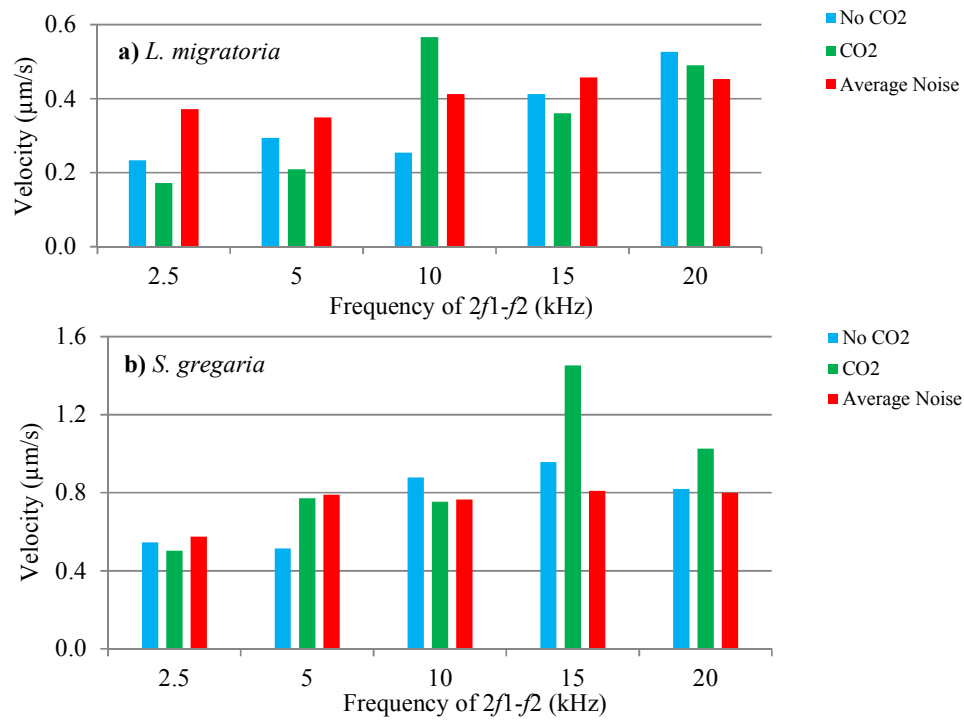

Figure 4.8 The average single-shot results of the $2f_1-f_2$ velocity recorded on the pyriform vesicle for the two species tested **a)** *L. migratoria* and **b)** *S. gregaria*. The averages were calculated from 10 individuals in each species. No significant velocity was found at the expected $2f_1-f_2$ frequency, the red bar shows the average noise floor of the experiments across the frequency spectrum recorded (1-30 kHz). The two tones stimulus sound levels were $f_1 = 55$ dB SPL and $f_2 = 45$ dB SPL.

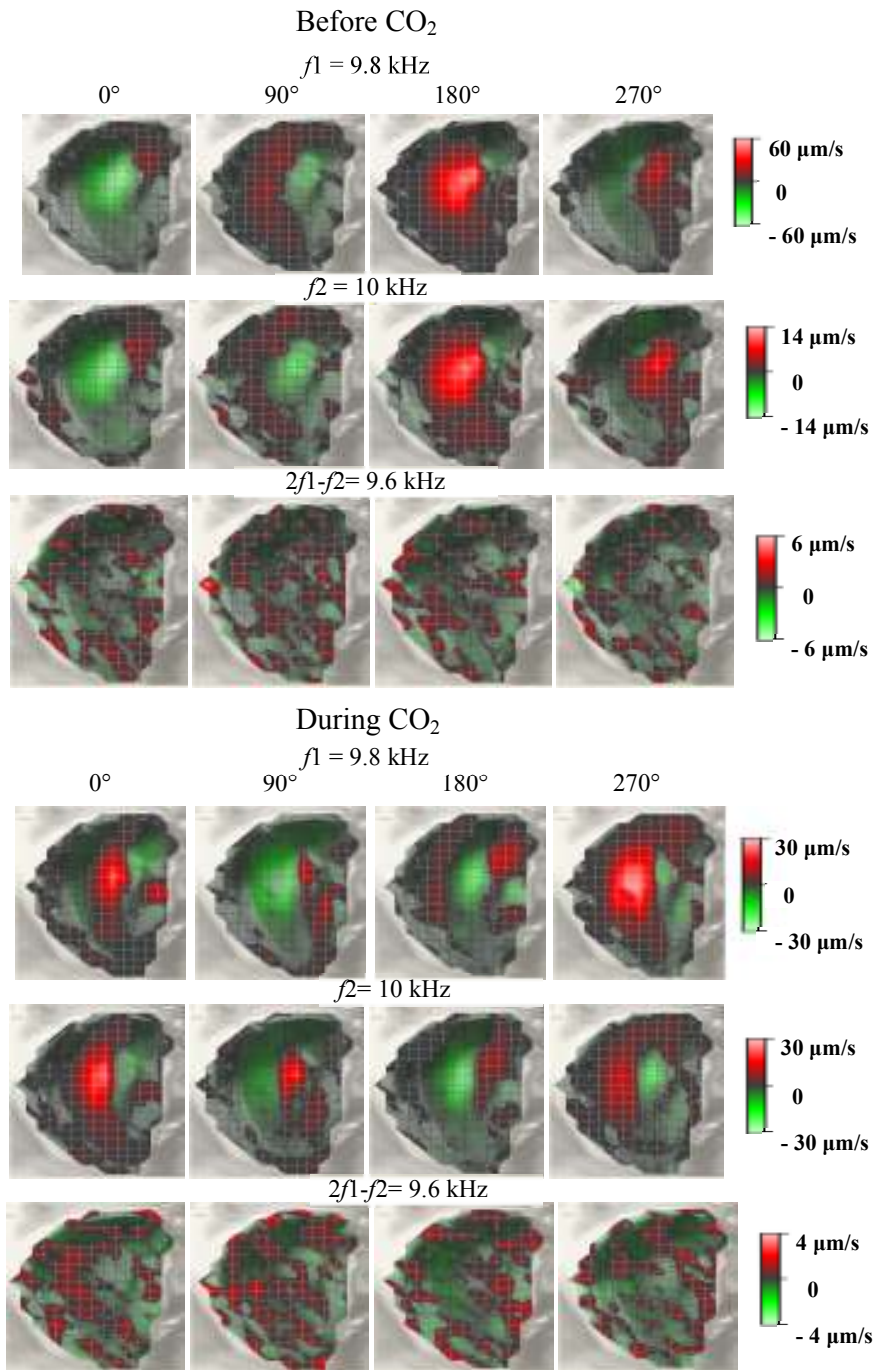

Figure 4.9 Membrane scans of *S. gregaria* before hypoxia was induced with **a)** CO₂ and **b)** during hypoxia. The acoustic stimulus applied was two tones, $f_1 = 55 \text{ dB SPL}$ and $f_2 = 45 \text{ dB SPL}$, the frequency is shown for each scan. There was no coherent point of deflections on the $2f_1 - f_2$ frequency scans.

4.3.4 Investigation into temperature and presence of DPOAEs

The single-shot vibrometry results taken for different body temperatures did not find any distinct difference in the appearance of DPOAEs on the pyriform vesicle. This was the case for 5 individual locusts of *L. migratoria*, at two temperatures tested, 18°C and 30°C. Statistical analysis could not be carried out on the data due to the small sample number. When the velocity of the pyriform vesicle was plotted against the background noise floor, (Fig. 4.10a), it is seen that at 30°C the velocity was slightly higher. However, the entire FFT spectrum of those locusts indicates that the background noise velocity was higher for those recordings, and so it was not due to any relevant DPOAEs being emitted (Fig. 4.10b).

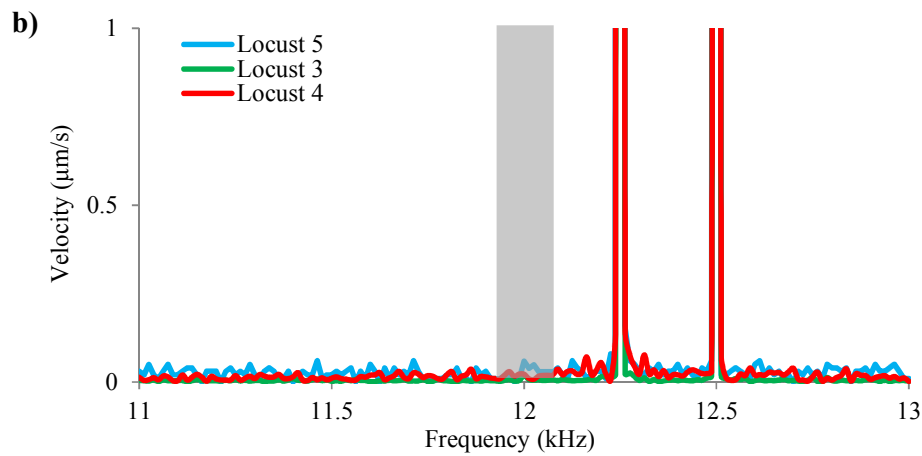
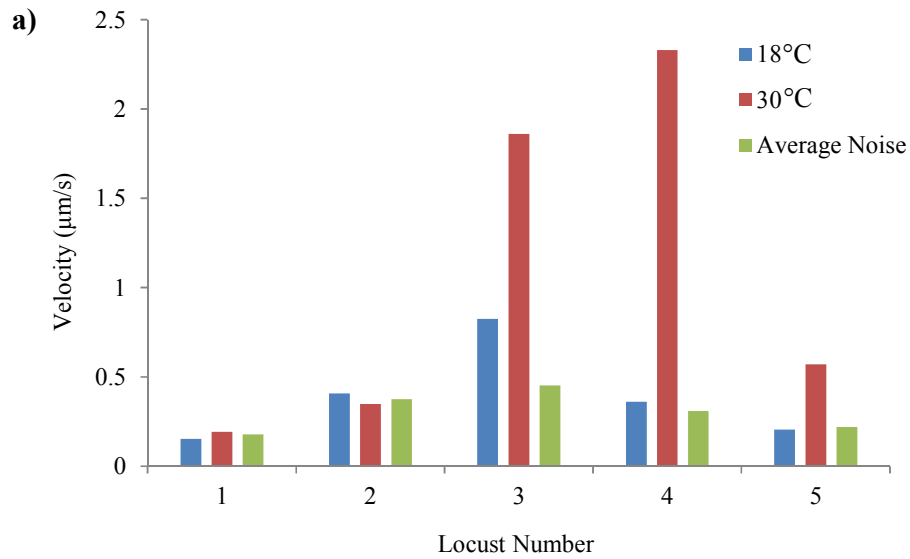

Figure 4.10 a) The velocity of the pyriform vesicle of five individual *L. migratoria* at the $2f_1-f_2$ frequency = 12 kHz, where $f_1= 12.25$ kHz and $f_2 = 12.5$ kHz; at two different body temperatures, 18°C and 30°C. The velocity over the frequencies recorded during the hot recording for locust 3, 4 and 5 are shown below, graph **b)** is the FFT graph of velocity over frequency, showing that the slightly larger velocity recording for locusts 3, 4 and 5 is not relevant for the presence of DPOAEs. The expected DPOAE frequency of 12 kHz is shaded in blue; the noise floor for those recordings is higher than the other recordings. SPL

4.3.5 Blocking Spiracle

A periodic chirp was applied as an acoustic stimulus and recorded over a frequency spectrum from 1-20 kHz. The gain of the membrane at the point of the pyriform vesicle did not change with any significant difference due to the spiracles being blocked (Fig. 4.11). Vibrometry scans of the *S. gregaria* tympanal membranes tested did not show any expected DPOAE deflections on the membrane in any of the different spiracle blocking experiments; no spiracles blocked, one spiracle or both (Fig. 4.12).

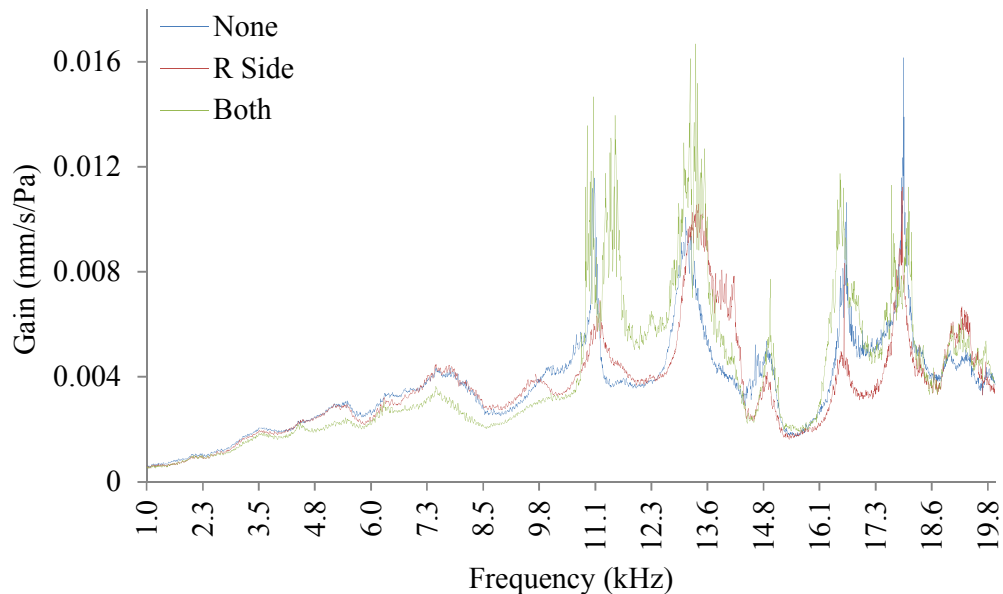

Figure 4.11 The average frequency spectrum of 4 locusts periodic chirp gain at the pyriform vesicle over the average spectrum data: before the spiracles were blocked (blue), when only the right spiracle was blocked (red), and then both spiracles (green). The gain across the frequency spectrum between 1-20 kHz indicates that there was no difference in the membrane behaviour due to blocking the spiracles.

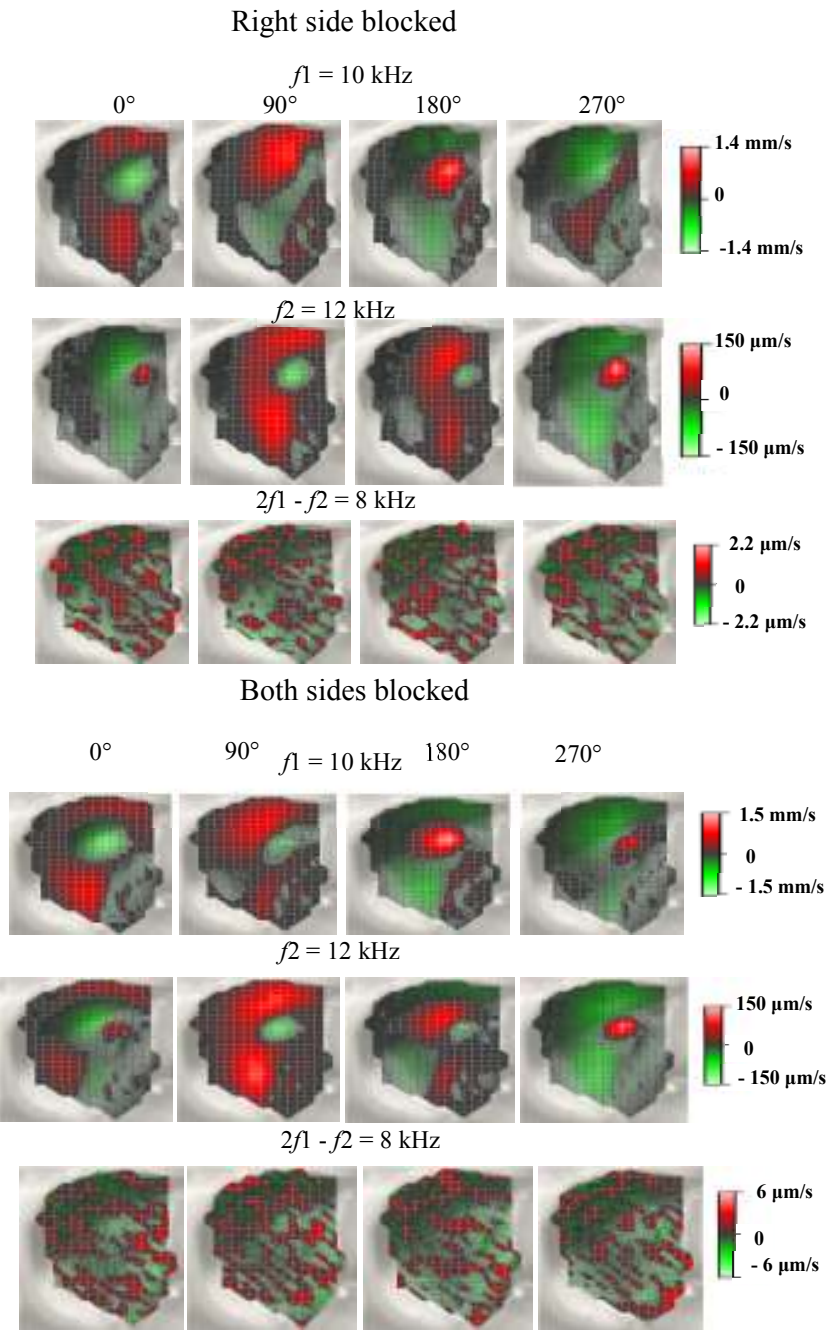

Figure 4.12 Scans of *S. gregaria* tympanal membrane when the spiracle is blocked on one side and on both sides; there is not a significant difference in velocity at any of the three frequencies $f_1 = 10$ kHz, $f_2 = 12$ and $2f_1 - f_2 = 8$ kHz shown over different phases of the oscillation cycle and there is not a coherent point of defection on the $2f_1 - f_2$ scans of the membrane in both states. The sound level for the two tones was 60/70 dB SPL for f_1/f_2 respectively.

4.3.6 High SPL Intensity Experiments

The sound level required to cause distortion of the loudspeaker is not very high in SPL comparatively, the levels used in the current experiments never went above 70 dB SPL. The scans also confirm the lack of any distinct emission from the membrane at the higher SPL levels (Fig. 4.14). It is known in signal processing that intermodulation can occur producing distortions of the sound in the same arithmetic quantities that DPOAEs occur. This can occur when a loudspeaker is overdriven or in a microphone system where the gain is altered so there are a number of possible sources of DPOAE production within the experimental set up that is used. The current measurements did find DPOAEs of small magnitude on the membrane velocity signal at a few of f_1/f_2 values tested using the single-shot settings. However, these were also present on the microphone's sound recording, indicating that it was in fact the loudspeaker producing the distortion (Fig. 4.13). This was confirmed by recording the sound stimulus in the absence of an animal. The DPOAEs were still present despite the animal being absent sound recording eliminating the possibility that the locust tympanal organ was producing the DPOAEs.

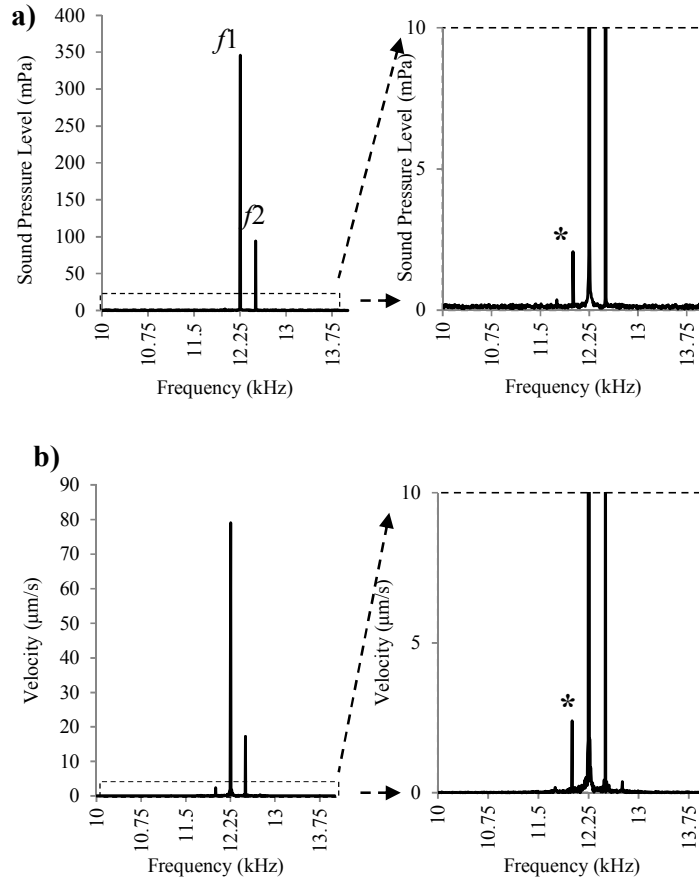

Figure 4.13 Example of DPOAEs present at very high SPLs due to overdriving the loudspeaker. The graph a) show the microphone recording of the two-tones with the DPOAE frequency highlighted with an asterisk (*). Graphs b) is the velocity recording on the PV of a *L. migratoria* individual the DPOAE appears on the FFT highlighted with an asterisk (*). If the animal was removed the microphone recording still showed the DPOAE frequency of $2f_1-f_2$ showing that it was intermodulation of the loudspeaker producing the distortion and not the animal. Scans of the membrane confirmed that the DPOAE was not a being emitted through the membrane.

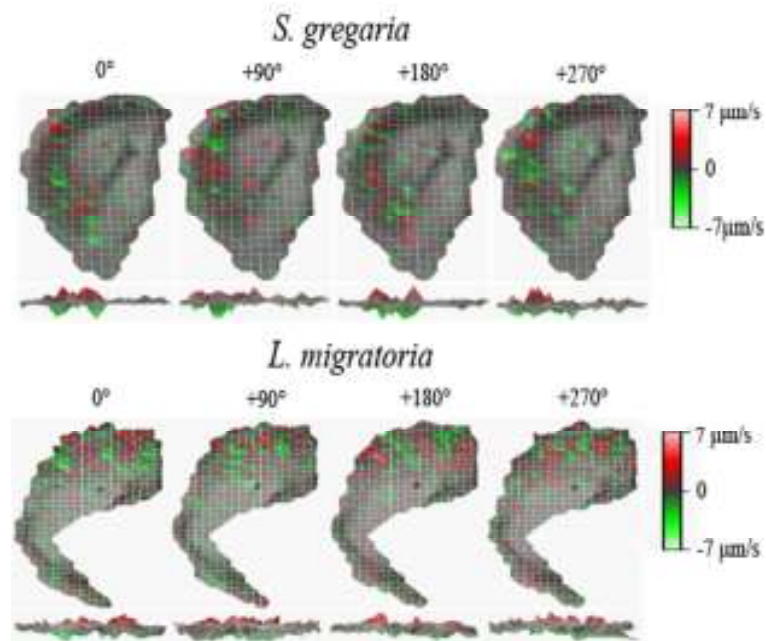

Figure 4.14 Laser vibrometry scan results of the high SPL experiments of both species of locust, from the Rayleigh calculation (Section 4.2.5), a 10 dB SPL emission should produce a measurable velocity of $0.8 \mu\text{m/s}$ as the noise floor of the experiments is $0.2 \mu\text{m/s}$. The laser scans of the membrane of both species did not find a coherent point of emission on the membrane surface. The scans shown are of the $2f_1-f_2$ frequency; 8 kHz, where the two tones were; $f_1 = 10 \text{ kHz}$ and $f_2 = 12 \text{ kHz}$ at 70/60 dB SPL, f_1/f_2 .

4.4 Discussion

Discovered in humans, DPOAEs are known to be produced due to the outer hair cells within the cochlea in mammalian hearing organs (Kemp, 2002). They have also been found in many non-mammalian ears which do not have a cochlea or hair cells, showing that other generation mechanisms are also possible (Manley, 2001; Bergevin et al., 2008). In the previous insect studies DPOAEs could be acoustically recorded. The chordotonal organs, specifically the scolopidial cells, were seen to be directly linked to the production of DPOAEs (Kössl and Boyan, 1998a; Kössl et al., 2008). For example if the d cell's connection to the locust tympanal membrane was severed then the DPOAEs at higher frequencies were reduced, destroying other parts of the membrane did not however affect the DPOAEs (Möckel et al., 2007). Further evidence of the link to the scolopidial cells involvement in DPOAEs was found when an insecticide, pymetrozine, which specifically reacts with the scolopidial cells of insects, was found to reduce the magnitude of the DPOAEs (Möckel et al., 2011). As the scolopidial cells attach to the back of the exposed tympanal membrane in insects, then if the sounds were being produced and emitted through that membrane at these points it appeared reasonable that the sound signature that is produced should be detectable in the motion of the membrane. The current experiments aimed to measure the expected DPOAEs on the tympanal membrane of various insects at frequencies and sound levels previously found to emit recordable DPOAEs. This was carried out using a laser Doppler vibrometer to record the membrane vibrations. Another suggestion to the origin of DPOAEs in locusts was the interaction between the thick and thin joining of the tympanal membrane (Kössl and Boyan, 1998a). Again, if there was any interaction at this region of the membrane then the laser vibrometry scans should detect this. Using a laser vibrometry system DPOAEs were recently shown to be recordable on the ear drums of humans (Dalhoff et al., 2007), the authors also originally tested the experiments on guinea pig ears.

DPOAEs are a characteristic of active hearing processes within sensitive hearing organs. Insect tympanal hearing organs were always previously thought to function passively to received sound (Yager, 1999), until the discovery of DPOAEs

(Kössl and Boyan, 1998b). The tympanal hearing organs of insects are relatively simple in structure; however they have been found to be capable of some very complex sound processing. One example of this is the mechanical filtering of sound of different frequencies using an intrinsic travelling wave on the tympanal membrane of locusts (Windmill et al., 2005). Despite this complexity the locust hearing organ was still thought to function passively as the travelling wave was still present in dead locusts (Windmill et al., 2005). This was also the case for a species of cicada shown to possess a travelling wave on the tympanal membrane (Sueur et al., 2006). However, the presence of a travelling wave in the auditory membrane in other animals was found to be one characteristic that generates DPOAEs (Bergevin et al., 2008). In another type of insect hearing organ, the Johnson's organ of mosquitoes has been found to possess active hearing, where the male antenna is capable of amplifying the low level sounds of the female wings (Göpfert and Robert, 2001; Jackson and Robert, 2006). The mosquito antennal mechanics also show self-generating oscillations with no sound present and they are very sensitive to hypoxic conditions (Göpfert and Robert, 2001).

All previous DPOAEs in insects were recorded acoustically in tympanal organs, using a small coupler next to the tympanal membrane (Kössl et al., 2008). This coupler is placed 1 mm away from the membrane and at some lower frequencies tested it was required to seal the coupler to the body wall (Kössl and Boyan, 1998a). The loudspeakers which produced the two tones and also the microphone which recorded the DPOAEs were contained within the coupler (Kössl et al., 2008). In the experiments described here the sound was produced in the far-field in an open set-up. The two-tones were applied with one loudspeaker; however the sound was continuously monitored with the microphone and so any extra distortion created by the loudspeaker could be monitored.

The current investigations, recording the whole membrane and also specific points on the membrane, did not identify any coherent deflections at the expected $2f_1-f_2$ frequency or any other DPOAE frequency in any individual tested in all three species used; *G. mellonella*, *S. gregaria* and *L. migratoria*. The velocity of the membrane of the locusts was compared to the average background noise across each recording, and there was not found to be a significant difference between these

values (Figs. 4.7a and b). For the moth scanning experiments the same test was carried out on the displacement of the point of receptor cells and the background noise floor, and again no DPOAE was recorded at any frequency tested (Fig. 4.7c). For the locust high sound level experiments where the loudspeaker became overdriven and DPOAEs appeared on the sound recording, (Fig. 4.13), the possibility that the animal was producing the DPOAEs was ruled out, as when it was removed from the set-up the distortion was still present. Using the Rayleigh integral it was calculated that the membrane would be displaced by 12 pm if an emission of 10 dB due to a DPOAEs; however no such displacement was present on the laser vibrometry measurements (Fig. 4.14).

In previous locust experiments it was found that the magnitude of the DPOAEs was reduced when altering their physiological state in various ways (Kössl and Boyan, 1998a; Möckel et al., 2007; Möckel et al., 2011). In the current experiments various different physiological alterations were carried out on locusts to identify if there was any difference to the appearance, or lack of, of DPOAEs whilst recording the membrane with the laser. Previously CO₂ application found a reduction in DPOAE magnitude which was taken to be an indication that the DPOAEs were being produced due to metabolic processes (Kössl and Boyan, 1998; Möckel et al, 2007). However, in other non-mammalian ears that have been found to possess DPOAEs the effect of anaesthesia did not alter the presence or the size of the distortion product significantly (Bergevin et al, 2008). The velocity of the membrane at the applied two-tones was also not significantly altered as a result of the CO₂ application (Figs. 4.8 and 4.9). As it is thought to be a reduction in the metabolism of the insect due to CO₂ that decreases the DPOAE magnitude, (Kössl and Boyan, 1998a), the current experiments make it difficult to comment on. However, the insects' respiratory cycle was visibly altered as a result of CO₂ application; the respiratory movement of the abdomen ceases and the antenna become de-elevated.

Further experiments were carried out, blocking the spiracle next to the tympanal organ. As the spiracle was closed during hypoxia the effect of actually blocking ventilation was also investigated. The reasoning behind these experiments was to alter the pressure inside the animal, as air would not be able to be ventilated in the air sacs backing the tympanal membrane. Previously it was found that pressure

differences in the tracheal sacs altered the membrane deflections and also the sensitivity of the auditory nerve responses (Meyer and Hedwig, 1995). From the results of the experiments (Fig. 4.11) it was found that this did not alter the lack of DPOAEs, or the velocity of the membrane at the $f1/f2$ frequencies. Blocking the main spiracles did not alter the gain across the frequencies tested either (Fig. 4.12).

In the current experiments altering the body temperature of the locusts did not alter the DPOAEs absence across all individuals tested. In other animals tested body temperature alterations were found to affect the magnitude of DPOAEs in a number of ways, either not affecting them, or increasing or decreasing their magnitude (Bergevin et al., 2008). If the DPOAEs present in insect ears are metabolically sensitive as was previously found (Kössl and Boyan, 1998), then changing the temperature could possibly alter the presence of DPOAEs. The effect of body temperature alteration to DPOAEs was not investigated in the previous acoustical recording experiments. However, across the current trials no effect was noted on the membrane deflections at the expected DPOAE frequency at either temperature change (Fig. 4.10). Locust auditory organs have been found to be sensitive to temperature alterations, increasing nerve activity to increasing temperature (Oldfield, 1988). But, as no DPOAEs were recordable on the membrane surface it appears that the increased metabolism due to increasing body temperature does not alter the functioning of the locust ear.

DPOAEs have also been acoustically recorded in moths from different families; in Noctuids (Coro and Kössl, 1998; Coro and Kössl, 2001; Kössl and Coro, 2006) and also in Notodontids (Coro and Kössl, 2001; Kössl et al., 2007). This is despite the fact that these moths have two and only one auditory receptor cell respectively. The emissions did not appear to be affected by the ratio of the frequency as the locust DPOAEs previously recorded did and other arithmetic combinations as well as $2f1-f2$, such as $4f1-3f2$ (Coro and Kössl, 1998). The DPOAEs were affected by the application of ethyl ether (Coro and Kössl, 2001). The results from the laser vibrometer of the greater wax moth did not find any recordable emissions on the surface of the membrane (Figs. 4.5 and 4.7c). This was the case over all frequencies tested, between 20 to 130 kHz, within the best frequency of the hearing organ. The most likely point of emission was thought to be at the point of

receptor cell attachment as the scolopidial cells are thought to be a likely candidate for the origin of the non-linearity (Kössl et al., 2008). At all frequencies the displacement at the expected DPOAE frequency was found not to be significantly different to the background displacement value calculated from the average recordings over the frequency spectrum with f_1 , f_2 and $2f_1-f_2$ removed.

Other types of otoacoustic emissions are also known; such as electrically and spontaneously evoked otoacoustic emissions in both mammalian and non-mammalian ears (Probst et al., 1991; Bergevin et al., 2008; Manley, 2001). The SOAEs, which are by-products from spontaneous behaviour of the hair cells in the mammalian cochlea in mammals, are recordable without any sound stimulus. The presence of these within a hearing organ has been described as the most dramatic evidence that a hearing organ possesses active hearing (Manley, 2001). In previous acoustical insect DPOAE experiments no SOAEs have ever been recorded in any insect investigated. Only DPOAEs have been found to be present in insect ears (Kössl et al., 2008).

The mechanical behaviour of the chordotonal organs in tympanal organs may introduce active mechanisms as the processing of the sound after the membrane activation is not fully understood. As the current laser vibrometry recordings did not find any coherent DPOAEs on the membrane surface it may be that any active processes relating to previous acoustic recordings of DPOAEs are due to the receptor cells. It was previously found that the Müller's organ of locusts showed complex oscillations, this was however at very high sound levels of 110 dB SPL in isolated tympanal organs (Breckow and Sippel, 1985). It is not known what oscillations do occur in insect tympanal organs, if any, after the sound has been transduced through the membrane. It would be very interesting to examine the mechanics of the Müller's organ in an intact locust to determine if any active processes are detectable. Further, the mechanics could be investigated in hypoxic conditions. Electrophysiology could also be used to investigate the response of the locust auditory nerves to determine if there is any non-linear processing occurring at the neural level of the hearing organs.

Investigating the response of the membrane in a closed set up, similar to that in which DPOAEs were previously acoustically recorded would also be valuable. That type of setup may alter the presence of the DPOAEs, such that if a closed coupler

was used as before, then recording the vibration of the membrane using laser vibrometry may reveal the origin of the DPOAEs. However, in the current experiments the sound levels and noise floor were calculated to be low enough such that the largest DPOAEs acoustically recorded should be detectable through the vibration they would cause if resulting from the deflection of the membrane. It may not be the sound field difference in the current experiments that is the cause of the absence of DPOAEs. As the function of the insect tympanal hearing organ is not fully understood it may still be that the site of production of DPOAEs could still be discovered.

Chapter 5:

Ultra high frequency response in the greater wax moth

Part of this chapter is currently under review for publication: Moir, H. M., Jackson, J. C. and Windmill, J. F. C., 2012, Ultra high frequency hearing in a 'simple' ear, Proceedings of the Royal Society B

5.1 Introduction

Greater wax moths (*Galleria mellonella*), (Fig. 5.1), are a pest of bee hives, due to this they are known to have a worldwide distribution and as such they are found in many different environments (Spangler, 1984b). The moths inhabit beehives where their larvae eat the wax produced by the bees, causing destruction of the hive (Spangler, 1986a). The moths use an unusual mating system based on the males producing ultrasonic calls to attract females (Spangler, 1985; Spangler, 1986a). There is also a pheromone aspect of the courtship, where the males release pheromones during courtship, this occurs whilst also calling (Spangler, 1987). Hearing in greater wax moth evolved due to predation pressures by echolocating hunting bats, as it did for all other known moth hearing organs (Hoy, 1992). The moths respond with evasive behaviour to stimulated bat calls (Spangler, 1984b). The aim of the current work was to investigate the upper limit of frequency range of the hearing of the moths as it was previously suggested that this could extend above 200 kHz (Spangler and Takessian, 1983).

In previous studies of the hearing sensitivity of greater wax moths there was some suggestion that the hearing range could be very high in terms of frequency in comparison to other known moth hearing sensitivities (Spangler and Takessian, 1983; Spangler, 1984b). This upper range of sensitivity was never confirmed with physiological studies of the hearing organ and has not been investigated since the original work in the 1980's. The current chapter aimed to investigate the greater wax moth hearing organ using a combination of laser vibrometry and electrophysiology methods, with an ultrasonic transducer to produce the sound stimulus, in order to see how high in terms of frequency the moths can actually hear.



Figure 5.1 Ventral side of a male adult wax moth, scale bar = 5 mm.

5.1.1 Tympanal hearing organs of the greater wax moth

The paired tympanal hearing organs of the greater wax moth are located on the first abdominal segment (Fig. 5.2). Greater wax moths are of the family Pyralidae which has many other known examples of hearing organs, all described as having a similar unusual morphology (Spangler, 1988a). The moth's hearing organs have evolved to be used for a dual purpose: bat detection and intra-specific communication. As such the frequency range of sensitivity is known to be relatively large in comparison to moths whose ears only function as bat detectors (Fullard, 1998). There are four auditory receptor cells, A1-A4, which attach to the membrane, visible as an opaque region of the membrane (Chapter 3: Fig. 3.2). There is also the non-auditory B cell.

The previously known frequency range for this moth was 20-120 kHz in terms of neural auditory recordings (Skals and Surlykke, 2000). However, earlier behavioural studies investigating various sound response behaviour of greater and also the closely related lesser wax moth, suggested that the frequency sensitivity range may be higher, (Spangler and Takessian, 1983; Spangler, 1984b). Laser interferometry of the tympanal membranes also indicated that the frequency range could go up to 300 kHz (Spangler and Takessian, 1983). Further behavioural tests investigated the tilting of the tympanal organs due to muscle contractions, believed to

be a signal of sound receptivity. This behaviour was seen in both lesser and greater wax moths above 300 kHz (Spangler and Takessian, 1983) The evasive manoeuvres of flying wax moths were also investigated to applied ultrasonic sounds up to 260 kHz. The moths reacted by carrying out the classic behaviour described originally by Roeder (Roeder, 1962; Roeder, 1965), for Noctuid moths of diving in response to high intensity ultrasound (Spangler, 1984b). Yet another behavioural test with ultrasonic frequencies was carried out on both male and female greater wax moths inside a chamber; using an actograph which records walking movement showed that the activity ceased inside the chamber with sounds up to 262 kHz (Spangler, 1984b). Despite this extensive work the ultra-high ultrasonic hearing response was not investigated physiologically. Therefore in most recent research on wax moth hearing it is not mentioned, with the range of hearing in greater wax moths documented as a maximum of 120 kHz as found in electrophysiological recordings (Skals and Surlykke, 2000).

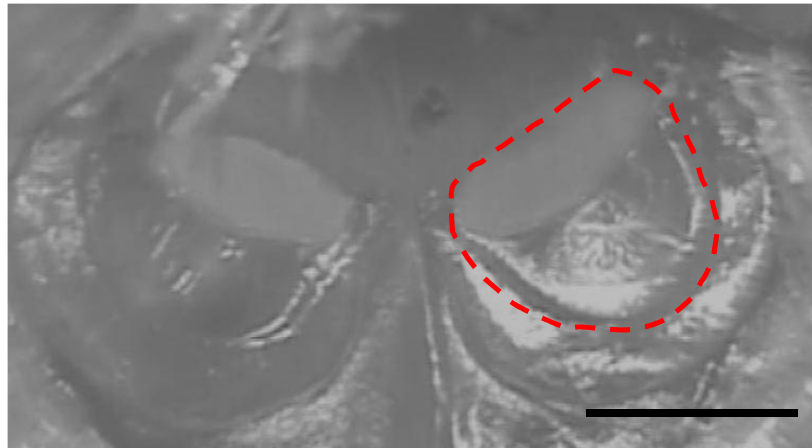

Figure 5.2 The paired tympanal membrane of the greater wax moth taken from the video feed of the laser vibrometer, with the membrane on the right outlined in red. The mesothoracic segment is being held back to expose the membranes. The membranes are roughly 0.5 mm across horizontally at the widest point, there is a sex difference in terms of size of membrane with the females having slightly larger area than the males (Spangler and Takessian, 1983). Scale bar = 0.5 mm.

5.1.2 Sound production and communication

Greater wax moths also use their hearing sense in intra-specific communication for pair-formation (Spangler, 1985). The males of the species produce sound with structures known as tymbals located on tegulae of the wings, where the forewings attach (Fig. 5.3). The sound is produced as the wings are beaten with a train of ultrasonic pulses being produced due to the pressure of the wings causing the tymbal to buckle; another pulse is produced as the wing is raised. Sound pulses produced have a peak frequency around 75 kHz, and the peak sound intensity is around 80 dB SPL measured 1 cm from the tymbal (Spangler, 1986a), other male moths are also required to be present and if the moths are isolated they do not call (Spangler, 1988b). The sound is produced to attract females and form pairs to mate. There is also a pheromone aspect involved to pair forming, but the sound production may increase the detection distance, as the pheromones are only effective in close contact (Spangler, 1987). Chorusing behaviour in males has been documented, with several males calling in close proximity to one another. This behaviour may increase the sound level, and so increase the chances of detection by females to help with mate formation (Spangler, 1986a). Also, males are known to prefer to call from within the beehive when few bees are present, and are not known to commonly call together outside of the hive (Spangler, 1985). Female wax moths respond to the male calls by wing fanning to display; males then produce pheromones to guide the female to him (Spangler, 1987; Jones et al., 2002). The females were also found to possess some temporal discrimination of sounds. The sounds produced by greater wax moths have some characteristics similar to the calls of hunting bats, but it was found that female moths were capable of distinguishing between bat and moth calls, displaying when a male call was played and ceasing the display when bat calls were played (Jones et al., 2002). Males may also be responsive to the low frequency produced by the female wing beat, (Spangler, 1985), males would continue to wing fan in response to electronically applied low vibrations through the substrate. The moths were further

found to appear to distinguish between the bees in the hive's vibration and their own thought to help preserve pheromone production (Spangler, 1987).

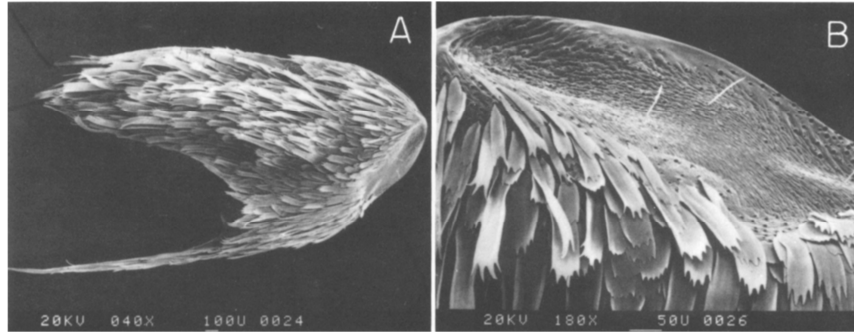

Figure 5.3 Scanning electron micrographs of a tymbal from male *Galleria mellonella*, taken from Spangler, 1986, the tymbal produces sound pulses when the wings are beaten.

5.2 Materials and Methods

5.2.1 Animals

Larval greater wax moths were obtained from Livefood UK Ltd., (Somerset, UK) and kept in conditions which have previously been described (Chapter 2: Section 2.1.2i). The adult moths were pinned onto a plasticine block with their wings and abdomen held back by staples, the legs were removed. The mesothoracic segment was held back using a staple to expose the paired tympanal membranes on the first abdominal segment for the laser scans, or the first leg stumps to expose the thorax for electrophysiological recordings.

5.2.2 Laser Vibrometry

The standard laser vibrometry set up was used as has previously been described (Chapter 2: Section 2.2). The restrained moths were placed in front of the close-up head. The moth had to be tilted slightly downwards to obtain a clear view of the tympanal membrane on the video feedback. The right tympanal membrane was used for all moths tested as it was positioned nearest to the sound source due to the layout of the equipment. Single frequency sine waves were created using a function generator (Tektronix, Dual Channel-AFG 3102; Bracknell; UK), which were passed to an air-coupled transducer, powered by a high voltage power supply. Sound pressure level was altered in steps of 10 dB SPL using an attenuator (JFW Industries, 50BR-009; Indianapolis; USA). The ultrasound transducer, mounted onto a tripod stand, was directed towards the tympanal organ at exactly the same height since the ultrasonic beam produced was spatially very narrow. The entire membrane area was selected to be scanned at the peak frequency of 80 kHz to check that the membrane was intact and the displacements were normal, (see Chapter 3: Section 3.3.2). Once these were deemed to be normal a smaller area around the receptor cell attachment point was then selected and scans were carried out for the remaining frequencies (Fig. 5.5). Frequencies were used between 50 – 300 kHz in steps of 5 kHz and at three different SPL's; 70, 80 and 90 dB SPL. This was repeated for 10 moths of each sex, giving $n = 20$. The scans were then analysed using the PSV software, and the

maximum point of deflection for each scan was noted. The results were collated and the average displacements for each sex were calculated and plotted.

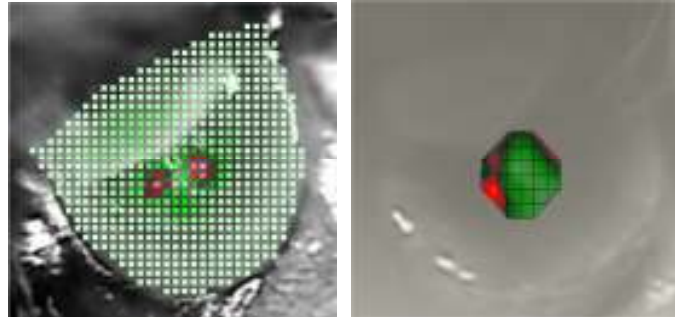

Figure 5.4 Area of the membrane scanned in the laser vibrometry measurements, once the correct response was found for the membrane surface the smaller area of the receptor cell attachment point was selected.

5.2.3 Electrophysiology

The moths were initially put into a refrigerator for a few minutes to immobilise them. They were then pinned to a plasticine block dorsal side up using staples over the wings and two bent staples to secure the abdomen. The legs were removed and another staple was used to pull back the first set of leg stumps to expose the thorax. The moths were then dissected to expose the nerve ganglion as is explained elsewhere (Chapter 2: Section 2.4.1). Two tungsten hook electrodes, (explained in the Appendix 2: Section A2.2 and A2.3), were used to detect the neural activity, the nerve electrode was held in place and controlled with a micromanipulator (M3301R, WPI; Hitchin, UK) and the reference electrode was held in place with Blu-tac. Once the nerve was successfully hooked and the reference electrode was in place in the abdomen, the dissecting microscope was removed and an air-coupled transducer was set in place directly above the moth. The sound pulses were produced by a function generator (TTI Instruments, TGA12102; Huntingdon, UK), with each sound pulse lasting 20 milliseconds. The frequency of the sound was set using the function generator. All sounds used were a continuous sine wave. The neural response were detected via the electrodes and passed through an amplifier (DAM 50, WPI; Hitchin,

UK) and then passed to an oscilloscope (Tektronix, DPO 2014; Bracknell, UK). The oscilloscope recording was transferred to a LabVIEW program (National Instruments, 8.6.1) via a USB link, and the data was saved as a text file (see Appendix 1: Section A1.3). The sound pulses were also transferred to the oscilloscope and this information was also saved to the text file. The sound level was altered using a step attenuator (JFW Industries, 50BR-009) which allowed the sound to be increased or decreased in steps of chosen units of dB SPL, between frequencies of 80 – 300 kHz (in steps of 20 kHz), (see Fig. 5.6 for experimental setup). This was repeated using 8 moths of each sex, n = 16. To analyse the electrophysiology data a custom built LabVIEW program (Appendix 1: Section A1.3), which also filtered the data to remove noise from the recordings, was used. The neural threshold was calculated using criteria previously used, where 2 or more A cell spikes were present in 8 out of 10 sound stimuli (Skals and Surlykke, 2000).

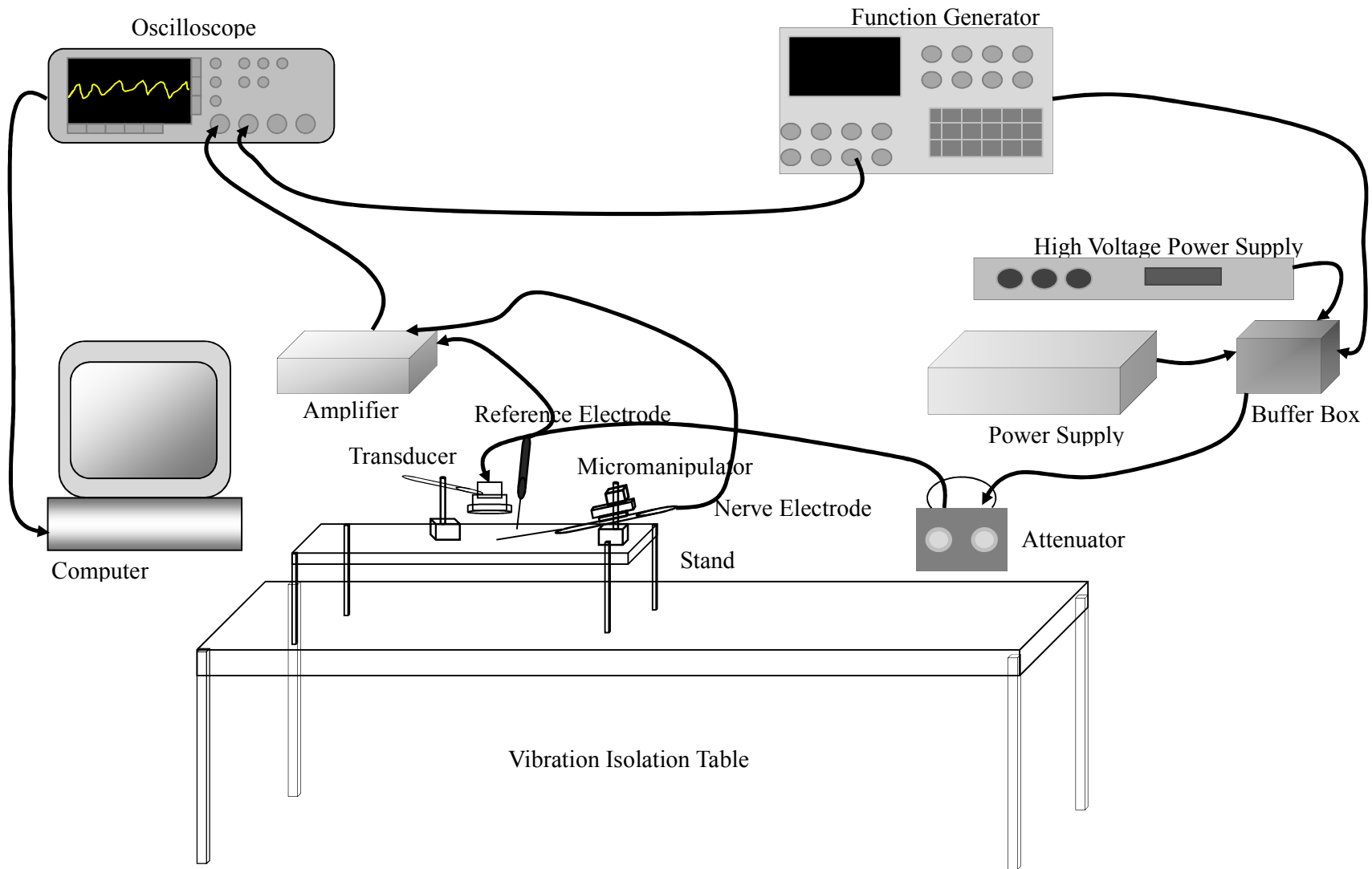

Figure 5.5 Equipment setup of electrophysiology experiments.

5.2.4 Simultaneous recording of laser vibrometry and electrophysiology

Experiments were carried out to record the electrophysiology signal, the sound and the laser vibrometry measurements simultaneously, so that all three could be plotted in time. As the sampling rate required was 1.024 MHz, running over a period of 512 ms, the oscilloscope could not be used for these experiments due to lack of memory space, and so the laser vibrometer acquisition system was used to record the data. As the laser vibrometer system used has only one reference channel, the sound pulses produced by the function generator and the electrophysiology voltage signal were combined with a custom-built summing amplifier, and recorded using the single reference channel (Appendix 2: Section A2.5). The laser vibrometer voltage signal of the membrane displacements was recorded through the normal channel. The recorded data set of the combined sound and electrophysiology data was analysed afterwards with LabVIEW (Appendix 1: Section A1.4). As the two signals occupy different frequency bands they were separated using bandpass filters (Bessel for linear phase response). The moth was prepared as for electrophysiology experiments. Once the nerve had been hooked, and the sound reaction of the nerve confirmed, the laser was then moved into place. The close-up head of the laser was attached. The attachment point was identified and the signals for both channels were recorded for 512 ms using the single-shot setting. The sound stimulus was produced as was previously described for electrophysiology experiments. A range of frequencies were used, with a high sound level of 100 dB SPL used so that the response of hearing organ would be easily detectable on both the laser vibrometry and electrophysiology recordings.

5.2.5 Sound production using the air coupled ultrasound transducer

The current experiments used a custom built ultrasonic transducer. This was used as commercially available loudspeakers can only produce sound in frequencies up to around 140 kHz, see Chapter 2: Section 2.2.4 for further discussion on the composition of the transducer and the equipment used to power the transducer.

5.3 Results

5.3.1 Laser vibrometry results

5.3.1i Laser vibrometry scans

Laser vibrometry scans show that the membrane of the greater wax moth moves in the same manner as was found for lesser wax moths (Rodriguez et al., 2005). The counter-tympanic and membrane proper moved out of phase of each other at low frequencies, around 40 kHz (Chapter 3: Fig. 3.8). It is not known why this occurs, but one possibility may be due to the counter-tympanic membrane being thicker and therefore having a resonance at low frequencies. At all frequencies tested the receptor cell attachment point undergoes a higher displacement, see Chapter 3: Section 3.3.2 for further details of the mechanics of the membrane. At higher frequencies only the attachment point of the receptor cells moved (Fig. 5.10).

The laser vibrometry scans of the smaller area of the attachment point were analysed and the maximum point of displacement were collated over frequencies 50-300 kHz, for $n = 16$ moths, $n = 8$ for each gender, this was plotted (Fig. 5.13). The average for all the moths tested found a maximum displacement at 90-95 kHz, average for all moths tested, $(13.7 \pm 3.3 \text{ nm, s.e. (standard error), } n = 16)$; which correlates with the male moth's calling frequency (Spangler, 1986a). The average when the sexes were split did show a difference of frequency for the maximum displacement value, males: $14.6 \pm 4.9 \text{ nm, } n = 8$ at 115 kHz and females: $17.2 \pm 5.5 \text{ nm, } n = 8$, at 85 kHz, where the error shown for both is the standard error, the values are at SPL's of 90 dB SPL. The females displacement curve appeared to be tuned to the male calls, at 70-100 kHz, but there was no difference between the sexes displacement values when statistically tested (One-way ANOVA, $P = > 0.1$, $n = 8$ for each sex). This may be due to the large variation between individuals tested. This difference of best frequency in relation to displacement between the sexes is also found at the other sound levels investigated, 70 and 80 dB SPL. At 70 dB SPL, the maximum displacement for males: $1.3 \pm 0.4 \text{ nm}$ at 120 kHz and for females: $1.5 \pm 0.6 \text{ nm}$, where the error shown was standard error. At 80 dB SPL the maximum male

displacement was: 3.7 ± 1.5 nm at 140 kHz, and for females: 5.7 ± 2.2 nm at 90 kHz. At all frequencies investigated the receptor cell attachment point was still being displaced above 1 nm, up to 300 kHz (mean \pm s.e.; 1.2 ± 0.5 nm, n=16 moths) at 80 dB SPL. The displacement graphs at sound levels 70 and 80 dB SPL can be found in the Appendix 2: Section A2.6. It was previously found that the Noctuid moth tympanal membrane requires a minimum displacement of approximately 100 pm to elicit a neural response (Windmill et al., 2007). This suggests that the greater wax moths are capable of detecting sounds of up to 300 kHz at a reasonable sound level, 80 dB SPL. To confirm this level of sensitivity in the greater wax moth electrophysiology recordings were carried out.

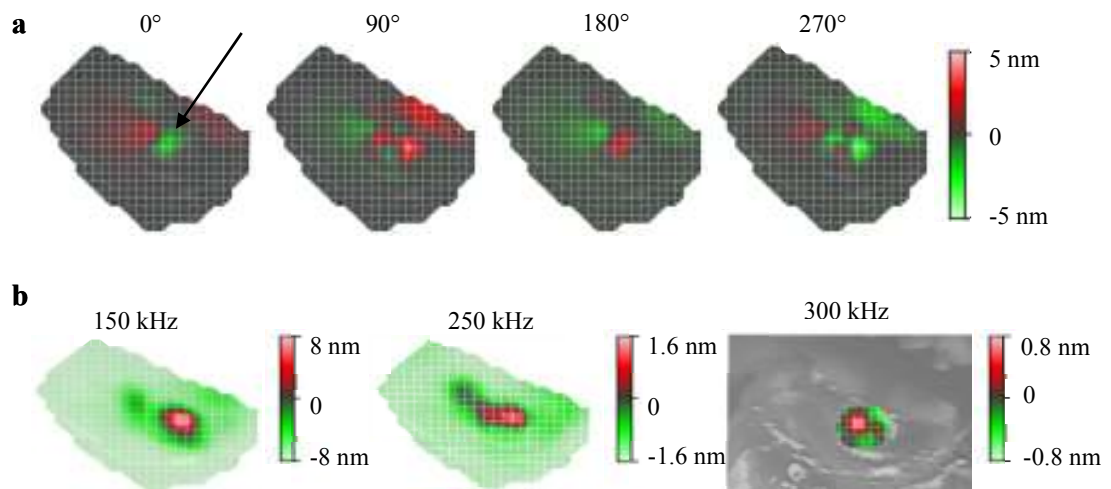

Figure 5.6 a) Laser vibrometry scans of a female greater wax moth when the sound stimulus frequency was 80 kHz at 90 dB SPL, the scans are shown over 4 phases of the oscillation cycle, 0 - 270°. The attachment point is highlighted with an arrow. **b)** Laser vibrometry scans of the same female wax moth as **a)** when the sound stimulus was 150, 250 and 300 kHz, all sound levels are 90 dB SPL. As the microphone cannot record the sound level at these frequencies the phase data cannot be shown. The scans show that the receptor cell attachment point is being displaced up to 800 pm.

5.3.1ii Temporal acuity results

The moths may also benefit from a large range of frequency sensitivity in order to provide greater temporal acuity. To assess if this was the case we calculated this from the average displacement curves measure with the laser vibrometer [5.1]. This was calculated as the full width at half maximum (FWHM) from the displacement curve averages of the sexes (Fig. 5.7).

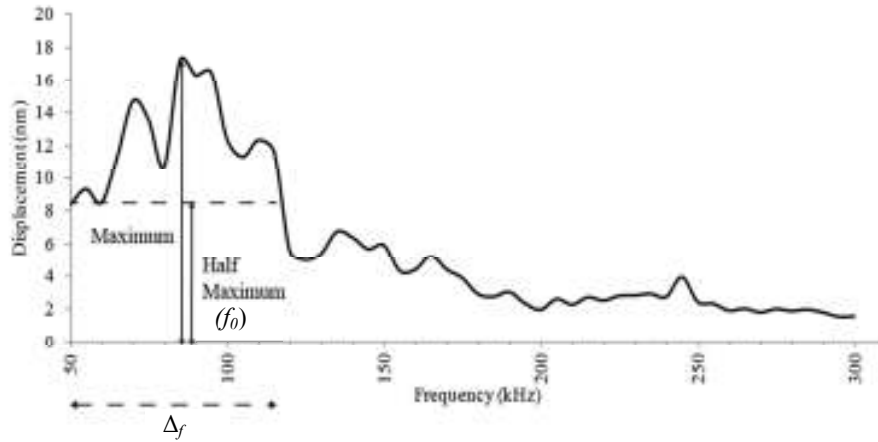

Figure 5.7 Displacement curve calculation for the full width half maximum. The curve is the average females investigated using the laser Doppler vibrometer.

$$Q = \frac{f_0}{\Delta_f} \quad [5.1]$$

Where Q = the number of cycles it takes for 99% of the energy to dissipate, due to f_0 being the half the maximum displacement in this case, over the frequencies at the value or above of the half maximum displacement (Δ_f). From this the time it takes can be calculated:

$$T = \frac{1}{\Delta_f} \quad [5.2]$$

The normalised data was fitted to a Lorentzian model to calculate the effective mechanical resonant frequency (ω_0) and dissipation (γ) of the greater wax moth ear:

$$A = \frac{F_0}{\sqrt{(\omega^2 - \omega_0^2)^2 + \gamma^2 \omega^2}}$$

[5.3]

where $\omega = 2\pi f$ and $\omega_0 = 2\pi f_0$.

$$Q = \frac{\omega_0}{\gamma}$$

[5.4]

From this the quality factors (Q) were calculated as 1.35 ± 0.13 and 0.94 ± 0.13 (mean \pm standard error) for males and females respectively ($n = 8$) [5.4].

$$Q = \frac{2\pi F_0}{\gamma}$$

[5.5]

The quality factor can be interpreted as the number of cycles needed to reach maximal displacement, and so the temporal acuity can be calculated as $10.21 \pm 0.95\mu\text{s}$ and $8.96 \pm 1.19\mu\text{s}$ (mean \pm standard error) for males and females respectively [5.5]. This is lower (better) than the values of temporal acuity previously recorded in other moths such as the lesser wax moth, between $20\text{-}50\mu\text{s}$, (Rodriguez et al., 2005) and noctuid moths, $60\mu\text{s}$, (Scholten et al., 1981).

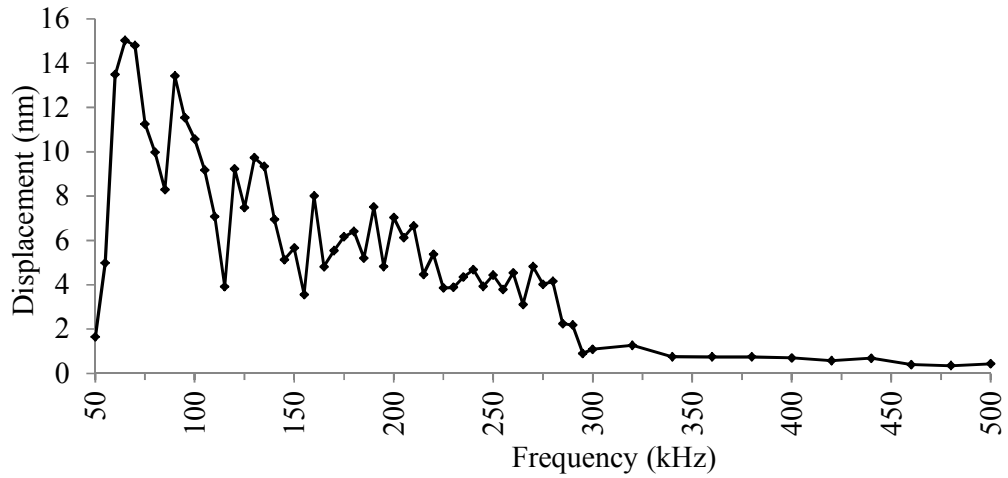

Figure 5.8 Single-shot recording using the laser vibrometer of an individual female wax moth displacement measurements of the receptor cell attachment point using sound stimulus frequencies from 50 kHz up to 550 kHz using the laser Doppler vibrometer, when the sound stimulus is 90 dB. The displacements are above 2 nm up to 295 kHz. The vibration is still responding with relevant displacements up to 300 kHz, at 550 kHz the displacement is 589 pm.

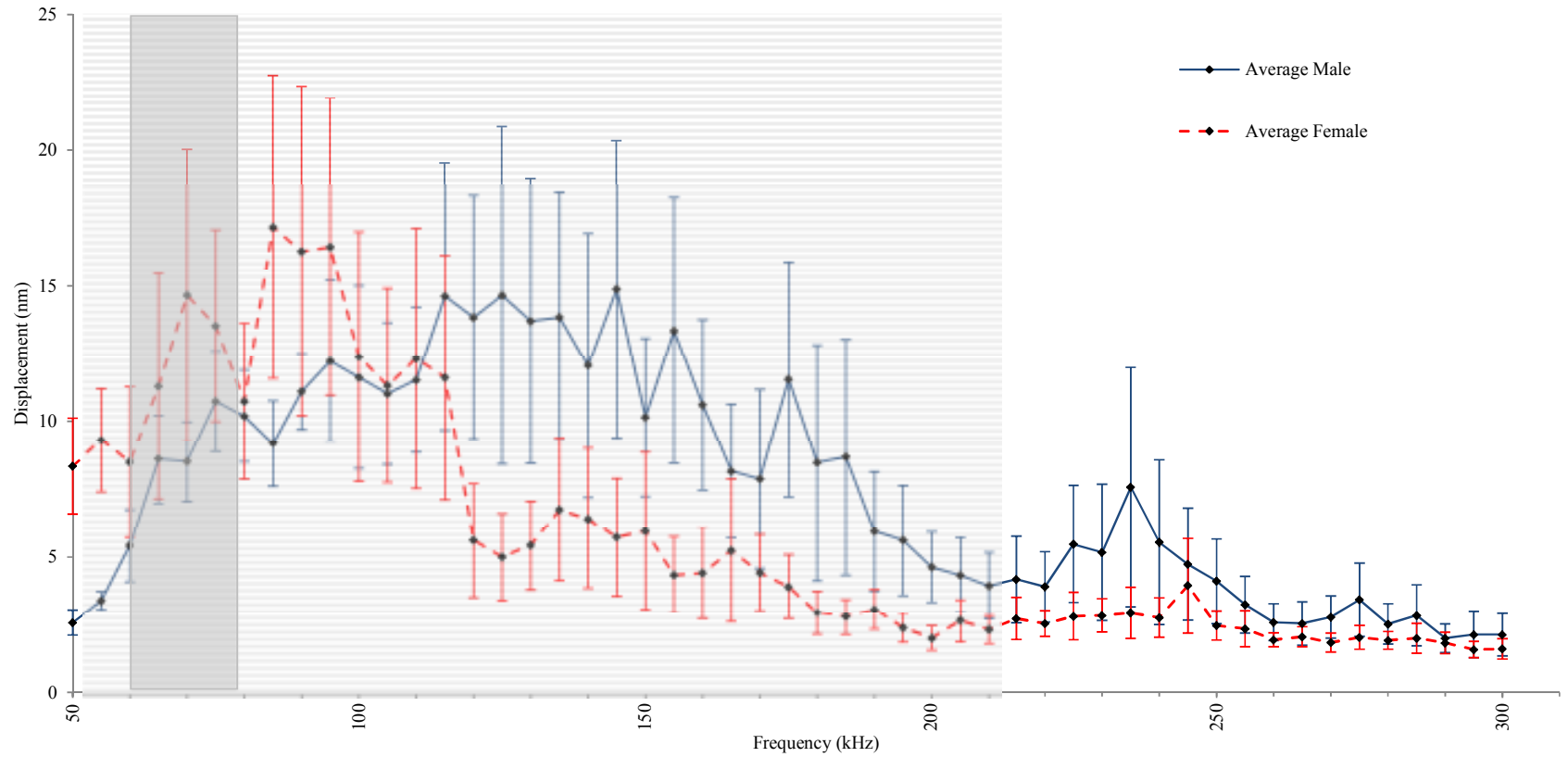

Figure 5.9 The average displacement of the attachment point of male (blue), $n = 8$ and female (red), $n = 8$ greater wax moths over frequencies between 50-300 kHz at 5 kHz increments, the error bars are all standard error. Statistical tests did not find a significant difference between male and females (One-way ANOVA, $P = > 0.1$, $n = 8$ for each sex). The range of bat echolocation frequencies are shown in grey lines with the frequency of the male calls in solid grey.

5.3.2 Electrophysiology results

Electrophysiology recordings were analysed using a custom LabVIEW program (Version 8.6), see appendix for more detail. The neural threshold response of the moths was identified using the same criteria as a previous electrophysiology study of greater wax moths (Skals and Surlykke, 2000), where 2 or more auditory spikes are present in 8 out of 10 sound stimuli, to overcome potential false positives due to the auditory cells, and also the B cell's, spontaneous firing rates coinciding with the sound stimulus (Fig. 5.10). Recordings between 80 - 300 kHz, at SPLs between 45 - 90 dB SPL, were analysed and the lowest level that the criteria was reached was noted as the threshold. This data was collated and plotted (Fig. 5.12). The highest sensitivity found for the neural recordings carried out in this work was at 80 kHz: (54.9 ± 1.0 dB SPL, mean \pm standard error (s.e.); $n = 20$), the males were found to be slightly more sensitive than females, males; (53.4 ± 1.3 dB SPL), and females; (59.2 ± 1.5 dB SPL) both at 80 kHz. However, gender data was divided and analysed separately, but no difference was found (Mann-Whitney U Test, $P = > 0.1$, $n = 10$ for each sex). From the electrophysiology recordings it was found that the majority of moths tested still produced a neural response up to 300 kHz. However, not all moths were found to react to tones of 280 and 300 kHz, at 280 kHz, 2 out of 20 individuals did not respond at 90 dB SPL, and in 5 out of 20 individuals tested, 300 kHz sound pulses at 90 dB SPL did not elicit nerve spikes. The auditory threshold level for the responding moths remained at a biologically relevant sound pressure level sensitivity at the very high frequencies investigated for the majority of individuals tested; 280 kHz (81.9 ± 1.9 dB SPL, mean \pm s.e.; $n = 18$) and at 300 kHz (86.3 ± 1.7 dB SPL, $n = 15$) (Fig. 5.11).

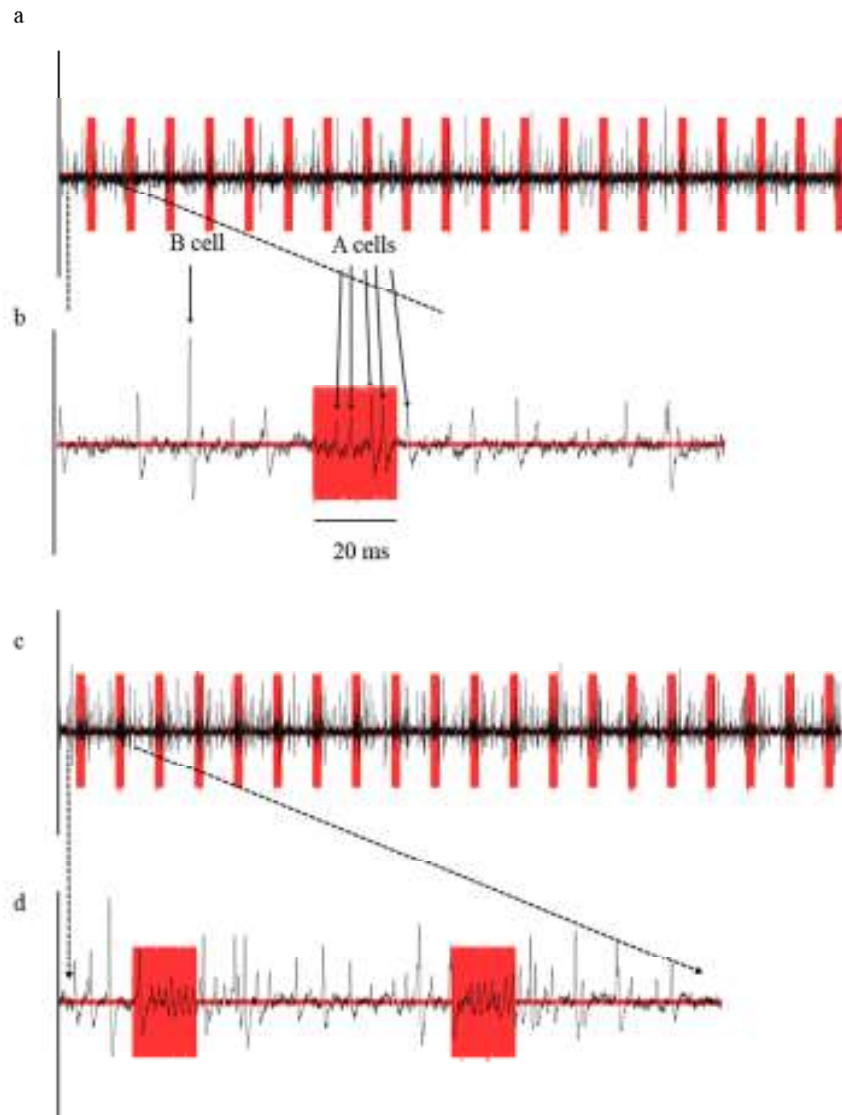

Figure 5.10 Examples of electrophysiological recordings. The above examples are from a female moth when the sound stimulus was at 80 kHz – where **a**) is the recorded nerve response of a female wax moth at the threshold level of 80 kHz, the best frequency tested. **b**) shows the close-up view of a sound pulse, the criteria for calculating the threshold was at least 2 A1 cell spikes are present for 8 out of 10 sound stimuli, the B cell and the A cells are pointed out with an arrow. **c**) is the recorded nerve reaction to 80 kHz at 90 dB and **d**) is the close up view of 2 sound pulses of the recording showing all the A1-A4 cells firing due to the increased sound intensity.

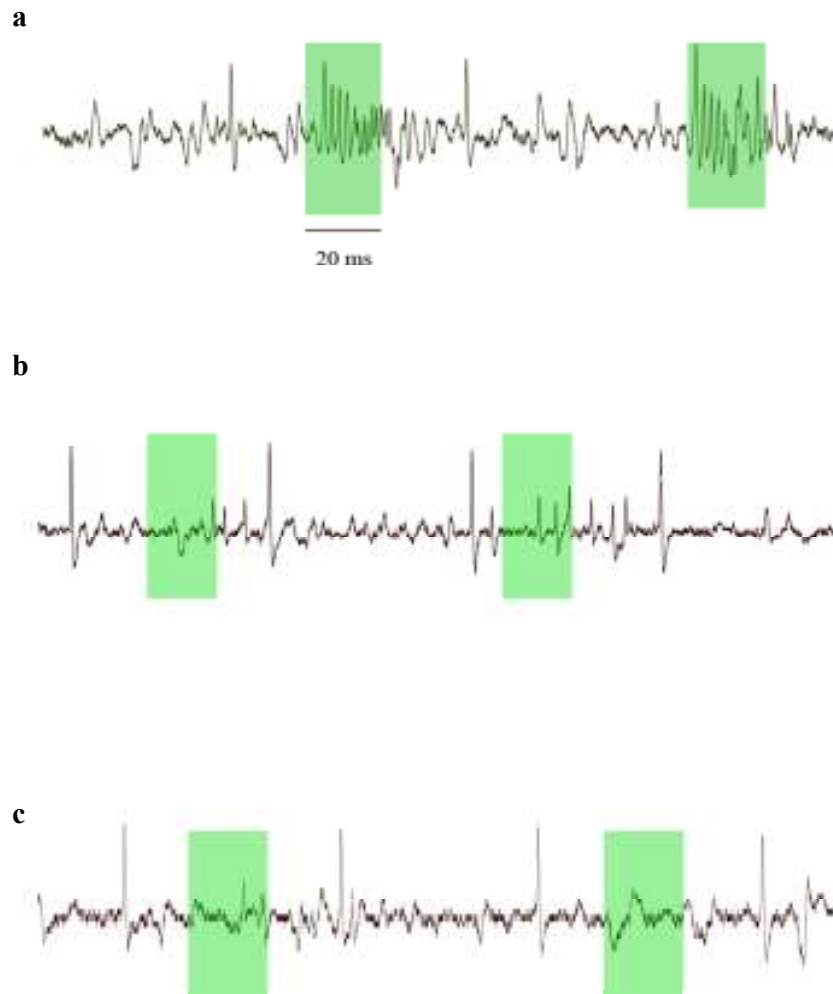

Figure 5.11 Neural recordings from a female moth when the sound stimulus is **a)** 260, **b)** 280 and **c)** 300 kHz, all sound levels are 90 dB SPL. The green area highlights when the sound is on for each recording. The nerve spikes are clear at 260 and 280 kHz but at 300 kHz the nerve spikes are not present, this means that this particular moth would have a limit of 280 kHz.

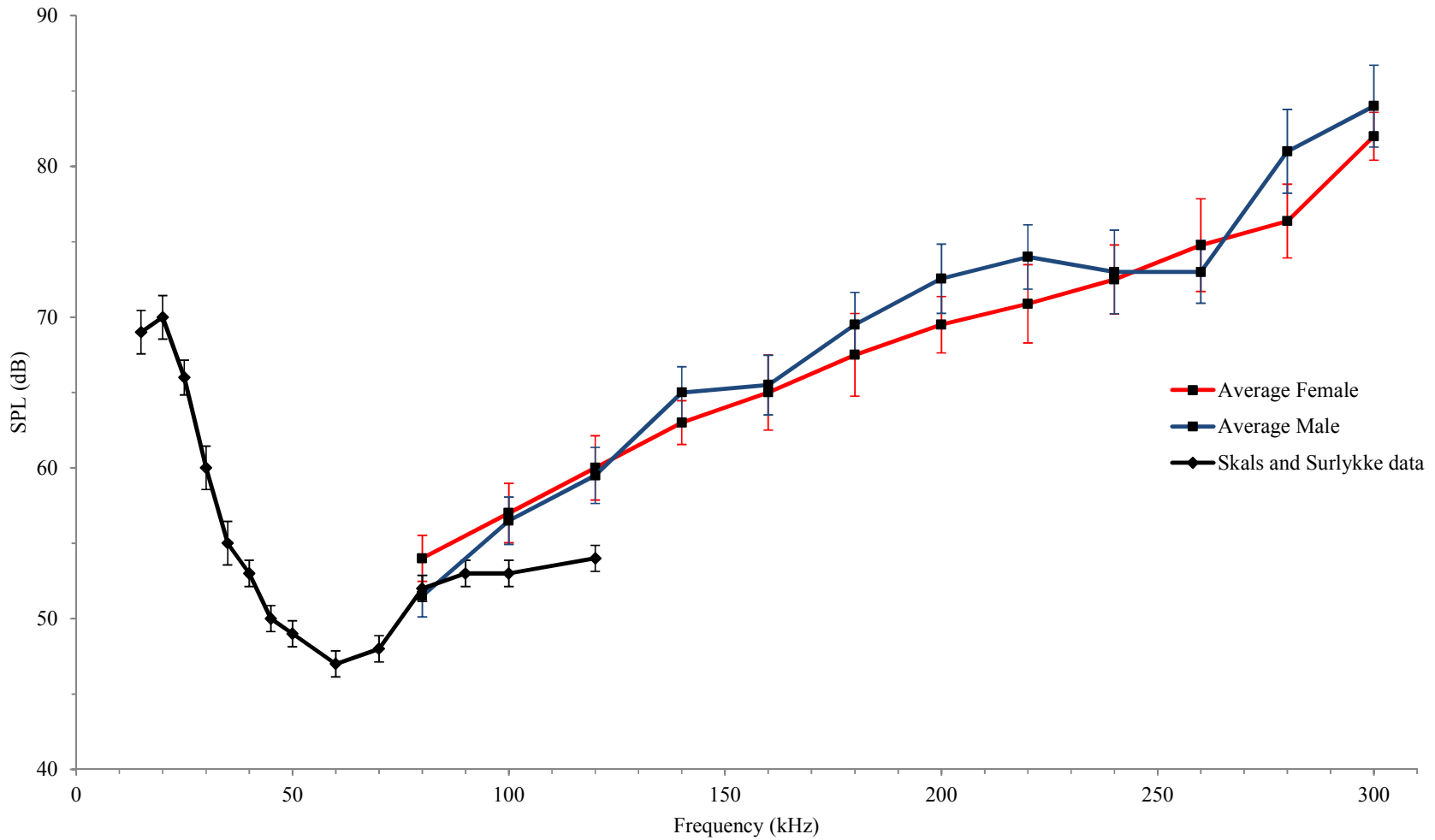

Figure 5.12 Threshold curve of the auditory nerve response from the electrophysiological recordings. The graph shows the neural threshold response of the greater wax moth where the average male and female ($n = 8$) is shown. The previously found neural threshold level by Skals and Surlykke (2000) is also shown for comparison. All error bars shown are standard error.

5.4 Combined Laser and neural measurements

The three recorded data sets of electrophysiology, laser vibrometry and the sound stimulus could be plotted together in time, allowing the vibration on the membrane caused by the ultrasonic sound pulse and then the neural reaction due to this displacement all to be recorded (Fig. 5.13).

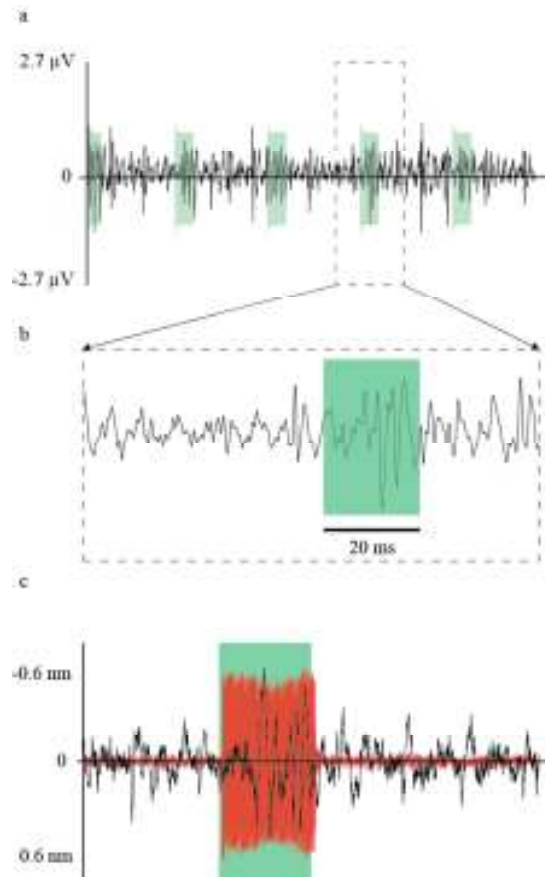

Figure 5.13 The simultaneous recording results of the electrophysiology and laser vibrometry recordings of an individual male greater wax moth at a sound frequency of 200 kHz at 100 dB SPL. **a**, shows the nerve recording (black trace) and the sound stimulus (200 kHz, 20 ms sound pulses, green trace). **b**, Magnification of the 4th sound pulse of the nerve recording: the A cell responses due to the sound stimulus are distinguishable. **c**, Is the averaged response to 5 sound pulses. Sound stimulus (green) elicits a mechanical motion (red). Neural activity (black trace) appears after some latency.

5.5 Discussion and Future Work

Bats first appeared over 60 million years ago, occupying a niche area of night-time hunting in which they have become incredibly successful, with more than 900 species known (Neuweiler, 1984). This evolution of bats and their echolocation hunting calls drove the evolution of insect hearing organs from pre-existing chordotonal organs due to the predation pressure (Spangler, 1988; Miller and Surlykke, 2001). This is considered to be one of the best known co-evolutionary arms-races in the animal kingdom (Fullard, 1998). Bats typically echolocate at frequencies above the limit of human hearing, >20 kHz. The moth's simple ear structure is capable of detecting ultrasonic frequencies and the upper limit of moth hearing was previously thought to be around 120 kHz (Miller and Surlykke, 2001). The findings of the current study indicate that the frequency range of a moth is much higher than was previously thought. In both mechanical and neural recordings the greater wax moth hearing organ can detect up to 300 kHz. There a number of potential reasons why the moths have evolved this incredible hearing range which shall be discussed in detail.

Moth hearing organs possess a very small number of auditory receptor cells, 1-4 cells depending on species (Spangler, 1988a), despite this the organs are extremely well developed and effective at detecting approaching predators (Fullard, 1998). The majority of known species of moths which are known to hear possess ears that only function as bat detectors, in fact the moths which also produce sound for intra-specific communication are the exception to the rule (Fullard, 1998). This evolutionary arms-race between predator and prey has been shown to be closely linked. This is seen in that moths species have generally been found to have evolved hearing sensitive to the frequency ranges of the bats they are most likely to encounter (Fullard, 1988). For example, the same species of moth which is spread over a large geographical area, such as the east and west coast of Canada, can have different frequency sensitivities due to them being exposed to different species of bats (Fullard et al., 1983). Similarly difference in frequency sensitivities are also found between South African and Canadian moth species. This is thought to be due to the South

African bats being under more predation pressure from a higher density and also variety of bats (Fullard, 1982). Conversely, moths which are endemic to areas where there are no bats are in a state of becoming deaf (Fullard, 1994). Prof. Fullard defined bats which echolocate at frequencies within the moth hearing sensitivity syntonetic and bats that call out with the limits of moth hearing allotonic (Fullard, 1987). The allotonic bats take advantage of the majority of moths not being able to detect their hunting calls and are successful predators. Their hunting calls are known to be very high or very low frequencies (Fullard, 1987; Faure et al., 1993). This may be one possible reason for the very high frequency sensitivity shown in greater wax moths; the moths may be exposed to gleaning bats in the area they inhabit, these bats predate on insects on surfaces and not for example taken in flight and use the highest known echolocation calls of known bat calls (Neuweiler, 1984; Neuweiler, 1990). Therefore, the greater wax moth may be at advantage to detect the approaching bat whereas most moths would not be able to detect the high frequencies produced by these bats.

Many species of moths have also been shown to have evolved counter-manoeuvres of their own to keep up with the predation pressures of the adapting bats. One such example is a species of Noctuid moth, *Noctua pronuba*, where the mechanics of the tympanal membrane are found to alter in their sensitivity at different sound levels. At low sound levels the membrane is tuned to frequencies of around 40 kHz, but at a higher sound level there is a shift in the range of frequency sensitivity up to 70-80 kHz. This suggests that the moths' tympanal membrane has adapted to detect the final approach of the bat calls more clearly and up tunes. It was also found that this shift took place very quickly, in 0.75 seconds, but to go back to the normal state took a long time, suggesting that the moth is still ready if the bat returns (Windmill et al., 2006). Another example of a moth counter-manoeuvre is the production of ultrasonic clicks, the reason for these clicks has been debated in the past with numerous reasons suggested, such as, the click blocking the bats echolocation call so the moths goes undetected, the click startling the bat, or the moth clicking to display aposematism, distastefulness (Fullard et al., 1994; Conner, 1999; Ratcliffe and Fullard, 2006). Whatever the reason the bat is put off anyway and the moths are less likely to be predated when the moth produces the sound pulses

(Conner, 1999). A structural example of adaptation due to bat predation is found in two species of Notodontidae, these moths have evolved external appendages around the ears; this is apparently to help with high frequency detection (Fullard, 1984). If the appendages were removed the high frequency sense was found to be reduced in sensitivity. Other examples include moths avoid bats completely by flying during the day, some species have been found to be deaf as there is no longer a need for the hearing sense for bat detection, others retain the hearing sense. There are however, other threats during the day from bird predation amongst other things, these moths were also thought to have originally had functional ears, through analysis of three species of the family Notodontidae, it was found that 2 had normal hearing similar to other night-flying Notodontids, whereas the other species tested had lost the higher frequency sensitivity (Fullard et al., 1997). As the moth evolution in hearing has been so diverse and the examples of adaptations are numerous it is plausible then that a moth can possess very high hearing in terms of frequency to detect the high end of the bat echolocation call range, as has been found in this work.

As greater wax moths can live in various environments and over a large geographical area, due to their inhabiting of bee hives, the range of bats by which they may come into contact with is larger than a moth with a smaller geographical area. As the greater wax moth hearing range is such a large bandwidth they can detect most known calls produced by bat species in terms of frequency and this may be the reason why they are so successful (Spangler, 1984b). Echolocating bats are known to produce sounds up to 212 kHz in their hunting calls (Fenton and Bell, 1981), although this may still be much higher due to the difficulties in detecting ultrasound, it may be useful to map the bat cochlea to gauge how high in terms of frequency that the bats can detect to measure the highest limit of the echolocation calls. This may be the reason that the moths have evolved such high frequency hearing to detect the full range of frequencies produced in the bats hunting calls, by detecting these extreme ranges of bat calls the greater wax moth have an advantage due to this high frequency sensitivity. The range of hearing in moth ears that are solely for detecting bats is around 20-80 kHz, the hearing organs also have a smaller number, 1 or 2, receptor cells also (Fullard, 1998).

Another possible reason for the high frequency sensitivity in greater wax moths may also possibly be due to the bees which hives they inhabit. There is some documentation of bees producing ultrasound (Spangler, 1986b). There is only one known reference to this, however, and the sounds produced and also how they are produced if they are indeed is not understood, there is mention of wing beat producing ultrasonic pulses (Spangler, 1986b). As greater wax moths are a pest of bee hives the ultrasonic hearing may have been influenced by the presence of bees, so the bees can be detected and avoided as they do show aggression, or to allow the moths to detect the sounds produced by the bees to locate their hives. The closely related lesser wax moth also inhabit bee hives and produces ultrasonic pulses for courtship, (Spangler and Takessian, 1983), it would be interesting to investigate the frequency range of this species also and perhaps other species from the family Pyralidae to see if the bees have a factor in the evolution of the moth hearing capabilities or if the other species of Pyralidae which do not live in bee hives also have very high frequency hearing. It would also be beneficial to investigate very high frequency hearing in other families of moths.

Temporal acuity is the time it takes the membrane to respond to incoming sound. As the tympanal membrane is an oscillator the quicker the attachment point can reach the required displacement for a neural reaction to be sent to the brain and respond with appropriate behaviour. If an insect has a large bandwidth of hearing sensitivity then the time is reduced (Section 5.3.1i). The temporal acuity of the wax moth was calculated from the laser vibrometry measurements of the receptor cell attachment point curves (Fig. 5.9). From other measurements of moth species the greater wax moth has the smallest value in comparison to Noctuid, 60 μ s, (Scholten et al., 1981), and also the closely related lesser wax moth, 20-50 μ s (Rodriguez et al., 2005). Both the lesser and greater wax moth membranes showed out of phase movements between the two parts of the membrane, (Chapter 3: section 3.3.3i), the reason for this anti-phase is not known. In the greater wax moth temporal acuity there was found to be a difference between the sexes as the males of the species have a larger range of sensitive frequency in displacement curves.

There remains much to be understood about the high frequency sensitivity not least the purpose and cause. To answer these questions the behavioural response to

the high frequencies would go towards hopefully understanding the need for the moth to hear these frequencies. Previously it was shown that the moths responded with bat avoidance behaviour to these high frequencies, but other reasons would also need to be investigated, including the possibility of bees producing ultrasound and also bats perhaps calling at frequencies higher than are currently known.

Chapter 6:

Conclusions and Future Work

6.1 Tympanal Membrane Mechanics

Understanding the mechanics of insect tympanal membrane mechanics is a fundamental part of understanding the other processes of the hearing organ as it is the first point of sound detection and for some species the start of the sound processing. The results of Chapter 3 show how varied the tympanal membrane size, the structure of the surface, as well as the frequency ranges of the insects species investigated are, even within orders. Some insects shown have one point of attachment of the receptor cells, whereas others like the locust have more than one. Also the differences in size and effectiveness of the hearing organ for its purpose is astonishing, for example the green lacewing hearing organ is only 0.02 mm^2 in area but can detect ultrasonic cries of bats in the air whilst flying, even despite the vibrations of the wings (Miller, 1970). Other insects have been found to have sophisticated frequency discrimination, for example, in locust species and also in Cicadas and bushcrickets this is due to a travelling wave arising with acoustic stimulation, similar to human cochlear tonotopy (Windmill et al., 2005; Sueur et al., 2006; Udayashankar et al., 2012).

Many species of insect which are known to have tympanal organs have not been investigated using laser Doppler vibrometry. It would interesting to investigate the orders which have not been studied, such as Coleoptera and also Mantodea for example, in order to compare the membrane mechanics across orders of Insecta. One reason for this is in light of the differences found within the order of Lepidoptera (Chapter 4) where one species (*O. nubilalis*) was shown to be tuned to a narrow range of frequencies whereas the Pyralidae moths investigated had a broad range of frequency sensitivity, with this mechanical response confirmed in *G. mellonella* using electrophysiology recordings of the auditory nerve (Chapter 5). There are also differences in that there is no evidence of up-tuning in the Pyralidae species investigated, whereas it is known in a Noctuid moth (Windmill et al., 2006).

Other results from the chapter are also unclear and would require further investigation; the laser vibrometry recordings of both *O. nubilalis* and *P. interpunctella* found differences in the expected best frequency ranges in terms of displacement of the membrane. Also the two parts of the membrane of *G. mellonella*

were found to move out of phase at the low frequency range of the moth, similar to the lesser wax moth (Rodriguez et al., 2005). The reason for this is not known, it might be due to the different thicknesses of the membrane having different resonances or it may be more complicated and have a part in the sound processing.

Green lacewings were found to be very difficult to rear to adults and so only one individual's laser vibrometry results are shown in this work; however the membrane mechanics were not previously investigated. There remains much to be understood about the structure of the hearing organ. This would be especially interesting due to different location and also the membrane being fluid backed, leading to questions on just how the sound is processed. Also, the green lacewing chordotonal organ was previously shown to have a high number of scolopidial cells and in other insects this is usually due to there being a more complex sound processing need (Yack, 2004). Green lacewings are thought to use hearing for bat detection but it would also be interesting to investigate if they also use the hearing sense for another purpose.

6.2 DPOAEs in insect tympanal organs

The current study (Chapter 4), using laser Doppler vibrometry, failed to identify any points of deflection on the tympanal membrane of the insect species investigated to be due to the emission of Distortion-product otoacoustic emissions (DPOAEs). This result was initially surprising as DPOAEs over various frequencies and also sound levels were acoustically recordable through the tympanal membrane with a number of insects species investigated (see Kössl et al., 2008, for a review), even from insect species which only possess one auditory receptor cell (Kössl et al., 2007). The scolopidial cells, and also the area of the membrane of the locust tympanal organ where the thick and thin membrane joins, were suggested for the site of emission of the locust species (Kössl and Boyan, 1998). In the current study the magnitude of vibration a previously recorded 10 dB DPOAE emission would cause was found to be well within the limit of the laser vibrometer. As this could not be detected on the membrane this then led to various other experiments which involved altering the physiological state to identify if this was a factor in the production of DPOAEs. This

again failed to record any DPOAEs on the membrane surface. A DPOAE frequency was only ever recorded when the loudspeaker was over driven at too high a sound level, this was confirmed by recording in the absence of the animal, this is known as intermodulation where the system becomes distorted.

It may be beneficial to assess the membrane mechanics of the tympanal membranes in a closed near-field sound situation as these are the conditions which found the acoustically recordable DPOAEs for both the locusts, (Kössl and Boyan, 1998) and also moths (Coro and Kössl, 1998). The current experiments were carried out in the far-field, although using the microphone ensured that the sound levels applied were the same. It was mentioned in the literature that the oscillations of the Müller's organ of locust were complex (Breckow and Sippel, 1985); using laser vibrometry to record the oscillations of the Müller's organ may also help to understand if the hearing organ of insects have active hearing through chordotonal organ vibrations.

Tympanal organs of insects were not previously thought of as having active hearing and were thought to function passively to sound, (Yager, 1999) until the measurements of acoustically recordable DPOAEs. In another order of insect, Diptera, active hearing has been found (Göpfert and Robert, 2001; Jackson and Robert, 2006), although in that case the hearing organ structure is quite different. Hopefully, in the future, by understanding the mechanotransduction of the scolopidial cells of insect hearing organs (as the structure of this cellular basis of insect hearing organs is fairly uniform), the site of the active processes and how they are produced can be understood. This knowledge could then possibly help to understand if tympanal organs of insects are capable of active hearing and if they are producing the DPOAEs previously found.

6.3 High frequency hearing in moths

The reason for the very high frequency hearing found in *G. mellonella* is unclear (Chapter 5). There are a number of possibilities which may have caused this species of moth to be sensitive to such a wide range of frequencies. Lepidoptera are known to have evolved the hearing sense due to the predation pressure of bats (Stumpner

and von Heleversen, 2001), as both predator and prey are in an evolutionary arms race (Fullard, 1998). Could the very high frequencies produced by bat species be driving moth species to extend their hearing ranges? Hearing is more complicated for the greater wax moth as they also have exploited the hearing sense for intra-specific communication; could it be aspects of the courtship call that are higher in frequency than previously discovered? In the future behavioural studies would be very helpful to answer these questions. Observing the reaction to sound at the very high frequencies (>200 kHz) would go towards identifying if the moths react with evasive bat detection behaviour or courtship behaviour. Previously moths were found to respond with evasive behaviour at 250 kHz (Spangler, 1984b). There is also the question of bees producing ultrasound, where the bees were also thought to behave aggressively to the moths, it may be that the moths are detecting the bees and attempting to avoid the bees. Another possible suggestion was that bees may produce ultrasonic frequencies and that the moths use this to find the hive to inhabit (Spangler, 1986). All of these reasons would have to be investigated further. Another suggestion for the hearing range is that a wider range of frequency sensitivity also increases the temporal acuity of the membrane. The hearing organs of females of the species were found to distinguish between bat and male calls also (Jones et al., 2002). As the call parameters can be similar it could be very important for the moth to distinguish the call quickly. It would also be beneficial to investigate other species of insect to compare the temporal acuity values.

High frequency hearing may also apply to other insect orders as they have also evolved due to the pressure of bat predation (Chapter 2: Section 2.4). It would be very interesting to investigate these orders in particular to identify if any other species can also detect these very high ultrasonic frequencies, especially other species of Pyralidae moth. The lesser wax moth would be an excellent target as they have very similar life styles and hearing organs (Chapter 3). Investigation of other species may go towards further understanding of why the greater wax moth has evolved this extreme hearing range.

Animals which echolocate are known to have very high frequency hearing; bat species have the highest known frequency call (Fenton and Bell, 1981). Due to ultrasound being difficult to record this may possibly be higher, other methods such

as cochlear mapping of bat species may in the future show that bat calls have very high frequency components, which is one possible reason for the very high frequency hearing discovered in the moth.

6.4 Overall Conclusions

In recent years research into insect hearing organs have led to many new aspects of their function being discovered. This is partly due to advancements in technology, allowing smaller measurements to be made, such as in laser Doppler vibrometry. Everything that is known currently about insect hearing organs has been discovered in this and the last century (Eberl, 1999). However, much still remains to be understood about insect hearing organs on many levels not least the theorised number of insect species hearing organs awaiting discovery (Yager, 1999). This Thesis work has aimed to add to this understanding of the functioning and structure of the tympanal organs, investigating a number of species using different experimental methods. This information will hopefully go towards providing biological inspiration for man-made sensor design so that smaller, more sensitive devices can be made.

References

- Adams, W. B.** (1971). Intensity characteristics of the Noctuid acoustic receptor. *the Journal of General Physiology* **58**, 562-579.
- Adams, W. B.** (1972). Mechanical tuning of the acoustic receptor of *Prodenia eridania* (Cramer) (Noctuidae). *Journal of Experimental Biology* **57**, 297-304.
- Agee, H. R.** (1969). Acoustic sensitivity of european corn borer moth, *Ostrinia nubilalis*. *Annals of the Entomological Society of America* **62**, 1364-1367
- Bennet-Clark, H. C.** (1998). Size and scale effects as constraints in insect sound communication. *Philosophical Transactions of the Royal Society B: Biological Sciences* **353**, 407-419.
- Benny, G., Hayward, G. and Chapman, R.** (2000). Beam profile measurements and simulations for ultrasonic transducers operating in air. *Journal of the Acoustical Society of America* **107**, 2089-2100.
- Bergevin, C., Freeman, D. M., Saunders, J. C. and Shera, C. A.** (2008). Otoacoustic emissions in humans, birds, lizards, and frogs: evidence for multiple generation mechanisms. *Journal of Comparative Physiology a-Neuroethology Sensory Neural and Behavioral Physiology* **194**, 665-683.
- Breckow, J. and Sippel, M.** (1985). Mechanics of the transduction of sound in the tympanal organ of adults and larvae of locusts. *Journal of Comparative Physiology a-Sensory Neural and Behavioral Physiology* **157**, 619-629.
- Bura, V. L., Rohwer, V. G., Martin, P. R. and Yack, J. E.** (2011). Whistling in caterpillars (*Amorpha juglandis*, Bombycoidea): sound-producing mechanism and function. *Journal of Experimental Biology* **214**, 30-37.
- Conner, W. E.** (1999). 'Un chant d'appel amoureux': Acoustic communication in moths. *Journal of Experimental Biology* **202**, 1711-1723.
- Coro, F. and Kössl, M.** (1998). Distortion-product otoacoustic emissions from the tympanic organ in two noctuid moths. *Journal of Comparative Physiology a-Sensory Neural and Behavioral Physiology* **183**, 525-531.
- Coro, F. and Kössl, M.** (2001). Components of the 2f(1)-f(2) distortion-product otoacoustic emission in a moth. *Hearing Research* **162**, 126-133.
- Dalhoff, E., Turcanu, D., Zenner, H. P. and Gummer, A. W.** (2007). Distortion product otoacoustic emissions measured as vibration on the eardrum of human subjects. *Proceedings of the National Academy of Sciences of the United States of America* **104**, 1546-1551.
- Dallos, P.** (2008). Cochlear amplification, outer hair cells and prestin. *Current Opinion in Neurobiology* **18**, 370-376.

- Dawson, J. W., Kutsch, W. and Robertson, R. M.** (2004). Auditory-evoked evasive manoeuvres in free-flying locusts and moths. *Journal of Comparative Physiology a-Neuroethology Sensory Neural and Behavioral Physiology* **190**, 69-84.
- Eberl, D. F.** (1999). Feeling the vibes: chordotonal mechanisms in insect hearing. *Current Opinion in Neurobiology* **9**, 389-393.
- Eggers, F.** (1919). Das thoracale bitympanal Organ einer Gruppe der Lepidoptera Heterocera. *Zoologische Jahrbücher* **41**, 273-376.
- Faure, P. A., Fullard, J. H. and Dawson, J. W.** (1993). The gleaning attacks of the northern long-eared bat, *Myotis septentrionalis*, are relatively inaudible to moths. *Journal of Experimental Biology* **178**, 173-189.
- Fenton, M. B. and Bell, G. P.** (1981). Recognition of species of insectivorous bats by their echolocation calls. *Journal of Mammalogy* **62**, 233-243.
- Field, L. H. and Matheson, T.** (1998). Chordotonal organs of insects. *Advances in Insect Physiology* **27**, 1-288.
- Fullard, J. H.** (1982). Echolocation assemblages and their effects on moth auditory systems. *Canadian Journal of Zoology-Revue Canadienne De Zoologie* **60**, 2572-2576.
- Fullard, J. H.** (1984). External auditory structures in 2 species of neotropical notodontid moths. *Journal of Comparative Physiology* **155**, 625-632.
- Fullard, J. H.** (1987). Sensory ecology and neuroethology of moths and bats interactions. In *Recent Advances in the Study of Bats*. (eds. MB Fenton, PA Racey and JMV Raynor), pp. 244-273. Cambridge: Cambridge University Press.
- Fullard, J. H.** (1988). The tuning of moth ears. *Experientia* **44**, 423-428.
- Fullard, J. H.** (1994). Auditory changes in noctuid moths endemic to a bat-free habitat. *Journal of Evolutionary Biology* **7**, 435-445.
- Fullard, J. H.** (1998). The sensory coevolution of moths and bats.. In *Comparative Hearing: Insects Springer Handbook of Auditory Research*. (eds. RR Hoy, AN Popper, and RR Fay), pp. 279-326. New York: Springer-Verlag.
- Fullard, J. H., Dawson, J. W., Otero, L. D. and Surlykke, A.** (1997). Bat-deafness in day-flying moths (Lepidoptera, Notodontidae, Dioprinae). *Journal of Comparative Physiology a-Neuroethology Sensory Neural and Behavioral Physiology* **181**, 477-483.
- Fullard, J. H., Fenton, M. B. and Furlonger, C. L.** (1983). Sensory relationships of moths and bats sampled from 2 nearctic sites. *Canadian Journal of Zoology-Revue Canadienne De Zoologie* **61**, 1752-1757.
- Fullard, J. H., Simmons, J. A. and Saillant, P. A.** (1994). Jamming bat echolocation - the dogbane tiger moth *Cycnia tenera* times its clicks to the terminal

attack calls of the big brown bat *Eptesicus fuscus*. *Journal of Experimental Biology* **194**, 285-298.

Fullard, J. H. and Yack, J. E. (1993). The evolutionary biology of insect hearing. *Trends in Ecology & Evolution* **8**, 248-252.

Göpfert, M. C. and Robert, D. (2001). Active auditory mechanics in mosquitoes. *Proceedings of the Royal Society of London Series B-Biological Sciences* **268**, 333-339.

Göpfert, M. C. and Robert, D. (2003). Motion generation by *Drosophila* mechanosensory neurons. *Proceedings of the National Academy of Sciences of the United States of America* **100**, 5514-5519.

Gray, E. G. (1960). The fine structure of the insect ear. *Philosophical Transactions of the Royal Society of London Series B-Biological Sciences* **243**, 10-94.

Griffin, D. R., Webster, F. A., Michael, C. R. (1960). The echolocation of flying insects by bats. *Animal Behaviour* **8**, 141-154.

Gu, J.-j., Montealegre-Z, F., Robert, D., Engel, M. S., Qiao, G.-X. and Ren, D. (2012). Wing stridulation in a Jurassic katydid (Insecta, Orthoptera) produced low-pitched musical calls to attract females. *Proceedings of the National Academy of Sciences of the United States of America* **109**, 3868-3873.

Guedes, R. N. C., Matheson, S. M., Frei, B., Smith, M. L. and Yack, J. E. (2012). Vibration detection and discrimination in the masked birch caterpillar (*Drepana arcuata*). *Journal of Comparative Physiology a-Neuroethology Sensory Neural and Behavioral Physiology* **198**, 325-335.

Haskell, P. T. (1957). The influence of flight noise on behaviour in the desert locust *Schistocerca gregaria* (Forsk). *Journal of Insect Physiology* **1**, 52-75.

Hoy, R., Nolen, T. and Brodfuehrer, P. (1989). The neuroethology of acoustic startle and escape in flying insects. *Journal of Experimental Biology* **146**, 287-306.

Hoy, R. R. (1992). The evolution of hearing in insects as an adaptation to predation from bats. *Evolutionary Biology of Hearing*, 115-129.

Hoy, R. R. (1998). Acute as a Bug's Ear: An Informal Discussion of Hearing in Insects. In *Comparative Hearing: Insects*, (ed. R. R. Hoy, Popper, A. N., and Fay, R. R.), pp. 1-17: Springer Verlag.

Hoy, R. R. and Robert, D. (1996). Tympanal hearing in insects. *Annual Review of Entomology* **41**, 433-450.

Jackson, J. C. and Robert, D. (2006). Nonlinear auditory mechanism enhances female sounds for male mosquitoes. *Proceedings of the National Academy of Sciences of the United States of America* **103**, 16734-16739.

- Jackson, M. E., Asi, N. S. and Fullard, J. H.** (2010). Auditory sensitivity and ecological relevance: the functional audiogram as modelled by the bat detecting moth ear. *Journal of Comparative Physiology a-Neuroethology Sensory Neural and Behavioral Physiology* **196**, 453-462.
- Jones, G., Barabas, A., Elliott, W. and Parsons, S.** (2002). Female greater wax moths reduce sexual display behavior in relation to the potential risk of predation by echolocating bats. *Behavioral Ecology* **13**, 375-380.
- Keil, T. A.** (1997). Functional morphology of insect mechanoreceptors. *Microscopy Research and Technique* **39**, 506-531.
- Kemp, D. T.** (2002). Otoacoustic emissions, their origin in cochlear function, and use. *British Medical Bulletin* **63**, 223-241.
- Kummer, P., Janssen, T. and Arnold, W.** (1998). The level and growth behavior of the 2 f1-f2 distortion product otoacoustic emission and its relationship to auditory sensitivity in normal hearing and cochlear hearing loss. *Journal of the Acoustical Society of America* **103**, 3431-3444.
- Kössl, M. and Boyan, G. S.** (1998a). Acoustic distortion products from the ear of a grasshopper. *Journal of the Acoustical Society of America* **104**, 326-335.
- Kössl, M. and Boyan, G. S.** (1998b). Otoacoustic emissions from a nonvertebrate ear. *Naturwissenschaften* **85**, 124-127.
- Kössl, M. and Coro, F.** (2006). L1,L2 maps of distortion-product otoacoustic emissions from a moth ear with only two auditory receptor neurons. *Journal of the Acoustical Society of America* **120**, 3822-3831.
- Kössl, M., Coro, F., Seyfarth, E.-A. and Naessig, W. A.** (2007). Otoacoustic emissions from insect ears having just one auditory neuron. *Journal of Comparative Physiology a-Neuroethology Sensory Neural and Behavioral Physiology* **193**, 909-915.
- Kössl, M., Möckel, D., Weber, M. and Seyfarth, E.-A.** (2008). Otoacoustic emissions from insect ears: evidence of active hearing? *Journal of Comparative Physiology a-Neuroethology Sensory Neural and Behavioral Physiology* **194**, 597-609.
- Lechtenberg, R.** (1971). Acoustic response of B-cell in noctuid moths. *Journal of Insect Physiology* **17**, 2395-2399.
- Leighton, T. G.** (2007). What is Ultrasound? *Progress in Biophysics and Molecular Biology* **93**, 3-83.
- Manley, G. A.** (2001). Evidence for an active process and a cochlear amplifier in nonmammals. *Journal of Neurophysiology* **86**, 541-549.
- Mason, A. C. and Faure, P. A.** (2004). The physiology of insect auditory afferents. *Microscopy Research and Technique* **63**, 338-350.

- McSweeney, S. G. and Wright, W. M. D.** (2008). Improving the Bandwidth of Air Coupled Capacitive Ultrasonic Transducers Using Selective Networks. *IEEE International Ultrasonics Symposium Proceedings, IUS 2008. IEEE*, 1191-1194, 2-5 Nov. 2008
- Meyer, J. and Hedwig, B.** (1995). The influence of tracheal pressure changes on the responses of the tympanal membrane and auditory receptors in the locust *Locusta migratoria* L. *Journal of Experimental Biology* **198**, 1327-1339.
- Michelsen, A.** (1971a). Physiology of locust ear .1. Frequency sensitivity of single cells in isolated ear. *Zeitschrift Fur Vergleichende Physiologie* **71**, 49-62.
- Michelsen, A.** (1971b). Physiology of locust ear .2. Frequency discrimination based upon resonances in tympanum. *Zeitschrift Fur Vergleichende Physiologie* **71**, 63-101.
- Michelsen, A. and Larsen, O. N.** (1978). Biophysics of ensiferan ear .1. Tympanal vibrations in bushcrickets (Tettigoniidae) studied with laser vibrometry. *Journal of Comparative Physiology* **123**, 193-203.
- Miles, R. N. and Hoy, R. R.** (2006). The Development of a biologically inspired directinoal microphone for hearing aids. *Audiology Neurootology* **11**, 86-94
- Miller, L. A.** (1970). Structure of green lacewing tympanal organ (*Chrysopa carnea*, Neuroptera). *Journal of Morphology* **131**, 359-382.
- Miller, L. A.** (1971). Physiological responses of green lacewings (*Chrysopa, neuroptera*) to ultrasound. *Journal of Insect Physiology* **17**, 491-506.
- Miller, L. A.** (1975). The behavior of flying green lacewings *Chrysopa carnea* in the presence of ultrasound. *Journal of Insect Physiology* **21**, 205-220.
- Miller, L. A. and Macleod, E. G.** (1966). Ultrasonic sensitivity - a tympanal receptor in green lace wing *Chrysopa carnea*. *Science* **154**, 891-893.
- Miller, L. A. and Surlykke, A.** (2001). How some insects detect and avoid being eaten by bats: Tactics and countertactics of prey and predator. *Bioscience* **51**, 570-581.
- Mullen, M. A. and Tsao, C. H.** (1971a). Morphology of the tympanic organ of the greater wax moth *Galleria mellonella*. *Journal of the Georgia Entomological Society* **6**, 124-132.
- Mullen, M. A. and Tsao, C. H.** (1971b). Tympanic organ of indian-meal moth, *Plodia interpunctella* (Hubner), almond moth, *Cadra cautella* (Walker) and tobacco moth, *Ephestia elutella* (Hubner) (Lepidoptera- Pyralididae)*. *International Journal of Insect Morphology and Embryology* **1**, 3-10.
- Möckel, D., Seyfarth, E.-A. and Kössl, M.** (2007). The generation of DPOAEs in the locust ear is contingent upon the sensory neurons. *Journal of Comparative*

Physiology a-Neuroethology Sensory Neural and Behavioral Physiology **193**, 871-879.

Möckel, D., Seyfarth, E.-A. and Kössl, M. (2011). Otoacoustic emissions in bushcricket ears: general characteristics and the influence of the neuroactive insecticide pymetrozine. *Journal of Comparative Physiology a-Neuroethology Sensory Neural and Behavioral Physiology* **197**, 193-202.

Nakano, R., Skals, N., Takanashi, T., Surlykke, A., Koike, T., Yoshida, K., Maruyama, H., Tatsuki, S. and Ishikawa, Y. (2008). Moths produce extremely quiet ultrasonic courtship songs by rubbing specialized scales. *Proceedings of the National Academy of Sciences of the United States of America* **105**, 11812-11817.

Nakano, R., Ishikawa, Y., Tatsuki, S., Skals, N., Surlykke, A. and Takanashi, T. (2009a). Private ultrasonic whispering in moths. *Communicative & integrative biology* **2**, 123-126.

Nakano, R., Takanashi, T., Fujii, T., Skals, N., Surlykke, A. and Ishikawa, Y. (2009b). Moths are not silent, but whisper ultrasonic courtship songs. *Journal of Experimental Biology* **212**, 4072-4078.

Neuweiler, G. (1984). Foraging, echolocation and audition in bats. *Naturwissenschaften* **71**, 446-455.

Neuweiler, G. (1990). Auditory adaptations for prey capture in echolocating bats. *Physiological Reviews* **70**, 615-641.

Neuweiler, G. (2003). Evolutionary aspects of bat echolocation. *Journal of Comparative Physiology a-Neuroethology Sensory Neural and Behavioral Physiology* **189**, 245-256.

Oldfield, B. P. (1988). The effect of temperature on the tuning and physiology of insect auditory receptors. *Hearing Research* **35**, 151-158.

Payne, R. S., Roeder, K. D. and Wallman, J. (1966). Directional sensitivity of ears of noctuid moths. *Journal of Experimental Biology* **44**, 17- 31.

Probst, R., Lonsburymartin, B. L. and Martin, G. K. (1991). A review of otoacoustic emissions. *Journal of the Acoustical Society of America* **89**, 2027-2067.

Ratcliffe, J. M. and Fullard, J. H. (2006). The adaptive function of tiger moth clicks against echolocating bats: an experimental and synthetic approach.. *Journal of Experimental Biology* **209**, 2811-2811.

Robert, D. (1989). The auditory-behavior of flying locusts. *Journal of Experimental Biology* **147**, 279-301.

Rodriguez, R. L., Schul, J., Cocroft, R. B. and Greenfield, M. D. (2005). The contribution of tympanic transmission to fine temporal signal evaluation in an ultrasonic moth. *Journal of Experimental Biology* **208**, 4159-4165.

- Roeder, K. D.** (1962). The behaviour of free flying moths in the presence of artificial ultrasonic pulses. *Animal Behaviour* **10**, 300-304.
- Roeder, K. D.** (1965). Moths and ultrasound. *Scientific American* **212**, 94-102.
- Roeder, K. D.** (1966a). Auditory system of noctuid moths. *Science* **154**, 1515-1521.
- Roeder, K. D.** (1966b). Interneurons of the thoracic nerve cord activated by tympanic nerve fibres in noctuid moths. *Journal of Insect Physiology* **12**, 1227-1244.
- Roeder, K. D.** (1974). Responses of less sensitive acoustic sense cells in tympanic organs of some noctuid and geometrid moths. *Journal of Insect Physiology* **20**, 55-66.
- Roeder, K. D. and Treat, A. E.** (1957). Ultrasonic reception by the tympanic organ of noctuid moths. *Journal of Experimental Zoology* **134**, 127-157.
- Schiolten, P., Larsen, O. N. and Michelsen, A.** (1981). Mechanical time resolution in some insect ears .1. Impulse responses and time constants. *Journal of Comparative Physiology* **143**, 289-295.
- Skals, N. and Surlykke, A.** (2000). Hearing and evasive behaviour in the greater wax moth, *Galleria mellonella* (Pyralidae). *Physiological Entomology* **25**, 354-362.
- Spangler, H. G.** (1984a). Attraction of female lesser wax moths (Lepidoptera, Pyralidae) to male-produced and artificial sounds. *Journal of Economic Entomology* **77**, 346-349.
- Spangler, H. G.** (1984b). Responses of the greater wax moth, *Galleria mellonella* L (Lepidoptera, Pyralidae) to continuous high-frequency sound. *Journal of the Kansas Entomological Society* **57**, 44-49.
- Spangler, H. G.** (1985). Sound Production and Communication by the Greater Wax Moth (Lepidoptera: Pyralidae). *Annals of the Entomological Society of America* **78**, 54-61.
- Spangler, H. G.** (1986a). Functional and temporal analysis of sound production in *Galleria mellonella* L (Lepidoptera, Pyralidae). *Journal of Comparative Physiology a-Sensory Neural and Behavioral Physiology* **159**, 751-756.
- Spangler, H. G.** (1986b). High-frequency sound production by honeybees. *Journal of Apicultural Research* **25**, 213-219.
- Spangler, H. G.** (1987). Acoustically mediated pheromone release in *Galleria mellonella* (Lepidoptera, Pyralidae). *Journal of Insect Physiology* **33**, 465-468.
- Spangler, H. G.** (1988a). Moth hearing defense and communication. *Annual Review Entomology* **33**, 59-82.
- Spangler, H. G.** (1988b). Sound and the moths that infest beehives. *Florida Entomologist* **71**, 467-477.

- Spangler, H. G. and Takessian, A.** (1983). Sound perception by 2 species of wax moths (Lepidoptera, Pyralidae). *Annals of the Entomological Society of America* **76**, 94-97.
- Stephen, R. O. and Bennet-Clark, H. C.** (1982). The anatomical and mechanical basis of stimulation and frequency-analysis in the locust ear. *Journal of Experimental Biology* **99**, 279-314.
- Stumpner, A. and von Helversen, D.** (2001). Evolution and function of auditory systems in insects. *Naturwissenschaften* **88**, 159-170.
- Sueur, J., Windmill, J. F. C. and Robert, D.** (2006). Tuning the drum: the mechanical basis for frequency discrimination in a Mediterranean cicada. *Journal of Experimental Biology* **209**, 4115-4128.
- Sueur, J., Windmill, J. F. C. and Robert, D.** (2008). Sexual dimorphism in auditory mechanics: tympanal vibrations of *Cicada orni*. *Journal of Experimental Biology* **211**, 2379-2387.
- Surlykke, A.** (1984). Hearing in Notodontid moths - a tympanic organ with a single auditory neuron. *Journal of Experimental Biology* **113**, 323-335.
- Takanashi, T., Nakano, R., Surlykke, A., Tatsuta, H., Tabata, J., Ishikawa, Y. and Skals, N.** (2010). Variation in Courtship Ultrasounds of Three Ostrinia Moths with Different Sex Pheromones. *Plos One* **5**, e13144
- ter Hofstede, H. M., Goerlitz, H. R., Montealegre-Z, F., Robert, D. and Holderied, M. W.** (2011). Tympanal mechanics and neural responses in the ears of a noctuid moth. *Naturwissenschaften* **98**, 1057-1061.
- Townend, J.** (2002). Practical Statistics for Environmental and Biological Scientists. Chichester: John Wiley and Sons Ltd.
- Treat, A. E. and Roeder, K. D.** (1959) A nervous element of unknown function in the tympanic organs of moths. *Journal of Insect Physiology* **3**, 262-270.
- Trematerra, P. and Pavan, G.** (1995). Ultrasound production in the courtship behavior of *Ephestia cautella* (Walk), *E. kuehniella* Z and *Plodia interpunctella* (HB) (Lepidoptera, Pyralidae). *Journal of Stored Products Research* **31**, 43-48.
- Udayashankar, A. P., Kössl, M. and Nowotny, M.** (2012). Tonotopically Arranged Traveling Waves in the Miniature Hearing Organ of Bushcrickets. *Plos One* **7**, e31008
- Whitely, S.....**
- Windmill, J. F. C., Bockenhauer, S. and Robert, D.** (2008). Time-resolved tympanal mechanics of the locust. *Journal of the Royal Society Interface* **5**, 1435-1443.

Windmill, J. F. C., Fullard, J. H. and Robert, D. (2007). Mechanics of a 'simple' ear: tympanal vibrations in noctuid moths. *Journal of Experimental Biology* **210**, 2637-2648.

Windmill, J. F. C., Göpfert, M. C. and Robert, D. (2005). Tympanal travelling waves in migratory locusts. *Journal of Experimental Biology* **208**, 157-168.

Windmill, J. F. C., Jackson, J. C., Tuck, E. J. and Robert, D. (2006). Keeping up with bats: Dynamic auditory tuning in a moth. *Current Biology* **16**, 2418-2423.

Yack, J. E. (2004). The structure and function of auditory chordotonal organs in insects. *Microscopy Research and Technique* **63**, 315-337.

Yack, J. E. and Fullard, J. H. (1993). Proprioceptive activity of the wing-hinge stretch-receptor in *Manduca sexta* and other atympanate moths - a study of the noctuid moth ear B-cell homolog. *Journal of Comparative Physiology a-Sensory Neural and Behavioral Physiology* **173**, 301-307.

Yack, J. E., Smith, M. L. and Weatherhead, P. J. (2001). Caterpillar talk: Acoustically mediated territoriality in larval Lepidoptera. *Proceedings of the National Academy of Sciences of the United States of America* **98**, 11371-11375.

Yager, D. D. (1999). Structure, development, and evolution of insect auditory systems. *Microscopy Research and Technique* **47**, 380-400.

Young, D. (1990). Do cicadas radiate sound through their eardrums? *Journal of Experimental Biology* **151**, 41-56.

Polytec Website: Basic Principles of Vibrometry:
<http://www.polytec.com/us/solutions/vibration-measurement/basic-principles-of-vibrometry/>

Appendices

Appendix 1: LabVIEW Software Programs

LabVIEW was used due to the large amount of data being recorded and processed at some parts of the thesis research. The programs are shown of the front panel and also the block diagram for each program which was written and a brief description of what the program was used for.

A.1.1 Locust DPOAE data recording

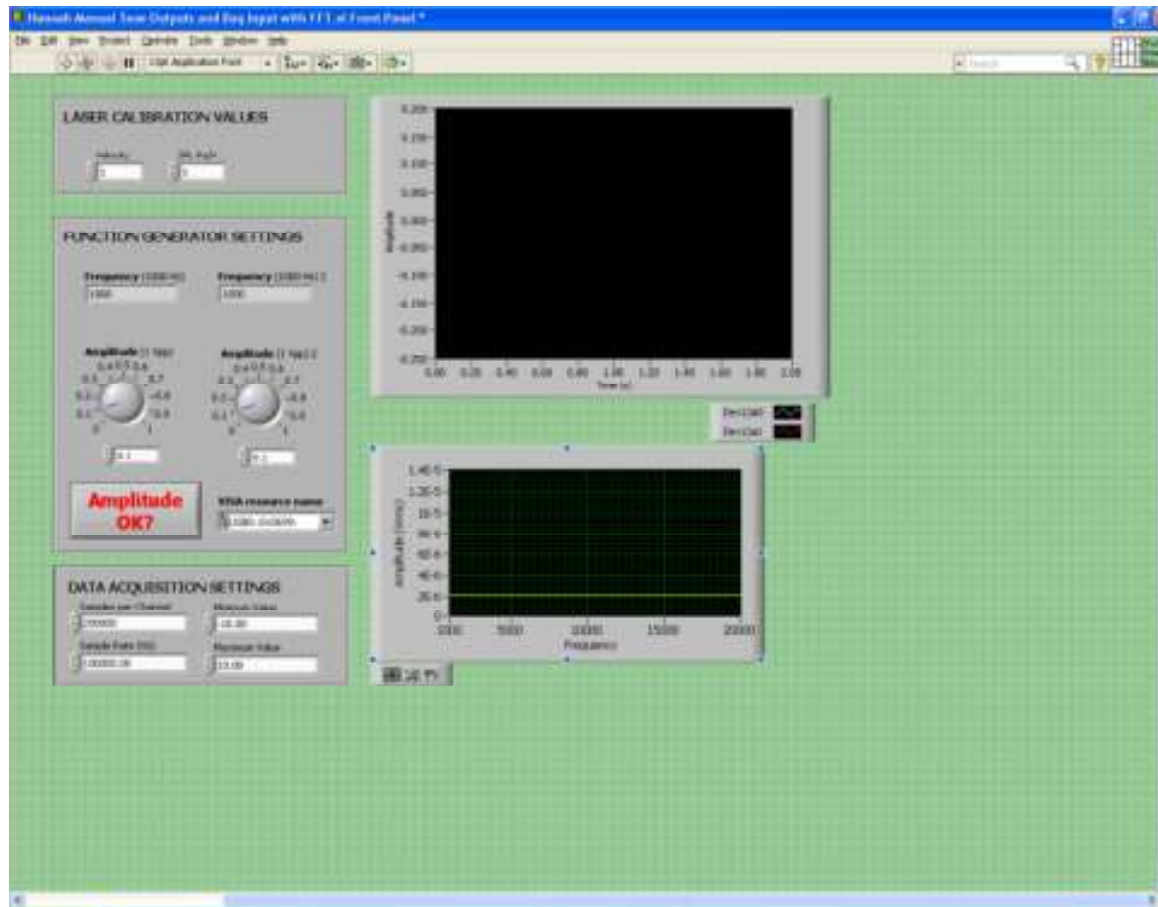

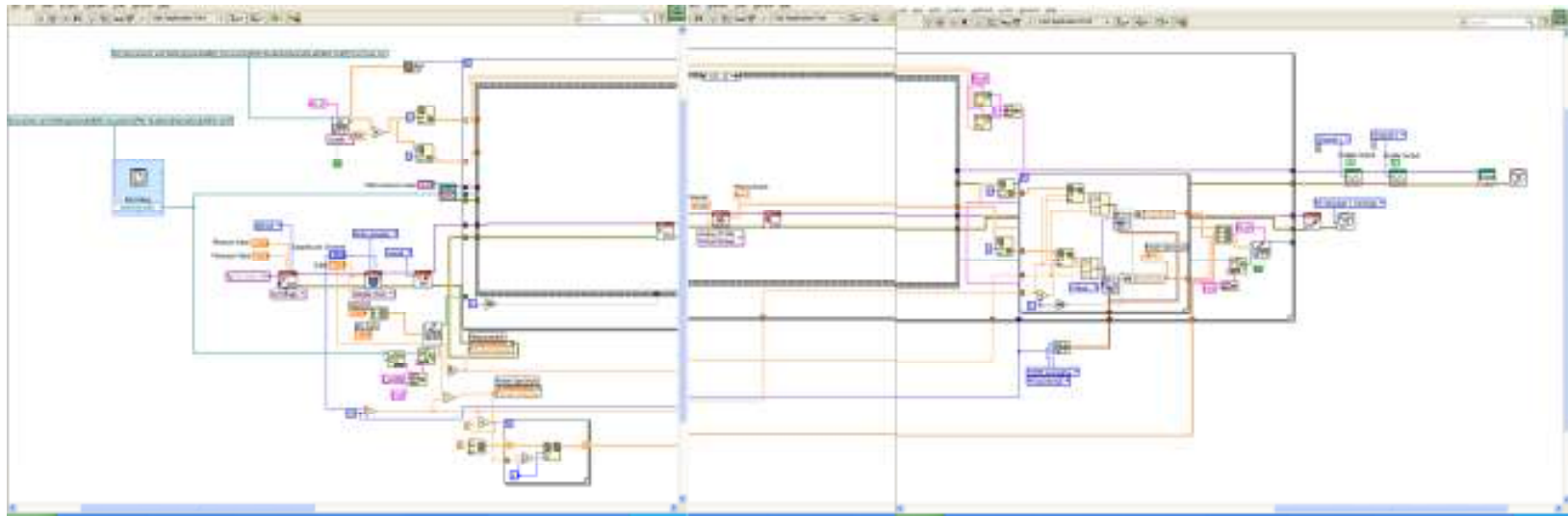
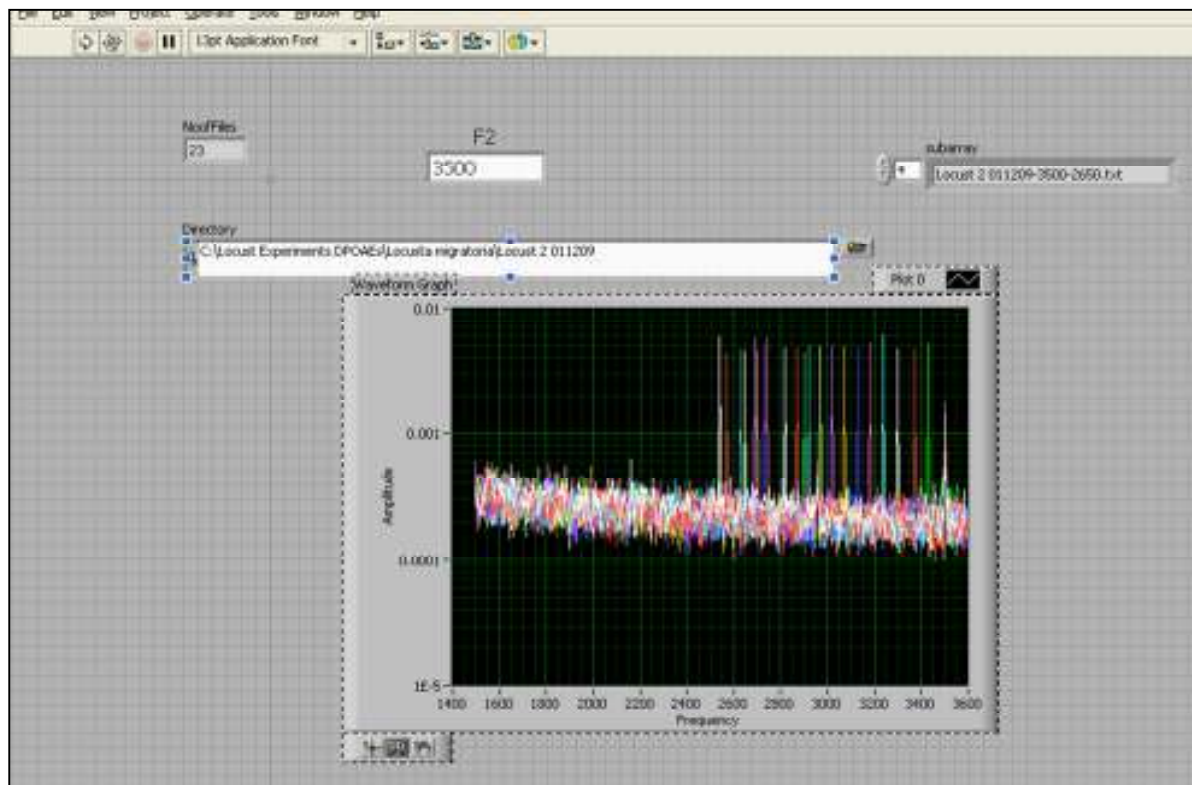

Figure A1.1 The locust DPOAE experiment results of the laser vibrometer were recorded using the DAQ card and this program front panel on the left and the block diagram below. The program ran through the two tone combinations and controlled the output of the function generator, when the sound level was correct the data was recorded as a text file. This was repeated for each locust investigated.

A1.2 Locust DPOAEs Analysis



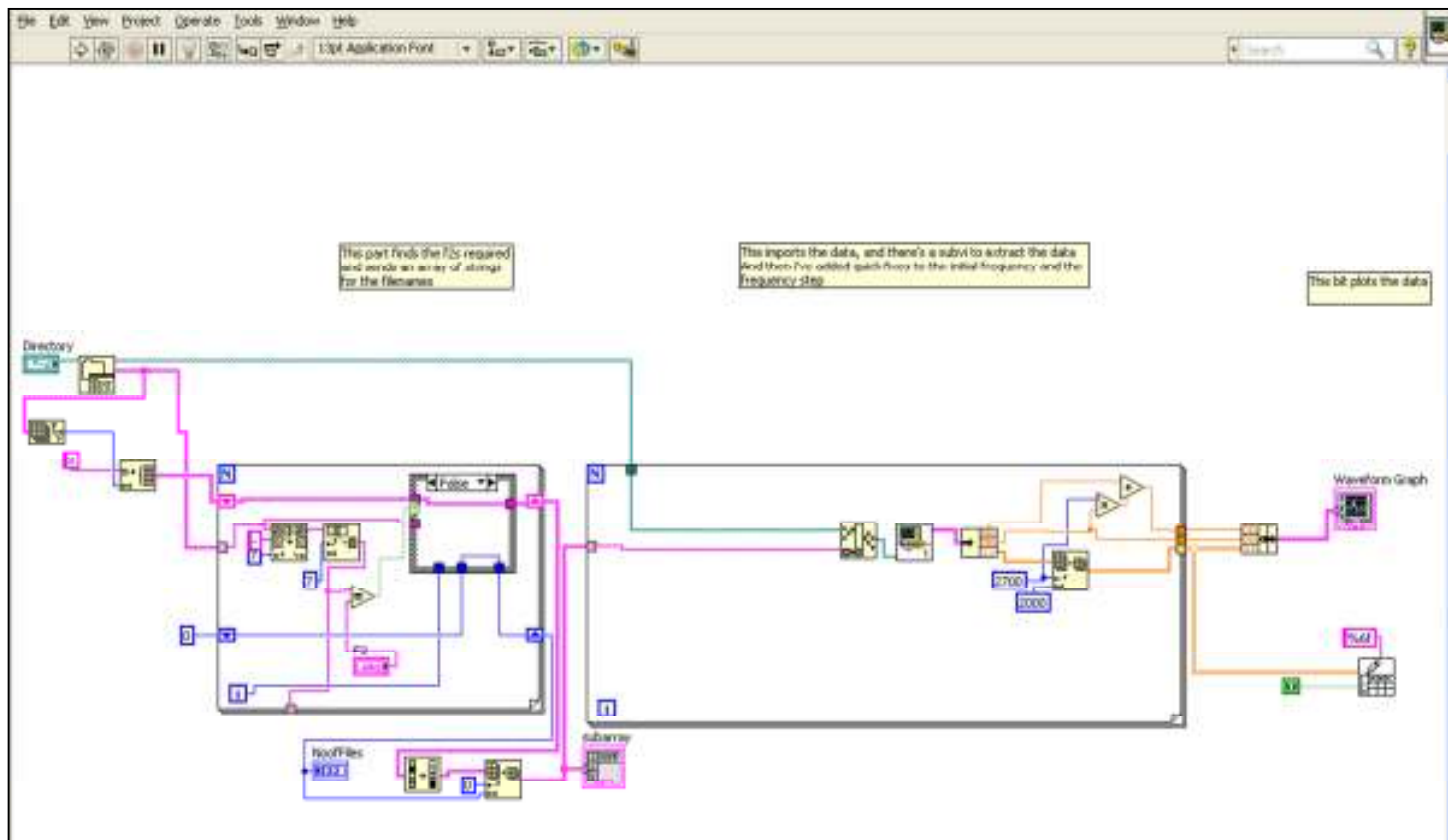

Figure A1.2 The data which was recorded using the previous shown program was then split. Each group of f_1 frequencies over the ratios recorded could be split and saved as a text file. This was repeated for all locusts used before the data could be further analysed.

A1.3 Greater wax moth electrophysiology recording and analysis

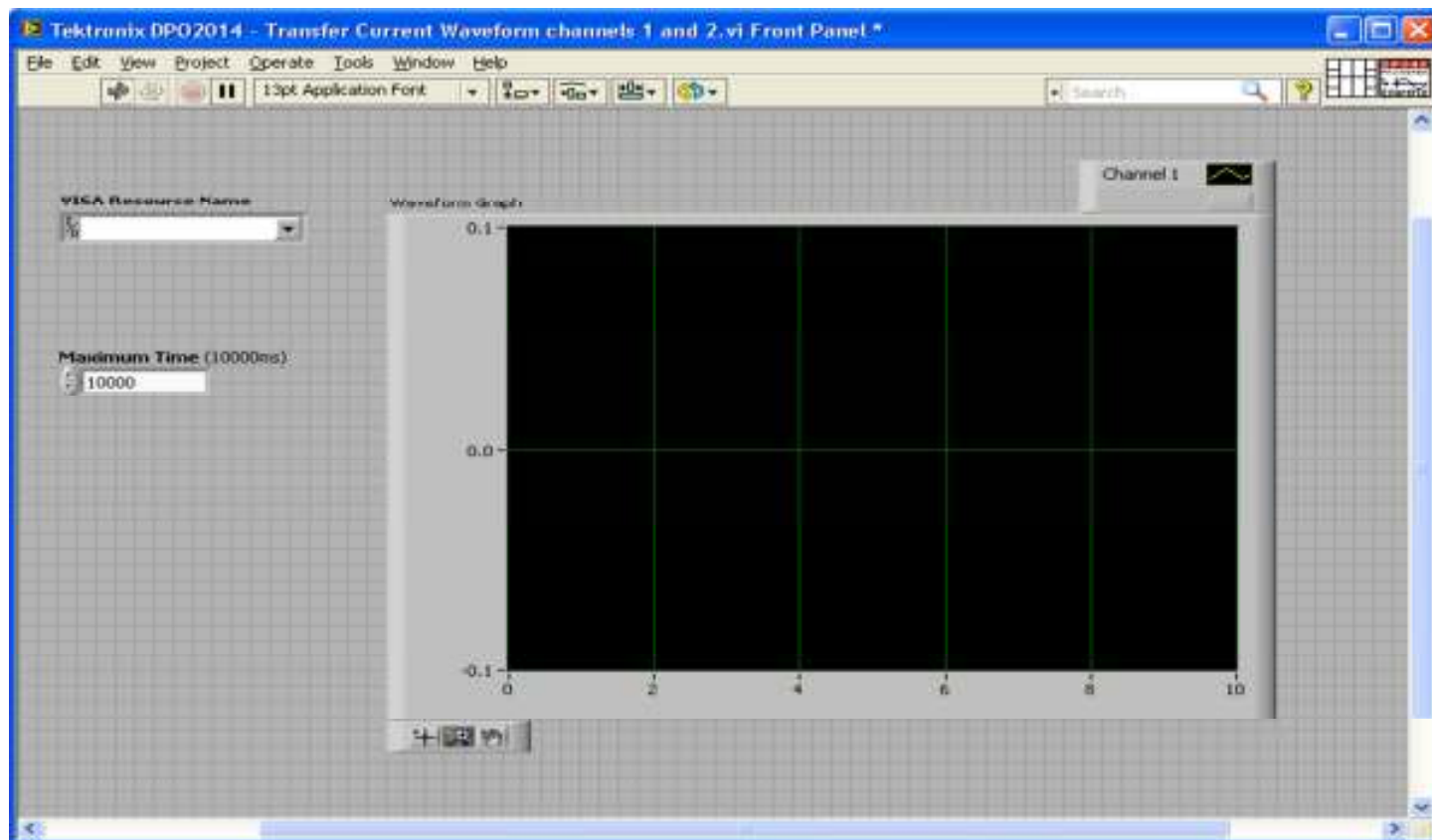
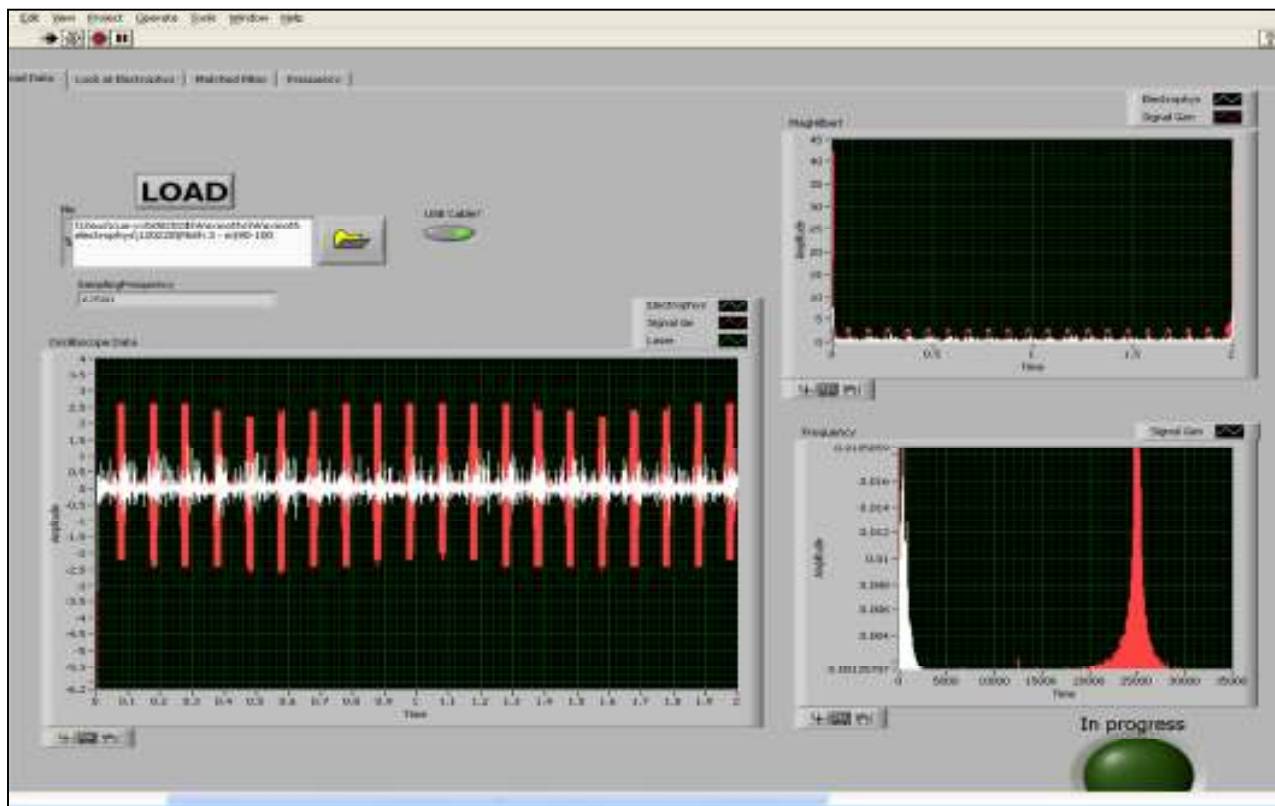

Figure A1.3 The above LabVIEW program recorded the electrophysiology and sound recording from the oscilloscope, the data was saved as a text file.



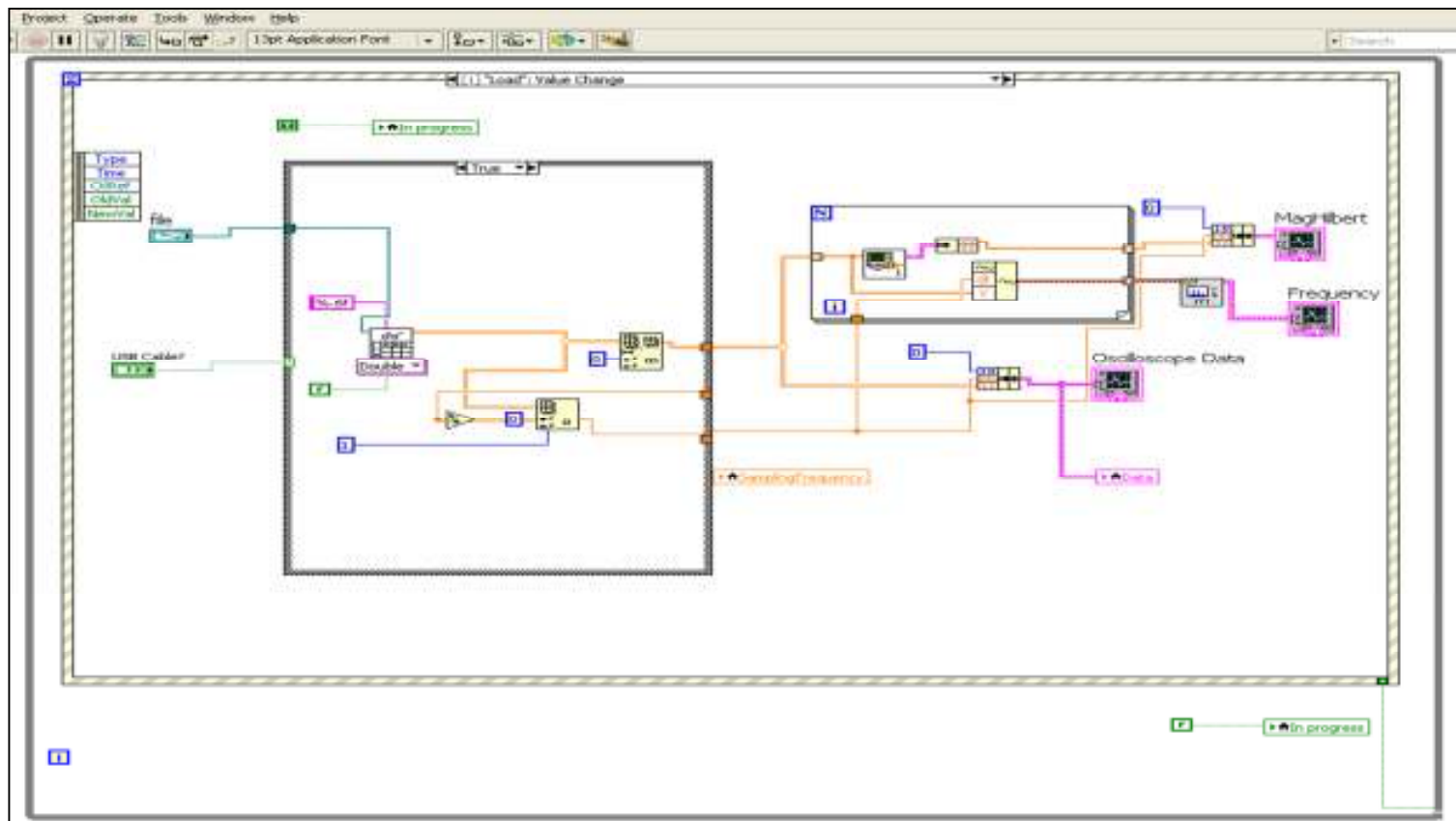
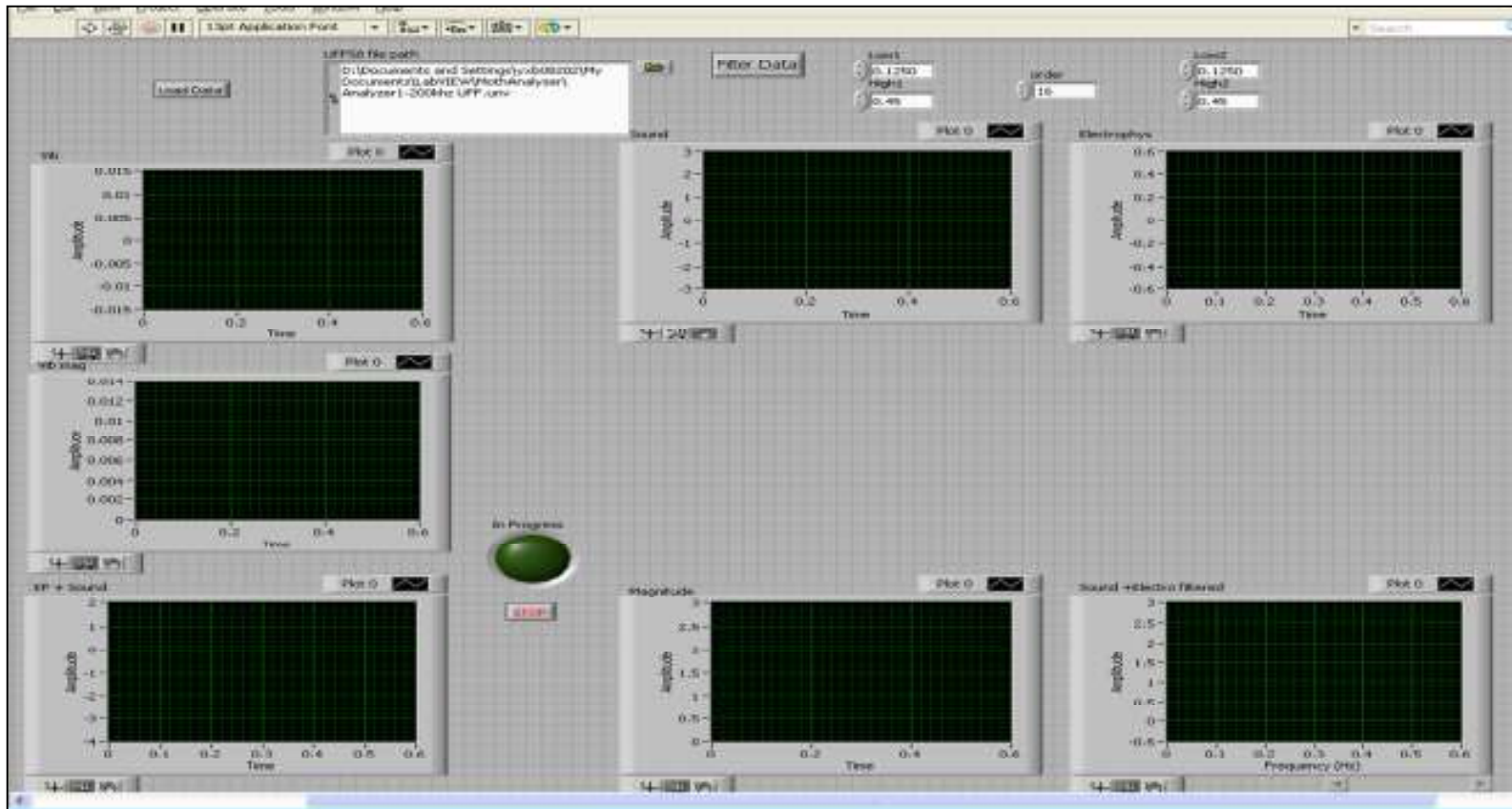

Figure A1.4 The recorded electrophysiology files were analysed using the above program, the electrophysiology trace is shown in white, with the sound pulses also recorded in red. Smaller sections of the time trace could be zoomed in to allow the counting of the A cells for the threshold level over the different sound levels tested. The FFT of both the neural response and also the sound frequency is shown on the bottom right graph, this allowed to check if the electrophysiology recording had 50 Hz noise and also to confirm the frequency of the sound pulses.

A1.4 Laser Vibrometry and Electrophysiology combined experiments



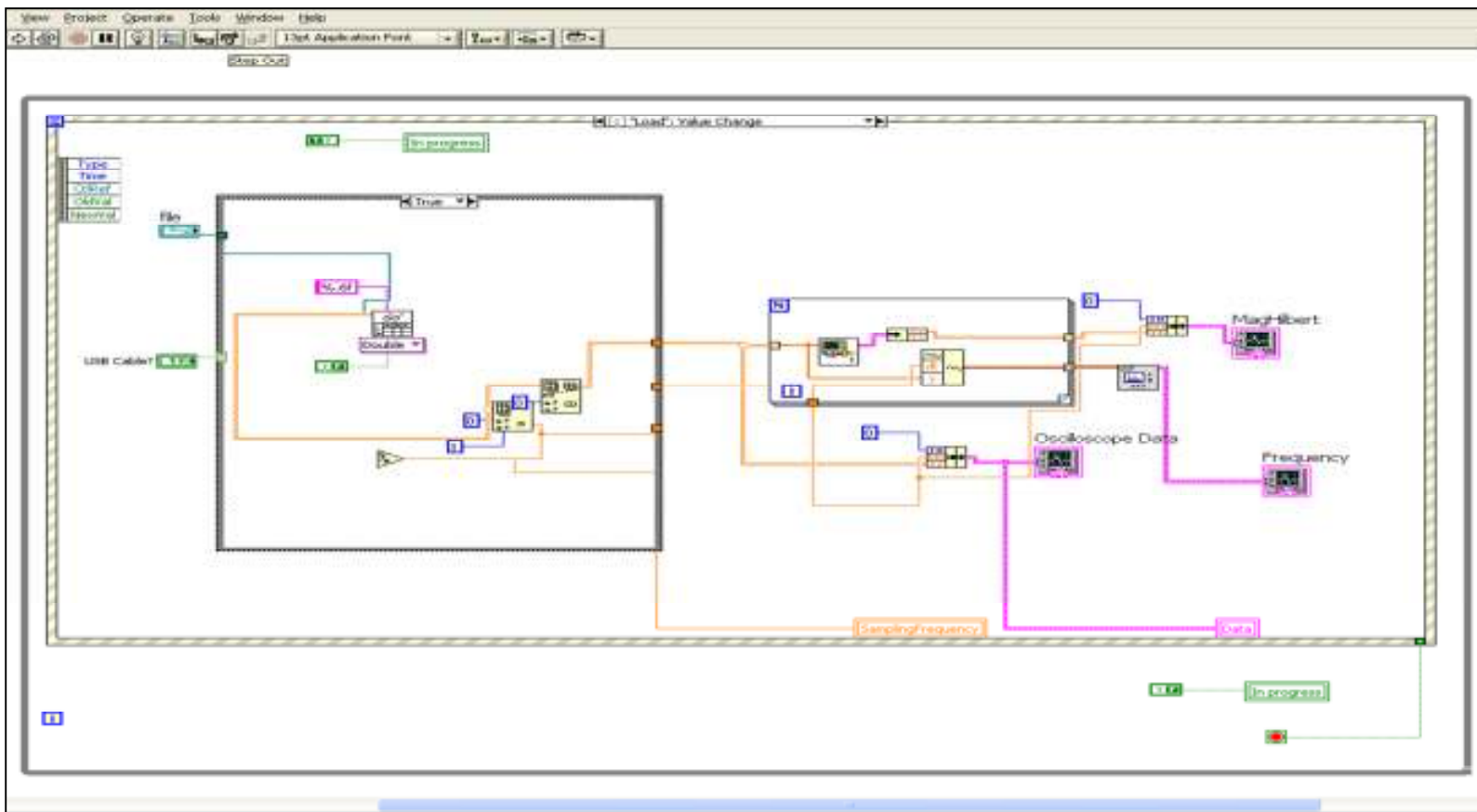

Figure A1.5 The recording of the electrophysiology and the sound pulse which had been combined with the summing amplifier was split back into two different recordings. The data was converted to a Universal file and then loaded into the LabVIEW program which split the two parts using frequency filters as the electrophysiology occupied a much lower frequency than the sound. The laser vibrometry recording was also shown on the front panel and filtering of all the data could be carried out.

Appendix 2: Greater wax moth experiments

A2.1 Dorsal dissection technique

The dorsal dissection method is another option but as the Pyralidae moths tympanal organs are located on the ventral surface of the abdomen, this technique could not be used. After the moth is cooled for 5 minutes in the refrigerator the legs are removed, the moth is pinned as before with staples, securing both wings and a bent staple securing the abdomen and another bent staple pulling back the front legs so the thorax is exposed. Remove the scales from the mesothorax and remove the cuticle at the top of the mesothorax. Cut around the mesothorax, cut the cuticle that connects the abdominal segments. Using tweezers lift the muscle; this should come out in one piece, cut at the top. Add saline to the preparation. The heart is removed along with any intestinal tract. The tracheal tissue in the form of a Y structure should be visible. The nerve should be should lie next to this tissue. The ground electrode is inserted into the abdomen securing with a small piece of plasticine. The nerve is then hooked onto the electrode and the saline drained using a small piece of kim wipe. Acoustic stimulus is played and the nerve activity monitored to ensure the nerve is adequately hooked on the electrode. If there is no neural activity then add saline to the preparation again and hook the nerve again. When it is hooked correctly the apply Vaseline from a syringe around the electrode being very careful not to knock the nerve, this helped to prevent desiccation.

A2.2 Making electrodes

Electrodes were made using tungsten wire of two different thicknesses, the thicker for the reference electrode which has to be inserted to the abdomen and the thinner which is used for the nerve electrode. The wire was trimmed and a short length inserted into a glass capillary. This was then superglued in place and left to dry. The glass capillaries were rather long and so the glass was carefully broken into quarters prior to the wire being inserted. The electrodes were then etched to reduce the thickness of the tips of the electrodes as described in the following section. These electrodes were tested using animals and it was found that the external noise was still very large on the recordings and so various different methods to combat this were investigated. Such as painting the electrode with nail varnish on the length of the wire, the glass capillary could not be used in this case. This did help to reduce the noise slightly.



Figure A2.1 First type of electrodes produced for use in the electrophysiology experiments, the tungsten wire is placed in a glass capillary.

The length of the tungsten wire was greatly reduced to about 3 cm in both the reference and the nerve electrode. This was then soldered to a piece of insulated wire and also etched. The soldering join was then taped with electrical tape also. There was a noticeable difference using this structure of electrode and the previous design was probably too long and picked up the electrical noise of the building.

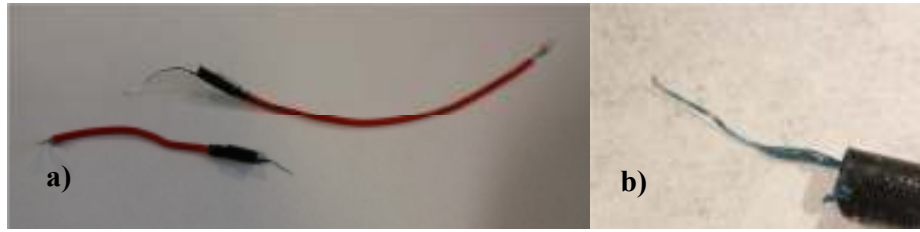

Figure A2.2 Second type of electrodes used in the electrophysiology experiments where a short length of electrode was soldered onto insulated wire and then wrapped in electrical tape **a)**. The exposed electrode is also painted with nail varnish, leaving the very tip exposed **b)**.

A2.3 Etching electrodes

The electrodes were etched to thin the tip; this was to help with insertion of the reference electrode to the body of the insect. The nerve electrode was easier to manage when it was thinner at the tip. To carry out the etching an electrolysis method was used using a chemical reaction, where the electrode was placed in a solution and another length of tungsten wire was also placed in the solution. The molecules of the electrode were then transferred to the other tungsten wire when an electrical current was applied. The chemical solution used was Sodium Hydroxide (NaOH) at 1 mol/L concentration. Set up of equipment is shown in Fig A2.3.

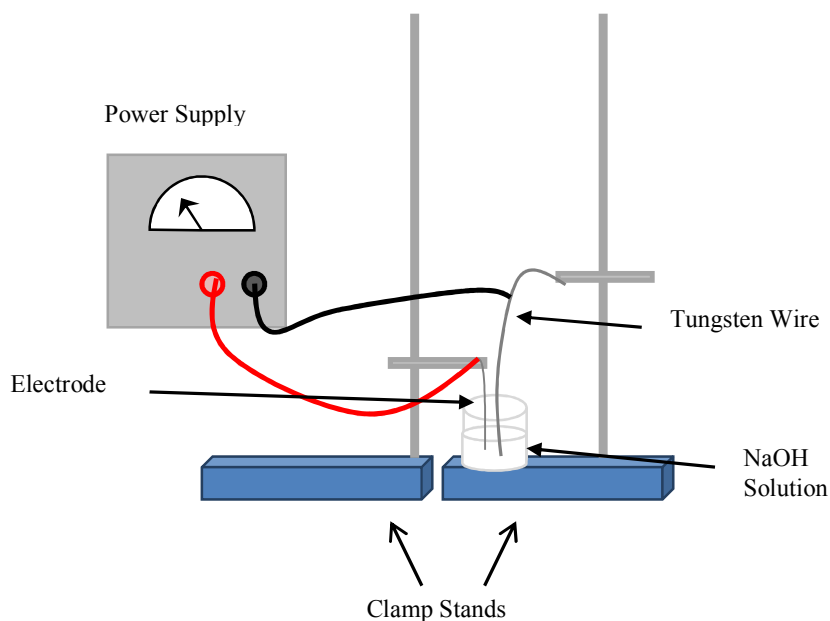

Figure A2.3 Equipment set up used to etch the tungsten electrodes.

A2.4 Saline solution – Spider Ringer

Chemical Compounds

NaCl – 190 MM

KCl – 2 MM

MgCl₂ – 4 MM

CaCl₂ – 4 MM

Concentration – g/L

NaCl – 11.1

KCl – 0.15

MgCl₂ – 0.38

CaCl₂ – 0.59

Measure out all the above compounds using scales into a beaker, then add 1L of deionised water. Add in a magnetic stirrer capsule and place onto a magnetic stirrer, cover the top of the beaker with parafilm. Leave the contents of the beaker stirring until all the compounds have dissolved. Then check with a pH meter, the solution should have a pH of 7.8. If the solution is above or below this in pH, then NaCl or HCl, both of 2 MM concentration, these can be added in drops if the solution is too acidic or alkaline respectively until the solution is at 7.8 pH. Then seal the beaker with parafilm and keep refrigerated.

A2.5 Combined Laser and Electrophysiology experiments – summing amplifier

The amplifier combines the two signals by summing the two outputs by reducing the voltage of the laser vibrometry signal and boosting the electrophysiology signal so that they can be combined at the same level (Fig. A2.4). The size of the resistors needed (R_{sound} and $R_{\text{electrophysiology}}$) were calculated using the equation below [A2.1] The signal can then be recorded on the same time signal with the laser vibrometry channel and then split afterwards as each occupies two different frequency bands using a custom built LabVIEW program (Fig. A1.5).

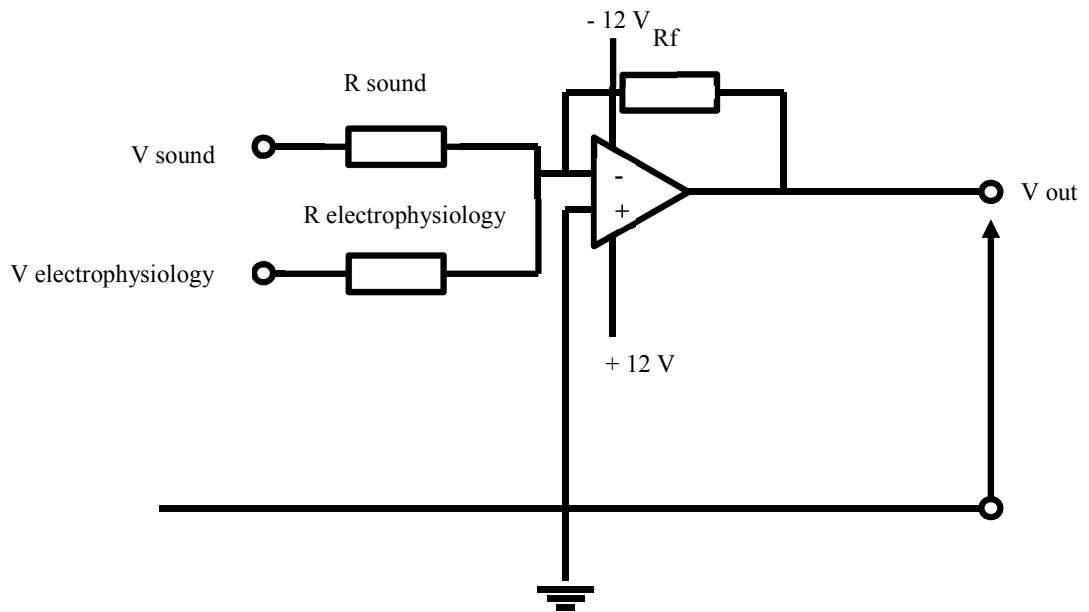

Figure A2.4 Electrical circuit of the summing amplifier used to combine the laser vibrometry and electrophysiology signals.

$$V_{out} = -\left[V_{\text{sound}} \frac{R_f}{R_{\text{sound}}} + V_{\text{electrophysiology}} \frac{R_f}{R_{\text{electrophysiology}}}\right]$$

[A2.1]

A2.6 Greater wax moth laser vibrometry graphs

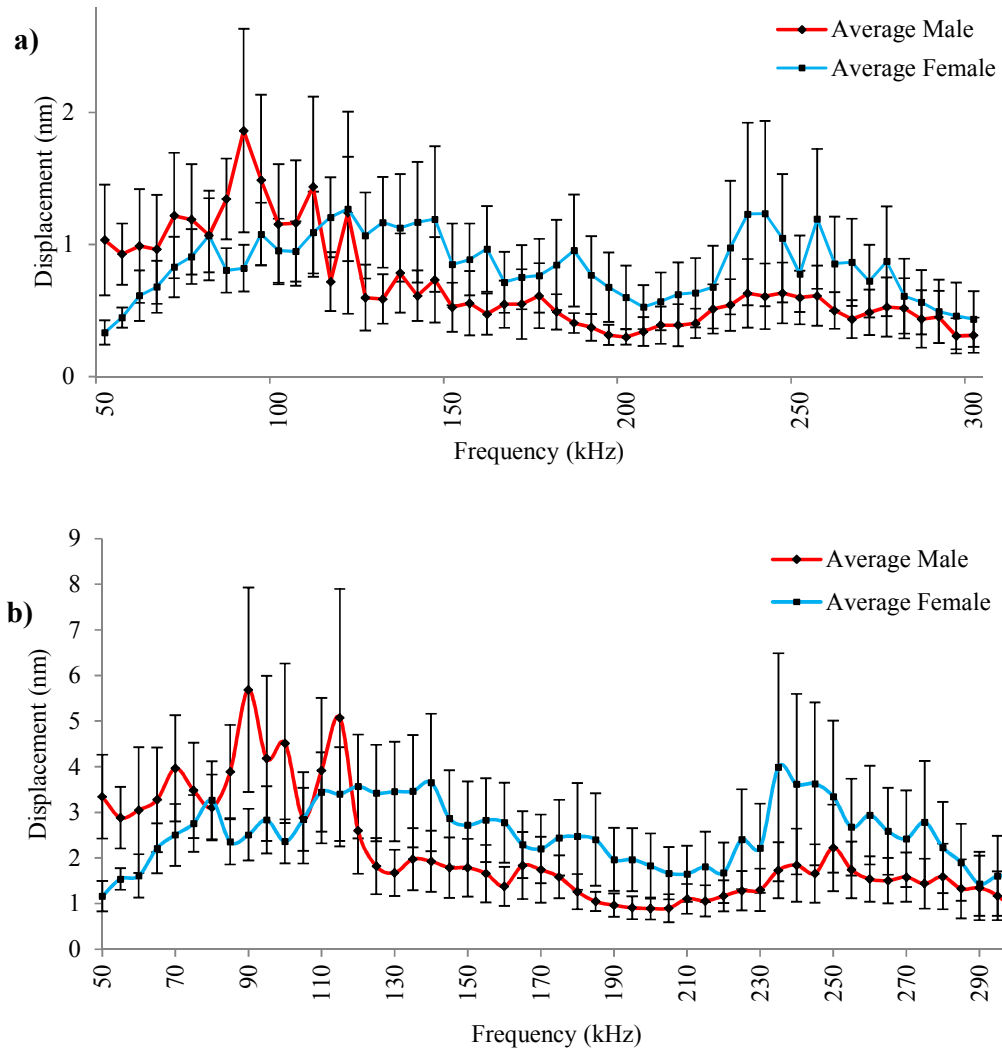

Figure A2.5 The displacement graph of the average male and female displacement of the receptor cell attachment point over frequencies 50-300 kHz, when the sound level is **a)** 70 dB SPL and **b)** 80 dB SPL.

Appendix 3 – Published Work

The thesis work has been presented at the following conferences:

- International Congress of Neuroethology
2012, Maryland, USA - poster presentation
- Invertebrate Sound and Vibration
2011, Missouri, USA - oral presentation
- International Congress of Neuroethology
2010, Salamanca, Spain - poster presentation
- Society for Experimental Biology
2009, Glasgow, UK - poster presentation - *Winner - Best poster prize in category*

And has been published in the following journals:

Moir et al, 2011, No evidence for DPOAEs in the mechanical motion of the locust tympanum, *J. Exp. Biol.*, **214**: 3165-3172

Moir et al, 2012, Ultra high frequency hearing in a moth, Proceedings of the Royal Society B– under review

Extremely high frequency sensitivity in a ‘simple’ ear

Hannah M Moir*, Joseph C Jackson and James F C Windmill

Centre for Ultrasonic Engineering, Department of Electronic and Electrical Engineering, University of Strathclyde, Royal College Building, 204 George Street, Glasgow G1 1XW, United Kingdom

Contact: Hannah.moir@hotmail.co.uk or james.windmill@eee.strath.ac.uk

SUMMARY

Bats and moths are involved in an evolutionary arms race deriving from a predator-prey interaction. Moths have evolved from predation pressure a tympanic hearing organ that acts as an ultrasonic resonator. In turn, bats have evolved ever more complex strategies to avoid being detected by their prey. While the highest known frequency of bat echolocation calls is 212 kHz, the upper limit of moth hearing is considered much lower. Here we show that the ear of the wax moth *Galleria mellonella* is capable of hearing up to 300 kHz. We demonstrate mechanical, using laser Doppler vibrometry, and electrophysiological evidence that this moth's ear, in both sexes, can respond to signals whose frequencies are far higher than signals currently accepted to exist in their environment. The reasons for exceptional hearing in this moth are unclear. We speculate that either this frequency sensitivity is a by-product of a need for greater mechanical temporal acuity, or that there exist bat calls with higher spectral content than previously known. In any case, should the calls of bats move to even higher frequencies, the wax moth is pre-armed.

Keywords: bioacoustics, hearing, laser Doppler vibrometry, electrophysiology, tympanal organ, *Galleria mellonella*

1. INTRODUCTION

Animals that use echolocation produce and hear the highest frequency sounds in the natural world. Ultrasonic echolocation calls are used to build an acoustic view of the local environment when restrictions to normal vision (for example in nocturnal hunting or in murky underwater conditions for cetaceans) render an ultrasonic ‘vision’ more advantageous (1, 2). Spectral content of a bat call can stretch far into the ultrasonic range, with the highest recorded frequency of 212 kHz (3), while some cetaceans are known to produce sounds up to 200 kHz (4). At these high frequencies, air attenuation becomes significant, such that bats need to produce loud echolocation calls that can be up to 110 dB SPL (5). The use of these loud calls by hunting bats to detect prey has led many night flying insects, particularly the moth, to evolve through predation pressure the ability to detect ultrasound (6-13). This interaction constitutes one of the best known evolutionary arms-races between predator and prey (7). This race is continuing - some bats have adapted to produce calls that are not detected by most insects, calling in low or very high frequencies to locate prey (7). Likewise, some moths have evolved clever tuning mechanisms to track the changes in bat calls during a hunt (13).

The use of very high frequencies by certain bats led us to ask if any moths were keeping up in the arms-race. We chose to investigate the hearing of the greater wax moth (*Galleria mellonella*), which as a worldwide apicultural pest may come into contact with a wide variety of bat calls. The greater wax moth ear is a tympanal

hearing organ, and used for both bat detection and mate formation, as the males produce ultrasonic courtship pulses (10, 14, 15). These organs are paired structures located on the first abdominal segment. The tympanal membrane acts like a drum, tuned to vibrate at ultrasonic frequencies. This membrane is divided into two parts (figure 1a), with four auditory receptor cells (A1-A4), and the non-acoustic B cell, attached to the centre of the membrane (16). The B-cell continuously generates action potentials at a fairly constant rate. Cells A1-A4 are the mechano-electrical transducers that generate action potentials when displaced by the membrane, and also fire spontaneously. Auditory nerve recordings have previously shown that this moth's auditory frequency capability ranges from 20-120 kHz (17), but earlier behavioural studies suggested that much higher frequencies may be audible (18, 19). We investigated this both mechanically and neurally, using laser vibrometry and electrophysiology. The sound was produced using a custom build ultrasonic transducer, allowing us to identify how high a frequency a 'simple' moth ear can hear.

2. MATERIALS AND METHODS

a) Animals

Larval greater wax moths were obtained from Livefood UK, and kept in an incubator at 25°C on a 12 hour photoperiod before pupating and emerging. Before experimentation, adult moths were placed in a refrigerator to immobilise them. They were then sexed and pinned to a plasticine block using staples. If the moths were prepared for laser vibrometry experiments the mesothoracic segment was held back

to expose the tympanal membranes. For electrophysiology experiments the first set of leg stumps were held back to expose the thorax for dissection. Sound stimuli were produced using a custom-built air-coupled transducer (see supplementary information).

b) Laser vibrometry

The vibration displacements of the tympanal membrane were recorded using a scanning laser Doppler vibrometer, (Polytec PSV-300-F) using a close up attachment attached to the OFV-056 scanning head. Animals were placed onto a metal holder on top of a tripod. The right tympanal membrane was used for all moths tested as it was positioned nearest to the sound source due to the layout of the equipment. The sound pressure level was measured using a calibrated microphone coupled to a preamplifier (Bruel and Kjaer, Microphone: 4138, Preamplifier: Nexus 2690). The microphone secured in the holder could be adjusted so that it was as close to the tympanal organ as possible. Single frequency sine waves were created using a function generator (Tektronix, Dual Channel AFG 3102), which were passed to the transducer, powered by a high voltage power supply (Brandenburg, 475R). Sound pressure level was altered in steps of 10 dB SPL using an attenuator (JFW Industries, 50BR-009). The displacement of the membrane surface was recorded and using the PSV software an animation of the membrane vibration could be created. The point of the receptor cells' attachment was the largest displacement and this was noted for each frequency tested, 50 – 300 kHz in steps of 5 kHz for each moth tested, n = 16.

c) Electrophysiology

The moths were dissected to expose the auditory nerves which run parallel to the abdominal connective of the metathoracic ganglion (17). One of the auditory nerves was hooked with a tungsten wire electrode and a reference electrode was placed in the abdomen. The ultrasound transducer was set in place directly above the moth. Sound pulse signals were produced by a function generator (TTI Instruments, TGA12102), with each sound pulse lasting 20 ms; all sounds used were a continuous single sine wave, frequencies ranged from 50 - 300 kHz. Auditory nerve action potentials were measured via the electrodes and passed through an amplifier (WPI, DAM 50), and then to an oscilloscope (Tektronix, DPO 2014), the oscilloscope recording was transferred to a LabVIEW program (National Instruments, 8.6.1) which saved the data as a text file from the oscilloscope. The sound level was altered using an attenuator (JFW Industries, 50BR-009) which allowed the sound to be increased or decreased in steps of 5 dB SPL. Using another custom-built LabVIEW program the data was analysed after the electrophysiology data was filtered to remove noise. The threshold was then calculated from the recordings using criteria from previous electrophysiological studies of greater wax moths (17).

d) Simultaneous Laser and Electrophysiology Experiments

Simultaneous recordings of membrane displacement and nerve spikes were carried out using the electrophysiology and laser vibrometer set up as has previously been described. The moth was prepared as for electrophysiology experiments; the laser vibrometer was then positioned to record the membrane displacement. As the sampling rate was 1.024 MHz over a period of 512 ms, the oscilloscope could not be

used for these experiments due to lack of memory space, and so the laser vibrometer acquisition system was used to record the data instead. The sound pulses produced by the function generator and the electrophysiology voltage signal were combined with a custom-built summing amplifier and recorded using the laser vibrometer reference channel. The laser vibrometer voltage signal of the membrane displacements was also recorded through the second channel. The recorded data set of the combined sound and electrophysiology data was analysed afterwards with LabVIEW, as the two signals occupy different frequency bands they were separated using bandpass filters (Bessel). Further filtering was done of all the signals using the LabVIEW program to remove noise. The sound stimulus was produced as was previously described for electrophysiology experiments, a range of frequencies were used and a high sound level of 100 dB SPL was used so that the response of hearing organ would be easily detectable on both the laser vibrometry recordings and electrophysiology.

3. RESULTS

Using a micro-scanning laser Doppler vibrometer, a highly sensitive (10 pm amplitude resolution) non-contact optical technique, we found that the membrane moved maximally at the point of the receptor cell's attachment (figure 1 b-d), which concurred with previous laser vibrometry results for the closely related lesser wax moth (*Achroia grisella*) (20). Interestingly, the response spectrum of the tympanic membrane was not finely tuned, in contrast to other moths such as *Noctua pronuba*, whose ears are extremely sensitive and narrowly tuned to the typical bat echolocation call frequencies they are most likely to hear in their environment (21). Greater wax

moth membrane displacements were over 1 nm at all frequencies tested (50-300 kHz), at a sound level of 90 dB SPL (figure 1e). The largest average membrane displacement measured was at 90-95 kHz, (13.7 ± 3.3 nm; mean \pm s.e., $n = 16$), at 90 dB SPL, which matches the male moth's calling frequency (14) (figure 1e), suggesting that the moths are most sensitive to the intra-specific communication sounds. There also appeared to be a sex difference with the females having slightly greater displacement (16.4 ± 5.5 nm; mean \pm s.e, $n = 8$), compared to the males (12.3 ± 3.0 nm, $n = 8$); however a statistical analysis found no significant difference (One-way ANOVA, $P > 0.1$, $n = 8$ for each sex).

As the auditory receptor cells of the tympanal organ are mechanoreceptors it is thought that a minimum displacement of the membrane is required to activate a neural response. Previous studies in various species of Noctuid moths have shown that the minimum displacement required to generate a neural response is approximately 100 pm (22). In the greater wax moth the tympanal membrane vibrates with at least 1 nm displacement up to 300 kHz in some moths at a level of 80 dB SPL, (1.2 ± 0.5 nm; mean \pm s.e., $n = 16$). Is it possible therefore that the wax moth can hear up to 300 kHz?

The relatively large membrane displacements recorded at high frequencies leads to the hypothesis that the ear may still be neurally responsive at extremely high frequencies, up to 300 kHz. Neural threshold responses were calculated using the same criteria as previous studies (17), *i.e.* 2 or more auditory spikes are present in 8 out of 10 sound stimuli, to overcome potential false positives due to the auditory cell's spontaneous firing coinciding with the sound stimulus. This was repeated for 20 individuals, 10 of each sex (Figure 2a). The highest sensitivity found for our

neural recordings was at 80 kHz (54.9 ± 1.0 dB SPL; mean \pm s.e., $n = 20$). From the electrophysiology recordings it was found that the majority of moths tested could produce a neural response up to 300 kHz. However, not all moths were found to react to tones of 280 and 300 kHz: At 280 kHz, only 2 out of 20 individuals did not respond at 90 dB SPL, and in only 5 out of 20 individuals tested, 300 kHz sound pulses at 90 dB SPL did not elicit nerve spikes. The auditory threshold level for the moths that did respond to these high frequencies matched the trend: At 280 kHz the auditory threshold was (82.9 ± 2.2 dB SPL; mean \pm s.e., $n = 18$) and at 300 kHz it was (86.8 ± 2.6 dB SPL, $n = 15$). It is expected that at higher sound pressure levels, neural responses may still be elicited by those that did not hear at 90 dB SPL.

Our final experiment aimed to simultaneously measure the mechanical motion of the tympanum and the electrophysiological response whilst the ear was stimulated with ultrasound pulses. These time domain recordings show the onset of tympanal motion followed by a volley of neural spikes (figure 3).

4. DISCUSSION

It is now clear that the wax moth *G. mellonella* can hear at least from 20 - 300 kHz, the highest known frequency hearing in the animal kingdom. This broad bandwidth is unusual, so it is useful to speculate on the benefits. In the context of the bat-moth arms race, echolocation hunting calls vary greatly in terms of temporal and frequency parameters (5, 7, 22), and many moths have evolved to possess frequency sensitivity related to the specific bat hunting calls that they are most likely to encounter (22, 23). In noctuid moths, which appear to only detect bats, hearing was shown from the results of both laser vibrometry and electrophysiology recordings to be narrowly

tuned to the frequencies of predatory bats (21). In other moth species where ears are used for two purposes (both bat detection and intra-specific communication), hearing is found to be sensitive to a large range of frequencies (a larger bandwidth) than in ears that are just bat detectors (7), as they are adapted for a wider frequency spectrum of auditory information. The greater wax moth uses ultrasonic pulses for intra-specific communication and as such the hearing is already known to be sensitive over a large range of frequencies (17). As greater wax moths are a worldwide pest, these moths may come into contact with a wide variety of bat calls (19), and so they may have evolved the capability of detecting a large range of frequencies. This would allow them to be better equipped to avoid any species of bat that they may come into contact with, as well as detecting intra-specific ultrasonic communication (20).

Wax moths may also benefit from a large bandwidth in order to provide greater temporal acuity. For an oscillator, the bandwidth is inversely proportional to the rise (or decay) time. Therefore, a larger bandwidth corresponds to a faster rise time such that the oscillator reaches its maximal displacement more quickly. We calculated the temporal acuity from the average displacement curves measured with the laser vibrometer (Fig 1e). The normalised data was fitted to a Lorentzian model to calculate the effective mechanical resonant frequency (ω_0) and dissipation (γ) of the greater wax moth ear. From this the quality factors (ω_0/γ) were calculated as 1.35 ± 0.13 and 0.94 ± 0.13 (mean \pm s.e.) for males and females respectively (n = 8). The quality factor can be interpreted as the number of cycles needed to reach maximal displacement (or the time taken to dissipate 99% of its energy), and so the temporal acuity can be calculated as $10.21 \pm 0.95\mu\text{s}$ and $8.96 \pm 1.19\mu\text{s}$ (mean \pm s.e.) for males and females respectively. These values are faster than the values of temporal acuity

previously recorded in other moths such as the lesser wax moth, between 20-50 μ s (20) and noctuid moths, 60 μ s (24).

Our results show that the tympanal ears of the greater wax moths, both mechanically and neurally, respond to extremely high frequencies of up to 300 kHz. The greater wax moth is thus shown to have the highest frequency response of any known ear in the natural world. How could the moth benefit from hearing a signal at 300 kHz? We can only speculate two reasons. First, it is possible that the large bandwidth has evolved for improved temporal acuity. The male moth's call contains two short (100 μ s) pulses repeated several times in a short burst (<50 ms) (14), whereas bat calls are single pulses with a longer interval (2). Female greater wax moths are capable of discriminating between bat and moth calls which have similar temporal and spectral characteristics (25). The temporal acuity could thus allow the moth to determine whether a sound is from a moth or bat, as previously seen in the behaviour of female lesser wax moths (26). Secondly, as moth ears primarily evolved as bat echolocation detectors, it is possible that the extremely high frequency sensitivity now discovered indicates that the upper limit of bat echolocation is underestimated. In any case, it is clear that the moths are keeping up in evolutionary terms with the predation pressure inflicted by bats. As some bat echolocation calls are known to have frequency components of up to 212 kHz (3), our results indicate that greater wax moths are easily capable of detecting the very highest known limit of bat echolocation calls. In the on-going battle, if bat's hunting calls were to evolve higher ultrasonic frequencies then the greater wax moths are already 'armed' against this.

Acknowledgements

We thank S. Whiteley and T. Mutasa for technical assistance and helpful discussions. This work was supported by funding from the Biotechnology and Biological Sciences Research Council (JW, grant BB/H004637/1), Engineering and Physical Sciences Research Council (HMM, grant EP/F01371X/1 and JCJ, grant EP/H02848X/1) and the Royal Society (JW, grant RG080039).

References

1. Jones G. 2005 Echolocation. *Curr. Biol.* **15**, R484-R488. (DOI 10.1016/j.cub.2005.06.051)
2. Neuweiler G. 1984 Foraging, echolocation and audition in bats. *Naturwissenschaften* **71**, 446-455. (DOI 10.1007/bf00455897)
3. Fenton MB, & Bell GP. 1981 Recognition of species of insectivorous bats by their echolocation calls. *J. Mammal.* **62**, 233-243. (DOI 10.2307/1380701)
4. Ketten DR. 1992 The marine mammal ear specializations for aquatic audition and echolocation. In *The Evolutionary Biology of Hearing*. (eds. DB Webster, RR Fay, & AN Popper) pp. 717-750. New York: Springer.
5. Neuweiler G. 1990 Auditory adaptations for prey capture in echolocating bats. *Physiol. Rev.* **70**, 615-641.
6. Fullard JH. 1987 Sensory ecology and neuroethology of moths and bats interactions. In *Recent Advances in the Study of Bats*. (eds. MB Fenton, PA Racey and JMV Raynor), pp. 244-273. Cambridge: Cambridge University Press.

7. Fullard JH. 1998 The sensory coevolution of moths and bats. In *Comparative Hearing: Insects Springer Handbook of Auditory Research*. (eds. RR Hoy, AN Popper, and RR Fay), pp. 279-326. New York: Springer-Verlag.
8. Hoy R, Nolen T, & Brodfuehrer P. 1989 The neuroethology of acoustic startle and escape in flying insects. *J. Exp. Biol.* **146**, 287-306.
9. Hoy RR, & Robert D. 1996 Tympanal hearing in insects. *Annu. Rev. Ento.* **41**, 433-450.
10. Spangler HG. 1988 Moth hearing defense and communication. *Annu. Rev. Ento.* **33**, 59-82. (DOI 10.1146/annurev.ento.41.1.433)
11. Roeder KD, & Treat AE. 1957 Ultrasonic reception by the tympanic organ of noctuid moths. *J. Exp. Zool.* **134**, 127-157. (DOI 10.1002/jez.1401340107)
12. Roeder KD. 1966 Auditory system of noctuid moths. *Science* **154**, 1515-1521. (DOI 10.1126/science.154.3756.1515)
13. Windmill JFC, Jackson JC, Tuck EJ, & Robert D. 2006 Keeping up with bats: Dynamic auditory tuning in a moth. *Curr. Biol.* **16**, 2418-2423. (DOI 10.1016/j.cub.2006.09.066)
14. Spangler HG. 1986 Functional and temporal analysis of sound production in *Galleria mellonella* L. (Lepidoptera, Pyralidae). *J. Comp. Physiol. A* **159**, 751-756. (DOI 10.1007/bf00603728)
15. Conner WE. 1999 'Un chant d'appel amoureux': Acoustic communication in moths. *J. Exp. Biol.* **202**, 1711-1723.
16. Mullen MA, & Tsao CH. 1971 Morphology of the tympanic organ of the greater wax moth *Galleria mellonella*. *J. Georgia Entomol. Soc.* **6**, 124-132.

17. Skals N, & Surlykke A. 2000 Hearing and evasive behaviour in the greater wax moth, *Galleria mellonella* (Pyralidae). *Physiol. Entomol.* **25**, 354-362. (DOI 10.1046/j.1365-3032.2000.00204.x)
18. Spangler HG, & Takessian A. Sound perception by 2 species of wax moths (Lepidoptera, Pyralidae). *Ann. Entomol. Soc. Am.* **76**, 94-97.
19. Spangler HG. 1984 Responses of the greater wax moth, *Galleria mellonella* L. (Lepidoptera, Pyralidae) to continuous high-frequency sound. *J. Kansas Entomol. Soc.* **57**, 44-49.
20. Rodriguez RL, Schul J, Cocroft RB, & Greenfield MD. 2005 The contribution of tympanic transmission to fine temporal signal evaluation in an ultrasonic moth. *J. Exp. Biol.* **208**, 4159-4165. (DOI 10.1242/jeb.01893)
21. Windmill JFC, Fullard JH, & Robert D. 2007 Mechanics of a 'simple' ear: tympanal vibrations in noctuid moths. *J. Exp. Biol.* **210**, 2637-2648. (DOI 10.1242/jeb.005025)
22. Neuweiler G. 1989 Foraging ecology and audition in echolocating bats. *Trends Ecol. Evol.* **4**, 160-166. (DOI 10.1016/0169-5347(89)90120-1)
23. Fullard JH. 1982 Echolocation assemblages and their effects on moth auditory systems. *Can. J. Zool.* **60**, 2572-2576. (DOI 10.1139/z82-330)
24. Schiolten P, Larsen, ON & Michelsen A. 1981 Mechanical time resolution in some insect ears 1. Impulse responses and time constants. *J. Comp. Physiol.* **143**, 289-295.
25. Jones G, Barabas A, Elliott W, & Parsons S. 2002 Female greater wax moths reduce sexual display behavior in relation to the potential risk of predation by echolocating bats. *Behav. Ecol.* **13**, 375-380. (DOI 10.1093/beheco/13.3.375)

26. Greenfield MD, & Weber T. 2000 Evolution of ultrasonic signalling in wax moths: discrimination of ultrasonic mating calls from bat echolocation signals and the exploitation of an anti-predator receiver bias by sexual advertisement. *Ethol. Ecol. Evol.* **12**, 259-279.

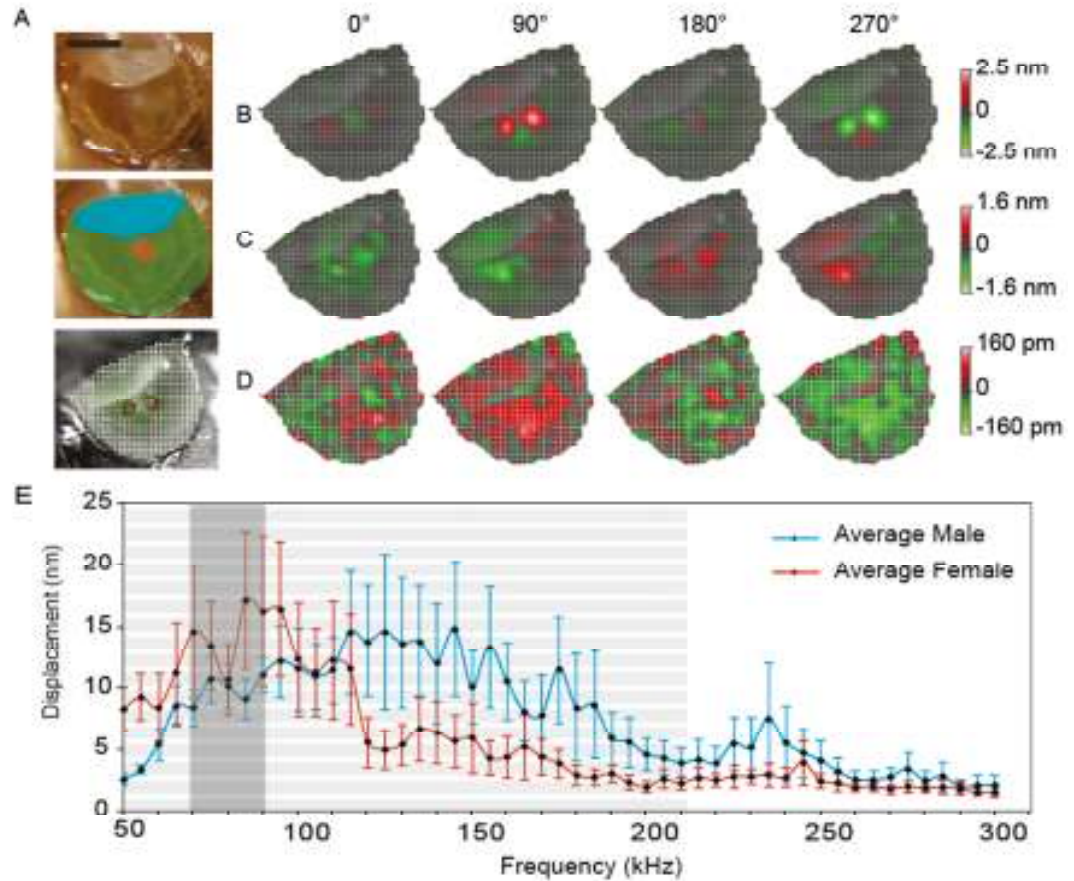

Figure 1. Laser Doppler vibrometry measurements of the greater wax moth tympanal membrane. **a**, Top: Greater wax moth tympanal organ, scale 0.1 mm. Middle: Highlighted features are the conjunctivum (blue), tympanic membrane (green), auditory receptor attachment site (orange). Bottom: Membrane measurement points to be scanned. **b**, **c**, **d** Vibrometry scans of a female moth tympanal organ, displacements inward (green), outward (red). Measurements are shown over 4 different phases through the oscillation cycle at different frequencies. **b**, 80 kHz, **c**, 280 kHz, **d**, 300 kHz. All measurements were at 90 dB SPL. **e**, The mean \pm s.e. displacement of the receptor attachment site from 50 – 300 kHz for male and female individuals ($n = 8$ for each sex), at 90 dB SPL at all frequencies. Male call frequency range is highlighted (solid grey), and known hunting bat call frequency ranges are highlighted (horizontal lines). No significant difference in the displacement spectra was found between the sexes (One-way ANOVA, $P > 0.1$, $n = 20$).

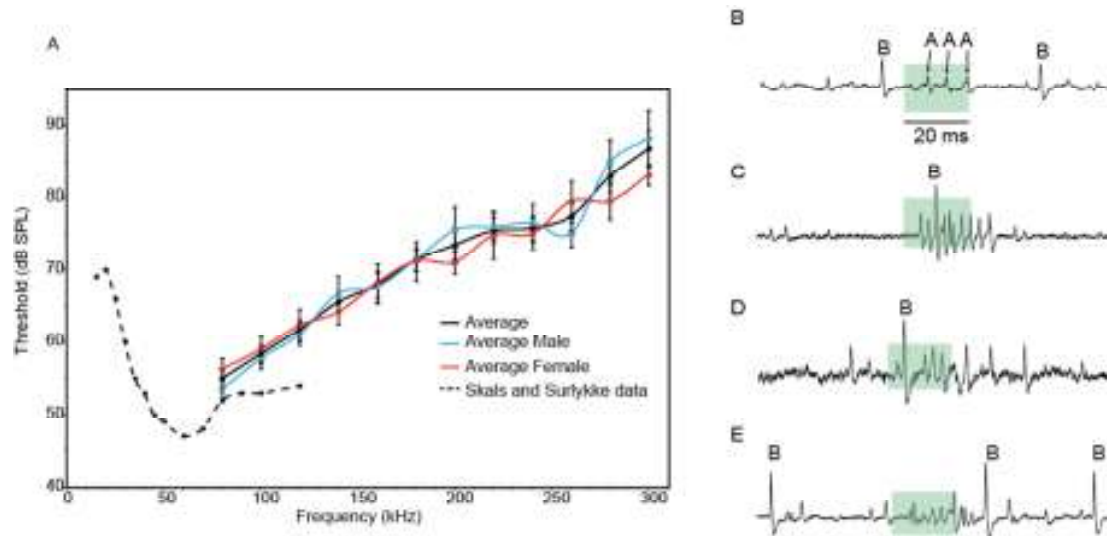

Figure 2. Electrophysiology recordings of the auditory nerve. **a**, Auditory threshold from 15 – 300 kHz. Thresholds include the previous measured data [20] (dashed line, permissions granted), the average of all moths tested (black), the average female (red), and the average male (blue); all error bars shown are standard error. There was no difference between male and female threshold levels (Mann-Whitney U Test, $P > 0.1$, $n=10$ for each sex). **b-e**, Examples of electrophysiological recordings, the 20 ms sound pulse is highlighted in green. The four auditory receptor A-cells have different sensitivity levels with A1 being the most sensitive and appearing first at the lowest sound levels. **b**, Nerve response at 80 kHz at threshold level, the A-cell and non-acoustic B-cell responses are labelled. **c-e**, Sound level of 90 dB SPL, non-acoustic B-cell responses are labelled. **c**, Nerve recording at 80 kHz, showing all A-cells firing. **d**, Nerve response at 280 kHz. **e**, Nerve response at 300 kHz.

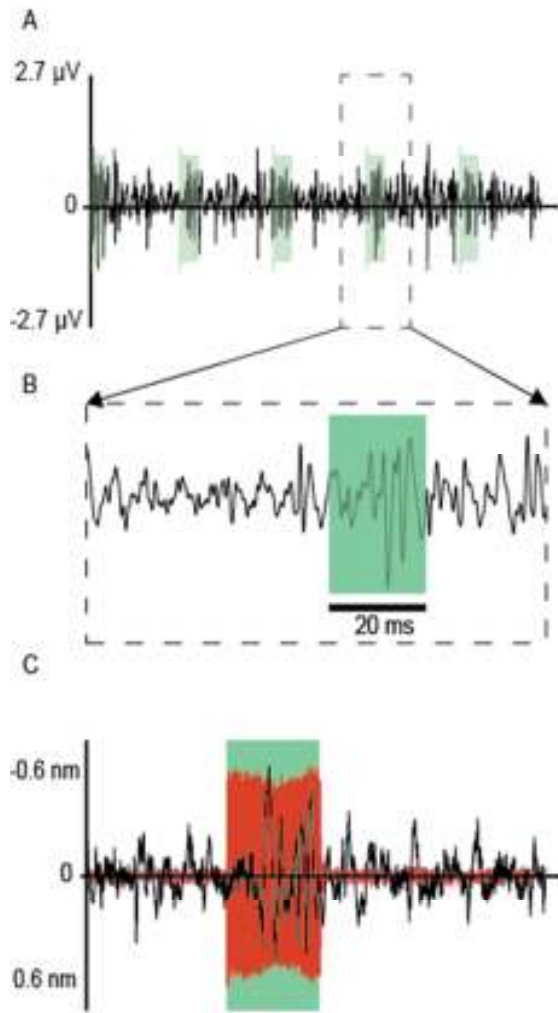

Figure 3. Simultaneous laser vibrometry and electrophysiology of the tympanal organ of a male greater wax moth. **a**, Nerve recording (black trace) and the sound stimulus (200 kHz, 20 ms sound pulses, green trace). **b**, Magnification of the 4th sound pulse of the nerve recording: the A cell responses due to the sound stimulus are distinguishable. **c**, Averaged response to 5 sound pulses. Sound stimulus (green) elicits a mechanical motion (red). Neural activity (black trace) appears after some latency.

Supplementary Information

Supplementary Experimental Methods

Ultrasonic Transducer Structure

The ultrasonic transducer used in the experiments was a custom made electrostatic air coupled device (S1). The device was composed of an insulating PVC shoe which is encased within an aluminium case. The front face of the transducer was a membrane made of polymer film which had been metallised with evaporated aluminium. The membrane was stretched over the backplate and held in place with an aluminium ring, which was screwed in place into the aluminium case. This ring provided electrical connection between the case and the metallised front face of the membrane.

Powering the Transducer

The transducer electronic system is shown in Figure S1. The transducer was powered with a high voltage power supply (475R photomultiplier power supply, Brandenburg, Dudley, UK), which provided a bias voltage. The sound signal was created using different function generators; for the electrophysiology experiments where sound pulses were created (Arbitrary Waveform generator, TGA12102, TTI), and for the laser vibrometry experiments where a pure tone sine wave was used (Tektronix, Dual Channel-AFG 3102).

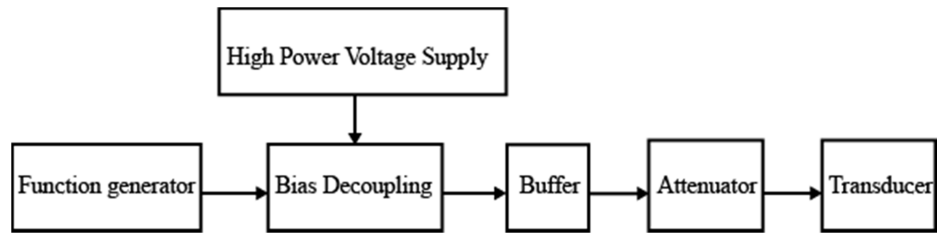

Figure S1. The equipment used to power the transducer.

Transducer Power Output

The output of the transducer was measured with a microphone and preamplifier (Bruel and Kjael, Microphone: 4138, Preamplifier: Nexus 2690). The transducer was powered as previously described, with the function generator output set at 5 V_{pp} and 10 V_{pp} (pp: peak to peak). The sound pressure level was measured with the microphone 10 cm away from the transducer. The output of the microphone was measured on an oscilloscope (Tektronix, DPO 2014), and this was recorded for frequencies between 50-120 kHz at 10 kHz intervals (see Figure S2). The transducer output is known to be consistent after 100 kHz (S1), providing a known sound stimulus at all frequencies tested.

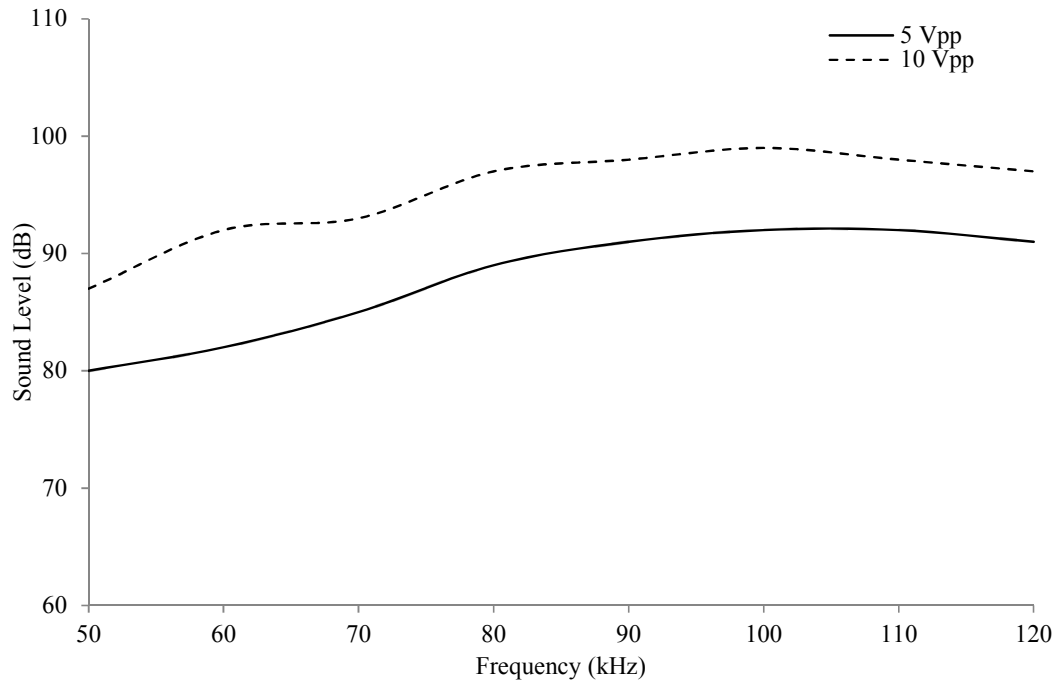

Figure S2. The sound level output of the transducer at two different driving voltage levels, 5 Vpp and 10 Vpp. The sound level (dB SPL) was recorded using a microphone, between 50-120 kHz, in steps of 10 kHz.

The electrophysiology experiments sound stimuli, 20ms sound pulses, were investigated to rule out the possibility that there were other (lower) frequencies being created due to artefacts. To test this two transducers were used, one to emit the sound and one to detect it, as the frequencies tested were too high to use the microphone. The detected sound pulses were recorded on an oscilloscope (Tektronix, DPO 2014). The recorded sound pulses clearly demonstrate a correct signal at all frequencies investigated, indicating that no extra frequencies were being produced (see Figure S3).



Figure S3. Start of a sound pulse used in moth electrophysiology experiments, recorded using a second transducer. The sine wave recorded was as expected, and so no extra frequencies were being created. This was the same for the range of frequencies tested. The above example is a 200 kHz sound pulse.

References

- S1. Whiteley, SM, Waters, DA, Hayward, G, Pierce, SG & Farr, I. 2010 Wireless recording of the calls of *Rousettus aegyptiacus* and their reproduction using electrostatic transducers. *Bioinspir. Biomim.* **5**, 026001