



**Design, Development and Demonstration of an Active
Network Management Testbed**

Thesis presented for the degree of

Master of Philosophy

at the University of Strathclyde

by

Craig Breaden

Department of Electronic and Electrical Engineering
University of Strathclyde

2015

Acknowledgments

I'd like to thank all of my colleagues at Smarter Grid Solutions for their support throughout the project. Three friends - Euan Davidson, Mike Dolan & Iain Smith - have been pillars of support through both professional and personal trials and tribulations, thus deserve special mention.

Euan's exceptional levels of personal and academic integrity are inspirational. Without his capacity for innovative and original thought, this project would not have been the success it was.

Mike's Trojan-like work ethic was often the driving force behind this work (and Thesis!) A few delirious weeks building a demonstration system was made far more manageable with Mike's presence and assistance. His contribution will not be forgotten when I win the Euromillions.

I'm highly grateful for the help and guidance provided by Iain Smith. His encyclopaedic knowledge of the system was invaluable during the design process. A true gent in every aspect of life.

Dr Adam Dysko was always available for support and a new perspective. His involvement and guidance throughout is always appreciated.

Dr Gerry Black's guidance throughout the project is very much appreciated. On his advice I was able to fulfil a dream by attending Massachusetts Institute of Technology.

Finally, but most importantly, my parents and sister have provided me with a bottomless pit of love, support and occasionally finances. I'm not sure whether this is a credit or criticism, but I would not be half the man I am today without them.

Declaration of Author's Right

The copyright of this thesis belongs to the author under the terms of the United Kingdom Copyright Acts as qualified by the University of Strathclyde Regulation 3.50. Due acknowledgement must always be made of the use of any material contained in, or derived from, this thesis.

Signed: _____

Date: _____

Abstract

The push to accommodate Distributed Generation (DG) has led to the requirement of better investing in the planning and operation of power networks. Geographically, in the UK, the most suitable areas of Distributed Generation typically exist in locations not previously designed for larger or reverse power flows. This leads to the need to costly and timely upgrades the physical infrastructure. Active Network Management (ANM) has been presented as a method of controlling existing assets in a real-time deterministic manner to allow it to operate closer to its limits thus deferring or avoiding investment. Active Network Management makes use of real time measurements to control generation or load to ensure the network remains within a set of safe, pre-defined limits, allowing network design rules to be relaxed.

Introducing new control techniques to power networks has a number of challenges. One such challenge is the time taken for utilities to adopt the technology and sufficient testing platforms to ensure safe and reliable operation. A current deployment, as implemented by Smarter Grid Solutions Ltd., took over 5 years to reach closed loop control. An area of research intended to speed up time to adoption and advance testing, amongst other objectives, is co-simulation: the real-time dynamic simulation of both the power system, the devices connected to it; and the communications infrastructure required for ANM.

This thesis describes work undertaken as part of a Knowledge Transfer Partnership between University of Strathclyde and Smarter Grid Solutions Ltd, which has resulted in the design, development and demonstration of a prototype testbed for ANM which

utilises co-simulation. Challenges and opportunities for further research into co-simulation for ANM have also been identified.

CONTENTS

1	Introduction	1
1.1	Motivation for research	1
1.2	Research objectives.....	3
1.3	Research contribution.....	4
1.4	Thesis overview	5
1.5	Publications	5
2	Active Network Management.....	7
2.1	Introduction	7
2.2	Background on the grid.....	7
2.3	Enablers.....	9
2.4	Why DG presents challenges	11
2.5	What is ANM	12
2.5.1	Power Flow Management.....	12
2.5.2	Voltage Control	13
2.5.3	Load & Generation Dispatch	13
2.5.4	State Estimation	14
2.6	Existing ANM Projects	15
2.6.1	Orkney	15
2.6.2	GenAVC	15

2.6.3	AuRA-NMS.....	16
2.6.4	DG DemoNet (Siemens/ATI)	17
2.7	Commercial Offerings	18
2.8	Chapter Summary	19
3	Test Environment.....	20
3.1	Introduction	20
3.2	Applications.....	20
3.3	Methodology.....	21
3.3.1	Requirements Capture	21
3.3.2	Technology Review and Trials.....	22
3.3.3	Cost Benefit Analysis	22
3.3.4	Design.....	22
3.4	Changing ANM Environment.....	23
3.5	Objectives/Requirements	26
3.6	Research on Co-Simulation	29
3.7	Overview of Software packages.....	31
3.7.1	Communications Emulation	31
3.7.2	Power Systems Simulation	34
3.8	Software Selection	37
3.9	Generic testbed architecture	38

3.10	Chapter Summary	40
4	Case Studies	41
4.1	Introduction	41
4.2	Case Study 1 – Principles of Access Test	43
4.2.1	Overview	43
4.2.2	Environment Configuration.....	45
4.2.3	Network Model	47
4.2.4	Simulation	49
4.2.5	Results	51
4.2.6	Proof of PoA: LIFO	51
4.2.7	Proof of PoA: Shared	54
4.2.8	Proof of PoA: Mix PoA (LIFO and Shared)	56
4.2.9	Observations	59
4.3	Case Study 2 – Orkney Simulation	60
4.3.1	Overview	60
4.3.2	Environment Configuration.....	60
4.3.3	Network Model	62
4.3.4	Dynamic Controllers.....	63
4.3.5	Simulations.....	63
4.3.6	Results of simulation	63

4.3.7	Observations	66
4.4	Case Study 3 – Automatic Voltage Controller.....	68
4.4.1	Overview	68
4.4.2	Environment Configuration.....	68
4.4.3	Network Model	69
4.4.4	Dynamic Controller	69
4.4.5	Simulation	70
4.5	Case Study 4 – Communications Emulation	73
4.5.1	Overview	73
4.5.2	Environment.....	73
4.5.3	Results	74
4.6	Chapter Summary	75
5	Discussion and Further Work.....	77
5.1	Conclusions	77
5.2	Future Work	79
6	References.....	81
6.1	Chapter 1 References.....	Error! Bookmark not defined.

Glossary

ANM	Active Network Management
AVC	Automatic Voltage Controller
CIREN	Congrès International des Réseaux Electriques de Distribution (translation - International Conference on Electricity Distribution)
DG	Distributed Generation
DNOs	Distribution Network Operators
DPCR4	Distribution Price Control Period 4
EPRI	Electric Power Research Institute
IEEE	Institute of Electrical and Electronics Engineers
IEC	International Electrotechnical Commission
IFI	Innovation Funding Incentive
LCNF	Low Carbon Networks Fund
LIFO	Last In First Out
NIC	Network Interface Card
NS-3	Network Simulator 3
Ofgem	Office for Gas and Electricity Markets
OPC	OLE (Object Linking Embedding) for Process Control
OSI	Open Systems Interconnection
PoA	Principles of Access
RIIO	Revenues = Incentives + Innovation + Outputs

RPZ	Registered Power Zone
RTDS	Real Time Digital Simulator©
RTU	Remote Terminal Unit
SCADA	Supervisory Control And Data Acquisition
SGS	Smarter Grid Solutions Ltd.
TCP	Transport Communication Protocol
UoS	University of Strathclyde
UKPN	UK Power Network

List of Tables

Table 1. ANM Hardware.....	47
Table 2. Test Scenario 1	49
Table 3 sgs power flow Thresholds	63
Table 4 Generator Priority Order	65
Table 5 Sequence of Events	66

List of Figures

Figure 1 Structure of Electricity Network	8
Figure 2 Methodology	21
Figure 3. CENELEC Smart Grid Architecture Model [1]	24
Figure 4. Communications Failure	25
Figure 5. NS-3 Model Architecture	32
Figure 6. Voltage Profile	36
Figure 7. Active & Reactive Generation Profile.....	36
Figure 8 Generic High Level Architecture	39
Figure 9 Dynamic Controller for DFIG	44
Figure 10. Active Power Controller for DFIG.....	45
Figure 11. Test Environment Configuration for PoA Tests	46
Figure 12. Network Model for POA Tests	48
Figure 13. Voltage Levels at Busbar D without any ANM Control Actions.	50
Figure 14. Voltage Levels at Busbar D with LIFO Ordered ANM Control Actions	52
Figure 15. LIFO Generator Set-points Issued	53
Figure 16. Corresponding MW output of DG Units following the LIFO PoA.....	53
Figure 17. Voltage Levels at Busbar D with Shared ANM Control Actions	54
Figure 18. Shared Generator Set-points Issued	55
Figure 19. Corresponding MW output of DG Units following the Shared PoA .	56
Figure 20. Voltage Levels at Busbar D with Mixed Order ANM Control Actions	57
Figure 21. Mixed PoA Generator Set-points Issued.....	58
Figure 22. Corresponding MW output of DG Units following the Mixed PoA...	58

Figure 23. Environment Configuration.....	60
Figure 24. Power Flow Control Network Model	62
Figure 25. Constrained Branch Loading and Thresholds	64
Figure 26. Generator MW Response to Thermal Overloads.....	65
Figure 27. Voltage Control proof of concept	68
Figure 28. Generator and AVC Control for Voltage Studies.....	69
Figure 29. AVC Model.....	70
Figure 30. Tap Changer Set Point Model	70
Figure 31. Tap Position.....	71
Figure 32. Voltage Response to Tap Change.....	72
Figure 33 Test Environment with Communications Emulation	73
Figure 34 Traffic at NIC 1.....	74
Figure 35 Traffic at NIC 2.....	74

1 Introduction

1.1 Motivation for research

The evolution of the power systems network is synonymous with the term “Smart Grid” which encompasses a variety of technologies and activities. The interconnection and communication of devices on the power network opens up a wide array new applications [1]. A plethora of new possibilities exist for advancing power networks: Advanced metering gives a greater understanding of the behaviour of energy consumer and new mechanism for consumer engagement with the supply and use of electrical energy [2]; Devices have been developed to automatically reclose lines during post fault conditions [3]; and new methods of control are being developed to utilise existing assets more efficiently.

Active Network Management (ANM) is one such control method. The introduction of Distributed Generation (DG) presents a number of problems. Currently, network planning is typically conservative. Aging distribution networks were not design for adding generation, which gives rise to a number of problems including breaching the thermal limits of cables or voltage rise or step [4]. This means to accommodate added DG, lines and switchgear may require upgrading; a costly and timely process. However, through monitoring and controlling the network condition in real-time, ANM allows the planning limits to be less conservative, freeing up capacity on the network, thus deferring or avoiding physical reinforcements. Various different

approaches to ANM have been suggested [5][6][7], and are described in chapter 3, however all rely on new communications infrastructure and exploit the controllability of DG to some degree.

One such example is the deployed ANM system that operates on the Orkney Isles off the North coast of Scotland [8]. The network topology and conditions provided an ideal test bed for trialling power flow management as a method of connecting further DG on a network already considered to be operating at capacity. The network consisted of an islanded 33kV parallel circuit feeding radial loads with an interconnector to the UK mainland. The trial has proved to be successful and evidenced Active Power Flow Management as an alternative to traditional upgrades, connecting over 20MW to what was previously considered a 'full' network.

The process of getting to closed loop trials was timely. From inception to deployment took approximately 5 years. Simulation was not used to develop the solution and thus, lessons pertaining to the temporal response of the system were learned during field trials and the logic had to be adapted iteratively. This approach may not be suitable for other network topologies or problems such as voltage control.

Despite the initial success of the Orkney Registered Power Zone (RPZ), it is anticipated that as solutions are scaled and incorporated into interconnected networks with increased complexity, co-simulation testing can play a role in the commercialisation process.

Smarter Grid Solutions Ltd. (SGS) was spun out of University of Strathclyde (UoS) in 2008 to commercialise research in the field of ANM and deliver the aforementioned Orkney RPZ. Since then, the company has grown mostly through regulator funded projects. The work of this thesis is completed under the auspices of a Knowledge Transfer Partnership between UoS and SGS. The aspirations of this work is to design, develop and prototype a test environment which takes learning from the exiting test environment in UoS. This thesis will serve as an account of the research and learning from implementing an appropriate and cost-effective test environment at SGS. The possibilities to refine the test environment for future development will be explored.

1.2 Research objectives

The research presented in this thesis had the following objectives:

- Present the requirements of a test bed for ANM based on the existing requirements of the verification and validation process internally at SGS;
- A literature review of the academic community's activity in the area of co-simulation and ANM field trials to give an understanding of the future requirements and developments which will inform the design of a testbed;
- An evaluation of the current open source and commercially available software and hardware. The suitability in terms of capability, limits, cost and potential will be assessed to determine its role in the design of an ANM test environment; and
- Informed by the previous activities, the design, development and demonstration of the prototype of the test environment will be presented through a number of case studies to show applications and understand

limitations.

1.3 Research contribution

The key contributions of this thesis can be summarised as follows:

- 1) This thesis makes available to the academic community the process of understanding the requirements for a test environment which feeds into its design. An example architecture of the test environment which was designed with flexibility and modularity for the purposes of testing ANM solutions is presented.
- 2) The testing of various modelling packages is discussed. Their merits and limitations are assessed to determine the suitability for ANM solution prototyping and future applications.
- 3) The challenge of integrating and synergising software simulations in a 'hardware in the loop' scenario is described. The method of co-simulating the power network and communications platform to reflect the actions of the ANM system is documented. A few realistic case studies are presented to demonstrate a proof of concept.
- 4) The limitations and opportunities of this proof of concept trial are also assessed. There exist a number of potential uses for the proposed approach depending on the perspective or role. Future potential is identified and discussed.

1.4 Thesis overview

Chapter 2: Active Network Management

An overview of Active Network Management is presented. The regulatory environment and technical challenges which allowed ANM to grow is discussed.

Chapter 3: Design & Development of Test Environment

The requirements for testing of ANM system are discussed. Other work in the area of co-simulation is explored.

Chapter 4: Demonstration and Case Studies of Test Environment

Chapter 4 presents four case studies giving an proof of concept test environment. This chapter shows how different power systems problems can be represented and how communications emulation can be part of the testing platform.

Chapter 5: Discussion of limitations and future opportunities for further research

This chapter discusses the potential and future uses of the testing platform. Enhancements and future developments are presented.

Appendix: A – NS-3 Point to Point Link Model

1.5 Publications

The following publications resulted from the work presented in this thesis:

- IEEE Innovative Smart Grid Technologies Europe 2013, “The Development of

an Active Network Management test bed using Communications Emulation”,
October 2013

- Congrès International des Réseaux Electriques de Distribution (CIRED),
“Development of a test-bed for active network management”, June 2013

The work in this thesis was presented at an invited CIRED round table panel titled
“Joint simulation of cyber infrastructure and power system for smart grid planning
and operation studies.” The session was chaired by Roger Dugan, Senior Technical
Executive, Electric Power Research Institute (EPRI).

2 Active Network Management

2.1 Introduction

This chapter presents the conditions in which Active Network Management (ANM) was able to grow. The current infrastructure of the power system and the challenges it will face in the coming years will be discussed. Regulatory incentives which encouraged Distribution Network Operators (DNOs) to investigate to new methods and technologies will be detailed.

Following this, the chapter will go on to explore the high level problems which a power network will typically face by introducing Distributed Generation (DG), as well as giving a review on trials and research in the area of ANM.

2.2 Background on the grid

Traditionally, the electricity network operated in a manner whereby electricity was generated in bulk, typically from a combustible fossil fuel source or nuclear fission. Topologically, an interconnected high voltage transmission network connects generation to distribution networks. In the United Kingdom, transmission voltage is considered to be 400kV, 275kV and 132kV (although in England 132kV is considered to be distribution.) Through transformers these voltages are stepped down to feed power to distribution networks at voltages of 33kV and 11kV until power is consumed

at its point of use at 415V and 230V, 3 phase and single phase respectively.

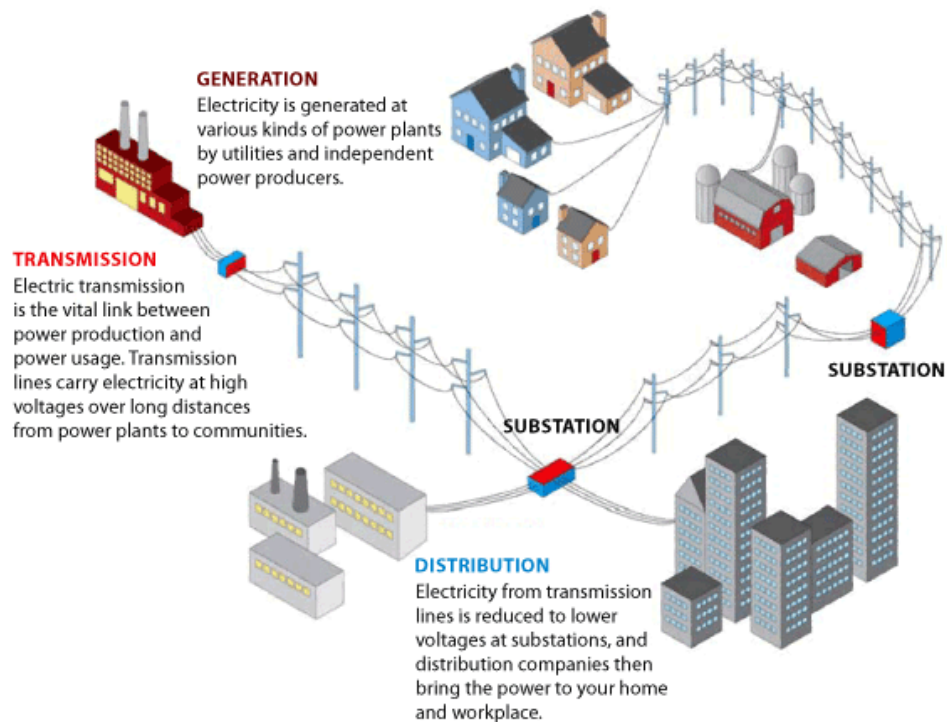

Figure 1 Structure of Electricity Network¹

The distribution network was designed to operate in a passive manner with voltage levels being controlled by fixed and on-load tap changers transformers. Monitoring levels are minimal and visibility of network conditions is largely unknown. A customer interruption may go unnoticed until the customer contacts their DNO. Constraints are dealt with at design stage: a conservative overhead is allowed to ensure the current on a line does not exceed its thermal rating, and voltage is regulated in such a way that the maximum drop over a given line should not breach the statutory or operational limits.

¹ Source: U.S. Department of Energy. "Benefits of Using Mobile Transformers and Mobile Substations for Rapidly Restoring

Efforts to secure supply of electricity and reduce the consumption of fossil fuels have brought about a change in the way electricity is generated and distributed. Economic and political drivers have led to greater levels of DG. DG is a term which is used to refer to a variety of energy sources connected to the distribution network. For the purposes of this thesis, the term DG will primarily be used to refer to embedded generation, typically making use of wind as the energy source for its prime mover.

2.3 Enablers

In recent years the Office for Gas and Electricity Markets (Ofgem) has, through a variety of mechanisms, provided the incentive for innovative technologies to be trialled to help address the challenges presented by the introduction of DG. By removing the financial barrier and rewarding those who successfully demonstrate innovation, DNO's were encouraged to invest in Research and Development. Innovation Funding Incentive (IFI) [9] grants was introduced to incentivise DNO's to invest in the research on an open platform to share learning from trials.

During Distribution Price Control Period 4 (DPCR4), between 2005-2010, Ofgem set up Registered Power Zones (RPZs) to provide funding for connecting DG onto distribution networks. RPZs were designed to provide another platform for developing cost effective and timely methods of connecting and operating DG.

The following price control period brought with it the advent of the Low Carbon

Networks Fund (LCNF)[10] which provided a pot of £500m for DNOs to sponsor projects that addresses and learns the challenges of developing a grid which can securely support energy from low carbon sources. The fund is split into Tier 1 and Tier 2 projects; Tier 1 being small scale projects to enable DNO's to recover some funding that has gone into R&D, whereas Tier 2 projects consist of an annual pot of £64million for DNO's to competitively bid for. Projects aim to remove some of the technical and commercial challenges of deploying innovative solutions. For instance, UK Power Network's (UKPN) Flexible Plug & Play Low Carbon Networks [11] aims to explore how IEC 61850 can be used to connect generation and integrate the control with other intelligent devices on the network. DNO's are further incentivised by a discretionary award to projects deemed to be successful in demonstrating innovation and benefit to the customer.

The next price control period will run between 2015-2023. Revenues = Incentives + Innovation + Outputs (RIIO) [12] is designed to encourage network operators to use new technologies on their network to ensure reliable operation and continuing to add low carbon generation, whilst doing so in a financially efficient manner. Each network operator has to provide an investment and innovation plan to OFGEM for approval, outlining the technologies it intends to adopt or trial in the coming period. Active Network Management is anticipated to be part of the 'Business as Usual' operation for many network operators according to their business plan, following a number of successful trials.

2.4 Why DG presents challenges

An amalgamation of technical, political and economic drivers have presented an opportunity for 'smart grid' technologies to be trialled and commercialised. The term smart grid is defined by the Energy Network Strategy Group [13] as:

“...part of an electricity system which can intelligently integrate the actions of all users connected to it – generators, consumers and those that do both – in order to efficiently deliver sustainable, economic and secure electricity supplies.”

The development in recent years of DG technologies has brought with it a host of challenges. Renewable energy resources tend to be located in rural areas of the United Kingdom, thus the infrastructure is typically a radial distribution networks and not previously designed to support the increased or reverse power flows. Therefore the network faces challenges in the form of voltage step [14], voltage rise [15] and power flow constraints [16]. Under certain conditions – a circuit fault or a combination of loading and generation conditions – DG may cause the voltage on a bus to breach a design or statutory limit. This presents a number of technical barriers for connecting new generators.

Network reinforcements in the traditional sense of replacing lines and upgrading switch gear can present an economic barrier to developers attempting to connect to the network. Furthermore, the time to connect may be prolonged to allow for network reinforcements. To better facilitate DG connections to the network, novel

methods of control have been developed to actively manage it under the prevailing conditions.

2.5 What is ANM

ANM presents a technically and commercially viable alternative to traditional reinforcements. To the authors knowledge no formal definition of ANM has been presented, although ANM can typically be characterised by autonomous control of intelligent devices in response to real time monitoring over a geographical region by making use of modern communications infrastructure and distributed computing.

The term ANM may pertain to a number of control techniques including but not limited to:

- Active or Reactive Power Flow Management;
- Voltage Control;
- Load & Generation Dispatch;
- Increased visibility of network conditions/ State Estimation; and
- Automatic Network Restoration.

The particulars of each algorithm is out of scope for this thesis, however a brief description of each are given.

2.5.1 Power Flow Management

Power Flow Management, as implemented by Smarter Grid Solutions (SGS), makes

use of real-time deterministic control methods to fully utilize the existing capacity. By actively controlling generation in response to prevailing conditions, constraints can be actively managed by monitoring lines and issuing controls to generators, allowing the power flow to operate closer to the thermal rating of a line, currently unutilized due to conservative planning, and thus deferring or postponing the requirement for line replacements or switchgear upgrading.

2.5.2 Voltage Control

Voltage control is a broad term which can pertain to a number of different research topics. For the purposes of this thesis, voltage control is designed to maintain voltage on the grid within limits in response to problems such as voltage rise and voltage step. Voltage control, regulates in real time of the amount of real or reactive power produced or consumed by multiple generators, loads, storage and the operating point of other grid devices, such as tap-changing transformers and reactive-compensation devices. Voltage limits on the grid can limit the scope for connection of new devices and low carbon technologies. Voltage control is presented as a method to connects more renewable generators and low carbon technologies to grids within statutory voltage limits works independently of, or in coordination with, existing voltage control equipment on the grid, minimises reactive power flows within the voltage limits of the grid and avoids or defers the need to reinforce the grid.

2.5.3 Load & Generation Dispatch

The concept of load and generation dispatch is one which exploits the probabilistic

nature of energy generation and consumption. Proposed are various methods of 'balancing' the network to remove the peaks and troughs seen at times during the day, coinciding with the populations predictable living habits. Energy storage is charged during times of low load and discharged to feed the grid during times of high load. The Northern Isles New Energy Solutions is a trial on Shetland [17] which uses immersion heaters to provide a load during times of high generation. By converting excess energy to thermal heat, this should reduce the peak from when a consumer would typically use their device. Theoretically this will remove a portion of the demand from other generators, and therefore reduce the peak output required.

2.5.4 State Estimation

Increased visibility of the network would allow for a more tightly control system, however this would require an increasing number of telemetry devices. An alternative to increasing the number of transducers on the network is Distribution State Estimate, as presented by in [18]. Linear programming methods presented have shown that the visibility of network conditions can be calculated on short time scales, depending on computation capacity, with the errors being calculated and bad or erroneous data being detected and removed from the calculations. Trials are currently on-going, but assuming these are successful, the measurements derived can be used as inputs to the previously detailed methods.

2.6 Existing ANM Projects

2.6.1 Orkney

This research is consequential of the work that led to the Orkney RPZ conducted by SSE and University of Strathclyde. The Orkney test bed was the ideal location for trials of Active Power Flow Management. Orkney is an island off the north coast of Scotland which, due to its geography, is an ideal location for wind generation. Under traditional planning rules the sub-sea interconnectors connecting the network to the mainland was considered constrained. As the network was already considered to be at its maximum capacity, alternative methods were trialled resulting in the introduction of a further 20MW of generation. The methods for doing so are detailed by [19]. Measurement points gathered data from the subsea interconnectors and controlled generation in response to the prevailing conditions, curtailing them to a calculated set point that would prevent a breach in the thermal limit of the line. Commercially the generators were given a ‘non-firm’ connection. Real-time deterministic control system was implemented to introduce ‘New Non-Firm Generation’ which in the event of a constraint on a branch was then curtailed. The commercial arrangements were to use the “Last-in First-off” model [20], curtailing generation according to which was the historically latest connection.

2.6.2 GenAVC

The authors of [21] paper proposed that through the use of State Estimation and Voltage control, an additional 50% of Generation can be accommodate, previously considered not possible due to the voltage rise limitations. Similar to the Orkney trial,

the region used to trial GenAVC is a RPZ set up between EdF Energy and Econnect. GenAVC regulates the voltage on an 11kV circuit by issuing set points to Automatic Voltage Controllers in response to real-time network conditions to allow for a landfill gas generator to increase its rating from 2MW to 3MW.

2.6.3 AuRA-NMS

The Autonomous Regional Active Network Management System (AuRA-NMS) [22][23][24] presented an advanced Distribution Management System (DMS) to address a number of ANM solutions:

- Power Flow Management;
- Voltage Control;
- Automatic Restoration.

AuRA-NMS aims to present a generic solution that can be applied to a variety of network topologies with different constraints, as opposed to the bespoke nature of other projects. The project between ABB and a number of university partners investigated the use of Multi-Agent System architecture and a number of control techniques to differing address network issues. AuRA-NMS took the approach of using an arbitration agent as a way of deciding on what agent should be prioritised when actions are proposed.

Moreover, the IEC 61850 data model was used as a way of reaching a common solution that can be deployed in an expansible fashion. Case studies on both radial and interconnected networks run on distributed systems with real-time simulation illustrate how the approach can be applied to different networks.

2.6.4 DG DemoNet (Siemens/ATI)

An on-going project which has a number of parallels with this thesis is the DG DemoNet [25] [26] project which explores implementing co-ordinated voltage optimisation between a number of DG's on a stretch of network in Austria. The similarities to this thesis lie in the methods of real-time simulation as further detailed in the next chapter. Research conducted by the Austrian Institute of Technology, used DIgSILENT PowerFactory's RMS capability interfaced by an OLE (Object Linking Embedding) for Process Control (OPC) communications client. This thesis will go on to describe how the same software is exploited in a similar fashion, making use of the real-time aspect of DIgSILENT PowerFactory.

The authors of the DG DemoNet trial set up controllers to interface to PowerFactory with 4 operational modes depending on objectives:

- 'Upper limit' – to save distribution losses;
- 'Lower limit' – to lower limit to decrease active power consumption;
- 'Centred' – central between upper and lower limit to increase safety margin for loads and generation;
- 'Minimum tapping' – minimise the number of transformer tap changes.

Following simulation, three DGs with a nominal active power of between 600kW and 1MW used Reactive Power Control to optimise network voltage. Early experiences have indicated that accurate simulation is essential, and even then there are

discrepancies between simulated and field trial results. Other takeaways from the studies have indicated that delays in communications and measurement processing should be accounted for in the design stage to manage the control loop to avoid hunting and reactive power oscillations.

2.7 Commercial Offerings

There are a limited number of commercial offerings which offer the wide area management of network assets to resolve grid constraints through real-time management. Smarter Grid Solutions were commercialised in 2008 from the intellectual property developed in the aforementioned Orkney project. It has offered its services to a number of DNO's and has been involved in a number of Low Carbon Network Fund projects. Since inception, Smarter Grid Solutions have adhered the philosophy to ensuring solutions are delivered on a hard real-time deterministic platform. This guarantees actions are predictable and will operate within a given time margin.

At the time of writing, there are no like for like product comparisons. This chapter referenced academic trials which have similar goals, however it is unclear if their hardware and software architecture is comparable. Commercially a small number of companies offer to solve similar power systems problems, however typically are achieved through existing Supervisory Control and Data Acquisition (SCADA) systems.

This thesis has been written in collaboration with Smarter Grid Solutions and University of Strathclyde as part of a Knowledge Transfer Partnership, and makes use

of their platform and applications in chapter 4 when running end-to-end tests as part of the proof of concept.

2.8 Chapter Summary

This chapter introduced the concept of Active Network Management. To understand the reasons for using Active Network Management, the current infrastructure was presented and the challenge of adding DG was explored. The regulatory framework which has incentivised DNO's was detailed to show the environment under which innovative technologies have been allowed to prosper in the United Kingdom.

Moreover the technical details of what can be achieved with Active Network Management were discussed, including Power Flow Management, Voltage Control, Load and Generation Dispatch and Distribution State Estimation. A literature review of the trials, research and commercial offerings in the area of Active Network Management was presented.

3 Test Environment

3.1 Introduction

This chapter will outline why rigorous testing is required and its intended impact on the development of solutions. The benefits of end-to-end testing early in the development cycle will be discussed. Following that, this chapter will explore existing testing frameworks and their relevance to this body of work. This chapter will then go on to discuss some of the software components which may be used in the framework being developed.

3.2 Applications

The test bed has been developed primarily to test power flow and voltage management applications. Power flow and voltage management applications monitor constraint points (e.g. a line with current flows which is starting to encroach on its thermal rating or a bus bar where the voltage is approaching the design limit) on the network. Upon a breach of the constraint, the application calculates a level of real and reactive power which if adhered to will bring the network back to an acceptable state. These applications heavily depend on timers, thus simulating the temporal response in real time can be used to highlight areas where thought experiment becomes too complex due to the ever changing nature of the states of a central and distributed control system as well as the measurements on the network and communications link status.

3.3 Methodology

The project was conducted following the methodology outlined in Figure 2. The key elements of the applied methodology are explained in the following sections.

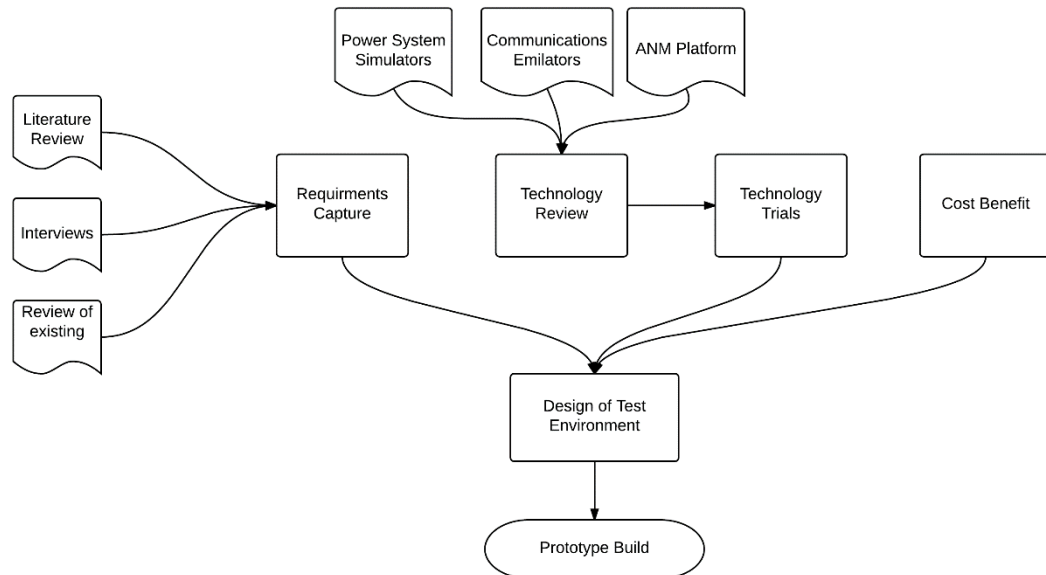

Figure 2 Methodology

3.3.1 Requirements Capture

The requirements capture was conducted over a number of months to ensure that the design of the test environment was appropriate for the products being tested, now and in the future. To do this an understanding of the existing testing infrastructure had to be obtained. Staff interviews and a review of testing practises were particularly informative in highlighting areas for improvement. An internal Technology Roadmap was key to understanding future requirements and products, indicating scale and functionality were both key areas for testing and development. A review of existing test environments is conducted later in this chapter.

3.3.2 Technology Review and Trials

To begin assessing technologies a review of existing technologies (primarily focusing on technical merit) was conducted and assessed. Subsequently, trials of individual components were conducted making use of trial licenses and available equipment in University of Strathclyde's existing test environment. This review is documented later in this chapter.

3.3.3 Cost Benefit Analysis

To enable the preparation of the business case for the purchase of software licenses and hardware, a cost-benefit was conducted. The components of each technology were assessed next to the following criteria:

1. Does this increase time to market?
2. Does this allow platform or algorithmic testing not previously capable?
3. Is this representative of deployed system?
4. Financial viability?

From the outset it was evident which were financially appropriate or not therefore this has not been formally documented.

3.3.4 Design

The design, as shown in chapter 4, takes into account the technical merit, costs and is benchmarked against the defined requirements. Following approval of the business

case presented, the appropriate components were purchased, assembled and tested. The next chapter provides a detailed outline of the build and test.

3.4 Changing ANM Environment

Generally, testing of Active Network Management (ANM) systems to date has been satisfied through thought experiment and simplistic modelling to simulate the signals of secondary measurement equipment under the assumption of perfect communications (i.e. no latency or bandwidth restrictions) prior to open loop testing. Signals are modified manually or using scripts and the response is manually verified to ensure the control system as a whole behaves in the anticipated manner. Thus far, for the network topologies being controlled, this approach has been successful with minor amendments being made following learning from field trials, particularly due to delays caused by communications channels.

However, as Active Network Management systems develop in scale and complexity, this approach is no longer sufficient due to the interconnected nature of the system variables. Advancements are required to give a more detailed representation of the entire system. The Smart Grid Architecture Model [27] as defined by Comité Européen de Normalisation Électrotechnique (CENELEC), shown in Figure 3, has been developed to provide a framework for displaying the various domains in a layered architecture to stakeholders engaged with a modern power systems network.

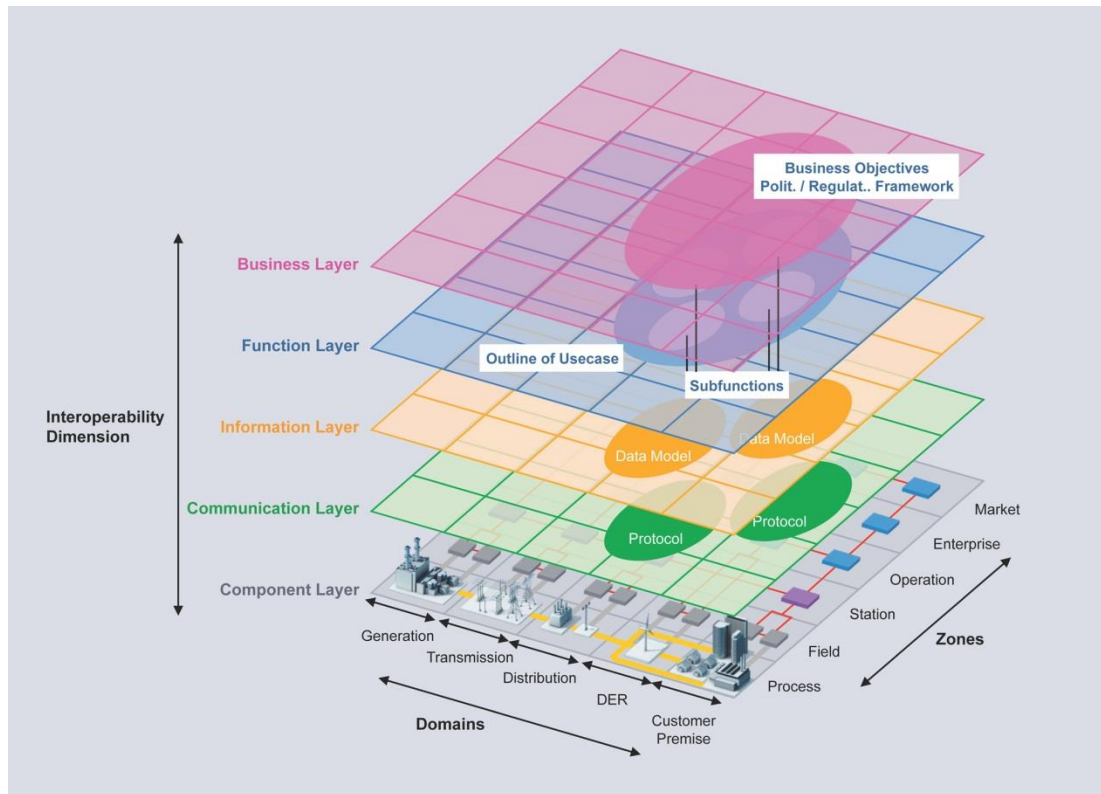

Figure 3. CENELEC Smart Grid Architecture Model [1]

The convergence of Information Technology, Operational Technology, Communications Infrastructure and Control Systems pave the way for increased visibility and governance of the real-time state of the power systems network. To fully realise the aspirations of ANM it can be argued that to understand the entire system, simulations and models should be represented in a combined environment which represents the temporal response for both the power system being controlled and communications platform used.

The provision of a combined environment allows for a multi-perspective analysis of the various domains. Active Network Management aims to solve one or multiple

power systems problems, primarily (although not exclusively) power flow or voltage constraints. Achieving such goals can be attained through the control of generation, load, transformers and other network devices which can influence the system variables. By the nature of data transfer, a communications network will inevitably be required to provide a medium to do so. This introduces a paradigm shift, where now, not only faults on the power systems network must be considered, but intermittency and delays of communications network also have ramifications (as has been seen on Orkney). Figure 4, below, demonstrates that when key communications channels are lost, the output of the generators are directly affected, thus has a direct impact on the capacity factor.

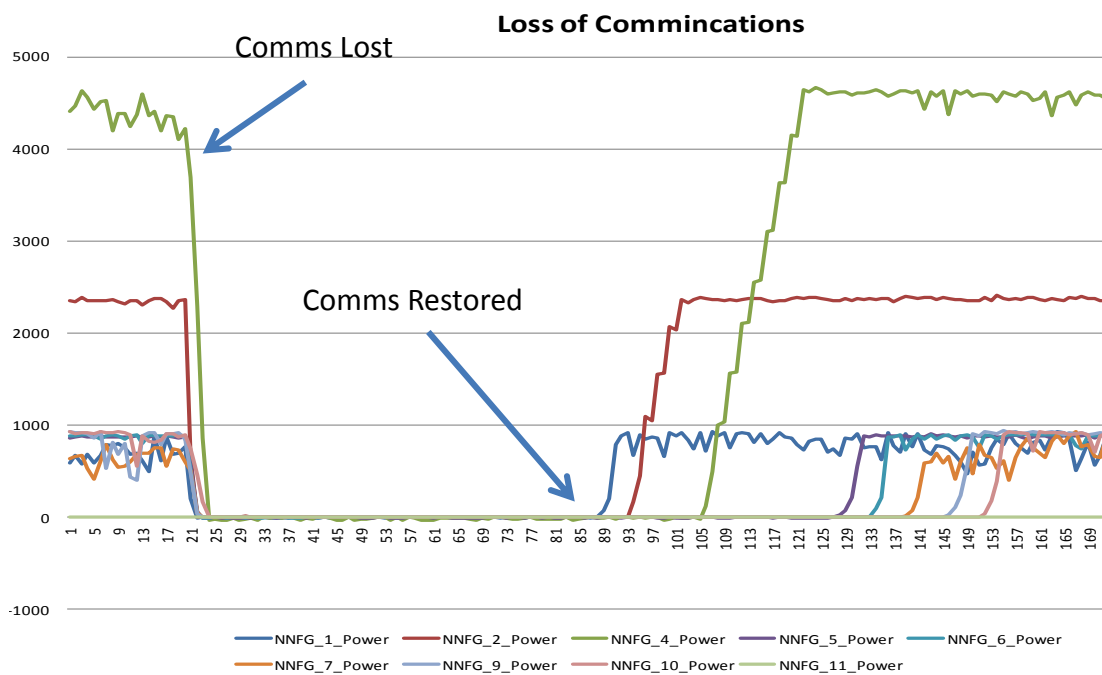

Figure 4. Communications Failure

An understanding of what is required by a test environment will be presented in the

next section of this chapter. The chapter will then go explore the advances in the simulation of power systems and communications, then finally present the architecture of a test environment which aims to address the requirements for testing the hardware and software elements of an ANM system.

3.5 Objectives/Requirements

The primary objective of testing an industrial control system which operates critical national infrastructure is to ensure a robust and reliable system operates in a manner, ensuring the safety and security of all stakeholders. Adequate testing is therefore essential. Failures, particularly at transmission level voltages, could result in customer outages and consequently penalties from the regulator, therefore before widespread closed loop control of ANM is implemented, rigorous testing must be conducted.

Financially, early testing can be rewarding, as [28] suggests that discovering faults early in the design process as opposed to field trials can result in savings by a factor of 100. Time saved by removing failures before production will also result in a faster time to adoption. One method of testing can be achieved through mathematical modelling and simulating a system.

Modelling is generally defined as the mathematical representation or abstraction of a real world system or object. Under a given set of conditions the model should, to an observer, reflect the expected behaviour of a given system and provide insight to the interactions with other systems.

For clarity, simulation in this document pertains to duplicating the behaviour of a system in the time domain in a way that appears to the external observer as representative of the behaviour of said system. Although similar to simulation, emulation is subtly different; emulation pertains to the duplication of the inner workings of a system. For example, communications emulation in this instance aims to use the same software kernels to generate packets and subject messages to the same layers of the Open Systems Interconnection (OSI) model [29] the device being emulated would use.

Testing can be an iterative process which is executed throughout the design and build process. Software development is often completed using the Test Driven Development methodology [30], whereby tests are written for each method before it is written with the aim of creating well-structured, readable and reusable code. Moreover simple soak testing of communications links are also tested to ensure paths are visible and support the volume of traffic anticipated. The focus of this thesis however will be on integration and end-to-end testing, as sowing the fabric together to ensure each component of the entire system work in synergy is where the novelty of this work lies.

Integration of an end-to-end system can be the most problematic step in the life-cycle of a software project, as it typically does not occur to later in the development process. According to the US Department of Defence '50% to 60% of resource is spent on testing, and of that 70% is spent on integration testing' [31].

As deployments of actively managed networks are transitioning from the early adoption stage to widespread use, formalised testing frameworks are still in their infancy. The National Institute for Standards and Technology (NIST) formed the Smart Grid Interoperability Panel (SGIP) which has a subgroup Smart Grid Testing and Certification Committee (SGTCC) who formed a working group dedicated to end-to-end testing [32].

The aspiration of this thesis is to present a testbed which enables repeatable and extensible testing on a flexible platform which adequately represents the power systems and communications platform to a level of 'correctness' not previously exhibited in testing. Typical type of tests the proposed testing platform should address includes functional, soak testing and response under failure conditions. It is desirable to ensure that a change in hardware and/or software does not result in the design principles not being met. Soak testing can instil confidence of the system's ability to perform as expected under voluminous traffic conditions. An important aspect of testing is to ensure the system can respond correctly and recover from a variety of failures. A further requirement of an expandable testbed is, where possible, utilise automated tests. This removes the scope for human error and ensures consistency when testing.

The aim of this thesis to capture the environment in which the system will be deployed to a level of accuracy greater than previously exhibited. To do so, power systems simulation packages which could be used to represent the dynamics of different devices were investigated. Key to this was establishing a method in which

external control could be used to interface to the model in real-time. Furthermore, it was desirable to include communications emulation to ensure the temporal response of intertwined controllers behaved as expected when different communications platforms were used. The academic community has coined the term “co-simulation” to describe the use of 2 or more simulation packages in tandem, which in this instance would be the simulation or emulation of the power systems and communications platform. Significant work has been completed in this field to date.

3.6 Research on Co-Simulation

The pervasive nature of communications systems and their impact on Power Systems have been document [33]. Efforts to include and simulate the effects feature in a plethora of literature, particularly in recent years as the adoption of said technologies increase. Simulating real time communications systems in other domains such as avionics date back to the 1980s-90s [34]. Although suggested in much of the literature, few researchers have presented a framework which would allow them to achieve real-time simulation.

In recent years a number of a research projects have made efforts at combining both power systems and communications network simulations with the goal of assessing the end-to-end system. Early work from 2003 shows the Electric Power Communications Synchronizing Simulator (EPOCHS) [35] project combining PSCAD/EMTDC simulator and Network Simulator 2 (NS-2) communication simulators with an independent mediator to ensure seamless synchronisation between the simulators. From the outset, the authors found that ‘the most obvious combinations

of control policies with Transport Communication Protocol (TCP) could malfunction under conditions that are quite likely to occur in a power system network.’ Also recognised is the challenge of how independent simulation engines interact, as typically the original design did not accommodate interoperability.

Researchers at Virginia Tech present a comprehensive review of the various projects that integrated power and communication network simulators, succinctly describing the tools used, their synchronization methods, scalability and if they have the capability of operating in real-time mode [36]. From the 9 projects described there exists commonality in a number as nearly all typically use NS-2 or OPNET as their method of simulating communications. Various flavours of power systems simulators are used depending on the target application. The Global Event Driven Co-Simulation (GECO) framework implemented by the researchers made use of NS-2 and PSLF primarily for the assessment of different protection methods and subsequently to assess cyber security threats on state estimators using PMU data [37].

The authors of [38] fully recognise the impact of communications networks have on modern power systems, although focus mainly on Medium Voltage DC systems such as naval ships. In [39] a framework for integrating a communications simulation package, OPNET, and a power systems package Virtual Test Bed (VTB) is presented, although again real-time simulation is considered to be future work.

The DG DemoNet project, at the Austrian Institute of Technology, has published a number of papers detailing their trials and tribulations in developing voltage control

techniques and the learnings from their subsequent trials. As a means of validating their techniques they have used some of the same features of PowerFactory as this thesis will describe. In [40] they have recognised the potential a co-simulation demonstration platform would have as a means of training students and professionals to aid the understanding of the end-to-end system and the coupling between domains.

3.7 Overview of Software packages

3.7.1 Communications Emulation

3.7.1.1 NS-3

Decisions on the communications platform and architecture used will be made on the basis of a number of factors: current infrastructure, location, criticality of operation, ease of operation, cost and availability. To inform these decisions, it is beneficial to quantify the technical merits of each platform while considering the cost. A communications failure during the aforementioned ANM solutions result in localised control curtailing generation to a predefined ‘failsafe’ position, therefore a robust platform is favourable as there is a direct impact on the capacity factor of a connected generator.

Communications emulation is proposed as a method to understand and assess each platform. A communications network simulator, NS-3 [41], was selected as a tool for implementing communications emulation due to its attention to realism. Moreover it provides a flexible and repeatable method for assessing the merits of a

communication system allowing for comparisons to be drawn between platforms, including the ability to emulate a failure of the communication network by dropping packets or delivering them out of sequence.

NS-3 is a discrete event simulator, primarily intended for research and teaching purpose. NS-3 has both emulation and simulation capabilities. It is open source licensed under GNU General Public License, being maintained by a growing community of software developers.

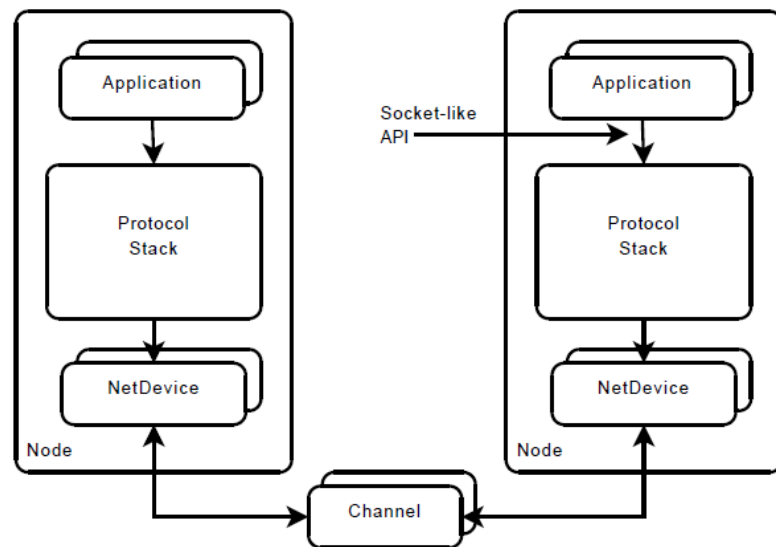

Figure 5. NS-3 Model Architecture

The architecture of NS-3 models, Figure 5 above, aims to present a realistic representation of a communications platform. Layers 2 to 7 of the Open System Interconnection (OSI) stack are highly detailed within a node. Layer 1, physical layer, is presented as a simplified channel model. A library of models is wrapped in C++ 'helpers' to build the topology. 'EmuDevice' model is used to encapsulate traffic at a

Network Interface Card (NIC), routed through the emulated network and transmitted at an egress point. Data Link models include Point-to-Point, Carrier Sense Multiple Access (CSMA) and Wi-Fi. Error models may be introduced to randomly drop packets or drop packets from the end of a queue in the event of a bottleneck or stochastically, therefore allowing for the effects of packet loss to be evaluated. Emulation mode makes use of a real-time scheduler which queues and sends packets at intervals defined by the network model, thus emulating the delay of a communications channel. The bounds of the test-bed are typically determined by the underlying physical attributes of the host(s), for instance the NS-3 user's manual states found that during testing there was an upper bound limit for TCP throughput, although it is expected this is due to the processing power of the platform being used [44].

Limitations on the scalability are present in the form of the capacity of the physical connection and computational power of the host [45]. Server traffic, CPU consumption and memory resources have been compared for emulated networks on a single machine and distributed machines. NS-3 uses single core processing and creates a new thread for each binding to a tap bridge host, thus has a linear relationship between the number of hosts and the resources consumed.

The authors of [46] have explored how the emulator clock may drift from the system clock when simulating a dense network as virtual machines consume much of the host resources, thus rendering the simulation inaccurate. It is not anticipated this would pose issues for the proposed test-bed, as the traffic being generated is by distributed hosts being interfaced by NICs as opposed to the virtual machines used in

the paper. It is essential to understand the limitations of the emulator moving forward and allow for an adequate framework to be built and establish boundaries on the validity. Not all technologies and protocols are modelled within the NS-3 API, although key characteristics can be extracted and applied to other models.

3.7.1.2 OPNET

OPNET Modeller is a commercially available discrete event simulator similar to NS-3 which has also been used extensively in research for the purposes of co-simulation. For example, the authors of [47] have used OPNET to investigate the effects delay have on the IEC 61850 protocol, and how different communications characteristics affect the behaviour. As previously detailed, the authors of [38][39] also use OPNET as their platform for representing communications. Communications emulation for testing power systems applications have been explored using OPNET in [42] [43].

3.7.1.3 Exata

Exata is commercially available software that has been used as a method of emulating communications. From the literature, Exata has been used to test military and health applications [48] [49], however research in the area of power systems is sparse. The set up and graphical user interface make it an appealing option for evaluation as it appears to simplify the task of routing machines and developing different models.

3.7.2 Power Systems Simulation

3.7.2.1 Quasi Steady State Simulator

IPSA is a load flow engine which calculates steady state conditions of a Power System. Using a Python scripting interface as a bridge between IPSA and an OPC Server, data

can be exchanged periodically. As IPSA is a steady state load flow engine, intermediate controllers have to be created manually in Python to simulate ramp rate response and tap changing delays, updating the IPSA model appropriately as the simulation progresses. The modelling process in IPSA is such that models can be created and modified in a relatively simple manner. The simulator displays only the steady state values of a system and thus does not allow the user to observe the dynamic response of a network.

3.7.2.2 DiGSILENT PowerFactory

The use of DiGSILENT for testing control algorithms has been explored by the authors of [50]. Running PowerFactory as an RMS Real-time simulation allows set points to be changed to observe the transient response caused by these changes. The architecture of the testing environment is similar to that proposed in the previous subsection, however, controllers are modelled within the PowerFactory environment and the simulator has a direct OPC link. The maximum number of buses within the simulation is dependent on the computational capacity of the host machine.

Pertinent data can be interfaced with a voltage management controller to actively manage network conditions. Figure 6 & Figure 7 demonstrate the step change response of a voltage set point being issued to an AVC, the resultant voltage output by a generator and the power generation profiles respectively. The transient response of active and reactive power can also be observed to demonstrate there are no issues relating to thermal or voltage constraints being breached as a result of a change in set point.

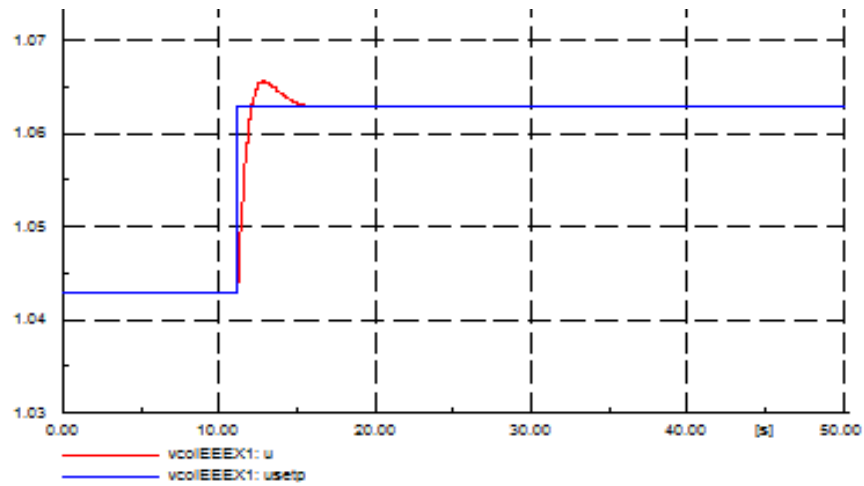

Figure 6. Voltage Profile

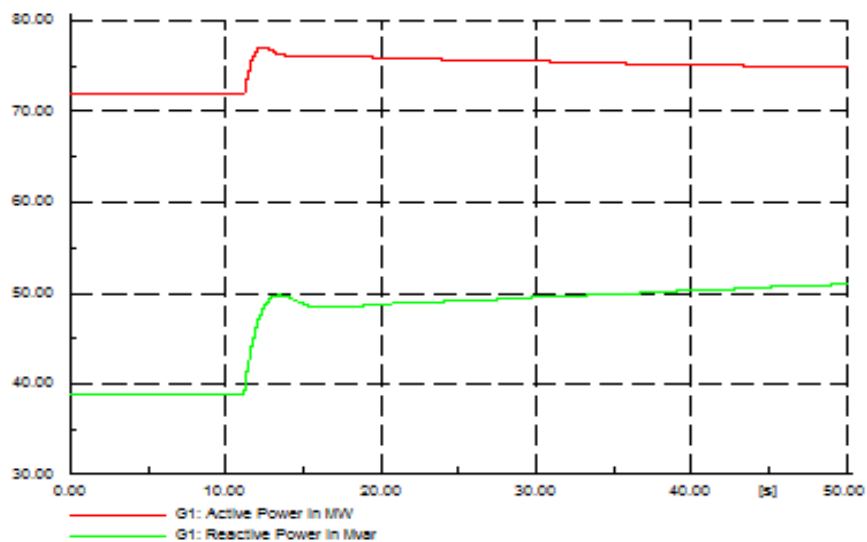

Figure 7. Active & Reactive Generation Profile

3.7.2.3 RTDS/ RSCAD

RSCAD is the modelling environment used to run simulations on the Real Time Digital Simulator© (RTDS). The modelling environment provides similar capability to that of PowerFactory, only at a higher granularity. Scalability is an issue (due to high cost of hardware) as there are a limited number of nodes per processing rack. To interface

with control algorithms the GTNET card of the RTDS has DNP3 and IEC 61850 GOOSE capabilities. The time resolution of this modelling set up is in the order of 50 μ s although simulating sub-cycle behaviour of the power system is typically not required to adequately represent the control of an ANM system. However, as solutions evolve simulations in this vein may be of greater interest.

Initial testing with the RTDS presented a number of limitations in the form of model availability and network scalability. A standardized model for a Double Fed Inverter Generator with active and reactive power control is not due to be published until 2015 (IEC 61400-25) so existing models (that did not have the capability to accept a set point) were modified models to change the reference current on the *i-axis* and *q-axis* of the generator as presented in [51], and thus the real and reactive power. IEEE standard synchronous generator, governor and Automatic Voltage Controller (AVC) models were used as alternative.

3.8 Software Selection

NS-3 is widely used in the academic community with a vast number of developers and supporters. Being open-source, it was an attractive option for developing a prototype. After review of the other software components and the potential benefit, it was decided NS-3 would be a suitable entry point for communications emulation.

DiGSILENT PowerFactory RMS simulation package was selected as the power systems simulation package for a number of reasons. Firstly, the library of models available and the environment for developing or modifying models were simple. The software

could be run on a Windows Operating System and had no exceptional resource requirement, as opposed to the dedicated hardware and software of an RTDS. The time step of 20ms is appropriate for the applications being tested. It is adequately resolute to capture the electrical and mechanical transient, but does not go down to the sub-cycle time steps that may be required for testing protection applications where RTDS would be more appropriate. Finally, the price point of PowerFactory made it an attractive option.

3.9 Generic testbed architecture

The architecture of the test environment can be somewhat amorphous. Due to its flexibility, it may manifest itself in a variety of forms of physical hardware or virtualised (i.e. running on a virtual machine.) This said, the end-to-end test environment simplifies to 4 high level blocks:

- Central Controller
- Communications Platform
- Local Controller(s)
- Controlled Device(s)

The construction of these blocks will ultimately look as shown in figure 8 below. Each of the following blocks is designed to be independent to allow for a modular architecture.



Figure 8 Generic High Level Architecture

The ‘Central Controller’ block in this instance will be Smarter Grid Solutions products, comprising of real-time control algorithms and standards based communication interfaces. This may be replaced by other controllers, providing the appropriate method for communicating data is available.

The ‘Communications Platform’ block will either be satisfied through direct connection to the same switch, thus assuming ‘perfect’ communications or by routing the traffic via a machine running NS-3 to introduce a bandwidth restriction or a delay, as discussed in the previous section.

The ‘Local Controller’ block is the controller that the ‘Central Controller’ will communicate to and would physically reside at the device being interfaced to. This may be an actual RTU or virtualised softPLC as can be seen in the first two case studies.

In this thesis the ‘Power Systems Simulation’ block will always be realised using

DIGSILENT PowerFactory as discussed in the previous section.

3.10 Chapter Summary

This chapter has 3 distinct themes. Firstly, an understanding of why testing is essential and what it would mean for ANM deployments was discussed, drawing parallels to other software programs operating critical infrastructure. High level requirements for a test environment were deduced.

Secondly, the chapter focused on similar research, of which there was plenty. Most had a flavour of power systems simulation and communications simulation, however none were able to simulate or emulate both which representing the real time dynamics of the system. Most used one of the commercially available software simulation packages to simulate the power network, and NS-2 or OPNET as their communication simulation or emulation package.

Thirdly, a description of each of the considered or trialed software packages is given. The rationale behind the software selection, taking into account the technical and commercial factors, has been given. Finally the architecture of a testing platform is presented which will be used to demonstrate a proof of concept in chapter 4.

4 Case Studies

4.1 Introduction

The previous chapter explored the tools, assessed the requirements and proposed an architecture for implementing the desired testing framework. This chapter presents practical examples of how the proposed flexible testing environment can be configured using various tools. Four case studies will be presented demonstrating a proof of concept. The first will demonstrate how the Principles of Access can be used in different configurations to manage a voltage constraint. The second demonstrates a large network model with a thermal constraint being resolved through the management of generators active power output. Another will demonstrate how the test environment can be used to test voltage control actions. The final case study will demonstrate the use of communications emulation. The challenges of executing the tests and the learning process will be documented.

As outlined in the previous chapter the architecture (figure 8) will consist of a central controller, communications emulator, local controller and power systems simulation package. The integration of these 4 elements provides a variety of challenges including ensuring real-time synchronisation, test execution and importantly the processing of results.

Defining the correct or optimal control actions for different power system problems under different constraints is an on-going research work. It is out with the scope of

this thesis to present the merits of different ANM methods. Ultimately there are a finite number of levers which can be used to control network conditions. This thesis aims to present a test environment which can allow the user to test these levers in a repeatable, systematic and flexible manner to prove or disprove their merits, whilst simulating the dynamic response of the power system. The case studies being presented intend on demonstrating these actions being on a power network in a real-time dynamic environment.

To interface to the power systems models, dynamic controllers that are available in the PowerFactory library had to be modified. Care had to be taken to preserve the behaviour of the models while using external controllers. This chapter will detail the changes and additions that were made to the controllers in PowerFactory.

The case studies are presented in a modular fashion to demonstrate the individual elements. Firstly, the focal point will be on the ability to represent different control actions on a power systems network. Communications emulation will be demonstrated at end of the chapter. In the power systems case studies, the communications platform is considered to have 'perfect' channels, in that the communications have clear paths and the volume of traffic being generated is well supported.

The communications protocols in this section is OPC for data in and out of PowerFactory, and either Modbus or IEC 61850 for communications between the central and distributed controller.

4.2 Case Study 1 – Principles of Access Test

4.2.1 Overview

This case study will show how the environment can be used to test a voltage control algorithm and how it can be achieved using various commercial arrangements known as Principles of Access (PoA). While it is understood that the profiles being used are manufactured to exercise the system under test, efforts have been made to use network models and scenarios which are applicable to Distribution Network Operators (DNOs). Line models and distances used are the parameters as modelled by a DNO. PoA are the contractual rules which govern the order of which controllable devices will be used to alleviate the given constraint. They are applicable to controlling both voltage and thermal constraints. There are a number of options in which the priority order can be determined:

- Last In First Out (LIFO)
- Shared Percentage
- Technical Best
- Greatest Carbon Benefit
- Market Based

To demonstrate the capability of an ANM system to adapt to different principles of access, an artificial scenario was modelled, consisting of three generators connected to a constrained busbar. A load profile was created to cause a breach in the upper voltage limit of the busbar, which then should be resolved by curtailing generators.

The same scenario was replayed a number of times, with a different PoA configured to observe the behaviour of the ANM system. The merits of the algorithms are not being assessed in this case study, nor are the PoAs.

The wind turbine models being used are controlled by the dynamic control models shown in Figure 9 & Figure 10. The following model shows the high level controller which is being used to govern generator output and reduce active power output to control frequency for a wind turbine with full inverter control.

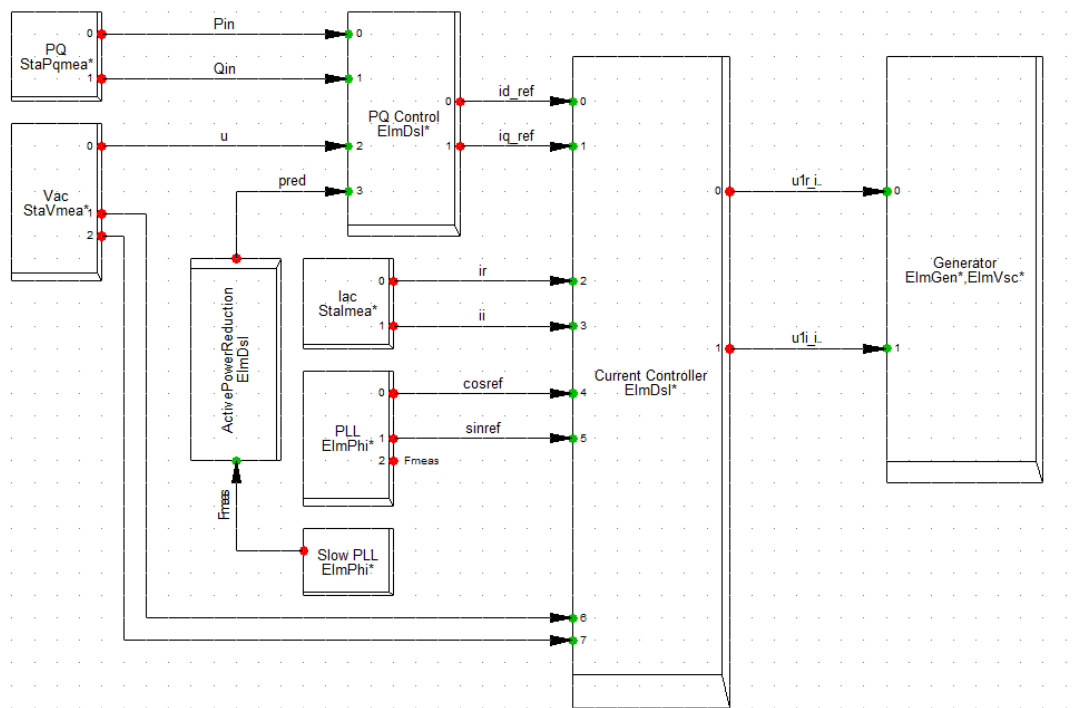

Figure 9 Dynamic Controller for DFIG

Figure 10 is the detailed model of the 'PQ Control' slot shown in Figure 9. By modifying the model to interface to the target power set point (Pref1 in Figure 10), control of the generators set point can be achieved through external interaction, in

this case from the RTU.

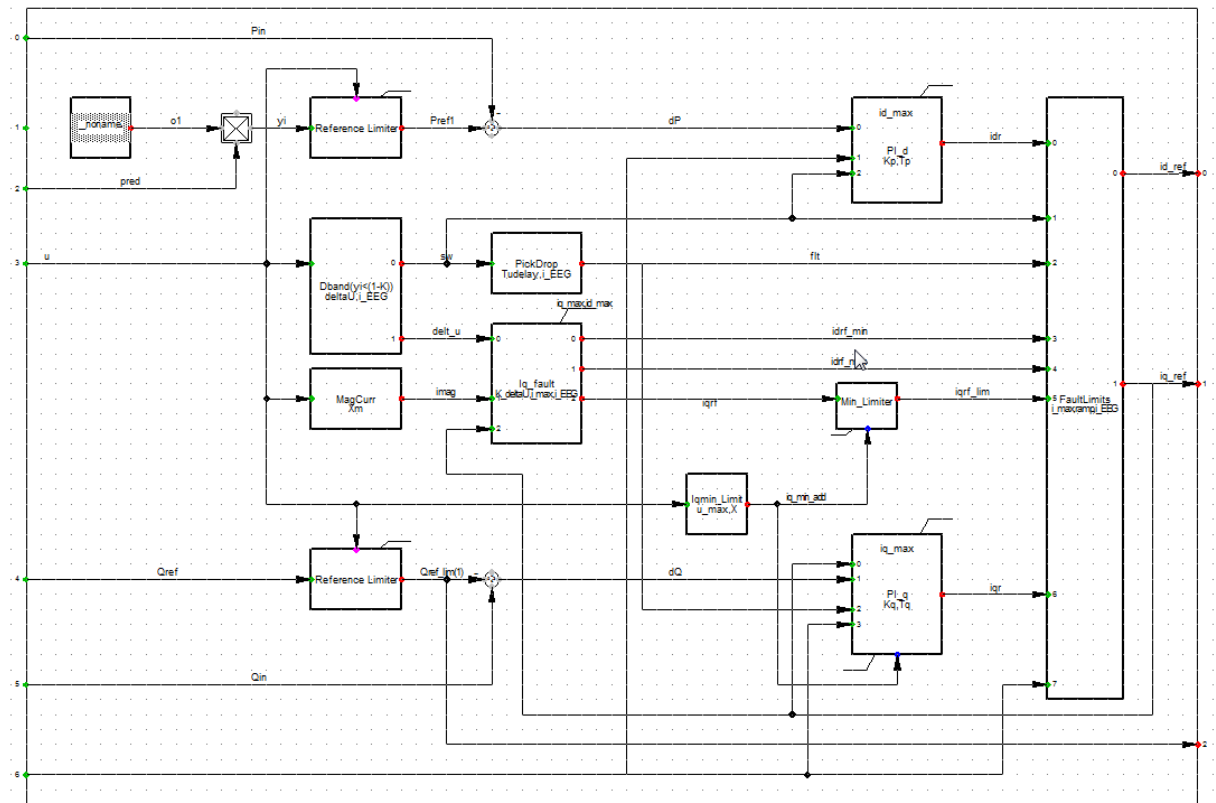

Figure 10. Active Power Controller for DFIG

4.2.2 Environment Configuration

The environment has been configured in the architecture as described below.

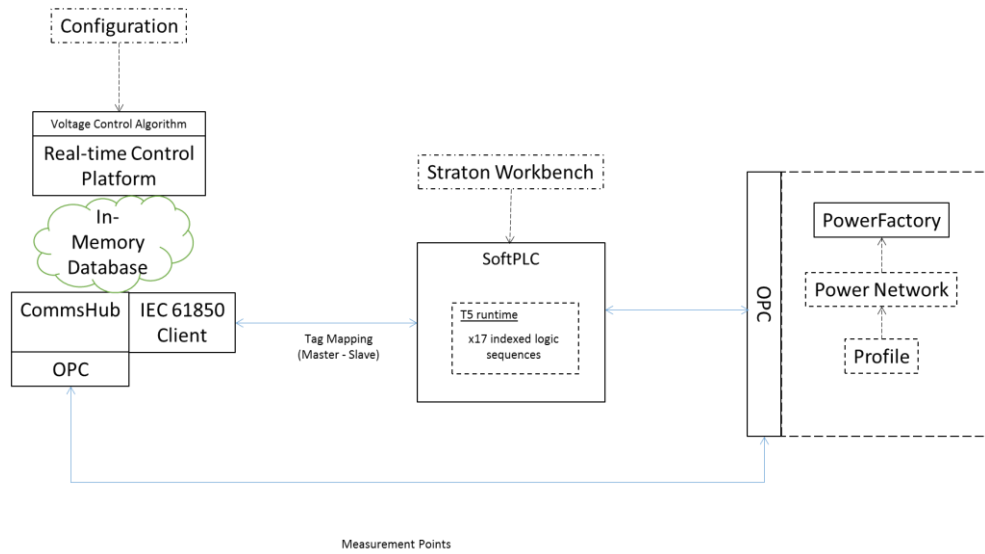

Figure 11. Test Environment Configuration for PoA Tests

The case study are the use of a softPLC (virtualised) as opposed to a (physical) Remote Terminal Unit (RTU). The softPLC uses the same run time software on a RTU, however is hosted on a virtual machine as opposed to the physical hardware of the RTU. This does not have an impact on the power systems simulation being conducted, although demonstrates the flexibility of the environment and adaptability to different stages of product development.

Table 1. ANM Hardware

Hardware	Role
HP Proliant server	Platform for hosting real-time algorithms
HP Proliant server	Platform for interfacing to network devices via standard protocols
SoftPLC	Local Controller
Lenovo E520 Laptop	Host for PowerFactory

These are programmed using IEC 61131 standard i.e. Structured Text. The SoftPLC has control over 4 generators and 4 circuit breakers as relationships have been set up for these generators against a single measurement point in the real-time controller configuration.

4.2.3 Network Model

Power Factory’s DigSILENT was used to model the 11kV feeder. The feeder has 3 DG units connected at its remote end, Busbar D.

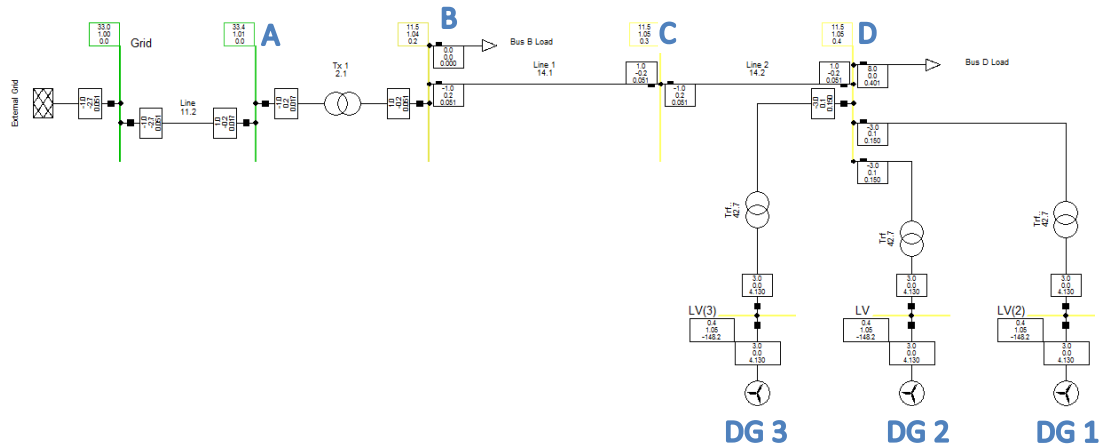

Figure 12. Network Model for POA Tests

The constraint location is at Busbar D. Load flows were run to identify the voltage level at Busbar D for the following:

- Starting conditions – with DG units at full rated output and the load at Busbar D at 8MW
- Intermediate conditions - with DG units at full rated output and the load at Busbar D reduced to 1MW
- Final conditions – with the DG units removed from service and load at Busbar D remaining at 1MW

The impact on the voltage at Busbar D with varying the load on the feeder and removing the DG units is recorded at the bottom of Table 2. This demonstrates that a solution exists and that the voltage controller has the ability to alleviate overvoltages through real power regulation of the DG units. The corresponding DigSILENT network models, for each stage, are shown below.

Table 2. Test Scenario 1

Initial Conditions		Intermediate Conditions		Final Conditions	
<i>Generator</i> <i>r</i>	<i>Output</i> <i>[MW]</i>	<i>Generator</i> <i>r</i>	<i>MW Output</i>	<i>Generator</i> <i>r</i>	<i>MW Output</i>
DG 1	3.6	DG 1	3.6	DG 1	0
DG 2	2.7	DG 2	2.7	DG 2	0
DG 3	2.7	DG 3	2.7	DG 3	0
<i>Load</i>	<i>Consumption</i> <i>[MW]</i>	<i>Load</i>	<i>MW Consumption</i> <i>n</i>	<i>Load</i>	<i>MW Consumption</i> <i>n</i>
Bus D Load	8	Bus D Load	1	Bus D Load	1
<i>OLTC</i>	<i>Tap Position</i>	<i>OLTC</i>	<i>Tap Position</i>	<i>OLTC</i>	<i>Tap Position</i>
Tx 1	-6 (LOCKED)	Tx 1	-6 (LOCKED)	Tx 1	-6 (LOCKED)
Vp.u. @ D = 1.05		Vp.u. @ D = 1.11		Vp.u. @ D = 1.03	

4.2.4 Simulation

The steady state analysis carried out in the previous section is used to compile a load profile, ranging from 8MW to 1MW and then back to up to 8MWs. The DG units start

at full rated output. The voltage profile at Busbar D, without any ANM control actions carried out, is presented in Figure 13.

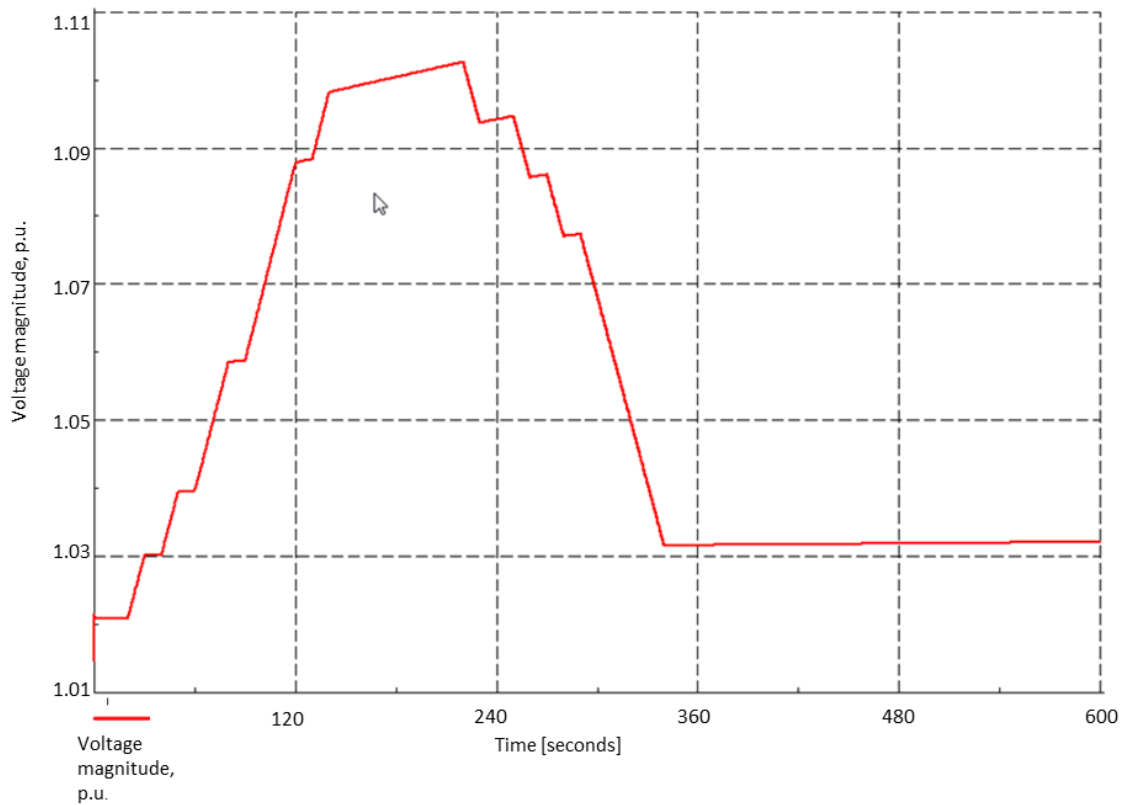

Figure 13. Voltage Levels at Busbar D without any ANM Control Actions.

For the purpose of the studies conducted below the following parameters were set within the voltage control algorithm:

- Upper Threshold – 11.66kV (+6%)
- Upper Release – 11.5kV (+4.5%)
- Target Voltage – 11.33kV (+3%)

4.2.5 Results

For each of the PoA combinations the following are shown:

- The voltage level at Busbar D with control actions implemented
- The set-points sent to each of the DG units
- The MW response for each of the DG units

4.2.6 Proof of PoA: LIFO

For the LIFO PoA the priority stack was as follows:

1. DG 3 (DG 3 having the highest priority)
2. DG 2
3. DG 1

Figure 14, below, presents the voltage at Busbar D. When the voltage exceeds the upper threshold (1.06p.u.) control actions are instructed to the DG units to drive the voltage towards the target voltage (1.03p.u.).

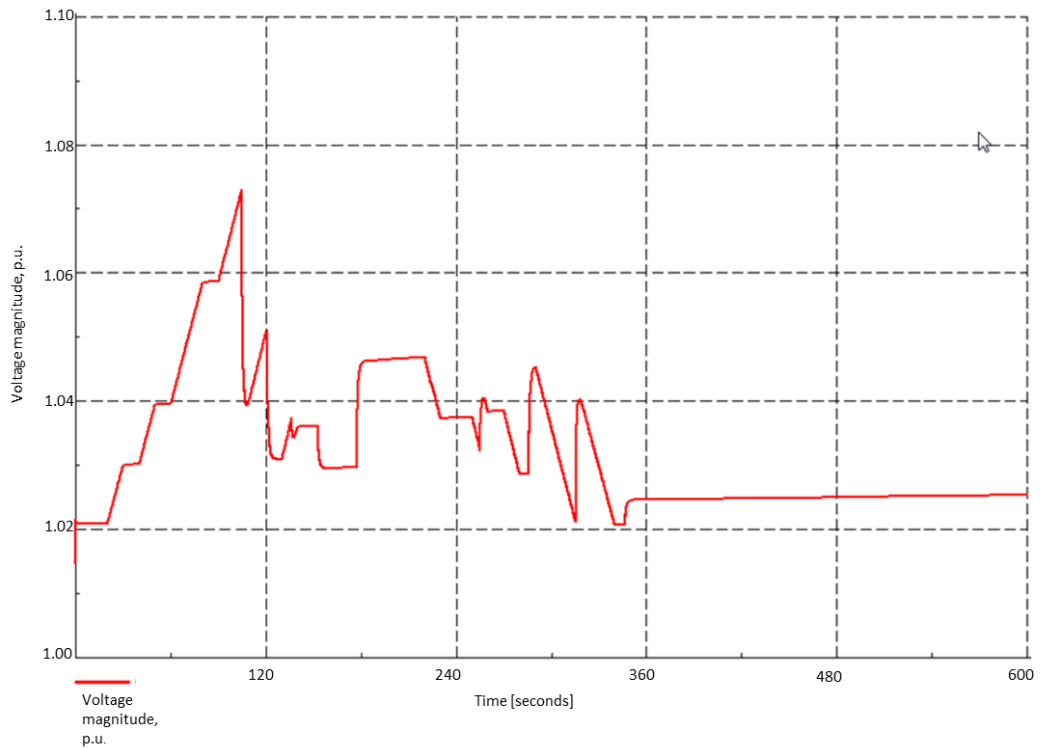

Figure 14. Voltage Levels at Busbar D with LIFO Ordered ANM Control Actions

In Figure 15, the order in which DG units are curtailed and released are as expected following the LIFO PoA. Initially on breach of the 1.06p.u. upper threshold DG 1 (red trace) and DG 2 (green trace) are issued set-points. As the voltage continues to rise further control actions are instructed. DG 2 is set to '0' and DG 3 is instructed to curtail its output. Only when the target voltage of 1.03p.u. is achieved (Figure 14) is a control signal issued to DG 3 (in line with the PoA) to relax its curtailment. This process is repeated, following on from DG 3, DG 2 is allowed to run uncurtailed followed by DG 1.

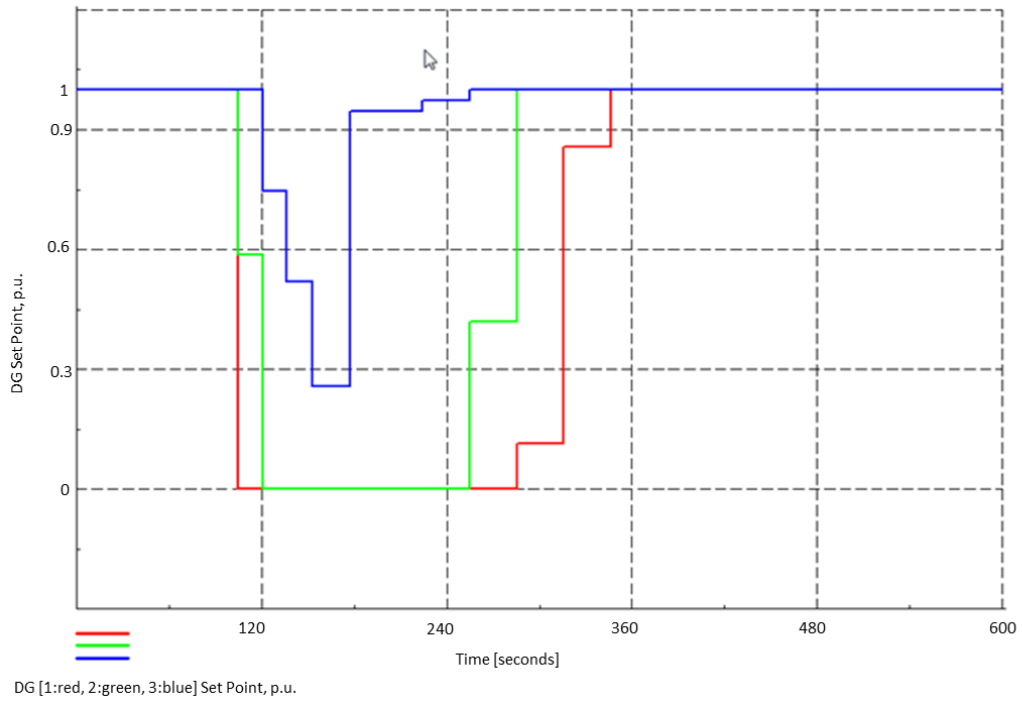

Figure 15. LIFO Generator Set-points Issued

The corresponding MW output of DG 1, DG 2 and DG 3 are shown in Figure 16 below.

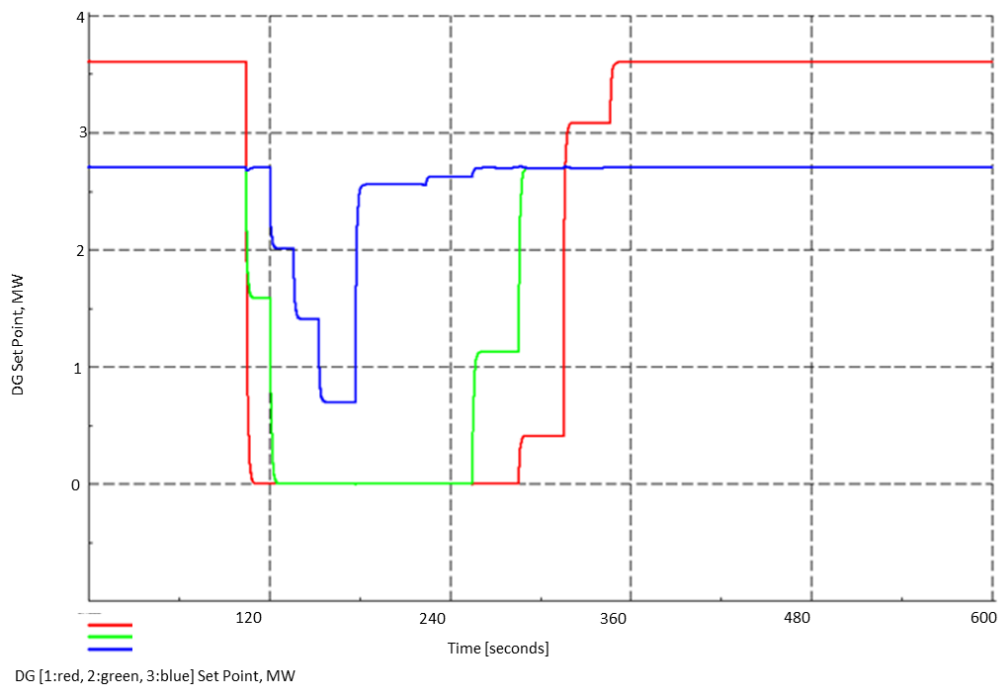

Figure 16. Corresponding MW output of DG Units following the LIFO PoA

4.2.7 Proof of PoA: Shared

For the Shared PoA the priority stack was arranged such that DG 1, DG 2 and DG 3 all had an equal priority assigned.

Figure 17, below, presents the voltage at Busbar D. When the voltage exceeds the upper threshold (1.06p.u.) control actions are instructed to the DG units to drive the voltage towards the target voltage (1.03p.u.).

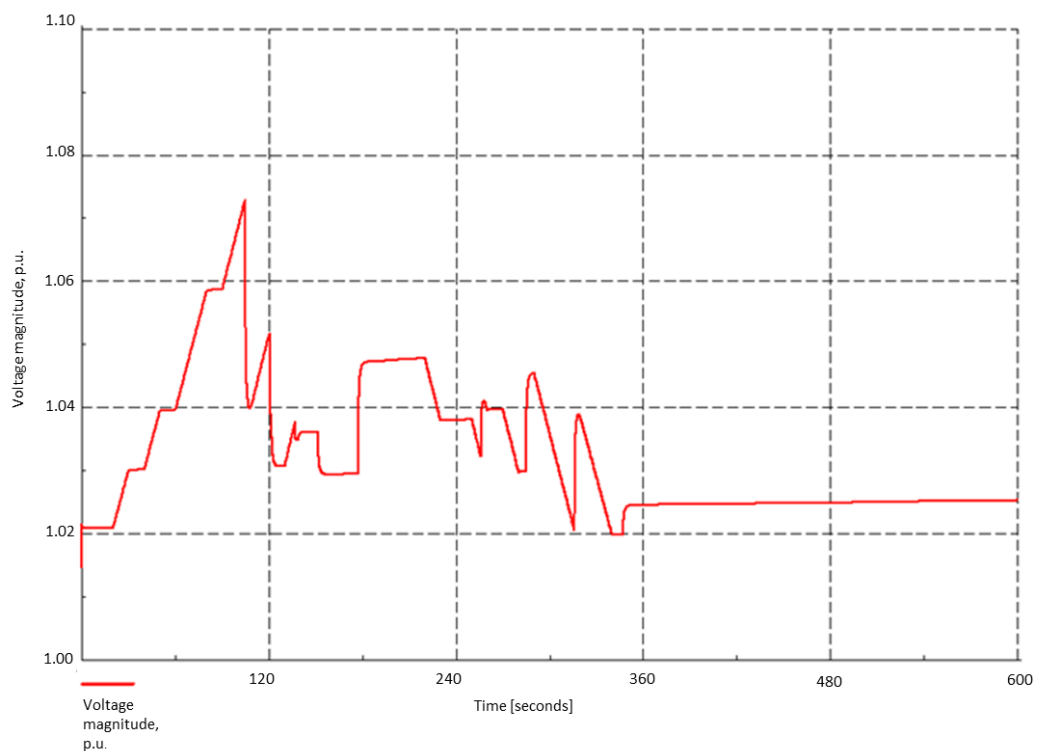

Figure 17. Voltage Levels at Busbar D with Shared ANM Control Actions

In Figure 18, the order in which DG units are curtailed and released are as expected following the Shared PoA. Initially on breach of the 1.06p.u. upper threshold DG 1 (red trace), DG 2 (green trace) and DG 3 (blue trace) are all issued the same set-points.

As the voltage continues to rise further control actions are instructed to all DG units. All DG units are set close to zero output. Only when the target voltage of 1.03p.u. is achieved (Figure 17) are control signals issued to all DGs (in line with the PoA) to relax their curtailment. This process is repeated following the Shared PoA until all DG units can run unconstrained.

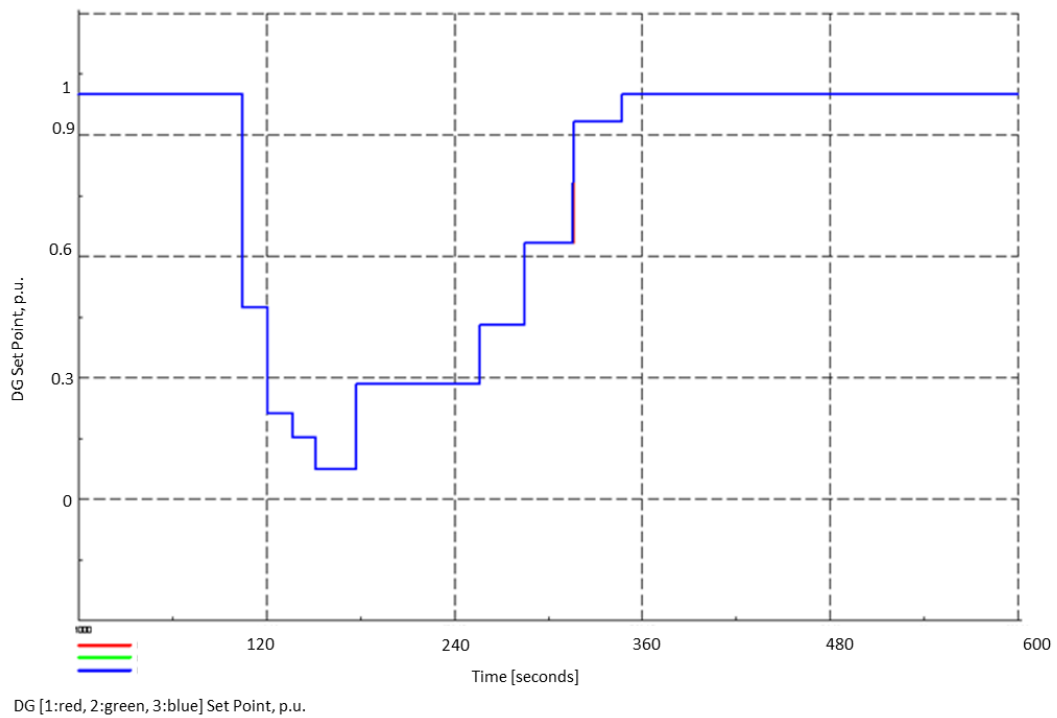

Figure 18. Shared Generator Set-points Issued

The set-points issued to the DG units result in different MW outputs from the units due to their different rated outputs. DG 1 has a rated output of 3.6MW whereas DG 2 and DG 3 have rated outputs of 2.7MW. The corresponding MW output of DG 1, DG 2 and DG 3 are shown in Figure 19 below (DG 2 trace is behind DG 3's trace).

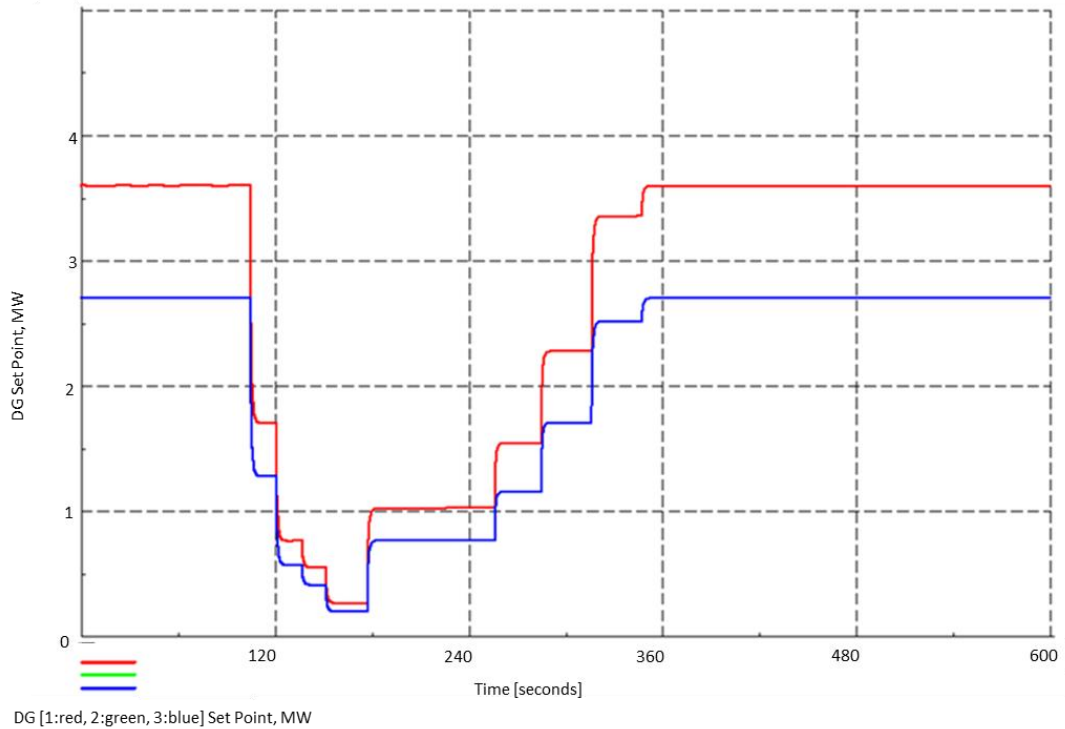

Figure 19. Corresponding MW output of DG Units following the Shared PoA

4.2.8 Proof of PoA: Mix PoA (LIFO and Shared)

For the mixed PoA the priority stack was as follows:

1. DG 2 and DG 3 have the same priority (DG 2 & DG 3 having the highest priority)
2. DG 1 is 2nd in the priority stack

Figure 20, below, presents the voltage at Busbar D. When the voltage exceeds the upper threshold (1.06p.u.) control actions are instructed to the DG units to drive the voltage towards the target voltage (1.03p.u.).

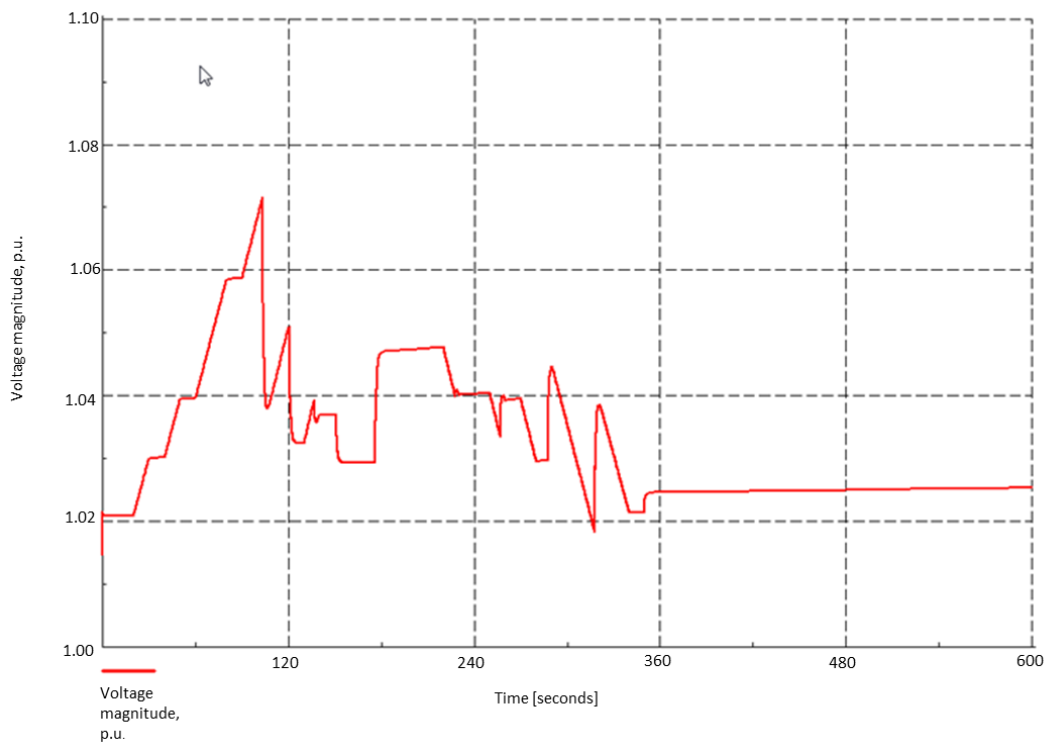
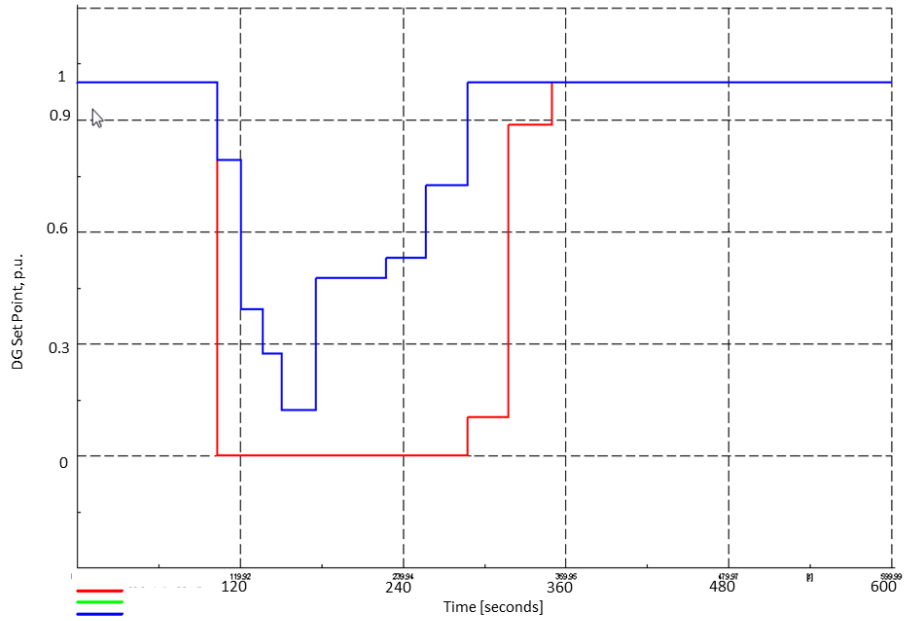

Figure 20. Voltage Levels at Busbar D with Mixed Order ANM Control Actions

In Figure 21, the order in which DG units are curtailed and released are as expected following the Mixed PoA. Initially on breach of the 1.06p.u. upper threshold DG 1 (red trace) is instructed to reduce its output to '0' while DG 2 and DG 3 are issued commands sharing their curtailment burden (the blue trace of DG 3 is on top of the green trace of DG 2). Only when the target voltage of 1.03p.u. is achieved (Figure 20) are control signals issued to the DG units (in line with the PoA) to relax their curtailment. The first units to be released are DG 2 and DG 3 followed by DG 1.



DG [1:red, 2:green, 3:blue] Set Point, p.u.

Figure 21. Mixed PoA Generator Set-points Issued

The set-points issued to ‘shared’ DG units 2 and 3 result in the same MW outputs as they have the same MW rating. The corresponding MW output of DG 1, DG 2 and DG 3 are shown in Figure 22 below (DG 2 trace is behind DG 3’s trace).

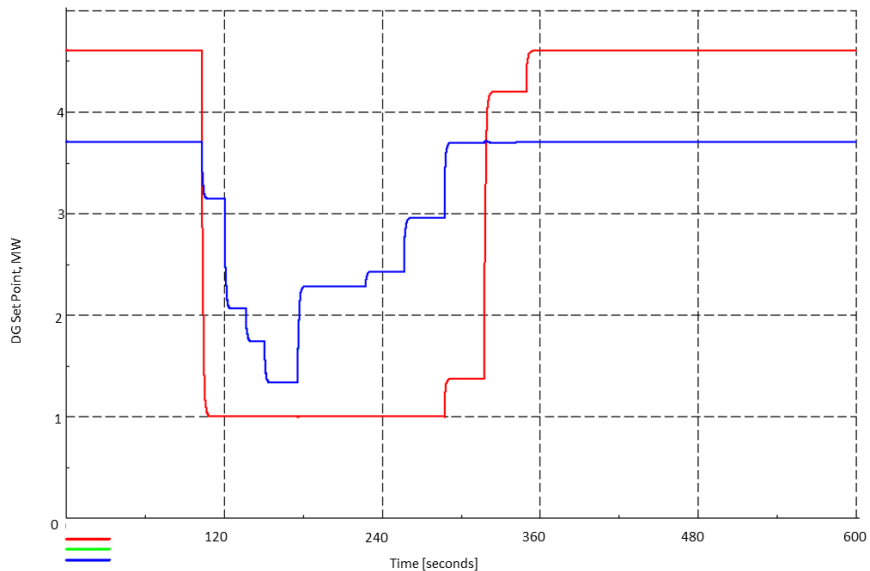

DG [1:red, 2:green, 3:blue] Set Point, MW

Figure 22. Corresponding MW output of DG Units following the Mixed PoA

4.2.9 Observations

From the above case study, a number of observations can result. Firstly, it was shown that this platform could adequately test and demonstrate the configured Principles of Access to ensure that generators in a deployed system will adhere to its contractual obligations. The system under test operated as expected, issuing curtailment and releasing the generators according to the pre-configured priority stack.

Further understanding of the configuration process for the platform as a whole was gained. Configuring the communications channels between the different components is a non-trivial task that requires fully understanding the data transfer between the different controllers to ensure the states are adequately represented.

This study has since been expanded upon with Smarter Grid Solutions. Utility networks have used this platform to implement a model of their own network to understand what impact this solution would have in a real life implementation. The environment being considered critical in the development of the sgs voltage product as there were no in-house alternatives for testing as the complexity of the product increased. The environment is also used to exhibit the product to clients.

4.3 Case Study 2 – Orkney Simulation

4.3.1 Overview

The second case study is used to demonstrate how the control actions of a power flow control product are reflected in the testing environment. The objectives of this test are primarily a proof of concept as the algorithm has been tested extensively in field trials, although at the time of writing not on a server based platform. The algorithms used by the controllers are not in scope at this juncture, but it is anticipated that the test environment will be used to highlight certain limitations or unexpected behaviour in order to improve the existing methods.

4.3.2 Environment Configuration

This case study will involve controlling 4 generators and circuit breakers to alleviate a thermal constraint at a given measurement point. The set-up of the environment is shown in the Figure 23.

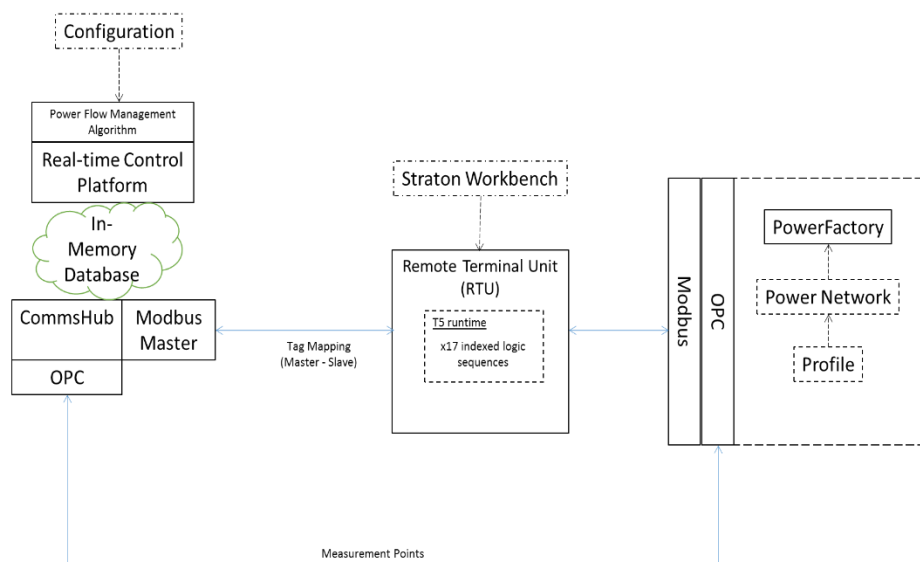

Figure 23. Environment Configuration

The hardware platform is the same as shown in the previous case study. A server hosting real time algorithms and a communication platform. The field devices are also as documented in case study 1; instead of a soft PLC a physical RTU is used to host multiple arrays of the local controller state machine.

Communications between the real time controllers, via, the communications interface, to the remote devices is achieved using the Modbus protocol, then subsequently translated to OPC for interfacing to PowerFactory.

4.3.3 Network Model

A section of a 33kV network was modelled as shown in Figure 20. The controllable generators are located upstream of the thermal constraint, taken at the point indicated as 'thermal measurement.' The network is being operated using Last-In-First-Off Principles of Access.

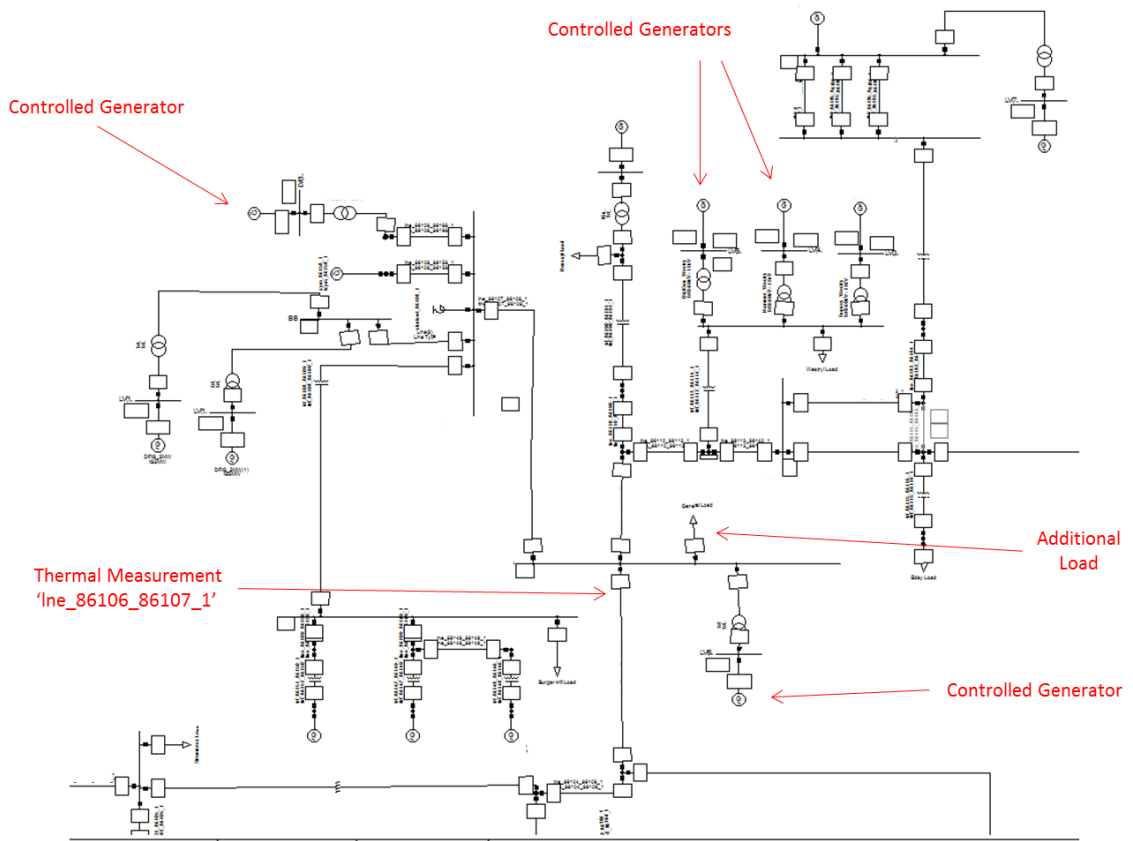

Figure 24. Power Flow Control Network Model

4.3.4 Dynamic Controllers

4.3.5 Simulations

The network model in Figure 24 has been chosen for the simulation due to the number of existing controllable generators and the availability of existing configuration files for sgs power flow. To force a thermal excursion on the network an additional load has been placed at the measurement point and written to from a .csv file holding the load profile values. This profile forces a thermal excursion on line, indicated by the thermal measurement in Figure 20.

The simulation is run over 2000 seconds.

4.3.6 Results of simulation

In Figure 25 the thermal loading of 'lne_86106_86107_1' is shown in kA. The global and sequential trip thresholds are plotted along with the trim and reset thresholds.

A summary of the values are presented in Table 3.

Table 3. sgs power flow Thresholds

Threshold	Value (kA)
Global Trip	326
Sequential Trip	311
Trim	281
Reset	255

In Figure 25 at time 0 seconds the power flow management algorithm is initialised and all generators are set to zero. This can be seen in the line loading as it drops to approximately 0.15kA. As generation is brought back on in the line with their connection priority the line loading increases. During the same period the additional load at bus draws power through 'lne_86106_86107_1' to the point of overload at approximately time 870 seconds and again at approximately time 1043 seconds.

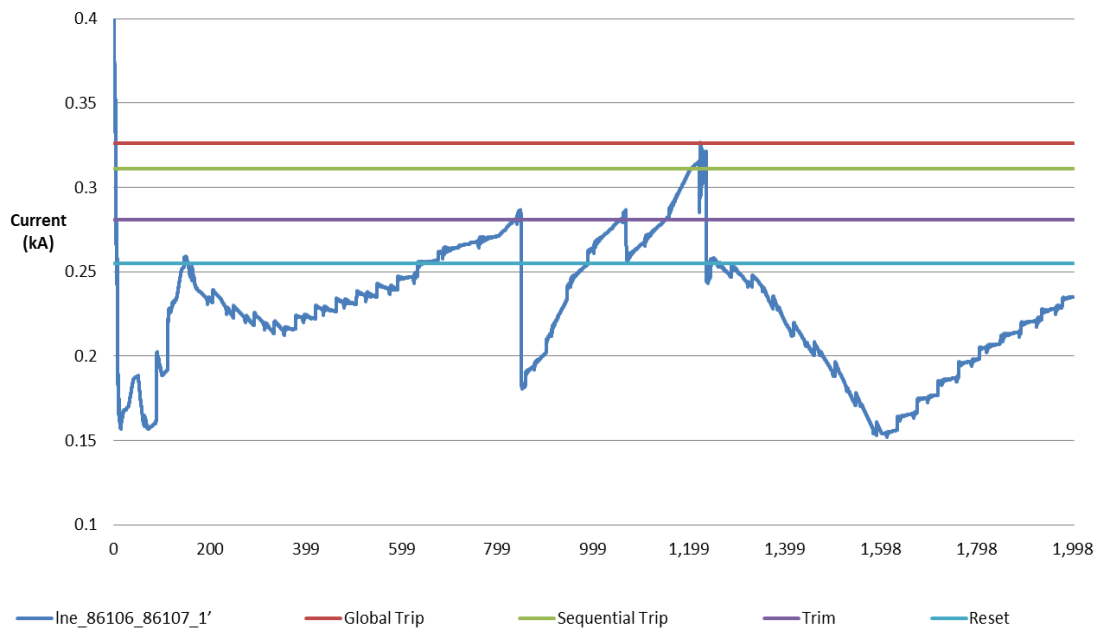

Figure 25. Constrained Branch Loading and Thresholds

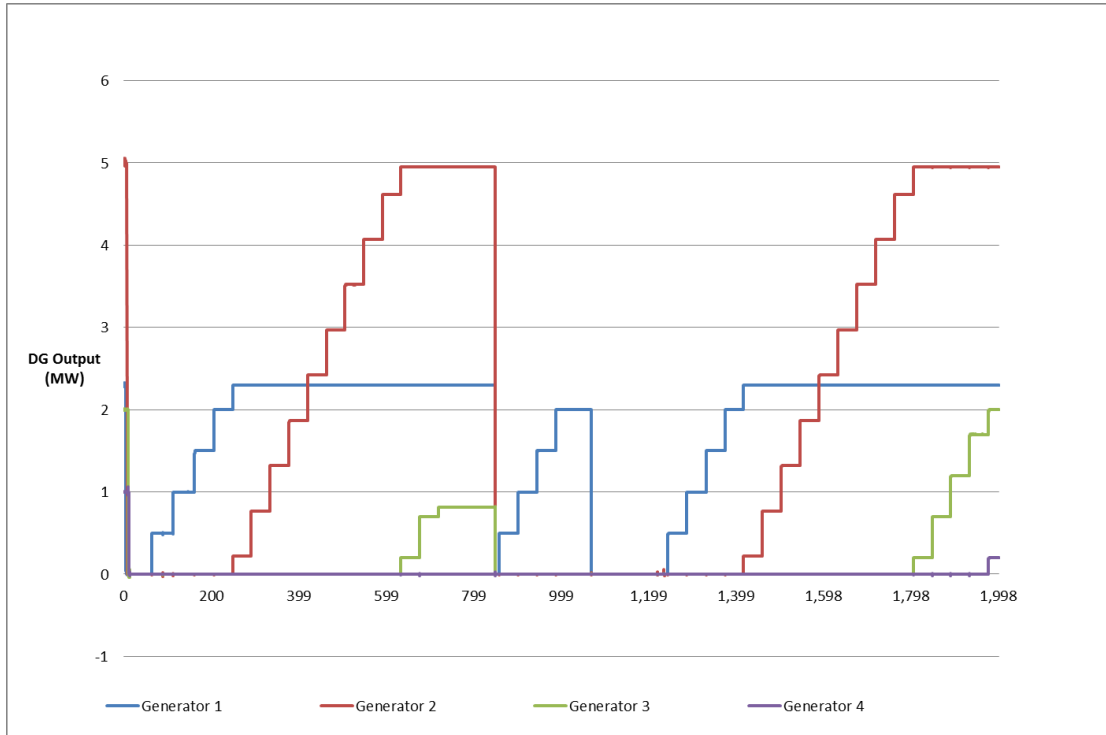

Figure 26. Generator MW Response to Thermal Overloads

The generator controls issued from the power flow management algorithm are shown in Figure 26. The priority order of the generators is shown in Table 4:

Table 4 Generator Priority Order

Generator	LIFO Priority
Generator 1	1 (first on)
Generator 2	2
Generator 3	3
Generator 4	4

The following main events can be taken from Table 5:

Table 5 Sequence of Events

Time [s]	Description of the event
0	Generators are released in order of priority on initialisation of the power flow application
870	Generators 1 and 2 are fully released. Generator 3 is in the process of releasing when thermal constraint is breached. Generators 1, 2 & 3 ramped to zero to alleviate thermal constraint
875	Current at thermal constraint, below Reset margin and begins to release Generator 1
1043	Thermal excursion occurs, curtailing Generator 1 to zero
1200	Artificial load profile returns below reset, allowing Generators to be released

4.3.7 Observations

This case study demonstrated the ability of the platform to represent the curtailment actions in response to a thermal overload. The results showed the dynamic response of the power network when set points are issued, demonstrating how this area of network could be actively managed. The development of dynamic controllers, particularly for Doubly Fed Induction Generators and Fully Rated Invertor Generator, were modified to accommodate set points from an external controller. It was observed that the controllers of machines will need tuned to represent more accurately the time constants of actual machines.

Again this has also been expanded upon by Smarter Grid Solutions, primarily for demonstration purposes. This has been a useful aid in exhibiting the response of the **sgs powerflow** product in a simulated environment.

4.4 Case Study 3 – Automatic Voltage Controller

4.4.1 Overview

The third case study is used to demonstrate how the use of voltage controllers of tap changers can be explored in this environment to determine its suitability for managing 11kV voltage rise on a feeder. The following network model shows an 11kV network with added generators which could introduce voltage rise above the defined operating limits.

4.4.2 Environment Configuration

In this case study PowerFactory is interfaced to purely from a user controlled OPC Client. This allowed for greater control of the network conditions to create the correct conditions for tap changing. Figure 25 presents the architecture of setup; an OPC Client is used to manually issue set-points to the PowerFactory simulation.

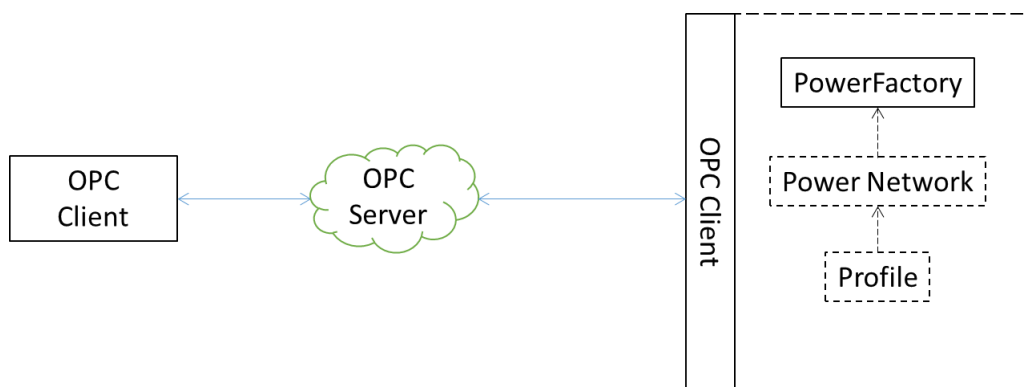

Figure 27. Voltage Control proof of concept

4.4.3 Network Model

The network model, Figure 28, in this case is an 11kV radial network which can be used to simulate a network with voltage rise problems caused by added generation. To alleviate the issues caused by voltage rise, and still accommodate the generators, changing the set point of an Automatic Voltage Controller (AVC) can be demonstrated.

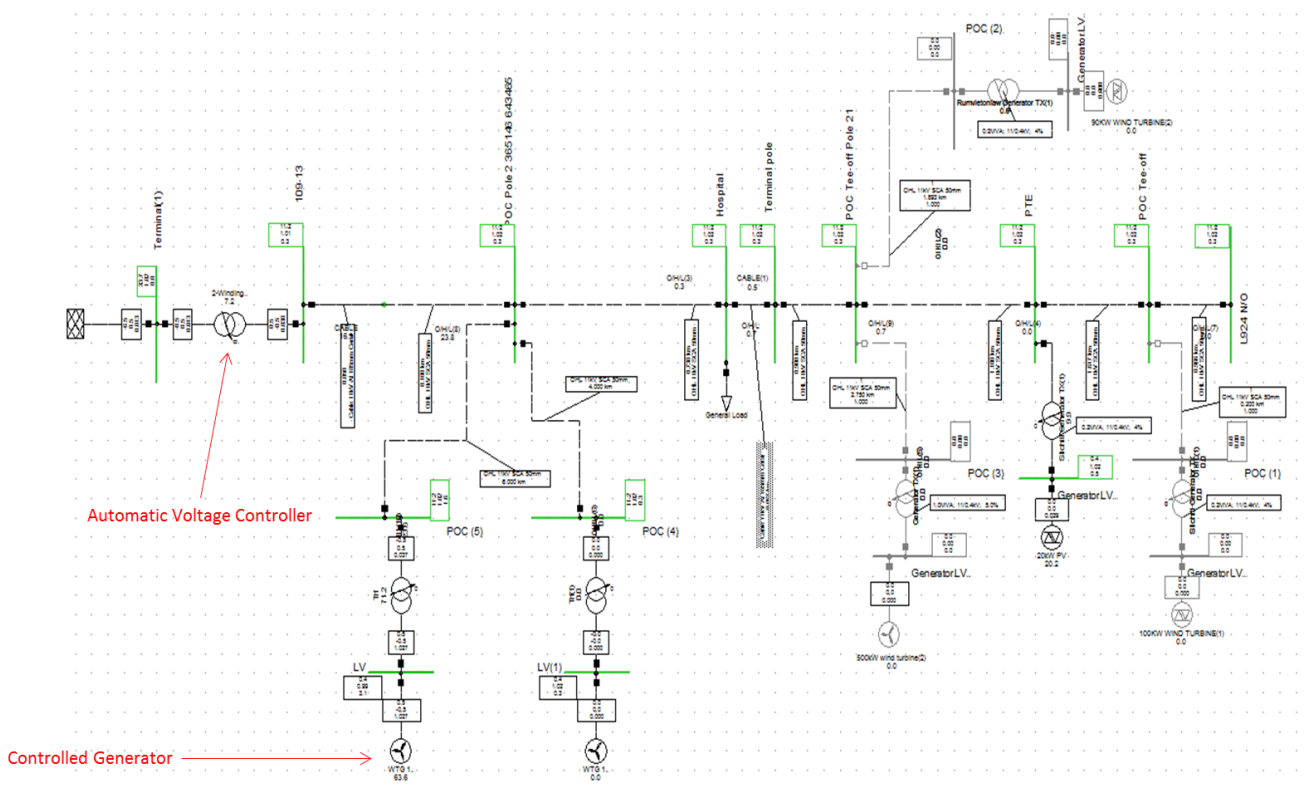

Figure 28. Generator and AVC Control for Voltage Studies

4.4.4 Dynamic Controller

The dynamic controller of the AVC is shown in the 3 block model in Figure 29. Figure

30 shows the detailed model of the 'TrfContr' the model. The 'vref' attribute can be interfaced to from an external source, in this case manually via an OPC client, to control the voltage set point which in turn sets the tap position of the transformer.

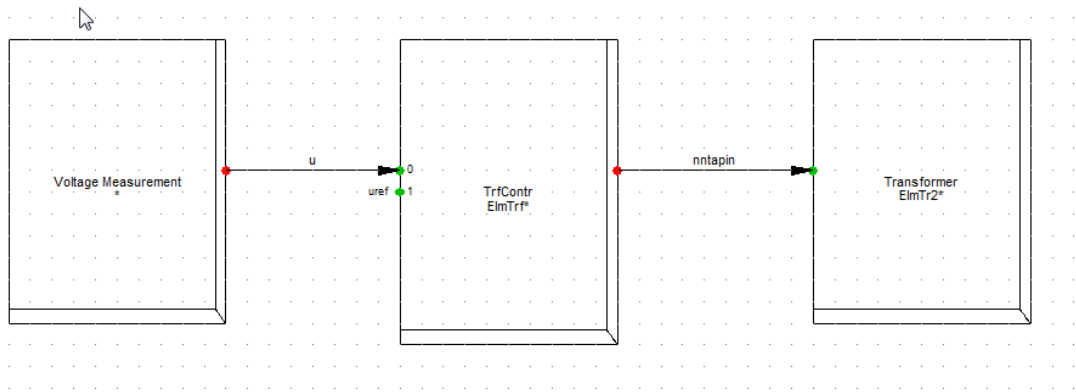

Figure 29. AVC Model

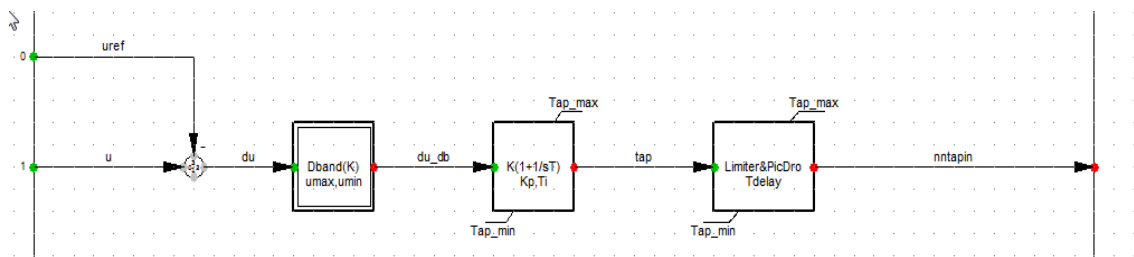

Figure 30. Tap Changer Set Point Model

4.4.5 Simulation

This basic simulation was an exercise to observe the response of the voltage at an observed bus in response to a change in voltage set point of an AVC controlling a transformer. At time $t \sim 10$ seconds the set point of an AVC was changed from 1.02 p.u. to 0.98 p.u. Figure 31 and Figure 32 show the change in voltage at the bus and

the change in tap position, respectively, following the change in set point. Local control at the generator is decreasing the voltage at the bus slowly. The step change in voltage is due to the tap changes at the transformer.

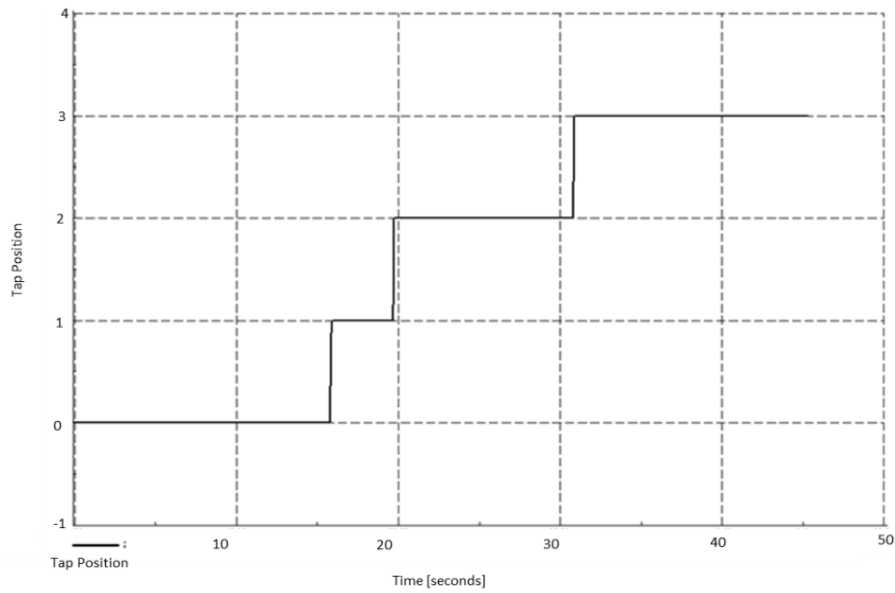

Figure 31. Tap Position

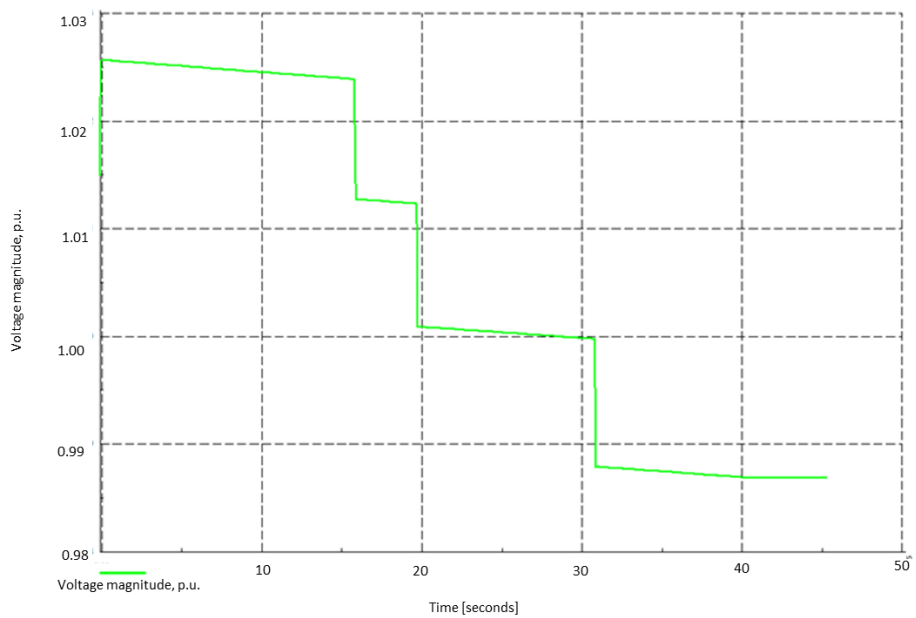

Figure 32. Voltage Response to Tap Change

It is anticipated this environment can be used to co-ordinate the control between generators output and tap changing to prevent hunting and other undesirable interactions between controllers which may present itself during operation. Simulating the network dynamically presents the temporal response of a network while being able to accommodate the real time controllers in parallel with PowerFactory.

4.5 Case Study 4 – Communications Emulation

4.5.1 Overview

Communication delays and faults must be accounted for in distributed control algorithms. This case study introduces communications emulation as a way of adding more ‘realism’ to the testing environment. This section will briefly demonstrate the use of communications emulation as part of the environment.

4.5.2 Environment

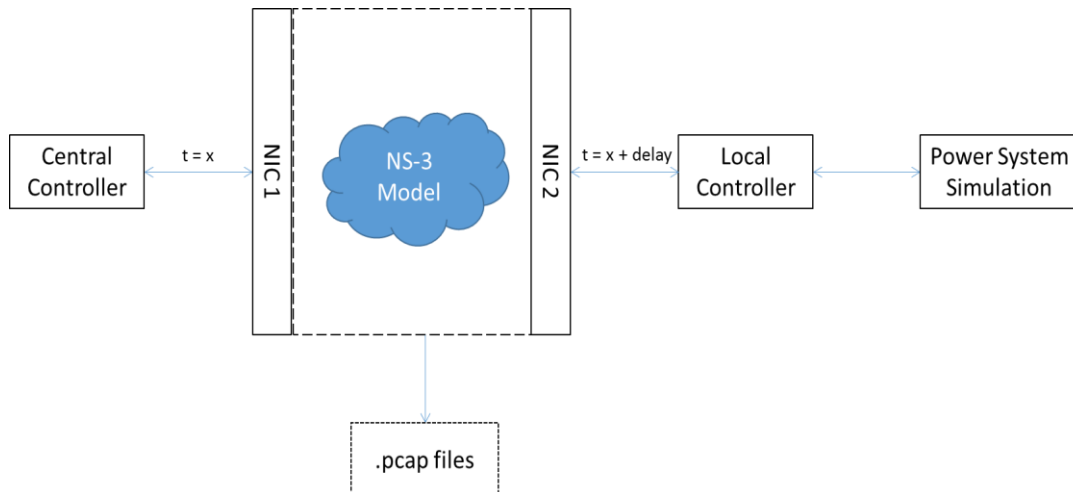

Figure 33 Test Environment with Communications Emulation

The environment is as described in previous studies, however the ability to introduce a ‘distance’ between the central controller and local controller is demonstrated here. Using separate network cards, the traffic can be input in to one part of the simulation and delayed or dropped packets before exiting the network card connected to the local controller, demonstrating the ability to handle various communication networks.

4.5.3 Results

Analysing the .pcap files collected by both network cards shows the delay being introduced across the network model. The model being used can be found in the C++ file in Appendix A. The data in NIC 1 shows a request being sent from the controller, the response is not received until approximately 100ms later. At NIC 2, the delay between the request and response is approximately 3ms. The model being used is designed to introduce a 50ms delay in both directions. The results are therefore consistent with what would be expected.

No.	Time	Source	Destination	Protocol	Length	Info
1	0.000000	10.100.7.2	10.100.8.2	TCP	50	55394 > iso-tsap [SYN] Seq=0 win=8192 Len=0 MSS=1460 SACK_PERM=1
2	0.004958	10.100.8.2	10.100.7.2	TCP	50	iso-tsap > 55394 [SYN, ACK] Seq=0 Ack=1 win=65535 Len=0 MSS=1460 SACK_PERM=1
3	0.113454	10.100.7.2	10.100.8.2	TCP	42	55394 > iso-tsap [ACK] Seq=1 Ack=1 win=64240 Len=0
4	0.113582	10.100.7.2	10.100.8.2	COTP	64	CR TPDU src-ref: 0x0001 dst-ref: 0x0000
5	0.117818	10.100.8.2	10.100.7.2	COTP	56	CC TPDU src-ref: 0x0001 dst-ref: 0x0001
6	0.218814	10.100.7.2	10.100.8.2	MMS	252	initiate-RequestPDU
7	0.321003	10.100.8.2	10.100.7.2	MMS	189	initiate-ResponsePDU
8	0.324099	10.100.7.2	10.100.8.2	MMS	107	confirmed-RequestPDU
9	0.326920	10.100.8.2	10.100.7.2	MMS	151	confirmed-ResponsePDU

Figure 34 Traffic at NIC 1

4	0.113570	10.100.7.2	10.100.8.2	COTP	64	CR TPDU src-ref: 0x0001 dst-ref: 0x0000
5	0.217901	10.100.8.2	10.100.7.2	COTP	56	CC TPDU src-ref: 0x0001 dst-ref: 0x0001
6	0.218652	10.100.7.2	10.100.8.2	MMS	252	initiate-RequestPDU
7	0.321193	10.100.8.2	10.100.7.2	MMS	189	initiate-ResponsePDU
8	0.324053	10.100.7.2	10.100.8.2	MMS	107	confirmed-RequestPDU
9	0.427079	10.100.8.2	10.100.7.2	MMS	151	confirmed-ResponsePDU

Figure 35 Traffic at NIC 2

This is an example of a point to point link model being used to introduce delay. Using this method, characteristics of communication networks can be extracted and modelled using the point to point link model. As discussed in the NS-3 section previous chapter, an extensive API is available to build models of increasing complexity.

4.6 Chapter Summary

This chapter demonstrates some of the practical ANM applications and products which can be tested using the proposed environment. The case studies first explore how the test environment can be used to simulate an over voltage to demonstrate the control algorithms response as it issues set points to a number of generators. To achieve such control, the modifications to the existing models are detailed. Moreover, the different commercial arrangements of the controllers were then demonstrated by changing the principles of access.

Following the voltage control examples, thermal control is then demonstrated. It is demonstrate that the test environment reflects the actions of a controller which may be used to curtail generation with the goal of alleviating a thermal constraint. The ability of the test environment to respond to discrete changes, such as tap changing control was demonstrated in case study 3. Again, the modifications made to the PowerFactory models to accommodate this were shown.

The final case study demonstrate how communications emulation can be used to vary the conditions for the traffic being transmitted and received by the different distributed components on the network. This simple point-to-point link model was shown to be able to introduce a delay of 500ms and restrict the bandwidth. These can be used to model the communications channels being used in the field to understand where timers may erroneously elapse or require tuning, amongst other learning objectives.

These case studies will be used to draw conclusions about the test environment and discuss future work in the next chapter.

5 Discussion and Further Work

5.1 Conclusions

The aspirations of this body of work was to develop a proof of concept prototype to be further developed and incorporated into the internal testing environment of Smarter Grid Solutions. This thesis has demonstrated how the combination of Power Systems Simulation and Communications Emulation can be used to develop a testing environment for Active Network Management solutions.

To understand the requirements for testing, first the technical and regulatory drivers for ANM were explored in chapter 2. Regulatory incentives such as Innovation Funding Incentive, Registered Power Zones and Low Carbon Network Fund provided the financial incentive for network operators to implement innovative technologies. The challenges of introducing Distributed Generation were outlined. It was discussed how using various control techniques these hurdles could be mitigated. However, before real-time control of network technologies can be implemented, testing is required.

Chapter 3 investigated the testing requirements for Active Network Management. The methodology for selecting the appropriate components of the environment was defined. Firstly, various factors contributed to the requirements capture process. Following the trials of various technologies, a decisions were made as to which technologies to trial and then subsequently integrate to design and build a prototype

testing environment.

Not only is testing required to verify and validate the control system, it can provide significant financial savings by eliminating errors early in the development lifecycle. A literature review of the existing testing platforms showed that similar testing environments exist, but very few are able to simulate/emulate both the real-time communications infrastructure and power systems network. The commercial and open source simulation packages used in combination to create a real time dynamic representation of an end-to-end ANM system are detailed.

Due to the flexibility of each package, there are a plethora of use cases for the test environment. Chapter 4 documents four power systems cases studies which highlight the scale and diversity of the uses. The first case presents a hypothetical network scenario to illustrate how generators can be used to manage voltage levels on a constrained bus. The second case demonstrates how the testing of an ANM scheme controller over 50 controllable devices to alleviate power flow constraints can be validated. Finally, the third case is introduced to highlight how using an Automatic Voltage Controller can be problematic under certain conditions. Finally an example of the uses of communications emulation is given. Each of these example cases provide valuable learning and have been fed back into the product development cycle at Smarter Grid Solutions.

5.2 Future Work

The test bed has vast potential in upgrading and extending its capability. This section will discuss a number of areas in which it would be beneficial to develop. The framework in which the test environment was designed is modular, and thus to extend its capability of one or more of the components, should have minimal knock-on consequences.

As discussed in the thesis, ANM in practise is relatively new, thus testing frameworks are yet to be developed. From both an academic and commercial view, it would be highly beneficial to develop a standard bank of models to represent typical power systems models. This would be beneficial in regression testing and for benchmarking different controllers. Academically, it would allow for defined metrics to be developed and analysed in a methodical manner.

Within the body of this work a NS-3 based model was used to emulate a point-to-point link, which is the method of communication used in the aforementioned Orkney project. However other projects, such as the Flexible Plug and Play project, have different communications channels such as a Radio Frequency (RF) Mesh. There exists a lot of scope to develop a bank of communication models to build upon the model provided in the appendix. Chapter 3 also highlighted other software packages which may have benefits over NS-3, such as having a user-friendly Graphical User Interface (GUI), simpler modelling environment and simpler routing arrangements. These aspects would open up the communications emulation platform to more

novice users and speed up development time. Further work would include a comprehensive evaluation of OPNET and Exata.

Since the simulations are operating in real-time, it would be highly impractical and inefficient for a user to sieve through the vast amount of data being created or to observe the system throughout the simulation. Therefore, it would be highly desirable to develop a system to automatically interpret results. Metrics such as the number of lost commands, improper response to a thermal or voltage excursion and other anomalies could be flagged to the user. Again this would have great benefits in terms of regression testing and developing a sufficient methodology for comparing system's behaviour.

Smarter Grid Solutions have continued to develop this body of work. The test environment has doubled as a method of effectively demonstrating how their system will perform on a utilities network during the sales process. Moreover the work has moved to trials at the National Renewable Energy Laboratories (NREL) in Golden, Colorado at their Energy Systems Integration Facility (ESIF). This body of work looks to build upon the platform and include physical generation and load in a Power Hardware in the Loop set up. Through the use of amplification and inverters, a simulated network appears to the physical devices as an actual network; to the simulation it appears as though the physical devices are part of the simulation. This work is ongoing and will report to the wider community in 2016 [52].

6 References

- [1] E. Liu, M.L. Chan, C.W. Huang, N.C. Wang, C.N. Lu, "Electricity Grid Operation and Planning Related Benefits of Advanced Metering Infrastructure", International Conference on Critical Infrastructure, 2010.
- [2] B. Wojszczyk, "Deployment of Advance Smart Grid Solutions - Global examples and lessons learned", Innovative Smart Grid Technologies 2012.
- [3] Soltions for Self-Healing Grids, <http://www.sandc.com/solutions/self-healing-grids.asp>, August 2015
- [4] Po-Chen Chen, R. Salcedo, Q. Zhu, F. De Leon, D. Czarkowski, J. Zhong-Ping, V. Spitsa, Z. Zabar, R. E. Uosef, "Analysis of Voltage Profile Problems Due to the Penetration of Distributed Generation in Low-Voltage Secondary Distribution Networks," IEEE Transactions on Power Delivery, Volume 24, Issue 4, 2012.
- [5] S. W. Alnaser and L. F. Ochoa, "Advanced Network Management Systems: A Risk-Based AC OPF Approach," IEEE Transactions on Power Systems, vol. Early Access Online, 2014.
- [6] R. A. F. Currie, G. W. Ault, C. E. T. Foote, and J. R. McDonald, "Active power-flow management utilising operating margins for the increased connection of distributed generation," IET Generation, Transmission Distribution, vol. 1, no. 1, pp. 197–202, Jan. 2007.
- [7] M. J. Dolan, E. M. Davidson, I. Kockar, G. W. Ault, and S. D. J. McArthur, "Reducing Distributed Generator Curtailment Through Active Power Flow Management," IEEE Transactions on Smart Grid, vol. 5, no. 1, pp. 149–157,

-
- Jan. 2014.
- [8] C. Foote, R. Johnston, F. Watson, R. Currie, D. Macleman, A. Urquhart, "Second Generation Active Network Management on Orkney," CIRED 2013.
- [9] Innovation Funding Incentive Overview,
<http://www.energynetworks.org/electricity/engineering/research-and-development/innovation-funding-incentive.html>, Jan 2015
- [10] Low Carbon Network Fund Overview,
<https://www.ofgem.gov.uk/electricity/distribution-networks/network-innovation/low-carbon-networks-fund>, Jan 2015
- [11] S. Georgiopoulos, E. Cerqueira, R. Johnston, R. Currie, C. Marantes, "Flexible Plug and Play Low Carbon Networks: An open and scalable active network management solutions for a faster and cheaper distributed generation connection", CIRED 2013.
- [12] RIIO ED1 Overview,
<https://www.ofgem.gov.uk/network-regulation-%E2%80%93-riio-model/riio-ed1-price-control>, Jan 2015
- [13] Electricity Networks Strategy Group: A Smart Grid Roadmap (2010)
- [14] C.J. Dent, L.F. Ochoa, G.P. Harrison, "Network Distribution Generation Capacity Analysis using OPF with Voltage Step Constraints", IEEE Transactions on Power Systems, Volume 25, Issue 1, 2010.
- [15] "Voltage Rise: The big issue when connecting embedded generation to long 11kV overhead lines", Power Engineering Journal, Volume 16, Issue 1, 2002.
- [16] M.J. Dolan, E.M. Davidson, G. W. Ault, F. Coffele, I. Kockar, J.R.

-
- McDonald, "Using Optimal Power Flow for Management of Power Flows in Active Distribution Networks within Thermal Constraints", Universities Power Engineering Conference, 2009.
- [17] B. O'Neill, C. Foote, R. Macdonald, M.J. Dolan, S. Gill, G. Milne, S. Reid, "Active Network Management on islanded systems: The Shetland Experience," IEEE Innovative Smart Grid Technologies, 2013.
- [18] E. Davidson, A. Keane, R. Currie, N. McNeill, D. Macleman, M. Lee, "Requirements Driven Distribution State Estimation," CIRED, 2013.
- [19] R. A. F. Currie, G. W. Ault, R. W. Fordyce, D. F. MacLeman, M. Smith, and J. R. McDonald, "Actively Managing Wind Farm Power Output," IEEE Transactions on Power Systems, vol. 23, no. 3, pp. 1523–1524, Aug. 2008.
- [20] R.A.F. Currie, G.W. Ault, C.E.T. Foote, N.M. McNeill, A.K. Gooding, "Smarter ways to Provide Grid Connections for Renewable Generators" IEEE Power and Energy Society General Meeting, 2010.
- [21] V. Thornley, J. Hill, P. Lang, D. Reid, "Active Network Management of voltage leading to increased generation and improved network utilisation", CIRED, 2008.
- [22] E.M. Davidson, S.D.J. McArthur, C. Yuen, M. Larsson, "AuRA-NSM: Towards the Delivery of Smarter Distribution Networks through the Application of Multi-Agent Systems Technology", IEEE Power and Energy Society General Meeting, 2008.
- [23] P.C. Taylor, T. Xu, N.S. Wade, M. Prodanovic, R. Silversides, T. Green, E.M. Davidson, S. McArthur, "Distributed Voltage Control in AuRA-NMS", IEEE Power and Energy Society General Meeting, 2010

-
- [24] M.J. Dolan, E.M. Davidson, G.W. Ault, J.R. McDonald, "Techniques for Managing Power Flows in Active Distribution Networks within Thermal Constraints", CIRED, 2009.
- [25] M. Stifter, B Bletterie, H. Brunner, D. Burnier, H. Swansan, F. Andren, R. Schwalbe, A. Albart, R. Nenning, F. Herb, R. Pointner, "DG DemoNet validation: Voltage Control from simulation to field test", IEEE Innovative Smart Grid Technologies Europe, 2011
- [26] M. Stifter, B Bletterie, W. Tremmel, H. Brunner, Schwalbe, A. Albart, F. Herb, R. Pointner, "DG DemoNet: Experiences from volt/var control field trials and control algorithms advancement", IEEE Innovative Smart Grid Technologies Europe, 2012
- [27] CEN-CENELEC-ETSI Smart Grid Coordination Group, Smart Grid Reference Architecture, November 2012
- [28] M. Debabbi, F Hassaine, Y. Jarraya, A. Soneanu, L. Alawneh, "Validation and Verification in Systems Engineering: Assessing UML/SysML Design Models"
- [29] OSI 7 Layer Model, <http://support.microsoft.com/kb/103884>, July 2014.
- [30] A. Cauevic, S. Punnekkat, D. Sundmark, "Quality of Testing in Test Driven Development", Conference on the Quality of Information and Communications Technology (QUATIC), 2012.
- [31] R. Paul, "End-to-End integration testing", Asia-Pacific Conference on Quality Software, 2001.
- [32] Smart Grid Testing and Certification, Jan 2015
<http://www.nist.gov/el/smartgrid/sgtest.cfm>

-
- [33] D. Niyato, Q. Dong, P. Wang, E. Hossain, "Optimizations of Power Consumption and Supply in the Smart Grid: Analysis of the Impact of Data Communications Reliability," IEEE Transactions on Smart Grid, Volume 4, Issue 1, 2013.
- [34] D.L. Howell, "Integrated Laboratory 'real-time interactive communications simulation'", IEEE National Aerospace and Electronics Conference, 1990.
- [35] K.M. Hopkinson, K.P. Birman, R. Giovanni, D.V. Coury, X. Wang, S.J. Thorp, "EPOCHS: Integrated commercial off-the-shelf software for agent-based electric power and communication simulation", Winter Simulation Conference, 2003.
- [36] L. Hua, S.S. Veda, S.S. Shukla, L. Mili, J. Thorp, "GECO: Global Event-Driven Co-Simulation Framework for Interconnected Power System and Communications Network", IEEE Transactions on Smart Grid, Volume 3, Issue 3, 2012.
- [37] H. Lin, Y. Deng, S. Shukla, J. Thorp, L. Mili, "Cyber Security impacts on all-PMU state estimator – a case study on co-simulation platform GECO", IEEE Conference on Smart Grid Communications, 2012
- [38] A. Monti, M. Colciago, P. Conti, M. Maglio, R.A. Dougal, "Integrated Simulation of Communication, Protection and Power in MVDC Systems", IEEE Electric Ship Technologies Symposium, 2009.
- [39] W. Li, A. Monti, M. Luo, R.A. Dougal, "VPNET: A Co-Simulation Framework for Analyzing Communication Channel Effects on Power Systems" IEEE Electric Ship Technologies Symposium, 2011.
- [40] T. Strasser, M. Stifter, F. Andren, P. Palensky, "Co-Simulation Training

-
- Platform for Smart Grids,” IEEE Transactions on Power Systems,” IEEE Transactions on Power Systems, Volume PP, Issue 99, 2014.
- [41] Network Simulator 3, www.nsnam.org, November 2012
- [42] S. Fateri, Q. Ni, G.A. Taylor, S. Panchadcharam, I. Pisica “Design and Analysis of Multi-Based Publisher/Subscriber Models Over Wireless Platforms for Smart Grid Communications” IEEE 11th Conference on Trust, Security and Privacy in Computing and Communications, 2012
- [43] M. Haffar, J.M. Thiriet, M. El-Nachar, “Software and hardware in the loop component for an IEC 61850 Co-Simulation platform,” in Proc. of the International Multiconference on Computer Science and Information Technology, pp. 817-823. 2010
- [44] NS-3 Model Library, P.60, Release 3.17, May 2013
- [45] A. Alvarez, R. Orea, S. Cabrero, X.G. Paneda, R. Garcia, D. Melendi, “Limitations of Network Emulation with Single Machine and Distributed NS-3”, SIMUTools International ICST Conference on Simulation Tools and Techniques, 2010
- [46] M. Skjegstad, F.T. Johnsen, J. Nordmoen, “An Emulated Test Framework for Service Discovery and MANET Research based on NS-3,” International Conference on New Technologies, Mobility and Security, 2012.
- [47] N. Das, Wu Ma, S. Islam, “Comparison Study of Various Factors Affecting End-to-End Delay in IEC 61850 Substation Communications Using OPNET”, Australasian Universities Power Engineer Conference, 2012
- [48] L. Chhagan, V. Laxmi, M.S. Gaur, “Video streaming over MANETs: Testing and analysis using real-time emulation”, Asia-Pacific Conference on

Communications, 2013

- [49] R. Kumar, B. Gowri, K.V. Kumar, "Biometric security based application development and emulation framework – IEEE 802.15.4 for Intensive Care Units", International Conference on Recent Advances in Computing and Software Systems, 2012
- [50] F. Andren, M. Stifter, T. Strasser, D. Burnier de Castro, 2011, "Framework for Co-Ordinated Simulation of Power Networks and Components in Smart Grids Using Common Communication Protocols", IECON 2011 – 37th Annual Conference on IEEE Industrial Electronics Society
- [51] R. Pena, J.C. Clare, G.M. Asher, "Doubly fed induction generator using back-to-back PWM converters and its application to variable-speed wind-energy generation," IEE Proceedings on Electrical Power Applications, Vol.143, No.3, pp. 231-241, May., 1996
- [52] Smarter Grid Solutions NREL Integrate project, <http://www.smartergridsolutions.com/us/news/2015/june/the-national-renewable-energy-laboratory-nrel-selects-smarter-grid-solutions-active-network-management-technology-for-ground-breaking-integrate-project/>, September 2015.

7 APPENDIX – NS-3 POINT TO POINT MODEL

```
/* -*- Mode:C++; c-file-style:"gnu"; indent-tabs-mode:nil; -*- */  
  
/*  
 * This program is free software; you can redistribute it and/or modify  
 * it under the terms of the GNU General Public License version 2 as  
 * published by the Free Software Foundation;  
 *  
 * This program is distributed in the hope that it will be useful,  
 * but WITHOUT ANY WARRANTY; without even the implied warranty of  
 * MERCHANTABILITY or FITNESS FOR A PARTICULAR PURPOSE. See the  
 * GNU General Public License for more details.  
 *  
 * You should have received a copy of the GNU General Public License  
 * along with this program; if not, write to the Free Software  
 * Foundation, Inc., 59 Temple Place, Suite 330, Boston, MA 02111-1307 USA  
 */  
  
#include <iostream>  
  
#include <fstream>  
  
#include "ns3/abort.h"  
  
#include "ns3/core-module.h"  
  
#include "ns3/internet-module.h"
```

```
#include "ns3/network-module.h"

#include "ns3/emu-module.h"

#include "ns3/applications-module.h"

#include "ns3/ipv4-static-routing-helper.h"

#include "ns3/ipv4-list-routing-helper.h"

#include "ns3/point-to-point-module.h"

using namespace ns3;

int

main (int argc, char *argv[])

{

    std::string ethName1 = "eth1";

    std::string ethName2 = "eth2";

    std::string encapMode ("Dix");

    GlobalValue::Bind ("SimulatorImplementationType", StringValue

("ns3::RealtimeSimulatorImpl"));

    GlobalValue::Bind ("ChecksumEnabled", BooleanValue (true));

    Ptr<Node> node1 = CreateObject<Node> ();

    Ptr<Node> node2 = CreateObject<Node> ();

    NodeContainer p2plink = NodeContainer (node1, node2);
```

```
Ptr<EmuNetDevice> deviceExt1 = CreateObject<EmuNetDevice> ();
deviceExt1->SetAttribute ("Address", Mac48AddressValue
("e4:11:5b:e8:20:9a"));
deviceExt1->SetAttribute ("DeviceName", StringValue (ethName1));
deviceExt1->SetAttribute ("EncapsulationMode", StringValue (encapMode));

Ptr<Queue> queue1 = CreateObject<DropTailQueue> ();
deviceExt1->SetQueue (queue1);
node1->AddDevice (deviceExt1);

Ptr<EmuNetDevice> deviceExt2 = CreateObject<EmuNetDevice> ();
deviceExt2->SetAttribute ("Address", Mac48AddressValue
("e4:11:5b:e8:20:74"));
deviceExt2->SetAttribute ("DeviceName", StringValue (ethName2));
deviceExt2->SetAttribute ("EncapsulationMode", StringValue (encapMode));

Ptr<Queue> queue2 = CreateObject<DropTailQueue> ();
deviceExt2->SetQueue (queue2);
node2->AddDevice (deviceExt2);

// We create the channels first without any IP addressing information
PointToPointHelper p2p;
p2p.SetDeviceAttribute ("DataRate", StringValue ("10Mbps")); // to be done:
```

asymmetrical data rate

```
p2p.SetChannelAttribute ("Delay", StringValue ("5ms"));
```

```
NetDeviceContainer devicesInt = p2p.Install (p2plink);
```

```
InternetStackHelper stack;
```

```
stack.Install (p2plink);
```

```
Ipv4AddressHelper ipv4;
```

```
ipv4.SetBase ("10.1.1.0", "255.255.255.252");
```

```
Ipv4InterfaceContainer interfaces = ipv4.Assign (devicesInt);
```

```
Ipv4Address localIp1 ("10.100.7.1");
```

```
Ipv4Address localIp2 ("10.100.8.1");
```

```
Ipv4Mask localMask ("255.255.255.0");
```

```
Ptr<Ipv4> ipv41 = node1->GetObject<Ipv4> ();
```

```
uint32_t interface1 = ipv41->AddInterface (deviceExt1);
```

```
Ipv4InterfaceAddress address1 = Ipv4InterfaceAddress (localIp1, localMask);
```

```
ipv41->AddAddress (interface1, address1);
```

```
ipv41->SetMetric (interface1, 1);
```

```
ipv41->SetUp (interface1);
```

```
Ptr<Ipv4> ipv42 = node2->GetObject<Ipv4> ();
```

```
uint32_t interface2 = ipv42->AddInterface (deviceExt2);
```

```
Ipv4InterfaceAddress address2 = Ipv4InterfaceAddress (localIp2, localMask);
ipv42->AddAddress (interface2, address2);
ipv42->SetMetric (interface2, 1);
ipv42->SetUp (interface2);

Ipv4StaticRoutingHelper ipv4RoutingHelper1, ipv4RoutingHelper2;
Ptr<Ipv4StaticRouting> staticRouting1 = ipv4RoutingHelper1.GetStaticRouting
(ipv41);
staticRouting1->AddHostRouteTo (Ipv4Address ("10.100.8.2"), Ipv4Address
("10.1.1.2"), 1);

Ptr<Ipv4StaticRouting> staticRouting2 = ipv4RoutingHelper2.GetStaticRouting
(ipv42);
staticRouting2->AddHostRouteTo (Ipv4Address ("10.100.7.2"), Ipv4Address
("10.1.1.1"), 1);

EmuHelper emu;
emu.EnablePcapAll ("emu", true);
p2p.EnablePcapAll ("p2p", true);

Simulator::Stop (Seconds (600.0));
Simulator::Run ();
```

```
    Simulator::Destroy ();  
}
```