

**DISTRIBUTED DISPATCHING FOR EMBEDDED GENERATION**

**Stephen J. Conner, BEng**

**A thesis submitted for the degree of Doctor of Philosophy**

**Energy Systems Research Unit**

**Department of Mechanical Engineering**

**University of Strathclyde**

**Glasgow, United Kingdom**

**August 2003**

© 2003 Stephen J. Conner

The copyright of this thesis belongs to the author under the terms of the United Kingdom Copyright Act as qualified by University of Strathclyde Regulation 3.51. Due acknowledgement must always be made of the use of any material contained in, or derived from, this thesis.

**“Imagination is more important than knowledge.”  
-Albert Einstein**

## ACKNOWLEDGMENTS

First of all I would like to thank my supervisor, Professor Joe Clarke, for advice, guidance, and proofreading and corrections of the piles of paper I dumped on him.

I am also grateful to the Carnegie Trust for the Universities of Scotland, who funded this project.

Thanks are also due to my fellow students, researchers and academics in ESRU, who were always full of helpful advice and interesting ideas. In particular, Nick Kelly and Iain Macdonald, who gave me a lot of assistance in the computer simulation side of matters, and Paul Strachan who introduced me to LabVIEW, an amazing piece of software which I used almost everywhere.

This project involved a lot of lab work, and a lot of custom-built equipment. I am very grateful to all of the technical staff who made things for me, lent me apparatus, and generally did things that were beyond the call of duty: Pat McGinness, Eric Duncan and the Energy Systems technicians, Donnie and Dino from DMEM, Bill Rooney and Bob Baird from the Department of Electrical Engineering, Alex Cairney from Dynamics and Control, and Jim Docherty.

I was also fortunate in that, when funds began to run out, I found a part-time job with an employer who understood the difficulties of juggling work and study, and made sure that I was able to carry on with my research. That job turned out to be very interesting and challenging in its own right. So thank you Ivan Andonovic, and everyone else at Kamelian Ltd., for keeping my cash flow healthy and giving me my first U.S. Patent.

Last but not least, I owe a debt of gratitude to my family, who gave me great moral support throughout this whole business, not to mention putting a roof over my head for some of the time.



Dedicated to the memory of my grandfather  
Ian Kitchener Colburn (1916-1972)  
Physicist and lover of knowledge

## ABSTRACT

Electrical power systems are currently moving towards distributed generation, using many small generators instead of a few large ones. This can potentially produce great improvements in efficiency, by allowing utilisation of waste heat (cogeneration). However, it also poses new problems of control and co-ordination of large numbers of generators, which may be connected deep within the distribution network. It is well known that existing schemes for planning, dispatching and protection of central generators are not directly applicable to the new technology, and dispatching (scheduling) of small embedded generators is not currently feasible.

In this work, a novel dispatching management system which may meet this requirement is proposed. Instead of using a single control centre, it distributes dispatching functions throughout the network. Some functions are performed by controllers and software agents built into the embedded generators themselves, and others handled by dispatcher software associated with a group of generators and loads. The dispatcher operates a small virtual market where energy can be traded between agents representing: generators, loads, network functions (AVR etc), and other dispatchers. This allows multiple dispatchers to be interconnected, so potentially dealing with very large numbers of generators.

To test this concept, some prototype agents, a basic dispatcher, and means of communication were created, in the form of programs on a desktop computer. The "REDMan" suite of software achieved successful trading of energy in a simulated environment. This motivated a more advanced trial where REDMan was developed further and used for experimental dispatching of real generating equipment and loads. Construction and assembly of the experimental apparatus, interfacing of hardware to the computer environment, experiments and results are presented and discussed here. The experimental system was dispatched in a satisfactory manner, and much practical experience was gained in the issues relating to dispatching of EG. Several possible avenues for further research were identified.

# CONTENTS

<b>Chapter 1: Preface</b> .....	<b>1</b>
<b>Chapter 2: Background</b> .....	<b>3</b>
<b>2.1. The use and waste of energy</b> .....	<b>3</b>
<b>2.2. Generation and transmission of electricity</b> .....	<b>6</b>
<b>2.3. The new idea: embedded generation</b> .....	<b>8</b>
<b>2.4. The technology of EG</b> .....	<b>9</b>
<b>2.5. Connecting EG to the grid</b> .....	<b>11</b>
<b>2.6. A look at dispatching</b> .....	<b>12</b>
2.6.1. Predicting demand.....	12
2.6.2. Coping with the unexpected.....	13
2.6.3. Economics.....	13
2.6.4. Renewables.....	13
<b>2.7. The future of dispatching</b> .....	<b>14</b>
2.7.1. Alternatives to classic dispatching.....	15
<b>2.8. Conclusions</b> .....	<b>16</b>
<b>2.9. References</b> .....	<b>16</b>
<b>Chapter 3: Power systems control</b> .....	<b>18</b>
<b>3.1. How does control apply to power systems?</b> .....	<b>18</b>
<b>3.2. Load frequency control</b> .....	<b>19</b>
3.2.1. Simple governor.....	19
3.2.2. Implementation in large networks.....	20
<b>3.3. Automatic voltage regulation</b> .....	<b>20</b>
3.3.1. Fundamentals.....	21
3.3.2. How AVR is set up.....	22
3.3.3. AVR considerations for EG.....	22
<b>3.4. Protection</b> .....	<b>23</b>
3.4.1. Types of protection equipment.....	23
3.4.2. Protection for EG.....	24
3.4.3. Anti-islanding protection.....	24
<b>3.5. Impact of EG on existing control systems</b> .....	<b>26</b>
<b>3.6. Economic dispatching</b> .....	<b>26</b>
3.6.1. Theory.....	26
3.6.2. Application to EG.....	28
<b>3.7. Stability</b> .....	<b>28</b>
3.7.1. What exactly is stability?.....	28

3.7.2. Classical stability studies.....	29
3.7.3. Application to EG systems.....	30
3.7.4. How will EG affect stability? .....	31
3.7.5. EG might improve stability.....	31
3.7.6. Or perhaps not.....	32
<b>3.8. Conclusions.....</b>	<b>33</b>
<b>3.9. References.....</b>	<b>34</b>
<b>Chapter 4: A new dispatching system proposed.....</b>	<b>36</b>
<b>4.1. Distributed dispatching.....</b>	<b>36</b>
4.1.1. Embedding LFC and AVR .....	36
4.1.2. Embedding ED.....	37
4.1.3. Embedding demand prediction.....	37
<b>4.2. Economic considerations.....</b>	<b>37</b>
<b>4.3. Three simple rules for dispatching .....</b>	<b>39</b>
4.3.1. The rules.....	39
4.3.2. Assumptions underlying the rules .....	40
<b>4.4. REDMan proposed.....</b>	<b>42</b>
4.4.1. Algorithm and communications .....	42
4.4.2. Timestepping considerations.....	47
4.4.3. Timestepping and commitment .....	47
4.4.4. Handling concurrency.....	48
<b>4.5. Proving the concept.....</b>	<b>48</b>
<b>4.6. Designing an experiment.....</b>	<b>50</b>
<b>4.7. Conclusions.....</b>	<b>50</b>
<b>Chapter 5: Developing the REDMan software.....</b>	<b>51</b>
<b>5.1. The dispatcher.....</b>	<b>51</b>
<b>5.2. Details of programming.....</b>	<b>54</b>
<b>5.3. Writing the program.....</b>	<b>54</b>
<b>5.4. Testing.....</b>	<b>55</b>
5.4.1. Worked example.....	56
5.4.2. Speed test.....	59
5.4.3. Speed test results.....	61
<b>5.5. Validation .....</b>	<b>61</b>
<b>5.6. Communications .....</b>	<b>62</b>
5.6.1. Ethernet networking.....	62
5.6.2. DSTP/DataSocket .....	63
5.6.3. Testing DSTP/DataSocket.....	64



5.6.4. Results.....	65
<b>5.7. REDMan comms routines.....</b>	<b>66</b>
5.7.1. Data items to be transferred.....	66
5.7.2. Allocating index numbers .....	67
5.7.3. Timing and synchronisation.....	68
5.7.4. Realisation of the system .....	68
5.7.5. Latency, quality of service, etc .....	69
5.7.6. Some sample agents.....	70
<b>5.8. Outcomes and conclusions .....</b>	<b>70</b>
<b>5.9. References.....</b>	<b>71</b>
<b>Chapter 6: Building a testbed.....</b>	<b>72</b>
<b>6.1. Grid-connected working.....</b>	<b>73</b>
<b>6.2. Generating plant.....</b>	<b>74</b>
6.2.1. Dispatching PV/wind energy.....	74
6.2.2. Using batteries.....	75
6.2.3. Inverters.....	76
<b>6.3. Considerations in setting up the system.....</b>	<b>76</b>
6.3.1. Choosing voltages and power levels.....	78
6.3.2. Measuring power flow.....	79
<b>6.4. Setup and commissioning.....</b>	<b>80</b>
6.4.1. Equipment list.....	80
6.4.2. Structure .....	81
6.4.3. Layout.....	83
6.4.4. Power wiring .....	83
6.4.5. Signal wiring .....	88
6.4.6. Testing .....	89
<b>6.5. Summary.....</b>	<b>89</b>
<b>6.6. References.....</b>	<b>90</b>
<b>Chapter 7: Agent software.....</b>	<b>91</b>
<b>7.1. A battery management agent.....</b>	<b>91</b>
7.1.1. Why batteries?.....	91
7.1.2. How lead-acid batteries work .....	92
7.1.3. Variation of capacity with discharge rate.....	92
7.1.4. Factors affecting battery voltage .....	94
7.1.5. Ageing and service life .....	94
7.1.6. Calculating energy content: not easy? .....	95
7.1.7. A simpler battery management model.....	95

7.1.8. Estimating capacity.....	96
7.1.9. Taking care of batteries.....	97
7.1.10. Using these ideas.....	98
7.1.11. A model for battery wear and tear.....	99
7.1.12. Practical implementation.....	101
7.1.13. Practical implementation.....	103
7.1.14. REDMan connection.....	107
7.1.15. Testing BatMan.....	107
<b>7.2. Inverter agent.....</b>	<b>109</b>
7.2.1. Design.....	109
7.2.2. Prototype.....	109
7.2.3. Calculating inverter efficiency.....	110
7.2.4. Simple fixed-price algorithms.....	110
7.2.5. Economic dispatch Mark One.....	111
7.2.6. Economic dispatch Mark Two.....	111
<b>7.3. Generator agent.....</b>	<b>113</b>
<b>7.4. Dump load agent.....</b>	<b>113</b>
7.4.1. Implementation.....	114
7.4.2. Performance.....	114
<b>7.5. Demand agent.....</b>	<b>116</b>
7.5.1. The original.....	116
7.5.2. Smart Socket.....	117
7.5.3. Prototype power-measuring agent.....	117
<b>7.6. Summary.....</b>	<b>121</b>
<b>7.7. References.....</b>	<b>121</b>
<b>Chapter 8: Experiments.....</b>	<b>123</b>
<b>8.1. Summary of development work so far.....</b>	<b>123</b>
8.1.1. Software.....	123
8.1.2. First hardware.....	124
8.1.3. Mark Two hardware.....	124
8.1.4. Mark Two software.....	124
<b>8.2. Experiment design.....</b>	<b>125</b>
<b>8.3. Testing dispatcher.....</b>	<b>126</b>
<b>8.4. Check agent programs/assumptions.....</b>	<b>127</b>
<b>8.5. Testing cost models.....</b>	<b>127</b>
8.5.1. Inverter cost model.....	128
8.5.2. Battery cost model.....	128
8.5.3. Interactions.....	128

8.6. <i>Examining multiple domains</i> .....	128
8.7. <i>Objectives of experiments</i> .....	129
8.8. <i>Summary</i> .....	129
<b>Chapter 9: Results of experiments</b> .....	<b>130</b>
9.1. <i>Test run for energy balance/transient</i> .....	130
9.2. <i>Energy balances</i> .....	132
9.3. <i>DAQ Hardware check</i> .....	133
9.4. <i>Inverter re-test</i> .....	135
9.5. <i>Transient behaviour</i> .....	137
9.5.1. Typical dispatching behaviour .....	137
9.5.2. Actual/dispatched power flows comparison .....	139
9.5.3. In search of missing energy.....	139
9.6. <i>Two-domain interaction</i> .....	142
9.7. <i>Summary</i> .....	142
9.8. <i>References</i> .....	143
<b>Chapter 10: Conclusions</b> .....	<b>144</b>
10.1. <i>Does it dispatch successfully?</i> .....	144
10.2. <i>Does it work economically?</i> .....	144
10.3. <i>Will it scale to large numbers?</i> .....	145
10.4. <i>Overall conclusions</i> .....	145
10.5. <i>Further work</i> .....	146
10.5.1. Hardware .....	146
10.5.2. Software issues .....	146
10.5.3. Marginal cost .....	146
10.5.4. Multi-domain issues.....	147
10.5.5. Concurrency and commitment handling.....	148
10.5.6. Penalties .....	148
10.5.7. Combined heat and power dispatching .....	149
10.5.8. New Electricity Trading Arrangements .....	149
10.5.9. Politics/economics/subsidies .....	149
10.5.10. Strategic barriers to implementation.....	150
10.6. <i>A final word</i> .....	151
<b>Appendix A: Building an inverter</b> .....	<b>153</b>
A.1. <i>What is an inverter?</i> .....	153
A.2. <i>Why build an inverter?</i> .....	153
A.3. <i>Design objectives</i> .....	154
A.4. <i>Specification</i> .....	155



<b>A.5.</b>	<b><i>Basic design choices</i></b> .....	<b>155</b>
A.5.1.	Switching technologies.....	156
A.5.2.	Circuit topologies.....	156
A.5.3.	Control algorithms .....	159
<b>A.6.</b>	<b><i>Simulation</i></b> .....	<b>161</b>
<b>A.7.</b>	<b><i>Practical design issues</i></b> .....	<b>161</b>
<b>A.8.</b>	<b><i>Control circuits</i></b> .....	<b>166</b>
A.8.1.	PWM generator .....	166
A.8.2.	Switching logic.....	166
A.8.3.	Drive circuits.....	170
A.8.4.	Reference generator .....	172
A.8.5.	Choosing a processor .....	173
A.8.6.	Firmware .....	174
A.8.7.	Support circuitry .....	174
<b>A.9.</b>	<b><i>Building and testing the Mark One</i></b> .....	<b>175</b>
<b>A.10.</b>	<b><i>Lessons learnt from Mark One</i></b> .....	<b>178</b>
A.10.1.	Odd spikes .....	178
A.10.2.	Excessive losses.....	178
A.10.3.	Too much distortion.....	178
A.10.4.	Latch-up .....	179
<b>A.11.</b>	<b><i>Mark Two</i></b> .....	<b>179</b>
A.11.1.	Loss budget.....	179
A.11.2.	Transistors.....	180
A.11.3.	Current sense resistor .....	180
A.11.4.	Wiring .....	180
A.11.5.	Transformer.....	180
A.11.6.	Filter components.....	182
<b>A.12.</b>	<b><i>Assembly and snagging</i></b> .....	<b>183</b>
<b>A.13.</b>	<b><i>Testing the Mark 2</i></b> .....	<b>188</b>
<b>A.14.</b>	<b><i>Lessons learnt from the Mark 2</i></b> .....	<b>191</b>
<b>A.15.</b>	<b><i>Protection</i></b> .....	<b>192</b>
<b>A.16.</b>	<b><i>Notes on firmware</i></b> .....	<b>193</b>
<b>A.17.</b>	<b><i>Flowchart</i></b> .....	<b>195</b>
<b>A.18.</b>	<b><i>Listing</i></b> .....	<b>196</b>
<b>A.19.</b>	<b><i>References</i></b> .....	<b>202</b>
<b>Appendix B:</b>	<b><i>A voltage-controlled dump load</i></b> .....	<b>204</b>
<b>B.1.</b>	<b><i>Design considerations</i></b> .....	<b>204</b>
<b>B.2.</b>	<b><i>Circuit</i></b> .....	<b>205</b>



<b>B.3.</b>	<b>Computer interface .....</b>	<b>206</b>
<b>B.4.</b>	<b>Construction.....</b>	<b>206</b>
<b>Appendix C: The “Smart Socket” .....</b>		<b>209</b>
<b>C.1.</b>	<b>Design considerations .....</b>	<b>209</b>
<b>C.2.</b>	<b>Interfacing.....</b>	<b>211</b>
<b>C.3.</b>	<b>Circuit description .....</b>	<b>211</b>
<b>Appendix D: Power measurement by soundcard .....</b>		<b>215</b>
<b>D.1.</b>	<b>Design considerations .....</b>	<b>216</b>
<b>D.2.</b>	<b>Hardware.....</b>	<b>216</b>
	D.2.1. Current transformer.....	216
	D.2.2. Voltage transformer .....	217
	D.2.3. Circuit.....	217
<b>D.3.</b>	<b>Software.....</b>	<b>217</b>
	D.3.1. Data gathering.....	217
	D.3.2. Analysis.....	218
<b>D.4.</b>	<b>Calibration and testing .....</b>	<b>218</b>
<b>D.5.</b>	<b>Conclusions.....</b>	<b>219</b>
<b>Appendix E: Modelling inverters in ESP-r .....</b>		<b>223</b>
<b>E.1.</b>	<b>About structure of ESP-r.....</b>	<b>223</b>
<b>E.2.</b>	<b>The power flow simulator (PFS).....</b>	<b>224</b>
<b>E.3.</b>	<b>Active connections .....</b>	<b>224</b>
<b>E.4.</b>	<b>Adding new power components.....</b>	<b>226</b>
<b>E.5.</b>	<b>Results .....</b>	<b>226</b>
<b>E.6.</b>	<b>Conclusions.....</b>	<b>228</b>
<b>E.7.</b>	<b>Acknowledgements .....</b>	<b>228</b>
<b>E.8.</b>	<b>References.....</b>	<b>228</b>
<b>Appendix F: Hybrid PV System Controller .....</b>		<b>229</b>
<b>F.1.</b>	<b>About the system .....</b>	<b>229</b>
<b>F.2.</b>	<b>Controller requirements .....</b>	<b>229</b>
<b>F.3.</b>	<b>Design considerations.....</b>	<b>229</b>
<b>F.4.</b>	<b>Theory of operation.....</b>	<b>230</b>
<b>F.5.</b>	<b>Circuit descriptions.....</b>	<b>230</b>
	F.5.1. Controller module .....	230
	F.5.2. Power supply/metering module .....	231
	F.5.3. System wiring .....	231
<b>F.6.</b>	<b>Modifications .....</b>	<b>232</b>

<b>Appendix G: How LabVIEW works.....</b>	<b>238</b>
<b>G.1. What is LabVIEW? .....</b>	<b>238</b>
<b>G.2. What is it used for?.....</b>	<b>238</b>
<b>G.3. Basics of LabVIEW programming .....</b>	<b>239</b>
<b>G.4. Data types.....</b>	<b>241</b>
<b>G.5. Conditional execution .....</b>	<b>241</b>
<b>G.6. Math functions .....</b>	<b>241</b>
<b>G.7. Multitasking .....</b>	<b>242</b>
<b>G.8. Modularity.....</b>	<b>242</b>
<b>G.9. Documenting LabVIEW programs.....</b>	<b>242</b>
<b>G.10. References.....</b>	<b>243</b>
<b>Appendix H: LabVIEW programs .....</b>	<b>244</b>
<b>H.1. The testbed software.....</b>	<b>244</b>
<b>H.2. Block diagrams (source) of selected Vis.....</b>	<b>246</b>
H.2.1. BatMan battery management (bm2.vi) .....	246
H.2.2. BatMan state-of-charge estimator (bmestimator.vi).....	251
H.2.3. Smart inverter management (invman7.vi).....	253
H.2.4. REDMan dispatching server (server3.vi).....	259
H.2.5. REDMan dispatching algorithm (matching15.vi).....	264

## Chapter 1: Preface

This Ph.D. started out with only a very general brief: To reduce the harmful effects of fossil fuel combustion. At the outset, this was easily mistaken for a technological problem, and it was tempting to believe that there was some kind of magic bullet to be discovered which would make engines and boilers more efficient, or which would make renewable energy sources so cheap, reliable, and tempting that it would not even be worth bothering with oil.

The first task undertaken was a literature review, trawling books, journals, and the Internet for background information. This gave cause for suspicion that the problem was of a different nature. There were many examples of new technologies, great improvements over the status quo in terms of combustion efficiency or harvesting of renewable energies, like biodiesel, the Coates engine, cogeneration, affordable electric drives for cars, and even the old-fashioned bicycle. The magic bullets were all ready and waiting. Why was nobody pulling the trigger?

Of course, energy use is not a technological problem at all, but a complex socio-political one. Reactionariness and fear of change are embedded into every society and institution, denial is a part of everyday life, and people will probably never drive electric cars because they don't make a revving noise. Large amounts of money are invested in maintenance of the status quo, short-term profit is pursued irrespective of long-term consequences, and there is nothing that engineering can do about any of this.

However, there did seem to be one or two small areas that might be susceptible to technological advances. Distributed generation was a recent, fairly radical concept in which large central electric power stations are replaced by large numbers of small generators. If these are sited carefully where heat is also demanded, perhaps in each domestic dwelling or public building, the waste heat inherent in electricity generation need not go to waste. With further study, it became apparent that this concept was missing one important component: a way of controlling all the small generators, synchronising them together so that they worked in harmony, keeping all the advantages of the old electrical grid. No record could be found in the public domain



of any work towards this objective, and so it seemed like a promising avenue for research.

The first step was to study the automatic generation control systems used in ordinary power networks. The tendency in these was for generation to be scheduled centrally, and it was obvious that this would never work with distributed generation, where a network might contain millions of units. If it was to be successful, the control system would have to be distributed too.

There are not many precedents for control systems of this kind. A rough analogy can be drawn with biological systems, e.g. plants and rudimentary animal life-forms. These all showed the same tradeoff: by forfeiting a centralised control, they became more robust, but sacrificed intelligence and functionality. According to this analogy, it seemed probable that some elements of traditional power networks would need to be sacrificed. But, it seemed hopeful that nothing much would be lost in the sacrifice, that much of the intelligence thrown away from the top might be reborn from the bottom up as an emergent property of the large, complex system made from the interconnection of many small ones.

With this in mind, an effort was made to abstract the automatic generation control/dispatching process to the simplest set of rules possible without actually making it useless. These rules were implemented in computer software, as modules which could be distributed over networked machines. The results were encouraging, and motivated the construction of a small renewable energy generating plant on which to test the new control system.

This pilot plant was a success, demonstrating desirable behaviour which would be impossible with existing EG control systems. However, there are still very many questions to be answered, and issues to be explored, before the “REDMan” system could see real-world applications. The work documented in this thesis is really just one drop, and it can only be hoped that future years, and the changing climates and priorities of the world, will bring on the ocean that distributed generation needs.

Stephen Conner

Glasgow, November 2002

## Chapter 2: Background

This chapter presents the findings of the initial literature review, by way of background. It looks at how energy is used, citing statistics on global energy production and consumption, with a view to finding out where energy is wasted, and whether this waste is avoidable. Out of various possibilities, cogeneration of heat and electricity is selected as a promising way of reducing energy waste, and investigated further. Problems which prevent the wider use of cogeneration are identified and explored in greater detail.

### **2.1. *The use and waste of energy***

As a rough estimate, the Earth's human population currently use 11.6 terawatts (tera= $10^{12}$ ) of all kinds of power in the course of their daily business [1]. Of this, approximately 3% comes from renewable sources, and 7% from nuclear power, but the remaining 90% is from fossil fuels. Estimates of the size of fossil reserves suggest that natural gas might run out in approximately 20 years, oil in 50-70 years, and coal in perhaps 200 years. From then on, nuclear and renewable energy will be the only options. As far as nuclear energy is concerned, the risks associated with radioactive waste, and nuclear plant accidents, are well known. The cost of providing safety measures against these risks, combined with adverse public opinion, has seriously hindered the nuclear industry. For example, [3] states that no new reactors have been ordered in the United States since 1979.

So, fossil fuels are running out, and nuclear energy is unlikely to step up to take their place. Therefore, future energy scenarios are likely to involve reducing demand, and increasing the amount of energy drawn from renewable sources. Reduction of demand will be considered first. An excellent way of doing this is reducing waste of energy, so it is logical to ask the question: Where do the greatest wastes of energy take place? Detailed studies [e.g. 1, 2] have been made of energy use patterns, and some representative figures\* are presented here.

---

\* These figures are average power flows over a one-year period.



Of the 11.6TW consumed as primary fuels:

5 TW (43%) is used in electricity generation, which is approximately 35% efficient, so 1.75 TW of electricity is the result.[1]

4.2 TW (36%) is used for heating of buildings, domestic hot water, and industrial processes [2]

1.9TW (16%) goes to transportation of people and goods. [2] The vast majority of this is of fossil origin. Motor vehicle engines convert about 20% of the fuel energy into mechanical work.

Of course, the question of what proportion of this energy is actually wasted is a difficult one. In transportation, for example, not all journeys are necessary. In heating, the insulation of buildings can always be made better. And, there are many uses of electricity which might not be considered indispensable. Finding answers to these questions would require a detour into politics, economics, and the social sciences. But, from an engineering perspective, it is obvious that a lot of energy is being wasted in electricity generation and transport. Unfortunately, this is for a fundamental reason.

All engines which convert heat to mechanical work, whether they be petrol engines in cars, or steam turbines in electric power stations, have a theoretical maximum efficiency imposed by the Second Law of thermodynamics. The theory behind this is well known, and will not be repeated in detail here. Suffice it to say that in a vapour-cycle heat engine the theoretical limit is the Carnot efficiency:

$$\eta = 1 - \frac{t_l}{t_h}$$

(Eq 2.1)

In modern thermal power stations, the materials used will stand source temperatures of around 800 K, and by rejecting heat straight to ambient, a sink temperature of around 300 K is possible. This equates to a Carnot efficiency of 63%. Of course, as any text on thermodynamics will tell, the Carnot efficiency can only be attained if all heat transfers in the cycle are reversible, which means that they must take place across zero temperature difference, and therefore be infinitely slow, and hence

useless. In practice, irreversibility caused by heat transfer across finite temperature differences, mechanical friction, etc. reduces the conversion efficiency to 35-40%. For example, [5] quotes a mean efficiency of 37% for power stations in the UK.

With regard to transport, internal-combustion engines are somewhat different; their theoretical benchmark is the air-cycle efficiency, which is a function of the compression ratio  $r$ .

$$\eta = 1 - \left(\frac{1}{r}\right)^{\gamma-1}$$

(Eq. 2.2)

State-of-the-art engines currently have compression ratios of between 8 and 16, which give air-cycle efficiencies of 56% and 67% (assuming  $\gamma=1.4$  for air) respectively. Again, though, in real life the best IC engines are about 40% efficient [4] when operated at their optimum speed and load. In transport applications, the widely-varying speed and load reduce the overall efficiency even further.

The point of quoting all these statistics is to suggest that, as regards improving the efficiency of heat engines, it may be a case of diminishing returns. If, by some feat of materials science, the absolute source temperature in a contemporary generating plant could be doubled without melting anything, the Carnot efficiency would only increase by 29%, which would probably mean at most a 16% increase in the actual efficiency. That 16% would probably be bought at an enormous cost in terms of elaborate materials, advanced design, and reduced reliability.

Another possibility might be to keep temperatures constant, but make up the shortfall between the Second Law efficiency and real-life efficiency, by reducing irreversibility. There are a number of innovative technologies, such as combined-cycle gas turbine plant, and bottoming cycles for steam plant, which are used to boost efficiency in this way. The fundamental principle is to use several real cycles in order to approximate the ideal cycle more closely. Unfortunately, the law of diminishing returns holds true here too. Adding one bottoming cycle might half the shortfall in efficiency, but to achieve the full Second Law efficiency would require an infinite number of cycles. Therefore, the degree of improvement is again limited by economic and technical considerations.



The one unchallenged assumption in all of this is that the heat rejected from a heat engine is wasted. This is easy to overlook, because in contemporary power-plant design, the heat is rejected at the very lowest temperature possible for efficiency's sake, and this makes it of no practical use. Deliberately raising the rejection temperature a little opens up a number of new applications for this "waste" heat, for example space heating, domestic hot water, and industrial process steam. This may seem like anathema because it makes the conversion to work less efficient, but really it does not matter any more; considering the rejected heat as a useful output, the actual efficiency of the system becomes 85-90% [4]. The old 'efficiency' now just determines the heat-to-power ratio. This concept is known as cogeneration, or combined heat and power (CHP). It promises to yield much greater gains in efficiency than any of the improvements to conventional heat engines discussed previously.

Cogeneration schemes like these could obviously save a great deal of energy if they were widely used, but this is unfortunately not the case: at the moment in Britain a mere 6 % [5] of UK electricity comes from CHP plants. The reason for this neglect is that there is a serious problem with large-scale use of CHP. The problem is intimately connected with the way in which electricity is generated and used.

## **2.2. *Generation and transmission of electricity***

Currently, electricity is generated in large power plants situated some distance from the point of demand. This system of 'centralised generation' dates from the late 19<sup>th</sup> century. All electrical equipment of that era used direct current of low voltage, which could not be transmitted more than a few miles without incurring excessive losses in the conductors, or using very thick and costly conductors. The solution was to build a small coal-fired generating plant on every city block, which was inconvenient, inefficient, and expensive. Soon, better ways of transmitting power were invented\*, to help in the exploitation of hydro-electric resources. This economical long-distance power transmission brought in a massive expansion of electricity supplies, and

---

\* The three-phase high-voltage AC transmission system was first used in 1891 and still exists in essentially the same form today.



allowed generating stations to be made as large as technically possible in order to gain economies of scale. This trend of increasing size and centralisation has persisted until the present day.

At present, in a country such as Britain, hundreds of generating stations, mostly sized between 100MW and 1GW, feed three-phase AC power into a 'national grid' of high-voltage (275-400kV) transmission lines which interconnect generators, switching stations, and demand centres. The grid system provides redundancy, so that if lines or generators fail, power can be quickly re-routed from elsewhere. The sheer scale of this system is impressive; for example, the UK's national grid handles approximately 327TWh of energy per year, through more than 7,000 km of transmission lines [6].

This may seem very impressive, but just because something is successful does not mean that it is perfect, and it is now acknowledged that centralised generation has one major drawback: It makes CHP almost impossible. This is because electricity can be transmitted easily over hundreds of miles; but there is no comparable system for transmitting low-grade heat from the place where it is generated to the points of demand.

This is not its only failing, though; centralised generation can also have an effect on reliability. If generation is concentrated in a few large units, then the failure of one of these units will have a greater impact on the network. To protect against this, network planners use 'spinning reserve'. A power plant (or plants) of total capacity equal to the largest single plant in use is kept idling and ready to pick up the load immediately. This protects against the failure of any single generating plant, but at a cost; even though this spinning reserve does not produce any power, it still uses fuel to make up its thermal and mechanical losses.

Centralised generation also means increased losses; although the transmission system is very efficient, it is not perfect. For example, [6] claims 1.7% losses for the UK National Grid transmission system. However, due to the enormous amounts of electricity being transmitted, this represents a large loss in absolute terms, in this case approximately 635 MW. This figure varies according to network configuration, and

does not include distribution losses, which are more difficult to measure, but are probably of a similar magnitude or even larger.

### **2.3. *The new idea: embedded generation***

Fortunately, there is a new way of organising the electrical network. Instead of having a few large generating stations, electricity generation can be subdivided into smaller units spread throughout the network. This is known as distributed generation. In the specific case where an effort is made to site generators as close as possible to centres of demand, in such a way that buildings might almost be thought of as generating their own power, it is termed embedded generation (EG).

This approach promises to solve many of the problems discussed previously. Firstly, it makes CHP practical. Individual generators can be sited right at centres of heat demand, so there is no problem with transmission. CHP benefits from smaller scale, since the heat rejection temperature of each individual generator can then be tuned to suit the process requirements: e.g. 50 °C for hot water, 150 °C for industrial steam.

And, if these small generators are connected with the existing electrical network, there could be a reliability benefit due to the redundancy of multiple power sources. This is a contentious point of view, though, which will be examined at greater length in a later section.

Distributed generation can also help exploitation of renewable energy (RE). Important forms of RE, such as wind and solar power, are diffuse by nature. They can only be captured in large quantities by using a large number of distributed small generators, covering a large area. It may be possible to embed large numbers of RE generators in/on existing buildings and structures.

Finally, electrical transmission losses are greatly reduced, since the electricity is not transmitted over any appreciable distance. For non-renewable sources, though, this advantage is perhaps not as great as it seems, since some other fuel must be transmitted instead. Transporting the fuel to the generator location uses energy too, and this can be thought of as a transmission loss.



## **2.4. The technology of EG**

Really, EG is just a return to Edison's 'powerhouse on every block' system which was abandoned 100 years ago. It may well become attractive again because of improvements in small generator technology, and the efficiency improvements promised by cogeneration. Small/medium heat engines suitable for cogeneration have seen many advances: Pollution, reliability and noise control have been improved, by borrowing technologies from automobile and aero-engine design. Microprocessor control allows generators to operate automatically without supervision. High-temperature ceramics and alloys together with computer-aided design have increased the efficiency of smaller heat engines. Examples of these modern heat engine technologies are: microturbines [7, 8] and IC engines [4]. These are popular for cogeneration or backup power in the industrial and commercial sectors. [9]

Renewable energy has seen improvements too. For instance, the cost of photovoltaic modules has fallen steadily, as shown in fig. 2.1. Wind turbines have also become more cost-effective, although it is harder to quantify prices in this case, because of the variable nature of output [10]. Some renewable generators have also been designed specifically for embedded generation, for example ducted wind turbines which are an integral part of the building façade [11]. However, these are currently at the experimental stage.

At present, renewable electricity is mostly uneconomic compared to fossil fuel-generated electricity, hence such large PV and wind installations as there are mainly exist because of government subsidies. However, wind power is rapidly becoming competitive, and other forms of RE are expected to play an increasing part in the long term, as fossil fuels become more expensive.

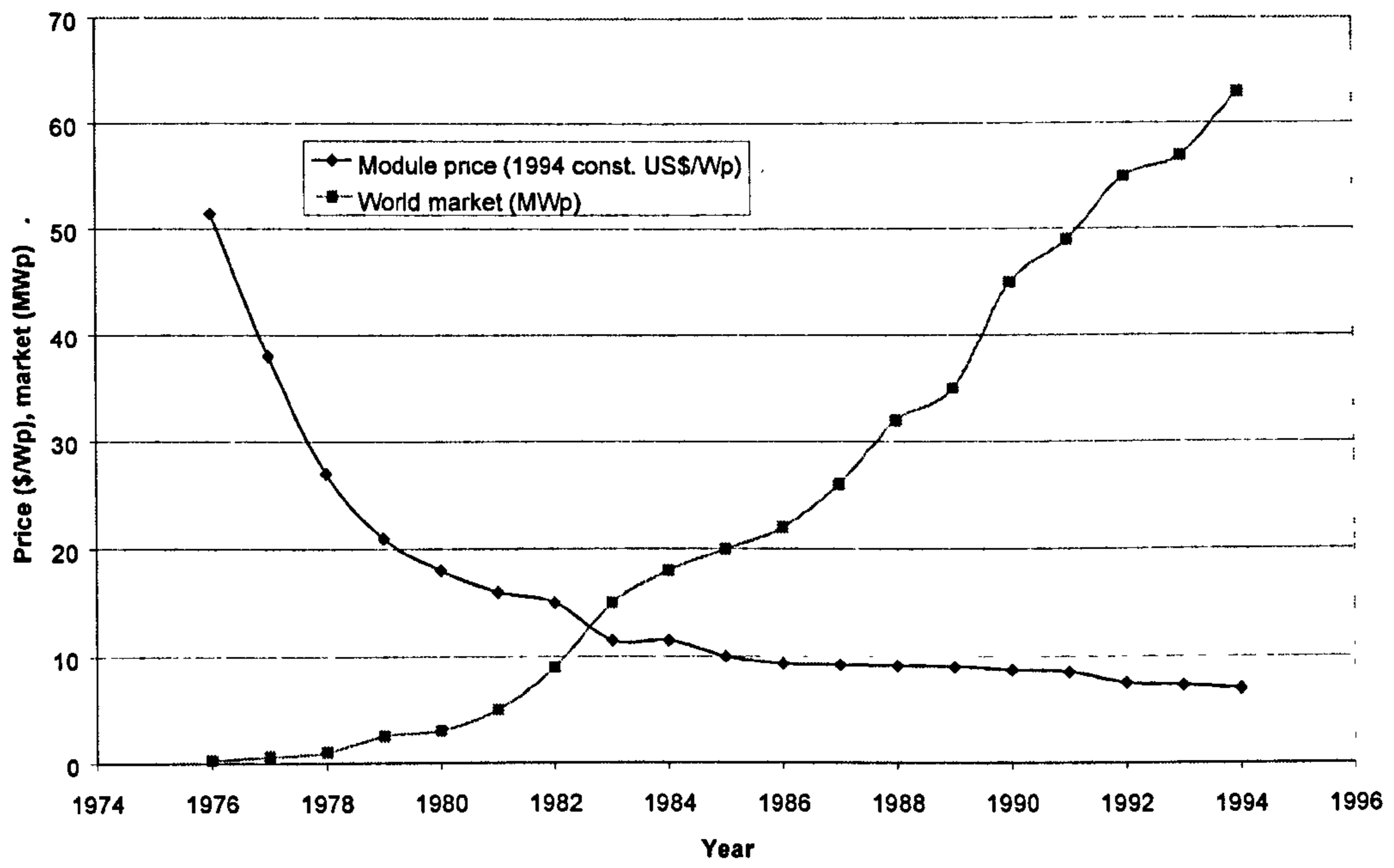

(Fig. 2.1: Price trend of PV, 1976-1994, reproduced from [12])

## **2.5. Connecting EG to the grid**

The main problem lies in using EG alongside the existing electrical grid with its centralised generators. While there is no fundamental reason why EG systems need to be connected to the grid at all, there are advantages to doing so. Firstly, by connecting multiple generators together to form a network, the reliability of the supply might be improved due to redundancy. For the same reasons, it is also very attractive to be able to combine the EG output with the existing grid. There are also economic benefits: the efficiency of a generator is usually a function of its power output, and so it is usually possible to calculate an optimum power for each generator in a network in order to achieve the best overall efficiency. In a similar manner, networking will make CHP more efficient, by making allowance for customers' heat demands as well. For example, if a customer with an embedded CHP plant has a sudden large demand for heat, he can increase the output of his CHP plant, but then he will find himself with surplus electricity. If his plant is connected to the grid, it should be possible to sell this electricity to another customer.

But, it is also possible that as the network is made bigger, it will become more complex, and the scope for error will increase too. As the system gets larger, the dynamics get harder and harder to model. It would be almost impossible to predict the transient performance, stability, response to faults, etc. of a network with hundreds of thousands of embedded generators. Therefore, power companies and EG manufacturers show a reluctance to move in this direction. There seems to be a great lack of work on understanding the issues involved.

Managing an electrical grid is rather like commodity trading, but fraught with difficulties because, unlike other everyday commodities, electrical energy is difficult to store in any significant amount. Even when converted to another form of energy, the possibilities for storage are limited, and some energy is always lost in the conversion. Therefore, in practice, the supply must be continuously adjusted to match the demand, and it must be done quickly, because the network does not have much of an energy reserve. The only inherent energy storage is the rotating inertia of the generators themselves, and any mismatch between supply and demand will therefore alter the speed of the generators, and hence the frequency of the alternating



current. So, the first type of management required is load frequency control (LFC) which adjusts the mechanical power driving the generators to hold the supply frequency constant. Alongside this is economic dispatching (ED) which aims to share out the total demand amongst the generators in such a way that they operate at the best overall efficiency.

These jobs are collectively known as ‘dispatching’, and this will be the main challenge that this hypothetical EG network will face: reconciling the traditional methods of dispatching, developed on networks with a few large generating stations, with the new requirements of EG. There seems to be no real idea of how to accomplish this. As a source of inspiration, though, it may be instructive to examine the way in which dispatching is currently done.

## **2.6. A look at dispatching**

Dispatching was originally performed by a combination of simple automatic controls, and people in a national control room, in contact with generating stations by telephone. Human dispatchers have since been superseded by computerised automatic generation control, but the objectives are still the same, and can be seen as consisting of three fundamental parts; predicting demand, coping with unexpected demand, and trying to reach an economic optimum.

### **2.6.1. Predicting demand**

The demand for electricity in each half-hour period of the day is forecast one day in advance. This is possible because there are daily and seasonal patterns in the demand, related to working hours, mealtimes, television programming, and seasonal heating/lighting requirements.

This system is satisfactory at present, but it should be borne in mind that the patterns are predictable because they are the mean of the activities of a large number of consumers. It is possible that, as the sample group is made smaller, as in a hypothetical scenario where dispatching is distributed, its behaviour may become more random, and prediction accordingly more difficult.

### 2.6.2. Coping with the unexpected

Prediction is never perfect, so there will always be some differences between predicted and actual demand. Because of the size of a national grid system, these tend to develop relatively slowly, and are not usually a problem. For example, if demand begins to exceed supply, the angular momentum of the rotating machines will make up the extra power. Therefore, the generator speed, and hence frequency, of the whole network will begin to decrease. As this happens, automatic control systems will ramp up the mechanical power input to restore the frequency. Different types of power plant vary in how quickly they can respond. So, operating within these constraints, the dispatcher has to make sure that there is always enough plant online, with enough spare capacity, and the capability to modulate its output quickly enough, to deal with these unforeseen demand changes.

Of course, this assumes that the system is working properly. If there is a sudden, violent disturbance, such as a fault, transient effects come in to play, and the effect can be much more serious. Transient analysis of networks is a whole other subject, though, and quite beyond the scope of this thesis.

### 2.6.3. Economics

Almost every type of generating plant is most efficient when operating at full power. Part-load efficiencies are often very poor. Therefore, dispatching is also concerned with maximising 'utilisation'. Put simply, out of all the generators in operation, as many as possible should be operated at maximum efficiency, which normally means fully loaded. This is in conflict with the requirement for reserve capacity, and so a trade-off has to be reached. The exact nature of this trade-off is a complicated issue, because it sets the benefit due to quality of supply against the cost due to operating the reserve capacity. In the UK, with its proud tradition of a nationalised electricity industry where profit was less of an issue than quality of service, the value of a dependable electricity supply is probably perceived to be quite high.

### 2.6.4. Renewables

When renewable energy is added to the supply pool, it causes new problems. The main problem is that the most popular forms of renewable energy (hydro, solar and



wind power) are subject to the weather. Therefore, it is hard to predict exactly how much will be available. This is really the same problem as coping with unexpected demands, except in mirror-image. Wise design and siting of the renewable system can help. At many sites in Scotland and Wales, for instance, wind and water are relatively reliable and plentiful resources. Similarly, in areas like the south-western US, sunshine is practically guaranteed most of the year. Also, the weather-related behaviour of renewable sources often coincides with weather-related demand. For example, in places like California, with sub-tropical climates, the output from solar PV matches the demand from air-conditioning nicely. Similarly, in countries such as Scotland, wind power increases in winter, in line with the increased heating and lighting demand. What is more, modern weather forecasting is often reliable enough that the output of wind/solar/hydro generating schemes can be predicted. However, the vagaries of the weather mean that the problem can never be eliminated entirely, and it is fairly certain that networks including large amounts of renewable generation will need to cope with more extreme and unpredictable variations in supply, either by using more reserve capacity, or by having some means of storing energy when there is a surplus and releasing it when there is a shortfall [13]. Management of storage systems like these would also fall under the remit of dispatching.

### ***2.7. The future of dispatching***

The main problem with current dispatching schemes, as described previously, is that present algorithms are based on taking information about every generator in the network back to a single control centre, calculating optimal setpoints for all the generators, and then sending this information back. This is feasible in current networks with 10-100 generating units, but in a future scenario with perhaps millions of small embedded generators, it may well be impractical. For example, consider the scenario where one in five UK households has replaced their domestic heating boiler with a small grid-connected CHP unit. Instead of 100 generators, the control centre has to deal with 5,000,000. Data flow to and from the control centre will increase by four orders of magnitude, but the worst is yet to come. The amount of computing power required to run the control algorithms is typically proportional to the square of the problem size, if not some higher power. Therefore, the computing power required



will increase by at least eight orders of magnitude. To put this in perspective, by Moore's Law (which states that the power of computers doubles every 18 months) it is around 40 years' worth of development.

Of course, it might well be possible to manage such large amounts of data successfully. But, objections can still be raised to the general concept of collecting all data together to a central executive. The chief objection is that it represents a serious reliability issue. If the control centre broke down, the whole network would be rendered useless. So, it is a weak link in a system that should be strengthened by redundancy. Also, because of its greatly increased complexity, the proposed control centre might be more likely to break down than present-day systems.

Unfortunately, as may be seen in the following section, there do not seem to be any more workable alternatives to this system at present.

### 2.7.1. Alternatives to classic dispatching

This section is based on a review of various EG systems currently available on the market. The manufacturers' published data, for example [7, 8], suggest that when designing their systems they make one of two simplifying assumptions:

1. The generator is designed to be the sole source of power. It is governed so that it supplies the correct amount of power to keep the terminal voltage and frequency within limits. These 'standalone' generators are simply not designed for connection to a grid; their output appears as a voltage source of low impedance, making power flow into the network unstable and very difficult to regulate.
2. The generator is designed for network connection, but the decision of how much power to generate at a given moment is left up to the end user, thus sidestepping the dispatching problem completely. These 'dumb' generators will typically not work unless they are connected to a large, stable electrical network.

NB: Some generators e.g. [8] can operate under either of the above modes, the selection being made by the user.

A large-scale deployment of standalone generators would be inadvisable, to say the least. An EG system made entirely of these, each feeding its own demand centre, would throw away all the advantages of a grid. It would be very inflexible; if a

demand centre required more power than its generator could supply, the only solution would be to buy a bigger one. Utilisation would be very poor too; the generators would have to be sized to supply the peak demand, and in most cases the mean demand is much less.

Connecting large amounts of dumb EG to the existing network would be equally unwise, because it would lack any form of dispatching. There would be no guarantee that supply would equal demand.

## **2.8. Conclusions**

By reviewing the way in which electricity generation works at present, it was seen that relatively large improvements in efficiency could be made by aggressive use of CHP. But, to make CHP work, embedded generation is essential. There is reason to believe that the full benefits of EG will not be realised unless it is network-connected, and suitably dispatched to ensure stability and good economic use. Unfortunately, it seems that the dispatching system presently used to control large centralised power plants will not be practical for millions of small generators, nor will the controls fitted to present-day EG solutions. Much work has been done on the technical and economic implications of EG, and the need for a new kind of dispatching system has been recognised [14], but there is no evidence of anyone having investigated ways of making such a system. The objective of this project is to do just that, but before producing any new ideas, a more detailed review of power systems control is called for. This is presented in the next chapter.

## **2.9. References**

1. 'BP Global Statistical Review of World Energy', 2001, <http://www.bp.com/>
2. 'World Energy Prospects to 2020', International Energy Agency, 2001, <http://www.iea.org/>
3. 'Nuclear Generating Units 1953-2001', Energy Information Agency, USA, 2003. <http://www.eia.doe.gov/>
4. 'Cogeneration with Gas Engines', Jenbacher Energy AG., 2003, <http://www.jenbacher.com/>



5. 'Digest of United Kingdom Energy Statistics 2001', Department of Trade and Industry, <http://www.dti.gov.uk/>, p.168.
6. 'Seven Year Statement', National Grid plc., 2002, <http://www.nationalgrid.com/>
7. On-line literature from Capstone Turbine Corporation, 2002, <http://www.capstone.com/>
8. Bowman Power Systems, 2002, <http://www.bowmanpower.com/>
9. 'U.S. Cogeneration: Beyond reduction of pollution', Cogeneration and On-Site Power Production, Vol. 1, No. 3. May-June 2000, pp. 25-33.
10. 'Wind Energy – The Facts: Volume 2, Costs, prices and values', European Wind Energy Association, 1997, p. 56. Online at <http://www.ewca.org/>, 2003
11. 'A hybrid PV/wind energy module for integration in buildings', Proc. 16<sup>th</sup> European Solar Photovoltaic Energy Conference, Glasgow, May 2000.
12. 'Eco-restructuring: Implications for sustainable development', ed. Ayres, R.U., United Nations University Press, 1998. Online at <http://www.unu.edu/>, 2003
13. "Wind on the System: Grid integration of wind power", Renewable Energy World, Vol. 3, No. 2, March/April 2000, pp. 61-71.
14. 'Embedded Generation', Jenkins, N. *et al.*, IEE, London, 2000, p. 259.

## **Chapter 3: Power systems control**

The need has been identified for a dispatching system that can control large numbers of electrical generators without being excessively complicated. In order to have a better idea of the requirements inherent in such a system, it will be wise to review the control engineering aspects of power systems, to get a good impression of the issues involved. This section is a brief review of power systems control; the techniques used, the issues involved, and the technologies employed, with a particular bias towards embedded generation. The reader is assumed to be familiar with some fundamental concepts of control engineering itself, such as feedback and stability. (See e.g. [1])

### ***3.1. How does control apply to power systems?***

Control engineering is fundamentally concerned with applying a self-correcting or self-regulating tendency to systems that do not naturally have such a tendency. This concept is applied in many ways throughout the whole electrical power field. However, in the sense of interest at present, power systems control essentially means keeping voltage and frequency within acceptable limits for the consumer, while operating the generating plant and transmission systems as efficiently and safely as possible. This task can become very complicated in a large electrical network with multiple generating stations, each with its own economic and dynamic behaviour, connected together by a grid which has losses and constraints on possible power flows. Multiple different control systems must work together without any negative interactions arising. The functions performed by these control systems can be grouped under a few very broad headings:

- Frequency control, also known as load frequency control (LFC).
- Automatic voltage regulation (AVR)
- Protection
- Economic dispatching (ED)



LFC is the system or systems that tries to keep the frequency of the supply constant. It does this by increasing or decreasing the real power output from generators. AVR, as the name suggests, tries to keep the voltage constant, or at least within limits for all consumers. This may be done by tap-changing transformers which step the voltage up or down slightly as required, or by devices which produce or consume reactive power. Protection ensures that no component is overloaded to an unsafe extent, by actuating circuit breakers in the event of a fault or overload. Lastly, ED tries to ensure that all plant is operating as efficiently as possible.

These systems are often analysed in isolation, e.g. the protection system is studied separately from all others. See [2] for examples. However, a little consideration of the matter may give reason to believe that the various control systems interact. These interactions are intentionally minimised in current power systems, but may become more significant in EG systems. How this will happen is only beginning to be studied (see e.g.[3]).

### **3.2. Load frequency control**

This is the most basic form of control in power systems. The idea behind it was hinted at in the previous section, and can be restated in more detail here. Supply of electricity must always equal demand. In an alternating current system, the frequency of the AC is an indication of how good the supply/demand match really is. If demand is greater than supply, the generators will begin to slow down and the frequency will fall, etc. LFC senses any deviation from the nominal value of frequency, and changes the mechanical power input to the generators, thus changing the real power injection to the network, in order to restore the frequency to what it should be.

#### **3.2.1. Simple governor**

The simplest form of frequency control, where rotating generators are involved, is to equip the engine/turbine (prime mover) with a governor that adjusts the fuel supply to hold the rotating speed constant. This is the norm for many smaller types of generator. However, in modern large National Grid-type networks, the scheme is rather more complex.

### 3.2.2. Implementation in large networks

A large grid will have many different generating plants, of different kinds. Some are capable of changing their power output quickly for LFC purposes, some are more sluggish to respond, and some, for instance renewable energy plant, cannot be controlled at all because they are determined by the amount of sun, wind, etc. present at that time. This limitation can be dealt with as follows: All the generators are connected together, therefore (within limits imposed by the configuration of the network) it does not matter physically where the injection of real power needed for frequency control comes from. In fact, the plant best suited to frequency control duties might change on a daily or hourly basis. To make full use of this flexibility, the modern trend is to schedule all generation on a minute-by-minute basis, via commands sent from a grid control centre [4]. This is done by advanced computer algorithms, which combine load-following control and economic dispatching. The ED component calculates how the demand should be shared out amongst the available generators, taking into account the reserves required for LFC. Large networks are divided into areas, each containing one or more generators plus some demand, and the ED algorithm also calculates how much power should be exchanged between areas (tie-line power flow). The LFC algorithm combines frequency error and tie-line power flow error in a given area to give a quantity known as the Area Control Error (ACE). A controller algorithm is used to adjust the output of the generator(s) in that area, in order to regulate the ACE to zero. Many different ways of deriving the ACE, and many different control algorithms, such as ordinary P-I-D, fuzzy logic, etc. are described in the literature. (e.g. [5, 6])

### 3.3. *Automatic voltage regulation*

The frequency of alternating current is the same everywhere in the grid, but not so voltage, which varies from place to place. Transformers step it up and down, and the resistances and reactances of cables and lines cause the voltage to drop, or sometimes even to rise, depending on the current passing. The purpose of AVR is to make sure that every consumer gets a voltage within the statutory limits at all times.



### 3.3.1. Fundamentals

AVR systems are fundamentally the same as any other control system. The voltage at a point in the network is measured, compared to a desired value, and the error signal actuates some kind of voltage-adjusting device in such a way as to extinguish the error. There are a few different types of voltage-adjusting device. One very widely-used type is the tap-changing transformer. This is like an ordinary distribution transformer, but has a high-speed switch mechanism that changes the tapping point on one or other of the windings according to the instructions of the AVR system [7, 8].

Another way of adjusting the voltage is by reactive power compensation [9]. This works because transmission lines, transformers, etc. have an inductive component. The inductive reactance of the system is usually much larger than the resistance and so is responsible for most of the voltage drop. Therefore, connecting a capacitive load can reduce the voltage drop, eliminate it completely, or even raise the voltage above normal. Capacitors may be permanently installed, or switchable under control of an AVR system. Another possibility is to use a synchronous motor, since these have the ability to generate or absorb reactive power as required. This may also perform mechanical work, or it may be installed purely for power compensation, in which case it is called a synchronous condenser. The synchronous generators used in most large generating stations also have the same ability. Recently, power electronic technology allowed the creation of the static compensator (STATCOM) which performs the same function as the synchronous condenser, but without moving parts [10]. Modern STATCOM/active filter systems are also capable of advanced functions such as reducing harmonic distortion [11, 18].

Of course, reactive power compensation assumes that the network impedance is mostly reactive. This may not always be the case, particularly in the distribution network, which uses lower voltages (hence more resistive losses) and can have a predominance of underground cables, which are not inductive but capacitive. Under these conditions, reactive power compensation is less effective.

### 3.3.2. How AVR is set up

In an ideal world, the voltage would be regulated so closely that every consumer received exactly the nominal voltage. This is not practical, so compromises have to be made. The voltages in the HV transmission system are regulated by reactive power compensation, performed by generators and sometimes synchronous condensers or capacitors. The aim here is as much to reduce losses by improving power factor, as it is to keep the voltage constant. Large generating stations may have an AVR system which controls the reactive power generation according to network voltage [12] or alternatively the generation of reactive power may be scheduled centrally. Indeed, a combination of the two is sometimes used, where individual generators have their own AVR and LFC setpoints, which in turn are controlled by central scheduling.

At the lower voltages used in the distribution system, tap-changing transformers are preferred. There are so many of these that central control is not practical, therefore they are normally controlled by their own local AVR, which is set so that the voltage at the far end of the feeder never drops below the minimum acceptable. The AVR may hold a constant voltage, or it may droop to allow current sharing between paralleled transformers, or it may even have compounding which makes the voltage rise as the current demand increases, to compensate for drop in the feeder. Finally, in the furthest reaches of the distribution system, the transformers have no taps at all, or taps selected by hand in a “set and forget” style.

### 3.3.3. AVR considerations for EG

Most embedded generation plant presently does not participate in AVR. This is for a few reasons. Firstly, individual embedded generators are normally too small to have any significant effect on network voltage. Of course there are some large EG units, and it could also be argued that a lot of small generators could have the same aggregate effect as a large unit. However, realising this would require some sort of management system to make all the generators work together. This has been proposed (see 3.5 below) but never tested. Secondly, some kinds of EG plant use induction generators and so cannot perform reactive power compensation. This may not be a great problem, since reactive power compensation is less effective deep in



the distribution network anyway [21]. On the other hand, there are other EG types (such as PV, microturbines, and variable-speed wind turbines) that incorporate a power electronic interface (inverter). This can simultaneously be used as a static compensator for AVR purposes [22].

### **3.4. Protection**

Protection may be thought of as a control system too. It monitors the operation of power system components such as lines, transformers and generators, and takes action if the component is in a potentially dangerous state. That action is normally the opening of a circuit breaker, which removes power completely from the component. The goal of protection is to isolate faulty equipment as quickly as possible, with minimal disruption to the supply of electricity, and minimal impact on the stability (see 3.7 below) of the system.

#### **3.4.1. Types of protection equipment**

The most basic item of protection equipment is a fuse. Fuses provide simple and reliable overcurrent protection, with a choice of response characteristics. However, fuses are not suitable for many applications, because they require replacement by hand before the power can be restored, amongst other reasons. Where this is a problem, it is preferable to use a more complex system comprising protection relays and circuit breakers. The protection relays are measurement devices which monitor current, voltage, frequency, etc. When the measured value is outwith the set limits, the protection relay sends a signal to the circuit breaker causing it to open. This system offers greater flexibility: many different types of protection relays are available e.g. earth leakage, phase imbalance, differential current, and several can be wired together to operate one circuit breaker. Another very important feature is that the breaker can be programmed to reclose by itself. Faults are often momentary in nature, e.g. a lightning strike on overhead lines causing an arc to start. In cases like these, opening the breaker clears the fault, and when it recloses, the system resumes normal operation. If the fault did not clear, then the breaker will trip out again as soon as it recloses, and after a few unsuccessful reclosing attempts, it will normally trip out for good.

### 3.4.2. Protection for EG

Embedded generation has mostly the same protection systems as normal generating plant, but with a few additional requirements. The first issue is that EG units of small size, using synchronous or induction generators, cannot contribute much fault current in the case of a fault on the distribution network. Sometimes the fault current is not much more than the full-load current, or even possibly less. Nevertheless, it could still hinder clearance of a fault, and so the distribution network must be protected from it. Overcurrent protection on the EG unit itself cannot do this, though, because the fault current flowing from the EG is too small. In this scenario, the fault will trip protection elsewhere in the system, and isolate the section containing the fault and EG unit. The EG will then hopefully trip out on over/undervoltage or other protection [13]. If it did not trip, however, a power island might be the result.

### 3.4.3. Anti-islanding protection

If a part of the electrical network becomes separated from the rest due to a fault, and it contains embedded generation, it might continue to function independently. Power companies believe this to be unacceptable for three reasons; firstly, it would endanger any personnel sent to repair the fault, secondly, the island would drift out of phase with the rest of the network and it would be impossible to reconnect it without causing a catastrophic transient, and thirdly, the power quality in the island could not be guaranteed. On these grounds, they claim that the only safe way of managing islanding is to forbid it; islands must be made deliberately unstable so that they trip themselves out within a few seconds.

Unfortunately, these anti-islanding methods are exactly the opposite of what is required for good network stability. For instance, if the frequency begins to collapse, the grid needs a big injection of real power as quickly as possible. Instead, the rate-of-change-of-frequency (ROCOF) protection systems commonly used with EG are likely to trip out the embedded generators, which will take more real power away and simply aggravate the collapse. A similar objection can be levelled at the SFS/SVS anti-islanding algorithms for power electronic inverters [14]. Heavy penetration of EG systems with this kind of anti-islanding protection would probably have disastrous effects on network stability. So, it seems that if EG is to achieve



significant penetration, the current philosophy on islanding may have to change completely.

The first objection, that islanding is unsafe, is perhaps not insurmountable. Electrical engineers are all trained in safety, and always assume a circuit to be live unless they have first-hand evidence to the contrary. It is probably more a matter of convenience and expense than safety: embedded sources of power in the LV distribution system would make fault location and repair much more difficult and time-consuming, because there will no longer be a clearly-defined power flow from 'generator' to 'load'. When the network stays live on both sides of a fault, how do you trace where the fault is? Of course, the high-voltage transmission system faces this exact challenge, and its solution is to use automatic protection relays that signal when and where a fault has occurred.

There is a more serious side to this issue, however: if an embedded generator were to trip out, and then restart at a later time while someone was working on the system, a very dangerous situation could result. The protection systems currently used with EG do not allow restarting unless a healthy voltage and frequency are already present, and this is therefore one feature that should be kept.

The second objection is somewhat more grounded in fact, but again it need not be insurmountable. If the power quality within an island was of a good standard, the voltage and frequency would remain very close to that of the rest of the network. Therefore, it might be possible to reconnect it at an instant when the relative phase was correct. This phase-sensitive switching would require replacement or modification of many breakers and reclosers in the existing system, and therefore might not be economically desirable.

An alternative line of attack might be to ensure that islands never drift out of synchronism at all. A very accurate timebase (to within a few nanoseconds) can be derived from Global Positioning System (GPS) receivers. If enough generators in an island were locked to the GPS timebase, and the generation in the rest of the network was also locked, then there would be no problem. The price of GPS receivers is currently around \$150 and so this standard is accessible even to relatively small EG units.



The final objection, poor power quality, is probably the most complex and demanding of all. The network may island in a vast number of ways; in theory it can split at any point where a fuse or circuit breaker is present. There is no way of knowing whether generation will match demand within whatever islands might form. The best approach here is probably to maintain tight voltage and frequency trips on all embedded generators. In this way, customers should either receive power of acceptable quality, or none at all.

So, it can be argued that there is no fundamental objection to islanding. It is simply a matter of difficulty and expense; to manage it properly would mean extending the advanced protection and switching techniques used in HV transmission into any part of the network that might island, which would entail fairly radical changes to the distribution equipment. In the short term, of course, it may prove more economical to make islands unstable and self-destructive as is currently done, but there seems to be no future in it.

### **3.5. *Impact of EG on existing control systems***

Adding EG to a network at the distribution level will change the power flows in ways that were never envisaged when the frequency control, AVR, and protection systems were set up. Therefore, these systems might not function as intended, and so the agencies who plan power systems tend to treat EG units as a nuisance. The problem here is real, but fundamentally it is just because of a lack of co-ordination between the EG units and the existing systems. If that co-ordination were present, in other words, if EG units were dispatchable, they could probably have a positive contribution to the existing control systems. [3] discusses this and proposes that EG and AVR should be handled together by a “Distribution Management System”. This seems very similar to the system proposed in this work.

### **3.6. *Economic dispatching***

#### **3.6.1. Theory**

The goal of economic dispatching (ED) is to operate all the generators in a network together in such a way as to get the cheapest electricity overall. This may be done

from a genuine profit motive, or alternatively the money and profit involved may be notional, and the real goal to minimise fuel consumption and hence environmental impact. It will be discussed here as if real money and profit were involved, but either way, the concept is fundamentally the same.

At first sight, this seems to be a simple matter. It costs money to generate electricity, and electricity from different sources is interchangeable thanks to a national grid. So, it should simply be a case of ranking generators in order of cost, and using the cheapest sources first. Of course, in reality there are a few catches.

First, the price of electricity from a given source is not constant, but rather it depends on the amount bought. In the short term, this is because the efficiency of a generating plant depends on the loading. Engines, turbines, boilers, etc. work most efficiently at a certain loading, which is determined at the design stage. Any other operating point compromises the efficiency. Hence, more fuel (which costs money) is wasted, and the cost of the electricity must be raised if the plant is to stay in profit. The cost calculated on this basis is called the short-run marginal cost. Also, in the long term, the capital cost of the plant, plus interest on loans, must be repaid out of the earnings, and this component will also loom larger if the plant is operated at a low capacity factor. Including this component gives the long-run marginal cost.

Finally, some of the generated power is lost in transmission, therefore the marginal cost also should reflect this. The amount depends on the distance between source and demand, and the characteristics of the transmission system. In practice, this complicates matters greatly and therefore it is tempting to ignore it.

Whether short- or long-run marginal costs are used, the effect is exactly the same. The merit order of the plants depends on the amount of power bought from each, which in turn depends on the merit order, etc. Therefore, achieving the economic optimum means solving a set of simultaneous non-linear differential equations. The exact form of these equations depends on the functions describing the marginal cost of each plant as a function of power.



### 3.6.2. Application to EG

These concepts do not translate directly to embedded generation. The first problem is that EG could involve very large numbers of generators, potentially millions on a national grid-sized network. Classical economic dispatching of all of these would require solution of an enormous equation set, not to mention the logistical trouble of gathering all the data together in one place where the equations could be solved. This is one of the main problems to be addressed in this thesis, and will be discussed at length in chapter 4.

The second problem is that the marginal cost of many EG sources is hard to define. For instance, in CHP plant, the marginal costs of heat and electricity, as well as the amounts of each generated, are tied together. In other words, the marginal cost of heat is determined by the amount of heat you buy, but also by the amount of electricity, and *vice versa*. In a situation where heat and electricity were sold in different markets, the mathematics for economic dispatch could become daunting.

In renewable generation, the short-run marginal cost is zero, since the fuel is free. The long-run marginal cost may be assumed constant, which is not a problem from the ED viewpoint, rather it simplifies matters greatly.

## 3.7. Stability

### 3.7.1. What exactly is stability?

Stability is rather loosely defined in power systems work. Basically, when all of the control systems discussed above are set up properly and working in harmony, stability is the result. If they are wrongly configured, or interact in unforeseen ways, then the grid may become unstable. For example, if load-following control is not working properly, there may not actually be enough reserve to meet a sudden increase in demand. The instability that results is known as frequency collapse, a nightmare scenario involving the whole national grid. The remedy for frequency collapse is drastic; demand has to be shed until the frequency starts to recover.

To take another example, if the protection system is not properly configured, then it is possible for a fault to trigger a chain reaction which trips out far more equipment



than was necessary to clear/isolate the original fault. This may also be thought of as a form of instability.

In a similar way, a fault in the transmission network can suddenly upset the flow of real power. The resulting transient can cause synchronous generators to pull out of synchronisation, and trip out. If a few large generators are lost in this way, the lack of generation could initiate a frequency collapse of the entire grid. The stakes are high, and so this is the best-known and most-studied form of instability.

### 3.7.2. Classical stability studies

The classical method of analysing stability (described in detail in [15]) involves a number of simplifying assumptions. Transmission lines, transformers, etc. are reduced to a network of shunt and series reactances. Synchronous generators are represented as a voltage source in series with an inductive reactance. This can be assigned one of three values (called synchronous, transient, or subtransient) depending on the expected timescale of the fault event. Resistances are often neglected. A steady-state solution is then performed to find power flows and rotor angles of the synchronous generators in normal operation.

The fault is then applied. Normally it is considered to be a three-phase balanced fault, since this simplifies calculations and is also a worst-case scenario. Other types of fault require a full unbalanced solution using per-phase or phase-sequence methods. Obviously this is not a problem with modern simulation software, but it still requires more effort in description of the model.

A fault is a short-circuit, and so cannot consume any real power. It is assumed that the real power input from the prime mover remains constant while the fault is on. Therefore, the real power cannot leave the faulted generator(s) and it (they) will begin to accelerate compared to the others in the system.

After a relatively short time, a circuit breaker should operate to clear the fault. The affected generators will be able to deliver real power again, but because the faulted component is now out of service, the amount they can deliver may be less. Taking this into account, the next step is to calculate whether the generators can dump the extra momentum they picked up while the fault was on. If they can, then the system

will settle into its new state and remain stable. If the momentum is too great, they will keep accelerating and pull out of synchronism. The system is therefore unstable.

The margin of stability in a system depends on many things, mainly the fault clearing time, the inertia of generators, the impedance and loading of transmission lines, the demand, and the topology of the network and protection systems. Stability studies are used in a predictive capacity to plan the network so that it will deliver the most kW per unit capital cost, with acceptable stability margins. A popular definition of acceptable stability is that the system will remain stable if the single largest generating station (or transmission line) is lost.

### 3.7.3. Application to EG systems

This approach has been adequate for design of centralised power systems. However, a number of the assumptions will begin to fall down in EG systems. The classical method reduces everything to real power transfer between voltage sources (transient internal EMFs of synchronous generators) through a network of reactances (transmission lines). In embedded generation, the generators are often not synchronous, but induction machines or even power electronic inverters. Induction generators can “pull out” in a similar way to synchronous generators, but with inverters, the behaviour could be totally different. Also, EG units may be connected at the distribution level, where it is no longer valid to view lines as simple inductive reactances (see 3.3.1 above). For this reason (and other reasons) the assumption of P-Q decoupling [16] commonly made in power flow analyses, can no longer be relied on. Finally, if distributed AVR/frequency control systems (see 3.3.3) were introduced, these would have dynamics of their own which may spoil the usual assumptions of ideal AVR, etc.

Of course, modern power systems CAD packages can perform much more detailed analyses, such as full transient analysis including the effects of user-definable control algorithms, and may well be able to manage this level of complexity. However, it will present a barrier to intuitive understanding for design engineers. Also, the computing power required to model a realistic network at the transient/power electronic switching timescale, and the effort required for model definition, may be prohibitive. This is only speculation, however, and computing power is increasing



rapidly all the time. Great steps have also been made towards a theoretical/analytical understanding of the issues described above. (See [17].)

#### 3.7.4. How will EG affect stability?

Due to the difficulties in modelling and intuitive understanding discussed above, it is unfortunately quite hard to say. At one extreme, if it were controlled in a totally optimal manner, it might be as good as, or better than, centralised power systems of today. At the other extreme, through blind projection of the technologies and policies currently applied to EG, it could wreck the network completely. No-one really seems to know how large numbers of EG units, each incorporating its own LFC and/or AVR, will behave when they are connected together and to a network that also contains other control algorithms, reactances, and rotating machines. Because the potential risks are so high, it is understandable for power systems engineers to take a conservative point of view: They cannot prove that EG will integrate satisfactorily, and so cite Murphy's Law [18] to prove that it will turn out to be disastrous.

However, this viewpoint must be weighed against considerations of redundancy, which suggest the opposite. A detailed review of reliability theory is outwith the scope of this work, but broadly speaking, small generators are simpler than large ones, and so may possibly\* break down less often. Therefore, considering a single 1,000 MW generator, as opposed to 1,000 one-megawatt units, power from the smaller generators should have more availability. This is especially so for demands less than 1,000 MW, which could be met even if several small generators were broken down. In other words, there is improved availability due to diversity, and also possibly due to improved reliability of individual units.

#### 3.7.5. EG might improve stability

In the “dream scenario”, where every EG unit did its share of all the control duties such as LFC and AVR, and all were economically dispatched, power quality might be better than at present. The number of degrees of freedom for voltage regulation

---

\* This has been found in studies of larger-scale generators, e.g. 500MW vs. 2000MW, but there are no data for the case of very small generators.



would increase, so that voltage could be controlled more tightly everywhere. Frequency control and transient stability might improve too, simply because smaller units respond proportionately faster. In fact, power electronic inverters can break this speed/size tradeoff altogether; no matter what the size, they are controllable with sub-cycle precision. ([19, 20] show good examples of such systems.) And lastly, deliberate islanding could make for more redundancy and so reduce the impact of faults compared to today.

### 3.7.6. Or perhaps not

In 3.7.5 above, evidence was presented to suggest that distributed/embedded generation could improve power systems performance if it was scheduled in a suitable manner. That is a very large 'if', and so it is only fair to present the other side of the case. There are two main problems.

The first of these is renewable energy, which will probably form a significant part of the EG mix in future years. In 3.7.5 it was assumed that the power output of EG units could be controlled entirely at will. This is true for such technologies as fuel cells, storage units of all kinds, and combustion engines/turbines (whether fossil or biomass fuelled). These all have an inherent store of energy that can be released as necessary.

However, some RE generators, like photovoltaics and wind turbines, are not directly dispatchable. The only possible means of control is dumping of any excess output, also known as constraint management. But on the whole, the output is controlled by the incident solar or wind energy, and so is liable to fluctuate more or less at random. This could obviously have a negative effect on power quality. In practice, other EG units that are dispatchable could be used to counteract the effect. This possibility has already been investigated, for instance in small-scale wind-diesel installations.

The other problem, which has already been discussed here, is that the algorithms for control of large numbers of embedded generators do not exist. The only precedents are the automatic generation control (AGC) algorithms used in conventional centralised networks, for example [5, 6]. Unfortunately, these are designed with the expectation that they will run on computers in a national grid control centre,

receiving data from the whole national grid, and controlling all the generators. It seems likely (as argued in Section 2.7) that this approach would encounter serious difficulties due to the sheer number of units involved in EG. Admittedly, algorithms such as that described in [6] make steps in this direction, by splitting the problem into several control areas, but the method still appears to require substantial exchanges of data between areas and so does not seem directly applicable.

The ultimate goal, in these terms, could be described as the creation of an AGC algorithm (incorporating LFC, AVR and ED functions) which is guaranteed stable with no data other than that which it can measure directly, i.e. the voltage and current at the generator busbars, and that irrespective of the number of instances of that algorithm deployed in the network, and the reactances, motor inertias, etc. also in the network. A “killer application” like this would greatly enhance prospects for large-scale embedded generation.

This is a serious task, and one which may lead to economic compromises, or in fact be impossible. It would be very desirable to obtain some kind of theoretical argument that it is possible. One line of attack might be to find a mathematical model of a worst-case network, comprising many instances of the algorithm under test along with reasonable models of tie-lines and loads, reduce this to a system of linear equations, and apply stability criteria, such as the well-known Routh criteria from control engineering. Since many power system components are non-linear, this may not be applicable. Another possibility might be to test the algorithm in a classical two-area or multi-area power system model, using existing power systems modelling methods, and perhaps developing new kinds of model boundary conditions that mimic “a large number of similar adjoining areas” without excessive computing requirements. However, each of these projects might well be a Ph.D. in its own right. [17] is an excellent guide to the latest research in the area.

### **3.8. Conclusions**

In this chapter, the current trends in power systems control were reviewed with particular attention to techniques relevant to embedded generation. The impression was that EG control was a relatively new and unexplored field, where many of the traditional concepts did not directly apply. The evidence suggested that



contemporary control and protection schemes used with EG units did not allow them to realise their full potential, and might in fact interact destructively with existing systems, causing negative effects on stability. However, there appeared to be no fundamental reason why this should be so; on the contrary, there was some evidence to suggest that EG systems might perform just as well as centralised ones, if each EG unit was controlled with the kind of care and detail devoted to AGC of centralised generators at present. Extending these AGC techniques to large numbers of embedded generators was identified as a very promising area for further work. Unfortunately, though, it seemed that the existing AGC algorithms might not be directly scalable, and fundamentally new techniques would be required. In the next chapter, the question will be explored of what those new techniques might be.

### **3.9. References**

1. 'Feedback Control of Dynamic Systems', Franklin, F. G. *et al.*, Addison Wesley, 1994.
2. 'Embedded Generation', Jenkins, N. *et al.*, IEE, London, 2000.
3. *ibid.*, p. 258.
4. 'Power-plant control and instrumentation: The control of boilers and HRSG systems', Lindsley, D., IEE, London, 2000.
5. "A new approach to automatic generation control and economic dispatch for real-time closed-loop operation", Albrecht, J. *et al.*, Proc. 12<sup>th</sup> Power Systems Computation Conference, Dresden, 1996.
6. 'Decentralized Load Frequency based on  $H_{\infty}$  Control', Ishii, T. *et al.*, Electrical Engineering In Japan, Vol. 136, No. 3, 2001.
7. 'Newnes Electrical Pocket Book 18<sup>th</sup> Edition', ed. Reeves, E.A., Butterworth, London, 1981.
8. 'Higher Electrical Engineering', Shepherd, J. *et al.*, Pitman, London, 1970, p.504.
9. *ibid.*, p. 508.



10. 'Reactive power generation and control by thyristor circuits', Gyugyi, L., IEEE Trans., 1979, IA-15, 5, pp. 521-532.
11. 'Power Electronics', Lander, C.W., McGraw-Hill, London, 1993, pp. 306-311.
12. 'Embedded Generation', Jenkins, N. *et al.*, IEE, London, 2000, p.106
13. *ibid.*, p.15.
14. 'Development and Testing of an Approach to Anti-Islanding in Utility-Interconnected Photovoltaic Systems', Stevens, J. *et al.*, Sandia National Laboratories, 2000.
15. 'Power Systems Stability Handbook', Pansini, A.J., Fairmont Press, 1992.
16. 'Electric Power Systems', Nasar, S.A. *et al.*, CRC Press, 1998, p. 88.
17. 'Dynamics and control of large electric power systems', Ilic, M., Zaborsky, J., Wiley, New York, 2000.
18. Murphy's Law can be stated as: "If it can go wrong, it will". Basically an alternative statement of the Second Law of Thermodynamics. Author unknown.
19. 'Multi-Module Parallel Small Battery Energy Storage System', Chiang, S.J. *et al.*, IEEE Trans. Energy Conversion, Vol. 11, no. 1, pp.146-154.
20. 'Line conditioning system with simple control strategy and fast dynamic response', Moran, L. *et al.*, IEE Proc. Generation, Transmission & Distribution, Vol. 142, No.2, pp. 128- 134.
21. 'Reduction of voltage violations from embedded generators connected to the distribution network by intelligent reactive power control', Wallace, A.R. *et al.*, IEE Conf. Publ. No. 488, April 2002.
22. 'A variable speed wind energy conversion scheme for connection to weak AC systems', Neris, A.S. *et al.*, IEEE Trans. Energy Conversion, Vol. 14, No. 1, March 1999.

## **Chapter 4: A new dispatching system proposed**

In the previous chapter, the control systems currently used in power systems were reviewed, as well as the likely problems when these systems are combined with and/or applied to embedded generation. Now, the next step is to propose a possible new paradigm for power systems control. The single grid control centre is replaced by large numbers of distributed dispatchers throughout the network. Each of these acts as a broker through which software agents buy and sell energy on behalf of generators and consumers which they represent. This will be referred to as distributed (or embedded) dispatching.

### ***4.1. Distributed dispatching***

The immediate question begged by this is: What physical form and location would embedded dispatching systems take, and how would they communicate with generation, demand, and each other? This question is probably best answered by looking at the nature of the sub-tasks involved in dispatching. The computational and data requirements of these three components suggest different ways of embedding them.

#### **4.1.1. Embedding LFC and AVR**

As evidenced in 3.7.5, load frequency control is a task that requires quick action. Therefore, it is wise to place it where it has immediate access to the frequency measurement, and the means of actuating it, without having to go through intermediate communications links. This will mean incorporating LFC into the grid-connected EG/storage units themselves, probably as an algorithm running on a microcontroller chip. The drawback to this approach is that separate EG units will not have knowledge of each others' control actions, and so there is always the possibility that they may act in an uncoordinated and unstable manner. This possibility might be eliminated by proper design of the LFC algorithm. Some kind of multi-level scheme might also be desirable, as described in 3.3.2. Similar considerations hold for automatic voltage regulation (AVR) functions.



### 4.1.2. Embedding ED

The essence of economic dispatch is co-ordination between multiple generating units so that they share the load optimally. Therefore, it is meaningless to consider embedding ED algorithms in individual generating units. ED requires some sort of control centre that connects to multiple generators. However, this work has already raised objections to the use of a single control centre for all generators belonging to a grid. It seems more sensible to embed ED functionality at some intermediate level; perhaps one control centre for every 10 to 50 EG units. Modern computing technology would allow the control centre to be produced as a small box similar in size and cost to a computer network router, and indeed it would probably connect to generators with a standard network technology such as Ethernet, DSL, ISDN, etc.

It also seems logical that this should be done on a hierarchical basis. In other words, the combination of a control centre and its generators could be made to appear as if it was a single larger embedded generator, which would connect along with other similar units to a higher-level ED control centre, and so on, until the entire EG fleet was reduced to a few top-level controllers. These might well be functionally similar to large generating stations, and capable of integration with the existing AGC systems for centralised generating plant.

### 4.1.3. Embedding demand prediction

There is scope for demand prediction at all levels. In tune with the embedded dispatching philosophy, though, it seems logical to embed it in those components that can benefit from it. Storage units are the most obvious example, although there are many electrical loads which could benefit from being able to predict the most economical times to operate.

## 4.2. *Economic considerations*

As was seen previously, there are advanced algorithms which attempt to operate all the generators in a power network at the economic optimum point. It is quite possible that existing ED algorithms could be modified so as to only optimise their local subnet of generators, but they seem to contain much functionality that is not applicable to the case in hand. Furthermore, those existing ED codes which could be

found are commercial, and not available for research purposes. This makes it an attractive proposition to develop a simple ED algorithm specifically for the case in hand.

The first question to ask here is: What is the goal of economic dispatch? Politics notwithstanding, it would be reasonable to say that it aims to provide the greatest benefit to the consumer at the lowest cost to the consumer. So, it would be sensible to put this objective at the heart of the prospective control system. Then, it could be hoped that the balance of efficiency, stability, and power quality appropriate to the situation (after all, it might change from place to place, and from hour to hour) will just fall out. Of course, creating an electrical network that optimises itself to deliver value for money sounds rather ridiculous. But really, it is just the same functionality as current ED systems, stated from a higher level of abstraction.

If numbers can be derived from the real-world electrical system that quantify ‘value’ and ‘money’, then there is at least a hope of using a computer to optimise value for money. Now, money is easy to define; it is simply the unit cost of generating the energy. But how to quantify value? Capitalism states that any given item is worth ‘what the market will bear’. From this, it would be easy to define the value of a unit of energy as the maximum amount the user would be prepared to pay for it.

So, defining ‘value’ and ‘money’ in these ways, the problem can be stated more formally. In a practical system, there will be many sources of energy, each with its own cost (the ‘money’) and many demands for energy, each with its own ‘value’. The task then becomes one of maximising the ratio of total value to total cost. Now, this ratio is easy to calculate, but it is somewhat harder to find a simple way of locating the maximum value. There are four main computer-based approaches to problem-solving and decision-making. The first, applicable where the problem can be stated as a system of mathematical equations, is to use a numerical solver. There are formal numerical methods for optimising any system of equations, but they are sometimes computationally intensive, and are not always very robust. The remaining methods are applicable to decision-making tasks normally done by humans, which are more abstract, hence not possible as a system of equations. These fall within the realm of expert systems or artificial intelligence.



The question is: which one is best for dealing with millions of tiny power sources? If the earlier arguments in this work, on redundancy and emergent properties, are to be believed, the answer would be; the one which is simplest and can operate with the least information, especially where this is information concerning the state of physically remote parts of the network. In other words, the simpler the algorithm is, and the less it knows about its world, the less likely it is that its operation will be upset.

On the other hand, of course, the simpler it is, the less likely it is to be any use; going down this path, there is always the risk of blundering into a kind of electronic *reductio ad absurdum* where, through disregarding vital information, a nonsensical conclusion is arrived at. So, there must be a compromise between the two extremes: getting a fine optimal solution at the cost of heavy computation and observing a large number of variables, and on the other hand getting a solution which is quick and easy, but useless. The conditions are quite different to those in ordinary power networks; the state variables of the system are much more difficult to observe, there is more and faster control movement available, and the concept of marginal cost may well be meaningless in many situations. Therefore, the compromise will naturally be different.

### **4.3. Three simple rules for dispatching**

The compromise proposed is as follows: by making a few sweeping assumptions, the dispatcher's job may be reduced to a simple rule-based algorithm. This may be thought of as the "knowledge elicitation" phase, where an experienced human operator is interviewed, and his/her knowledge turned into a rule base. The most basic system of economic dispatching is well documented in the literature (e.g. see 3.6.1) and hence there is no need to explicitly interview anyone as such. As an absolute minimum, the system can be expressed as three rules:

#### **4.3.1. The rules**

Rule 1: Buy the cheapest electricity first.

Rule 2: Sell it to the consumers who are prepared to pay most for it.

Rule 3: Continue this process until either: all the consumers are satisfied, or the supply runs out, or the total amount of money paid to sellers of electricity approaches the total amount earned by selling it on (allowing for a profit margin where one is required)

#### 4.3.2. Assumptions underlying the rules

Now that the rules are established, it is time to debate the assumptions under which they were created. First of all, and most drastic compared to the traditional paradigm, it was assumed that all the generators and consumers actually are dispatchable. This is totally at odds with the *status quo*, in fact, as far as some power engineers are concerned, distributed generation is synonymous with non-dispatchable. A large proportion of this thesis is devoted to possible ways of making distributed generators dispatchable, and making renewable energy generating technologies that are not dispatchable behave as if they were.

Second, it was assumed that a single per-unit price is enough to describe the true cost of electricity. This has the effect of banishing marginal cost, the implications of which were hinted at in section 3.6.2. In the present context, the impact of this could be minimised by making sure that the system maximises utilisation, and the remainder of the responsibility shifted to the generator, so that it must keep its per-unit price fixed and decide for itself whether it is economic to run or not. Again, this may be a case for embedded prediction, or it may prove unsatisfactory.

Third, there is no prediction. No attempts are made to foresee changes in demand, as current AGC systems do. The reasoning behind this is that more and faster control movement makes prediction unnecessary. There is also no load scheduling capability, i.e. a way of reserving a block of energy in advance. Many demands represent a commitment that must be carried through, and this simple system has no way of knowing in advance what the total cost of such an operation will be, so it cannot help to decide whether to start the operation. Load control would probably be limited to load shedding in cases of excessive/uneconomic demand.

Fourth, it is assumed that sellers are capable of providing the amount of electricity ordered by the dispatcher at short notice. This presupposes that the generator's



response to changes in setpoint will be fast, which was substantiated earlier (in 3.7.5).

Fifth, and linked to the previous requirement: There can be no consideration of requirements for minimising control movement. Generators will be compelled to respond to orders for power which may change at any moment. This issue is often encountered when working with large generating plant where rapid and frequent changes in power level cause thermal stress which can lead to early failure of components. This task could be off-loaded by having the generator manipulate prices; if it needed to continue generating at a higher level than the demand warranted, it could attempt to increase demand by lowering the selling price. This would be a job for artificial intelligence associated with the generator. As argued earlier, however, control movement is often not a problem with the kind of small generators under consideration.

Lastly, there has been no consideration of frequency control (LFC) at all. This does not signal an intention to ignore it, but rather to embed it at a lower level, in the generator/storage system apparatus itself, for the sake of fast response. LFC may override the requirements of economic dispatch on a temporary basis, and in the longer term, present itself to the economic dispatch system as a virtual generator or load which buys/sells the amount of energy needed for frequency control. This type of organisation is similar to the “balancing market” employed in some modern electricity trading systems.

These assumptions seem very gross, and perhaps almost untenable. But there are compelling reasons for simplifying matters to such an extent. The system will have to deal with supply and demand data from millions of sources, and react on the same time-scale as changes in demand; essentially in real-time. It will also have to be robust, since its reliability will directly impact that of the electricity supply. It was argued in this work that the best way of achieving this is by distributing it like the generators and loads it serves. An omniscient central executive which solves the whole network for a global optimum requires data from the whole network, and is therefore susceptible to malfunction if any data connection in the network should be broken. Therefore the robustness of such a system is seriously in question and it is to

be avoided. If generators and demands need more information to make their decisions, they can get it elsewhere. With respect to these considerations, the proposed solution is thought to be a reasonable compromise, for initial purposes at least.

There are also issues of satisfaction and perceived fairness. These are embodied in Rule 3, where they appear as a trade-off between supplying electricity to buyers who will only pay low prices, which is necessary to generate customer satisfaction, and making profit for the dispatcher, which must be done, otherwise there would be no incentive to operate the system. This trade-off is implemented by setting a profit margin as proposed earlier; by following the rules set out, the profit might be expected to increase rapidly as the dispatching proceeds, reach a peak, and then fall off again. The dispatching process would be terminated just before the profit falls below the profit margin. The higher this is set, the more the system emphasises making money as opposed to keeping customers happy.

With these caveats in mind, the rules of the game can be formalised, not to mention proposing an acronym for it; Real-time Embedded Dispatch Manager, or REDMan.

#### **4.4. *REDMan proposed***

The REDMan system is thought of as consisting of sources of power, demands of power, a central dispatcher, and a communications system which allows messages to be passed between them. Physically, it will probably consist of several computer programs (agents for sources and demands, plus a dispatching program), running on one or more computers or embedded controllers, interconnected by a network of some kind. Within this framework, it may be envisaged working as follows:

##### **4.4.1. Algorithm and communications**

1. A source must advertise to the dispatcher the maximum amount of power it can supply, and its per-unit price. The price is allowed to be zero or even negative. The source will then be informed of the amount of power required of it, and must then supply that amount. The amount of power required may change at any time and may be any amount between zero and the advertised maximum. If the source



requires to change the maximum available power or price for any reason, the advertisement should be repeated.

2. In advance of switching on, a demand must state the amount of power required to fulfil it, and the maximum per-unit price which it is prepared to pay for the fulfilment. It will then be informed as to whether or not it can be fulfilled at that price. If so, it may proceed; if not, it must remain off, or resubmit at a different price. If the amount of power required or the maximum price should change, the submission should be repeated. As a result of this it may turn out that the demand can no longer be fulfilled; in this case it must switch off, or resubmit at a different price.
3. This information will be supplied to a dispatching algorithm whose goal is to buy energy from sources and sell it to demands in an optimal manner, or as close to optimal as possible. The recommended algorithm for the time being is a simple rule-based one embodying the three rules described earlier. A more advanced algorithm may be substituted at a later date.
4. The price that the demand submits to the dispatcher in (2) is the price that it must pay, irrespective of how much the dispatcher paid for the electricity. This is of course the practical implementation of that cornerstone of capitalism, “an item is worth exactly what the market will bear”. It creates a deadlock that keeps things fair; otherwise demands could ensure fulfilment by quoting enormous prices in the knowledge that their bluff would almost never be called.
5. The network may contain several such dispatching algorithms, each dealing only with sources and demands local to itself. The system of algorithm and local sources/loads may be called a ‘domain’. To interconnect different domains, two connections will be used, so that each domain appears to the other as if it were one source and one demand. The number and size of domains in the network will be determined by other factors to be considered later.
6. Operations 1, 2 and 3 are repeated at a regular interval (the timestep). When a source is ordered to supply power, there is an implicit commitment for the period of one timestep. The same is also true for demands. Means of monitoring to ensure that these commitments are fulfilled, penalties for non-enforcement, and

means of enforcing such penalties, are not currently defined. The timestep is uniform within a domain and all communications between sources, demands, and dispatcher are carried out synchronously with the timestep.

The system described by these rules is shown in simplified form in Fig. 4.1. Only one domain is shown here: a possible arrangement of multiple domains is shown in Fig. 4.2. Renewable generation is included here on the premise that it can be dispatched to an extent, e.g. constrained down. (See Section 3.7.6.)



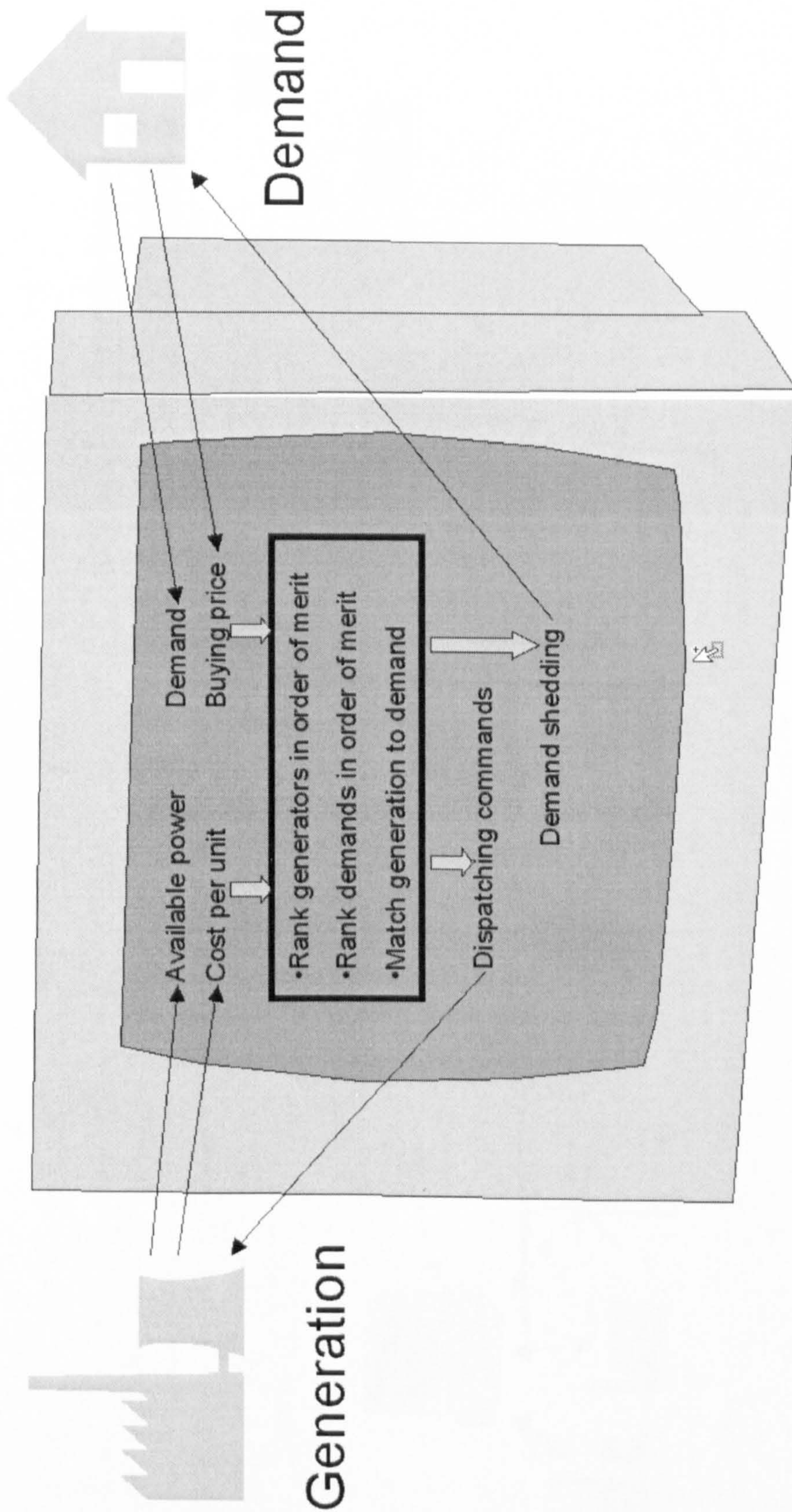

(Fig. 4.1: Rules expressed in diagram form)



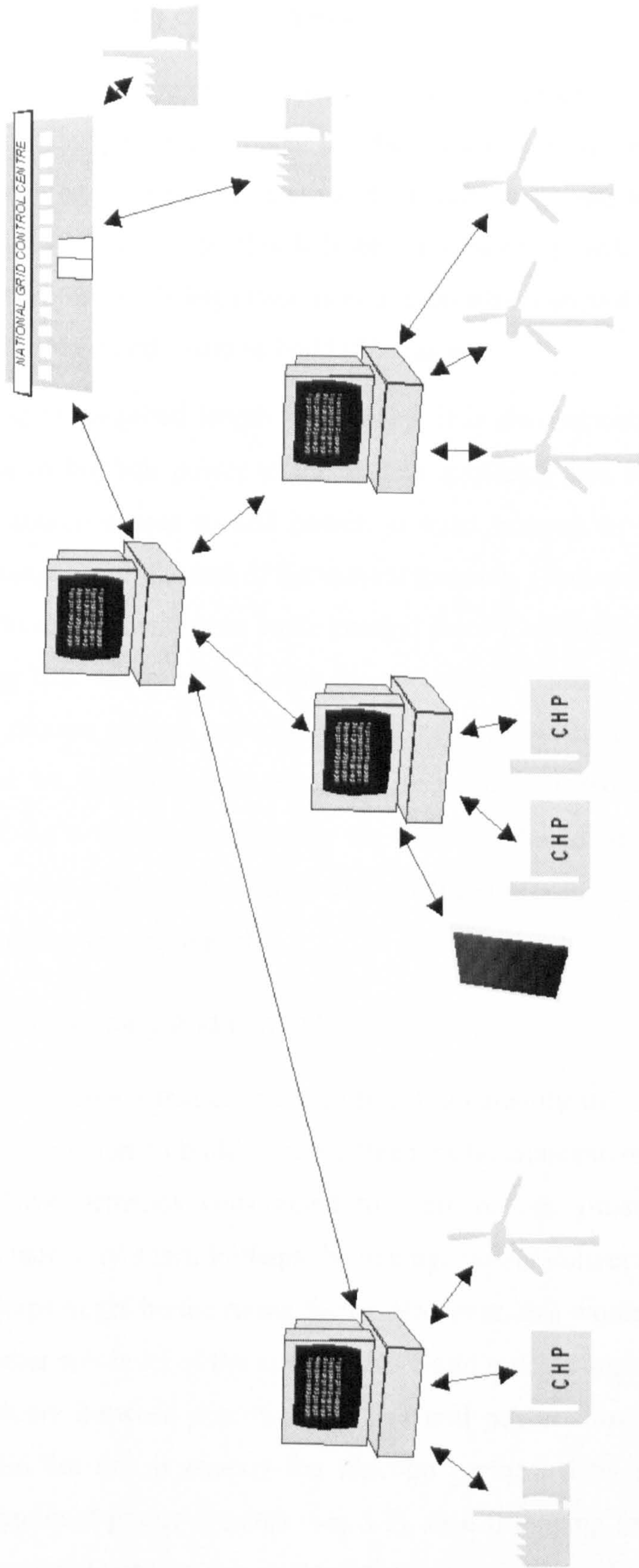

(Fig. 4.2: How multiple domains might be configured)



#### 4.4.2. Timestepping considerations

The above processes will be repeated at most once per 'timestep'. One timestep must be at least the amount of time it takes for the information in one domain to be gathered, the matching algorithm to run, and the results to be redistributed. There is not yet a firm idea of how long this will be, or whether it will be synchronous between different domains. Perhaps there is no reason why it should be, and indeed it may well be more robust and easier to build if it was not.

When considering the required length of timestep, it is also important to remember that all contracts to buy/sell power in the system implicitly last for one timestep. Therefore, if a source agrees to sell power, it must commit to maintaining the required power output until the end of the current timestep. Obviously if a renewable generator is to do this, it must store some energy, since it cannot guarantee that the renewable energy flux will not fall during the commitment period. Since renewable energy systems require storage anyway, having storage distributed along with RE generators might be desirable. However, the longer the timestep, the larger the storage required. As a first approximation, the timestep should be short enough so that the maximum expected shortfall or excess of RE in the course of one timestep is small compared to the storage available.

#### 4.4.3. Timestepping and commitment

The above analysis assumes that each commitment is perfectly strict and immutable. In practice it may be better to build in some freedom for manoeuvre; It may also be undesirable to have demands constrained to units of one timestep, unless the timesteps were made very short. Perhaps the average power delivered over a certain number of timesteps might be the ruling factor. However, this would presuppose the existence of another sub-level of the system, that could quickly supply or absorb the transient mismatches between commitments and real power flows. If this sounds familiar, it should be: this is exactly the function performed by Load Frequency Control in conventional power systems (see 3.2), or a balancing market as used in some trading systems. Carrying this analogy further, in a case where commitments are not strict, the REDMan system itself corresponds to the economic dispatching

layer of a centralised system, and like its centralised counterpart, is no longer directly responsible for power quality. (See 4.1.1, 4.3.2.)

#### 4.4.4. Handling concurrency

As described, the REDMan system contains multiple entities, any of which may act simultaneously. The actions of some entities are dependent on the actions of others. There must be some explicit means of scheduling the various actions in order to avoid total chaos and confusion. An easy way of doing this is to link the actions to the system timesteps. For instance, at the beginning of the timestep, a call would be sent out to sources and demands, asking them to make their bids. Once all bids had been received (or after a time window allowing a reasonable time for bids to arrive) the dispatching algorithm would be run, and the results sent back out to the sources/demands, before the end of the timestep. This is the same basic principle as a synchronous circuit in digital electronics, and the call for bids is analogous to the clock signal in such a circuit.

#### 4.5. *Proving the concept*

Now that some theories have been advanced of how automatic distributed dispatching might be made to work, they should be tested for validity. The first step would be to state clearly what the goal of the project is, in terms of a hypothesis which may be proved true or false. In this case, the hypothesis might be: “The REDMan system outlined in this chapter will perform automatic generation control of large numbers of distributed electrical generators, such that resources are utilised efficiently, and users of the electrical power receive acceptable quality of service.”

The next step is to design an experiment to test this hypothesis, and it is here that matters start to become more complicated. The obvious experiment would be to assemble an electrical grid with a large number of embedded generators and test the system on it, paying attention to criteria such as efficiency, voltage and frequency fluctuations, outages, etc. Of course, this is not very practical. So, perhaps an alternative would be to model such a network, using power system simulation software, or a dedicated power systems simulation computer.



However, a full-size network might contain thousands or millions of generators, and similar numbers of embedded dispatchers, etc. The computational effort required for solution, and labour required for model definition, might well be excessive. So, the most immediately obvious line of attack is to show (by simulation or experiment) that the system can control a smaller number of generators, and then to prove by other means that if it can do this, it will equally be able to control the larger number. This will require finding rules and proofs of the inductive type, pertaining to the behaviour of REDMan-type systems. These rules would be similar to shortcuts currently used in power systems simulation, as discussed in Section 3.7.2.

The REDMan system might for instance be tried on networks of different sizes, with a view to imputing relationships between performance and size by which the performance on a really large network could be predicted, or it might be tested on industry-standard models like the two-area, three-area, or multi-area model, either in standard form or modified.

Doing this requires either an experimental power system, or a simulation, which can accommodate at least a small REDMan system. But which is best to aim for? Simulation is very attractive, because it is a very cost-effective way of doing things, requiring no actual generators, power lines, and the like. Unfortunately, in the context of this project, there is a major drawback; a simulation cannot be trusted until it is validated. Validation means checking the results of a test case against the experimental equivalent, or against another simulator that has previously been validated by experiment. For this project, validation will be a serious problem. The combination of power engineering, power electronics, computer networks, and rule-based decision making proposed here is to the author's knowledge a new one, with no existing simulation tool immediately capable of modelling it. So, before simulations could be done, a new simulation tool would have to be created, and since it would be the first of its kind, it would require validation by experiments. So, whatever direction the project takes in future, there is a strong case for starting out with an experimental system.

#### **4.6. *Designing an experiment***

The challenge here is to create the best possible experiment (i.e. the one that gives most information towards reinforcing/disproving the hypothesis) subject to the limitations of money, time, and technical ability. A system capable of demonstrating dispatching obviously requires more than one source of power, and more than one demand for power. It would also be desirable to incorporate storage systems, and sources, that are typical of those used in embedded generation.

There will of course be constraints on the amount of money and time available for the experiment. Any practical system which could be built will probably be relatively small, and biased towards more mainstream, manageable technologies, such as PV modules, inverters, wind turbines, etc. rather than multi-megawatt CHP plants and the like. However, by careful design, it should still be possible to extract useful results.

#### **4.7. *Conclusions***

A proposal has been advanced for a new means of power systems control, called embedded dispatching, which may be suitable for large numbers of embedded generators. A possible protocol for transferring the minimum of information necessary for distributed dispatching, and a possible algorithm for performing the dispatching, were described. These systems have been kept simple by making assumptions about the behaviour of the network, and requiring control systems to be incorporated in generators and loads such that those assumptions hold true. Arguments in favour of these assumptions were presented, but it will be vital to back them up with evidence from experiments or simulation. The next chapters set out to do just that, starting with an implementation of the REDMan dispatcher in computer software.



## Chapter 5: Developing the REDMan software

So far, a new system for embedded dispatching has been proposed, and arguments made in favour of a real experimental test of it. Now, it is time to make a first attempt towards constructing that experiment. A reasonable place to start will be with the combination of the dispatcher and the communications network that connects it to the sources and demands it manages. The goal here will be to implement these as computer programs with the capability of interfacing to real-world sources and demands.

### 5.1. *The dispatcher*

In chapter 3 a simple dispatching algorithm was proposed, consisting essentially of just three rules; buy cheapest electricity first, sell to highest bidder, stop when customers satisfied, demand exhausted, or operation no longer economical (whichever occurs first) But these rules are of rather a high level of abstraction, and in order to incorporate them in a computer program, they must be broken down into simpler elementary operations.

Providing cheapest commodity/highest bidder functionality in support of the first two rules is easy enough. The first step is to gather together the power and cost information for each source into a list of (power, cost) pairs, and do likewise for each demand. A simple sorting algorithm to place these in order of cost, cheapest first for sources, and highest bidder first for demands, is all that is required.

The source list and demand list are then fed to the dispatching algorithm proper. It takes the first demand in the list, and makes it up using power from the source list, again starting with the first item. In the meantime it also calculates the total cost of the energy taken from the source list and compares it to the price the demand is prepared to pay. If the cost is greater than the price which will be paid, the transaction is deemed uneconomical. As soon as the first transaction of this kind is detected, the dispatching process is finished, because the order of sorting of the lists ensures that all subsequent transactions must also be uneconomical.

This simple strategy is guaranteed to at least break even. In practice it will normally make a profit, the precise value of which is undefined. A more advanced version of the algorithm could operate with a target profit margin specified in advance. This would be implemented by keeping a running sum of the profit due to the fulfilment of each demand within the dispatching process:

$$profit = \sum_{j=1}^m (Pd_j Cd_j) - \sum_{i=1}^n (P_i Cs_i)$$

(Eq. 5.1)

where in a system with  $m$  demands and  $n$  sources,  $Pd_j$  is the power of the  $j$ th demand,  $Cd_j$  is the price it pays,  $P_i$  is the power bought from the  $i$ th source, and  $Cs_i$  is the price of that power. The dispatching process would be terminated when this value dropped below a predefined profit margin. However, the simpler version will be considered for now. Based on the description above, a flowchart can be drawn for the dispatching algorithm (Fig. 5.1) In this, the first step is to receive data for the sources: the maximum dispatchable power and the per-unit cost of it, then receive data for the demands: the price each is prepared to pay, and the amount of power it requires. Then the sources are sorted in order of the per-unit price so that the cheapest will be used first, and likewise with the demands so that the highest-earning ones will receive priority. The next step is an allocation procedure, the dispatching proper. Here, the amount of power required by the first demand is subtracted from the first source in the source list, going on to subsequent sources if the first one cannot give enough power. Meanwhile, a running tally is kept of the per-unit cost. If it exceeds the cost associated with the demand, then that demand cannot be accommodated. This process is repeated until all demands in the list have been dispatched. Then, the results are presented to some sort of mechanism which will make the real generators and loads obey them.



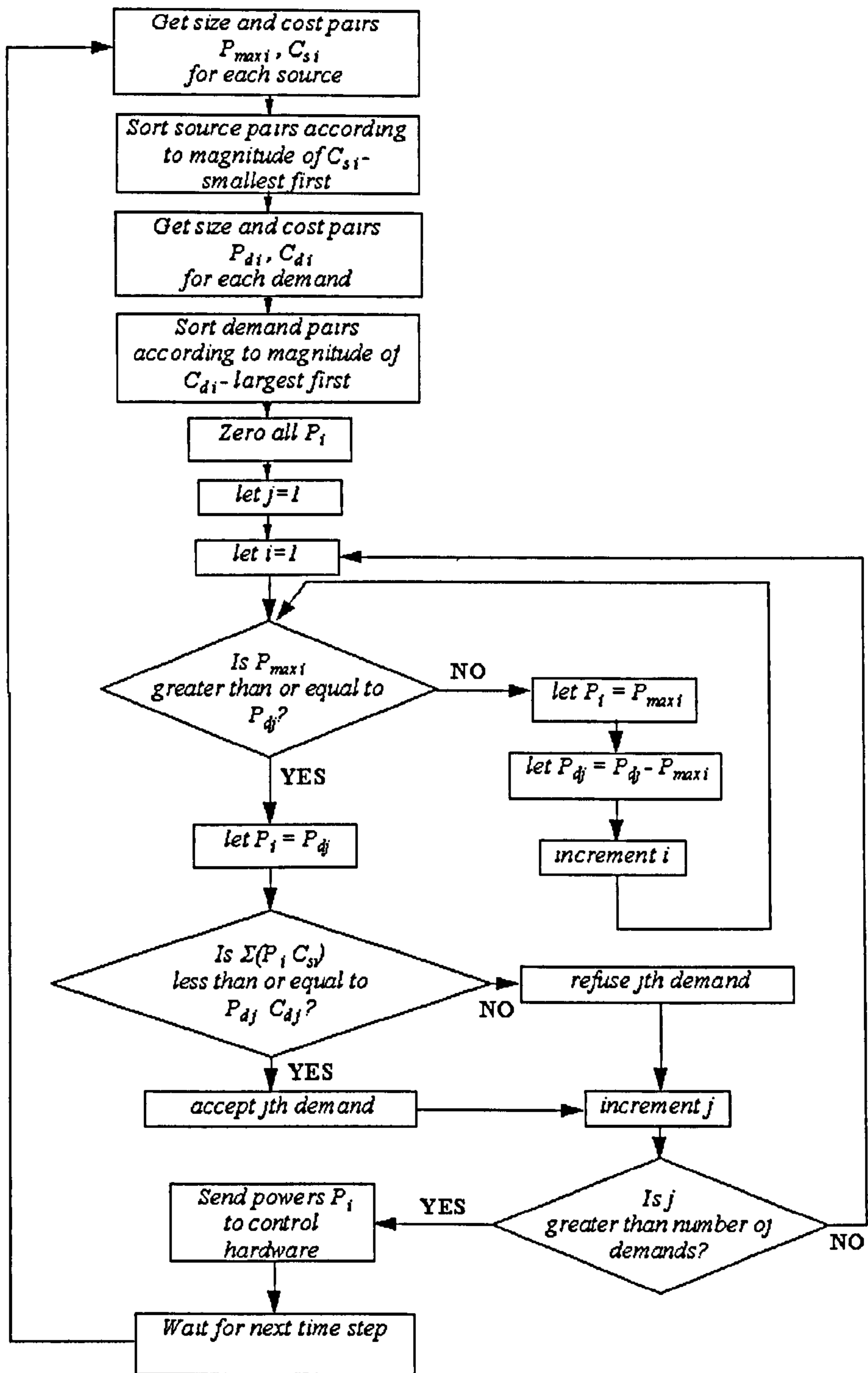

(Fig 5.1: Flowchart of a simple dispatching algorithm.)

This flowchart is a good enough specification to form the basis of a computer program. There is just the matter of sorting numbers; for this part of the program, the chart indicates ‘sort the numbers’, without specifying how this should be done. Sorting of lists is a very common operation in computer data processing, and there are many different methods in use, each best suited to different kinds of list. One of the fastest overall is the well-known ‘Quicksort’ algorithm. However, in the proposed experimental system, the lists are liable to be very small (about 10 entries) and it was felt that the time taken up by sorting would be insignificant compared to other aspects of the program, whatever algorithm was used.

## **5.2. Details of programming**

Now that the algorithm has been specified, there is just the matter of what programming language it should be written in. It was decided to use National Instruments’ LabVIEW environment [1] for reasons of convenience which were touched on earlier, and because of its good and easy-to-use support for data acquisition and networking, which are of great use in programs for communicating across networks and speaking to experimental hardware. A review of the LabVIEW system can be found in Appendix G.

Really, though, the choice is a matter of convenience; almost any high-level programming language currently in use, whether it be C++, Java, or Visual Basic, could easily have managed the task in hand, and the reader may well prefer to take the algorithms developed here into his or her preferred programming environment. Therefore, programs written in this work will generally be presented in the form of flowcharts or pseudocode. Since it would take up a great deal of space, the original LabVIEW source code (block diagrams) has only been printed for a few of the most important programs. In any case, all of the source files can be downloaded from ESRU’s website at <http://www.esru.strath.ac.uk/>

## **5.3. Writing the program**

The first task is to define how the algorithm will interface with the other parts of the system. The flowchart specified that the program should receive ‘size and cost pairs for each source/each demand’, send ‘powers  $P_i$  to control hardware’, and



'accept/refuse  $j$ th demand'. In the actual program, these items of information will be contained in data structures which are passed between the program and another program dealing with communications. The usual way to deal with lists of this kind is to represent them by arrays of a custom datatype (known as a *typedef struct* in C or a *cluster* in LabVIEW.) The cluster is rather like a database record, in that it can be configured to contain any desired combination of numbers, text, Boolean true/false values, etc. So, the size and cost values for each source in the system can be represented as an array of clusters, where the cluster contains a number representing size, and a number representing cost, and the array has one element for each source in the system.

Once the data are introduced to the program, the next step is to sort them. The indexed and sorted arrays are then fed to the source/demand matching routine. This operates exactly as shown in the flowchart. The outputs from this are a list of the powers actually required from sources (termed the *buy vector*), and a list of true/false values indicating whether each demand is to be accepted or refused (termed the *dump vector*) These arrays are then re-sorted according to the previously-added index number to return them to their original order.

The LabVIEW block diagram of this program is included in Appendix H, section H.2.5.

#### **5.4. Testing**

Once the code had been written, the next step was to test it. There are two components to the testing process. Most important is to show that the algorithm itself is correct, in that it can perform optimal (or close to optimal) dispatching of a given set of sources and demands. Under the assumption of zero marginal cost, the ED optimisation problem is trivial. Hence it is sufficient to verify that the program performs in the same way as the algorithm originally specified; that is, to debug it. The basic method of doing this is to run the program on a sample dataset and compare the results with those given by hand calculation according to the rules from which the algorithm was derived. This is a fairly unexciting process, but by way of a demonstration of the program, an example run is given here.

### 5.4.1. Worked example

The first task is to make up a list of sources. Choose 3 sources, and let their available powers be 9200, 72, and 159 watts, and their prices 0.17, 1.2, and 3 units. Also make up a list of demands; for instance 3 demands, with powers of 400, 9000, and 1 watts, and prices of 10, 1 and 0.1 units. Note that these numbers are of no special significance: they are chosen at random. Now, work through the algorithm specified in the flowchart.

Sort sources in order of price:

Power	Price
9200	0.17
72	1.2
159	3

Sort demands in reverse order of price:

Power	Price
400	10
9000	1
1	0.1

Take first demand from source list. All of this will be supplied by the first source, and the cost will be 0.17, which is less than the 10 that the demand is prepared to pay, so the transaction can go ahead. The new source list:

Power	Price
8800	0.17
72	1.2
159	3



Next demand is 9000W. If this was to be supplied it would use up the 8800W remaining from the first source, the 72 of the second source, and  $(9000-8872)=128$ W of the third. The cost would therefore be:  $((8800*0.17)+(72*1.2)+(128*3))/9000 = 0.218$ . This is less than the 1 that the demand will pay, so again this transaction will be allowed. The new source list:

Power	Price
0	0.17
0	1.2
31	3

Now for the final demand. The remaining power has a cost of 3, but the demand is only prepared to pay 1. Therefore, it will not be allowed, and the dispatching operation ends here.

Next step is to feed the same source and demand lists into the dispatching program. Fig 5.2, following page, shows the output of the program when fed with this data (input in fields marked 1, 2, output in fields 3, 4) and it can be seen to be identical to the output predicted by hand calculation. This is a simple example: in the course of debugging, more complex test sequences were used, to verify absence of rounding errors, proper operation when demand exceeds supply, etc.



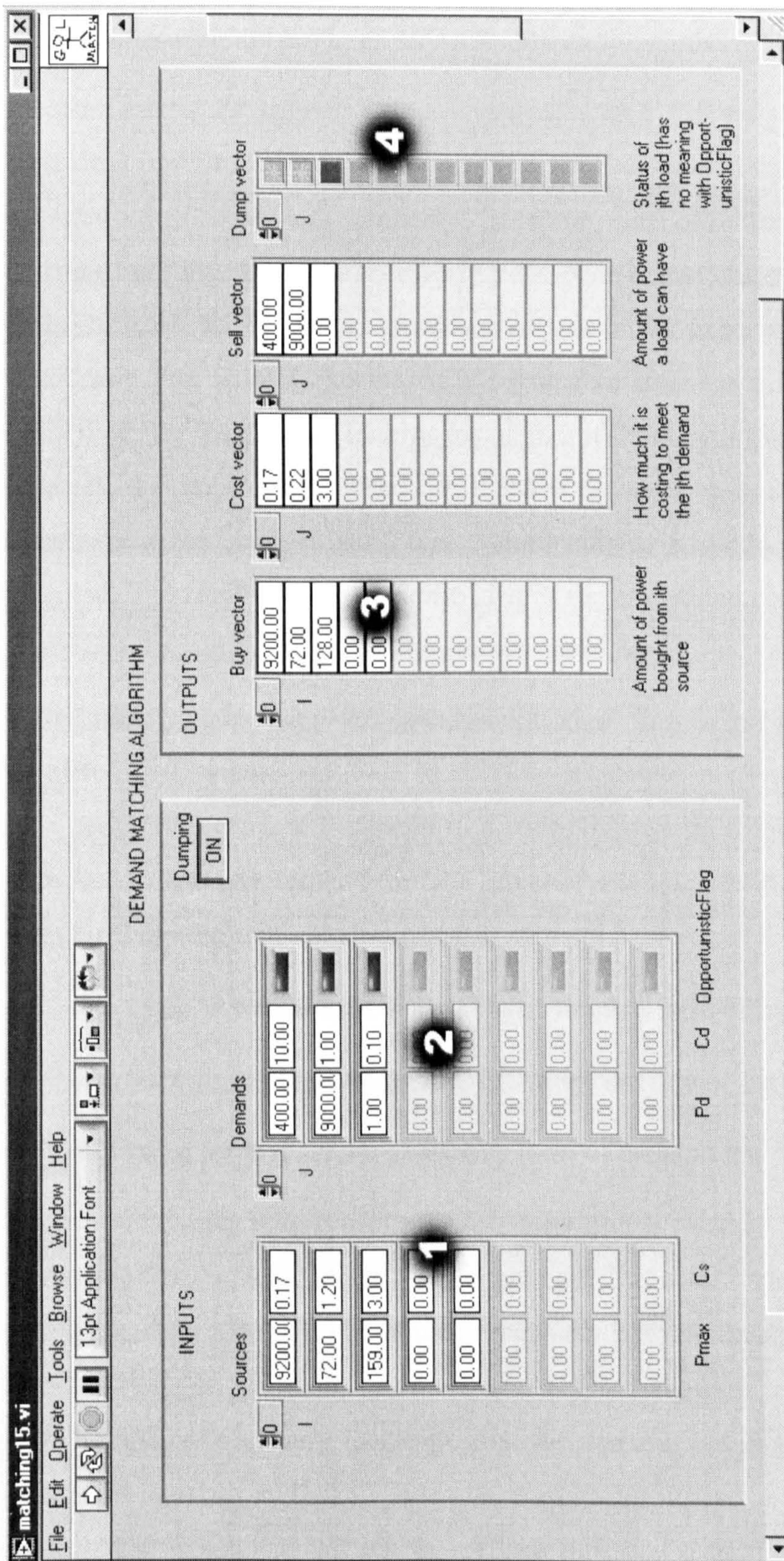

- 1= list of sources
- 2= list of demands
- 3= amount of power bought from sources in source list
- 4= light is ON for each demand in demand list that is allowed to receive power

(Fig. 5.2: User interface of dispatching algorithm. See text)



### 5.4.2. Speed test

Another matter of interest is the speed at which the program operates, and the computing resources used for its operation. Of course, as discussed in Chapter 4, the eventual application will probably be some sort of embedded microcontroller, whether built into a generator, inverter, etc. or in a stand-alone "dispatching box" of some kind. However, for the purposes of this initial experiment, it is important to make sure that it will execute in a reasonable time on an ordinary PC running LabVIEW. By 'reasonable time' is meant that it should complete within the proposed timestep of one second, and still leave a generous allocation of time for communications routines and other components of REDMan running on the same machine. The results also give some idea of the embedded computing resources that might be required in future, and so are presented here.

Unfortunately, measuring the speed of the algorithm is not totally straightforward, because it is not constant. Due to conditional statements within the algorithm, the time taken to execute will depend in a complex way on the values of data items. It will also obviously depend on the number of sources and demands, with the following approximate relationships:

- Time taken to bubble-sort demand list: varies as (size of list)<sup>2</sup>
- Time taken to bubble-sort source list: varies as (size of list)<sup>2</sup>
- Time taken for dispatching: varies as (size of demand list \* size of source list)

In other words, the total run-time of the algorithm is roughly proportional to the size of the problem squared. One way to measure the actual speed of execution is by timing the algorithm as it is executed repeatedly with randomly-generated source and demand lists. In order to exercise the dispatching part of the algorithm to a maximum, it is necessary to ensure that the demand list is always slightly smaller than the source list, so that all demands must be dispatched and none can be dumped. A simple program was written to perform this, and tests conducted on a 300MHz Pentium II machine, running Windows 98 SE and LabVIEW 6i.

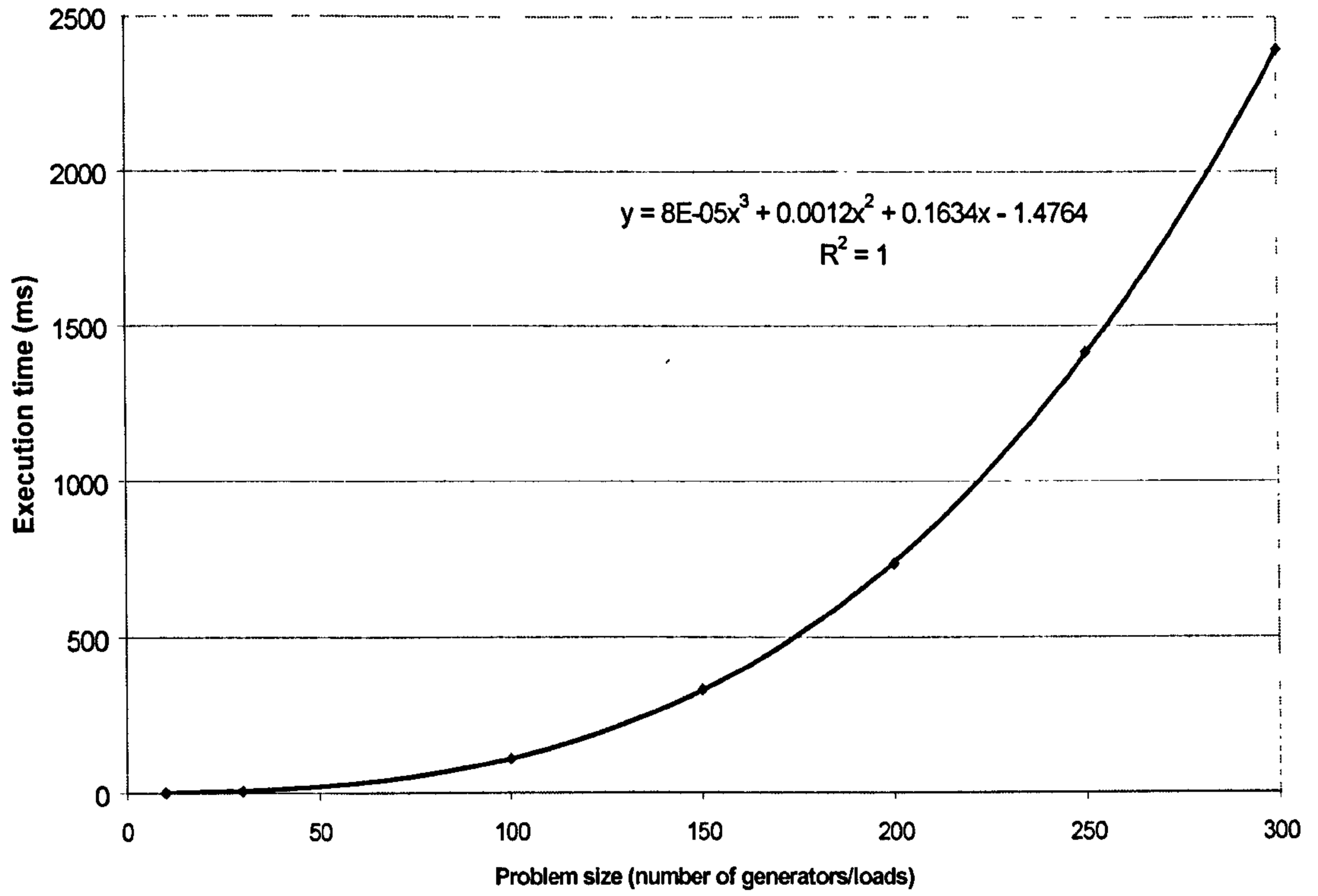

(Fig. 5.3: Execution time of REDMan algorithm vs. problem size)



### 5.4.3. Speed test results

Fig 5.3 shows how the execution time varied with the problem size. The best-fit to these results is a cubic polynomial, which suggests that the problem is not  $O(n^2)$  as predicted, but  $O(n^3)$ . This is a serious discrepancy between theory and practice, but can perhaps be explained by the way in which data is cached in the computer's memory. Assuming a small cache of higher-speed memory which is not quite big enough to hold an entire array, and the probability of accessing each array element being equal (i.e. random accesses or sequential accesses over entire array) the mean number of cache misses (requiring a slower access to main memory) will be proportional to (size of array – size of cache) and hence the mean speed of performing operations on such an array will depend on its size. Thus, it is possible for an algorithm containing a number of operations of order  $n^2$  to show an execution time of order  $n^3$ . This argument no longer holds once the array is large compared to the cache.

This hypothesis can be tested by re-running the speed test, but modifying the program under test to include a fixed delay, large compared to memory access time, with each array access. The effect of this is to make the access speed independent of the array size, and the resulting execution times are  $O(n^2)$ .

In any case, for small problems such as will be encountered in this experimental work, the speed is quite sufficient. For a 10x10 problem, the program executes in 0.62 ms, and even for a 100x100 problem, it is still only 110 ms, which is small compared to a 1-second timestep.

## 5.5. Validation

This is a less clear-cut subject. What are the criteria by which the efficiency of the dispatching should be measured? There has been other work (such as [2, 3]), which attempts to quantify dispatching efficiency, by metrics such as the amount of control movement, and the network frequency stability, due to a given algorithm. However, as argued in chapter 4, the goal was not to optimise either of these; the first is assumed to be irrelevant due to the response speed of small generators, and the second delegated to lower-level automatic controls. The proposed dispatcher is

concerned only with economics, and under the simplifying assumptions made earlier, the dispatcher's optimising 'problem' is fairly trivial. It is only in a situation where at least one source has non-zero incremental cost that there is anything worthy of serious mathematical optimisation.

Doubtless a more advanced algorithm could be specified, but a case has already been put forward in favour of the simplest approach possible. There are many scenarios (renewable energy, storage devices, domestic grid electricity) where the price of the product can correctly be assumed independent of the amount bought, because it is too troublesome to implement price breaks. In these situations, the dispatching is indeed trivial from a mathematical viewpoint, but the technical and organisational issues involved, of actually measuring and directing the power flow according to the commands of the dispatcher, are far more serious. This work is concerned as much with these latter issues as with dispatching itself, and so it seems appropriate to continue with investigating them. Due to the modular nature of the system, it should be possible to drop-in a more advanced economic dispatching algorithm at a later date. For now, though, the dispatcher is serviceable and can be used in testing of the communications layer.

## **5.6. Communications**

Now that the dispatcher is operational, the next step is to get the information flowing between it and the sources and demands. As mentioned earlier, the obvious way to do this is over a computer network, and for the sake of availability and ease of use, there is a strong bias towards using PC-compatible computers, an Ethernet network, the TCP/IP protocol, and the communications libraries of LabVIEW, in this experimental context.

### **5.6.1. Ethernet networking**

The Ethernet network was chosen because of accessibility. It is the most popular standard in local-area networking. Almost all modern personal computers can be fitted with a low-cost Ethernet network interface card (NIC), and all of the personal computer operating systems in use today have support for Ethernet hardware. Ethernet supports a great variety of communications protocols, including the popular



TCP/IP, as used by the Internet, and of more relevance, LabVIEW's communication VIs. In other words, LabVIEW programs can easily communicate with each other over an Ethernet network. Considering that the University buildings, like most office buildings, all have built-in Ethernet, it becomes a very tempting choice.

Of course, it is not perfect; there are issues associated with latency and quality of service, which may possibly not be good enough for this application. These issues will be investigated in more detail in Section 5.7.5 below.

### 5.6.2. DSTP/DataSocket

LabVIEW provides a variety of functions for network communication. The most basic of these are the TCP/IP VIs, which as the name suggests allow the programmer to work at the low level of raw TCP/IP data packets. This is not optimal for the present application, though; it simply requires transmission of floating-point numbers and logical true/false values with the minimum of fuss. To send these by raw TCP/IP requires an intermediate stage of encoding floating-point numbers into binary code. This is not especially difficult, but there are other higher-level means of communication in LabVIEW which can make the job even easier; DataSocket and the DSTP protocol.

DSTP is a part of National Instruments' DataSocket system for network-enabled measurement. This is a unified way of dealing with scientific-type data, which allows it to be read from different sources in a flexible manner. For instance, a program using DataSocket could just as easily load a time series of numbers from a disk file on the local machine, as from a remote file via FTP, from a web site via HTTP, or from another program on a remote machine via DSTP. This last function is of particular interest, because it is exactly what is required; a way to transfer numbers between programs which may be on different machines.

DSTP works on a client-server model. The DSTP-enabled program is always the client. To send a data item, it communicates with a separate DataSocket server program, and places the data item onto the server. A program wishing to receive the item connects to the server and picks it up. When an item is read from the server, it stays unchanged on the server: in other words, once you have written an item, you

may read it several times before writing it again, and each time it will return the same value. A good analogy is to think of the DS server as a noticeboard, where a write operation pins a notice onto it, and a read operation inspects the notice without removing it from the billboard. Data items are identified in two ways:

1. A Uniform Resource Locator (URL) which works in just the same way as the HTTP URLs (aka web addresses) familiar to any Internet surfer, except that it begins in `dstp://` instead of `http://`
2. An attribute, which is a text string associated with an individual data item. This is used in situations where it is convenient to store several data items at one URL. Attributes are optional and need not be used.

DSTP/DataSocket shows some promise for this application. The only foreseeable problem was that it seemed to be rather a complicated system, and moving data through it at a reasonable speed might therefore require a lot of computing power. In order to find out more, some tests were called for.

### 5.6.3. Testing DSTP/DataSocket

A few small experiments were done with DSTP and the DataSocket suite to determine its suitability for the project. Initially a rough estimate of speed was made, by using a simple program that started a timer, wrote an item to a datasocket, immediately read it back, and then stopped the timer. This gave the time elapsed between starting to place an item on the DataSocket server and finishing to read it back, i.e. the latency. This was quite variable; it was observed to reach under 1ms, but could also occasionally be up to 20ms. The mean latency was about 0.5ms. These figures were obtained when running the DS server on the same computer as the test program; when communicating with a DS server on a remote machine via Ethernet, they were somewhat higher, if more consistent; a mean of 3ms, with occasional peaks up to 6ms.

This is the time taken to transfer one double-precision floating point number. The REDMan application involves sending a series of values, using one DataSocket write after the other. It is reasonable to suppose that the result could be scaled up, by multiplying the time measured above by the number of values which are to be sent.



Another parameter of interest was the overhead, i.e. the amount of extra data added on top of the payload itself. By using a packet-sniffer program, the traffic between the DataSocket server and the client program was intercepted. Each transfer of a double-precision floating point number was observed to use one packet of approximately 600 bytes in size. (It is hard to be more precise because the size of the packet depends on the point in the protocol stack where it is intercepted.) Given that an IEEE-format double float uses only 64 bits (8 bytes) this is somewhat disappointing, although not very surprising given the amount of essential routing information that goes into a TCP/IP packet besides the payload.

Related to this, and also of interest, is the load imposed on the computer's CPU by the DataSocket routines. If this was excessive, it might not leave enough CPU time for the proper functioning of other REDMan modules. To test this, the CPU load was measured using Microsoft Windows' System Monitor application, while using the previous test program to write and read fifty DataSockets per second. The result was a load of almost 40%, on a machine with 333 MHz AMD K6-2 processor.

#### 5.6.4. Results

Performance of the dispatching algorithm and communications system has been measured. The dispatching algorithm runtime was found to vary roughly as the cube of the problem size, whereas the communications runtime varied linearly as the problem size. With the full processing power of a computer similar to the 300 and 333MHz test machines used, approximately 100 source/demand pairs could be dispatched and communicated with in a one-second timestep. The efficiency of this could doubtless be improved by orders of magnitude by using more advanced custom software, but for the time being, this speed is completely adequate for the size of the experimental system, which is unlikely to contain more than 10 sources and 10 demands. This means that DataSocket will be satisfactory, and so it is time to define the data format and write the communications routines.

## 5.7. REDMan comms routines

### 5.7.1. Data items to be transferred

The comms specification was defined in chapter 4. To recap, a power source must state the maximum amount of power it can supply, and the per-unit price of this power. In return, it will be told the amount of power actually required of it. A power demand must state the amount of power it wants, and the price it is willing to pay. In return, it will be told whether it is authorised to draw that power. In terms of data items, then, a power source sends two numbers and receives one number. A power demand sends two numbers, and receives one logical true/false value.

Each of these items must be identified uniquely. Furthermore, when there are several sources and demands in a network, the data streams associated with each client must be identified. The primary means of identification in DataSocket is the URL, and so it was a fairly obvious step to define a URL for each client. One complication in this scheme is that a single DataSocket URL represents a connection that passes data in one direction, whereas data flows both to and from a client. The solution was to define not one but two URLs for each client, one for each direction of transfer.

The following naming scheme was adopted for the URLs;

```
Dstp://<hostname>/redman/<client|server>/<load|gen>/<number>
```

Where <hostname> identifies the machine running the DataSocket server application, <client|server> is 'client' for the connection that sends data towards the dispatching algorithm and 'server' for the connection that sends it towards the source/demand agent, <load|gen> is 'load' if the agent is a demand agent and 'gen' if it is a source agent, and <number> is an index number uniquely identifying each agent.

For instance, the connection between the first generator agent and the dispatching algorithm would be specified by the following two URLs;

```
Dstp://localhost/redman/client/gen/0  
Dstp://localhost/redman/server/gen/0
```

This scheme is fairly complex, and with a reasonable number of agents in use, would generate large numbers of similar URLs. This proved to be a nuisance during early development of the system, where a good deal of errors were made simply through



confusing or mistyping URLs. In order to make the process less prone to error, a program was created to build the URLs automatically, and included as a subroutine in all REDMan components that required communications.

Within some of the connections defined by a single URL, it is necessary to transport several data items. This was done by means of attributes as mentioned earlier. In the case of the connection from power source to dispatcher, the maximum power was given the attribute string "Pmax", and the cost "Cs". The connection in the opposite direction only carries one data item and so needs no attribute. The connection from power demand to dispatcher carries two items; the power required, identified by the attribute "Pd", and the price willing to pay, "Cd". In the reverse direction, from dispatcher to demand, there is only one item; a logical true/false informing the load if it is permitted to switch on.

### 5.7.2. Allocating index numbers

The previous section mentioned that the various agent programs are identified by index numbers. The important question is: how to manage these index numbers, making sure that they are associated with the appropriate programs, that they are really unique, and that programs can join and leave the network if necessary?

Ideally, the numbers would be dynamically allocated. In other words, an agent that had just started and wished to join the network would make contact with a separate management program to request an ID number. The next free ID would be allocated. When the agent terminated (for example if its host appliance was switched off) it would notify that the ID was no longer in use.

However, this protocol is relatively complicated, and in the first instance, where there might only be 10 agents in total, it would be no great trouble to allocate the numbers statically by hand. The problem of opening and closing connections can be avoided thanks to a peculiarity of DataSocket discussed earlier; an item, once written to the server, is not altered by being read. By arranging for agents to write a power supply or demand amount of zero when they quit, the receiving end of the DataSocket connection will keep returning zero every subsequent time it is read. As far as the dispatching algorithm is concerned, a source with zero maximum power, or

a load with zero demand, is ignored completely. This might seem like a quick fix; computing power is being wasted to read connections every timestep when they carry no useful data. A proper allocation system which obliged the agent to request a connection would be more economical. Again, though, the speed tests showed that there will be no shortage of computing power.

Relying on the agent to “close” the connection in this way may also reduce the robustness of the system; for instance, if the agent crashes or is terminated before it can write a final zero, the last value that it managed to write will persist. So, it is evident that a proper handshaking/allocation procedure would be very important in a future real system. However, for initial experiments, the procedure described above proved to be satisfactory.

### 5.7.3. Timing and synchronisation

So far, there has been much mention of ‘timesteps’ without any substantial discussion of how these will be defined and enforced. Fundamentally, it is obvious that the timestep must be long enough to allow all of the data to be transferred and all of the calculations to be completed. It is also desirable that the timestep should not vary, since it would complicate conversion to and from REDMan’s native energy units of watt-timesteps. The several different phases of data transfer will also need to be co-ordinated, so that one program will be sending when the other is expecting to receive. These issues can all be resolved by an appropriate synchronisation system, which is generated by the central dispatcher. There are three phases of data transfer:

1. The agent programs all submit their data to the dispatcher.
2. The dispatching algorithm operates on the received data.
3. The results are returned to the agent programs.

These phases are synchronised by a ‘call for bids’ signal sent from the dispatcher to all agent programs.

### 5.7.4. Realisation of the system

Constructing the communications system according to these principles was merely a case of coding, and the details will not be discussed here. The end-product was a



toolkit of subroutines (or subVIs in the parlance of LabVIEW) to perform the tasks of URL generation, opening connections, transferring data, and closing connections. Synchronisation was implemented using the previously-discussed system of flags, but was later modified to allow different programs to run at different timesteps. Variable time-stepping such as this can be a very useful tool in maximising computational efficiency, but it requires careful and informed choice of the timesteps, since the choices made will have implications for dynamic behaviour and stability. These issues will be explored in a future section.

#### 5.7.5. Latency, quality of service, etc

Of course, the previous discussion assumes that the data passes through the network without corruption, and arrives on time at its destination. As can be appreciated, this is often not the case. Ordinary TCP/IP does not have guaranteed latency or quality of service, so there is always the possibility of data arriving late, or never. If this happens in the experimental system, the value from the previous timestep will be substituted for the missing one. This is a very rudimentary error “correction” scheme, but proved to be adequate since the networks used in experiments were reliable enough and had low and repeatable latency (see 5.6.3). However, this could not necessarily be depended on, and practical systems would require better means of dealing with errors and excessive/variable latency. Some newer networking protocols, like ATM and Ipv6, allow creation of streams with guaranteed latency and QoS.

Of course, in the real world, nothing is “guaranteed”. Guaranteed latency just means that the latency is unlikely to exceed a certain value. It does not mean that the system is immune to physical damage or malicious software, or that data can magically be transported faster than an undersized physical network infrastructure will allow. A system constructed along REDMan lines would therefore be vulnerable to breakdowns in the data network, as well as breakdowns in the power network. In all fairness it must be remembered that power companies already make considerable use of datacomms networks in scheduling their existing generation [4]

### 5.7.6. Some sample agents

To assist in testing, two simple agent programs were written. One was a test source, which submitted a power and cost as typed in by the user. The other was a test load, which could have its price set by the user, and which reported whether it was switched on or dumped by the dispatcher.

## 5.8. *Outcomes and conclusions*

This chapter was concerned with initial development of the dispatching algorithm. The rules for dispatching developed earlier were transferred into a computer program, and tested. The relevance of optimal dispatching under the simplifying assumptions made in this system was investigated, and it was found that the optimisation problem was trivial, if not non-existent. This suggests that the economic dispatching could be improved by removing the assumption that incremental cost is zero, and re-designing the algorithm appropriately.

A system was also created by which different programs within REDMan could communicate. A networking strategy suitable for experimental purposes was developed, by using existing Ethernet, TCP/IP and DataSocket components. The network was built and the software routines required to use it were written. Some speed tests of the dispatcher and communications were conducted and the results proved to be satisfactory.

Finally, the dispatcher and communications module were combined into one program, the 'REDMan Server'. The operation of this was tested by connecting it to mock source and demand agents, which were very basic simulations of real-world generators and loads. In this way it could be verified that there were no bugs in the system.

At this point, the core of the system was complete. However, its ability to control real-life generators and loads with varying power demands and prices was still untried. Therefore, the next step was to try connecting it to some actual power equipment, and this will be covered in the following chapter.



## 5.9. References

1. National Instruments LabVIEW, <http://www.ni.com/labview/>
2. 'Neural-based Generation Control for Highly Varying and Uncertain Loads', Shoureshi, R. A. *et al.*, Proc. 2001 IEEE Porto Power Tech Conf.
3. 'Decentralized Load Frequency based on  $H_{\infty}$  Control', Ishii, T. *et al.*, Electrical Engineering In Japan, Vol. 136, No. 3, 2001.
4. 'Beyond POTS (Electricity generation/selling control), Johnson, C., IEEE Power Engineering Society Summer Meeting 2000, Vol. 1, pp. 585-588.

## Chapter 6: Building a testbed

It is now time to take the step of hooking the dispatching server up to a collection of actual electrical generators, loads, and storage systems. This could be quite a difficult process, and there are a few main problems which can be foreseen in the light of previous discussions.

The first problem will be finding suitable generating equipment, given the constraints imposed by the scale of the project. This could well rule out heavy machinery like fuel cells and IC engine-powered generators, which tend to be costly, spread noxious chemicals and fumes around, and require large amounts of care and attention.

The second problem will be setting up an interface between the generating plant (or indeed the electrical loads) and the computer-based dispatcher. The generating plant must be able to accept commands such as 'change output power to 300 watts'. Similarly, the loads should be capable of being switched off (or *dumped*) by the dispatcher. A generator or load which fulfils these requirements is sometimes called dispatchable. At the review stage it was found that dispatchable small generators and dispatchable loads are quite rare.

The third problem is to manage grid co-operation. It is a very attractive proposition to use the existing electrical grid as if it were one generator in the system, because it will essentially take over control of load voltage and frequency, easing the task of the other generating plant. It also allows the REDMan network to be merged with the existing mains wiring so that REDMan-dispatched generators and loads can simply be plugged into ordinary wall sockets, which would be very convenient. However, electricity companies will not tolerate any equipment on their grid if they think that it might be unsafe, or that it might interfere with other users. This means that any experimental equipment connected to the grid should be made to comply with their recommendations. Nevertheless, time and budget restrictions associated with this project might make this an unreasonable objective. The decision to interact with the grid, or not, will have a very strong influence on the testbed design, and so it is logical to tackle this issue first.



## **6.1. Grid-connected working**

The UK electricity authorities publish recommendations which define a minimum standard and means of connection for embedded generating equipment. Some of these recommendations are actually law. Others are not, and the electricity company has no legal way of forcing you to comply with them. The legal restrictions relevant to this project (see [1]) can be summarised as follows: It is illegal to connect your installation to the grid if it can also be supplied from an alternative source. That is, unless you satisfy either of these two conditions:

1. Your installation is completely disconnected from the power company supply before it is connected to the alternative supply, and stays disconnected. In other words, an either/or arrangement.
2. You obtain the written agreement of the power company before connecting any power source of your own in parallel with their supply.

Condition (1) could be satisfied by means of a transfer switch on the premises where embedded generators are used, so that loads may be powered either by the EG or the grid, whichever is available or most economical. The switch is mechanically interlocked so that the EG can never be connected to the grid. While this system provides the highest degree of protection against islanding, it is very restrictive from the point of view of economic dispatching, because the EG must be sized to meet the maximum expected demand. There are also problems with operating the transfer switch while loads are drawing power, since this is liable to cause spikes and/or brief interruptions of the power supply. Really, this mode of operation is best reserved for backup power applications where the transfer is only made in case of a power failure.

Another possibility would be to actually connect the EG equipment to the grid, but controlling it in such a way that supply never exceeds on-site demand and hence no export to the grid is possible. This is rather like the one-way valve concept, except that the valve in this scenario is virtual, and so has no power losses. Of course, it is unlikely that generation could be made to track the changes in demand instantly, and so there might well be transient feed-back of power. However, it is hard to object to this on legal grounds, because there are many loads currently in use which do actually feed power back into the supply from time to time. It is standard practice in

industrial motor drives, where it is known as regenerative braking. As the name suggests, when the drive is to be braked, the motor is reconfigured to act as a generator. The best-known application of this principle is in lifts (elevators) where it allows the potential energy of the cage and counterweight to be recovered instead of wasted. It also finds application in drives for rotating machinery with very high inertia that needs to be stopped or reversed frequently, for example in rolling mills.

In any case, condition (2) specifies only that no energy should be fed back into the “point of interconnection”. In the present case, this would be the connection between the University building and the power company’s substation. It is hard to imagine that a small-scale experiment could ever feed in enough power to overcome the demand of the whole building, even in the middle of the night.

## **6.2. *Generating plant***

The choice of generators is mostly dependent on what equipment is available. It so happened that there were a number of PV modules used for other research projects in the department which could be borrowed. Once fixed to the roof, they could be properly classed as embedded renewable generation. A pair of experimental ducted wind turbine (DWT) modules were also available, and there was some interest in how they would perform in a system of this kind, so the intention was to use these also.

Unfortunately, while the use of PV is commendable from an environmental viewpoint, it causes some new problems of its own. The first of these is that PV in its native form is not dispatchable. The electrical output is determined by the insolation (and also the temperature to a certain extent) If the dispatching program demands more or less power than the PV can supply, something must be done. The second is that PV modules supply DC, whereas the electrical grid and the vast majority of loads require AC. The DWTs present exactly the same problems.

### **6.2.1. Dispatching PV/wind energy**

Dealing with the situation where the PV supplies less power than required is easy. Recall that the dispatching algorithm receives a maximum power value for each generator. If this is set to the maximum possible power given the insolation at that



timestep, then the PV will never be asked to supply more power than it can. Slightly more involved is the scenario where the dispatcher asks for less power than the PV is supplying. Here, some electronic intervention is required, by diverting the surplus power into a *dump load*, where it is wasted as heat, or by changing the loading on the PV module so that it is operating under a less efficient condition. The former method is more simple, because in this case the power incoming from the PV is always the maximum possible power, which is therefore easy to measure for dispatching.

A dispatchable dump load was built for the purposes of this experiment. The circuit and construction are described in Appendix B.

### 6.2.2. Using batteries

Batteries bring a major advantage, in that they act as a short-term energy store. This means that the dispatching software does not have to keep the energy balance perfect at every instant in time; as long as it adds up on average, any transient errors will be soaked up by the battery. To use an informal analogy, they are a place for the energy to pile up while the dispatcher decides what to do with it. This is a direct analogue to the LFC functions proposed earlier for distributed systems. Obviously it is not quite the same, since a DC system has no frequency. But if voltage is taken as the stabilised parameter instead, then the correspondence is exact: the battery is an energy store that automatically lets out or takes in power to keep the DC control area stable. It does this without any formal control algorithm as such, merely by being a voltage source with low internal resistance.

Having such a flexible and forgiving kind of “LFC” allows liberties to be taken with other aspects of the control software. In particular, dispatching for the PV is a case of measuring the *actual* power fed into the battery by the PV, and setting the maximum available power ( $P_{max}$ ) for dispatching purposes equal to this. If the dispatcher decides that the whole of the PV power is not required, then a dump load can be activated to draw the surplus power out of the battery.

As well as being a stabilising influence, batteries are also an energy store, and this aspect will need to be managed too. In order to do this, the battery will have to appear to the dispatching algorithm as two entities; one source and one demand. The

amounts of power bought and sold by the battery, and the associated prices, will depend on the state of charge of the battery in quite a complex way, and this topic will be investigated in more detail in a subsequent chapter on battery management.

### 6.2.3. Inverters

Of course, batteries and PV modules both work with direct current, whereas the electrical grid is 240 volts AC, 50 Hz. In order to achieve co-operation with the grid, a piece of equipment is needed that will convert the DC to AC and change the voltage to the proper level. This apparatus is known as an *inverter*. In the system under consideration, the inverter acts as a bridge between the part of the system containing generators and storage, and the part containing the loads. Therefore, the power throughput of the inverter should be determined by the power demand from the loads, or the power available from the generators/storage system, whichever is the smaller. It should be possible to achieve this effect by appropriate logic in the inverter control program, which will be considered later, but this is not the whole story; there is still the matter of actually making the inverter output the amount of power desired by the program. This will mean having it dispatchable under control of a computer, and unfortunately there are no inverters available on the market which can do this. They all have built-in maximum power point tracking. Therefore, it would be necessary to modify a commercial inverter, or build one. Building was chosen as probably the easier option. A 550 watt grid-intertied inverter was designed and built as part of this work. Details of design, construction, and testing are in Appendix A.

### 6.3. *Considerations in setting up the system*

Now that decisions have been made on what items of plant to use, it is time to consider how they should be connected together, and how they should be interfaced with the computer running the dispatching functions. Defining the basic hook-up is easy enough. The system will have, as it were, two buses; a DC bus and an AC bus. All DC plant (PV, DWTs, dump load, batteries) connects to the DC bus, and all AC plant (loads, grid) connects to the AC bus. The inverter connects to both buses and links them together.



The hook-up of measurement equipment is slightly more complex. It is necessary for the power flow to/from every item of plant to be known. By known is meant that it should either be measured, or controlled equal to a desired value, depending on the type of plant. For instance, the power flow from PV modules to batteries can only be measured (since it is *controlled* by the insolation) whereas the power flow from batteries to dump load should be controlled. It should also be noted in this context that when there are  $n$  flows of power into/out of a node, it is only necessary to know  $(n-1)$  of them. The  $n$ th can be inferred from conservation of energy which requires that the sum of powers must be zero. (assuming that negligible power is dissipated within the node itself, which will be reasonable if it is chosen to be a small point)

Therefore, in order to know the power balance for the DC side, it is necessary to know the DC bus voltage, and all but one of the currents drawn by equipment connected to it. The AC bus has three power flows: the power output of the inverter, the power consumed by loads participating in the dispatching scheme, and the power imported/exported (although export must be blocked for legal reasons) through a notional grid connection that supplies the scheme. This connection is not real, of course, because the loads participating in the scheme will be mixed in with other loads that do not, and there will be no single connection between the portion of AC wiring serving participating loads, and the 'rest of the grid'. Hence, it is impossible to measure the power flow in it directly, and so the other two flows must be measured instead; inverter power output and demand.

It would be possible to separate participating loads from the grid, so that the import/export could be measured directly, but there are certain advantages to not doing so. In effect, it creates a 'virtual power network' superimposed on the real one, an idea reminiscent of the privatised electricity market, where it is possible to buy electricity from half a dozen different suppliers, but whichever you choose, it nevertheless arrives at your house through the same wiring. The power is only separate from an accounting viewpoint.

Of course there are also disadvantages, the most important being that each participating load (or group of loads where possible) must have its power demand sensed and reported individually. This requires each load to be connected to the

computer network. In this age where more and more appliances are being enabled with on-board microprocessors, and networking technology is finding its way into even domestic premises, this is not as serious as it may seem. In fact, there is interest in connecting electrical appliances to computer networks for reasons which have nothing to do with energy systems; home automation, web-enabled appliances, etc.

However, this in turn requires that the load should have knowledge of its own power consumption. This is somewhat more difficult, because historically there has been no motive for doing anything of the kind. It may require extra sensing circuitry, which adds complexity and cost. In the case of a very simple appliance, such as a lamp, the extra cost may be completely unreasonable in proportion to the cost of the appliance itself. It is fortunate, then, that for many simple appliances there is a workaround. The power consumption of a resistive load, like a lamp or heater, is substantially constant. If a 60-watt bulb is switched 'ON' it is reasonable to assume that its power consumption is 60 watts. In this case, knowing the power consumption reduces to a simple case of determining whether the appliance is 'ON'.

Another possibility would be to group simple loads in order to spread the cost of the sensing circuitry amongst them. For instance, taking the example of a lamp, the whole lighting circuit of a domestic premises might count as one single load as far as the dispatching software is concerned, and one power sensor (which might conveniently be fitted in the distribution board) would be sufficient.

Some prototype forms of demand-measuring and reporting equipment were designed and built as part of this work. Appendices D and E describe these in detail. But, to return to the issue at hand, there is now a basic specification for the structure of the experimental system, and it is time to tackle the issues of the actual implementation.

### 6.3.1. Choosing voltages and power levels

The choice of AC voltage is of course predetermined. In the matter of DC voltage, there is some choice, but it is limited by the availability of components. There are four PV modules, two each of different kinds, and all nominally 12 volts. For good performance, PV panels that are connected in series should be matched. Therefore, it is only possible to connect two in series and so the maximum possible voltage will be



24. And, while lead-acid batteries are available in other voltages, the most common type are also 12 volts. Therefore, the choice is between 12 or 24 volts. Since the higher voltage will allow more efficient operation, with less  $I^2R$  losses in the wiring and inverter circuitry, 24 is the logical choice.

### 6.3.2. Measuring power flow

As far as DC is concerned, this is simple. Provided that both voltage and current do not have a significant AC component, the power is the product of mean voltage and mean current. Therefore, the power balance can be measured by measuring the DC bus voltage and each current entering/leaving it. The powers calculated from this will be those entering/leaving the node where the voltage is measured. These will not be quite the same as the powers generated or consumed, because of power losses in the connecting cables. The impact of this error can be minimised by designing for low voltage drops and measuring the voltage at a carefully-chosen central 'star point'.

With respect to the AC side, matters are more complicated, since loads sometimes have non-unity power factor, or indeed may draw a non-sinusoidal current. Accurate measurement under these conditions requires a dedicated power meter circuit. These generally function by rapidly sampling the instantaneous voltage and current, and using digital signal processing techniques to multiply the voltage and current samples together and take a running average of the result, which will be true RMS power [2]. However, as previously discussed, some loads have a constant and predictable power consumption, and these can be measured by just sensing whether they are 'ON' or 'OFF'. To sum up, there are three possible levels of measurement depending on the nature of the load, shown here in order of difficulty and expense:

1. An ON/OFF indication (for loads whose consumption is constant and whose power factor is constant although it need not be unity)
2. Corrected average rectified current (for loads with unity or constant power factor but whose consumption may vary)
3. True RMS wattmeter (for loads with neither constant power factor nor constant consumption)

In the experimental system, the ON/OFF sensor (type 1) is attractive on grounds of being simple. A sensor of this kind was built and tested; this is described in Appendix C. A true RMS wattmeter with computer interface was also built; see Appendix D.

The responsibility for power measurement of the inverter can be delegated to the inverter itself. If its power control is accurate, it may be sufficient to assume that the power output is equal to the demanded power output. The approach used was to calibrate the inverter using a laboratory wattmeter, and store the calibration table in the inverter control software. This will be discussed in more detail in appendix A.

#### **6.4. Setup and commissioning**

At this time, most of the parts required for construction of the experimental system were ready. The inverter had undergone several test runs and seemed to be stable and reliable. The dispatching programs had been tested with sample data, and a PC with eight-channel data acquisition card was ready. Batteries and PV modules had been procured. The time was ripe to assemble everything and risk some preliminary test runs.

##### **6.4.1. Equipment list**

Item	Maker	Quantity
Saturn 80, monocrystalline PV module, 12V nominal, 80W peak	BP Solar	2
MSX-50, polycrystalline PV module, 12V nominal, 50W peak	Solarex	2
Lead-acid battery, 12V, 75 amp-hour	Varta	2
Inverter, 24V in, 230V out, 550W max	In-house (See appendix 1)	1
Dump load, 24V, 200W max, with shunt regulator and control input	In-house (See appendix 2)	1
Terminal board with fuses, battery isolator, current shunts and voltage	In-house	1



divider		
PC-Compatible computer, 333MHz, 128MB RAM	Various	1
PCI-6023E, data acquisition card, 8 analogue input channels, 8 digital output lines	National Instruments	1
LabVIEW 6i, software	National Instruments	
Ducted wind turbine, 100W nominal	University of Strathclyde (experimental)	2

### 6.4.2. Structure

The system was configured according to Fig. 6.1. The PV panels are connected as two 24-volt arrays, and brought to the 24-volt battery bank, composed of two 12-volt batteries in series. The two ducted wind turbine (DWT) modules are also connected to the battery bank. Since they generate AC, a rectifier is used with each.

The inverter takes its input from the battery bank, and feeds its output into the electrical grid. It is plugged into a wall socket like any other electrical appliance. All voltages and currents of the DC system, and also the inverter status, are logged/controlled by a computer with DAQ card. Via Ethernet, this computer connects to another computer which is physically remote. This second computer monitors/controls the status of the loads (consumers of AC power).



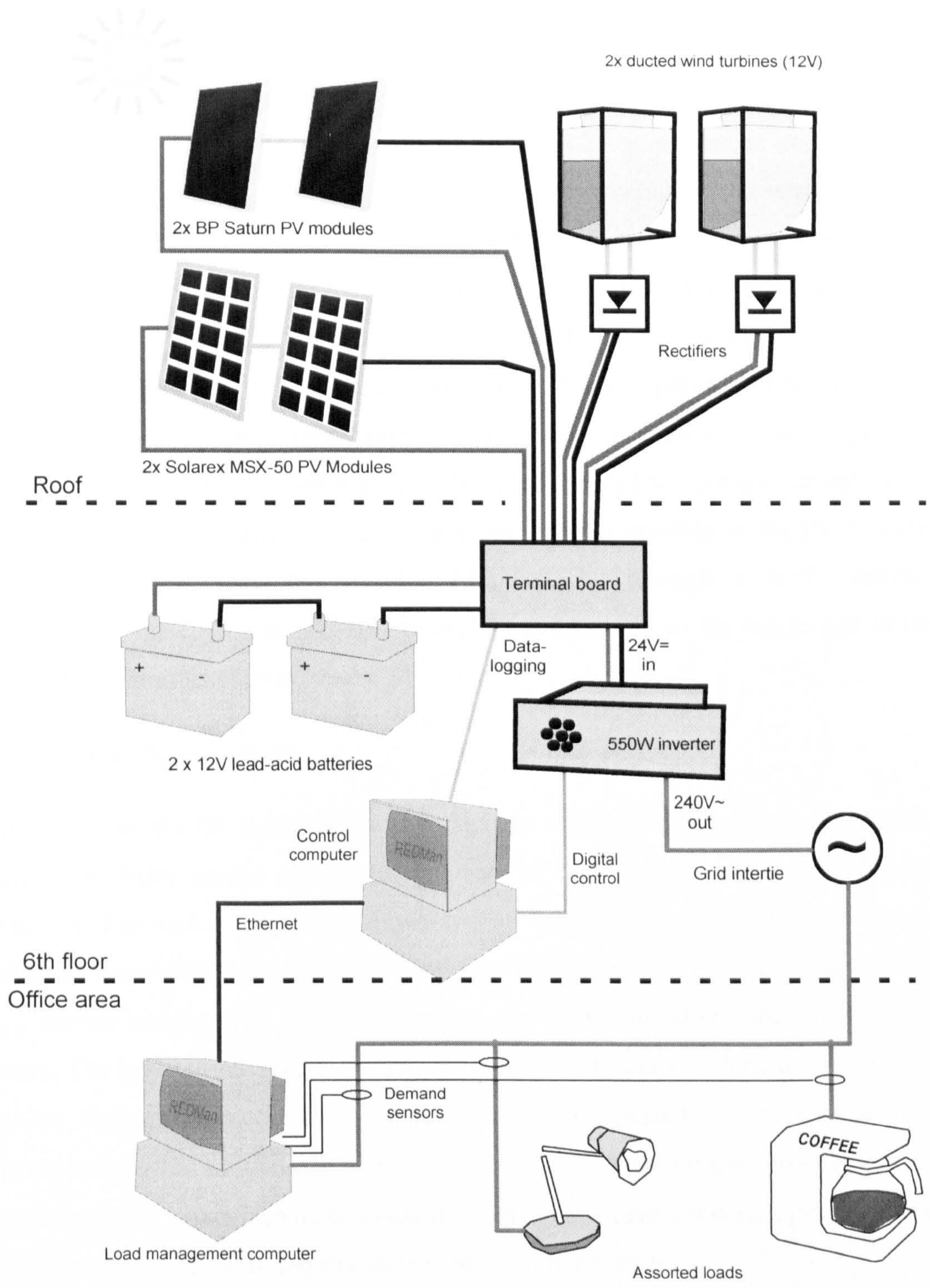

(Fig 6.1: Layout of the test-bed)



### 6.4.3. Layout

The proper siting of the various parts of the system required some thought. Firstly, and most obviously, the PV modules would have to be sited outside and high up, where they would not be shaded by other structures. A suitable spot was the south edge of the roof of the University's James Weir building. Next, to minimise electrical losses in the wiring, the rest of the DC equipment would have to be sited as close to the generators as possible. And, since there would be a large amount of sensitive signal wiring between the DC measuring shunts, the computer, and the inverter, which would pick up interference unless made as short as possible, it was logical to site all this apparatus in the same place. That place proved to be a convenient room on the top floor of the James Weir building, as close as possible to the PV module mounting location, with the power cables led out through a roof window. Nevertheless, the cable run was still around 20 metres, and so the cables had to be oversized to minimise power losses.

### 6.4.4. Power wiring

Cabling for all the DC equipment was brought to a custom-made distribution board, constructed from acrylic sheet with bus-bars of copper strip and steel bolts for terminals. The wiring diagram is shown in Fig. 6.2. The generators (two PV arrays and two ducted wind turbines) and dump load connected to these via fuses and 10-amp current shunts. The battery connected via a 30-amp shunt and an isolation switch. The inverter was connected directly across the busbars with neither a fuse nor a shunt. Owing to the currents of up to 30A (RMS) expected in these connections, and the assumption for the sake of power calculation that volt-drops in the DC wiring were negligible, it was important to use the shortest and heaviest cables practical, and not to include more fuses and shunts than absolutely necessary.

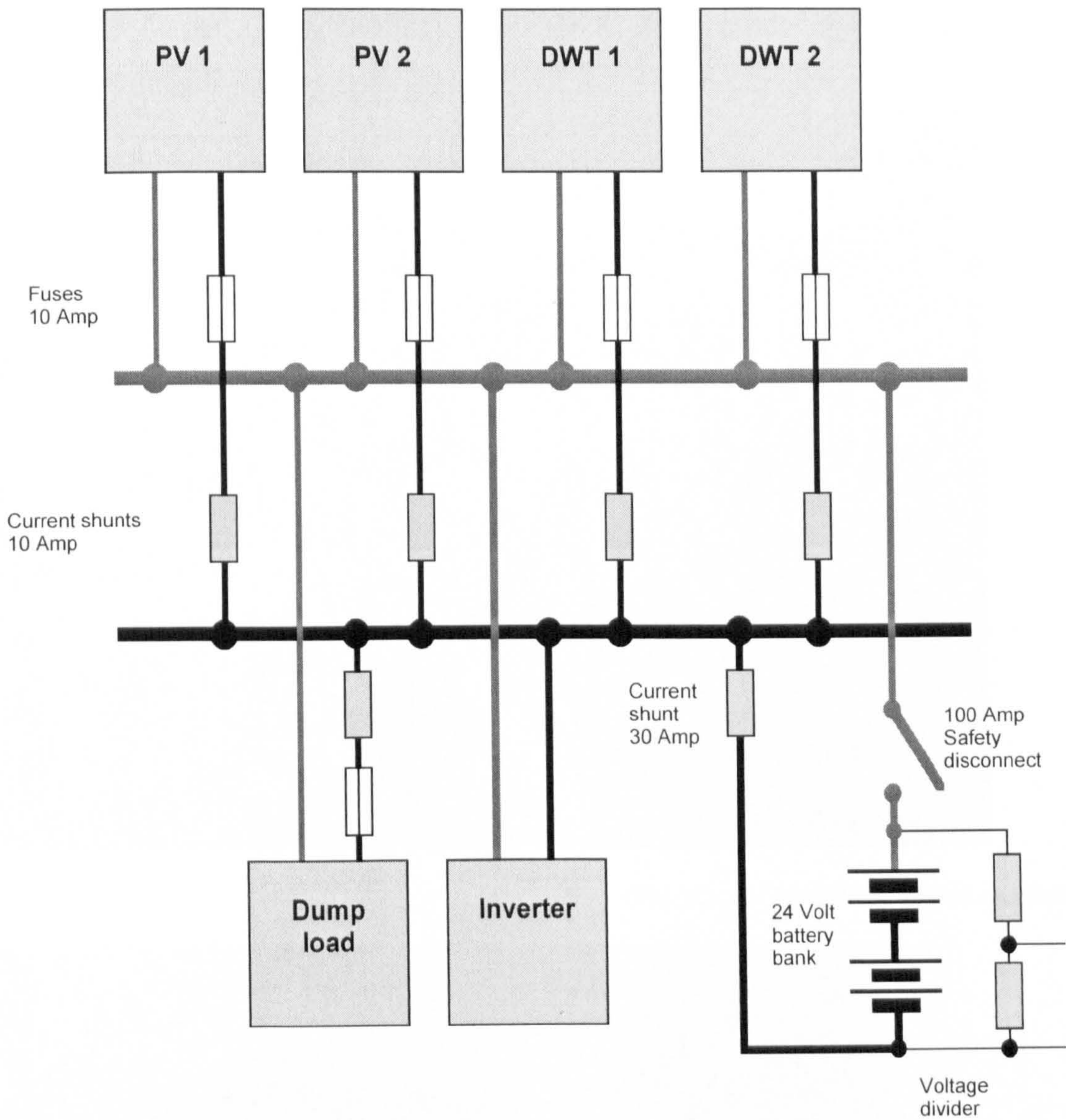

(Fig. 6.2: Wiring diagram of DC equipment/terminal board)





(Fig. 6.3: PV Modules mounted on roof)

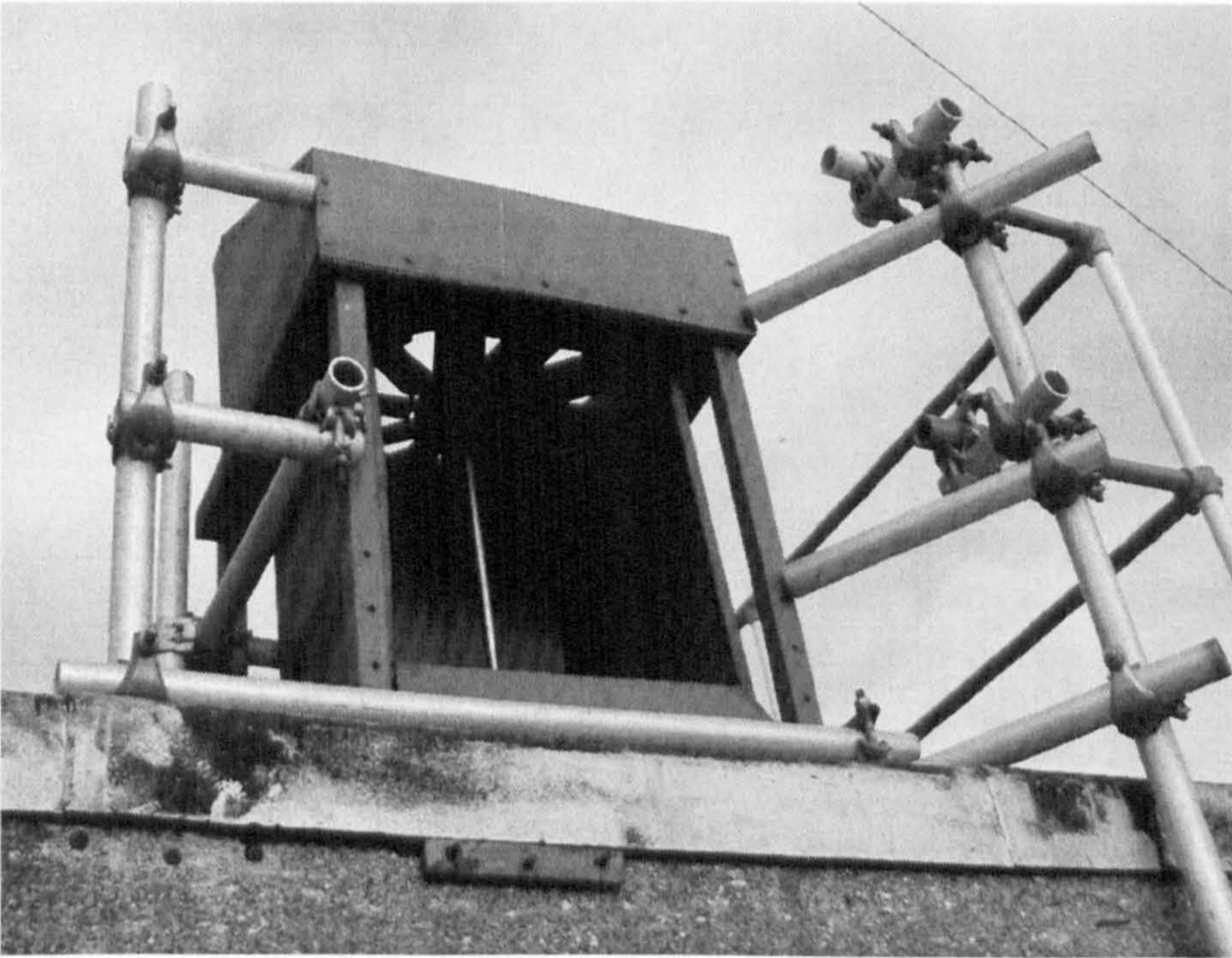

(Fig. 6.4: Ducted wind turbine)



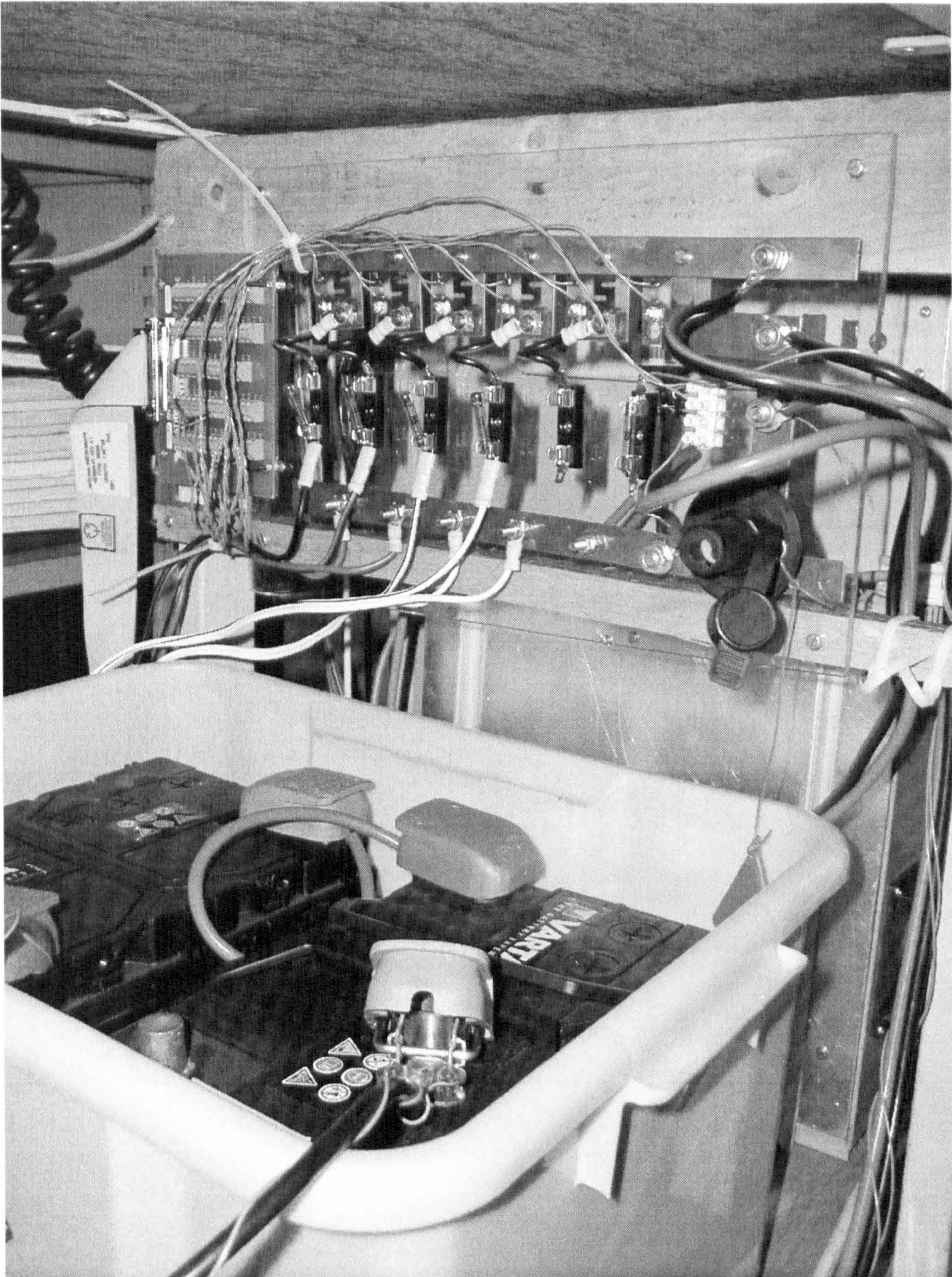

(Fig. 6.5: DC terminal board and battery bank)



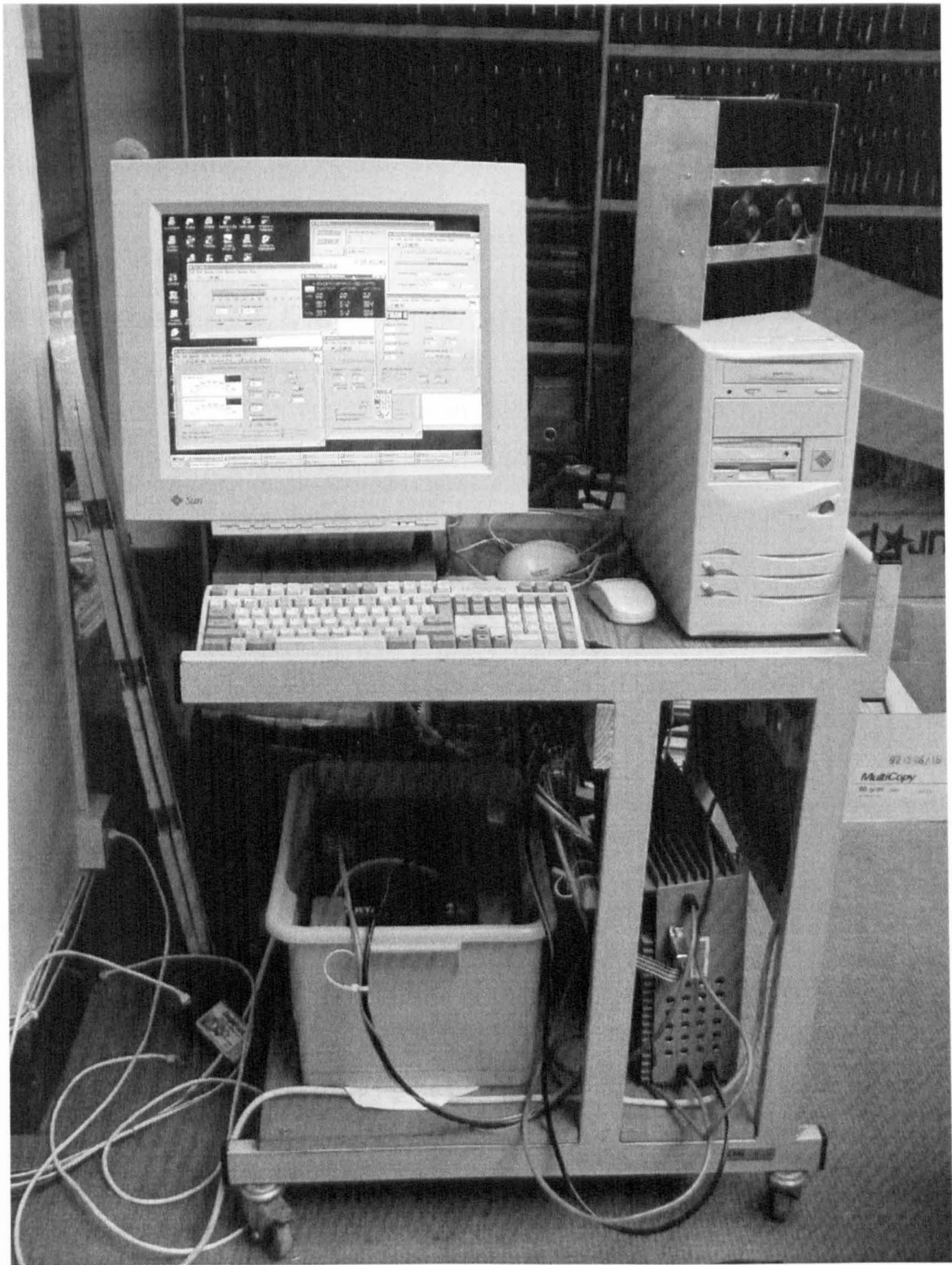

(Fig. 6.6: Complete experimental set-up)



On a similar line of reasoning, the connections for voltage measurement were made directly to the terminals of the battery, thus establishing it as the theoretical node of the DC circuit. In other words, the powers measured would correspond to the powers entering or leaving the battery. This choice was deliberate, because battery management was expected to be the most demanding application in terms of power flow measurement accuracy.

With respect to the AC side, the inverter was plugged into an ordinary wall outlet, mixing its output with the existing grid electricity. This may seem dangerous since power would be present on the pins of the inverter's plug if it was pulled out. However, in practice it is acceptable due to the inverter's fast-acting loss-of-mains protection. Pulling the mains plug represents a very large disturbance which is easy to detect, and triggers a complete inverter shutdown within 0.1 second, before the plug has even been withdrawn far enough to allow contact with the exposed pins. The loss-of-mains protection was tested extensively during development, and in every case the test rig de-energised immediately on loss of the grid: For more details see appendix A.

The prospective AC loads were in a completely different part of the building, with reliance made on the existing electrical wiring to transmit the power, and on the building's Ethernet network to communicate dispatching information.

#### 6.4.5. Signal wiring

The main part of this was between the current shunts and voltage divider on the distribution board, and the computer's data acquisition card. This was configured to give eight channels with differential inputs, which were taken up by seven current shunts and one voltage divider. Single-ended inputs are impractical for use with current shunts, because the common-mode signal due to volt-drops in wiring can be much larger than the voltage of interest developed across the shunt itself.

The variable dump load required a control voltage of approximately 1-5V to operate it over its full range of currents. Since the DAQ card did not have any proper analogue outputs, an R-2R ladder was used with its digital outputs to make a



rudimentary 8-bit DAC. The dump load input was connected directly to the resistor ladder output.

The inverter connected directly to the computer's printer port. (Interface details in appendix A)

The one remaining connection was an Ethernet cable linking the computer to the campus network, and thus eventually to another computer in charge of the AC loads.

#### 6.4.6. Testing

Initial tests were restricted to checking functionality of the system components and looking for any interference between them that could not have been found when they were tested separately. In this respect, the biggest worry was that the inverter would generate electrical noise which would make accurate measurements impossible. All possible precautions were taken against having it give out high-frequency switching noise, but it was theoretically inevitable that in generating a sinusoidal output, the current drawn from the DC bus would be a sine-squared waveform. Since this is only of twice mains frequency (i.e. 100 Hz) and of high amplitude (50A p-p at full power) filtering it down to a small amplitude would require very large filtering components, and so would not be very practical.

Luckily, a solution was at hand in the form of digital filtering. By having the DAQ card take several samples and calculating the mean value, a simple low-pass filter was implemented in software. Sampling at 1,000/sec and taking the mean of successive blocks of 100 samples was found to reduce the ripple to an acceptable level, although at rather a high cost in terms of computing power.

#### 6.5. *Summary*

Hardware design issues related to grid interconnection and component choice were investigated. An experimental test-bed consisting of four PV modules, two wind turbines, a 24-volt lead-acid battery bank, a grid-connected power inverter, a dump load, and a data acquisition/control computer was assembled and commissioned successfully. The inverter and dump load were designed and built especially for this

project (See Appendices A, B) as also were two different kinds of demand sensors (Appendices C, D).

The next step is to develop and test the agent programs that interface the experimental hardware to the dispatching system.

## **6.6. References**

1. 'Electricity Supply Regulations 1998', HMSO, 1998. Part VI, Section 26, and Schedule 3. Available online at [http://www.hmso.gov.uk/si/si1988/Uksi\\_19881057\\_en\\_1.htm#tcon](http://www.hmso.gov.uk/si/si1988/Uksi_19881057_en_1.htm#tcon)
2. 'ADE7755 Energy Metering IC with Pulse Output', datasheet, Analog Devices Inc., 1999. Available online at <http://www.analog.com>



## **Chapter 7: Agent software**

This section covers the development of agent programs. The term “agent” is used here to denote programs which interface between actual energy storage/conversion hardware, and the dispatching engine. The basic philosophy and assumptions as to the roles of agent and dispatcher were developed in chapters 2 and 3. To recap: In the case of a generator, or other source of power, its agent informs the dispatcher of the maximum possible power it can generate, and the per-unit cost of this power. The dispatcher replies with the actual power that it requires of the generator. In the case of a load, its agent tells the dispatcher how much power is required, and what per-unit price it is prepared to pay. The dispatcher returns a yes/no answer as to whether the load may run or not.

### **7.1. A battery management agent**

REDMan divides network entities into two classes: energy sources and energy demands. However, it would seem that an energy store does not fit this classification because it could be either, depending on whether energy is entering or leaving it. This is not a problem, because a single energy store can be represented as two separate objects in the REDMan world: an energy source and an energy demand. The problem is rather one of deciding just when the energy store should buy energy and when it should sell it, and indeed when it should do neither. It was argued earlier that this is not REDMan’s job; it simply acts as a trading centre where supplies and demands are matched. The business of how much to supply or demand, and when to do it, is left to software agents acting on behalf of the loads and generators. So, the task would be to create an agent for a battery storage system.

#### **7.1.1. Why batteries?**

There are many energy storage technologies, from compressed air to flywheels and ultracapacitors. But, lead-acid batteries recommended themselves straight away for this application. Being a 120 year-old technology, their behaviour is very well understood and characterised (if not entirely simple). And unlike the more esoteric technologies, they can be bought cheaply over the counter. However, they have

certain odd behaviours which will need to be taken into account when designing the management system.

### 7.1.2. How lead-acid batteries work

The operating principle of the lead-acid battery is well known. It consists of a positive plate made of lead dioxide, and a negative plate made of metallic lead, immersed in an electrolyte of sulphuric acid. As the battery is discharged, both plates are converted to lead sulphate, and the acid concentration of the electrolyte decreases. Upon recharging, the plates return to their original composition. This seems simple enough, but in practice there are a number of peculiarities which make things more challenging. The most exasperating feature, from the energy metering point of view, is that the capacity and efficiency of the battery is not constant, but varies in a complex way. To understand this behaviour, a more detailed examination of battery physics is called for. First of all, what is meant by ‘capacity’? From an energy systems point of view, it would be defined as the amount of energy contained in the battery which is available for use. This is the quantity that the control algorithm will need to know in order to make its decisions. But how can it be derived from the battery parameters that are directly measurable?

In electrical terms, energy is the product of voltage, current and time. Now, the product of current and time, i.e. charge, is the basic measure of electrochemical reactions. The rules of chemistry dictate that ‘X’ coulombs of charge will always cause the reaction of ‘Y’ moles of substance. Hence, the mass of reactants available in a battery sets a definite upper limit on the amount of charge that can be stored in it. This is why batteries are specified in terms of ‘amp-hours’, and this is the accepted definition of capacity; the number of amp-hours available from a battery.

### 7.1.3. Variation of capacity with discharge rate

The catch is that the available mass of reactants is not constant. In order to maximise the surface area of material that can participate, and hence the capacity, battery plates are made porous, rather like a sponge made of lead. As the battery discharges, the surface of the plates is covered in lead sulphate. At low rates of discharge, it builds up evenly, and the reaction proceeds until most of the lead has been converted. But,



at high rates of discharge, the resistivity of the electrolyte in the pores comes into play and causes current to flow mostly from the outside surface of the plate. More current means more lead sulphate created, and so the sulphate builds up mostly on the surface, blocking the pores so that the lead inside cannot react. The net effect is that the capacity seems to vary with the discharge rate, with the battery seeming to run out sooner than expected at higher currents. The actual capacity does not really change, though, because the unreacted material is still present, so if the battery is allowed to rest for some time, it may recover.

The precise relation between capacity and discharge rate is a complex function of the battery construction, and also of time; a battery which has been discharged at a high rate will recover to a higher apparent state of charge a while after the discharge is finished, as the sulphate tends to redistribute itself more evenly. The process has been modelled in various ways to high levels of detail [1], but a reasonable approximation can still be had by the 100 year-old equation known as Peukert's Law, which relates discharge current, time, and capacity:

$$I^n t = C$$

(Eq. 7.1)

Or, in terms of capacity, substituting  $Q=It$ :

$$Q^{(n-1)} t = C$$

(Eq. 7.2)

In Eqs. 7.1, 7.2:  $I$  is current,  $Q$  is estimated capacity,  $t$  is time,  $C$  and  $n$  are constants found experimentally for a particular kind of battery. ( $C$  is related to the battery capacity,  $n$  typically is between 1.20 and 1.45)

So, by measuring the discharge current and using Peukert's Law, an estimate of the available capacity can be found. But the problem is not solved yet, because the answer is in amp-hours of charge, not the available watt-hours of energy. To calculate this, the battery voltage must also be considered.

#### 7.1.4. Factors affecting battery voltage

Unfortunately, just as the capacity varies from its nominal value, so does the battery voltage. A single lead-acid cell nominally gives 2 volts. But, when the cell is almost discharged, the voltage can be only 1.6V, and when it is reaching the end of a charging cycle, it can rise as high as 2.4V. Thus, a '12-volt' lead-acid battery can give anything between 9.6 and 14.4 volts. This change in voltage is brought about by three mechanisms. First is the 'polarising voltage'. The chemical reactions in the battery, being irreversible, require energy to drive them. They draw this energy from a small voltage drop associated with the reaction. The size of this drop depends on the current drawn, the state of charge, and the temperature. The polarising voltage is a log function of the current, and is zero when the current is zero.

Second, even in the absence of any current, the open-circuit voltage depends on the state of charge and the temperature. The dependency is approximately linear in both voltage and temperature.

Thirdly, the electrical resistance of the battery causes a voltage drop proportional to the current. The internal resistance is usually very small, and so this component can often be ignored.

The voltage measured at the battery's terminals is the sum of open-circuit voltage, polarising voltage, and voltage dropped across the internal resistance, and so varies with state of charge, current, and temperature. Modelling these variations in voltage will be key to making an accurate estimate of the remaining usable energy at any time. But, here there is a serious problem, because all of the relationships discussed above are subject to change as the battery ages.

#### 7.1.5. Ageing and service life

There are many mechanisms at work here, but this discussion will be limited to the two most likely to affect a battery in cyclic service. The first is simply a reduction of the amount of active material; lead sulphate takes up more room than metallic lead, and so with each cycle of the battery some of the plate material is literally prised off by the growing sulphate crystals and falls to the bottom of the battery case where it is of no more use. The amount of material shed in each cycle depends on the depth of



discharge. Secondly, if the battery is allowed to stand for a length of time while discharged, the lead sulphate tends to change to a different crystal structure. This new structure is very difficult to recharge, and so areas of the plate that have become 'sulphated' in this way are rendered useless. The seriousness of this effect depends on the area of plate vulnerable to sulphation, and on the length of time for which it is exposed. Both of these mechanisms cause a reduction in the effective capacity, and a corresponding increase in internal resistance. To give an accurate estimate of available energy, this must also be taken into account.

#### 7.1.6. Calculating energy content: not easy?

With all these effects at work, modelling a lead-acid battery could well be a difficult job. Nevertheless, it has been done in considerable detail [2] although models for ageing are less common. The main objection to this approach is the amount of experimental effort required to characterise the battery in sufficient detail. To gather data on capacity variation with discharge rate, multiple charge and discharge cycles at various different rates must be done, which takes a lot of time and generates a lot of data to be processed. More worryingly, the mere act of cycling the battery ages it and so reduces its capacity over the duration of the experiment; the battery you finish the series of experiments with is not the same one you had at the start. Gathering data on ageing effects is more time-consuming still, and involves the destruction of at least two batteries. And, even if the experiments could be done, there were grounds for suspecting that a fully-detailed model would not be very robust, merely because of its complexity. The difficulties of making a full model seemed very discouraging. So, it was decided to take a more basic approach, and make do with the simplest model that would give reasonable results.

#### 7.1.7. A simpler battery management model

To assist in making this new model, battery management practices currently used in industry were reviewed. The information presented in 7.1.8 and 7.1.9 is compiled from several sources, including textbooks, websites, books and magazines aimed at renewable energy and electric vehicle designers, e.g. [3, 4, 5, 6].

### 7.1.8. Estimating capacity

The traditional method of finding the state of charge is by measuring the specific gravity (density) of the electrolyte. Since the acid concentration is proportional to the state of charge, and the densities of water and acid are different, it is easy to infer the state of charge from the density of the mixture. This method is accurate, provided that the water and acid are evenly mixed throughout the cell, the temperature dependence of density is taken into account, and any water lost from the cell is replaced before measurement. The measurement is done using a hydrometer, which is inserted into the cell and sucks up a sample of electrolyte into a chamber containing a graduated float. Better-quality hydrometers also include a thermometer for temperature compensation. The hydrometer method has been used for many years and is simple and inexpensive; the equipment only costs a few pounds. However, there are a few drawbacks; it is difficult to automate because automatic sensors of density are complex and expensive, and it is not applicable to sealed battery types (e.g. 'gel cells') where the electrolyte is not accessible.

A readout of the estimated remaining capacity (or run-time) allows planning of recharges and so makes battery-powered equipment more useful. So, with the increasing use of rechargeable batteries in consumer products, more advanced ways of determining state of charge have been developed. The simplest of these is current-compensated voltage measurement. This relies on the fact that the terminal voltage is affected by the electrolyte concentration, which in turn is proportional to the state of charge. Of course, the terminal voltage also depends on the current drawn, but by measuring the current, its contribution can be compensated for. In the simplest form of this system, a known current is taken from the battery, and the voltage measured directly. Often, the current draw of the equipment itself is quite constant, and only the voltage need be measured. This is the principle behind the ubiquitous 'low battery' indicator light. More advanced implementations use an actual measure of the current, and may also measure battery temperature, since this affects the voltage too. Where the current can fluctuate widely, time averaging of the result is used to hide any transient errors in the calculation [4]. This method can be reasonably accurate, and is applicable to almost every battery chemistry, not only lead-acid. Some battery types have very little change in voltage with state of charge, though, the worst



offenders in this respect being nickel-cadmium batteries, whose voltage remains constant until the last of the charge is used up, and then suddenly collapses. In cases such as these, voltage measurement is almost useless.

The final, and most sophisticated method is the charge meter. The heart of this system is an electronic coulomb meter connected in series with the battery which measures the actual quantity of charge entering and leaving. The coulomb meter works by measuring current and taking the time integral. Of course, where integration is involved, there is always the possibility of errors building up to an unlimited extent, and so this method relies on a secondary means of resetting the coulomb meter to a known state. Commercially-available systems use a voltage measurement to do this; when the terminal voltage exceeds a certain amount, the battery is considered to be full and the meter is reset [5].

The charge meter method is applicable to all known battery chemistries, since every chemistry shows a rise in voltage during charging once the battery is full. In its basic form, it takes no account of the capacity's dependence on discharge rate and battery ageing, and is usually calibrated in 'amp-hours out'; the number of amp-hours extracted from the battery with reference to its fully-charged state. The user is left to estimate what fraction this represents of the available charge. Some commercial charge meter products [6] provide a readout in percent remaining, or miles of range for electric vehicle applications, and it might be inferred from this that they have proprietary ways of compensating for capacity variation with discharge rate.

#### 7.1.9. Taking care of batteries

Lead-acid batteries have been in use for over 100 years, and in that time, a great amount of empirical experience has been gained in how to treat them for optimal performance. Today, this body of knowledge is summed up by a few simple rules, which will be reviewed here. These guidelines apply to batteries in cyclic service, as in renewable energy systems.

1. Lead-acid batteries do not like to be discharged more than absolutely necessary and should certainly never be discharged completely. The exact amount of discharge tolerable depends on the battery design; purpose-built deep-cycle

batteries can withstand perhaps 2,000 cycles to 20% capacity (i.e. 80% of charge extracted), standby and automotive types perhaps 500 cycles to 70% capacity [7].

2. Lead-acid batteries should not be allowed to stand discharged any longer than necessary. A battery which is left completely discharged will be destroyed in a few months.
3. The maximum allowed charging current depends on the state of charge; it is very high when the battery is almost empty and tapers off as it charges. This requirement is usually met by a constant-voltage charger with current limiting.
4. Charging is considered complete when the terminal voltage reaches 2.4 volts per cell (i.e. 14.4 V for a nominal 12-volt battery)
5. The battery should be overcharged occasionally (e.g. once a month) by maintaining the voltage at 2.4V/cell for a few hours. This is known as 'equalisation' and ensures that all cells in a series-connected battery receive a full charge even though some might have a slightly different capacity to others. It also produces gas bubbles which ensure mixing of the electrolyte. This should not be taken to excess or water loss will result.
6. Electrolyte level should be checked from time to time (e.g. every three months) and any loss made good with de-ionised water.

#### 7.1.10. Using these ideas

How can these rules and methods of measurement be transformed into a computer program for managing batteries optimally? First of all, note that it is the act of discharging that wears the batteries out. So, if it was desired to manage the batteries for maximum life, then they should never be discharged at all. But, batteries which cannot be discharged are obviously of no earthly use. So, the object of management cannot be to maximise the life. Is it to maximise the amount of energy delivered from the store? No, because this means completely emptying the battery on a regular basis, and so wearing it out prematurely. The object of battery management should probably be to reconcile the conflicting goals of delivering the most energy, and making the battery last as long as possible; in other words, to deliver the maximum benefit from the battery. This can be defined as the ratio of how useful the battery is



(expressed as a price some user is willing to pay for the energy taken from it) to the cost of the damage being done to the battery by supplying that energy. In order to calculate this ratio, a means of costing the damage done to the battery is needed.

#### 7.1.11. A model for battery wear and tear

Earlier it was seen that there are two main mechanisms of damage in a lead-acid battery: sulphation of the plates due to being left in a discharged condition, and shedding of active material due to excessive depth of discharge. It seems obvious that the main factors affecting sulphation are depth of discharge (only discharged areas of the plate are affected) and time (the longer it is left, the worse the effect). Bearing this in mind, a simple model for estimating sulphation can be proposed.

Consider an elemental area of plate  $a$  which is so small that it can only hold one quantum of charge. So, its depth of discharge  $DOD$  is either 0 (full) or 1 (empty). Next it is assumed that the probability of it becoming sulphated is zero if it is full and  $P$  if it is empty. Once it has become sulphated, it is out of service forever. So, an expression can be written for the probability  $S$  of this small area becoming sulphated in a given time interval:

$$S = P\Delta t \times DOD$$

(Eq. 7.3)

From this can be derived the number of small areas  $N_s$  which are liable to become sulphated in this time interval. This of course assumes that the sulphation of an elemental area is a random event and that the total number of elemental areas  $N$  in the battery is large.

$$\frac{d}{dt} \left( \frac{N_s}{N} \right) = S$$

(Eq. 7.4)

Then, remembering that an area once sulphated stays that way, the above expression can be integrated to find the fraction of the battery's plate area which will have become sulphated over the period of time in question. Substituting 7.3 into 7.4 and integrating with respect to time:

$$\frac{N_s}{N} = P \int DOD(t) dt + C$$

(Eq. 7.5)

where  $C$  is a constant equal to the fraction of plate already sulphated at  $t=0$ . Note: Since this integral is the sum of a large number of small areas, the overall DOD can now be other values than 0 or 1.

Now, when the plates are completely sulphated the battery will be useless and will need replacement. In this case, equation 7.5 will be equal to unity, and the financial penalty will be equal to the cost of the battery. So, multiplying equation 7.5 by the cost of the battery completes the model.  $P$  and  $N$  may be lumped into one empirically-derived constant  $TTF$ , which may be pictured as the time taken for the battery to wreck itself completely if it was left totally discharged.

$$P_s = \frac{C_b}{TTF} \int DOD(t) dt$$

(Eq. 7.6)

The shedding of active material must also be allowed for. Some research has been conducted on this, mostly by battery manufacturers desiring to improve the life of their products. Published data [7] suggest that the amount shed is proportional to the total integrated discharge capacity. This could be quite complicated to deal with, but as a first approximation, it could be assumed that the amount of material shed in the course of a given discharge is proportional to the depth of the discharge. Then, by a similar line of argument to the previous section:

$$P_c = \frac{C_b}{CTF} \max(DOD(t))$$

(Eq. 7.7)

where the various factors are again lumped into an empirically-derived constant  $CTF$ : the number of cycles to 100% D.O.D. required to destroy the battery. ( $\max$  denotes the largest value observed over the cycle.) Of course, this model assumes that the proportionality is linear; in other words, if discharging the battery to 50% dislodges one unit of plate material, then discharging it to 100% will dislodge two units, and so on. Proving this experimentally is such a long and involved process, and



the result of such limited application, that it is hardly if ever done, and so it proved impossible to find data which would confirm or deny this assumption. Actually performing the experiments is beyond the scope of this research. So, this model should not be considered accurate, but rather as a temporary measure which is just good enough to help prove the general concept.

#### 7.1.12. Practical implementation

In order to implement the model, thought needs to be given to the conditions under which the equations are valid. A battery in energy storage service with REDMan will probably have energy flowing in and out almost at random. So, the battery may charge a little, discharge a little, charge some more, sit idle for a time, and so on. On the other hand, most theories of battery functioning (and ours are no exception) assume a single discharge starting with the battery full and ending at the desired depth of discharge. Adapting the model to this different regime of operation will require some more consideration of the details.

The general plan of action consists of allowing the battery to buy and sell energy as required, all the time monitoring the depth of discharge, and using the model to estimate the cost of wear and tear. When this looks like exceeding the profit made by buying and selling energy, something should be done about it that will cut losses. That ‘something’ is obviously to stop selling any energy and to allow the battery to recharge as quickly as possible until it is full. Of course, this process carries a cost too; the energy for recharging costs money, and there is still area susceptible to sulphation until the battery is completely recharged. Both of these costs can be calculated if it is known at a given time how much energy is needed to refill the battery, how much it will cost, and how long it will take. Knowing these quantities, an estimate for sulphation during recharge can be added to the model:

$$P_r(t) = C_b \frac{TTR}{TTF} \frac{DOD(t)}{2}$$

(Eq. 7.8)

and an estimate for the cost of recharging:

$$C_r(t) = \frac{DOD(t)}{\eta_r} C_e Q_{nom} V_{nom}$$

(Eq. 7.9)

where  $\eta_r$  is the charging efficiency,  $C_e$  is the cost of electricity,  $Q_{nom}$  is the nominal (20-hour) capacity, and  $V_{nom}$  is the nominal voltage.

Now that the model is complete, it is time to consider how the information that it needs might be gathered. The data needed are:

- Depth of discharge
- Maximum depth of discharge
- Estimated time to recharge
- Estimated price of recharging

Depth of discharge can be estimated by one of the capacity-measuring techniques investigated earlier. The chosen method is the coulomb meter, because it does not depend on properties of the battery which would have to be measured experimentally. Maximum depth of discharge is easily derived from this using a peak-detection routine. The estimated time to recharge can be found by averaging the incoming energy over the previous week.

It is also time to consider what can be done with the output of the model. This is a cost representing how much the battery wear and tear will cost if discharge was stopped at the present time, and the battery recharged completely at a rate similar to previous charge rates. A logical step would be to calculate the profit returned by the battery. How is profit defined? The income of electricity sold since the beginning of the cycle, less the expenditure of electricity bought. These figures are easily available from the REDMan engine. Subtracting the modelled wear cost from the profit gives the expected profit if sales were stopped immediately and the battery recycled.

A spreadsheet calculation was done to show the performance of the model over a discharge, with parameters estimated as roughly representative of the batteries used in actual experiments. Since battery operation is not economical compared to grid electricity, the selling price had to be inflated to 50p/kWh. The buying price was



assumed a token 0.1p/unit, which was REDMan pricing for PV power at the time. Figure 7.1 shows a graph of the estimated profit. Since wear cost is quadratic with depth of discharge, and income is linear, the result is parabolic, of the form  $bx-ax^2$ . Therefore, two courses of action suggest themselves. The greedy model will terminate the cycle at the maximum (turning point) of the parabola, for maximum profit. The altruistic model will terminate it where it intercepts the x-axis, so as to just break even. A compromise between the two could of course be arranged, by terminating it at a target profit value after the turning point.

Of course, these economic issues are specific to the particular storage system used. Lead-acid batteries just happen to be a very expensive way of storing energy once all the loss and wear mechanisms are taken into account. Other systems, such as flywheels, regenerative fuel cells, superconducting magnetic energy stores (SMES), and the like, may well be much more favourable.

### 7.1.13. Practical implementation

The next step was to connect this model to the actual battery bank, and the REDMan environment. The model would be combined with battery control logic, and REDMan buying/selling agents, into a single battery management program, named (obviously) 'BatMan'.

Within this program, collecting data on power bought and sold, and its cost, was easy enough, the data being available from the REDMan subroutines. The one problem was that REDMan's native units of energy are "watt-timesteps", and the timestep, nominally 5 seconds, was quite poorly controlled in the prototype environment. The solution to this was a conversion routine that measured each timestep by means of the computer's internal 1-millisecond clock, and so converted accurately to watt-milliseconds, and then trivially to watt-hours. The bought and sold values were accumulated in separate integrating registers, multiplied by the respective prices, and the difference taken.

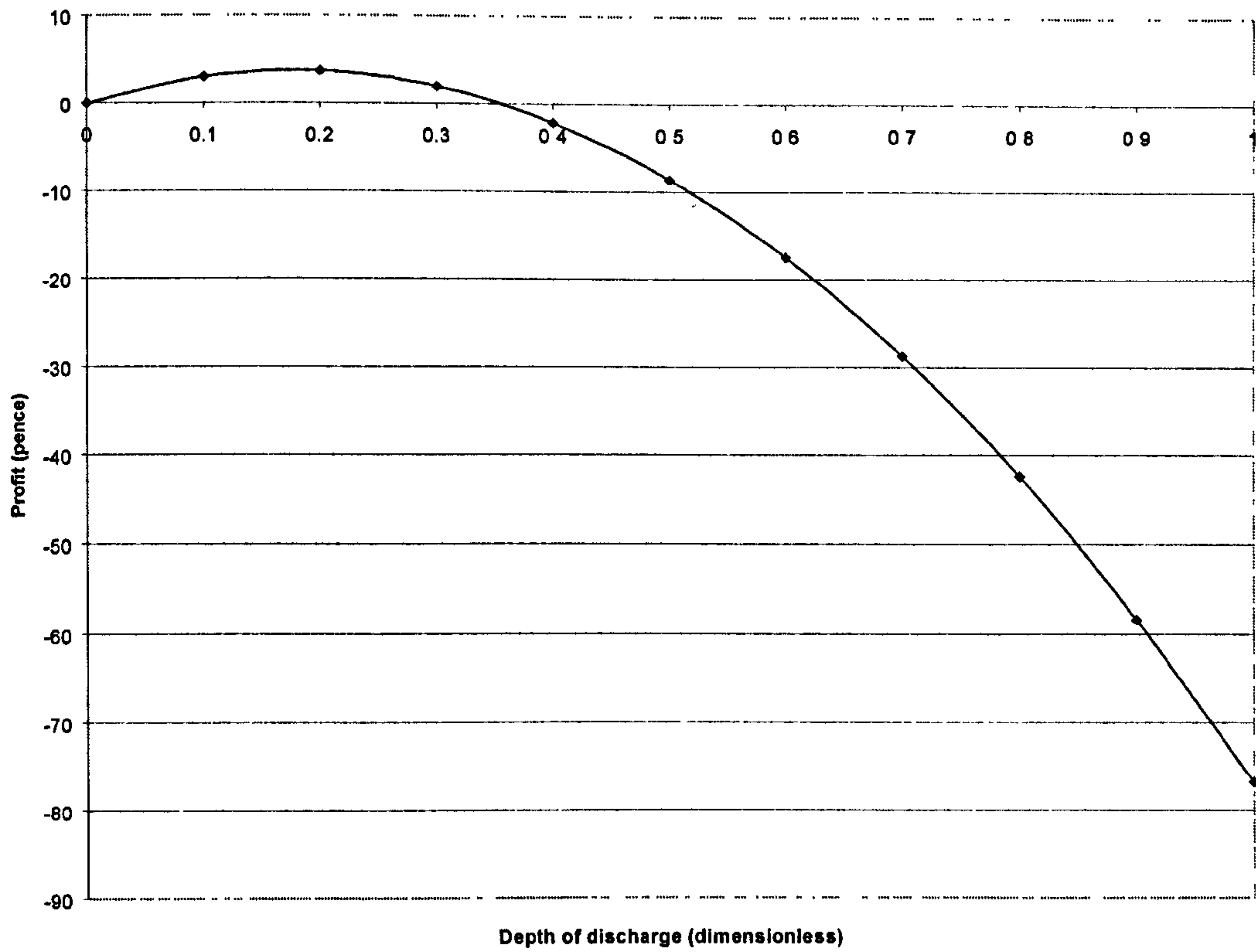

**(Fig 7.1: Profit vs. depth of discharge for a sample run of economic battery management.)**



Collecting data on depth of discharge was not too difficult either. Data acquisition routines had previously been written, which supplied the battery terminal voltage and current to any other program requiring it. So, it was a simple matter to write a coulomb meter program, which ran once per timestep (like all subprograms of BatMan) multiplied the measured current by the measured length of the timestep, and added it to an integrating register. Provision was made for the integrator to be reset by an external signal. The coulomb meter employed correction by Peukert's law, according to the magnitude of the measured current, so that it could give an estimated depth of discharge.

The wear cost model equations were also solved once per timestep, using the depth of discharge from the coulomb meter program, both normal, and peak detected. The peak detector was to be reset by the same signal that reset the integrator. The output from the energy bought/sold routine was subtracted from the wear cost to give the expected profit, updated every timestep.

Executive decisions in BatMan were taken based on the expected profit, and also on the battery voltage relative to float and equalising thresholds, and an equalising timer. The basic course of action, according to the battery management techniques discussed earlier in this section, was this:

Allow the battery to buy or sell energy, unless:

- The voltage goes above the float threshold, in which case, sell only.
- The expected profit falls below zero, in which case, go into recycle mode.

In recycle mode, buy energy only. When the voltage rises above the equalising threshold, start the equalising timer. When the equalising timer finishes, reset all integrating registers in the program (assumed that the battery is now totally full) stop buying, and return to sell mode.

These rules were easiest implemented in software as a state machine, which is a well-known concept in digital logic systems (see [8]). It determines its current state based on the previous state and its inputs. The state diagram is shown in figure 7.2. The only

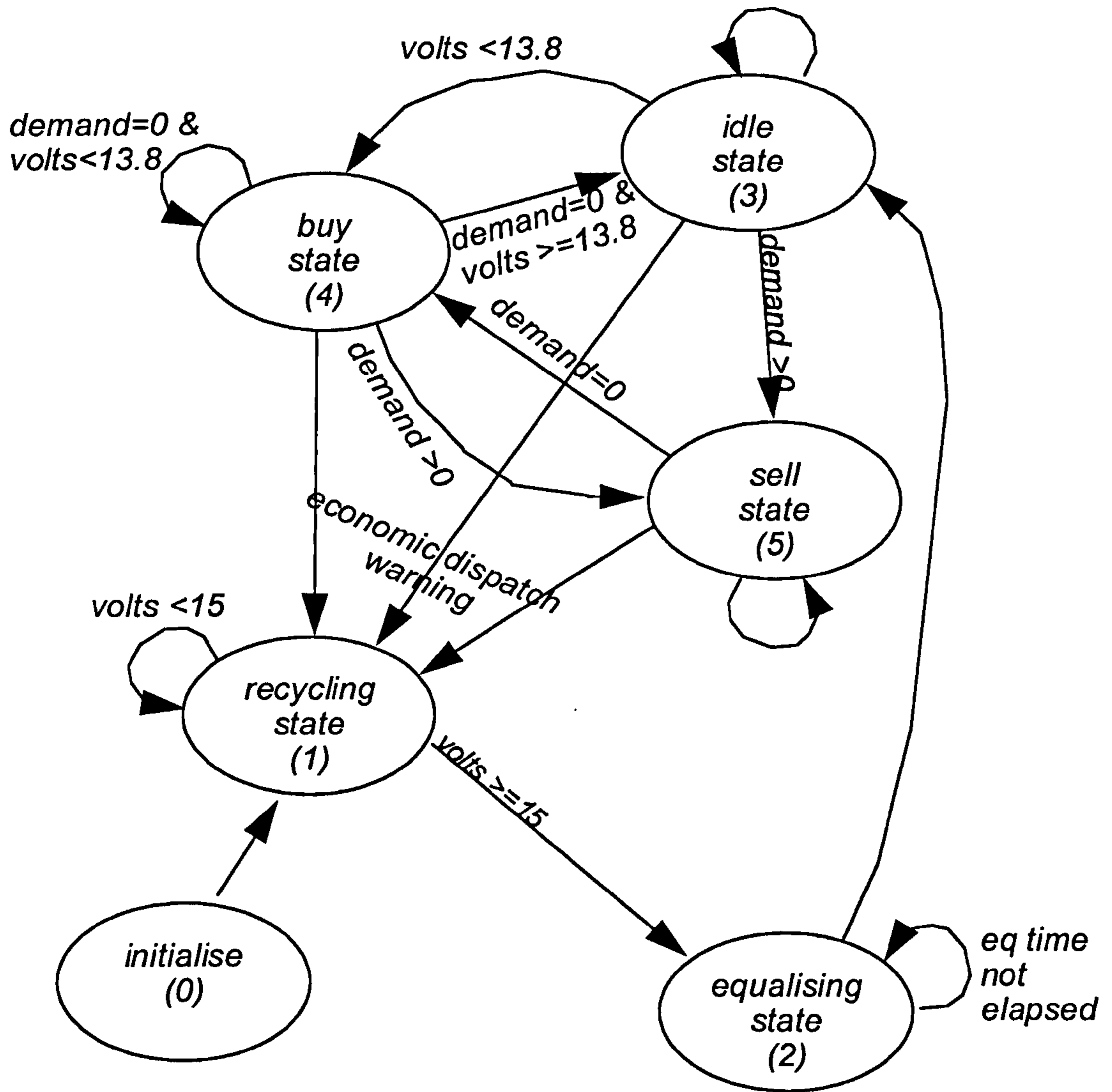

- Idle state:* Neither buy nor sell power
- Buy state:* Buy any available power (considering set price)
- Sell state:* Advertise power for sale
- Recycling:* Buy any available power with no selling allowed
- Equalising:* As recycling until battery voltage has been high for a few hours
- Initialise:* When program first run

(Fig. 7.2: State machine for battery management.)



new feature is the initial state, which was not specified in the above rules, but which every real state machine must have. This is the state entered as soon as the state machine is started, by running the program. It leads to the 'Recycle' state, so that the batteries will fully charge and the coulomb meter be reset to the proper state of charge.

#### 7.1.14. REDMan connection

Connecting the system to the REDMan dispatcher proved to be something of an issue. The main problem was this: A battery being charged is not like a normal load, such as a light bulb. The light bulb always consumes, say, 60 watts. On the other hand, the battery will take whatever power is available. Unfortunately, the REDMan dispatcher had no way of understanding this; it could only work in terms of definite powers. This was a serious problem which required rewriting the dispatching engine. The result was the Opportunistic flag. This is a true/false input which appears in the communications routine used by loads. When asserted, the dispatcher treats the power value sent by that load as if it were a maximum, and if that amount is not available, it sends whatever power is available. In calculating the available power, the price paid by the load is of course taken into account. It operates on a per-load basis, so that loads using the Opportunistic flag function can be dispatched alongside loads without it.

Once this modification was made, the rest was simple enough. The powers sent to REDMan communications routines were chosen according to the state of the state machine. All powers were either zero, or a high value, larger than any foreseeable demand in the system, such as 1000 watts. Fig. 7.3 shows a functional diagram of the program. A listing of the LabVIEW program is in Appendix H, sections H.2.1, H.2.2.

#### 7.1.15. Testing BatMan

Initial testing was performed in the actual experimental system, under variable conditions of supply and demand. Once debugged, the program was observed to behave in a very similar way to an ordinary charge controller. This was exactly as would be expected, since it was modelled on one in the first place. The testing and results will be covered in chapters 8 and 9.

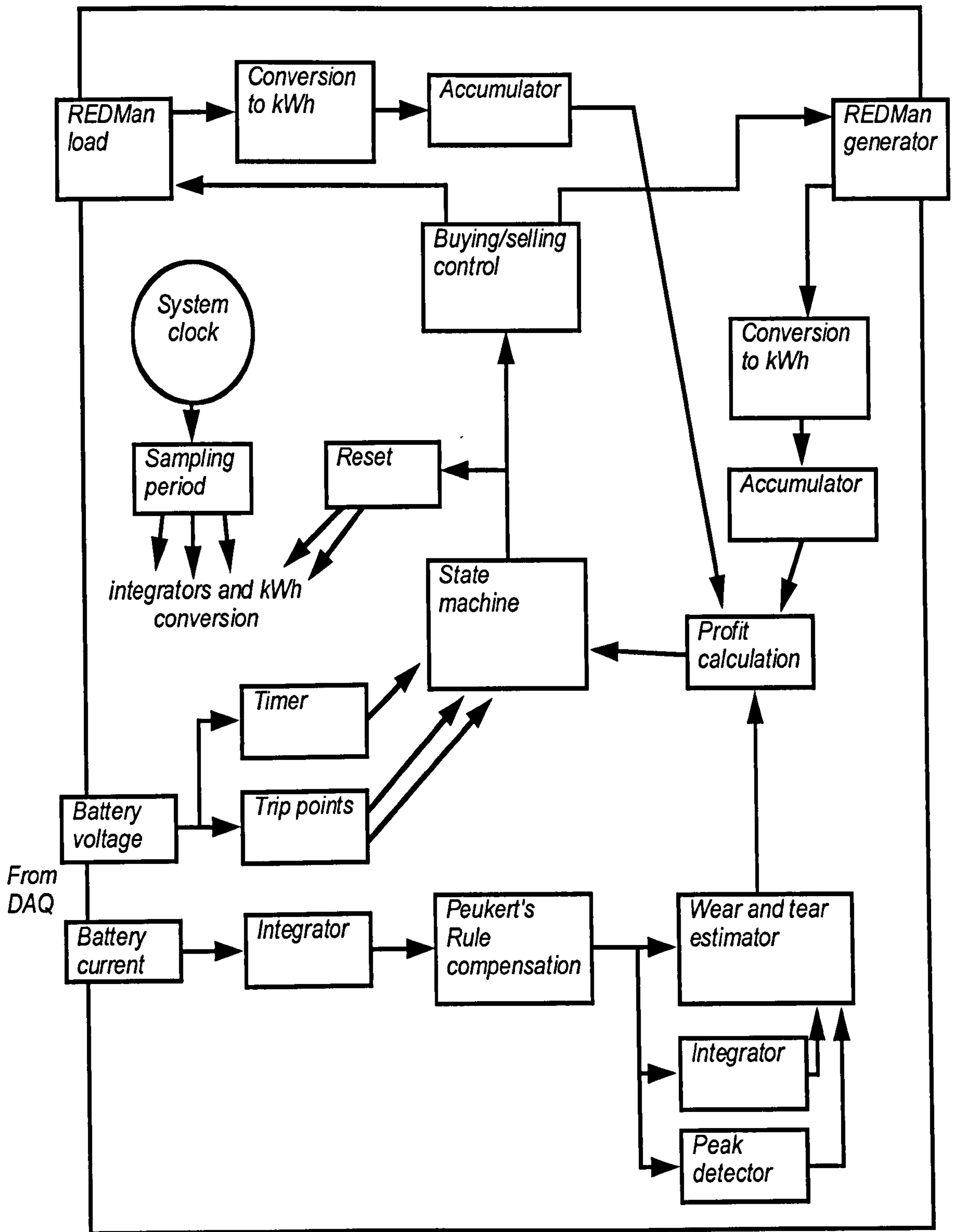

(Fig. 7.3: Functional block diagram of the battery management program)



## 7.2. Inverter agent

### 7.2.1. Design

To a first approximation, this would appear to be a simple piece of programming. The inverter agent is a double-headed combination of the ordinary load and generation agents. One head connects to the dispatcher dealing with the DC network, where it appears as a load. The other head connects to the AC dispatcher, where it appears as generation. But complications soon arise. How much AC power should the inverter advertise for sale? As much as it can get from the DC side, less its operating losses. But what if not all of the advertised AC power is bought? The answer is that the inverter should be governed by the available DC power, or the bought AC power, whichever is less. Unfortunately, this is not as easy to implement as it sounds. The nature of the REDMan system is that it cannot tell you how much power you *could* have. You either get the amount you asked for, or less than you asked for, or none. The only way to find out if there is surplus power is to try and buy more, and see what happens.

Another connected problem is pricing. The inverter has losses, and has to pay for energy that it buys. If it is to operate economically, it has to make a profit on the energy it sells, to cover the losses. This means selling at a higher price than it bought. One of the prices has to be known beforehand, either fixed by human intervention, or estimated by some other algorithm. Then the other price can be calculated. Once all these values are known, there is enough information to present to the two dispatchers, who will decide how much power is required of the inverter. This will alter the losses, so it is necessarily an iterative process, which will hopefully converge. Of course, dispatchers which had knowledge of incremental cost could perform an optimisation by analytical means, which would be more elegant and probably more accurate. This will be discussed in greater detail in Chapter 10.

### 7.2.2. Prototype

The original inverter agent worked by requesting power from the DC side, the buying price being set low, and the amount equal to the maximum input the inverter

could handle. Since the Opportunistic flag was asserted, the dispatcher allocated whatever surplus PV power was available. The inverter was then controlled so that its DC input power was equal to this amount, by measuring the input voltage and current, and using an integral control algorithm. (See section 7.4.1) This was equivalent to using the inverter as a dump load, which was legally justified (see chapter 6) because it was only activated during office hours when loading easily exceeded the inverter's output. However, it was not satisfactory, because it made no use of the system's storage capabilities, nor did it demonstrate economic dispatch of the inverter.

### 7.2.3. Calculating inverter efficiency

The initial approach to this was to measure it in real-time. Since the DC input could be measured, and the AC output was assumed accurately proportional to the control signal, the losses and efficiency could be calculated. There were a few problems with this, however. The ripple in the inverter current caused the measured DC values to fluctuate somewhat, so the calculated loss figure was very unstable. It could occasionally be seen to go negative, so either the laws of physics were being broken, or it was wrong. Averaging it would have helped, but at the cost of slowing the measurement down even further. Even without averaging, there was a 1-second delay between resetting the inverter power level, and knowing the new DC input. This was undesirable in algorithms that used a feedback controller, and so a faster method was devised. This meant compiling a look-up table from laboratory tests on the inverter, relating the control value, AC output, and DC input. Knowing any one of these parameters, the table could be used to find the other two immediately. This of course assumes that the inverter performance is repeatable (see Appendix A.13, also Section 9.4).

### 7.2.4. Simple fixed-price algorithms

The first control algorithm tested had both buy and sell prices fixed. The inverter power level was set according to demand on the AC side. If this demand (plus losses) could not be met by the DC side at the specified price, the inverter was dumped in the same way as an ordinary load.



### 7.2.5. Economic dispatch Mark One

In the original economic dispatch algorithm, the selling price was fixed, and the buying price controlled. It operated in two phases. In the first phase, it attempted to buy power from the DC side, with the Opportunistic flag set, and a maximum amount equal to the largest input the inverter could take. The price was set equal to the selling price, plus the amount required to cover losses. The amount of power actually returned by the dispatcher was then advertised for sale on the AC side, less losses. Once the dispatcher returned the desired AC power, the second phase of operation began. The inverter was started, and the initial power and price on the DC side were replaced by the measured DC power, and the price calculated from the actual losses.

There were some problems with this approach. Firstly, it had somewhat of a one-way characteristic. Once the second phase was underway, the advertised power on the AC side was set by the available DC power, and the maximum DC power was in turn set by the amount of AC power bought, so the power level could only decrease. The solution to this was to periodically change the advertised AC power amount to full power. If it turned out that there was an AC market for full power, but DC conditions did not permit it, the power would decrease on the next timestep. However, this represented one timestep's worth of DC power that was drawn without the dispatcher's permission, and the more often this process was repeated, the bigger would be the error. In practice, this was aggravated even further, because different agents operated at different timesteps. (These issues will be discussed in chapter 10.) The solution required rewriting the algorithm.

### 7.2.6. Economic dispatch Mark Two

The trick was to bid on the DC side for a slightly larger amount of power than the AC side was demanding. If more DC power was available, then the excess would be carried through to the AC side. If there were a market for this extra AC, then it would be bought. The extra would be carried back to the DC side, plus the slight increment. In this way, the power level is always driven upwards, until availability or economic dispatching on either side limits it. The drawback of this algorithm is that, where the

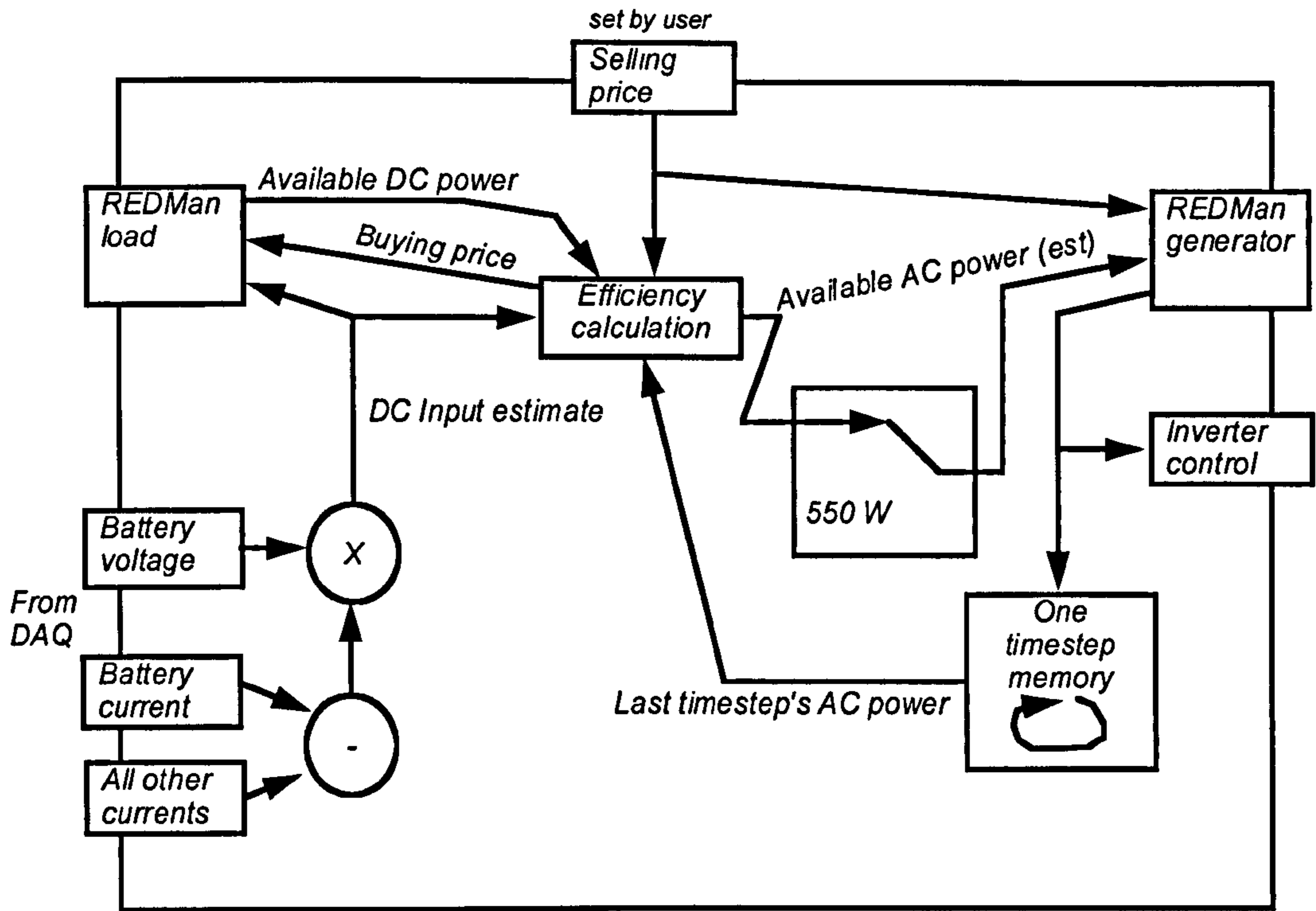

(Fig. 7.4: Original inverter management)

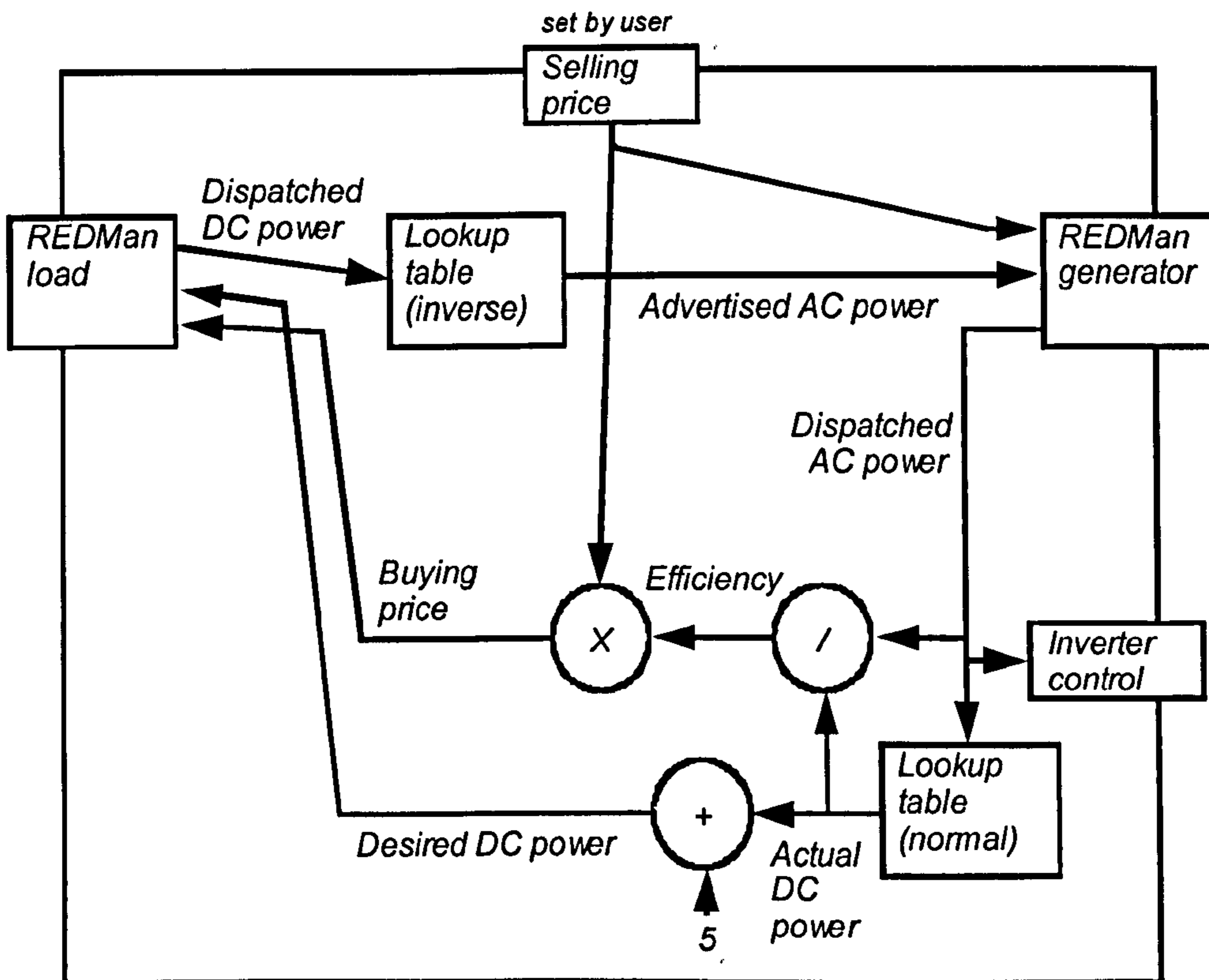

(Fig. 7.5: Inverter management with revised economic dispatching)



power is limited by AC demand, it will constantly buy more DC than the inverter is actually using. The increment is small (5 watts in prototype) but nevertheless it is an error. Again, a revised dispatching algorithm using incremental cost might well make this work-around unnecessary. Look-up tables were also introduced in this revision. The LabVIEW program is listed in Appendix H, section H.2.3.

### **7.3. Generator agent**

Unlike the previous efforts, the agent for RE generation was a simple program. The amount of power generated was determined by the RE source, such as the amount of solar radiation, or wind velocity. The program only had to measure this power, by reading the current and voltage and multiplying them together, and then communicate it to the dispatcher, using the standard communications routine. In return it would receive the actual amount of power required. Ideally, it would operate a dump load to dispose of the difference between actual and required powers. In practice, it proved easier to arrange matters so that there was always a guaranteed market for all of the power generated (see 7.4)

If the generator had been of the traditional type, burning fuel that costs money with less than 100% efficiency, matters would be more complex. For dispatching purposes, the generator would be more like an inverter, which also has to pay for its input energy, and has an efficiency depending on the power level. It might be possible to adapt the algorithms developed for inverters (see 7.2)

### **7.4. Dump load agent**

The task of the dump load is simple enough. It only needs to get rid of surplus energy. The definition of surplus energy is a different matter altogether. In the early versions of the system, the dump load was controlled by the generator agent, to burn off the difference between the energy delivered from PV/wind, and the energy bought by the dispatcher. This was not really in tune with the concept behind the system, though. A simpler and more elegant approach was to have the dump load controlled by an agent that bought any power available at a very low, or zero, cost. By pricing the RE output at slightly below this figure (I.e. very low, zero, or even negative) then the RE generator would always be guaranteed a market for its total

output. It should be borne in mind that in 'real life' there are 'dump loads' that do useful work, such as off-peak electric heating systems.

#### 7.4.1. Implementation

Connection to the dispatcher was done using the standard communications routines used in all other agents. The load routine was used here: it takes a desired power and price, and returns a true/false value authorising the load to switch on, or not. In this application, the Opportunistic flag was set. This modification to the basic REDMan dispatcher was discussed previously; it means that if the load's desired power is not available, it will be given whatever power is available, rather than nothing at all. When the load communication routine is operating in this mode, the true/false output is replaced by a number stating how much power the load can have.

Connecting this to a real dump load is a relatively simple matter. The dump load hardware can be thought of as a variable resistance, controlled by an 8-bit digital output from the computer. When this is all 1s, the dump load draws maximum current. This is not very well defined, and depends on battery voltage and temperature. It was measured at about 10 amps. When the output is zero, the dump load draws zero current. At some ill-defined value between zero and 255, it starts to conduct. Because of this vague characteristic, the control program must use feedback to make the current accurately equal to a desired value. The computer measures the dump load current anyway, so the required data are present. The feedback was implemented as an integral controller algorithm (see figure 7.7)

The control algorithm described above takes a current as input, whereas the output from the communications routine is the *power* that must be dumped. The conversion is simply a case of dividing by the measured battery voltage.

#### 7.4.2. Performance

Reckoned in the steady state, the dumped power was accurate, to the limits of the DAQ system at least, since an integral controller has no steady-state error. However, the transient behaviour was a different story altogether. The data acquisition routines update once every second, and this represents a one-second time delay in the integral control loop. Classical control theory [9] predicts that unless the integrating time



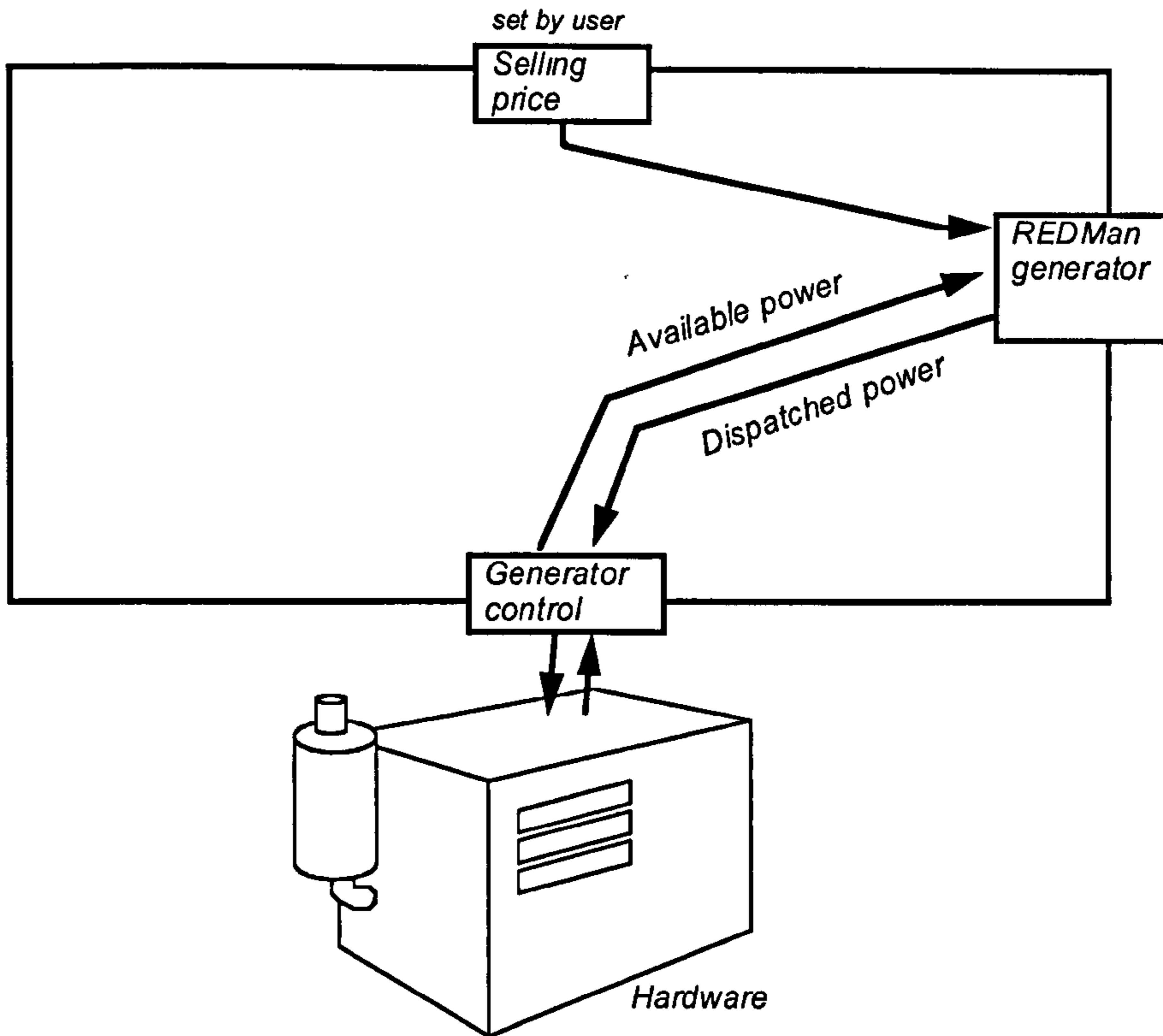

(Fig. 7.6: block diagram of generator agent)

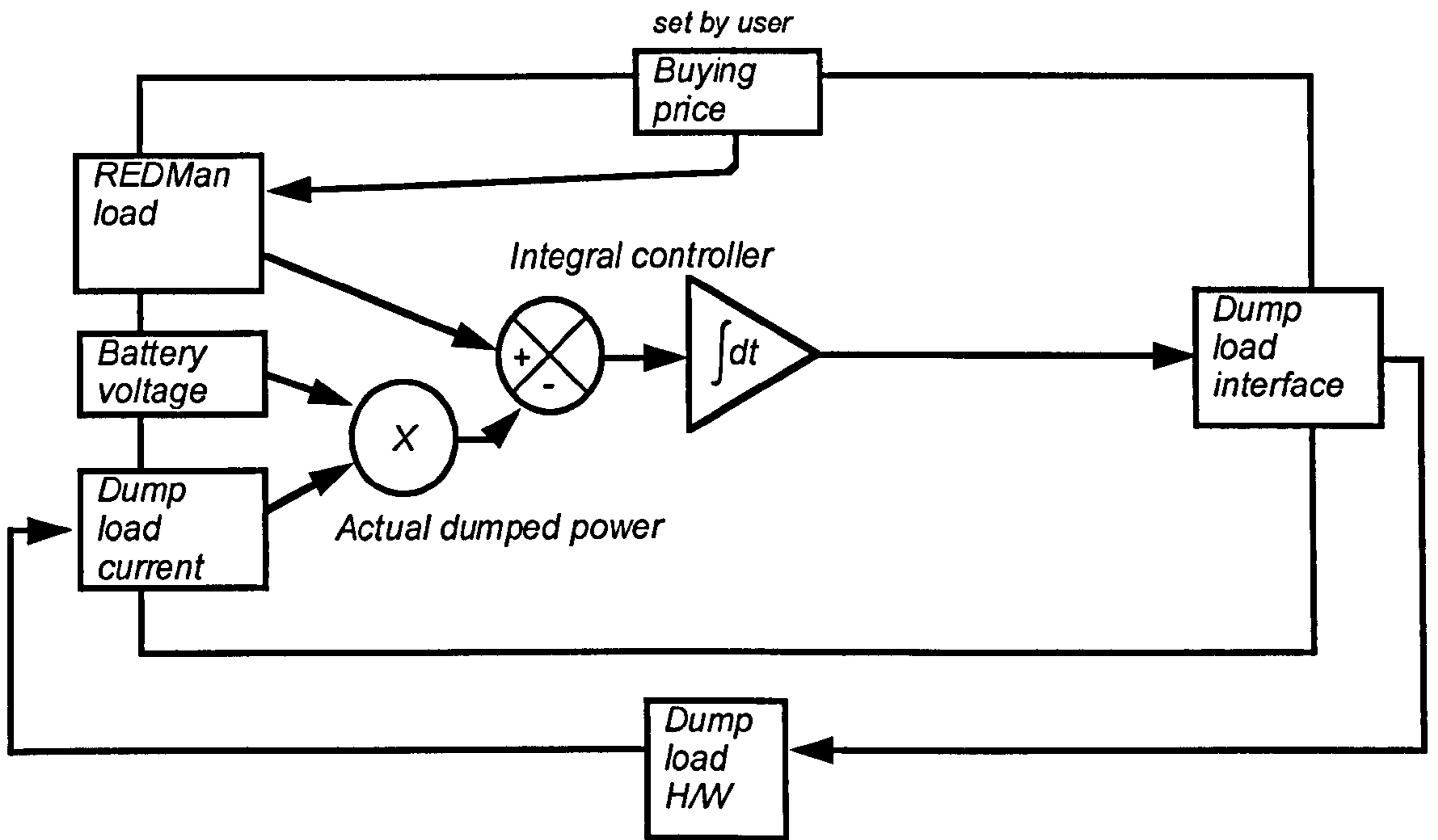

(Fig. 7.7: block diagram of dump load agent/hardware)

constant is made long enough, the system will show underdamped behaviour, and eventually instability. Unsurprisingly, experiments with the system showed this to be true. A time constant of about 7 seconds was chosen to give an overdamped response. The slow response was not a problem, since the batteries were expected to make good any transient errors.

### **7.5. Demand agent**

Throughout the development of the system, a variety of demand agents were used. All were based on the same communications program (except for the introduction of the Opportunistic flag). The only real difference was in the means of reckoning the power being consumed, and transferring the dump commands to the load. The latter is a particularly touchy subject. It seems reasonable to assume that consumers like to have control of their appliances, and resistance can be expected to anything that turns appliances on and off by itself. It may be less objectionable in the case of equipment like dump loads, inverters, washing machines and heaters, but appliances like computers and TVs should probably be considered sacred, and no physical means of dumping them provided. In these cases, load dumping will probably have to be reduced to a token gesture, by displaying some kind of warning to the consumer, or paying such a high price that there is no chance of dumping, or by incorporating a haggling procedure in the agent, so that it meets dump commands by upping the price until the commands stop.

#### **7.5.1. The original**

The first demand agent created had no link to a physical demand at all. It simply accepted power and price values typed into it. This was adequate for development purposes, when testing the dispatching algorithm. At this stage, when the whole system was just a virtual curiosity, there was no requirement for the flows of actual electric power to match the flows seen by the dispatcher, nor indeed to actually have any hardware at all. This simple agent remained useful, for loads that were constant in power draw, and were turned on and off very infrequently. It was used to represent the consumption of the datalogging computer, which had been measured as a constant 50 watts.



### 7.5.2. Smart Socket

The next type of agent provided a rudimentary link to an actual appliance. It was still assumed that the appliance would be of the “either on or off” kind, in other words, that whenever it consumed power, it was always the same amount of power. The hardware used with this was a modified 13-amp extension lead. It was equipped with a relay so that the power could be turned on or off by a digital logic signal, and also had a sensor that could determine if the appliance was drawing current (although it could not measure how much current) and output a logic 0 or 1 accordingly. There was one complication: in order for the strategy to succeed, the dispatcher would need to know if the appliance was turned on, even if it had been dumped. To do this, a small amount of current was allowed to flow, even when the relay was open, by means of a capacitor across the relay contacts. The sensor was made as sensitive as possible. The hardware is described fully in appendix C. The inputs and outputs from the Smart Socket strip (containing 4 sockets) were brought into the computer using a 24-line digital I/O card. The agent program was essentially the same as the basic model described above, except that it reported the power consumption to the dispatcher as zero, or the typed-in value, according to the state of the current sensor, and also operated the relay according to the dump signal.

### 7.5.3. Prototype power-measuring agent

This was the most desirable form of demand agent: one that had accurate knowledge of the power being consumed by the load at the present time. Getting this information is simple in theory, by using a true RMS wattmeter which can communicate with a computer. In practice, it was difficult to find a meter like this, and the few that could be found [10] were expensive, and difficult to interface. Eventually some information was found which suggested that one might be made by connecting current and voltage transformers to the line input of a computer soundcard, and performing the appropriate signal processing in the computer. (The hardware and software are described in Appendix D.) This solved the problem, and then creating the demand agent was easy; a case of transferring the measured power value from the power meter program to the communications routine.

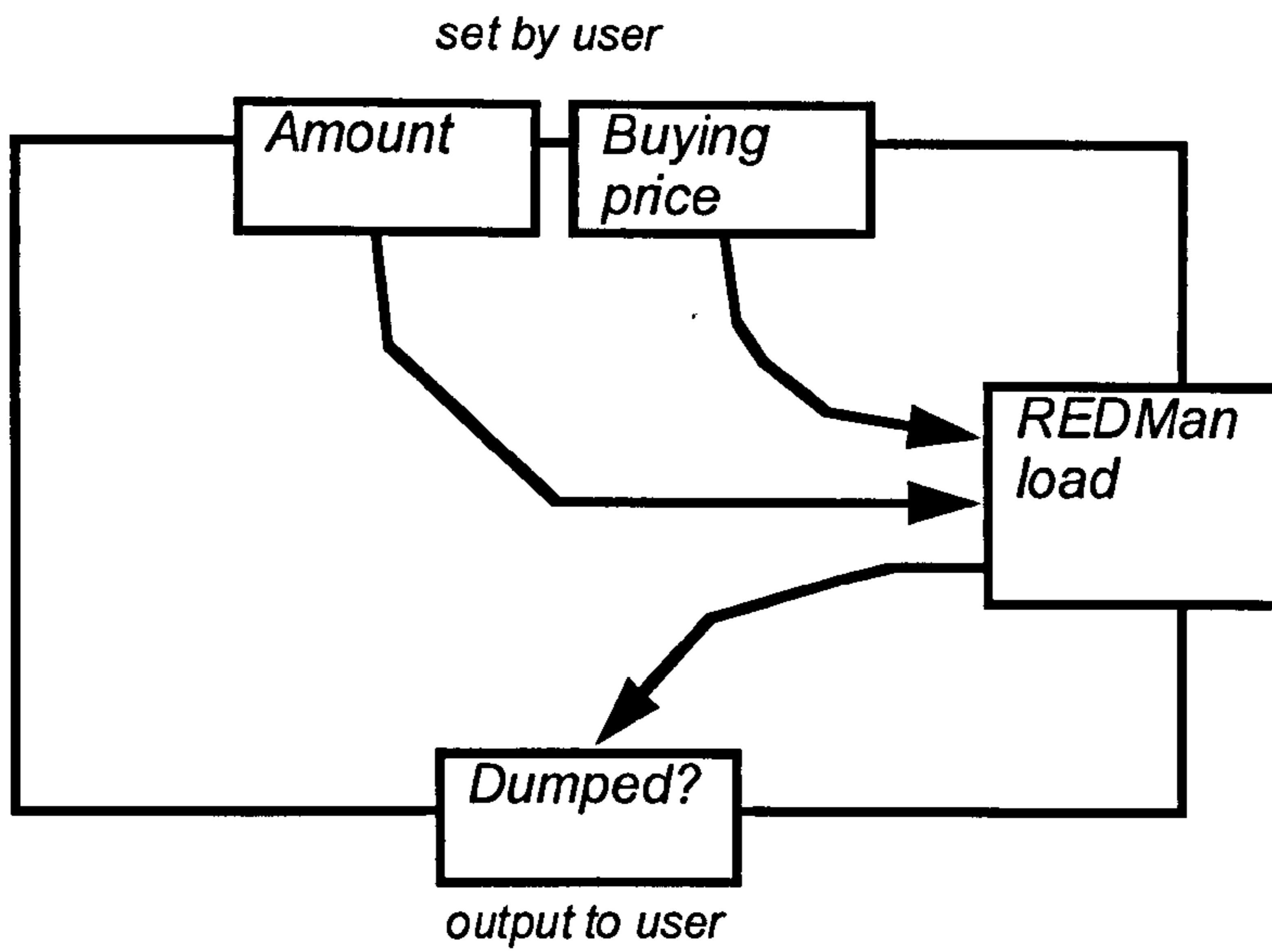

(Fig. 7.8: block diagram of original demand agent)

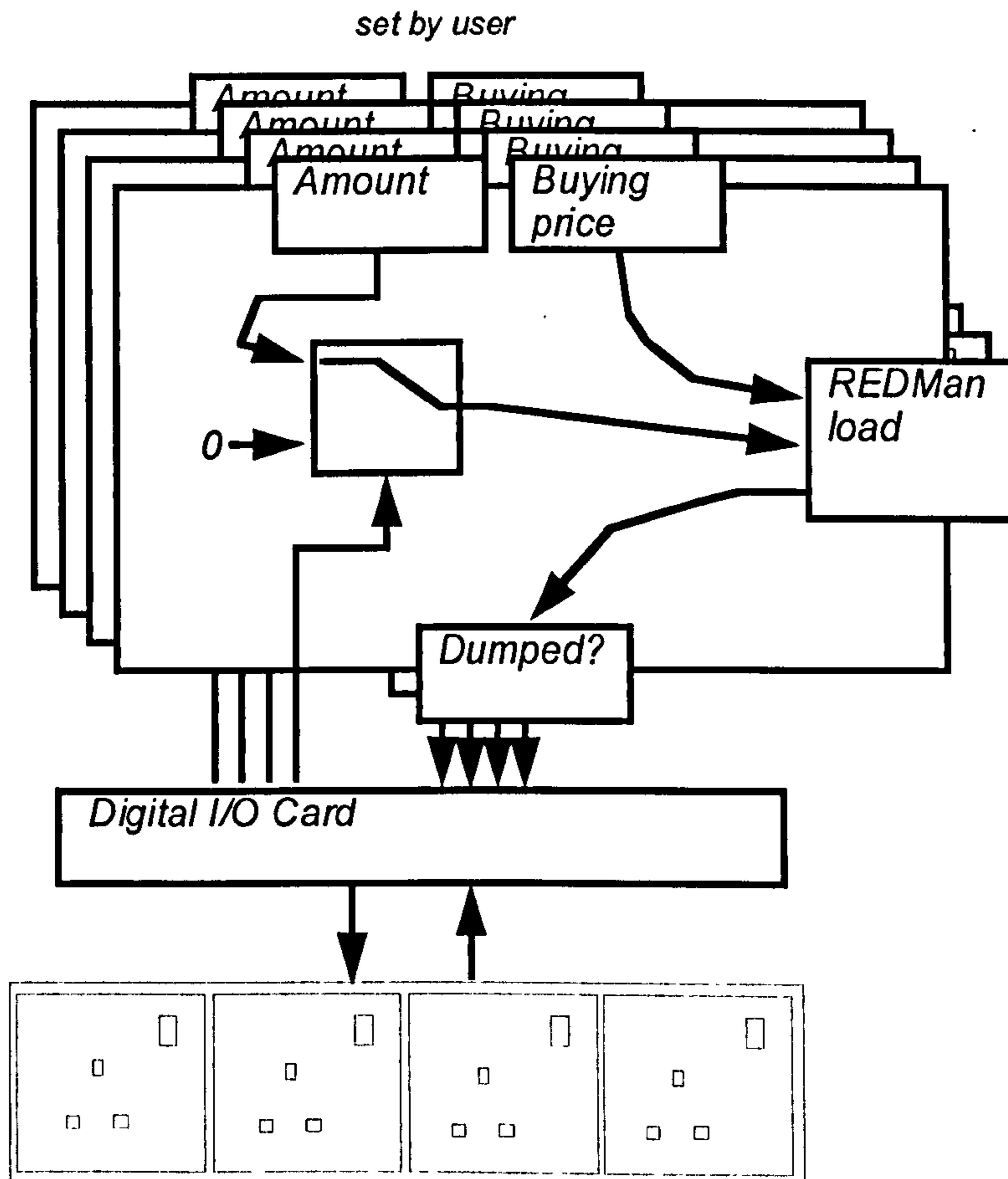

(Fig. 7.9: block diagram of smart socket/agent system)



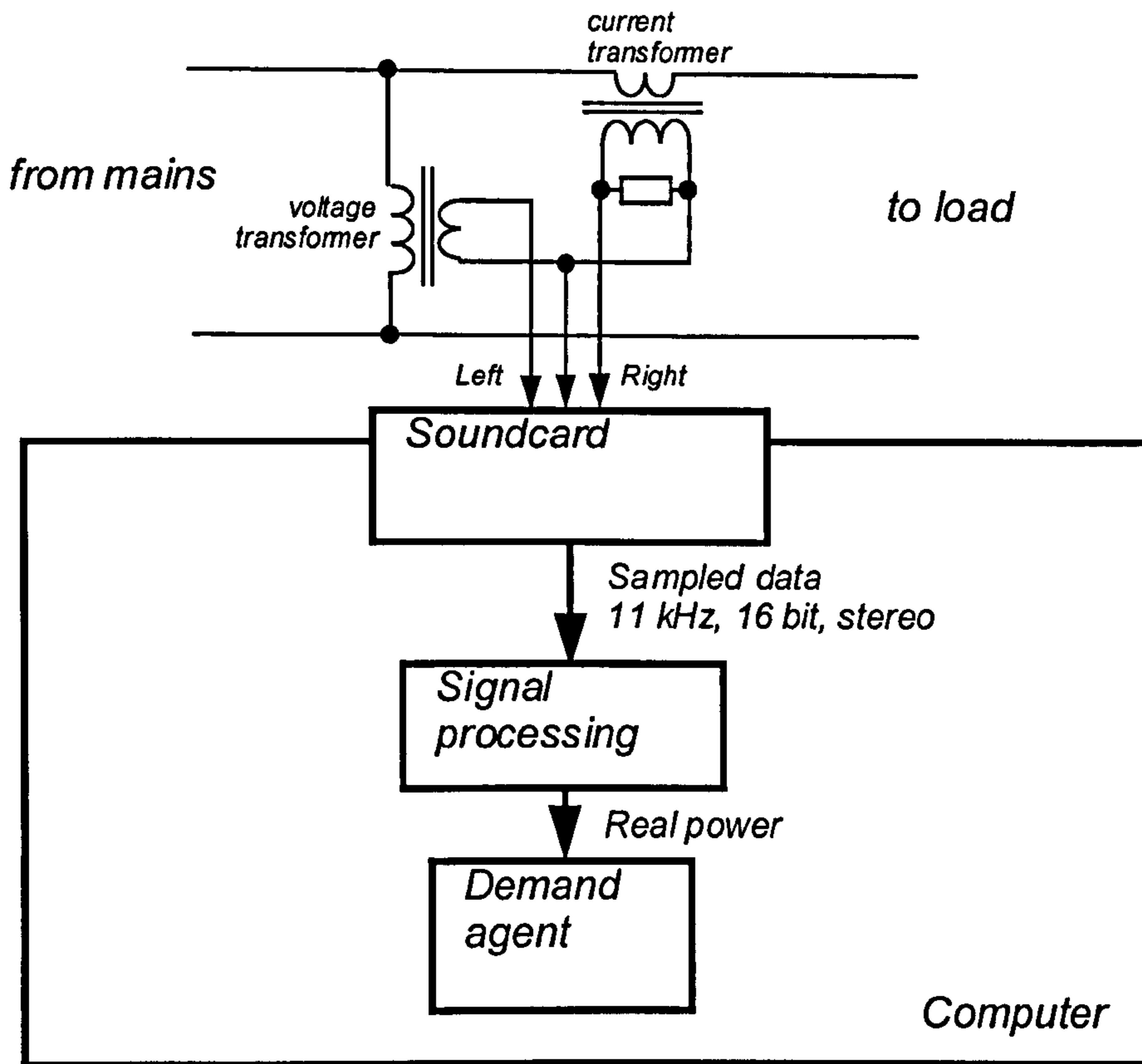

(Fig. 7.10: block diagram of power measurement hardware/software/agent)

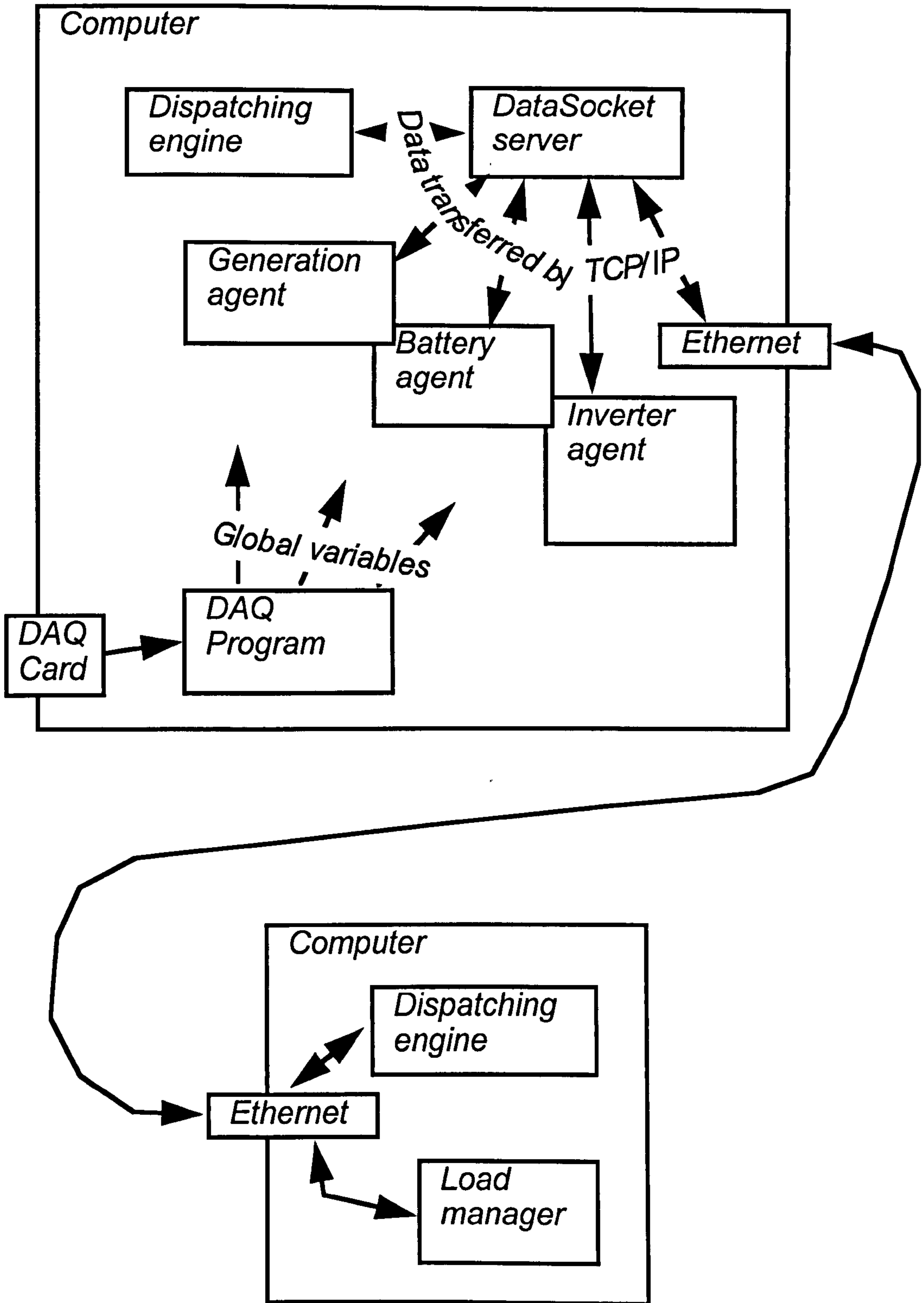

(Fig. 7.11: Software configuration of experimental system)



## 7.6. Summary

A set of computer programs were developed to interface the experimental system's hardware to the dispatching engine. The complete suite of software is shown diagrammatically in Fig. 7.11. Selected programs are listed in Appendix H, and the source for all programs can be downloaded from <http://www.esru.strath.ac.uk/>

In the case of the renewable energy generators and the dump load, there were no real problems. On the other hand, dealing with the inverter and battery was more complex. The agents for these had to incorporate economic models for the costs incurred by running the equipment, and also decision-making logic, which amounted to a simple form of rule-based intelligence. In the battery management agent, the model and rules were developed from well-known battery management techniques used commercially. In the inverter management agent, they were developed from first principles. In every case, they were refined by testing on the experimental system, until performance was satisfactory. These experiments will be described in more detail in the following chapter.

## 7.7. References

1. 'Modelling battery charge regulation for a stand-alone photovoltaic system', Ross, J.N. *et al*, Solar Energy, vol. 69, no. 3, pp.181-190, 2000.
2. 'A mathematical model for lead-acid batteries', Salameh, Z. M. *et al.*, IEEE Trans. Energy Conversion, Vol. 7, No. 1; pp. 93-97.
3. 'Design and build your own electric vehicles', Hackleman, M., Earthmind Press, 1974.
4. 'The Sinclair C5 Electric Vehicle', Milner, P.J. *et al.* Online at <http://www.sinclairc5.com/technical/paper/c5paper.htm>
5. 'Instructions for Tri-Metric Battery Meter', Bogart Engineering Inc., 1997. Online at <http://www.bogartengineering.com/TM2Instrpt1.pdf>
6. 'Owner's Manual Part # 890015', Cruising Equipment Corporation, Seattle USA, 1998. Online at <http://www.xantrex.com/DocumentDepot/manuals/link10.pdf>

7. 'Lead-acid batteries', Bode, H.E., Wiley, 1977, p. 334.
8. 'Digital Fundamentals', Floyd, T.L., Macmillan, New York, 1994.
9. 'Feedback Control of Dynamic Systems', Franklin, G. F. *et al*, Addison-Wesley, 1994, pp. 182-183
10. Manufacturers' websites e.g. <http://www.socomec.fr>,  
<http://www.brandelectronics.com/>, 2002.



## **Chapter 8: Experiments**

This section describes the experimental work: the actual work that was done, the reasons for doing it, and the results. Due to the nature of this project, though, it was difficult to separate these three categories. Much of the experimental work was really development; in other words, the kind of experiments that test whether an item of hardware or software is functioning according to a specification. Of course, creating the specification was part of this project, too, and at the beginning it was only the vaguest of concepts, “something that would make renewable energy systems more cost-effective, or more useful, through intelligent control.” It was through experimentation, trying out various ideas, writing different kinds of control software, and so on, that this vague concept evolved into a real machine that actually did something. This development work has already been covered in previous chapters, and will only be briefly summarised here.

Rather, this chapter is concerned with the second kind of experiments; those which test the performance of the whole system, to see whether it is good or useless, and whether the project has been a success or a failure. Obviously, in order to do this, a standard is required to judge it against, because goodness and success are not absolutes. So, the question is, what experiments should be done to prove that the system is good? This is a serious question which must be tackled before any experimental design is attempted.

### ***8.1. Summary of development work so far***

#### **8.1.1. Software**

The first task undertaken was to write a computer program that performed dispatching according to the simple rules specified in Section 4.3.1. This was successful. Next was to develop a communications infrastructure, which would connect the dispatcher to the power sources and demands for which it was responsible. As part of this task, dummy load and generator programs were created. The dispatcher, communications, and simulated loads/generators were tested

together, and seemed to be functioning correctly, which is to say that they behaved according to the theoretical description of how the system should work.

### 8.1.2. First hardware

The logical next step was to create some hardware for the software to control. The first prototype dispatchable inverter was developed, and also a rudimentary means of power measurement and load control, called the “Smart Socket”. These were interfaced to the computer, by writing the first generator and load agents. The inverter agent used was very basic, treating the inverter as a dispatchable source of power at fixed price. In this way, the system could perform dispatching; the generated power could be measured, and seen to be equal to the demand (within the accuracy limits of the hardware) and when the demand was changed, the supply changed to track it.

### 8.1.3. Mark Two hardware

These results were encouraging, so a decision was made to proceed to a more ambitious goal; to demonstrate economic dispatching on a more realistic set of hardware, similar to real-world embedded generation plant. Work was started on the most important component; a more powerful, efficient, and reliable dispatchable inverter. Once this was functioning, a small solar generating plant was built, using PV modules, lead-acid storage batteries, and the inverter. The whole plant was equipped with data acquisition (DAQ). A dispatchable dump load was also developed.

### 8.1.4. Mark Two software

This plant served as a development system for the next generation of agent programs, for economic inverter and battery management. For the latter, a rule-based system was developed, based on well-known battery management rules used commercially. An economic lead-acid battery model was also developed, which unfortunately could not be validated by experiments, due to pressures of time and budget. Inverter management was handled by an economic model based on stored efficiency curves of the inverter. During the course of software development, a number of unforeseen



issues arose, which required a partial rewrite of the dispatching engine and communications layer. Eventually, the system was brought to an apparently satisfactory operating condition. A datalogging engine was added, and the system was considered complete and ready for evaluation.

## **8.2. Experiment design**

But how would this evaluation be done? Evaluation conjures up an image of testing system A against system B, to see which is better. But, in this case, the system is a new invention. There is no other system for small-scale economic dispatching to test it against, so any comparisons must necessarily be indirect, perhaps with traditional automatic generation controllers. What is more, a comparative test like this is not necessarily meaningful, because the result depends on which properties you choose to compare. The choice of property is necessarily subjective; there is no experiment, or equation to solve, that will indicate which are the “right” comparisons to make. But, there are obvious properties which people experienced in this field would presumably want to see tested. These are;

1. Does it actually dispatch? In other words, does supply equal demand? On average? In the steady state? Under transient conditions?
2. Is it truly economic? Does it manage power flows, and capital items such as batteries, to deliver maximum energy per unit cost to its operator? How does the performance compare to existing economic dispatch algorithms? How does the cost of the control hardware, and the power it consumes, weigh up against the benefits?
3. Is it novel? What does it do that was not, or could not, be done before?
4. Does it really deliver on the promise to be usable with large numbers of generators?

These are the questions that the experiments must try to answer as well as possible. (1) is relatively easy; results from the datalog files can be scanned to check for consistency, and power measuring equipment can be used to check that the hardware is transporting the same power as the software commands.

(2) is more difficult, because it depends on other questions: Who is the owner of the system? How are income and expenditure defined? Are the simplifying assumptions at the heart of the dispatching engine valid? Are the cost models built into the agents correct? There is little hope of answering the first two, which are subjective, but the third and fourth will bear investigation.

(3) is a function of (1) and (2). It was known at the start of this project that economic dispatch, or indeed any kind of coordinated dispatch of small-scale embedded generators, was a novel idea. If (1) and (2) can be answered in the affirmative, or even just (1), then something novel has been done.

(4) is obviously impossible to test by experiment with real generators. Some sort of simulation could conceivably be made, though, which connected multiple REDMan instances together, and evaluated the performance. Also, the experimental system contains two instances.

So, to summarise, the objectives of the experiments should be: To test whether supply and demand are held equal, both in the dispatching software environment, and in the hardware. To detect any errors in the supply/demand matching, either transient or steady-state. To validate/invalidate assumptions made in dispatching algorithm. To validate/invalidate cost models of equipment. To examine the behaviour of multiple interconnected REDMan instances.

### **8.3. *Testing dispatcher***

This will entail two experiments. The first is to scan the logged data, and ensure that the dispatching engine's inputs and outputs all add up. This will be quite simply achieved, by importing the datalog files into a spreadsheet, and summing the appropriate columns. If supply and demand are truly matched, then the sum of power supplied, minus the sum of power demanded, should always be zero. It will also be important to examine the transient response of the dispatcher; how long it takes to process sudden changes in supply/demand, and whether it settles cleanly to the new configuration, or dithers around. This can be done by extracting log file entries corresponding to times when changes occur, and plotting them as a time series for



visual examination. A good presentation format would be as two stacked line charts, one for supply and one for demand, aligned in time.

#### **8.4. *Check agent programs/assumptions***

The second is to measure the actual flows of power, and check that they are the same as the desired flows, within reasonable limits of accuracy. This data may also be extracted from the log file, but this is perhaps not the best way of doing things, because these are the same figures used by the programs which control the power flow. So, they will appear correct, even if the measuring transducers installed on the test rig are inaccurate. It would be better to use a separate set of volt, amp, and watt meters.

There is also one power flow which is invisible to the system; the battery's internal self-discharge and losses. This is not accounted for in any way by the dispatcher; at present it is not clear what happens to it at all! This should be investigated in more detail; self-discharge should be measured, and its implications investigated and discussed.

Data should be gathered to check if the assumptions and control strategies built into the various agent programs are correct/suitable.

#### **8.5. *Testing cost models***

This is related to the previous topic, which described ways of testing if the dispatching of simulated generators worked optimally. The question here is whether the simulated generator is an accurate representation of the real one. There are four devices considered as generators in the experimental system; the PV modules, the ducted wind turbines, the inverter, the battery, and the grid. PV modules and DWTs were considered to always have zero cost. The grid was considered to have a constant price representative of the price given to small consumers. Neither of these assumptions is verifiable by experiment, and so cannot be considered further. However, the batteries and inverter each had their own cost modelling built in, and this can be tested.

### 8.5.1. Inverter cost model

The selling cost of the inverter output is dependent on the input price, and the power loss in the inverter. This relationship was discussed in more detail previously. The model can be tested by measuring power loss in the inverter and checking that it is the same as the modelled power loss, over the whole range of powers.

### 8.5.2. Battery cost model

Again, the selling cost of the battery output depends on the input (which in this case is free) and on the expense of battery wear and tear. The assumption of free input cannot be tested, so it is the wear and tear model which must be examined. If this can only be done by performing life tests on actual batteries, it may be impossible due to limitations of time.

### 8.5.3. Interactions

The prototype REDMan system does not take full account of all economic interactions between components. Some of the prices are fixed, in the interest of simplifying the interactions so that system behaviour could be more easily understood and checked during development. In particular, the battery selling price is fixed, when it could be calculated by the wear cost model. The result of removing this price fixing is unknown, and probably would be quite interesting, so this would also be a worthwhile experiment.

## 8.6. *Examining multiple domains*

Some of the information required for this would be forthcoming from the logfiles. What would be of interest here is the transient response in one domain to changes in the other. Any sign of instability, where a change in one domain caused a change in the other, that then reflected to the domain where it started, etc. would be a cause for concern. Also of interest would be the tendency of changes to ripple through multiple domains, the length of time taken for this, and whether these time delays are of practical consequence. This is less evident in the experimental results, but could be obtained from a simulation consisting of multiple domains, or by extrapolating from



the settling time of the two-domain experimental rig. It may well turn out that this is a very complex matter which cannot be resolved within the scope of this work.

### **8.7. Objectives of experiments**

The following are suggested as realistic goals for the experimental program;

1. Scan logfiles and check supply=demand, also check transients
2. Measure actual power flows using separate instruments to ensure supply=demand in real world, also check transient behaviour.
3. Test inverter performance and compare to model (see 2)
4. Check behaviour of agent programs.
5. Try to quantify two-domain interaction.

There will not necessarily be a one-to-one mapping between each of these objectives and a physical test procedure or experiment. Experiments 2 and 3 are naturally related, and the same physical experiment could cover both. Similarly, 1, 4, and 5 could be covered by a single test run.

### **8.8. Summary**

In this brief chapter, a set of experiments were designed whose results would allow a judgement on whether the REDMan system was satisfactory, and would hopefully suggest ways in which it might be improved. The experiments were performed, and data gathered. Now, it is time to discuss the results.

## **Chapter 9: Results of experiments**

The experimental apparatus was described in chapter 6, and the software it ran in chapters 5 and 7. Chapter 8 proposed an experimental protocol and possible ways of interpreting the results. This chapter describes the details of the experimental work and the results obtained.

### **9.1. Test run for energy balance/transient**

Most of the data required for the experiments proposed could actually be gathered in the course of a single test run, which exercised the various system components over a reasonable range. A week in summer was chosen when a reasonable mixture of sunshine and cloudy periods could be expected. The batteries were fully charged at the beginning of the experiment. As regards the loading and the battery management setup, there was some uncertainty. Using the economic battery management presented some problems, which were discussed previously. To recap, the issue was that the use of batteries was uneconomical compared to grid electricity, so enabling the economic dispatch resulted in the batteries being turned off completely. They could be artificially subsidised to make them work, but there did not seem to be any way of doing this in a meaningful manner. Therefore, the economic algorithm was turned off, and replaced by an ordinary cut-out algorithm, disabling the batteries once the state of charge dropped below 60%. The inverter was set up with the revised economic dispatch algorithm. A load of 50 watts was placed on the AC side, and the buying price of this chosen so that it would be powered by renewable energy or grid power, but battery power would be too expensive. This was done because it was known that the RE generation (only 30 watts on average) would not be sufficient to cover the load, and also to test economic dispatching, and give the inverter management more changes in power to deal with.

The system ran satisfactorily for four days with no obvious problems. At the end of this period, the data files were collected for analysis. Fig 9.1 shows the dispatched powers in the AC domain over the entire test run period. This gives an overview of the system performance.



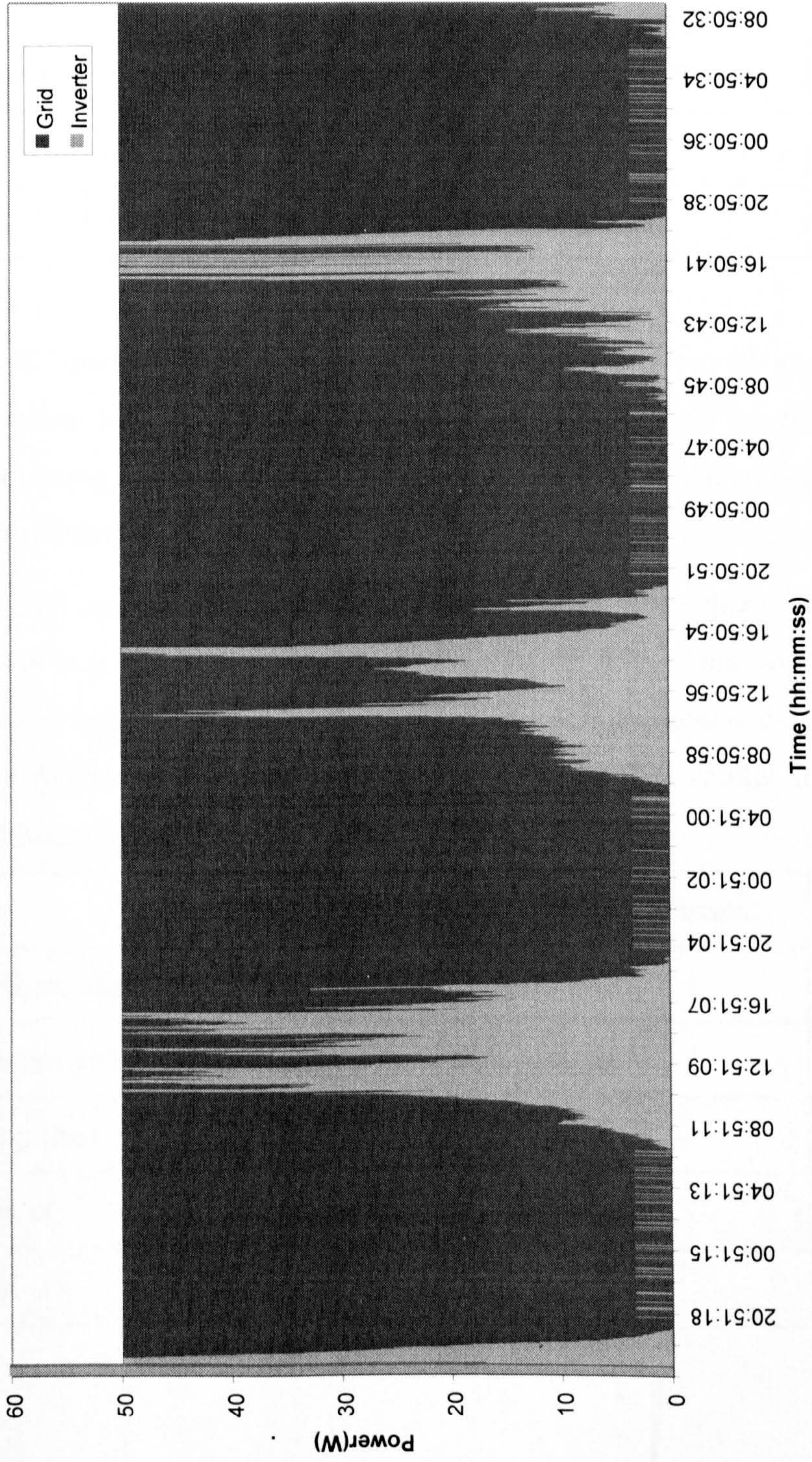

(Fig. 9.1: Dispatching performance of system)



## 9.2. Energy balances

The first task was to check that all the powers in the dispatching engine added up. This was done by summing all the supply powers from the test run log file, summing all the demand powers, and taking the difference. Results are summarised below for each domain:

Domain	Energy demanded (Wh)	Energy supplied (Wh)	Difference (Wh)
DC	1513.205	1513.194	0.011
AC	4669.583	4669.583	0.000

(Table 9.1)

The AC numbers are exact, however the DC numbers are very slightly out. Whatever the reason for this, it represents an error of only 10 parts per million, and is hardly worth being concerned about, unless of course it is an integral-type error that grows in an unbounded manner with time.

The next test is to compare the powers presented to the dispatching engine with the powers derived from system voltages and currents. This will catch any internal inconsistencies in the agent programs. This test is applicable only to the DC domain, since AC voltages and currents were not logged. The results are as follows (all in watt-hours, generation is positive)

Item	Energy dispatched	Energy measured	Difference
RE Generation	1393.559	1274.212	-119.347
Battery (net)	72.516	165.967	93.451
Dump load	-124.415	-174.568	-50.153
Inverter	-1341.65	-1265.611	76.039
Total	0.01	0.0	-0.01

(Table 9.2)



There are fairly large discrepancies here between the measured and dispatched values. Both sets of values are internally consistent in that they add up to zero. However, this is no surprise, since it was already shown that the dispatcher powers add up, and the DAQ system works by taking  $n-1$  measurements and calculating the  $n$ th on the assumption that the sum of currents is zero.

The RE system generated less energy than the dispatcher thought to be the case. This may have been due to an oversight in programming: During development, the wind turbine and PV currents were often observed to be a small negative amount in the absence of any wind/sunshine. This was assumed to be an offset error in the measurement electronics and so was eliminated by forcing all currents less than zero to zero. However, if this had been a genuine leakage current, it would explain the error. It would also account for part of the missing energy from the battery, which delivered three times more energy than the dispatcher credited it with. In order to answer this question, the DAQ system accuracy should be checked.

The dump load dumped more energy than the dispatcher ordered it to. This could be explained by the voltage regulator function built into it, which clamps battery voltage at 30.0V. If the battery was temporarily overcharged due to slow response of the battery management program, the voltage regulator would dissipate power to keep the voltage under control. This hypothesis could be checked by examining the datafile in more detail; see section 9.4 (Transient behaviour)

### **9.3. DAQ Hardware check**

DAQ current and voltage readings were checked against a 3999 count digital multimeter. This is no better than the 12-bit (4096 count) DAQ board; however, the meter has a wide choice of ranges, whereas the DAQ is limited to one fixed range. This effectively makes it much more accurate than the DAQ when dealing with currents that are a small fraction of the DAQ's full scale (FS).

The DAQ and meter readings of battery voltage agreed to within 0.01 volt.

Some errors were noted on the current channels; a constant offset of  $-0.03$  A on the 10 A current channels (except the dumpload which had  $-0.01$ A) and  $-0.09$  A on the 30 A channel. This corresponds to a voltage offset of  $0.03 * 0.075/10 = 225\mu\text{V}$  in

either case, which is within the DAQ card tolerance of  $345\mu\text{V}$  [1] when operating at 500mV FS sensitivity. The card has a higher gain setting with lower offset, but it is not usable because the maximum input at this setting is only 50mV, and signals of 75-150mV are expected from the current shunts.

The 0.03A error at 24V represents a power error of 0.72W on each 10A measurement channel, and 2.16W on the 30A battery channel. The renewable energy (on 4 channels) will be in error by  $4*0.72=2.88\text{W}$ . Thus,  $2.16+2.88=5.04\text{W}$  in total are unaccounted for. The error on the dumpload channel should be reckoned as having the opposite sign, because the dumpload controller regulates the DAQ-measured current to zero, thus the actual current will be the same as the DAQ offset, but with the opposite sign. Therefore, the dumpload measured energy will be less than the actual amount.

Over the 91.67 hour duration of the experiment, the errors in watt-hours work out as follows:

Item	Measured energy (Wh)	Error (Wh)	Corrected energy (Wh)
R.E.	1274	264	1538
Battery	166	198	364
Dumpload	-175	-22	-197
Inverter	-1266	-439	-1705
Total (check)	-1	1	0

(Table 9.3)

The 'Error' column figures are estimated from the offset figures calculated above, and used to estimate what the energy flows would really have been. To clarify the sign convention: The R.E. actually generated more energy than the DAQ system measured. The battery output more, the dumpload dissipated more, and the inverter used more. The errors and corrected values still sum to zero (rounding errors notwithstanding) because they were generated under the assumption that  $\Sigma I = \Sigma P = 0$  still holds. This assumption is discussed in Section 6.3.2.



The effect of this divorce between measurement and reality is somewhat involved. Firstly, the measured results were accurate (0.3% of FS) by the standards of everyday instrumentation. The large accumulated errors (~20%) shown above are an unfortunate consequence of the operating conditions; the system spends a lot of time under conditions that are only a fraction of full-scale i.e. night-time, cloudy conditions, inverter load of only 9%, and so the error is magnified accordingly. Although these discrepancies are large, they mostly had no observable effect. The inverter is controlled as a function of its output power, so this is always correct. The dump load will get a little hotter, but this is hardly obvious. The only obvious symptom would be an inaccuracy in the battery's estimated state of charge; the real battery would discharge faster than the model. The effect will be more pronounced under conditions of low RE supply, and demand almost as great as supply, which are the exact conditions under which these results were taken.

#### **9.4. Inverter re-test**

The inverter was re-tested to determine if the efficiency had deteriorated, or the dispatching calibration had drifted, since the original test. Results are shown in Fig. 9.1 and Table 9.4. To summarise:

Efficiency appeared to have deteriorated by around 2%, however this is within the limits of experimental error. Also, the measurement in this experiment included losses in the connecting leads between DC bus and inverter.

Calibration appeared to have drifted downwards by around 3%. This cannot be explained by experimental error, and must be a genuine problem with the inverter.

Temperature/time dependence of calibration was checked. The thermal effect noted in Appendix A was not detectable at this time.

Efficiency vs. power

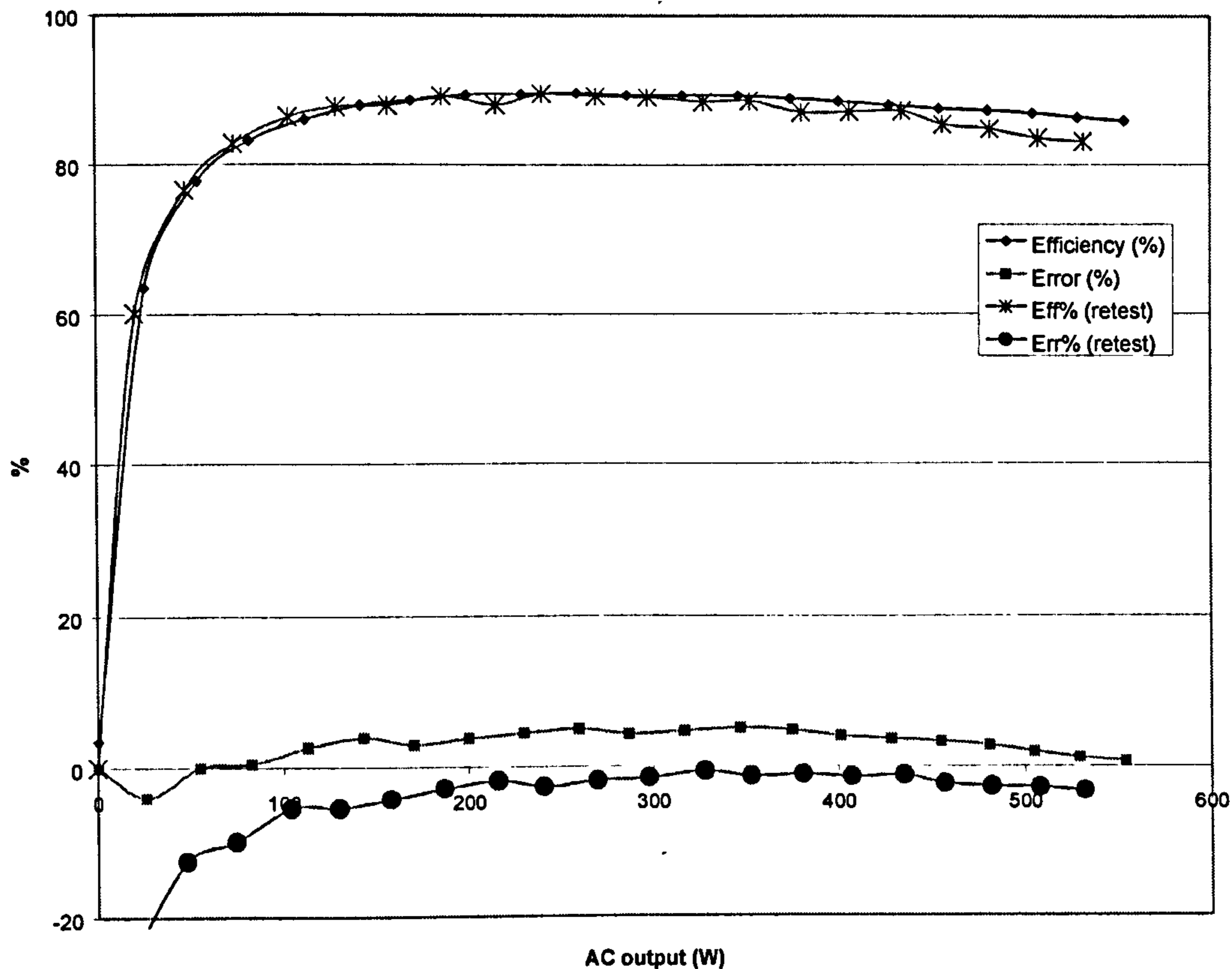

(Fig. 9.1: Efficiency and calibration curves of inverter re-test)

Power %	Demand setting	Expected power W	DC Bus voltage V	DC Input current A	DC input power W	AC Real power W	Efficiency %	Power error W	Power error %
0	0	0	0	0	0	0	?		
5	12	27.5	25	1.39	34.75	20.9	60.14388	-6.6	-24
10	25	55	24.82	2.53	62.7946	48.1	76.59894	-6.9	-12.5455
15	38	82.5	24.68	3.64	89.8352	74.4	82.81832	-8.1	-9.81818
20	51	110	24.58	4.9	120.442	104	86.34862	-6	-5.45455
25	63	137.5	24.5	6.05	148.225	130	87.7045	-7.5	-5.45455
30	76	165	24.45	7.35	179.7075	158	87.92065	-7	-4.24242
35	89	192.5	24.38	8.6	209.668	187	89.18862	-5.5	-2.85714
40	102	220	24.29	10.1	245.329	216	88.04503	-4	-1.81818
45	114	247.5	24.25	11.1	269.175	241	89.53283	-6.5	-2.62626
50	127	275	24.2	12.5	302.5	270	89.2562	-5	-1.81818
55	140	302.5	24.15	13.85	334.4775	298	89.09418	-4.5	-1.4876
60	153	330	24.07	15.4	370.678	328	88.4865	-2	-0.60606
65	165	357.5	24	16.6	398.4	353	88.60442	-4.5	-1.25874
70	178	385	23.97	18.25	437.4525	381	87.09517	-4	-1.03896
75	191	412.5	23.94	19.5	466.83	407	87.18377	-5.5	-1.33333
80	204	440	23.85	20.9	498.465	435	87.26791	-5	-1.13636
85	216	467.5	23.85	22.4	534.24	457	85.54208	-10.5	-2.24599
90	229	495	23.75	23.9	567.625	482	84.91522	-13	-2.62626
95	242	522.5	23.72	25.6	607.232	508	83.65831	-14.5	-2.77512
100	255	550	23.6	27.1	639.56	532	83.18219	-18	-3.27273

(Table 9.4: Inverter re-test data)



## **9.5. Transient behaviour**

An investigation of transient response was made, by scanning the logfiles for areas where rapid changes in power level appeared to take place, and then examining these in further detail for any evidence of unexpected behaviour.

### **9.5.1. Typical dispatching behaviour**

A 9-minute period characterised by rapidly-varying PV power was found, which demonstrates the function of the dispatching and inverter control at this time. Powers vs. time are graphed in Fig. 9.2; PV generation, inverter input, inverter output, and dump load. Results can be interpreted as follows: At first, the inverter input tracks the PV output. This is in accordance with the pricings set, which state that the AC load can only afford PV power. At sample 15, the PV generation becomes enough to supply the 50-watt AC demand, through the inverter. Therefore, the inverter buys no more power. The battery is full at this point, so the surplus is directed to the dump load. As PV generation falls again, the dump load turns off at sample 31.

Unfortunately, the real story is slightly more complex. The inverter output had already reached 50 watts at sample 9; why did the input continue to rise until sample 15? The answer is in the inverter control program, which always tries to buy 5 watts more than it needs, as discussed in Chapter 6. While the inverter is governed by the available input power, it cannot find those extra 5 watts. Once the output-side demand becomes the limiting factor, though, the input power can be seen to rise 5 watts above the true value between sample 9, and sample 15 when the dump load turns on.

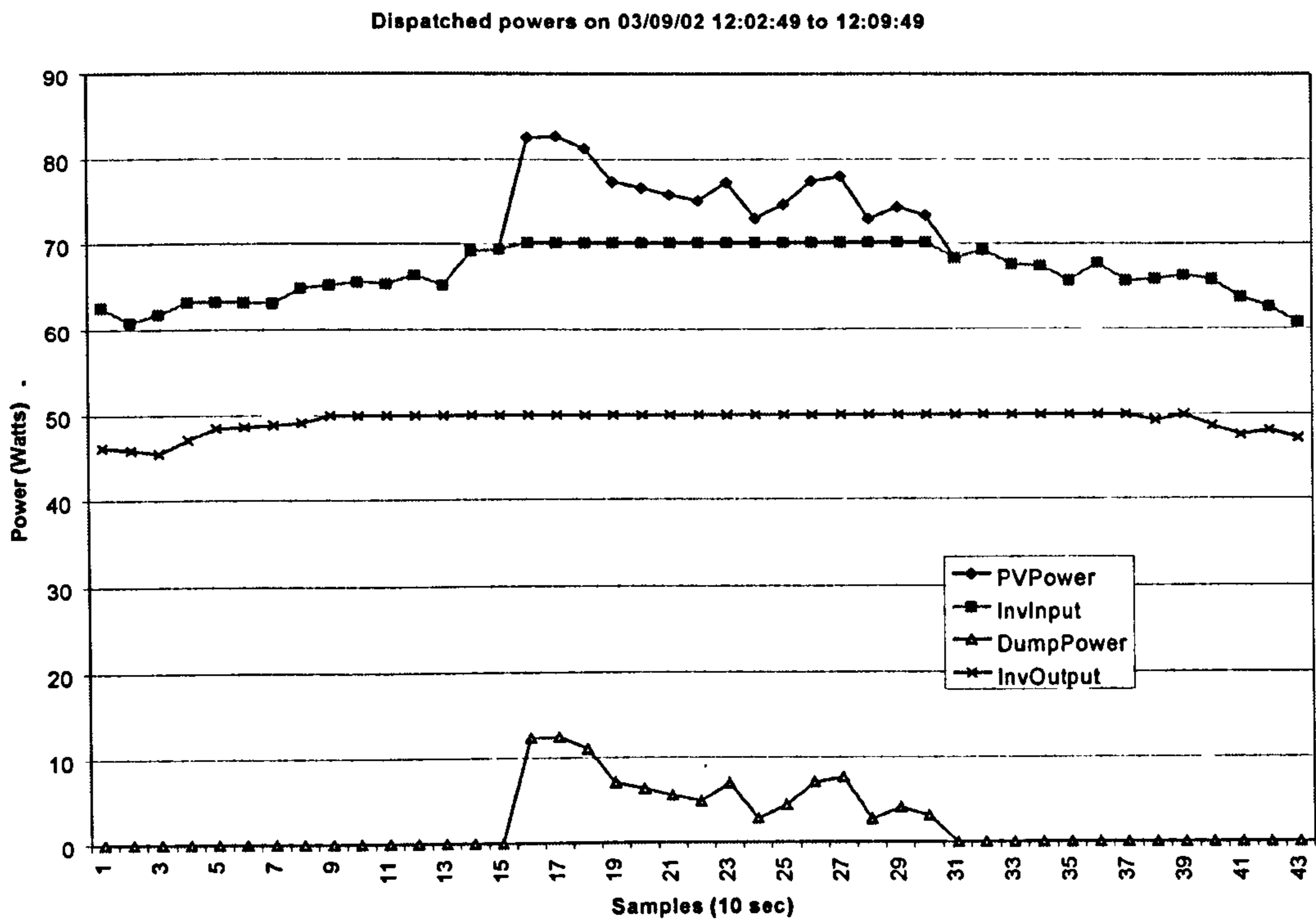

(Fig. 9.2: Time history of dispatched powers)

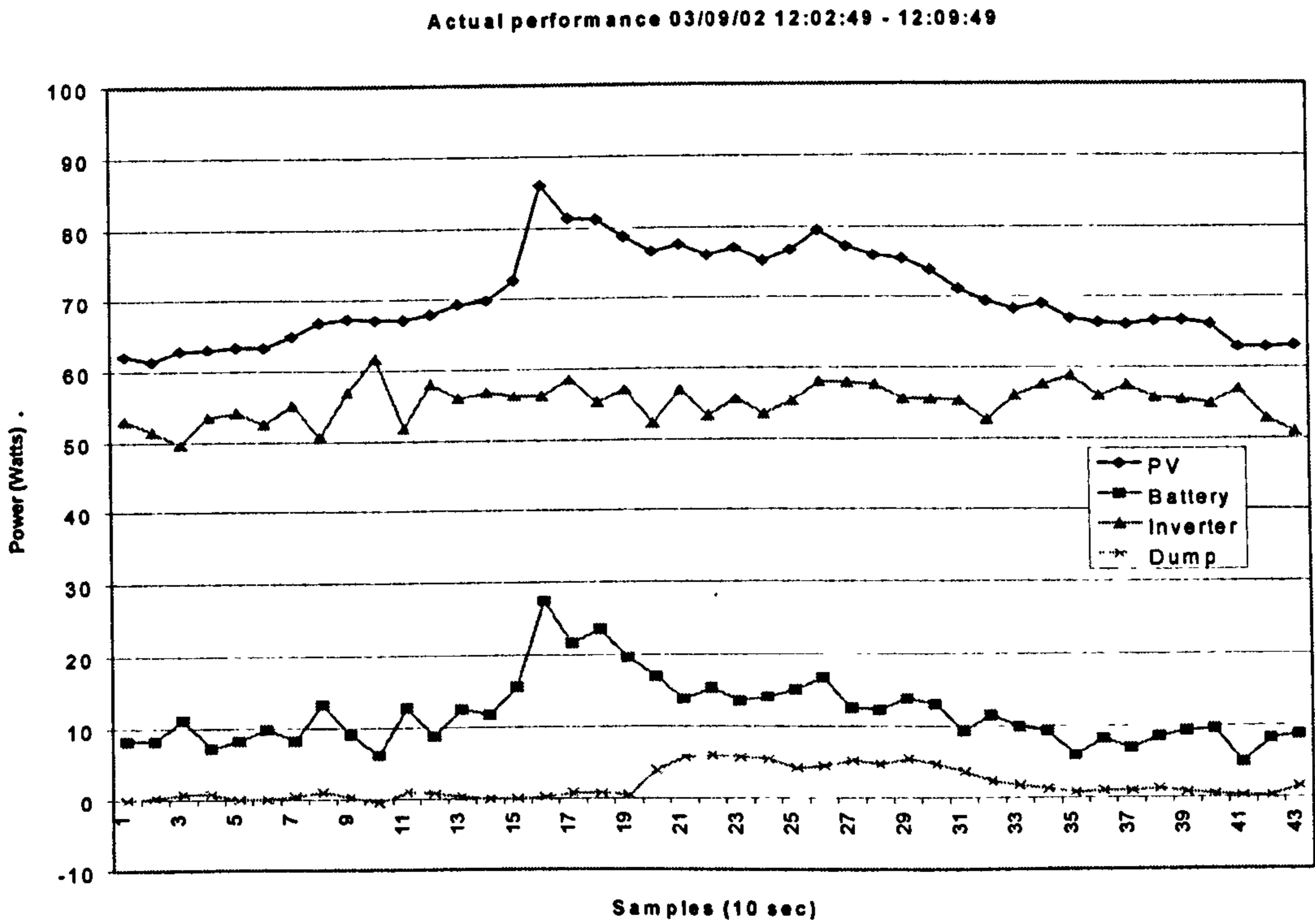

(Fig. 9.3: Time history of actual powers)



### 9.5.2. Actual/dispatched power flows comparison

The actual power flows measured by the DAQ subsystem can also be graphed in the same way. This will give an idea of how the control programs for inverter, dumpload, etc. are performing. Fig. 9.3 shows this, and it is rather a different story to the dispatcher's point of view. The PV power is the same, but the dump load is not living up to the performance seen by the dispatcher. It kicks in late, and in a half-hearted manner, dissipating only 5 watts instead of the 15 it is commanded to. The remainder goes into the battery, which swallows it without any appreciable effect on the voltage. This suggests that it is not full, otherwise the voltage would rise. The S.O.C. at this point is in fact only 97.5%, which is unusual considering that the batteries started at 100%, and that they were not supposed to be delivering any energy at all.

The slow operation of the dump load can be blamed on the dump load controller program itself. As discussed earlier, this uses a simple integral controller to adjust the current passed until it is equal to the desired value. Unfortunately, because of the square-law characteristic of the transistors in the dump load, the integral gain must be chosen to give stability at the highest currents, where the square-law gain is highest. This makes for a very sluggish response at low currents. However, the unexpected behaviour of the battery is puzzling, and requires a detailed investigation.

### 9.5.3. In search of missing energy

Fig. 9.4 shows the battery parameters over the duration of the experiment. The dispatched battery power is as expected, mostly zero except for a few charging peaks. The measured battery power shows the same peaks, but also a drain of  $\sim 5W$  during the hours of darkness. This is not battery self-discharge, which cannot be measured by the DAQ system. Rather it must be some load within the system. Leakage in the wind turbines/PV modules was eliminated; it shows up zero in the measurements and also was checked with a separate meter. Therefore, either the dump load or the inverter must be responsible. Stranger still, though, the battery then recharges slightly during the day, even though the battery management agent is not buying any power; the dispatched power trace shows zero.

An explanation of this strange behaviour was sought, through careful examination of all of the logged data. In the end, it turned out that the problem was nothing to do with the battery management program at all, but with the inverter management, which had two faults. First was this: When the available power is zero, the economic dispatch calculation fails. Instead of returning a buying price of zero for DC electricity, as expected, it returns “Not A Number” (NaN) The dispatcher appears to respond to NaN by treating it as though it were infinity, and hence gives the inverter agent the go-ahead to take power from the battery. The inverter agent buys an initial 5 watts. As soon as it gets power, though, the calculation starts to work again, and the price changes from NaN to a low value. The dispatcher refuses any further power and the inverter turns off again. The cycle repeats as long as the available RE power is zero. Inspection of the logfile measured powers shows that the inverter hardware does actually toggle on and off during the hours of darkness, draining power from the battery.

So much for the unexplained discharging, but what about the tendency to recharge during daytime? The problem here lies with the inverter management lookup table. Earlier, when retesting the inverter hardware, it was found that the power calibration had drifted downwards. Therefore, the inverter would have been outputting less AC power than the lookup table expected. The efficiency also declined, but by a very small amount only, so on the whole, the inverter would tend to draw less DC power than the lookup table predicted too. So, when the inverter management thought it was using all the available RE, there would actually still be some energy entering the battery. However, this effect was not as great as the tendency to discharge during night-time, so overall the battery slowly discharged.



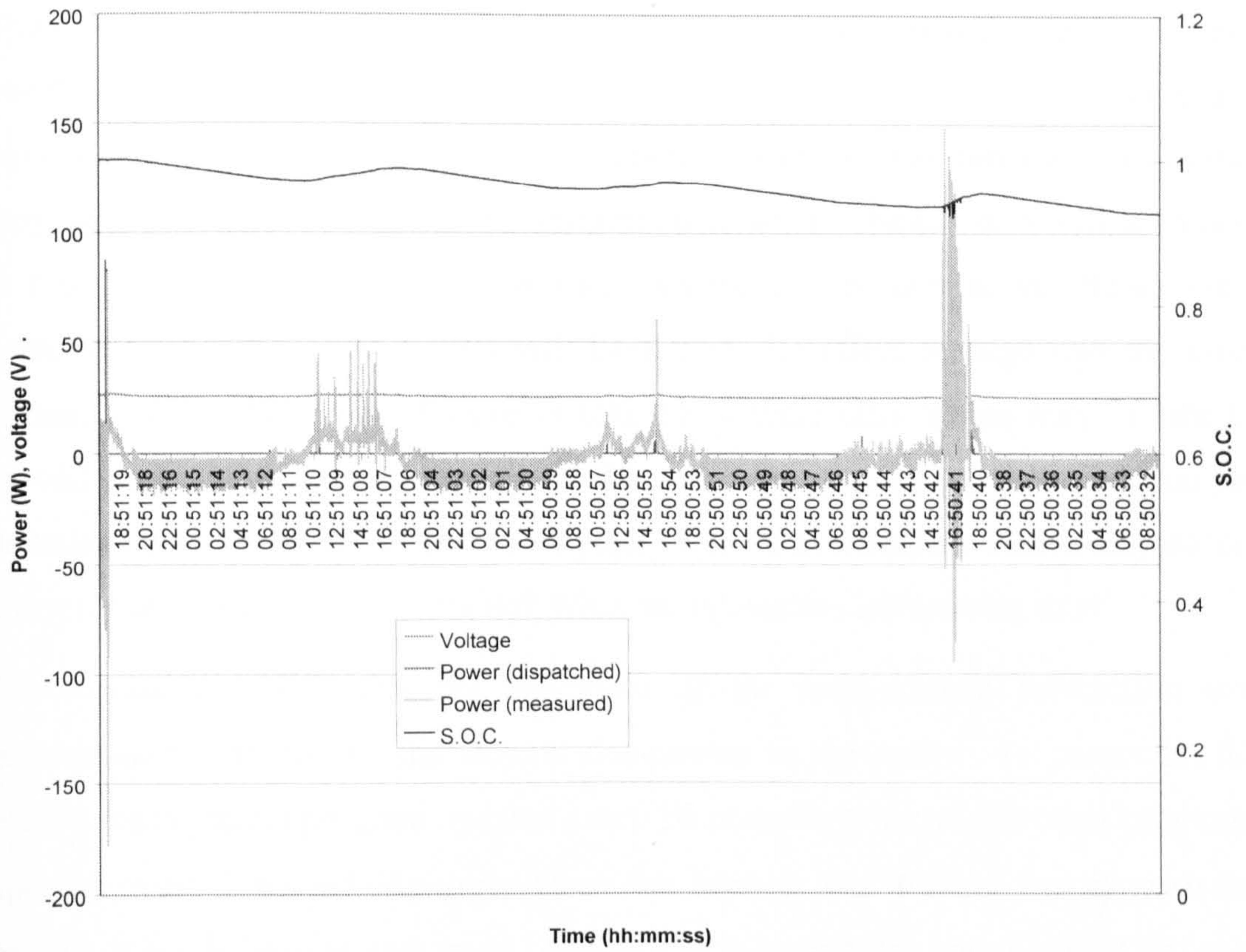

(Fig. 9.4: Time history of battery-related variables)

## **9.6. Two-domain interaction**

The experimental system contains two instances of the dispatcher, one for AC and one for DC. The two are connected together by means of the inverter agent program. No attempt was made to synchronise the operations of the two domains, except that they were configured to have the same nominal timestep. The effect investigated here is this: When a change is made in one domain, it may alter power flows/prices associated with the inverter. This will then carry the effect through into the other domain, which may cause changes to take place there also. These may in turn be carried back to the original domain, and so on. The question is: how long do the domains take to converge to their new state? Are there situations where they do not converge at all but become unstable? What are the factors influencing this?

The results suggested that the behaviour of the inter-domain connection was sometimes determined by the slowest component in the system. In particular, the battery management program updated every 10 seconds, whereas the other programs updated every 1 second. At times when the inverter was trading energy with the battery, it would have to wait up to 10 timesteps to receive the energy that it ordered. This does not comply with the specification laid down for the system, which requires a response by the following timestep. The effect was to make the inverter management slow to respond, and sometimes even unstable, as was the case with the original inverter management algorithm. The inverter sometimes became trapped in a loop, toggling on and off repeatedly. At the time of development, this was thought to be a problem with the inverter management itself, and the problem was cured by a revision of the algorithm. The true cause did not become apparent until the final results were examined in detail.

## **9.7. Summary**

A four-day long test run was performed. The logged data allowed analysis of the dispatching performance, in terms of energy balance and transient behaviour. Also, the DAQ and control hardware used in the test rig was checked against other measuring equipment. The results can be summarised as follows: The dispatching engine itself worked very well. All the other software worked properly with the



exception of the inverter management agent. There was a slight discrepancy in its operation which left a small amount of power unaccounted for, causing a difference between the power flows in reality and those seen by the dispatching engine. Errors in the measurement hardware also contributed to this effect. However, these errors and differences were not of great importance, and basically the system did operate as intended. In the next chapter, these findings will be discussed, and some conclusions drawn as to the validity of the REDMan concept as a whole.

## **9.8. References**

1. "PCI-6023E/6024E/6025E User Manual", National Instruments, 2000, online at <http://www.ni.com/>

## **Chapter 10: Conclusions**

### ***10.1. Does it dispatch successfully?***

The answer here is yes. Experiments showed that the matching of supply and demand was performed reliably and without errors; such errors as were present could be attributed to problems with the hardware or auxiliary agent programs. These errors were an inconvenience, but did not detract from the proof of concept.

### ***10.2. Does it work economically?***

Within the assumptions made (zero marginal cost etc.) it certainly does. The question is rather one of whether those assumptions were valid in the first place. The inverter actually did not have zero marginal cost, and so the dispatcher had no formal means of dealing with this. The inverter management program had to find a way of turning the incremental cost into a single figure. In practice, this was done by calculating the price as a function of the power level at each timestep, and just presenting this figure to the dispatcher. This worked properly, provided that only one device in each dispatching domain operated in this way.

Also, there were problems with the economic battery management, which had to be disabled. Partly, it was a victim of its own success, the problem being that the lead-acid batteries themselves were not economically viable for use in this system. It also suffered from a minor bug causing some power to be wasted.

Of course, this begs the question: If the batteries were not economically viable, why were they included in the system in the first place? It would have been possible to have an inverter that connected directly to the PV modules with no intervening battery storage. One reason is that, while batteries might not be economical, other storage systems may well be, now or in future. The use of storage is expected to increase as RE penetration increases; hence REDMan-like dispatchers would probably be involved in the control of storage systems, and so it was thought important to demonstrate that it could be done. Another reason was simply to absorb transient power fluctuations on the DC side, and “eliminate” the need for MPP tracking, which simplified the inverter design greatly. Of course, a bank of capacitors



would have done equally well in this respect, but the storage capacity would have been insufficient for dispatching studies.

### **10.3. Will it scale to large numbers?**

The experimental system had two REDMan dispatchers, one managing the AC domain, the other the DC domain. They co-operated satisfactorily. However, it is still hard to extrapolate from this and say that a system of 50, 100, 5000 etc. dispatchers will work properly too. In fact, some results gave slight cause for concern, in that the coupling between the two domains seemed rather stronger than it should have been. There was a kind of oscillation provoked by sudden changes of power levels in either domain. However, the data suggested that this was due to the inverter control algorithm (which is effectively the component that interconnects the two domains) interacting with the variable time-stepping, rather than any fundamental problem with the multi-domain concept as such. This suggests that variable time-stepping should be rationalised, and the protocol for inter-domain connection looked at. A more detailed discussion of this issue is in 10.5.5 and 10.5.6 below.

### **10.4. Overall conclusions**

The experimental program set out to achieve the following: demonstrate dispatching of embedded generators using the software developed, show that it was working in an economic manner, and show that it was usable with large numbers of generators and loads. The first objective was achieved; the system was shown to dispatch successfully. This in itself appears to be a new achievement in the EG field.

As for the second, economics, this was handled adequately, considering that it was partly overridden to allow the inclusion of battery storage. Some power was wasted compared to the optimal case, but this was due to measurement errors rather than any kind of faulty dispatching.

Finally, the most contentious issue, scaling to large numbers, remained open. The system functioned satisfactorily with two dispatchers working together. However, transient response was slower than with one dispatcher working alone. It was felt that this could have been remedied to a great extent by revision of the inverter

management, and rationalising of the various modules' settings for variable time-stepping.

## **10.5. Further work**

### **10.5.1. Hardware**

The experimental hardware proved to be rather inaccurate and not very robust to errors in various components. The datalogging should be redesigned with more redundant measurements, and greater measuring accuracy. The inverter should be improved, perhaps with higher efficiency, but certainly with accurate onboard measuring/control of input and output currents and powers. Safety/regulatory issues associated with inverters should be reviewed, since these are subject to ongoing change, normally for the better.

Batteries should be investigated in more detail in order to confirm/deny assumptions made in the battery management software. Also, policy on energy-storage systems should be revised. Systems without any storage at all might be investigated, or other storage systems with smaller penalties for partially-charged operation. For example: Some battery chemistries (e.g. nickel-cadmium, nickel-iron, nickel-metal hydride, lithium ion) suffer no ill-effects from being left discharged. Exotic technologies like flywheels and ultra-capacitors are also eligible.

### **10.5.2. Software issues**

Bugs in the inverter management were found. These were not fatal but contributed to inaccuracy. These should be removed as far as possible, however their existence is partly tied in with incremental cost and multi-domain dispatching.

### **10.5.3. Marginal cost**

A dispatching algorithm without marginal cost optimisation proved to be adequate for controlling the experimental system. However, as a result of this research, it was appreciated that marginal cost facilities would be very desirable. Therefore, a revision of the dispatching algorithm to include it is recommended. This might consist of adding extra information to the communications network; a generator with



incremental cost would provide, not one single price, but coefficients for a modelling equation that described cost as a function of power level. For simplicity, it would be desirable to use a general equation applicable to all kinds of generator/converter, depending on the values of the coefficients. However, it would be possible to include a flag for selecting alternative models.

The dispatcher would set up the modelling equations for each generator, including those with zero incremental cost, which would be represented by all coefficients zero except for a constant term. Equations representing the money earned by selling to loads would also be set up in the same way. The complete system of equations would be solved in such a way as to maximise the money earned per unit of total generating cost.

#### 10.5.4. Multi-domain issues

The experimental system functioned properly with two domains, however its dynamic behaviour was more sluggish than expected.

More thought needs to be given to the design of the software components that handle the connection between domains, so that they can better decouple domains from one another. There are a few possible ways of doing this. For instance, it might be possible to adapt the idea of tie-line bias control from conventional AGC. In this, effort is made to hold tie-line power flows constant except where the demands of load frequency control temporarily override this objective. The setpoints for tie-line power flows are calculated by economic dispatch.

In the system under consideration, the inter-domain connection would take the place of the tie-line. By arranging domains in a tree-like hierarchy, dispatchers at higher levels would see lower-level domains as if each was a single generator/load, and by performing economic dispatch on them, would be managing the “tie-line” power flows. There is no reason why this could not be repeated across multiple levels, provided that the levels were decoupled adequately.

This issue seemed to be related to the variable timestepping system. Proper rationalisation of timesteps used in the various domains and components would probably help to improve dynamics. It is probable that the timestep should be the

same for all programs in a domain. However, timesteps may be made progressively slower as the hierarchy level became higher. For example, bottom-level (individual building/subsystem within building) dispatching might operate at a timestep of 0.1 to 1 second, and top (national) level at a timestep of minutes to hours, which is a comparable timescale to that of current national grid-type dispatching. The inter-domain connection would need to perform explicit translation between the different timesteps of adjacent domains, rather than simply passing the data across as it did in experiments.

#### 10.5.5. Concurrency and commitment handling

Really, the issues involved in multi-domain operation are just different aspects of the concurrency problem. Concurrency was dealt with across single domains by using synchronous operation. However, it is probably not realistic to aim for synchronous operation across an entire multi-domain system. So, what is needed is a different way of handling concurrency. The hierarchy system discussed in 10.5.4 above may be a suitable solution.

Another related issue is that the commitment period associated with an agreement to buy/sell power may change between domains, since it is always one timestep, and the timestep may be different. The responsibility for handling this falls onto the inter-domain connection program. It may be called upon to meet commitments to supply for, say, 5 minutes, when the domain it is buying from only has a commitment of 10 seconds. In order to always guarantee meeting the longer commitment period, therefore, it must have access to a store of energy, either directly controllable by itself, or for sale elsewhere in the system. Alternatively, the possibility must be allowed for that commitments could be broken.

#### 10.5.6. Penalties

If this possibility is entertained, then there would have to be a formal system of penalties for failure, and a means of coping with the power quality consequences of failure. These means are already used in centralised power systems, and were discussed in Section 4.4.3.



### 10.5.7. Combined heat and power dispatching

More research is required into the simultaneous dispatching of heat and power flows of CHP generators. There would be two possibilities in this respect. The most obvious is to use two dispatchers for each domain: one for the electricity market and another for the heat. However, this does not explicitly manage the interactions between the two markets.

A more logical line of attack would be to expand the dispatcher algorithm to deal with several inter-related energy flows associated with each source, rather than a single stream per source as at present. Solution of the heat and electricity markets would then be simultaneous, and the interactions would not be an issue. A practical implementation of this would involve revising the dispatch algorithm and communications layer, as described in 10.5.3 above. In addition to these changes, though, modelling equations for generators would include means of calculating heat output as well as power output, and demands would indicate whether it was heat or power that they required.

### 10.5.8. New Electricity Trading Arrangements

Around the time that this project was in progress, many electricity utilities, including the UK's, were transitioning from the old pool trading system to a new paradigm based on bilateral contracts. In this, the "utility" is unbundled into generators, consumers, and the transmission company. Generators and consumers make contracts with each other directly, and pay the transmission company to transport the electricity. To take care of the inevitable errors, a balancing market is run where generators can tender to produce extra power at short notice. It would appear that the REDMan system is fundamentally compatible with this paradigm, but further investigation is needed.

### 10.5.9. Politics/economics/subsidies

Many energy markets do not work according to pure free-market principles. Markets which have made the most successful transition to EG/RE, such as Germany, Denmark, etc. are characterised by government intervention, subsidising the new technologies. The intention is of course to stimulate the market, causing costs of the

new technology to drop through mass-production, until it is competitive even without subsidies. This was successful in the case of wind energy in Europe. Subsidies are already possible with the existing system, to an extent, because they do not affect the dispatching system directly.

Another mechanism which is sometimes seen is that some consumers are prepared to pay a premium price for environmentally-sound renewable energy. In order to allow this, which is non-rational according to traditional economics, the dispatching system could be modified to give source tracking of energy, so that energy could be labelled or weighted according to its type (e.g. renewable, fossil, cogen, etc) This might override the economic dispatching process, enabling environmentally-conscious consumers to select their desired type of energy, instead of being supplied with the cheapest by default. This would be a further extension of the combined heat and power dispatcher proposed in 10.5.7. However, the complexity of such a system may prove to be prohibitive.

#### 10.5.10. Strategic barriers to implementation

So far, the problems discussed have been purely technical ones, such as making the system perform with large numbers of generators, resolving specific bugs and issues, and so on. However, there are also some broader strategic issues, which have been touched on in passing throughout the text, but which deserve to be summarised here.

The first is that of dispatchability. Most EG plants, as they are designed and built today, are not able to receive dispatching commands from a system like REDMan. Therefore, existing EG plants would need to be replaced or modified, and the design of new EG plants would need to be changed.

The second barrier is a lack of co-ordination between EG and the existing control and protection systems, such as frequency control and anti-islanding. The protection systems currently used in power distribution networks may well not be compatible with REDMan-like systems. Also, the protection systems currently used in EG plants may have negative effects on system stability, if a large amount of EG plant was present. Therefore, currently-used protection hardware and software elements may



need to be updated, which might be expensive and difficult, since they are so numerous and widely distributed in the network.

These issues were discussed in detail in Section 3.4. As for what to do about them, the first step is undoubtedly to perform system studies, in order to gain a more detailed understanding of what is actually happening in the various interactions.

### **10.6. *A final word***

Many ambitious ideas have been put forward in this thesis, and a basic proof of concept experiment has been performed. However, these ideas need more rigorous testing and refinement before they can form a system that will be of practical utility.

One very useful development will be to rewrite the REDMan dispatcher so as to take marginal cost into account. This would resolve the problems and inconsistencies discovered during the experiments, and increase its applicability to thermal generators, inverters, and the like.

However, possibly the most important task will be system studies. These will involve building a model of a sizeable power system that includes distributed generators and the REDMan control algorithms. This could perhaps be done using simulation software like PSCad, ATP, or one of the advanced power systems simulators based on custom computer hardware. The results of such studies will point the way forward in development of the algorithms, and hopefully hasten the day when REDMan can be let loose on a real power system.

## **APPENDICES**



## **Appendix A: Building an inverter**

### ***A.1. What is an inverter?***

Electrical power is usually transmitted and used in the form of alternating current. However, some kinds of electrical generation and storage devices produce direct current, examples being PV modules and batteries. An inverter is a power electronic apparatus which converts DC to AC, allowing the DC power from these generators to be used with ordinary AC appliances, and/or mixed with the existing electrical grid.

### ***A.2. Why build an inverter?***

During the course of this project, the need was identified for a novel type of inverter, which could be dispatched as part of the REDMan system. In practice this meant that it should have a computer interface that could accept commands to set the output power. No inverter of this kind was available on the market, and it was not even remotely economical to have one custom-made by an outside contractor. So, there seemed to be two possible courses of action: buying a commercial inverter that lacked the required facilities and modifying it to suit, or building an inverter from scratch. Modifying a commercial unit seemed attractive at first, but after a few inquiries [1] it became apparent that manufacturers kept the details of their inverters confidential. They were not prepared to release any information on the circuitry of their inverters or the computer firmware that controlled them, even for academic purposes. This is obviously wise practice in a commercial scenario, but it would mean that modifying their product would be a matter of reverse-engineering it; in other words, poring over the circuit boards with a magnifying glass, and trying to reconstruct the firmware from the raw machine code extracted from ROM chips. This would not only be a very difficult job, but probably an offence under intellectual property law.

On the other hand, while building an inverter from scratch might seem more difficult, the whole reverse engineering issue would be avoided, and more importantly, the

plans could be placed in the public domain where they might be of use to other researchers.

### **A.3. Design objectives**

The most important objective, and the whole purpose of the exercise, was that the inverter must be controllable in real-time by a computer. It must accept commands telling it how much power to transfer from DC to AC at a given instant.

It would also have to be reliable. It is all too easy to create a unit that performs OK on the test bench, but fails in the field. The unit would have to operate successfully for the duration of the experiment – at least one month.

Efficiency was also a concern. If the experiment was to give realistic results, the efficiency would have to be representative of the efficiencies of contemporary commercial inverters. Since these can exceed 90%, this could be challenging.

Safety and power quality were also crucial. Any risk to personnel caused by malfunctioning of the inverter would be completely unacceptable, as would disruption to other electrical equipment caused by interference from the inverter. UK electricity companies drafted the G77 standard, defining the required safety features, and maximum level of distortion, permissible for equipment connected to their grid, and ideally the design would meet these. However, this is a fairly strict specification, and there would always be the danger that meeting it would not be economical in terms of time and money. N.B: at the time of writing, the UK standard was harmonised with the US standard, IEEE P929 [2].

The final consideration was the power rating of the apparatus. It would be wise to make it at least the same, if not more than; the expected peak power from the RE sources in the experimental system. The PV arrays totalled 260 W and there were also two 100 W wind turbines.



#### A.4. Specification

Parameter	Min	Typ	Max	Unit
<b>Power quality:</b>	<b>(as per G77)</b>			
Current THD			5	%
P.F.	0.95 lead		1.00	
DC Injection			5	mA
<b>Protection:</b>	<b>(as per G77)</b>			
Voltage range	216	230	253	V
Frequency	47	50	50.5	
Disconnect time			5	S
Reconnect time	3			Minutes
<b>Performance:</b>				
Efficiency		85	90	%
Power control tolerance			1	%
Output power	300			W

Reconnect time is to be reckoned as time after supply is restored within limits. Disconnection to be by mechanical contacts to IEC 255, not electronic means.

#### A.5. Basic design choices

Now that the specification is known, the task is to design the inverter circuit that will meet it. There are a number of different possible circuits, but fundamentally, all inverters work by using switches to periodically reverse a direct voltage. So, the two main design choices to be made are: what sort of switches to use, and what control algorithm to use for switching them on and off.

### A.5.1. Switching technologies

Historically, inverters have been made with every kind of switching apparatus, such as rotating or vibrating mechanical contacts, gas-filled electronic valves, and thyristors (SCRs). However, in contemporary use, the field is led by two special kinds of transistor.

The first kind is the Metal-On-Semiconductor Field-Effect Transistor (MOSFET). This device has a very rapid switching action, and can be designed with a low resistance so that it will pass high currents efficiently, provided that the voltage it has to stand in the 'OFF'-state is low. MOSFETs designed to withstand high voltages have a much higher 'ON'-state resistance, making them less efficient. Whatever the voltage rating, MOSFETs are electrically robust, and difficult to destroy by excessive voltage or current.

Complementing the MOSFET is the Insulated Gate Bipolar Transistor (IGBT). When designed for high 'OFF'-state voltages, this outperforms MOSFETs, although the MOSFET is still best at lower voltages. IGBTs switch rather slower than MOSFETs and are not quite as resistant to damage by overloads [3].

Given these advantages and disadvantages, the actual device chosen will depend on what sort of inverter circuit is chosen (this determines the voltages and currents imposed on the devices) and on what control algorithm is chosen (this determines the speed at which switching must be performed)

### A.5.2. Circuit topologies

The most simple and well-known kind of inverter is as shown in Fig A.1. It consists of four switches which connect the DC supply (symbolised by a battery) across the output terminals, first in one sense, then in the other. In this way, the voltage is periodically reversed.

Voltage conversion is often required where an inverter is used. This is the case in the present application, where 24V DC must be converted to 230V AC. The circuit of Fig A.1 has a fixed output that is determined by the voltage of the DC source. There are two common ways of circumventing this, the simplest being to apply the AC output of the inverter to a transformer, and so step it up or down to the desired



voltage. This circuit is shown in Fig. A.2. A more complex method is to change the voltage of the DC source instead, by means of a DC-DC converter. This is made of an inverter (sometimes called a *chopper* in this application) followed by a transformer, followed in turn by a rectifier, as shown in Fig.A.3. Although this is more complicated, it has certain advantages. When the inverter output is fed through a transformer, the transformer must be designed to operate at the inverter's output frequency. In the case where the inverter operates at 50 Hz, the transformer can be rather bulky and costly. When a DC-DC converter is used, its operating frequency can be made different to the eventual output frequency. By using a very high frequency, such as 50 or 100 kHz, a much smaller transformer is needed to handle the same amount of power, making the finished apparatus lighter, more compact, and cheaper. But, since the inverter stage connects directly to the line in this circuit, DC injection could be a problem.

When an inverter circuit is used to drive a transformer, there are extra possibilities in terms of topology. The most common circuit uses a centre-tapped primary winding and cuts the number of switches required from four to two. ("Inverter 1" in Fig. A.3 is of this kind.) While this saves money on switches, it makes the transformer less efficient, because each half of the winding is passing current only 50% of the time. Hence for a given mean current (which determines the power output) the RMS current (which determines the losses) will be higher, and so for a given design efficiency, the transformer must be bigger and more expensive. This must of course be weighed against the fact that in the full-bridge circuit, the current must pass through two switches in series. In practice, the centre-tap circuit is very commonly used where the DC source voltage is low and the operating frequency is high.

NB: A point should be made here on terminology. The functions of voltage changing and DC-to-AC conversion are normally combined in the same apparatus. Even though it is made of an inverter and a transformer, or even two inverters, a transformer and a rectifier if a DC-DC converter is used, it is customary to refer to the whole apparatus as an 'inverter'. To muddle matters even further, the digital logic gate performing the 'NOT' function is also known as an inverter, even though it has nothing to do with converting DC to AC.

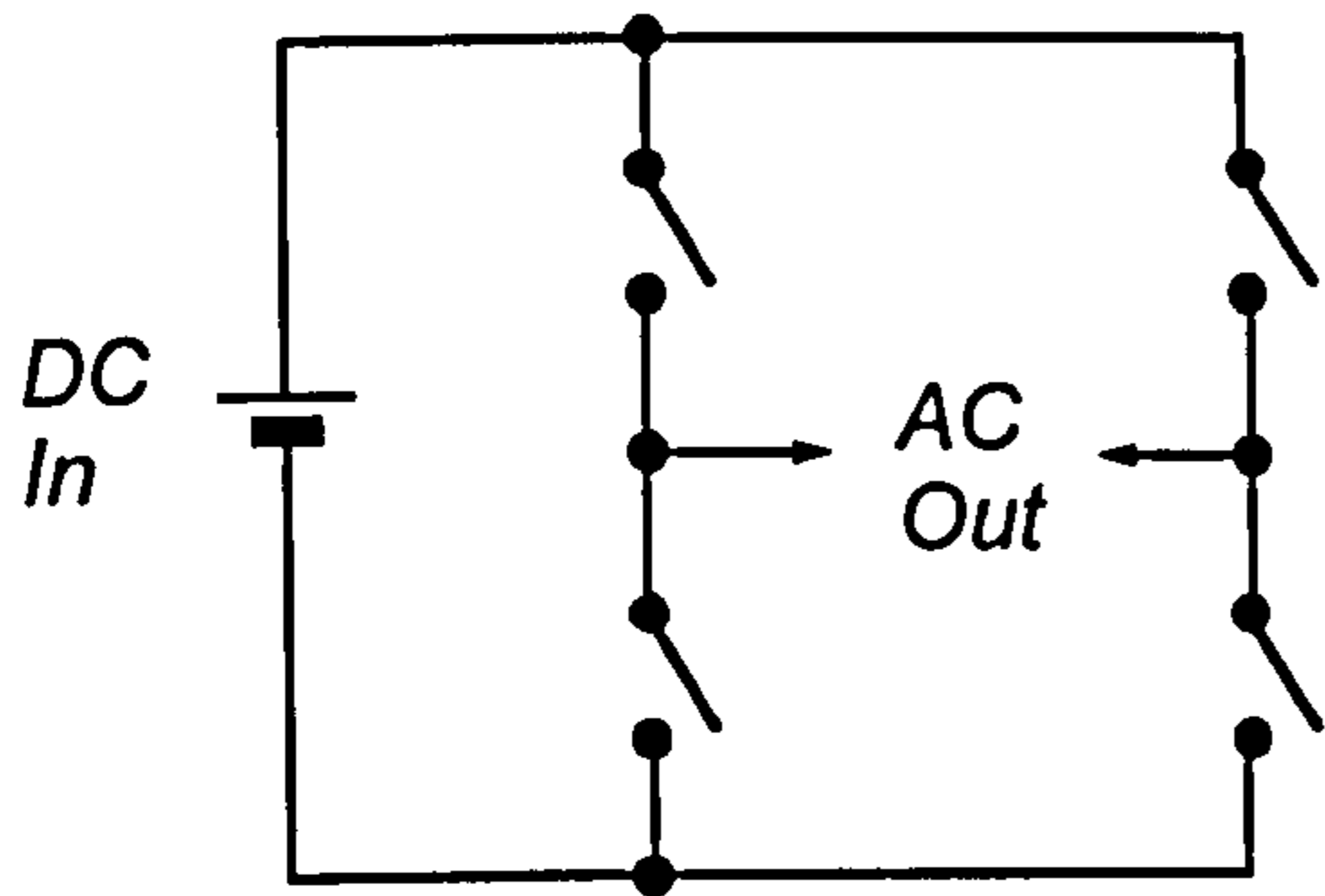

(Fig A.1: Basic inverter circuit)

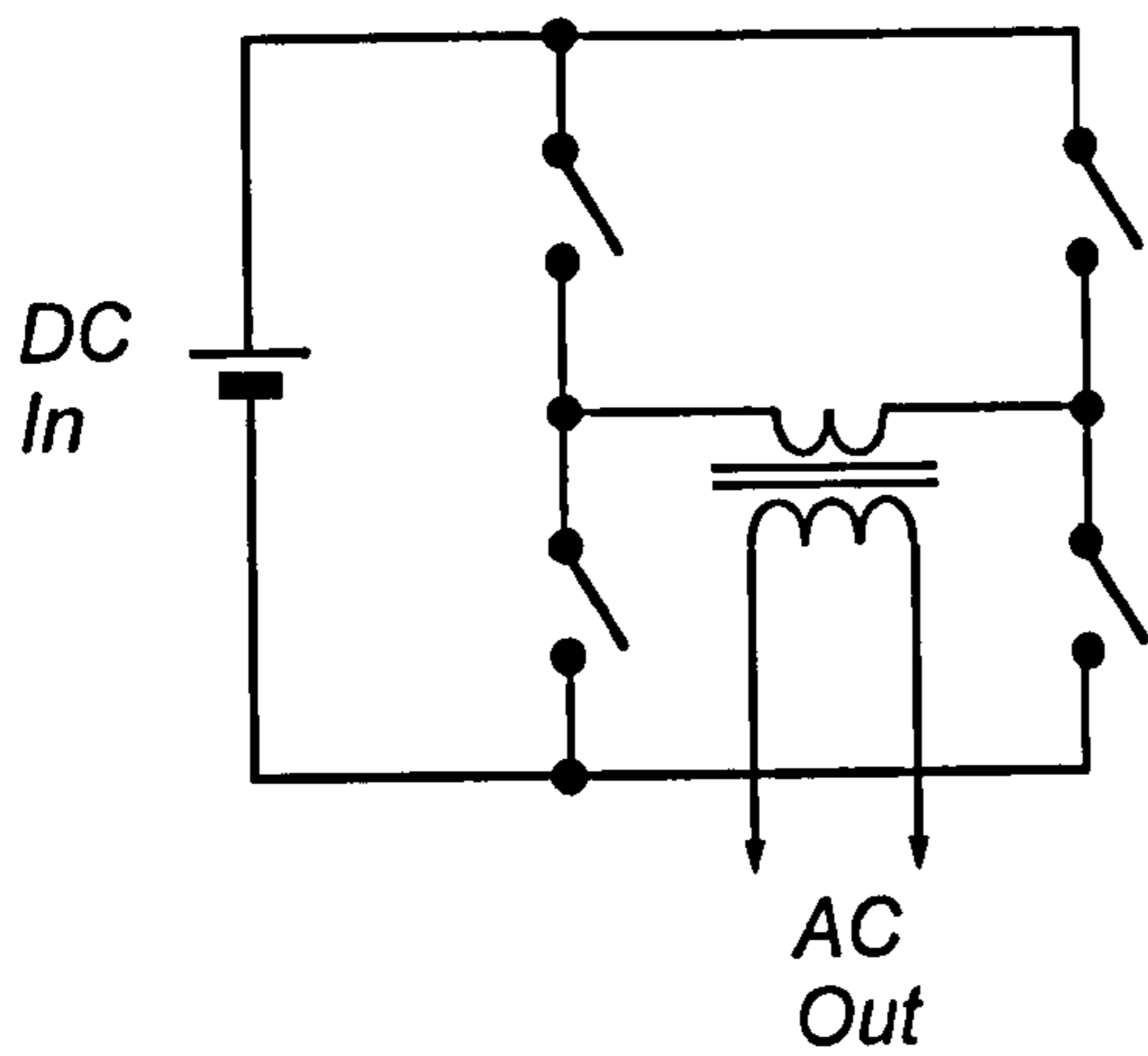

(Fig. A.2: Inverter with transformer)

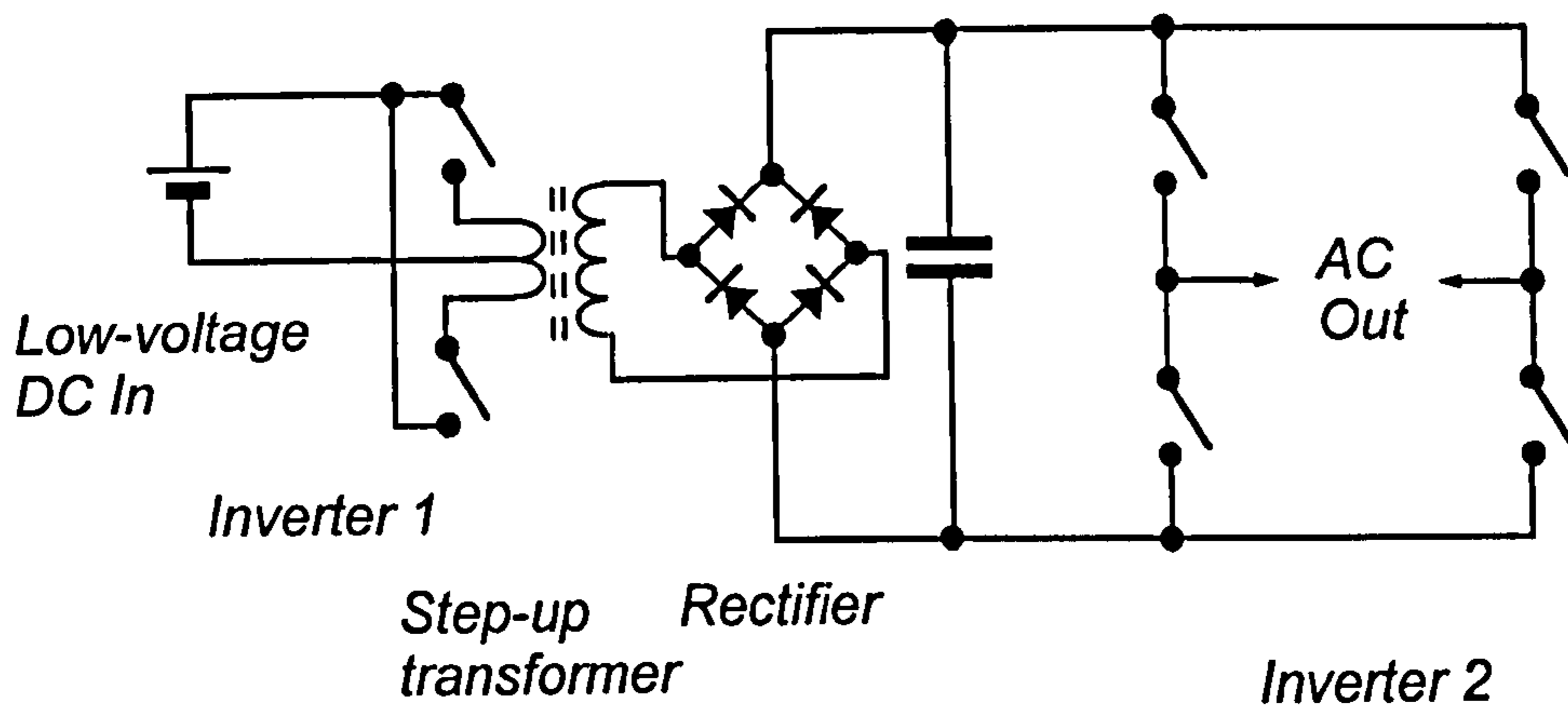

(Fig. A.3: Inverter with DC-DC converter)



### A.5.3. Control algorithms

From the point of view of control, these different inverter circuits are more or less interchangeable. The precise details of exactly which switches must be operated vary from circuit to circuit, but the scheme that controls *when* they are to be operated tends to be the same.

The most basic is the algorithm described earlier. To generate one half-cycle of the output, the inverter is switched to one polarity; for the next half-cycle it is switched to the opposite polarity. This generates a square output waveform whose peak amplitude (NB: peak and RMS are same for square wave) is equal to the DC source voltage. This is very easy to implement, but a square wave will not satisfy the requirement for low distortion. (The total harmonic distortion of a square wave is around 55%)

The next step in complexity is to arrange for a period in the cycle when the output voltage is zero. In the full-bridge inverter circuit, for example, this is achieved by turning S1, S3 on, hence shorting the AC terminals together. The result is a square wave with pieces missing, which can be arranged to have a peak-to-RMS ratio the same as a sine wave. This is very useful when the inverter is used to power a collection of normally mains-driven apparatus, which includes some appliances functioning according to the RMS voltage, and others requiring the peak voltage to be correct. With an ordinary square wave, the peak:RMS ratio is always 1, so both conditions cannot be satisfied at once. The harmonic distortion of this 'modified sine' wave is also less than a square wave (at around 25%) but this is still too high to meet the specification.

Therefore, it will be necessary to turn to more advanced methods. The most popular and most efficient way of creating a genuine sine-wave output is by pulse-width modulation (PWM). This starts with a sinusoidal modulating wave at the desired output frequency, and a triangular carrier wave at the desired switching frequency. These two waveforms are fed to a comparator: an electronic comparison circuit whose output is 'HIGH' if the instantaneous value of the modulating wave is greater than that of the carrier wave, and 'LOW' otherwise. The result is a train of pulses

repeating at the carrier frequency, with the width of each pulse proportional to the value of the modulating wave. A spectrum analysis of this waveform would show that it contained a component at the modulating frequency, a component at the carrier frequency, and the harmonics of the carrier frequency. This pulse train is used to operate the inverter's switches, so that a high-power replica of it emerges from the inverter's AC output terminals. A low-pass filter is then used on this to remove the carrier frequency and its harmonics, while letting through what turns out to be a very good reconstruction of the modulating wave. See [4] for more information.

The task of the low-pass filter is eased by making the difference between carrier and modulating frequencies very large. By using MOSFET switches, which perform very well at high frequencies, it is easily possible to have a carrier frequency of, say, 50 kHz, and so the carrier can be greatly attenuated, while the desired 50 Hz component is unaffected, using only a simple second-order filter. In this way, it is theoretically easy to meet the distortion spec.

The PWM generator can be simplified even more by using hysteresis (aka bang-bang) control, which is a technique borrowed from commercial inverters that drive induction motors. In bang-bang control, the carrier wave is dispensed with, and the modulating waveform is compared directly with the AC output. The result of the comparison is used to control the power switching stage: If the output is too great, the power switch is turned OFF so that it begins to decrease, and if it is too small, the switch is turned back ON. This can be thought of as forcing the inverter to generate its own carrier by self-oscillating, and for it to work efficiently, there are two necessary conditions. Firstly, the comparator must have hysteresis (a dead band where no action is taken) and secondly there must be a low-pass filter included between the inverter switches and the output which is being controlled. If there were no filter, the output would change immediately the power switch changed state. Between them, the hysteresis band size and the filter cutoff frequency determine the effective carrier frequency.

The bang-bang approach is also well-suited to grid-intertied operation. The conventional form of PWM generation is not very suitable, because the modulating input controls the output voltage. So, the output of a classical PWM inverter appears



as a voltage source. Now, the grid is also a voltage source, and so there are two voltage sources connected together by the very small reactance of the inverter's output filter. Thus, tiny changes in the magnitude or phase of either voltage would cause large and dangerous current surges.

However, by sensing the inverter's instantaneous output current, and using bang-bang control acting on this, then the inverter appears as a current source instead, and the problem is avoided. The necessary low-pass filter takes the form of an inductor in series with the inverter's output terminals.

### ***A.6. Simulation***

An inverter of the design described above was simulated using ATP, the Alternative Transients Program [5]. At this early stage, the precise design details were not yet known. For this reason, and also to save computing resources, a simple representative circuit was simulated. The model used was a combination of two parts: a schematic of the switching circuit created with the ATPDraw graphical front end, and a description of a bang-bang controller algorithm/circuit made with ATP's MODELS language. The ATP simulator solved the electrical circuit, and also executed the controller algorithm at every timestep of the solution. This model was mainly used as a design aid, to explore the effects of different kinds of output filter and different hysteresis bands. The results gave confidence that the proposed design could be made to work and give good performance. Figs. A.4-A.7 show the schematic diagram, the control algorithm description, and some sample waveforms. The circuit modelled here uses a second-order LC output filter.

### ***A.7. Practical design issues***

Once the basic topology and strategy of control had been developed, the next step was to design a practical electronic circuit around them.

The main problem was to find a way of sensing inverter output current for the bang-bang control. The nature of the challenge was this: In accordance with feedback control theory, the error performance in a system of this kind is mainly limited by the sensor. The sensor would have to be accurate to within a few per cent to meet the specification, with a low DC offset being vital to prevent DC injection to the line,

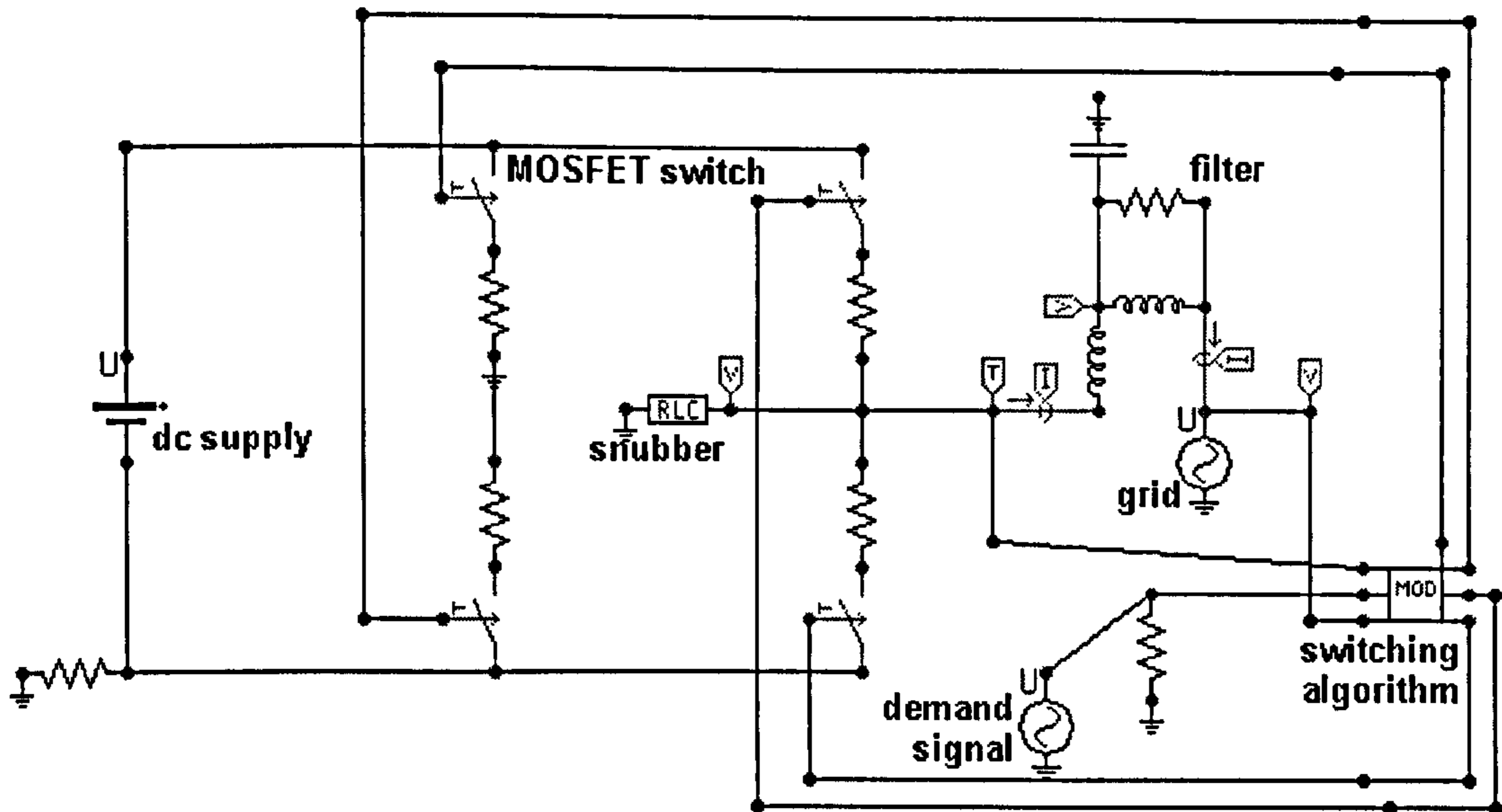

(Fig. A.4: ATPDraw schematic of the inverter model)

```

MODEL bang3
DATA
  db                -- dead band magnitude (amps)
INPUT
  IL,VDEM,VGRID    -- inductor current, demand current
OUTPUT
  S1,S2,S3,S4     -- to TACS switches
VAR
  S1,S2,S3,S4
HISTORY
  S1 {dflt:0}
  S2 {dflt:1}
  S3 {dflt:1}
  S4 {dflt:0}
  IL {dflt:0}
EXEC
  if VGRID>0      -- first do left hand bridge (50 Hz)
  then
    S1:=0
    S2:=1
  else
    S1:=1
    S2:=0
  endif
  if IL>(VDEM+db) -- now do right-hand half (hysteresis)
  then
    S3:=0
    S4:=1
  endif
  if IL<=(VDEM-db)
  then
    S3:=1
    S4:=0
  endif
ENDEXEC
ENDMODEL

```

(Fig. A.5: ATP MODELS description of bang-bang controller)



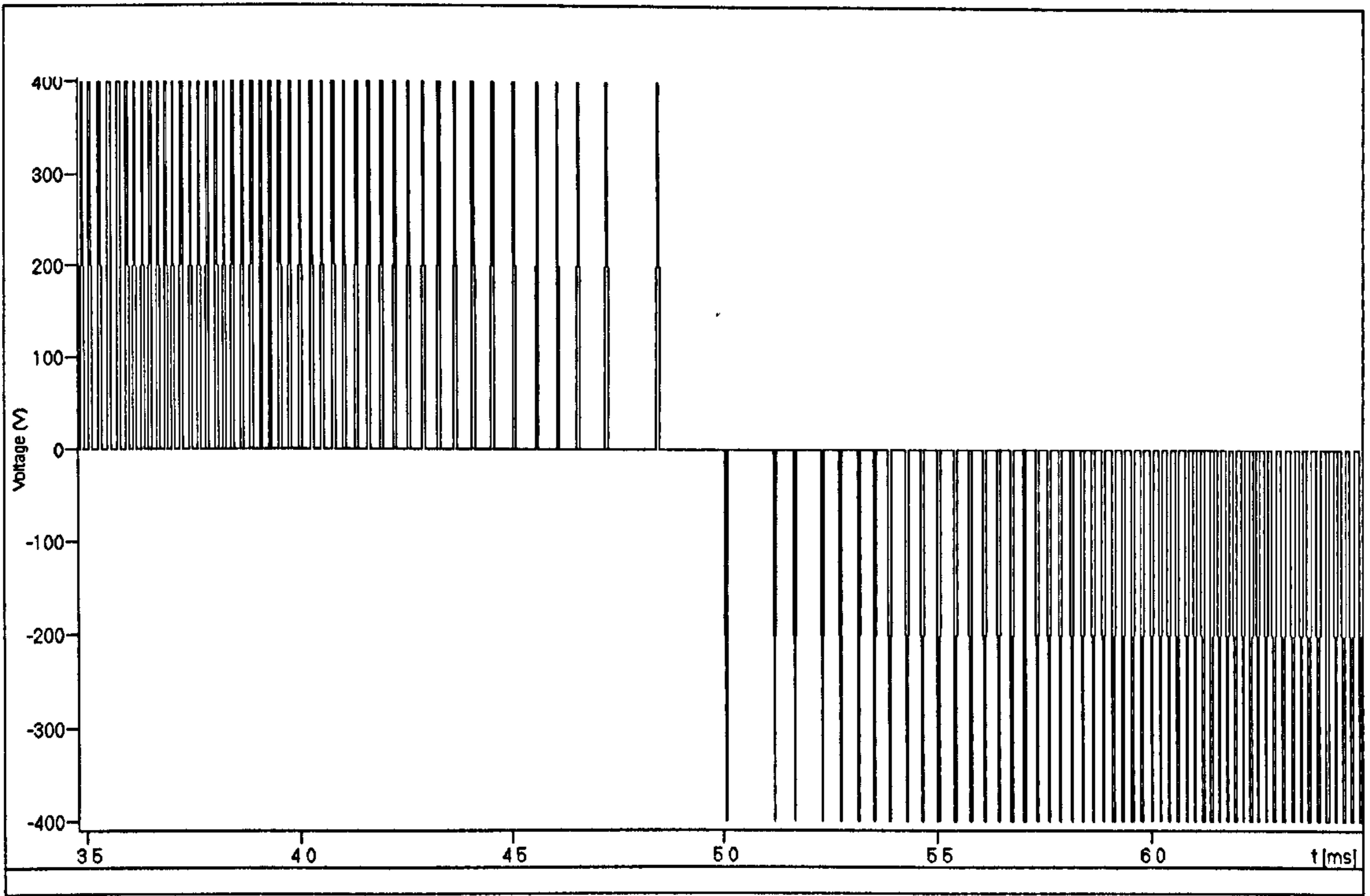

(Fig. A.7: Simulated switching waveform: close-up shown, note time scale)

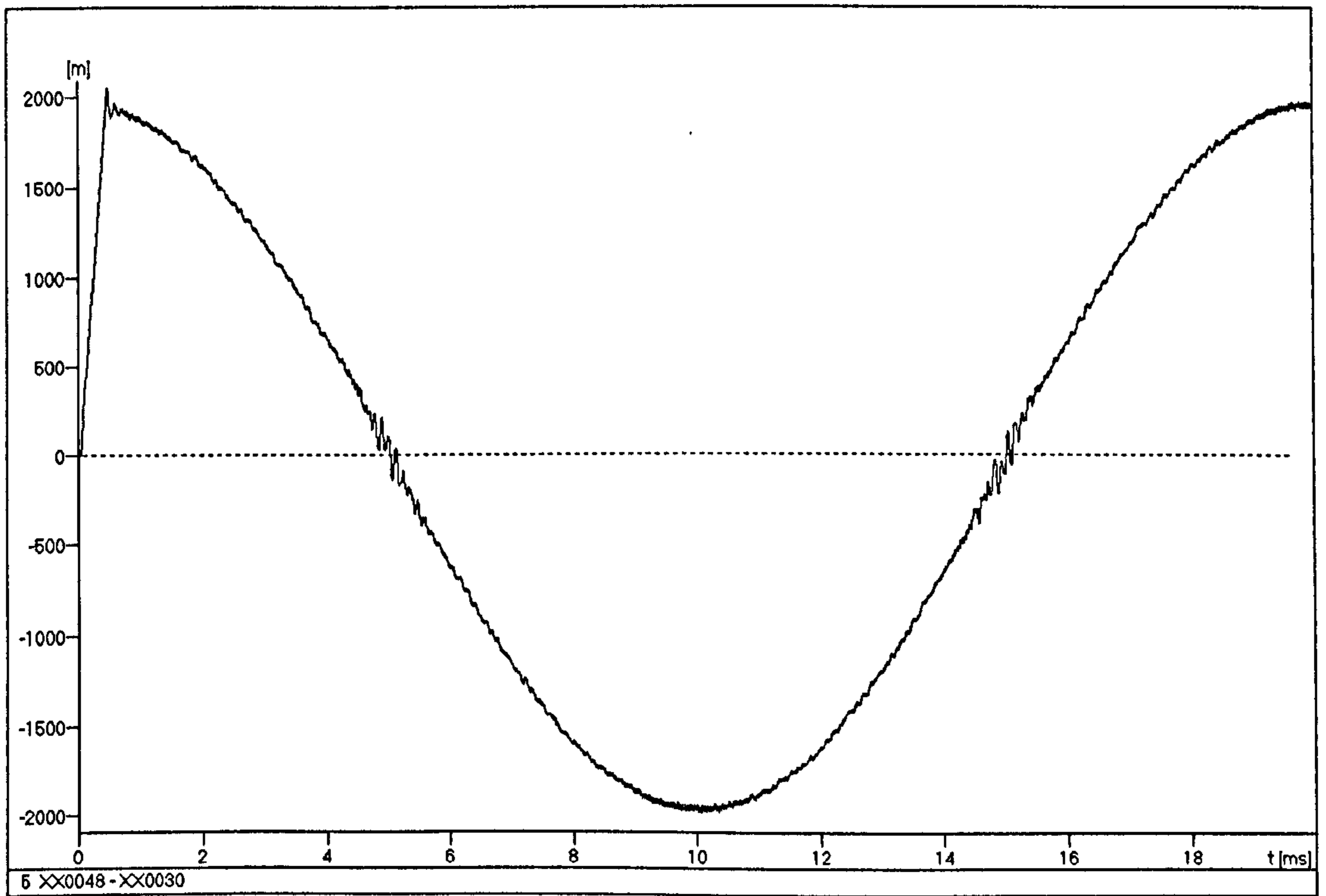

(Fig. A.8: Simulated line current waveform)

or saturation of the output transformer if one was used. It would also require high bandwidth so that the bang-bang control would work properly. Finally, it would need excellent immunity to interference from the inverter's own HF output voltage.

A current transformer would seem attractive, because of its immunity to interference. Unfortunately, the sensor needs to be DC-accurate, and transformers do not respond to DC at all. This could probably be got round by ingenious circuitry, but even then the transformer would have to be physically large if it was to handle the 50 Hz component of the inverter output without saturating. Its leakage inductance might then cause problems with accurate measurement of the HF components.

A natural contender, then, was the Hall-effect current transformer. It can respond to DC, and has a high bandwidth. Unfortunately, though, the devices investigated all had a very large DC offset, which ruled them out.

The remaining option was the humble sense resistor. This had been ruled out, because it would have to be placed in series with the inverter's output. In this situation, the small voltage across the resistor would have to be separated from a large high-frequency common-mode signal.

This seemed to be a major problem. Solutions like opto-isolation were investigated and ruled out on grounds of complexity or inaccuracy. It was finally solved by a modification to the switching circuit (See Fig. A.8)

It works because the full-bridge (as it is usually set up) has only one side driven with HF at a time. The sides change roles with every half-cycle. The inactive side has the lower switch turned on continuously, in effect earthing the un-driven end of the load.

So, two extra transistors were added solely for this function. Instead of taking the load current directly to earth, they were arranged to divert it through a current-sensing resistor. Crucially, one end of this resistor is now earthed, solving the common-mode interference problem. A simple op-amp differential amplifier finishes off any remaining common-mode due to voltage drops in the ground paths.



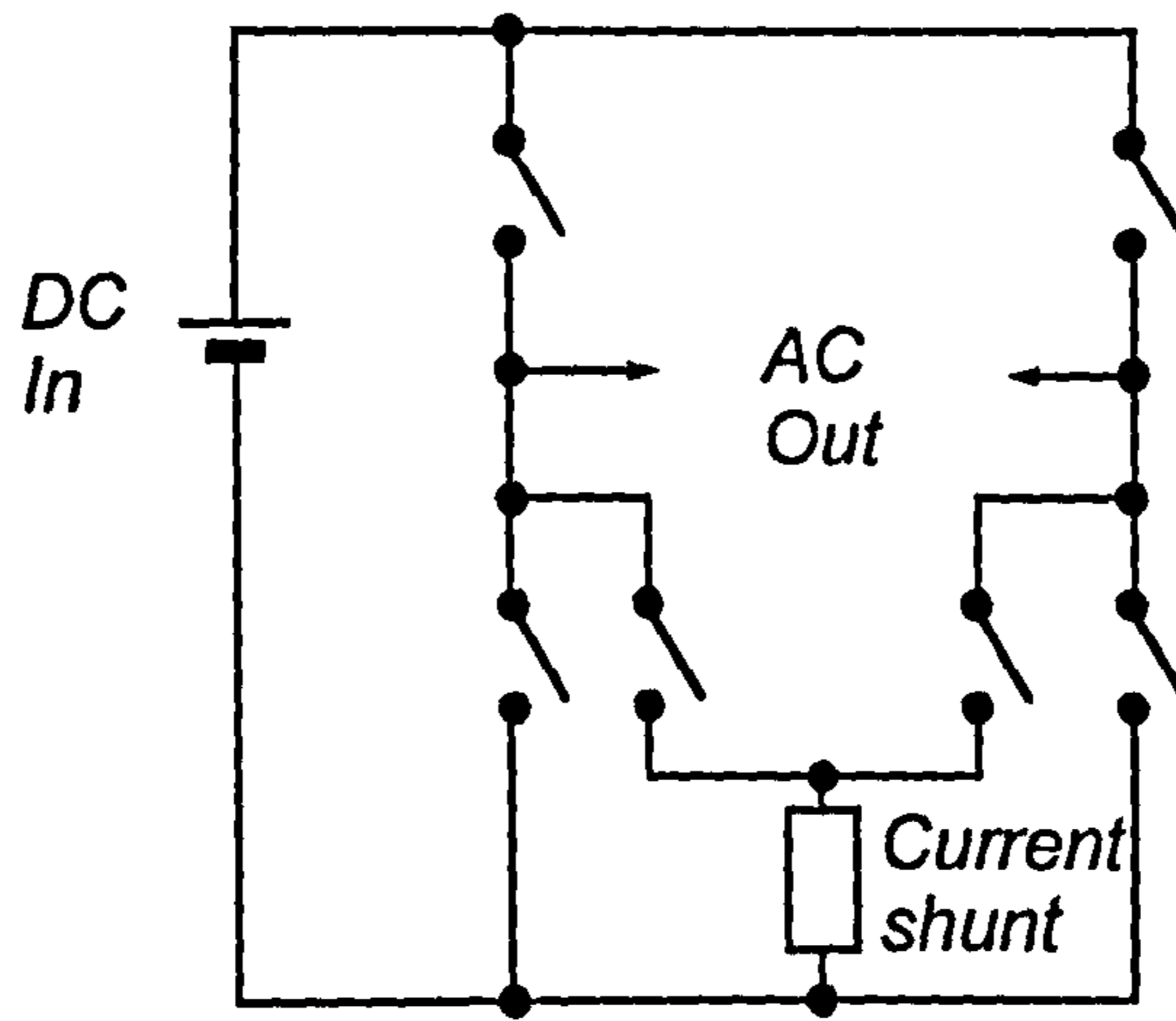

(Fig. A.8: Modified full-bridge inverter for easier current sensing)

## **A.8. Control circuits**

### **A.8.1. PWM generator**

This is perhaps a misleading title, because the bang-bang method of control causes an oscillation involving the entire circuit. So, it is hard to say just which part is actually the PWM generator. For the purposes of this discussion, though, it will be defined as the part from which the PWM waveform first emerges, which means the comparator circuit which compares the modulating wave to the measured current. The comparator is U2A of Fig. A.9. It compares the DAC output (smoothed slightly by C2 and buffered by U1B) with the voltage across the current shunt, amplified ten times by differential amplifier U1A, and smoothed to eliminate high-frequency interference by R5, C1. R6, R7 and R8 set the amount of hysteresis, while R9 is a pull-up resistor required due to the design of the comparator chip (open-collector output) The PWM waveform appears at U2A output, and is fed to the power switching circuitry via a switching logic circuit, described next.

### **A.8.2. Switching logic**

The main issue to be addressed is how to drive the switches in the proper sequence. There are six separate switching elements, and yet the PWM comparator only gives one output. Some sort of additional logic is required to sequence the operation of the switches.

With reference to Fig A.10, the basic strategy of operation is this. During one half-cycle of the grid voltage, the PWM waveform is applied to S1, S2. S1 receives the normal waveform, and S2 receives its inverse, so that S1 is ON when S2 is OFF and vice versa. The result is an amplified copy of the PWM waveform at the junction of S1 and S2.

While this is happening, S3 and S4 are both OFF. S6 is permanently ON, connecting the other output terminal to ground.

During the next half-cycle, the roles must be swapped over. S3, S4 receive the PWM signal, while S1, S2 are off, and S5 is ON.



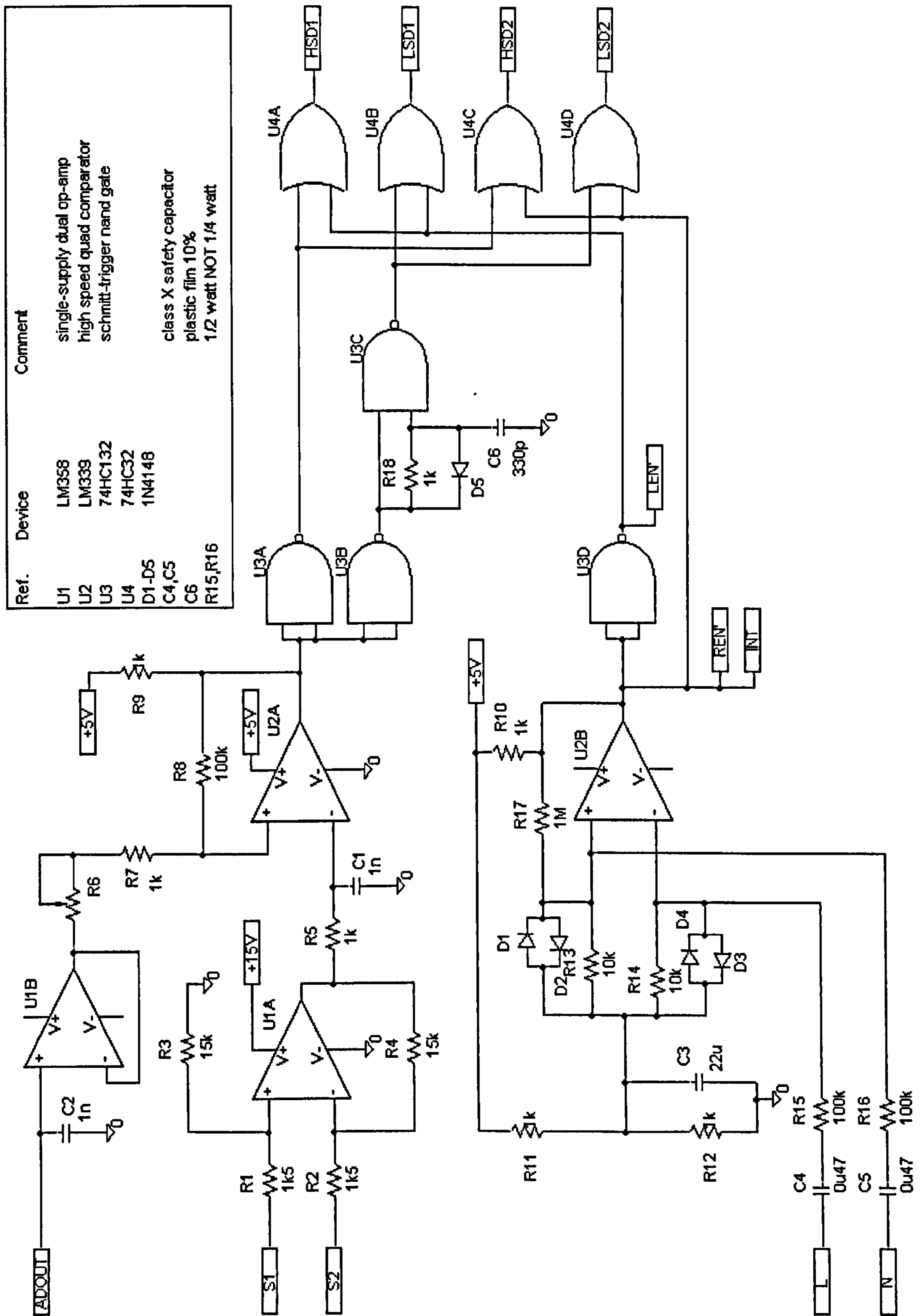

(Fig.A.9: PWM generator and switching logic circuits)

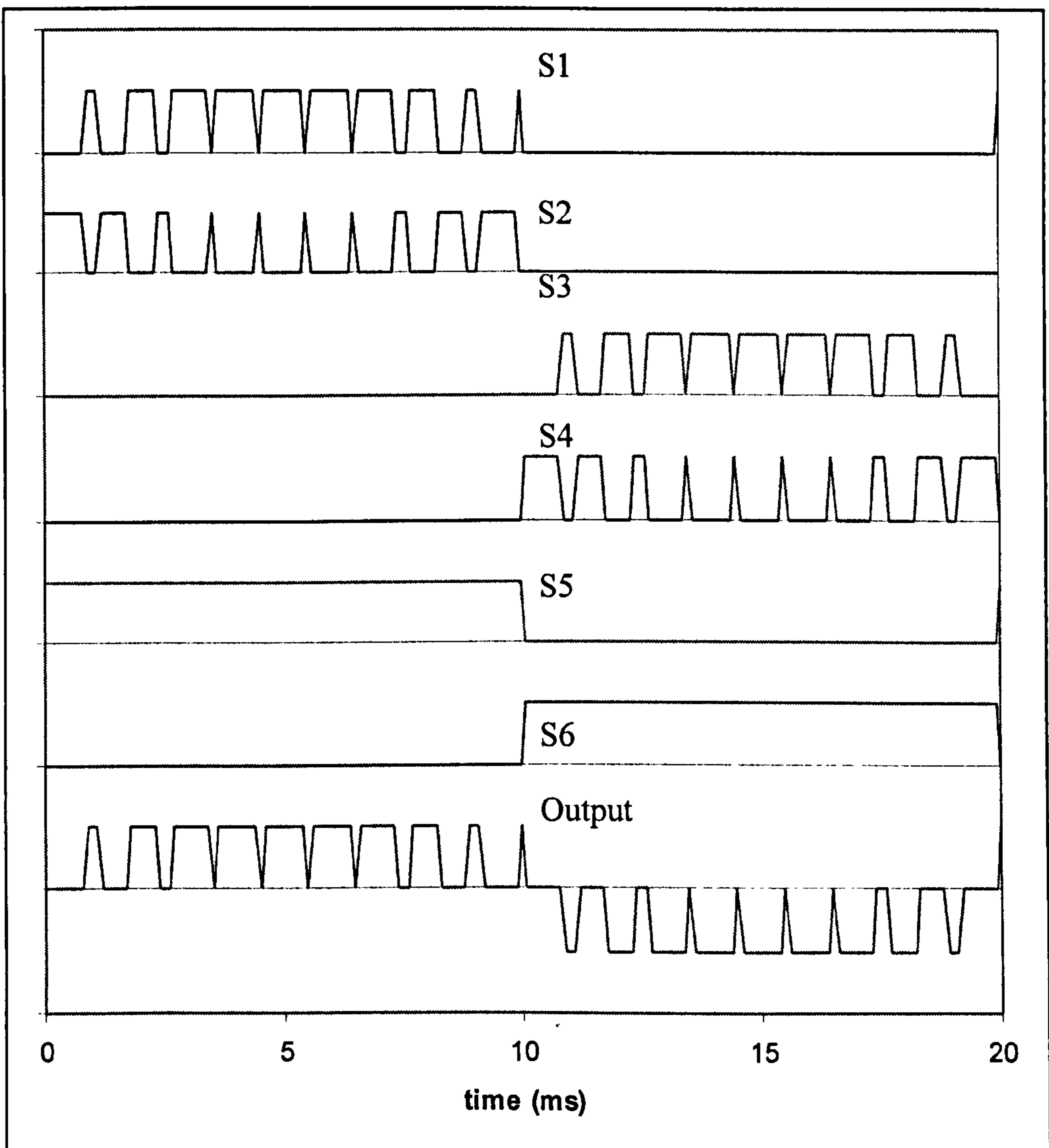
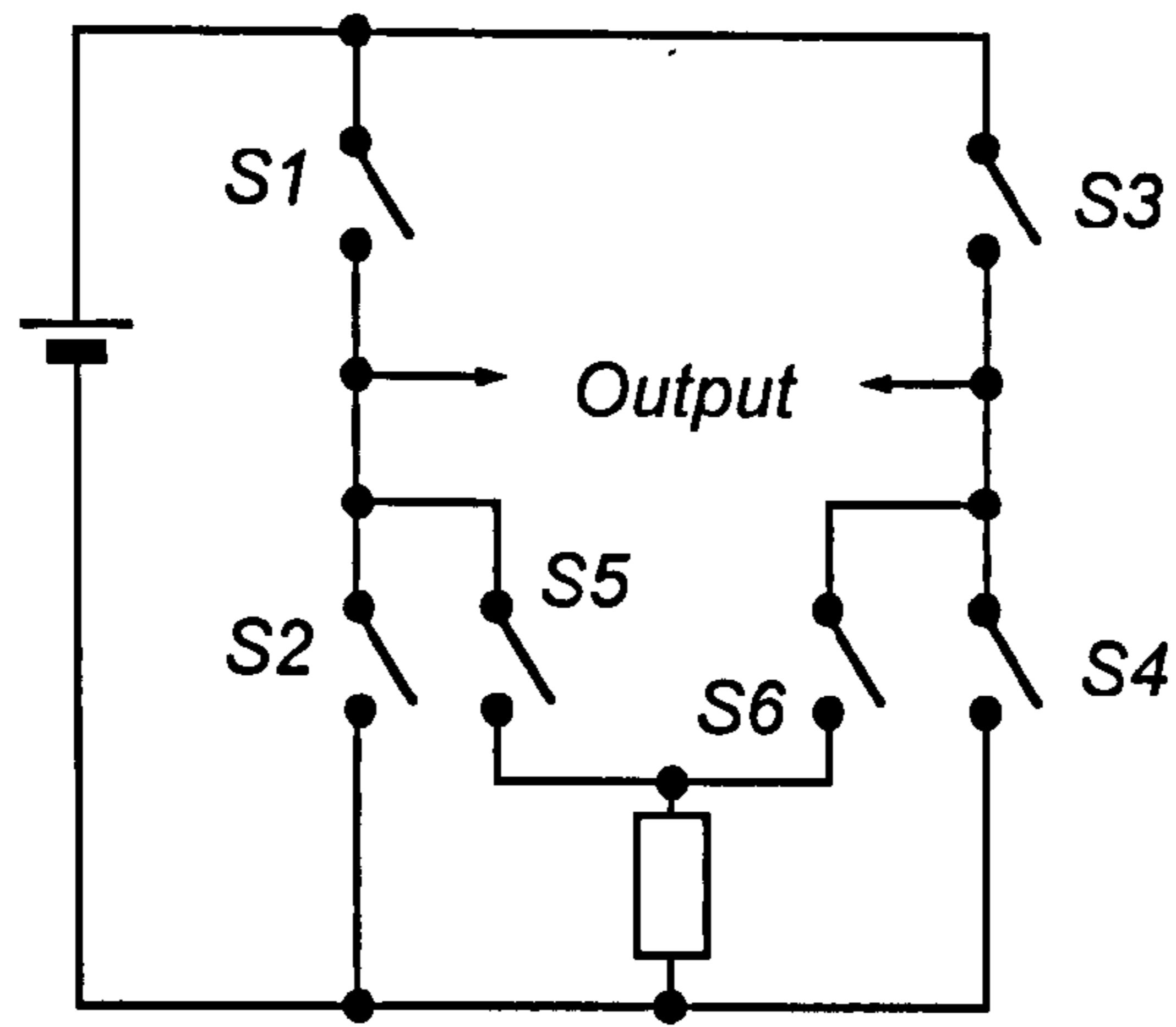

(Fig.A.10: Switching circuit and simulated waveforms. Carrier frequency reduced for clarity)



These rules can be turned into a simple collection of digital logic gates by using well-known techniques. Firstly, the inputs to the circuit must be defined: they are P, the PWM pulsetrain, and G, the polarity of the grid voltage. (G=0 when grid is negative and 1 when it is positive) Let the outputs be S1, S2, S3, S4, S5, S6, and let a '1' indicate that the corresponding switch is closed. A truth table can then be drawn. In the interests of clarity, this will not be done in the conventional manner; instead of the usual 0 or 1, the outputs can also be P or P'.

G	S1	S2	S3	S4	S5	S6
0	0	0	P	P'	0	1
1	P	P'	0	0	1	0

(Table A.1)

From this it is easy to write Boolean expressions for each output:

$$S1=PG \quad (\text{Eq. A.1})$$

$$S2=P'G \quad (\text{Eq. A.2})$$

$$S3=PG' \quad (\text{Eq. A.3})$$

$$S4=P'G' \quad (\text{Eq. A.4})$$

$$S5=G \quad (\text{Eq. A.5})$$

$$S6=G' \quad (\text{Eq. A.6})$$

Before proceeding from here to an actual logic circuit, there is one detail that must be taken care of. S1, S2 are in series across the DC bus, as are S3, S4. If both switches in either pair should turn on simultaneously, the result is a short across the DC bus. Even if this only happens for a matter of microseconds, a very high current can momentarily flow, which leads to inefficient operation and possible damage to the circuit. To avoid this destructive "shoot-through", it is normal practice to arrange a small delay in the turning-on of each switch, so that the previous one has ample time to turn off. The precise nature of the delay required depends on the switching speed of the power circuit, which will be discussed in more detail in a subsequent section. For now, suffice it to say that by the nature of their driver circuits, S1 and S3 will

naturally turn on and off somewhat slower than S2, S4. Therefore it is sufficient to delay the turning-on of S2, S4. The logic expressions for these can be rewritten:

$$S2=Q'G \quad (\text{Eq. A.7})$$

$$S4=Q'G' \quad (\text{Eq. A.8})$$

Where Q' is the same as P' but with a delay introduced in each low-to-high transition. Components R18 and C6 introduce this delay in the circuit.

Both switching logic and PWM generator are shown in Fig. A.9. The grid voltage signal G is derived from U2B and associated components. These act as a differential comparator measuring the voltage between live and neutral of the mains input. It can be thought of as a differential amplifier with very high gain, so that the output is a square wave. C4, C5, R14, R16 attenuate the mains voltage to a safe level.

### A.8.3. Drive circuits

There are a few peculiarities involved in actually applying these drive signals to MOSFETs, which will be explained here. A certain amount of specialised drive circuitry is needed, and the circuit used is shown in Fig. A.11, to which the following explanation refers.

The first difficulty is that the gate of a MOSFET has considerable capacitance. It is essential to turn the MOSFET on and off as quickly as possible, and so high peak currents are required to charge and discharge the gate capacitance. In order to provide the current, a complementary pair of transistors Q1 and Q2 are used as emitter follower buffers. These are special transistors designed for the application and can supply peaks of up to 2 A. MOSFETs M5 and M6 do not have this drive circuit because they only operate 50 times per second and so do not require high-speed switching.

The second difficulty is that the drive signal must be referred to the MOSFET source. In the case of M2, M4, M5, M6 this is not a problem since the source is grounded. But M1 and M3 have their sources connected to the output terminals. When they are turned on, the source voltage will rise to the DC bus voltage, and so to keep them switched on, the gate voltage must be kept higher than the DC bus. This is taken care of by a 'bootstrapping' circuit, which supplies the gate drive voltage from a



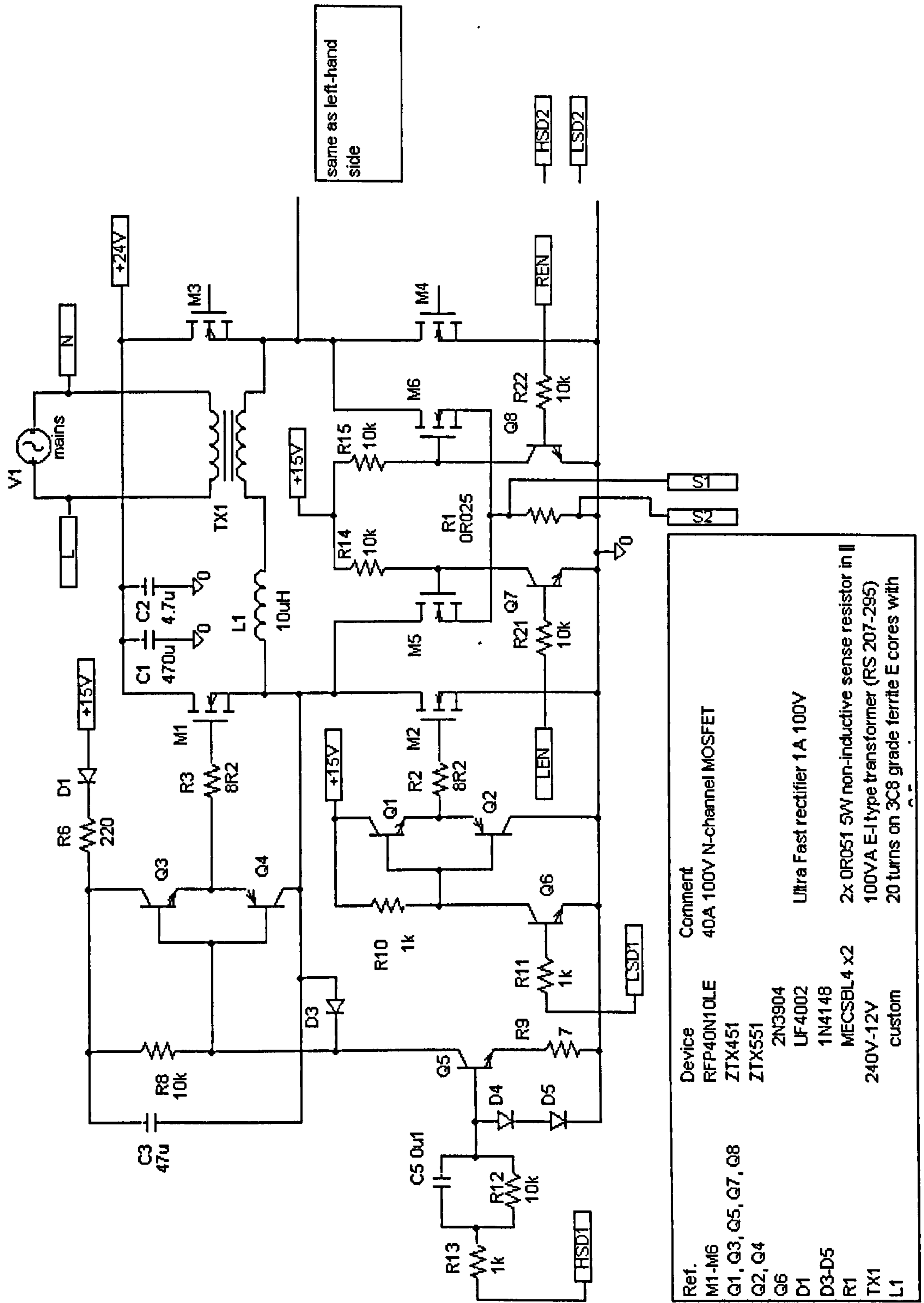

(Fig. A.11: Circuit diagram of driver stage. One half only shown.)

capacitor, C3, connected to the source. This capacitor is charged from the auxiliary 15 V supply via R6, D1 during periods when M2 is on and the source is grounded. A side-effect of this circuit is that it slows down the switching action compared to the non-bootstrapped version. This is because the voltage at Q5 collector must swing by a larger amount, and hence the Miller effect in Q5 will be greater. The network C5, R12 injects extra base current to compensate for this as much as possible, but it is still somewhat slower.

It should be noted that these drive circuits all invert the signal: a HIGH input signal turns the associated MOSFET OFF. This is taken care of by modifications to the switching logic.

#### A.8.4. Reference generator

If this circuit is to produce a sinusoidal output, it requires a sinusoidal modulating wave as a reference. In order to connect to the grid, the reference must be phase-locked to the grid voltage. Also, the power output is controlled by varying the magnitude of this wave, so to ensure accurate results, the magnitude must be stable, and controllable in an accurate and repeatable manner.

Various ways of generating this were investigated, and there seemed to be two attractive methods. The first was to use traditional analogue techniques. The reference would be generated by a sinusoidal voltage-controlled oscillator (VCO) with stable output amplitude. A phase-locked loop (PLL) would be used to synchronise this with the line voltage. To vary the power level, an analogue multiplier would be used to multiply the reference waveform with a DC power command voltage. This would ultimately be derived from a digital-to-analogue converter (DAC) under control of a computer running dispatching software.

The main competitor was a microcontroller-based system, where all the processing is done by a computer program, and a DAC outputs the finished reference waveform. This system could be called direct digital synthesis (DDS) In this, the reference waveform is stored digitally as a look-up table (LUT) in memory. At regular intervals, successive cells are read from the LUT, and sent to the DAC. However, for this application, the basic DDS is elaborated somewhat. To implement power



control, each value from the LUT is simply multiplied by a power command value, read in from the host computer via some kind of digital interface. Synchronisation is achieved by sensing the zero-crossings of the grid voltage, and having the program adjust its timing until its own zero-crossings coincide with them; this is just a digital version of the phase-locked loop used in electronics.

The choice between these two techniques is not difficult. Although the analogue system is conceptually easier to understand, there are serious challenges associated with making a VCO whose output amplitude remains constant to within 1%, and a multiplier which is similarly stable. The digital version, while being somewhat more troublesome to construct and de-bug, avoids these problems altogether, and so is naturally superior.

#### A.8.5. Choosing a processor

The first task was then to choose a suitable microprocessor, from the hundreds of types available. In order to do this, a quick estimate was made of the computing power required. Firstly, to meet the 5% distortion target, 8-bit precision would be ample. This then gives an idea of the number of points required per cycle; if the output can only take 256 ( $2^8$ ) possible values, then there is no point in sending out more than 256 points per quadrant of the sine wave.

Secondly, for each point, two 8-bit numbers are to be multiplied together. Unless the processor has a hardware multiplier (and only more complicated and powerful processors do) this is quite an intensive task; the number of instructions required is at least the square of the bit depth of the smaller of the two numbers. Therefore, each point will need at the very least 64 instructions; say 100.

So, given that there are 50 cycles per second, and 4 quadrants in each cycle, the processor needs to execute approximately:  $50 \times 4 \times 256 \times 100 = 5,120,000$  instructions per second.

Now, to estimate the amount of memory required: The LUT will contain around 256 values, each of which will consume one word of memory. Then, there are 100 instructions executed to produce one data point. (This is not strictly accurate; the program might consist of 10 instructions, looped 10 times. However, it is adequate

for a rough guess.) There will also be code for the phase-locked loop, and for reading in power commands. This is assumed to be 100 instructions or less; otherwise, it would not have time to execute once per zero-crossing. Finally, there will be perhaps another 200 instructions for setup and error-detection. Each instruction will also use one word, so giving a total of 656 words.

Therefore, a suitable microcontroller would have around 700 words of non-volatile memory, and an execution speed of about 5 million instructions per second (MIPS).

Arizona Microchip's PIC16F84-10 chip looked quite attractive, due to its simple reduced-instruction set computer (RISC) architecture, low price, and ease of use; it can be programmed using an ordinary PC and the very simple NOPPP ('No-Parts PIC Programmer'). However, while it had an ample 1,024 words of memory, its maximum speed was only 2.5 MIPS. This would be fast enough, though, if the precision were reduced to 7-bit, and 64 points used per quadrant instead of the 128 implied by the precision. This would still provide a good enough waveform to meet the distortion spec.

#### A.8.6. Firmware

The firmware program is listed at the end of this Appendix, and an explanation of the code is also given.

#### A.8.7. Support circuitry

The PIC does not quite do everything by itself. It requires a few supporting components; the circuit is shown in Fig. A.12. The quartz crystal is a standard part: the frequency of 9.8304 MHz may seem odd, in fact it was a convenient multiple of 50 Hz.

(50 cycles per second

\*2 half-cycles per cycle

\*128 D/A conversions per half cycle

\*192 instructions per conversion

\*4 clocks per instruction =9,830,400)



Also needed is a digital-to-analogue converter, which is formed by resistor network R5-R20, a classical R-2R ladder. R21, R22 allow the output voltage to be adjusted. R1-R4, Q1, and U5 multiplex the 8-bit parallel input down to 4 bits in order to save I/O pins. U6 is the microcontroller itself.

### ***A.9. Building and testing the Mark One***

This design evolved over a period of a few months. The various subsystems were tried out on breadboards in the lab, and once they seemed to be functioning happily in isolation, it was time to build a prototype and try out the whole system. The emphasis at this stage was not on perfect performance or error-free operation, but simply to provide a proof of concept. A printed-circuit board (PCB) was made and stuffed with components, and the various stages of the circuit were tested in isolation, before connecting everything together. Inevitably, a number of design flaws were discovered, and changes had to be made to the circuit.

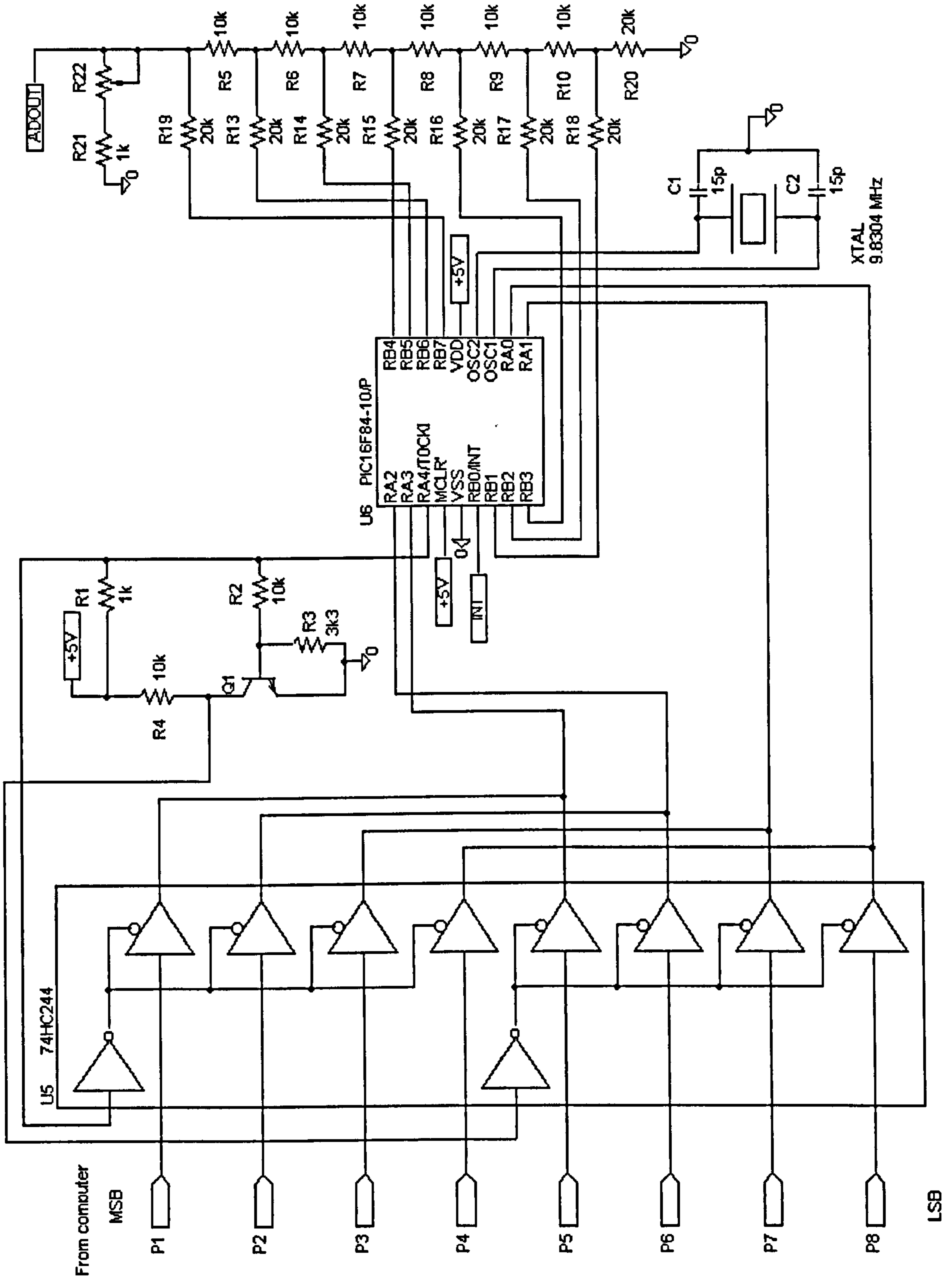

(Fig. A.12: Circuit of microcontroller and support components)



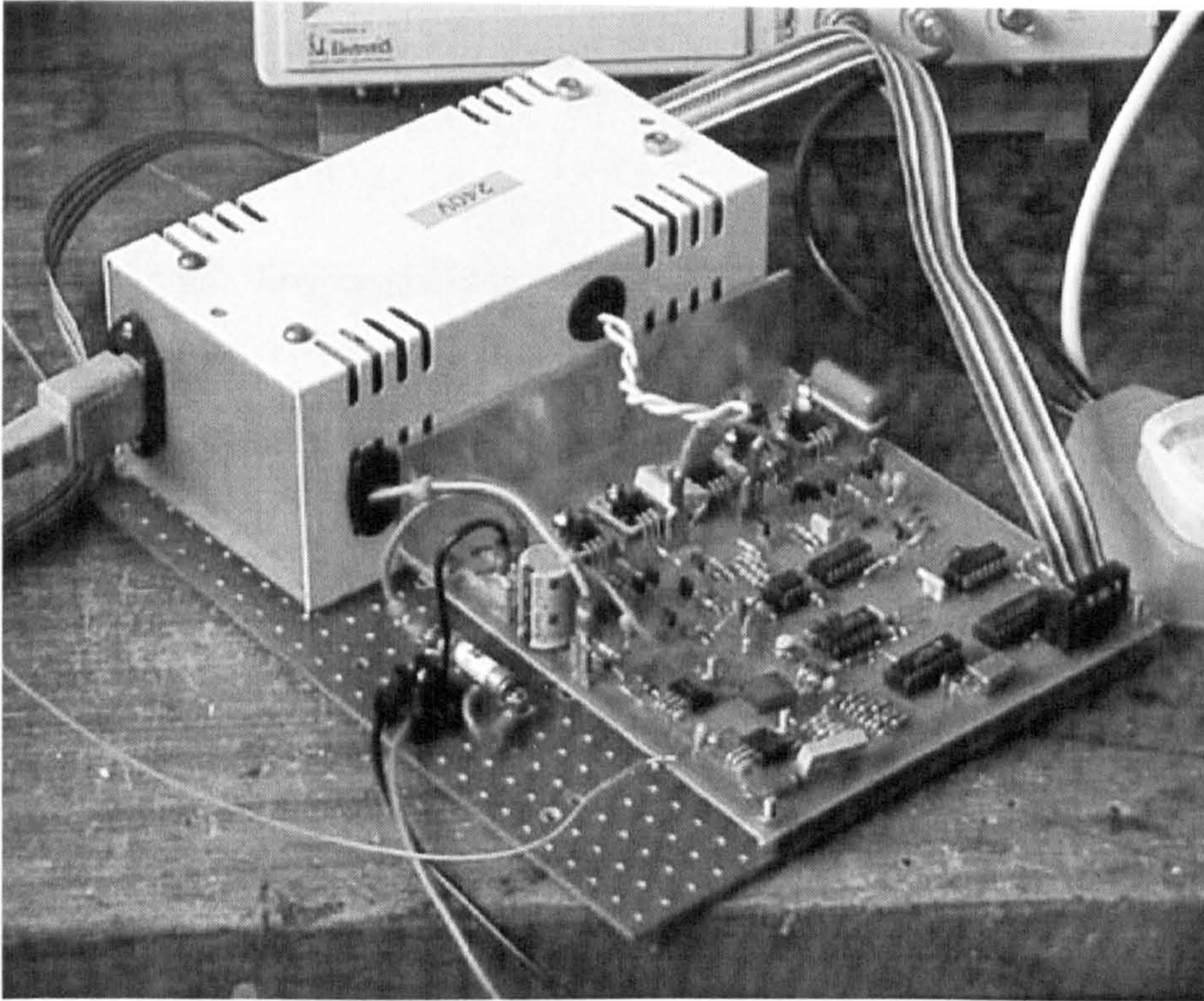

(Fig. A.13: Mark One inverter under test)

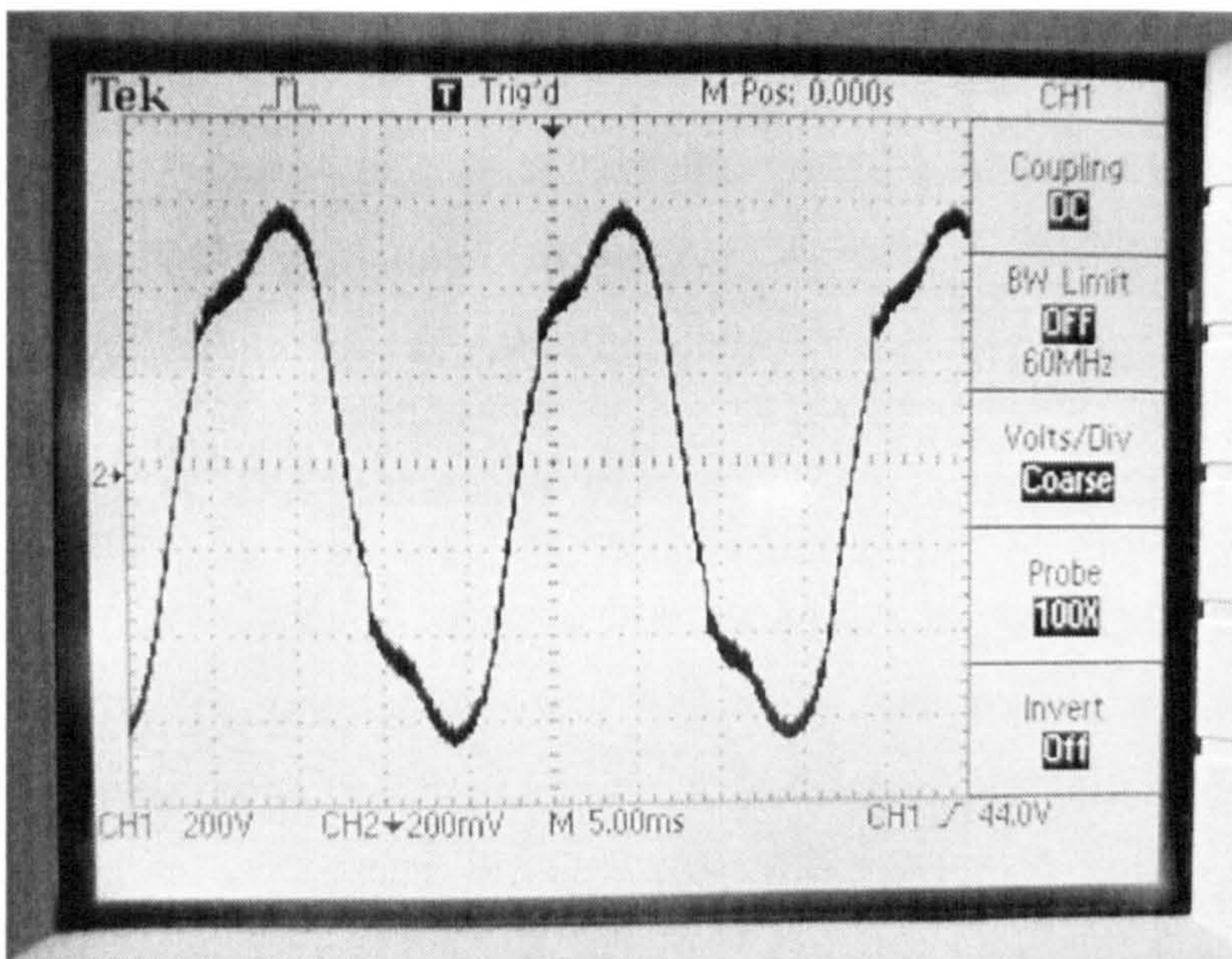

(Fig. A.14: Line current of Mark One operating at 100% output. Y Scale: 200mA/div)



## **A.10. Lessons learnt from Mark One**

### **A.10.1. Odd spikes**

The most puzzling anomaly in the Mark One's operation was a strange disturbance in the current waveform. When the switching devices change state, the rate of change of current is supposed to reverse. This it did, but accompanied by a very large transient (a 'spike') which disturbed the bang-bang control system quite severely. To allow proper operation, the spikes were reduced by low-pass filtering the current signal, but the true cause was discovered quite by accident.

If it is to work correctly, the inverter requires a filter inductance in series with the load. Quite a small inductor had been used, with the intention of using the leakage inductance of the transformer to help with the filtering. Unfortunately, the transformer winding also has capacitance to the core, which is earthed. In use, one end of the winding was connected directly to the unfiltered HF output, and the very high rate of change of voltage ( $dV/dt$ ) caused large transient currents to flow to earth via the winding-core capacitance. Swapping the leads around, so that the inductor was in series with the end of the winding having most capacitance to the core, reduced the problem considerably. A more permanent fix would be to use two inductors, one for each winding end.

### **A.10.2. Excessive losses**

The Mark One also suffered from excessive losses. It was only 85% efficient at rated output. No single component was really responsible; the losses were equally spread amongst the transformer windings, transistors, and current sense resistors.

### **A.10.3. Too much distortion**

Also, it did not meet the 5% distortion target. The source of the distortion turned out to be the transformer; a commercial unit designed with economy in mind. Discussions with a manufacturer of transformers revealed that it is common practice to design for a peak flux density of 1.5 Tesla, which is actually greater than the saturation point of the core material, 1.3 T. Therefore, the core saturates towards the



end of every cycle, reducing the inductance dramatically and causing spikes of magnetising current. A more conservative transformer design would be the obvious solution.

#### **A.10.4. Latch-up**

The final insult was that it occasionally suffered latch-up. This was a frustrating condition where once in a while all six MOSFETs would turn on simultaneously as soon as power was applied to the circuit. The result was a complete short-circuit across the DC bus, normally followed by some kind of small explosion. The root cause of this was that the MOSFET driver circuits were inverting, i.e. a HIGH input to the drive transistor base turns the MOSFET off. If the power to the driver circuits were to come up before the power to the logic circuits, then the drivers would start operating while all their inputs were still low. The solution would be to sequence the power supply rails so that the driver circuits were powered up last of all.

### **A.11. Mark Two**

The Mark One inverter had served its purpose as an experimental prototype. However, it was not powerful enough, and in any case had design flaws which would require serious revision. It seemed that the best course of action was to build another inverter.

With these shortcomings in mind, work began on the Mark Two. The most important goal for this was extra power; 600 watts instead of the Mark One's 100. Achieving this extra power while meeting the 90% efficiency target required some careful planning. The first step was to draw up a loss budget.

#### **A.11.1. Loss budget**

Up to 10% of the power can be lost. Now, due to the design of the inverter's output circuit, every component passes the same current. This is assumed to be 50 A (600W at 12V: the reason for using 12V will be discussed later) So, the maximum allowable circuit resistance is the value which will dissipate 10% of 600W, when passing 50A. From Ohm's law this is  $0.024\Omega$ .

Now, it is assumed that half of this resistance is in the transformer primary and secondary lumped together. So, all the other parts must come in at under  $0.012\Omega$ .

### A.11.2. Transistors

'UltraFets' made by Intersil were prime candidates. They are inexpensive devices with a very low on-state resistance; only  $0.006\Omega$ . Four were used in parallel in each switching position; a total of 24 devices. Since the current flows through two sets of switches in series, the total resistance will be  $0.003\Omega$ .

### A.11.3. Current sense resistor

A commonly-available 30A 75mV meter shunt was chosen. This has a resistance of  $0.0025\Omega$ .

### A.11.4. Wiring

The power connections were specified as copper sheet 2mm thick by 12mm wide. The total length is about 150mm. The resistance of this is  $0.0001\Omega$ : small enough to ignore altogether. (The inductance was not- but that is another story)

### A.11.5. Transformer

Bearing in mind the requirement for a 'clean' magnetising current, a custom transformer had to be constructed. An off-the-shelf 625VA toroidal transformer, with 230V primary and two 40V secondaries, and 5% volt-drop at full load (regulation) was chosen as a base.

First of all, the magnetising current was measured. Although the mains voltage was near 250V on the day of the experiment, the current was very low; less than 30mA RMS. It would have been difficult to measure with more accuracy because the switch-on surge would have destroyed a sensitive meter. The transformer was also silent in operation with no buzzing. In any case, if the magnetising current had been higher, the transformer could have been modified by adding extra primary turns.

Next, 10 turns of wire were placed on it and the voltage on this winding measured; 4.99V. Thus, each turn gives 0.5V.



But, what voltage should the new winding be? The inverter will malfunction if the DC terminal voltage ever drops below the peak AC voltage. Now, the DC voltage is nominally 24. But, being supplied from a lead-acid battery, it could drop as low as 20. So, the peak AC should be a little less than  $\frac{20}{\sqrt{2}} = 14\text{V}$ . Leaving a little more room for the inverter's internal 10% voltage drop (design efficiency is 90%) the result is around 12V, therefore 24 turns.

Next, calculate the thickness of secondary conductor required. Assume that the 5% volt drop is shared equally between the primary and secondary, so that the volt drop in the new secondary should be 2.5%. It is also known that at full power, the current in the secondary will be nearly 50 A. So, it is possible to calculate the resistance of the secondary that will drop 2.5% of 12V= 300mV when passing 50 A. It is 0.006Ω.

Next, knowing the core dimensions, the length of one turn can be calculated; 0.18m. Therefore, 23 turns will use 4.14m of wire. The resistivity of copper is  $1.72 \times 10^{-8} \Omega\text{-m}$ ; so if it is to have a resistance of 6 mΩ, a conductor of this length must have a cross-section of  $1.19 \times 10^{-6} \text{ m}^2$ , or 12 mm<sup>2</sup>. A single copper wire of this size would be very difficult to handle, so a number of smaller wires in parallel is preferable. 2mm diameter wire is easily available, and using four strands of this gives a cross-section of 12.6 mm<sup>2</sup>. However, there appeared to be plenty of room on the core and so it should be possible to be conservative, and use five.

So, the existing secondaries were unwound, and replaced with five 24-turn windings of enamelled copper wire, 2mm diameter, connected in parallel.

### A.11.6. Filter components

Say that the switching frequency is not to exceed 30 kHz. Now, it was observed from the ATP simulation, and experiment with the Mark One, that the highest switching frequency occurred when the instantaneous line voltage was about half its peak value: that is, 12V.

$$\frac{di}{dt} = \frac{V}{L} = \frac{12}{L}$$

(Eq. A.7)

Now say the system is running at a hysteresis of 5% of the peak current; 3.5A. One half switching cycle can then be calculated as the time taken for the current to change by 3.5A.

So,

$$\int_0^{\tau} \frac{di}{dt} dt = 3.5$$

(Eq. A.8)

Substituting 12/L for di/dt (Eq. A.7) and performing the integration:

$$\frac{12\tau}{L} = 3.5$$

(Eq. A.9)

thus  $t=0.29L$ , and  $f=1/2t=1.72/L$

so to have 30kHz,  $L=1.72/30000=57 \mu\text{H}$

So, the requirement is for two 30  $\mu\text{H}$  inductors to handle 71A without saturating. Also, their combined DC resistance must not exceed 0.006  $\Omega$ . The options were somewhat limited; it was necessary to use off-the-shelf cores because having custom magnetic assemblies made would be too expensive and time-consuming. The largest ferrite available was Ferroxcube's ETD39, and for each inductor, two of these core assemblies were stacked to double the core area. These were wound with a 5-turn coil made of 5mm dia. copper pipe with 0.7mm wall thickness, and assembled with an 0.8mm (approx.) airgap between core halves.



With these coils, the switching was somewhat faster than ideal: 70-100kHz. This suggested that the inductance was too small. However, since the inverter did not seem to be suffering from excessive switching losses, and larger inductors would have been a major problem, requiring custom-made ferrite assemblies, it was decided to use them anyway.

### ***A.12. Assembly and snagging***

Most of the circuitry was put on a PCB, which was a modified version of the board used in the Mark One. There were three main revisions. First was an extra negative supply (generated by a small DC-DC converter) for the current sense amplifier. This removed the rail-to-rail requirement, so allowing a wider choice of op-amps. Second was a transistor switch allowing the microcontroller to disable all the MOSFET drivers at once, so curing the latch-up problem, and allowing the inverter to be totally shut down. Third was a great enlargement of the power circuit, with 24 MOSFETs instead of the original six. In fact, the power circuitry could not be put directly on the PCB, because the copper was not thick enough to carry the current. So, the board was used only for mechanical support, and the current was carried by brass and copper bus strips joined together by nuts and bolts. Considerable thought was put towards laying out the power circuitry, to give the shortest current paths and smallest current loops possible, and hence minimum resistance and inductance. The drain leads on the MOSFETs were not used, contact being made through the metal tab of the package instead. This gave a lower-impedance electrical contact, and also better thermal contact.

The latter was not of great significance, though, because the transistors were not expected to dissipate very much power in this high-efficiency design. In fact, there were no actual heatsinks as such; the brass connecting strips that carried the transistors were just made a little larger and thicker than electrically necessary, to help in carrying the heat away. (See Fig. A.17) This design decision proved to be reasonable, with transistor case temperatures not exceeding 60 °C, in a 20 °C ambient without forced air cooling. Unfortunately, the current shunt ran rather hotter than this, since it was wedged underneath the circuit board and overloaded beyond its

design rating. This problem was mitigated by raising the circuit board up so that air from the cooling fan could circulate underneath it.

The main circuit board, transformer, and an extra board (containing mains relay, EMI filter, and parts of the zero-crossing detector) were mounted to an aluminium baseplate. This was installed in a casing that had once housed a variable-speed motor drive, as shown in Fig. A.17. The cooling fins, while they look the part, do not actually do anything; cooling is by forced air, sucked in through the fan, and exiting through a grill on the opposite side of the case (not visible in figure). Two high breaking capacity (HBC) fuses were also fitted, one 32 amp in the DC circuit, and one 63 amp in the low-voltage AC circuit.

The inverter was tested in this state. The original electrolytic capacitors used for decoupling were found to be inadequate straight away; they were overheating and there was excessive DC bus ripple, enough to cause the circuit to malfunction. They were augmented by six pulse-rated plastic film capacitors in parallel (each  $1\mu\text{F}$ , 63V) and all the decoupling capacitors were relocated onto two copper strips right at the DC input terminals, instead of being on the PCB as before. This cured the ripple problem. The electrolytics still heated up, but not excessively. Fig A.16 shows the decoupling arrangement.

Later, additional circuitry was added; a controller for the cooling fan so that it only started when the inverter was running, and an undervoltage trip for the DC bus. The reason for using an undervoltage trip was that if the DC bus voltage fell too low, the inverter would act as a rectifier instead (due to body-drain diodes in the MOSFETs) and start to backfeed the DC side from the AC side. This might cause unexpected behaviour of the circuit and possible damage. The undervoltage trip made sure that the inverter would be completely shut down in a safe manner before the DC voltage could fall to a potentially dangerous level.



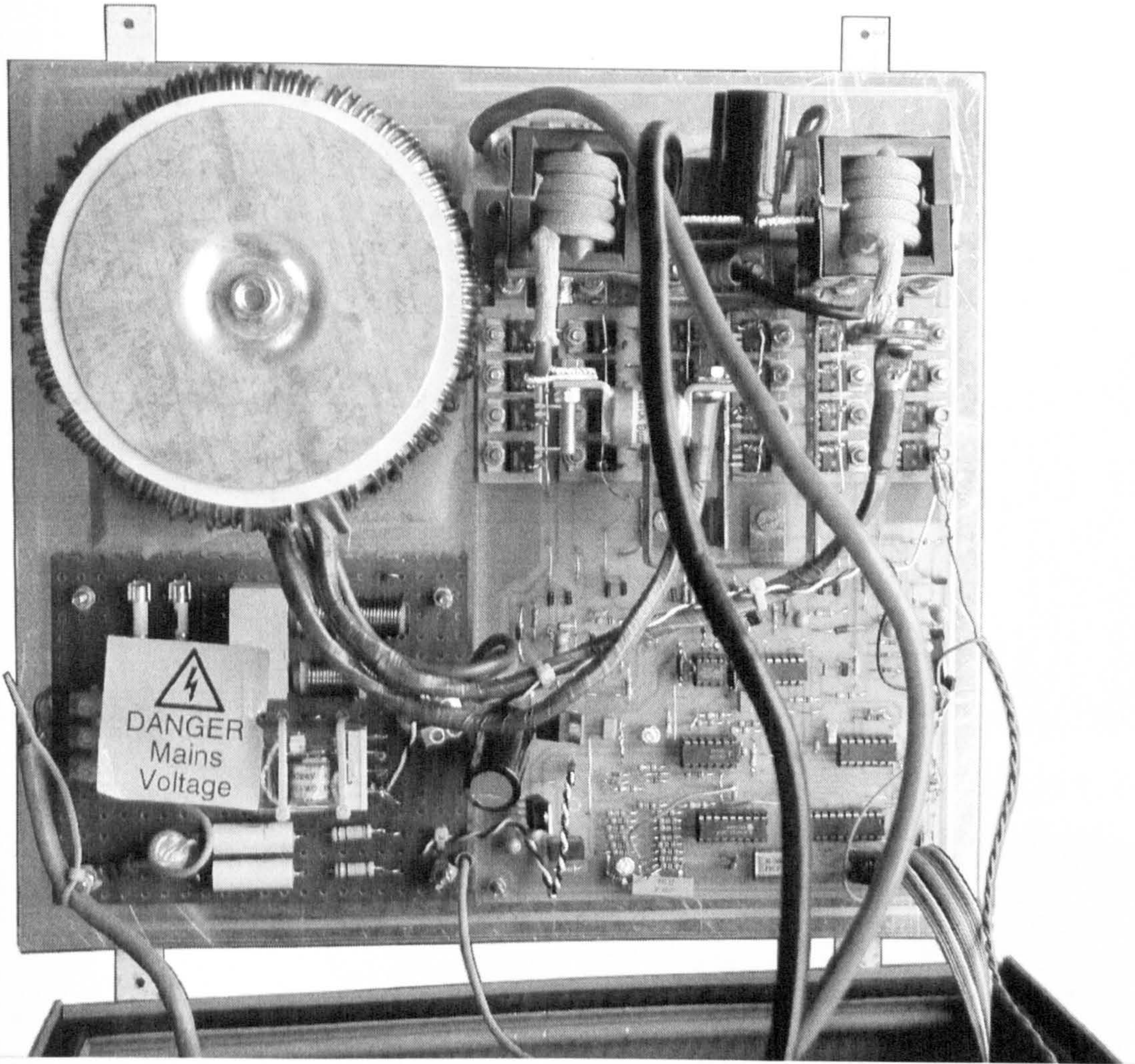

(Fig. A.15: Internal view of Mark Two inverter. Overall size approx. 250 x 300mm)



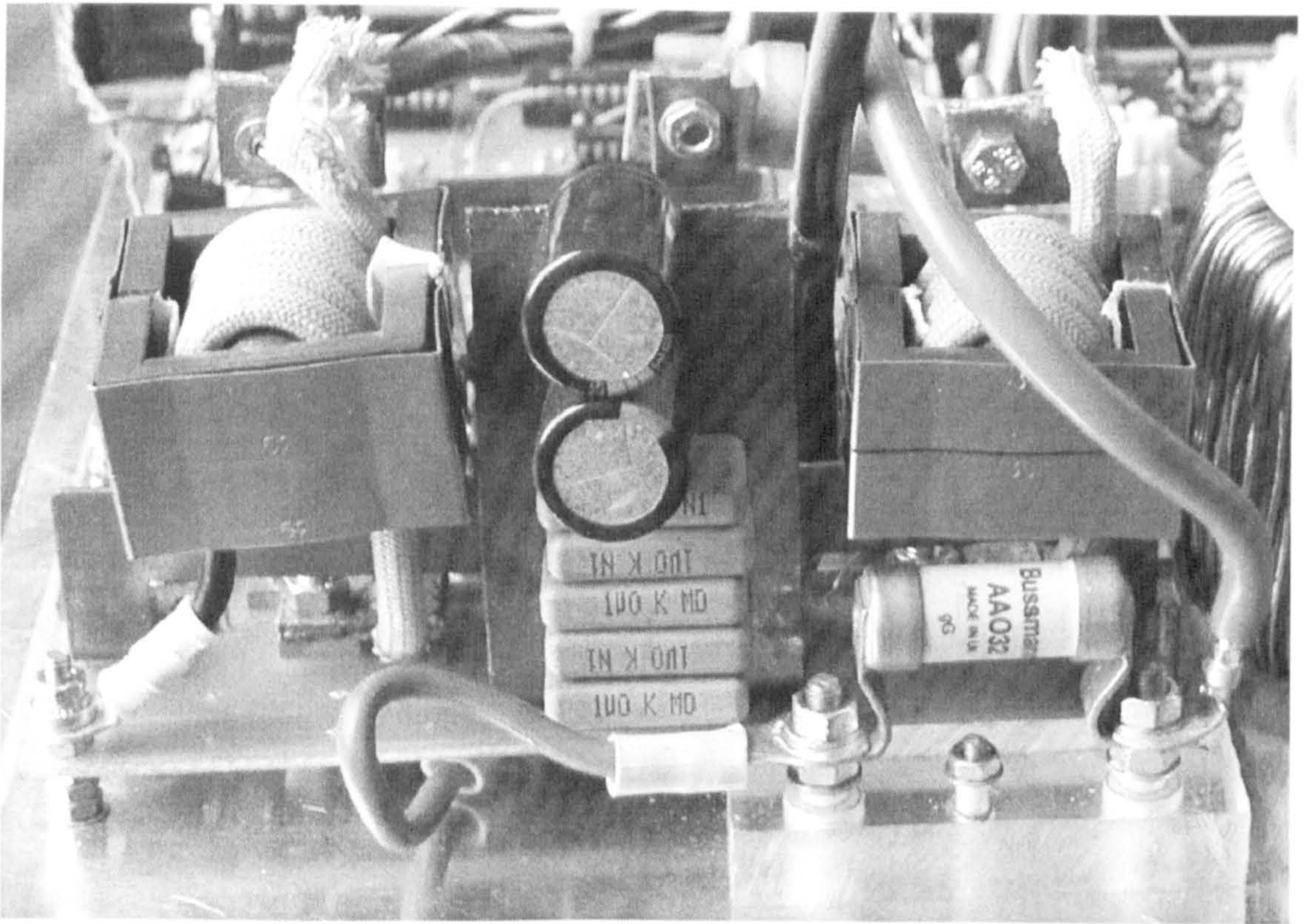

(Fig. A.16: Filter chokes and DC bus decoupling capacitors)

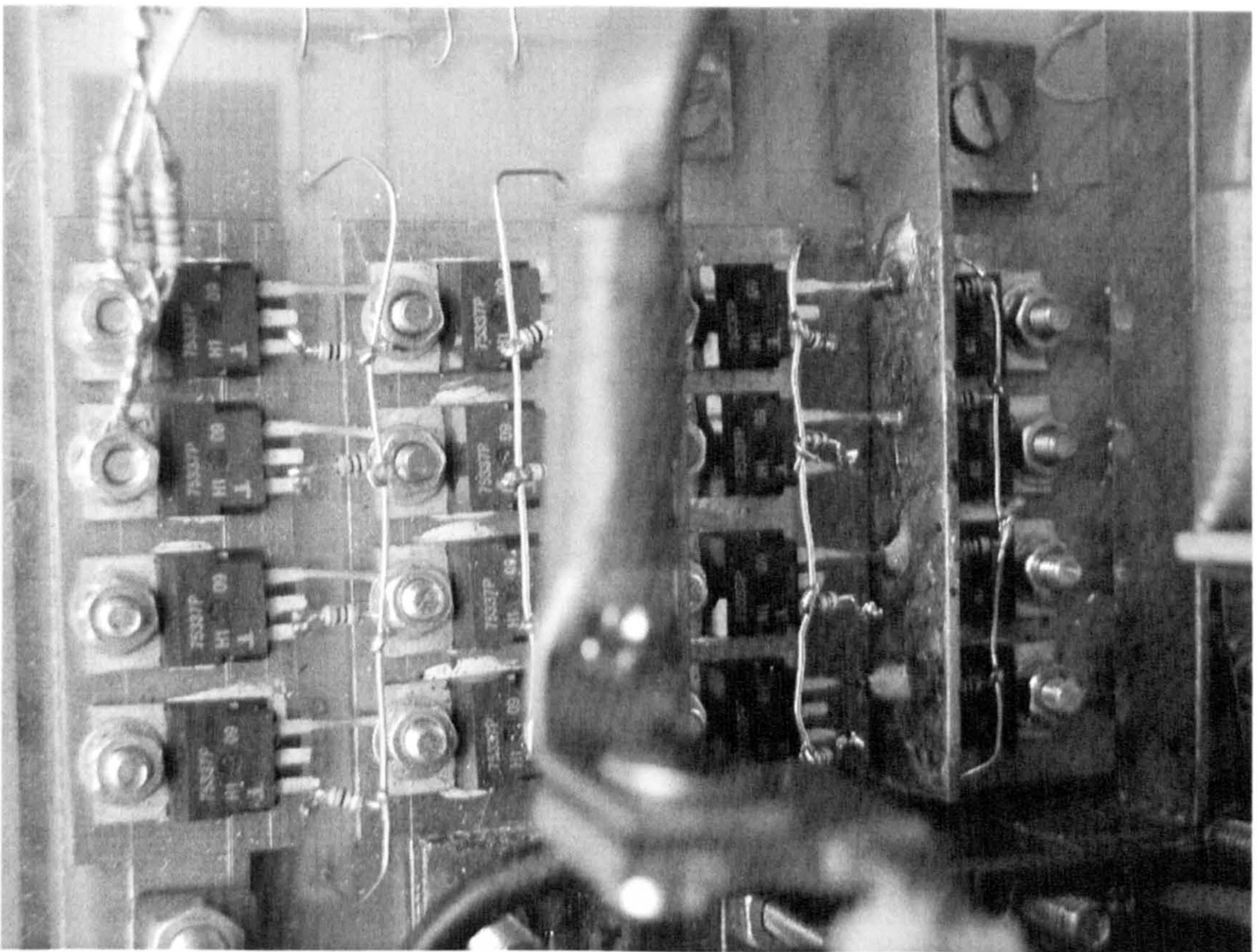

(Fig. A.17: Detail of power circuit showing transistors and busbars)



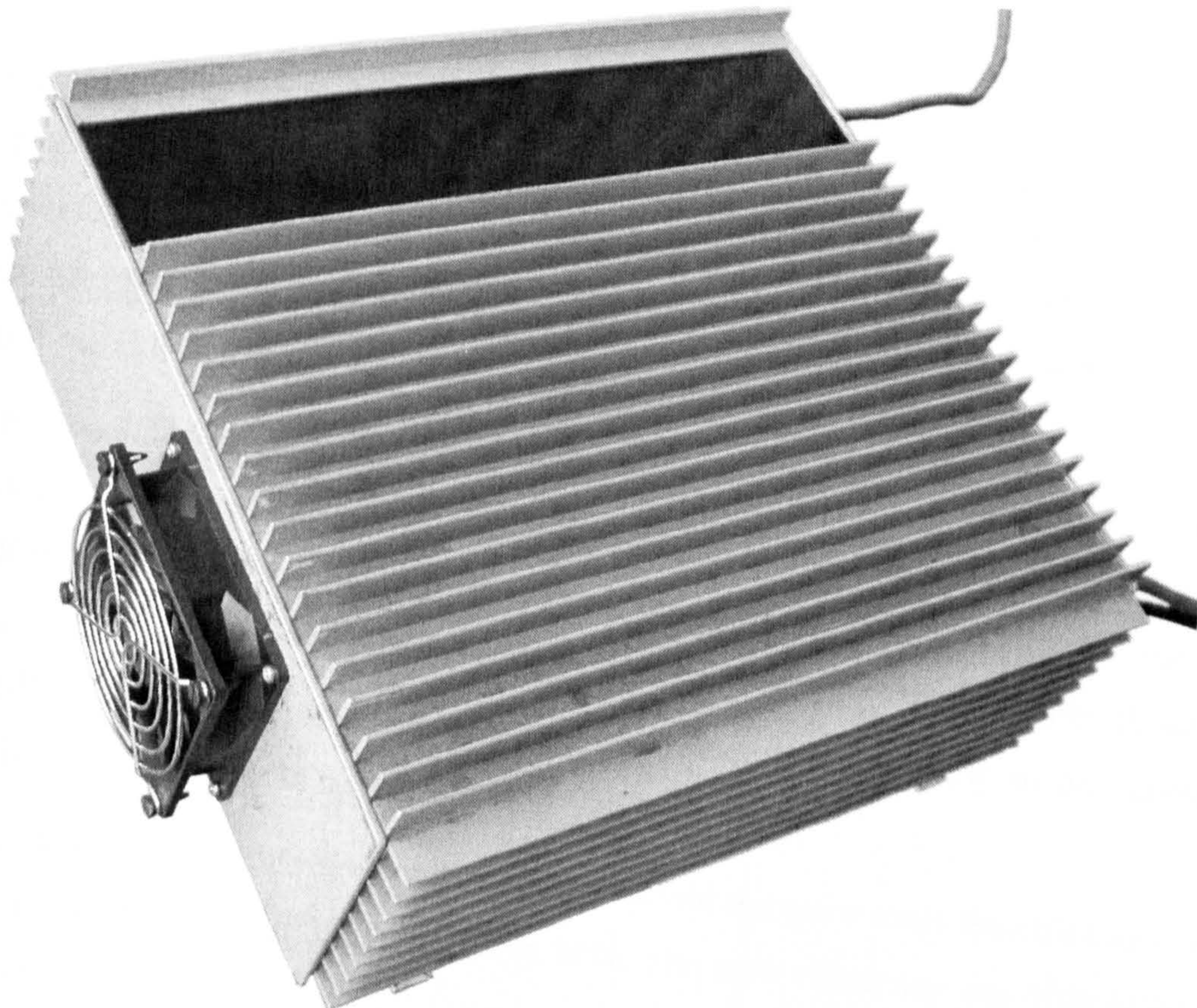

**(Fig. A.18: Mark Two inverter assembled)**



### **A.13. Testing the Mark 2**

Once the unit seemed to be operating satisfactorily, it was time to conduct some tests. First and most important was the efficiency/power control test. For this, the inverter was powered from a series pair of 12V lead-acid batteries, with facilities for measuring DC voltage and current draw. The AC output was fed back to the local grid via a digital power meter (made by Elcontrol, Italy: type VIPD)

The results were not terribly encouraging. It was immediately obvious that the inverter could not meet its rated power spec: although it had been designed for 600W, it proved impossible to get any more than 570W out of it, and this accompanied by some very sinister crackling noises coming from the filter chokes. A 550W limit was set on subsequent tests, to reduce the possibility of any damage, until the problem could be found.

As tests continued it became obvious that it would not quite meet the efficiency spec either: the efficiency at 550W was only 86%. The peak efficiency was 90% at 260W output.

Harmonic distortion of the AC line current was somewhat higher than spec. too, with a measured 5.8% at 550W.

There was also a non-linearity of power with power control. The power began to compress at higher levels, and it seemed likely that this was related to the inability to meet rated power.

Finally, to add insult to injury, the power output was not stable with time, varying by around 15W (3% of the rated power) at full power. It seemed likely that this was a thermal effect, probably heating of the current shunt, which could be expected to heat up since it was operated at high current in a confined space, and being made of copper would have a considerable tempco. of resistance. This would explain the compression issue, too. Note: a retest of the inverter one year later (see Section 9.4) found that this power instability effect was no longer present. Therefore, there are grounds for suspecting that the true cause was not heating.



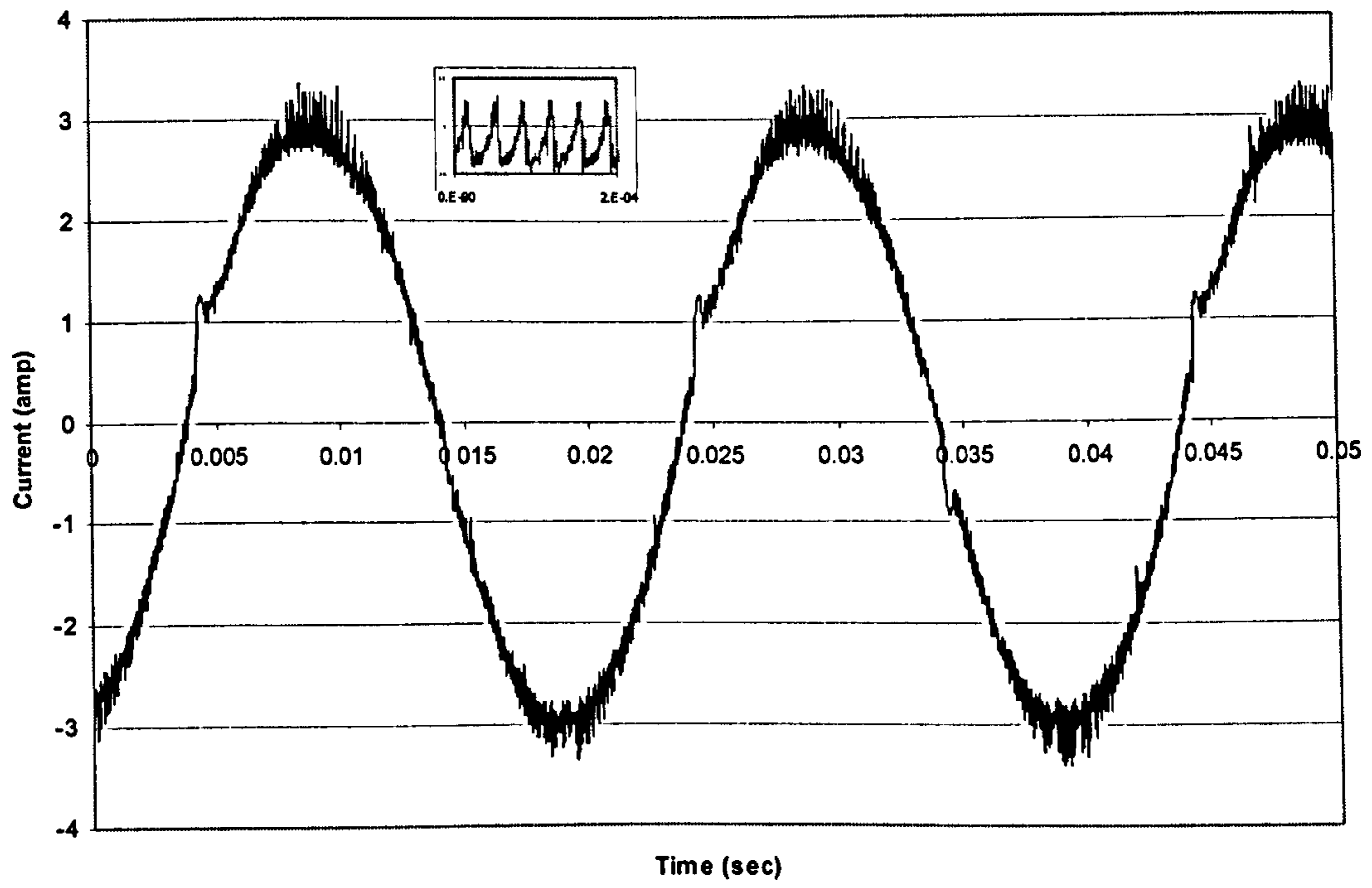

**(Fig. A.19: Mark Two inverter line current at 550W output. Inset shows waveform at current peak, magnified to show 200 us)**

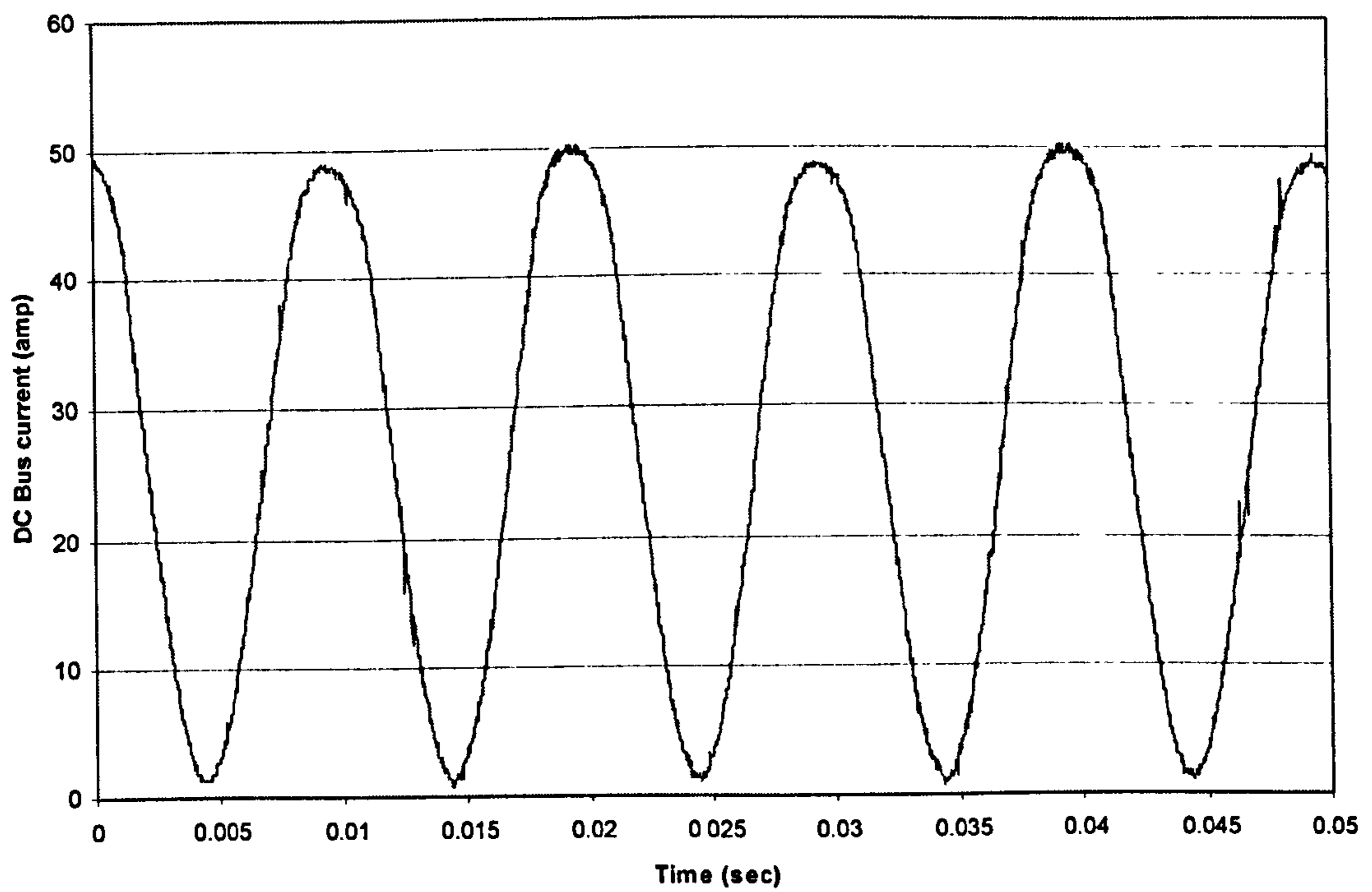

**(Fig. A.20: Mark Two inverter DC input current, also at 550W output)**



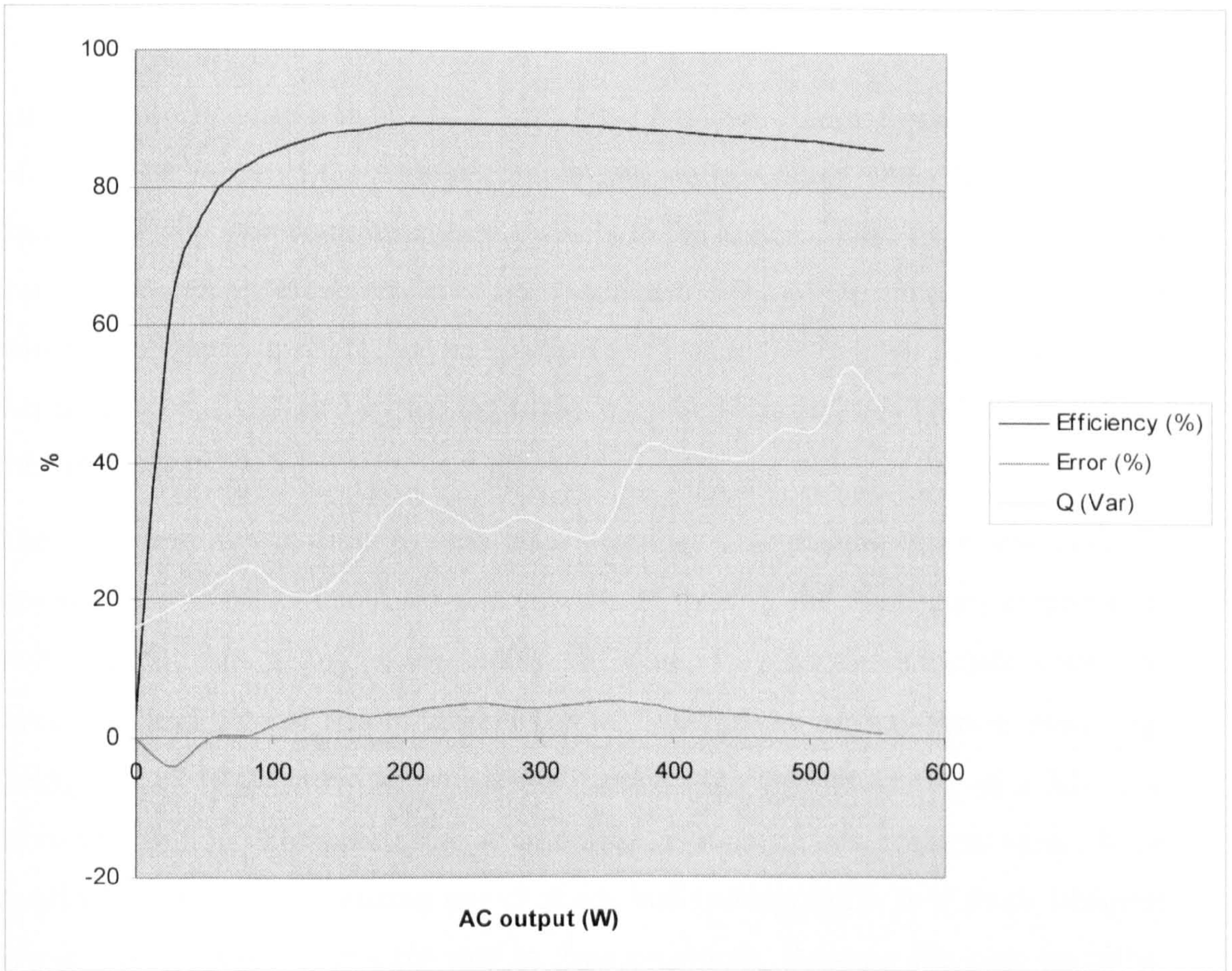

(Fig. A.21: Mark Two efficiency/reactive power/control error)



#### ***A.14. Lessons learnt from the Mark 2***

The lack of efficiency was the most intractable problem. Again, from an examination of the temperatures of the various components while running under load, it seemed that no one part was contributing excessively to the losses. There were probably two main causes: an underestimation of resistance across the whole circuit, by not taking into account the skin effect, and an ignorance of iron losses in the transformer, which would also be aggravated by the high-frequency currents and any DC component in the output.

The premature power limiting was also puzzling. Considerable time was spent in investigation of this, without any real success. In the end, the most likely explanation was transient dips in the power supply rail, caused by circuit inductances and the extremely high rate of rise of current (up to 700A/ $\mu$ s) in the rail during switching. Transients of 10-20 volts were observed, across only the inductance of a 80mm x 15mm x 2mm thick copper strip. A complete solution of this problem would have required scrapping the existing power stage, and redesigning it to a more compact layout, which was not feasible due to time pressures. Derating the unit to 550W proved to be an acceptable workaround.

The excessive THD was probably a result of too large a hysteresis band, coupled with inadequate low-pass filtering of the output.

So, in conclusion, the Mark Two inverter almost met the specification, but not quite. Considerable time and effort were devoted to improving the performance, but in the end, the above figures represented the best possible without a redesign. There was no time to embark on a Mark Three, and so the Mark Two unit was the only hope. It should be borne in mind that the original goals represented the standard obtained by the very best commercial inverters. Even though it did not meet the spec., the Mark Two still outperformed many units currently on the market. Also, the only shortfall which actually affected standards compliance was the distortion. This only required marginal improvement, which could easily be done by adding an off-the-shelf EMI filter, for instance. Therefore, it was still quite acceptable for experimental use.

### **A.15. Protection**

Once the basic operation of the inverter had been proved, it was time to consider a protection system. The specification has already been quoted, and is quite clear on all points, except for “loss of mains protection”. This seems to be an additional category apart from voltage and frequency limits. Since the G77 spec was written, this has been defined more clearly in the American standard IEEE P929 [2]. It is now formally known as “anti-islanding protection”.

Islanding is the condition where a network containing embedded generation, and demand, comes disconnected from the rest of the grid. because of a blown fuse or tripped breaker, and continues to function on its own, with the embedded generation supplying the local demand. The implications of this have been discussed in previous chapters; it is assumed for the present discussion, as the electricity authorities do, that it is an undesirable condition and must be prevented. The first line of defence is to have over/undervoltage and frequency trips, which work because inverters (and ours will be no exception) look to the grid to determine the voltage and frequency. If the grid is cut off, the inverter will lose its timing, and the frequency will go wrong. And, if the load does not match the inverter output, the voltage will go wrong too. Either case will result in a trip. Unfortunately, there are conceivable situations where the load does indeed match the inverter output. (The REDMan system is one example) Worse, there are combinations of inductive and capacitive loads which will resonate at the line frequency. This is fairly common, in fact, because power factor correction works in exactly this way. If an inverter is islanded while supplying a load that matches its output, with a strong enough resonance at 50 Hz, the voltage and frequency will stay within limits, and it will keep on going.

It was to address this situation that dedicated anti-islanding protection was invented. One popular anti-islanding algorithm, SFS/SVS [6], is available in the public domain. It functions by deliberately introducing instability; if the voltage departs suddenly from its mean value, the inverter is caused to change its power output, in such a way as would amplify the disturbance. A similar algorithm is used for frequency; the inverter tries to change its own output frequency to amplify any deviations in grid frequency. The thinking behind this approach is that the inverter is



basically made to behave like a hooligan and fight the grid instead of working with it. Because the grid is bigger, it always wins. But as soon as an island develops, the inverter wins; the voltage and frequency go wildly out, and the voltage/frequency trips shut the inverter down.

Of course, this approach assumes that inverters have an insignificant effect on the grid. Therefore it is doomed to become a victim of its own success. If enough inverters with SFS/SVS were installed in an area where the grid was weak, they would actually be able to out-fight it, with tragi-comic consequences. Aggressive anti-islanding protection like this can never be a part of any plan for significant penetration of embedded generation.

So what protection scheme was opted for? Considering the situation, as discussed here and in previous chapters, it seemed that the only pressing need was for a rudimentary loss-of-mains detection. The microcontroller chosen limited the options rather, because there were no I/O pins left, and no onboard analogue/digital converter, so fitting an AC over/undervoltage trip would have been a very fiddly business. Eventually, the method settled on was a sensitive over/underfrequency trip (this was a firmware job and needed no hardware mods) which resulted in instant loss-of-mains tripping in every scenario tested.

### ***A.16. Notes on firmware***

The firmware has three major jobs to do: locking to the mains frequency, scaling the output according to the power command, and measuring the frequency for protection purposes. The frequency measuring and locking is the most complicated part. It is based around an interrupt which is triggered at every zero-crossing of the mains voltage. (The interrupt pin is normally edge-sensitive, and a programming trick is used to make it sensitive to both positive and negative edges.) Another interrupt is triggered by the onboard timer, and causes a D/A conversion to happen. The frequency of this interrupt is nominally every 192 instruction cycles, but it can be changed by programming different values into the timer. This is what the frequency locking routine does; it tries to adjust the timer value so that 128 timer interrupts happen in the space of one zero-crossing interrupt. In order to get finer frequency

resolution, the timer value is dithered by adding one to it on the first 'n' interrupts in every cycle of 128. ( $0 \leq n < 128$ )

The frequency measuring works by keeping an eye on 'n' and the timer value, which (assuming the frequency locking is working) form a 13-bit number inversely proportional to the mains frequency. This is compared to high and low limits, and a violation counter is incremented every time the limits are broken. This counter is slowly decremented all the time, so that in normal use it will not reach the threshold. But if the rate of violations becomes excessive, the threshold will be broken. This causes the inverter to shut down immediately. Shortage of I/O pins mandated some dirty tricks here. The same pin that drives the input multiplexer is used for shutdown: the multiplexer only needs narrow pulses to operate it and the shutdown circuit is deliberately made too slow to respond to these. Undervoltage on the DC bus (which is potentially catastrophic) also causes a shutdown. The undervoltage detector circuit connects to a pin that is normally the LSB of the D/A converter. A series resistor is used so that in normal operation the PIC pin overdrives the detector output, and the D/A works properly. The pin is briefly reconfigured as an input at every zero crossing to sample the detector.

Scaling is done by a software multiplying routine, because the PIC used has no hardware multiplier. This uses well-known arithmetic techniques to multiply two unsigned 8-bit numbers together, taking about 77 instruction cycles to do so (which leaves about 115 instructions per conversion for everything else) The least significant 9 bits of the result are discarded in this application.



### A.17. Flowchart

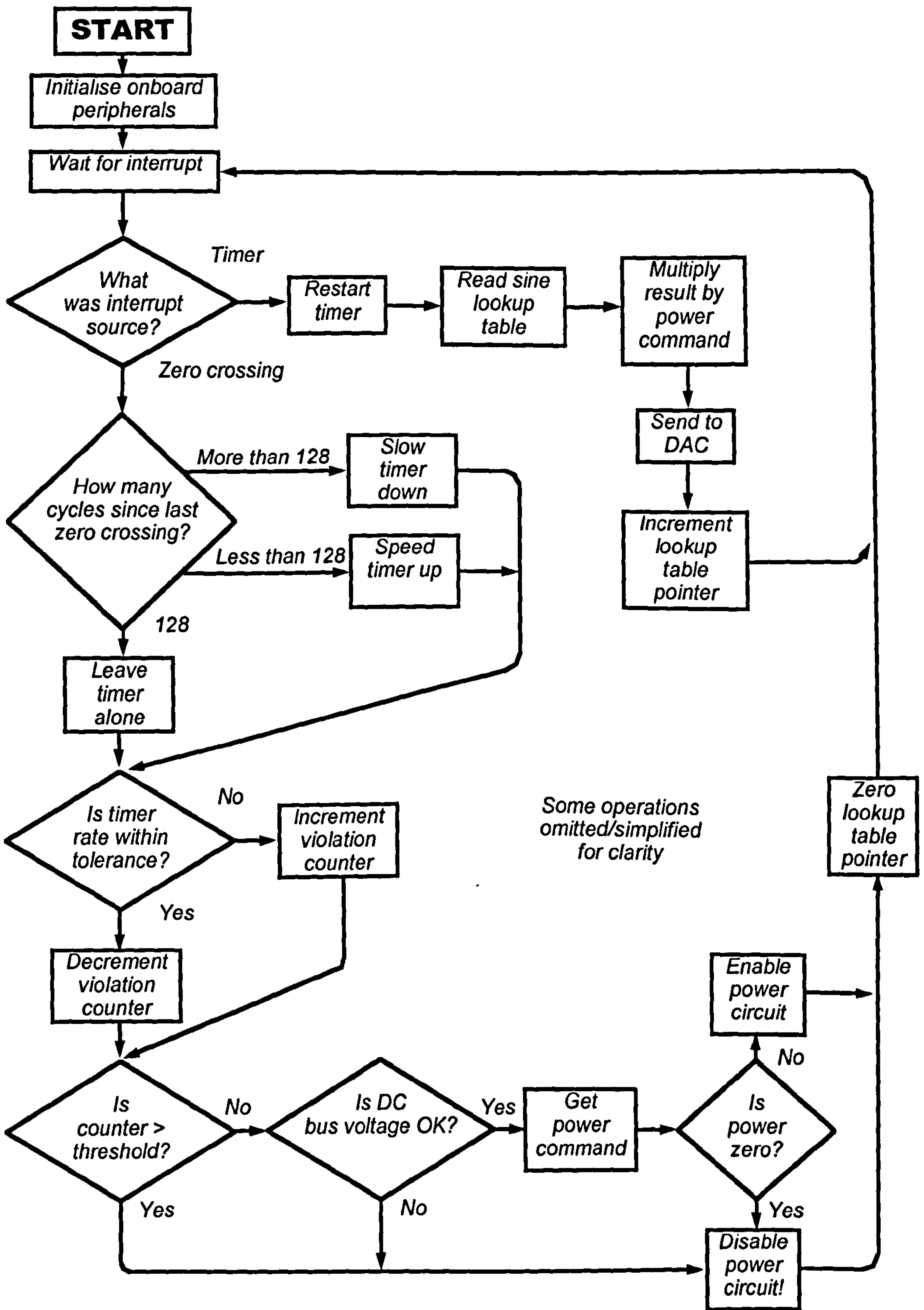

## A.18. Listing

This program may also be downloaded from the ESRU website at <http://www.esru.strath.ac.uk/>

```
*****
; GRID INTERTIED INVERTER FIRMWARE
; VERSION 3.03
; WITH PROTECTION
*****
; STRICTLY (C) 2000-1 STEPHEN J.CONNER ESQ BENG
; SO HANDS OFF
*****
; HI-RES VERSION
; INTENDED FOR PIC16(C|F)84(A)-10
; WITH 9.8304 MHz CRYSTAL
*****

*****
; ASSEMBLER SETUP
*****

; What kind of processor are we using
LIST P=16F84

; include file gives names to special function registers
#include "P16F84.INC"

; processor config flags -
; watchdog on, code protection off, xtal oscillator, etc
__CONFIG _WDT_ON & _HS_OSC & _PWRTE_ON
__IDLOCS H'1234'

; code origins
#define LUTBASE 0x300 ; lookup table base address
#define RESVEC 0x00 ; power-on reset vector
#define INTVEC 0x04 ; vector for one and only interrupt
#define LUTPCH (LUTBASE/D'256') ; high bits to poke to PC

; Magic numbers
#define FCY D'100' ; mains frequency Hz
#define FTOL D'3' ; mains freq tolerance (in 128ths of a cycle)
#define FOSC D'9830400' ; crystal frequency Hz
#define SPC D'128' ; wave steps per cycle
#define CPS ((FOSC/4)/(FCY*SPC)) ; clocks per wave step
#define LAT D'18' ; total timer interrupt latency
#define MAXLEN D'104' ; maximum number of instructions in a step
#define ISAT (SPC+D'14') ; index saturation value
#define TMR (D'256'-(CPS-LAT)) ; initial preload for timer allowing for
latencies
#define TMAX (D'256'-(MAXLEN+LAT+D'10')) ; the absolute max timer setting
#define TREF (D'128'+(MAXLEN/2)) ; the timer reference point to aim for
#define THI (TMR+FTOL) ; upper and lower tolerance bands
#define TLO (TMR-FTOL)
#define TARGET (SPC-1) ; the target step index value
#define CTR D'255' ; number of cycles to elapse before run
#define CTS D'10' ; number of frequency violation cycles before shutdown

; Protection states
#define SYNCING 1 ; in process of locking to grid
#define READY 2 ; locked and ready to start power stage
#define RUNNING 3 ; power stage started
#define TRIPPED 4 ; tripped out
#define ASLEEP 5 ; shut off due to being idle for a while

; Working registers
power equ 0x0c ; Throttle setting (output power control)
index equ 0x0d ; current index into lookup table
H_byte equ 0x0e ; multiplier working regs
```



```

L_byte equ 0x0f ; as above
mulplr equ 0x10 ; working reg for multiplier
count equ 0x11 ; multiplier loop count
timer equ 0x12 ; what the timer value should be based on...
errc equ 0x13 ; phase lock coarse error
errf equ 0x14 ; phase lock fine error
tmrtmp equ 0x15 ; timer saved value
wtemp equ 0x16
stemp equ 0x17
run equ 0x18 ; ready to go when run=0
pstat equ 0x19 ; protection status
fvi equ 0x1A ; frequency violation counter
cyc equ 0x1B ; cycle counter

;*****
; LOOKUP TABLE
;*****
;
; contains a half cycle of rectified sine wave
; note: the dt statement generates a retlw instruction for each data item
; note: there is extra dummy data at the end
org LUTBASE
table addwf PCL,F ; jump to the right place in the table
dt .6,.13,.19,.25,.31,.37,.44,.50,.56,.62,.68,.74,.80,.86,.92
dt
.98,.103,.109,.115,.120,.126,.131,.136,.142,.147,.152,.157,.162,.167,.171,.176
dt
.180,.185,.189,.193,.197,.201,.205,.208,.212,.215,.219,.222,.225,.228,.231,.23
3
dt
.236,.238,.240,.242,.244,.246,.247,.249,.250,.251,.252,.253,.254,.254,.255,.25
5
dt
.255,.255,.255,.254,.254,.253,.252,.251,.250,.249,.247,.246,.244,.242,.240,.23
8
dt
.236,.233,.231,.228,.225,.222,.219,.215,.212,.208,.205,.201,.197,.193,.189,.18
5
dt
.180,.176,.171,.167,.162,.157,.152,.147,.142,.136,.131,.126,.120,.115,.109,.10
3
dt .98,.92,.86,.80,.74,.68,.62,.56,.50,.44,.37,.31,.25,.19,.13,.6,.0
dt
.128,.128,.128,.128,.128,.128,.128,.128,.128,.128,.128,.128,.128,.128,.12
8

;*****
; RESET VECTOR
;*****
org RESVEC

; interrupts off until we are all set up
bcf INTCON,GIE
goto init

;*****
; DO-IT-ALL HANDLER
;*****
org INTVEC

; interrupts are stopped automatically when entering handler
; find out where the interrupt came from
; zero crossings get priority
btfsc INTCON,INTF ; if a zero crossing interrupt
goto zero
btfsc INTCON,TOIF ; if a timer interrupt
goto wave

; if a cosmic ray hits the interrupt circuitry...
; we should cater for the possibility
retfie

;*****
; zero crossing interrupt service routine

```

```

; uses a simple digital PLL to keep locked into the 50Hz
; and reads the throttle setting
; protection also dealt with here
;*****
;
; deal with the timer ASAP
zero   movf    TMRO,W           ; get the current timer
        movwf  tmrtmp
        movf   errc,W           ; and restart it
        movwf  TMRO

; coarse lock
; this adjusts timer speed until we get the correct number of steps per cycle
        movf   index,W
        bcf    STATUS,C
        sublw  TARGET           ; (target-index)
        btfsc  STATUS,Z         ; if the index is exactly target, Z=1
        goto   fine             ; do fine lock
        btfss  STATUS,C         ; if the index is greater than target, C=0
        goto   toohi           ; execute 'too high'

; too low (executes if none of above conditions true)
        incf   errc,F           ; increment error
        goto   fprot           ; and skip over fine lock

; too high
toohi  decf   errc,F           ; decrement error
        goto   fprot           ; and skip over fine lock

; once the coarse lock has worked -the fine lock is brought into play
; TREF is subtracted from the measured TMRO value. If TREF > TMRO, i.e.
; TREF-TMRO > 0, then the timer needs to be faster, so we increment the error
; register. Otherwise we decrement it
fine   movf   tmrtmp,W
        bcf    STATUS,C
        sublw  TREF
        btfss  STATUS,C         ; test TREF-TMRO
        goto   fneg

; if positive or zero
        incf   errf,F           ; increment it
        btfss  errf,7           ; if error is now greater than 7F
        goto   fprot           ; (skip rest of routine if it's not)
        clrf   errf            ; reset it to zero
        incf   errc,F           ; and increment coarse error
        goto   fprot           ; end of 'if zero or positive' code

; else if negative
fneg   movlw  1
        bcf    STATUS,C
        subwf  errf,F           ; take 1 away from errf
        btfsc  STATUS,C         ; has it rolled over from 00 to FF
        goto   fprot           ; if not skip next instruction
        decf   errc,F           ; decrease coarse error

; now timer calculations are finished- test if frequency in tolerance.
; This is done by checking the timer preload (errc) which of course depends
; on the frequency
; Now there are 128 steps in each cycle, 100 cycles per second, and the timer runs
; at 2,457,600 ticks per second. So, we'd expect there to be 192 ticks in each
; cycle. But, the timer interrupt has a latency of 14 ticks, etc. Fear not, the
; value which the timer should take is calculated in the defines- it's TREF

; This routine is vaguely based on Sandia Labs' SFS protection system
; increase frequency violation counter every time errc strays outside tolerance
fprot  movf   errc,W
        bcf    STATUS,C
        sublw  TLO
        btfsc  STATUS,C         ; is errc less than TLO
        goto   finc
        movf   errc,W
        bcf    STATUS,C
        sublw  THI             ; or is it more than THI

```



```

        btfss STATUS,C          ; skip if it is not
        goto   finc
        goto   fok

finc   incfsz fvi,W           ; test if this will roll over
        incf   fvi,F           ; if it won't then increment
        goto   ftest          ; skip decrement

; else, if frequency was OK, decrement fvi. Unless it's zero!
fok    movf   fvi,F           ; move fvi to itself
        btfss STATUS,Z          ; in order to test for zero
        decf   fvi,F

; if the counter hits 'CTS'- Bring the show down!
ftest  movf   fvi,W
        bcf   STATUS,C
        sublw CTS
        btfsc STATUS,C          ; skip if fvi greater than CTS
        goto  fnotrip          ; branch to 'no trip' if fvi within limit

        bsf   PORTA,4          ; otherwise immediately cut out power stage
        movf  pstat,W          ; test if status != tripped ie trip has just
occurred...
        sublw TRIPPED          ; because we only want to reset fvi once...
        btfsc STATUS,Z          ; and not every time we do this test...
        goto  fnotrip          ; which would lock us up for good
        movlw TRIPPED
        movwf pstat           ; status = tripped
        movlw CTR              ; reset fvi.
        movwf fvi

; if the counter hits 0- Start up again!
fnotrip movf  fvi,W           ; next instruction skipped if fvi=0
        btfss STATUS,Z
        goto  ttest
        movlw RUNNING         ; set status to running
        movwf pstat

; now get the new throttle setting for this cycle
; a 8 bit setting multiplexed in as two lots of 4 bits due to shortage of
; IO pins
ttest  movf   pstat,W          ; don't execute this if we are tripped
        sublw TRIPPED
        btfsc STATUS,Z
        goto  nothrot

throt  bsf   PORTA,4          ; set multiplexing bit
        nop
        nop
        movf  PORTA,W          ; read 4 most significant bits into W
        andlw B'00001111'      ; mask
        movwf power           ; put into power register
        swapf power,F          ; swap nibbles
        bcf   PORTA,4          ; clear multiplexing output
        nop
        nop
        movf  PORTA,W          ; read 4 least significant bits into W
        andlw B'00001111'      ; mask
        iorwf power,F          ; OR with existing contents of power reg

; simple sleep mode
        btfsc STATUS,Z          ; is throttle setting zero?
        bsf   PORTA,4          ; then cut out power stage

; finally saturate errc
; this is needed so the timer can't be set to pump out interrupts faster than the
; program can handle them
nothrot movf  errc,W
        bcf   STATUS,C
        sublw TMAX
        btfsc STATUS,C          ; is errc greater than TMAX
        goto  skpsat          ; if not skip the next bit
        movlw TMAX
        movwf errc           ; if so let errc=TMAX

```

```

; reset the step index
skpsat clrf    index

; toggle the interrupt edge trigger bit (the next interrupt will come on the opposite
; edge)
    bsf    STATUS,RP0          ; our business is in bank one
    btfsc  OPTION_REG,INTEDG  ; if bit is set
    goto   clear              ; clear it
    bsf    OPTION_REG,INTEDG  ; otherwise set it (because it was clear)
    goto   tend                ; and skip the next line...
clear  bcf    OPTION_REG,INTEDG ; which would just clear it again
tend   bcf    STATUS,RP0      ; back to bank zero

; wreck any interrupts that might have happened meantime
    bcf    INTCON,INTF        ; clear zero crossing interrupt
    bcf    INTCON,TOIF        ; clear timer interrupt

; send zero to PORTB (since this code runs instead of wave step handler)
    clrf   PORTB

; now portb=0 we can test that DC input is ok
; this is dodgy- we hooked a comparator to one of the port pins normally
; used as output (ie time multiplexing)
    bsf    STATUS,RP0
    bsf    TRISB,1            ; briefly turn rb1 to an input
    bcf    STATUS,RP0
    nop                          ; wait for things to settle
    nop
    nop
    btfss  PORTB,1            ; if the DC is out of spec this =1
    goto   dctstok            ; so if not =1 skip to ok
    movlw  TRIPPED
    movwf  pstat              ; status = tripped
    movlw  CTR                ; reset fvi.
    movwf  fvi
dctstok bsf    STATUS,RP0
    bcf    TRISB,1
    bcf    STATUS,RP0

; return the hard way - resetting the program (and eventually overflowing the stack-
; but this is not a problem since the stack is a circular buffer)
    bsf    INTCON,GIE
    goto   main

; timer interrupt service routine
; living dangerously we ENABLE interrupts when executing this code
wave  bcf    INTCON,TOIF      ; clear the interrupt that got us here
    bsf    INTCON,GIE        ; interrupts on

; first calculate the timer value- this needs explained
; the timer value is made from the coarse error plus a simple dither arrangement
; the timer is bumped up by one if the current step index is less than the fine
; error
; if you think about it- this controls the period in increments of 1/128 of a step
; we compute errf-index. if this is +ve or 0 then the timer is incremented
; note the higher the error values- the FASTER the timer will go
    movf   errc,W            ; save errc into timer
    movwf  timer
    movf   errf,W
    bcf    STATUS,C
    subwf  index,W          ; errf - index
    btfsc  STATUS,C          ; if errf < index
    incf   timer,F          ; add one to timer value
    movf   timer,W
    movwf  TMR0             ; now load the timer

; load up some registers
    movlw  0x08              ; set loop count for multiplier
    movwf  count
    movf   power,W          ; transfer current power setting to
    movwf  mulplr           ; temp register (multiplier will mangle it)

; fetch the right lookup table entry

```



```

    movlw  LUTPCH          ; load PC high bits latch
    movwf  PCLATH         ; because the table is in a different page
    movlw  LUTBASE        ; put base address in W
    addwf  index,W        ; add current wave index to W
    call   table          ; here goes nothing

; we return from lookup table with wave step value in W
; multiply by throttle value
; using microchip example multiplier code (mul8x8)
; Multiplier is in mulplr, multiplicand is in W. Answer comes out
; in H_byte (the lower 8 bits are ignored)
; It takes 73 cycles
    clrf   H_byte        ; clear working regs from last time
    clrf   L_byte
mloop    bcf     STATUS, C          ; Clear the carry bit in the status Reg.
carry bit) rrf     mulplr, F        ; Rotate the multiplier right (through
    btfsc  STATUS, C          ; Test the carry bit - if not zero
    addwf  H_byte, F        ; then add W to the high byte
    rrf    H_byte, F        ; Rotate high byte right (with carry
from addwf)
    rrf    L_byte, F        ; rotate low byte right (through carry)
    decfsz count, F        ; decrement count and test - if not zero
    goto   mloop          ; then loop again

; Test to make sure we are in run mode
    movf   pstat,W
    sublw  RUNNING
    btfss  STATUS,Z
    goto   clr

; Send out to D/A (LSB will be ignored by PORTB) unless not in run mode
    movf   H_byte,W
    movwf  PORTB
    goto   noclr

; if not in run mode- send zero instead
clr     clrf   PORTB

; increment wave step index for next time, testing for overrun
noclr  movlw  ISAT          ; value to saturate index to
    subwf  index,W
    btfss  STATUS,Z          ; if zero flag not set...
    incf   index,F          ; increment index

; all done
    clrwdt          ; keep watchdog timer happy
    retfie         ; retfie also re-enables interrupts

;*****
; POWER-ON INITIALISATION
;*****
; initialise working registers
init   bcf     STATUS,RP0          ; bank 0
    clrf   power
    clrf   index
    clrf   errf          ; set up initial values
    clrf   cyc
    movlw  TMR
    movwf  errc          ; for timer speed
    movlw  CTR
    movwf  run          ; countdown to start
    movwf  fvi
    movlw  TRIPPED
    movwf  pstat          ; protection algorithm status

; setup timer
    bsf   STATUS,RP0          ; bank 1
    bcf   OPTION_REG,TOCS    ; timer mode not counter
    bsf   OPTION_REG,PSA    ; prescaler to watchdog timer
    bcf   OPTION_REG,PS2    ; set for 1:1 prescaling
    bcf   OPTION_REG,PS1    ; gives nominal 18ms WDT
    bcf   OPTION_REG,PS0
    clrwdt

```

```

    bcf     STATUS,RPO
    bsf     INTCON,TOIE           ; enable timer overflow interrupt
    clrf    TMRO                 ; preload timer

; setup PORTA
    movlw   B'10000'             ; output latches to known state
    movwf   PORTA               ; (RA4=1 to hold power stage disabled)
    bsf     STATUS,RPO         ; bank 1
    movlw   B'01111'           ; all inputs (TRISA=1) except RA4
    movwf   TRISA

; setup PORTB
    bcf     STATUS,RPO         ; bank 0
    clrf    PORTB              ; clear output latches
    bsf     STATUS,RPO         ; bank 1
    movlw   B'00000001'        ; all outputs (TRISB=0) except RB0
    movwf   TRISB
    bsf     OPTION_REG,NOT_RBPU ; turn off internal pullups
    bsf     OPTION_REG,INTEDG  ; interrupt on rising edge
    bsf     INTCON,INTE        ; enable RB0 as interrupt source

; start interrupts and we got ourselves a convoy
    bcf     STATUS,RPO         ; bank 0
    bsf     INTCON,GIE         ; global interrupt enable
    goto    main

;*****
;   MAIN CODE
;*****
; this doesn't need to do anything - all the work is done by interrupts.
; Having the processor in an endless one-instruction loop might increase interrupt
; latency (because goto takes 2 cycles) so I give it several hundred
; pointless instructions
main    nop                    ; no operation
        org      (LUTBASE-1)    ; then execute a stack of empty memory
        goto     main           ; loop forever

; phoo-ee
        END

```

## A.19. References

1. Personal communications with Trace Engineering and Statpower, 2000
2. 'P929 Recommended Practice for Utility Interface of Photovoltaic (PV) Systems', IEEE, Sep 1998
3. 'Power MOSFET Design', Taylor, B.E., Wiley, 1993, various.
4. 'Power Electronics', Lander, C.W., McGraw-Hill, 1993, pp. 198-216
5. Alternative Transients Program website, Michigan Technical University, <http://www.ee.mtu.edu/atp/>, 2001.
6. 'Development and Testing of an Approach to Anti-Islanding in Utility-Interconnected Photovoltaic Systems', Stevens, J. *et al*, Sandia National Laboratories, 2000



7. 'Switched Mode Power Supplies in Practice', Kilgenstein, O., Wiley, 1993.
8. 'Electromagnetism for Electronic Engineers', Carter, R.G., Chapman & Hall, 1992
9. 'The Art of Electronics' 2<sup>nd</sup> ed., Horowitz, P., Hill, W., Cambridge University Press, 1989
10. 'Utility-interactive photovoltaic power conditioning system with forward converter for domestic applications', Matsui, K. et al., IEE Proc.- Electr. Power Appl, Vol. 147, No. 3, May 2000

## **Appendix B: A voltage-controlled dump load**

The experimental setup required an apparatus for getting rid of surplus electrical power. In renewable energy, this is known as a dump load. In its simplest form, it is a large resistor, rather like an electric fire element, which can be turned on or off by a relay as required. This application called for something more advanced, so that the power dumped could be modulated to any desired level. It also seemed prudent to incorporate an overvoltage protection circuit, which would dump power if the DC voltage ever rose to a potentially damaging level. In normal operation, of course, the dispatching/battery management system should keep the voltage within sensible limits, but due to the experimental nature of things, it might well not work according to plan.

### ***B.1. Design considerations***

The design of the dump load unit was influenced by the availability of parts, as well as the required functionality. A bank of power MOSFET transistors on a large heatsink was left over from a previous experiment. These were almost ideally suited to the job, except that the power dissipation was not quite high enough. This could be improved by connecting power resistors in series with the MOSFETs. There was still some doubt as to whether the heatsink could handle the power level, though. A few cooling fans would probably deal with this problem. 200 watt wire-wound resistors, and 80mm 12 volt fans, were available at reasonable prices.

MOSFETs are controlled by applying a voltage to the gate terminal. They are normally used in the switching mode, where the gate voltage is either zero, or 10-15 volts, enough to turn the device fully on. By using intermediate gate voltages, though, the MOSFET can be turned only partly on. In this 'linear' region of operation, the device looks like a current sink, drawing a constant drain current proportional to the square of the gate voltage. The constant of proportionality is quite poorly defined, and would vary widely between different batches of devices, so this mode of operation would not be very suited to a mass-produced instrument. For a one-off construction, though, there is no problem; the response of the actual devices can be measured and the circuit tailored accordingly. It also varies with temperature,



though, so a particular gate voltage can never be depended on to always give the same drain current. In this application, this can be dealt with by putting the dump load inside another feedback loop that measures the current and adjusts the gate voltage accordingly. This could be a function of the dump load control software, since the computer has access to the dump load current measurement.

The over-voltage protection circuit would be easily made using a shunt regulator IC. This is a chip that compares a voltage to an internal reference, and if the voltage is higher than the reference, sinks current to ground through a built-in transistor. A few of the popular TL431 regulator chips were to hand, so they were a natural choice. Unfortunately, they operated in the wrong sense for this application: an excess of voltage would require that the MOSFETs be turned on more to burn up more power. In order to do this, current should be sourced into the gate terminal, but the regulator chip sinks current instead. This would easily be dealt with by using a current mirror-type circuit.

## ***B.2. Circuit***

Fig. 11.1 shows the circuit diagram: M1-M4 are the power MOSFETs, sinking current to ground via resistors R1, R2. The gate terminals are connected to the control voltage input, via R12, R13 and potentiometer R15, which adds an adjustable DC offset so that the MOSFETs are biased almost at their turn-on threshold of 1.5-2V when the control voltage is zero. R3-6 are stopper resistors to prevent parasitic RF oscillations, a common problem in MOSFET circuits. D1 senses the DC bus voltage via divider network R9, R10, R11, R17. When the voltage at D1 input exceeds the internal 2.45V reference, D1 sinks current, turning Q1 on, which sources extra current into the MOSFET gates, increasing the gate voltage and turning the devices on. Circuit values are chosen so that the MOSFETs can be turned fully on by the regulator even when the control voltage input is zero. Potentiometer R9 allows the regulating voltage to be set between 24 and 30V. Cooling fans (not shown in circuit) are connected in series for 24 volt operation, and connected across R1, R2 so that fan speed depends on current draw.

### ***B.3. Computer interface***

The control voltage was derived from 8 digital output lines on the computer, using an R-2R ladder type DAC, borrowed from a prototype inverter. This has rather a high output impedance, and the dump load control input will load it down somewhat. Fortunately, the input turned out to be sensitive enough that this was not a problem.

### ***B.4. Construction***

The apparatus was assembled on a large heatsink (200x250x50mm) with a bracket to hold the cooling fans in place. An aluminium casing was made to protect the wiring and terminals from short-circuits, and to allow the assembly to stand upright for optimum convection cooling. This was an issue because the fans did not actually start spinning until about 80-90W dissipation was reached.



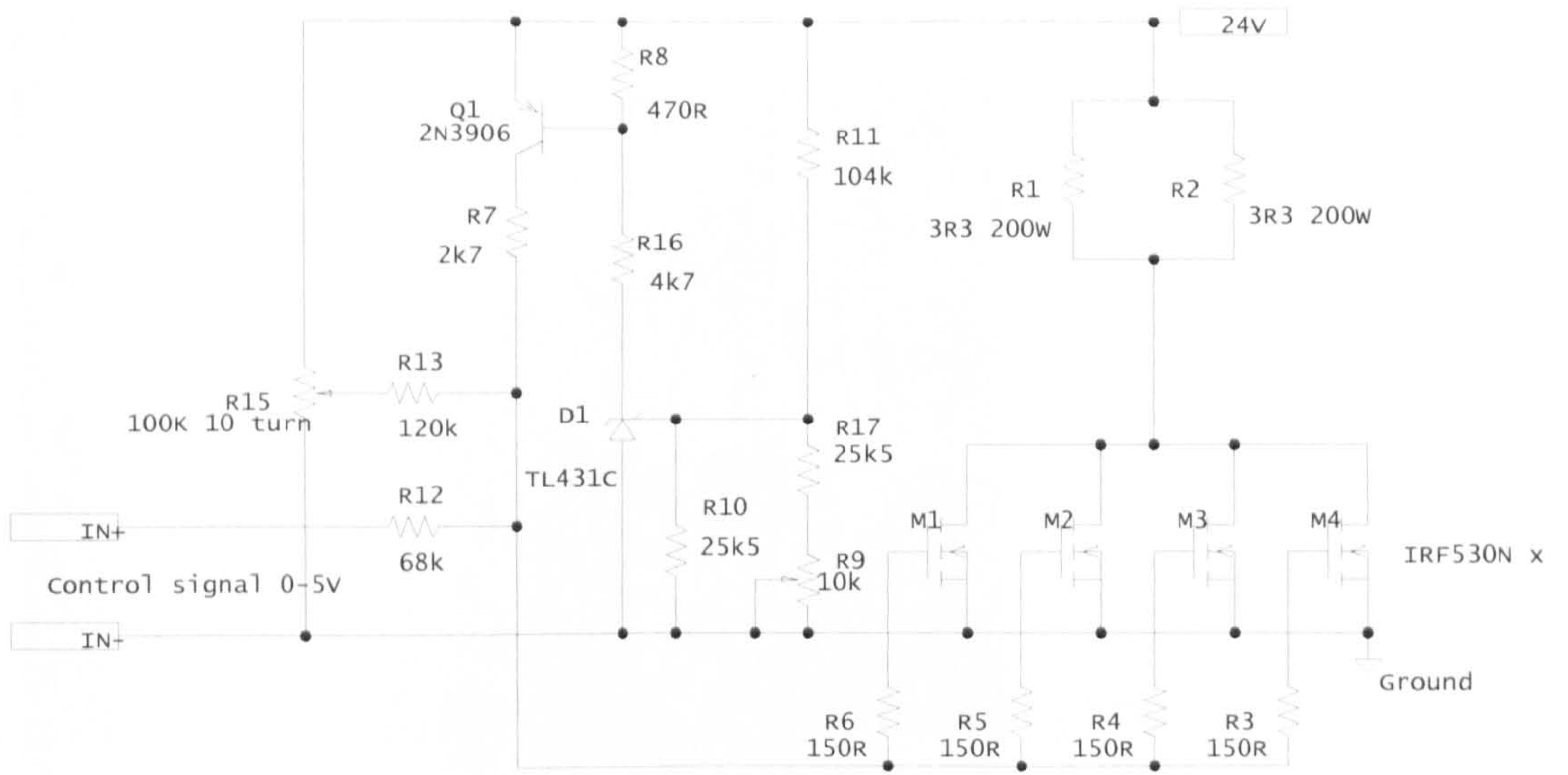

(Fig. B.1: Circuit diagram of dump load.)

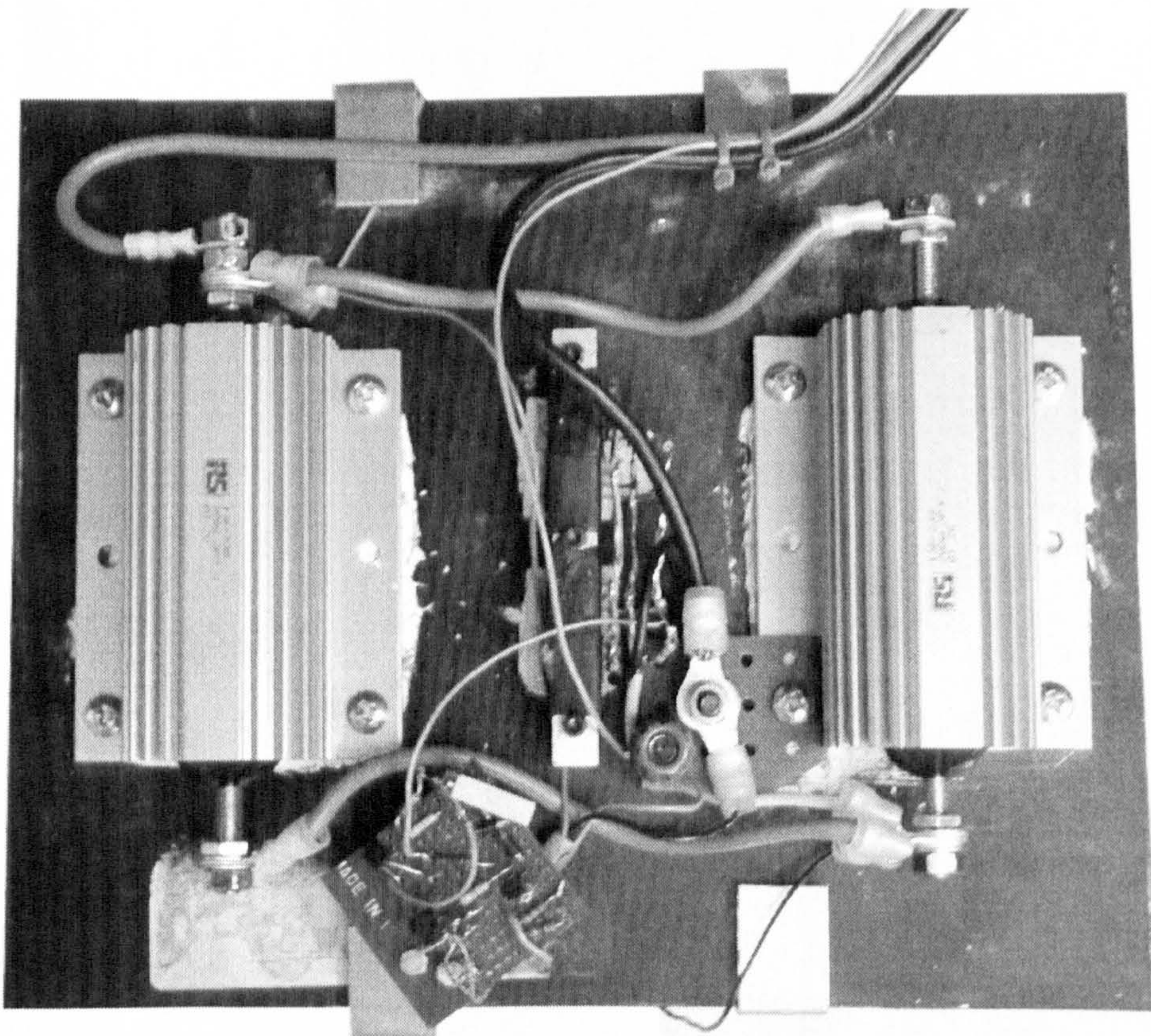

(Fig. B.2: Dump load interior view. Size approx 200x250mm)



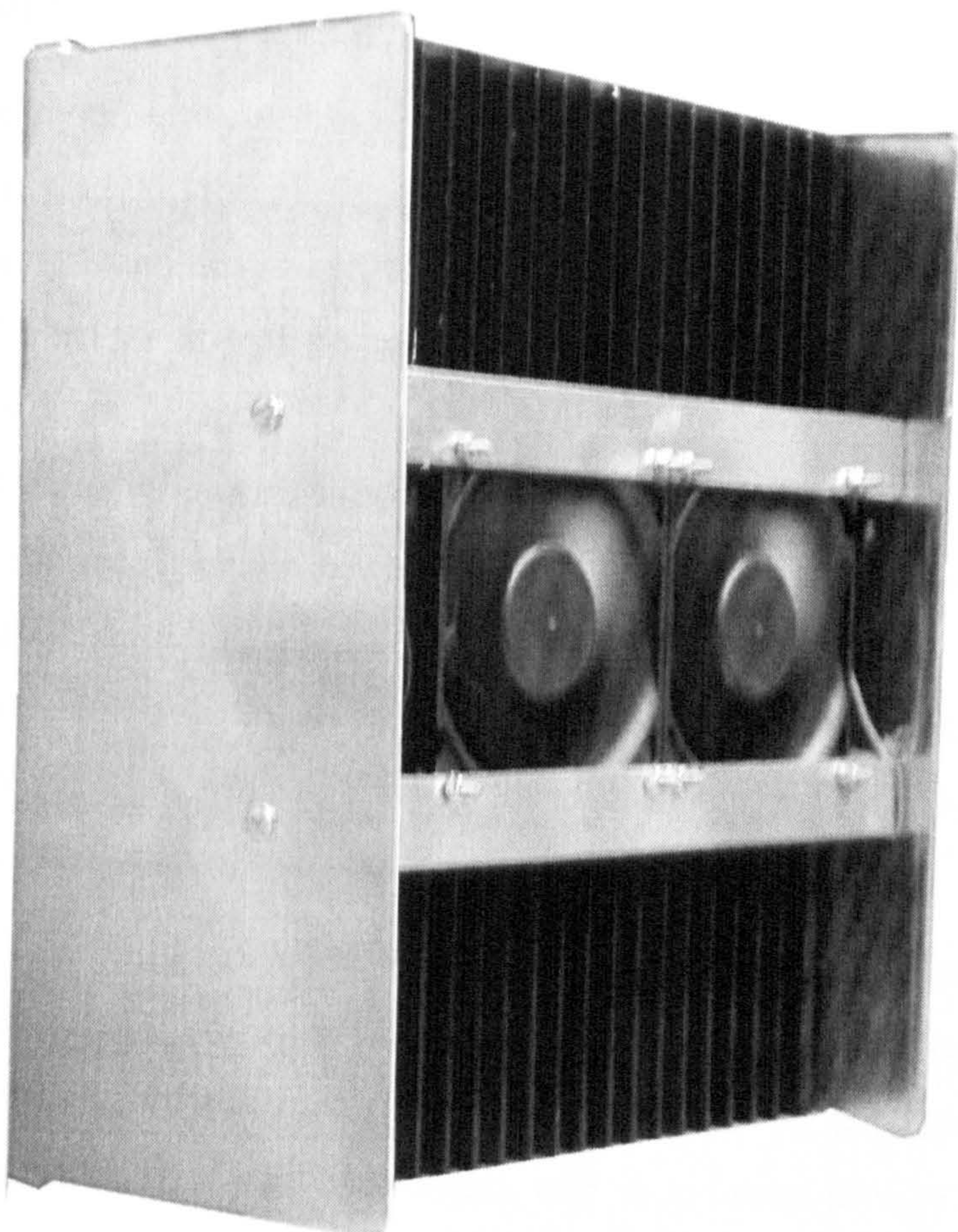

(Fig. B.3: Dump load assembled)



## **Appendix C: The “Smart Socket”**

The proposed system needed some way of making electrical loads “smart”. In other words, giving them a means of telling the dispatching system how much power they required, and how much they were prepared to pay, and in turn having the dispatcher tell them whether it was acceptable to turn on. The way of doing this would ideally be simple, inexpensive, and applicable to existing electrical appliances. To achieve this backwards compatibility, it would have to take the form of some kind of device that connected between the appliance and the power source, sensed the power demand, communicated with the dispatching system, and optionally interrupted the power supply if the demand was not authorised. It seemed that a logical place for such a device would be inside the power socket to which an appliance connected, hence the name “Smart Socket” was coined.

The different kinds of power measuring systems were discussed at greater length in Section 6.3.2. To recap, the simplest and cheapest option is a sensor that just detects the presence or absence of electrical current flowing through the load. The wattage of the load is measured beforehand, and is assumed always to be the same. This is sufficient for many types of load, such as incandescent light bulbs, electric heaters, and the like. More complicated sensors would measure the magnitude of the current flowing, or better still, measure both voltage and current, and calculate the true power. However, for this first attempt, a decision was made to use the simplest kind of sensor possible.

### ***C.1. Design considerations***

It was decided to use a current sensor that would give a binary “yes/no” output depending on whether current was flowing or not. Current is usually sensed by having it flow through a resistor, and measuring the voltage that appears across the resistor. However, this method posed a few problems in this application. First was that the dynamic range of currents to be measured was quite large. The design was to work with an ordinary 13-amp mains socket. The largest load which this can be expected to carry is of course 13 amps. The current sense resistor must be able to take this without excessive voltage drops and heating. (In this context, “excessive

heating” is heat that cannot be dissipated within the plastic body of an ordinary UK wall socket; i.e. more than about 5-10 watts, and excessive voltage drop is anything more than about 2 to 3 volts.) Therefore, the maximum current shunt resistance is set by the dissipation requirement, at around  $R=P/I^2=0.05$  ohms. The volt drop across this at 13 amps will be 0.57V only. This is quite a small voltage, however the real trouble comes when some of the smallest loads are used. The same socket needs to be able to cope with loads like portable radios, which might typically use 5-10VA. 5VA represents a current of 21mA, hence a voltage across the same current shunt of only 1mV.

This voltage is rather small, and would require a precision op-amp for detection. This is undesirable, because the amplifier, besides costing money itself, would require a power supply. The power supply components would add extra cost and complexity to the system, especially when requirements for safety isolation were taken into account.

A simple solution was to replace the current shunt resistor with a non-linear element. A string of diodes was ideal for this purpose: the forward voltage of a diode is around 0.7V over a wide range of currents. Three diodes in series gave enough voltage drop to light an opto-isolator directly, so the resulting circuit was very simple. However, it would dissipate considerably more power than allowed; around 40 watts with a 13-amp load. Although this did not meet the design goals, it was not judged to be a problem in the research context. The workaround consisted of limiting the current to 10 amps, and fitting a metal heatsink to the socket housing.

Another problem was that the output was not continuous when current was flowing. As the AC current passed through zero, the opto-isolator would momentarily go out, causing an interruption in the signal. This was solved by having the opto-isolator signal trigger a one-shot multivibrator-type circuit with a period longer than a half-cycle of AC.

So much for the sensing side of things, but there was also control to be done. The simplest way of controlling the load was to turn it on and off with a relay built into the socket. This was not a problem, except that the specification called for information on the load’s on/off status, even when it was turned off by the relay. This



was achieved by fitting a small capacitor across the relay contacts, allowing a small amount of current to pass; not enough to operate the load, but enough to allow the current sensor to tell if the load was turned on. Unfortunately, the capacitors chosen were slightly too big, the result being that enough current passed to operate one portable radio tried during testing, even when it was meant to be off. There might have been a resonant condition between the capacitor and the magnetising inductance of the radio's transformer, causing a greater current flow than expected.

### **C.2. *Interfacing***

The prototype was constructed as a four-way socket strip, similar to an ordinary extension lead. It had four digital inputs, one controlling each relay via a transistor buffer, and four digital outputs, one from each current sensor. These were all brought to a 24-line digital I/O card fitted in a PC computer. The card was a low-cost model made by Maplin Electronics, no longer in production. A LabVIEW driver was written for it, especially for this experiment.

### **C.3. *Circuit description***

This description refers to Fig. 12.1. The live line of the mains input (LIVE IN) connects to the current sensing diode network D3-D7. This is made from a bridge rectifier with an extra diode connected across the DC output terminals. When a current passes, the voltage developed across the diode network lights the LED in opto-isolator U5. This is an AC opto-isolator, and so has two LEDs back to back. R3 converts the opto-isolator photocurrent to a voltage, which is buffered and Schmitt triggered by U1A. The output of U1A operates a simple one-shot circuit comprising D1, R2, C1, and U2A. The operation is as follows: When the optoisolator lights, U1A output goes LOW, C1 is discharged rapidly via D1, and U2A output goes HIGH. When the optoisolator goes off, C1 recharges slowly via R2, causing a time delay before U2A output goes LOW again. This time delay is chosen to be longer than one half-cycle of mains (1/100 sec) and so U2A output stays steadily HIGH even though the optoisolator goes out at every current zero.

The live output from the diode network goes to the load via relay RL1. Capacitor C2 allows a small current even when the relay is open, so that the sensor will continue to

function. Q1, Q2, R1 are an ordinary Darlington driver which boosts the current capability of the control signal so that it can operate the relay. D2 is a flywheel diode which prevents the relay coil generating turn-off spikes.

5 volt power for the logic chips and relays is supplied by the I/O card.



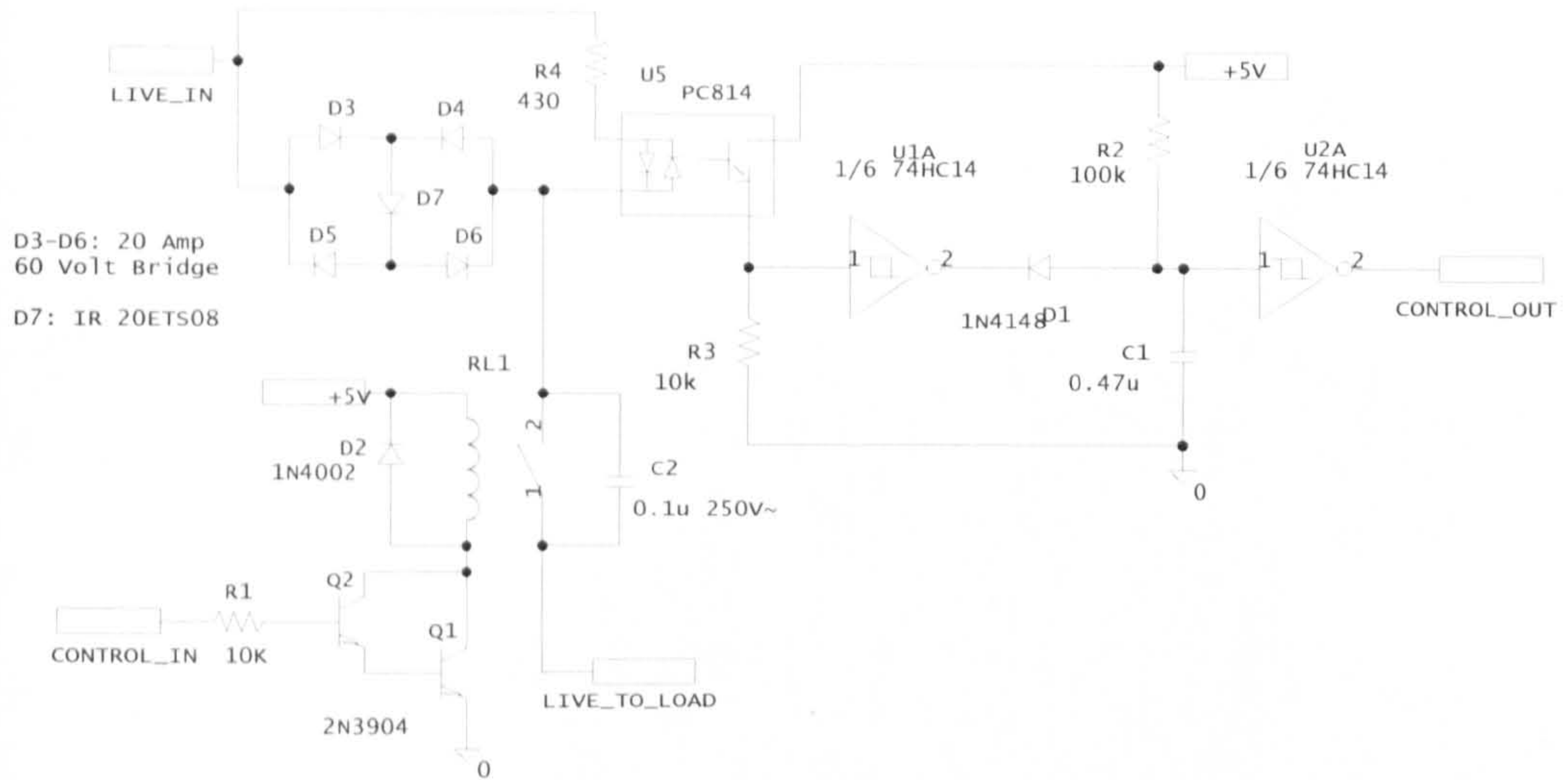

(Fig. C.1: Circuit diagram. One channel shown, unit has four identical channels.)

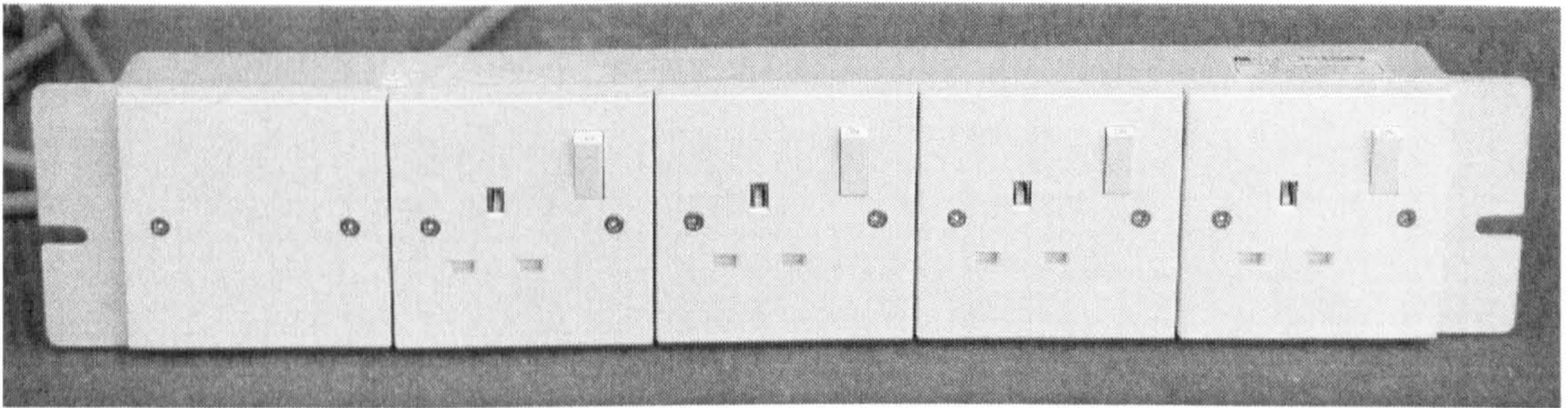

(Fig. C.2: The smart socket unit)

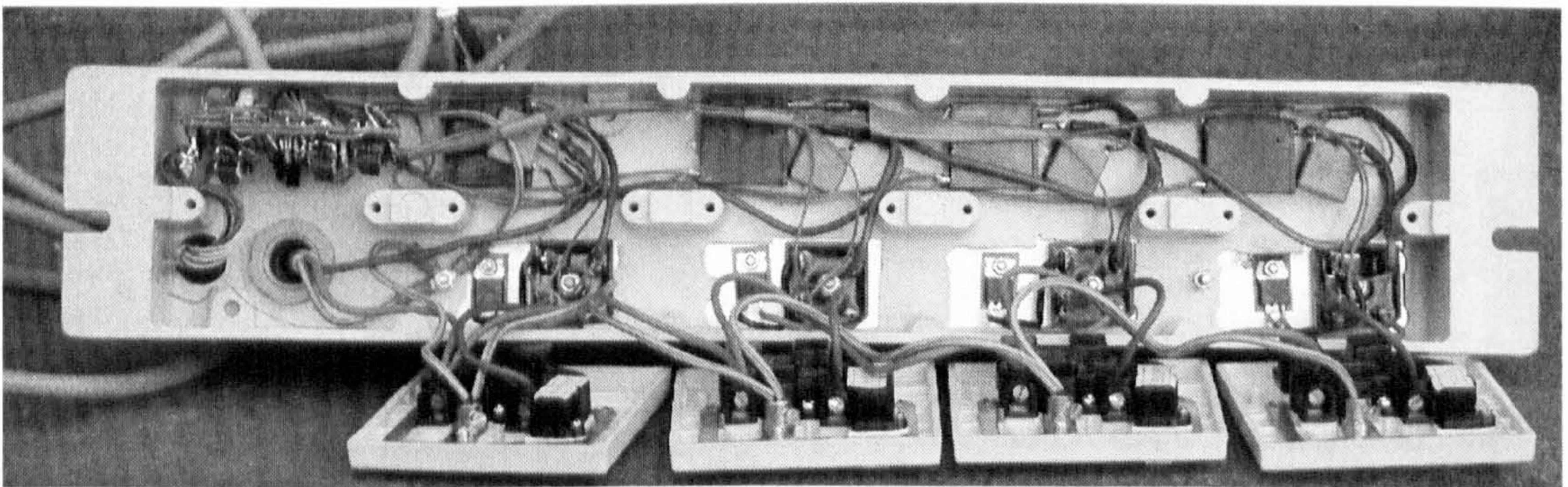

(Fig. C.3: Internal view of smart socket unit)



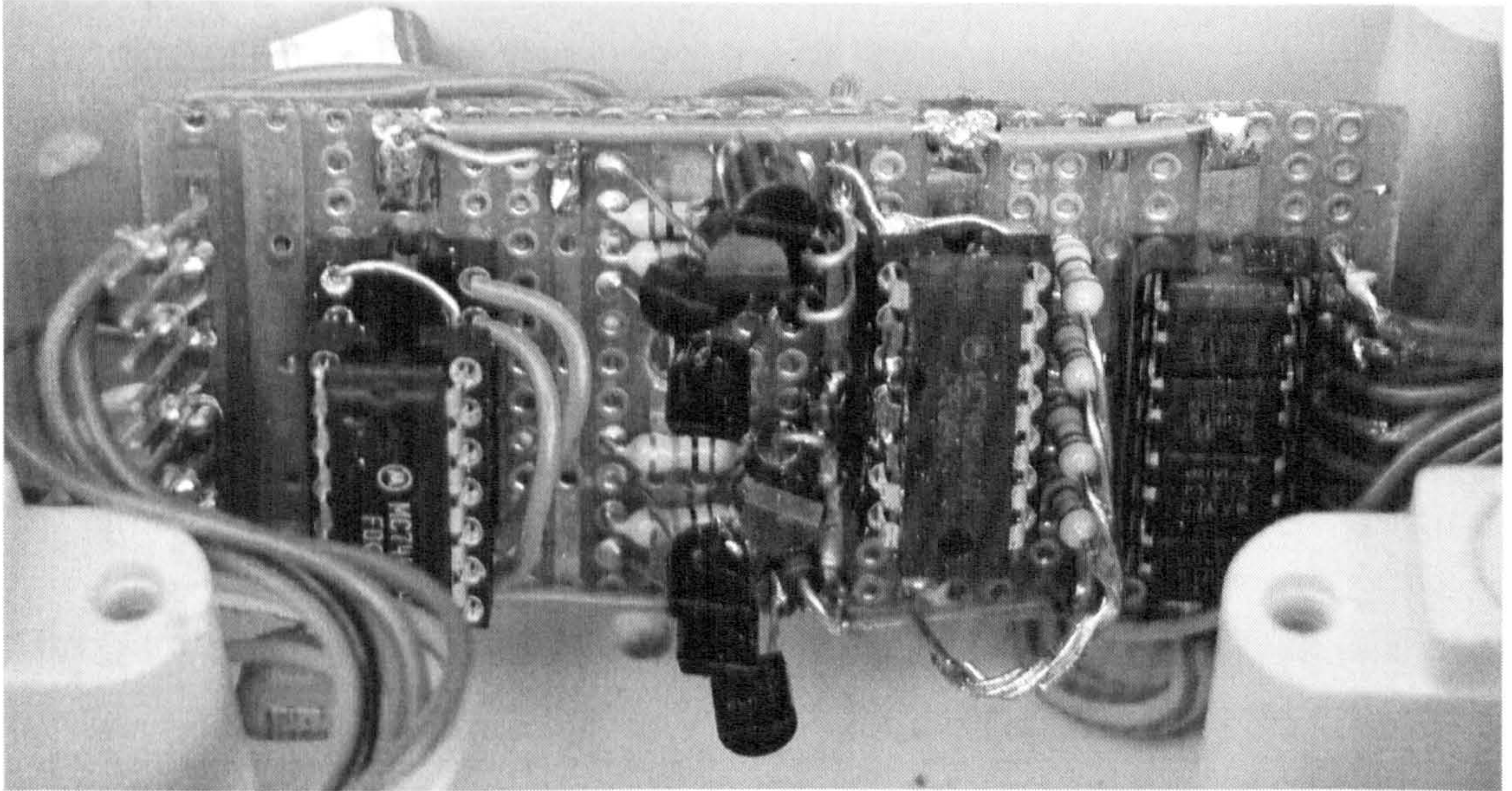

(Fig. C.4: Circuit board containing opto-isolators, one-shots, and relay drivers)

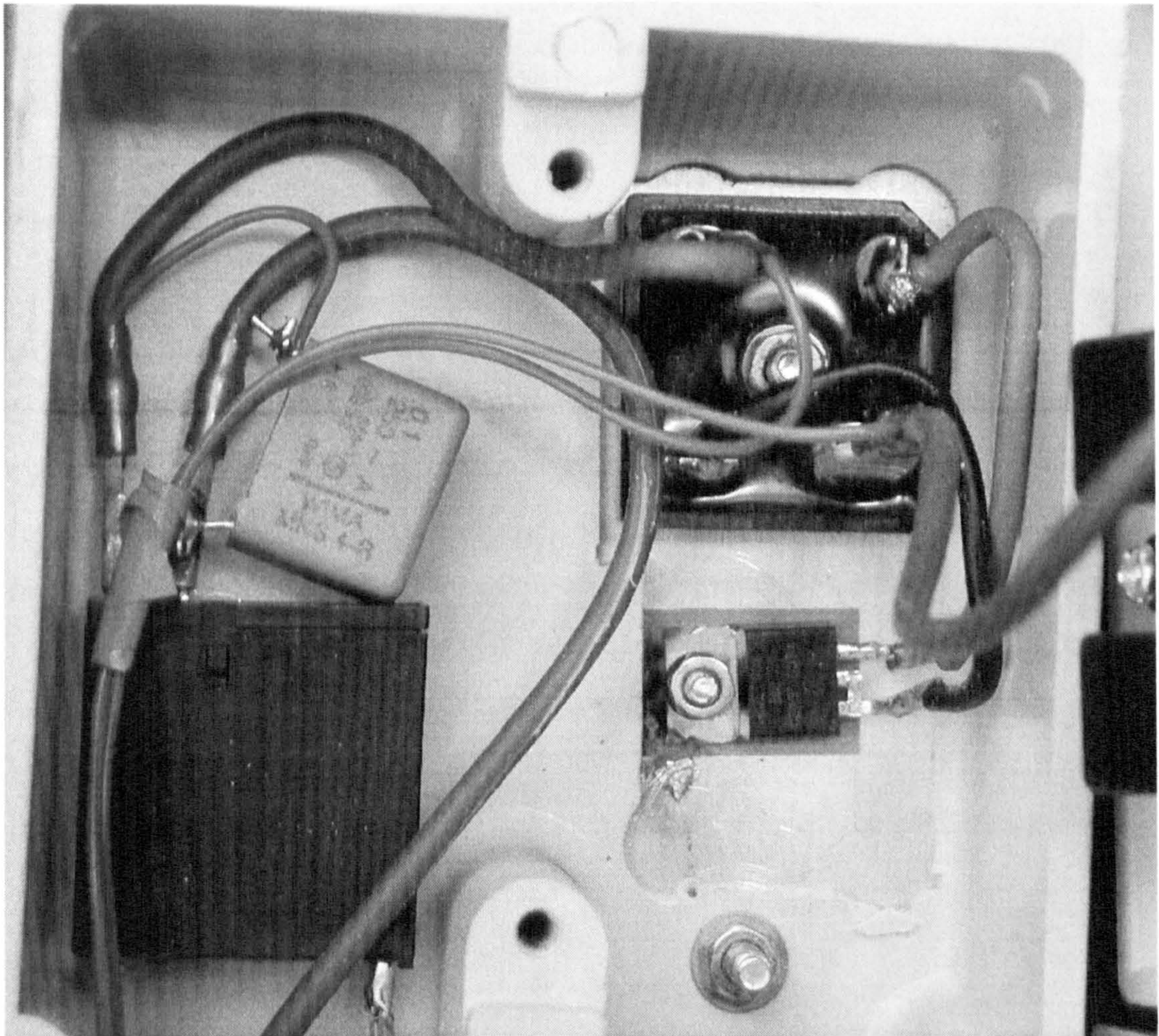

(Fig. C.5: Switching/sensing circuit showing relay, diodes and capacitor)



## Appendix D: Power measurement by soundcard

As part of the program of experiments, there was often a need to measure the power drawn from the mains by electronic equipment with reasonable accuracy, in a convenient way that did not require any expensive hardware. For accuracy's sake, the power measurement had to be what is sometimes called "true RMS" power; in other words, it had to take account of power factor, and the effect of non-sinusoidal line current and voltage waveforms.

There are two ways of getting this "true RMS" power measurement. The first involves computing the RMS voltage and current, and the power factor angle (found by measuring time interval between voltage and current zero crossings). The product  $V_{rms} I_{rms} \cos\phi$  then gives the real power.

The second involves sampling the instantaneous voltage and current waveforms, and multiplying each pair of voltage and current samples together to give an instantaneous power. The time average of the instantaneous power gives the real power.

Both of these algorithms are normally run on a dedicated instrument, sometimes including a microcontroller and A/D converter, or alternatively analogue multipliers or digital rate-type multipliers. A power meter built in this way normally costs a few hundred pounds. Power meter ICs are also available that integrate most of the above functions, and can be used with a timer/counter or microcontroller. However, it was brought to my attention that most personal computers already have the proper hardware to make a power meter. The sound system on a typical PC, Macintosh, etc. has two 16-bit A/D converters for stereo sound input, which could be used to sample voltage and current instead. The CPU on modern computers has ample power to perform all the required calculations. It seemed that a PC could be used as a power meter with just voltage and current transformers to provide isolation and reduce the voltage to a safe level.

## ***D.1. Design considerations***

16-bit conversion gives a theoretical accuracy of one part in 64,000, which is far better than required for power measurement. Unfortunately, though, the rest of the sound circuitry in computers often does not match up to this level of accuracy. It is common practice to use components of 5% or 10% tolerance, electronic level control circuits whose characteristics can vary with temperature, and electrolytic capacitors whose value can vary by up to 80%. Problems which might be caused include calibration shifts with temperature, unwanted phase shifts, and mismatches in phase shift between the two stereo channels. Any of these could degrade the accuracy of a power measurement, and unfortunately it would be difficult to quantify the accuracy of a particular soundcard, since it would involve testing it over various different temperatures and so on. It seemed that a reasonable plan of attack might be to build a prototype of the system, and see if it worked.

## ***D.2. Hardware***

The most important parts of the system (apart from the soundcard) would be the current and voltage transducers. The requirements for these would be: galvanic isolation between the mains voltage and the soundcard, and reasonable accuracy in reproducing the voltage/current waveform, the latter implying a good bandwidth free from phase and amplitude distortion, etc. This requirement might be quantified as; total harmonic distortion less than a few percent, and bandwidth of around 5-10 kHz.

The simplest kind of transducer meeting these requirements is a current or voltage transformer. A transformer has one drawback, in that it cannot reproduce any DC component in the waveform. This should not be a problem, though, because AC supplies and loads are not supposed to have any DC component. It happened that there were some surplus current and voltage transformers available, so these were tried first of all.

### **D.2.1. Current transformer**

The CT was taken from a scrapped electronic wattmeter apparatus. It was originally a 1:1 CT rated at 0.2A. By connecting the original primary and secondary together in series, and then adding a new 3-turn primary winding, it was made into a 100:1 CT



capable of handling 20A. It was used along with a 10 ohm burden resistor to give an overall sensitivity of 0.1V/A.

### D.2.2. Voltage transformer

A small toroidal power transformer was used as the VT. The toroidal type was chosen since it has less magnetising current, leakage reactance, DC resistance, etc. than the E-I type, and hence ought to reproduce the waveform with less distortion. The transformer was chosen simply because it was the smallest toroid I could find. It had a 240V primary and 15V secondary, therefore a ratio of 16:1. The 15V RMS output would be too high for the soundcard input and some sort of attenuation would be needed.

### D.2.3. Circuit

The measuring circuit (see Fig. 13.1) was very simple. Outputs from the VT and CT with burden resistor were taken to a pair of trimpots for calibration. In the case of the VT, a 100k resistor was added in series with the 10K pot to give an additional 10x attenuation. Outputs from the pot wipers went directly to the soundcard line inputs, current to the left channel and voltage to the right.

## D.3. Software

The software was written in NI LabVIEW, using the sound input capabilities and signal analysis functions.

### D.3.1. Data gathering

The sound input was set up to provide a stream of stereo 16-bit data at 11025 samples per second. This is one of the standard sample rates used by computer sound hardware, others are 22050 and 44100/second. The sample data piled up in a buffer, and each time the buffer became full, the chunk of data was passed to the analysis section of the program. There was a tradeoff here. As the chunks became larger, the analysis would be more accurate, being the average of a greater number of mains voltage cycles. But, each chunk would take longer to accumulate and hence the display would be slower in updating. The buffer size was made adjustable in 1K

increments to help in exploring this tradeoff. A 16K buffer, hence an update period of  $(16384/(11025*4))=0.37$  sec., was found to give good results.

### D.3.2. Analysis

The buffer contents were converted into two arrays of 16-bit 2's complement integers, one for the left (current) channel and the other for the right (voltage) channel. Next, these were changed into double-precision floating-point format, and multiplied by appropriate calibration constants. The result was one time series (1-D array) of voltage samples and another of current samples.

These were processed in three ways. First, corresponding elements of the two arrays were multiplied together to create a third array, the time series of instantaneous power. The mean of this series was taken, giving the real power P.

Second, the variances (standard deviation) of both voltage and current series were calculated. These were the RMS voltage and current respectively. The product of RMS voltage and current gave the apparent power S.

Third, the reactive power Q and power factor P.F. were calculated by the well known relations,  $P^2+Q^2=S^2$ ,  $P.F.=P/S$ . This completed the power analysis.

### D.4. Calibration and testing

The first step in calibration was to set the voltage reading. A suitable voltage calibration constant was chosen, in this case 350V f.s., and the voltage trimpot was adjusted so that the power analyser voltage readout agreed with a voltmeter connected to the power analyser socket.

Next, a current calibration constant was chosen, in this case 8 amps, a load of known power consumption was connected, and the current trimpot adjusted until the power readout agreed.

The choice of calibration constants is not arbitrary, rather it determines the full-scale range of the device. In this case it would be:  $\frac{350}{\sqrt{2}} \times \frac{8}{\sqrt{2}} = 1400VA$ . That assumes sinusoidal voltages and currents, in practice some extra headroom must be allowed (crest factor)



The calibration was retested at regular intervals and was found to drift slightly. The same 60-watt bulb read between 60 and 62 watts at different times. Of course, this could have been caused by actual changes in line voltage to an extent.

More annoying was a slight zero offset (3.6 watts) that could not be eradicated. It was eventually tracked down to crosstalk; the signal on the voltage channel was bleeding into the current channel. This was happening inside the soundcard circuitry itself, and not very much could be done about it, short of upgrading to a better soundcard. In any case, this was an error of under 1% of f.s. which was actually better than some commercial power meters.

Figs. 13.5 and 13.6 are sample screenshots from the software. 13.5 shows the power analysis of a 60 watt light bulb. The power is correct to within a few percent, and the error could be due to the bulb rather than the measurement system. The only problem with this measurement is that it shows a small amount of reactive power, whereas a lamp is obviously a pure resistance. This would tend to suggest a slight phase error between channels, or it could be a result of capacitive/inductive crosstalk between channels.

13.6 shows a highly reactive and non-linear load, actually the AC power unit of a laptop computer. This example illustrates the need for such complex means of measuring power. By using a voltmeter and ammeter here, and multiplying the voltage and current readings, the result would be similar to the apparent power (VA rating) which in this case is 47. However, the real power measurement shows that the unit is only consuming 19 watts.

#### ***D.5. Conclusions***

Measuring power with a computer soundcard certainly seems to be possible, as the experimental prototype shows. It requires a minimum of extra hardware, and gives acceptable (though not excellent with this particular soundcard) results. It would be useful in applications where there is access to a computer, power measurements are desired, but the budget does not permit a dedicated power meter.



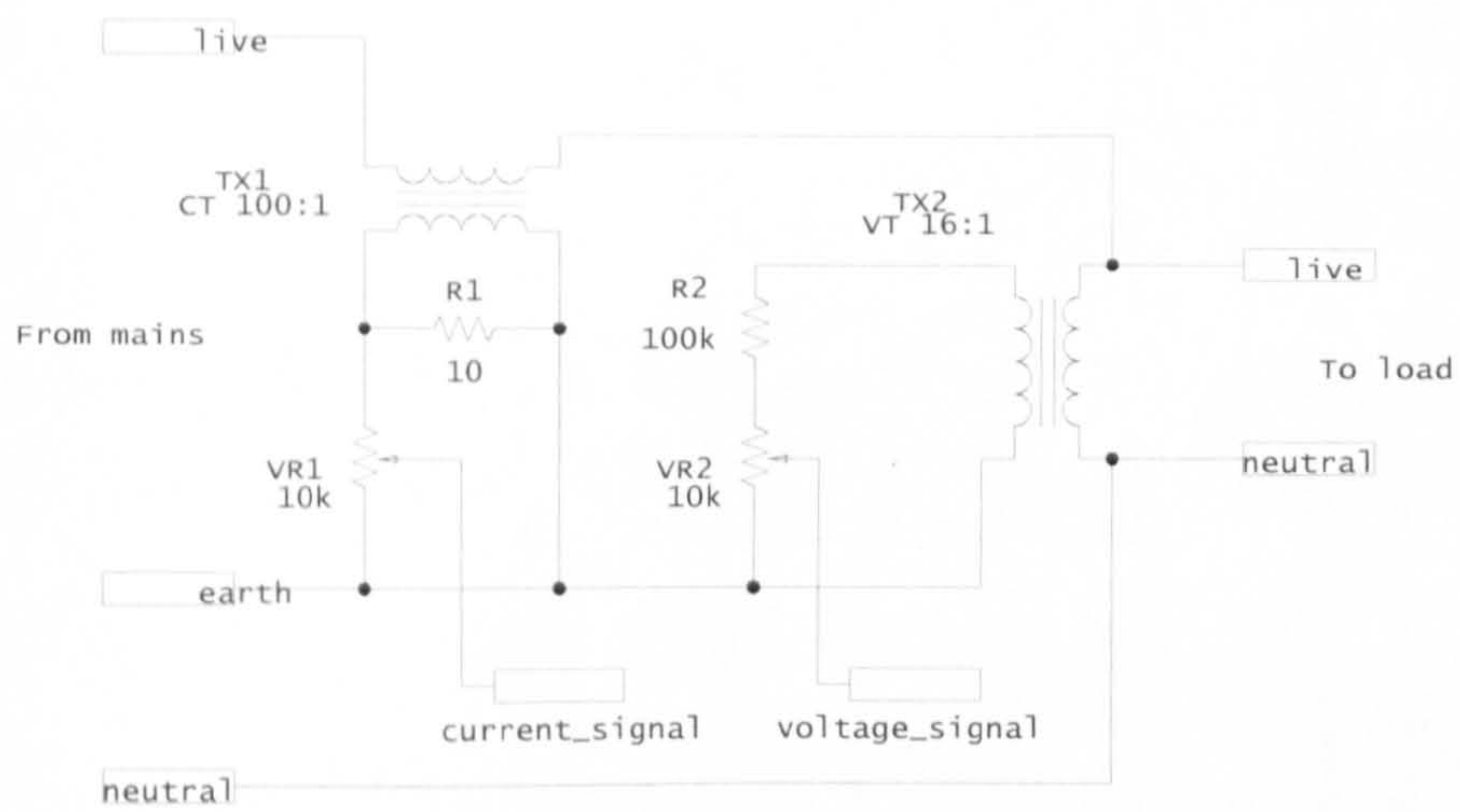

(Fig. D.1: Circuit of measuring unit)

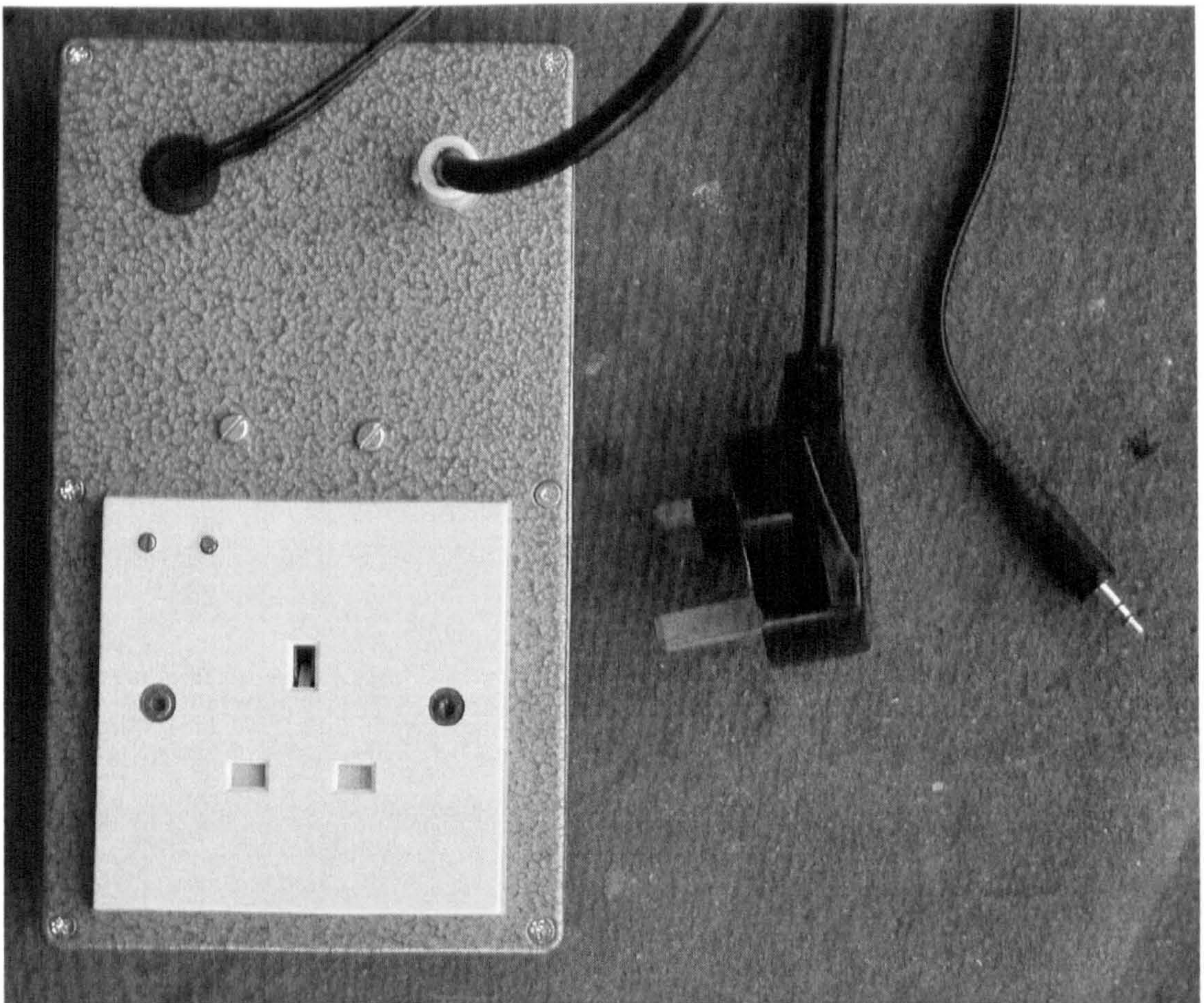

(Fig. D.2: Measuring unit)



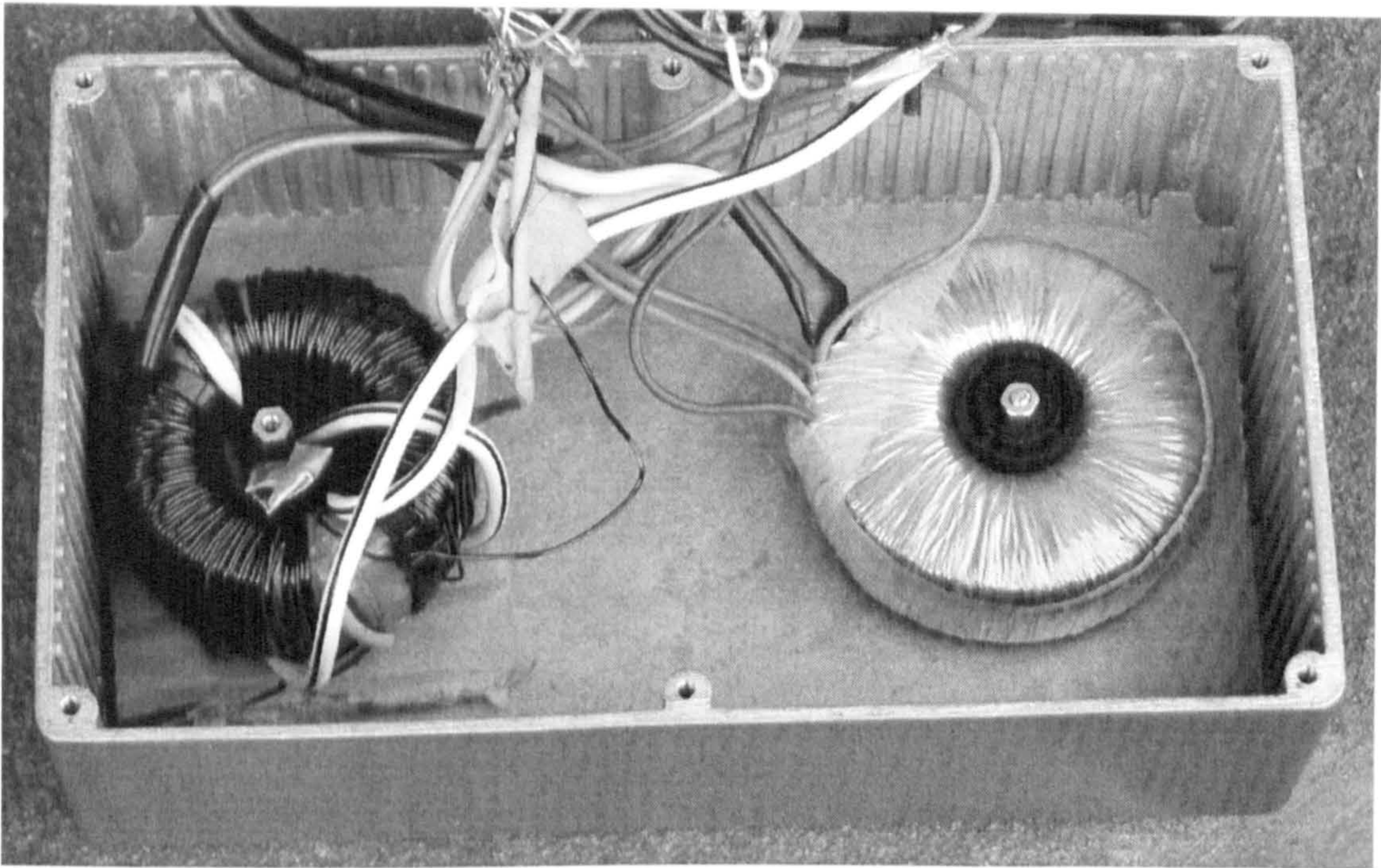

(Fig. D.3: Inside unit showing current and voltage transformers. CT is on left.)

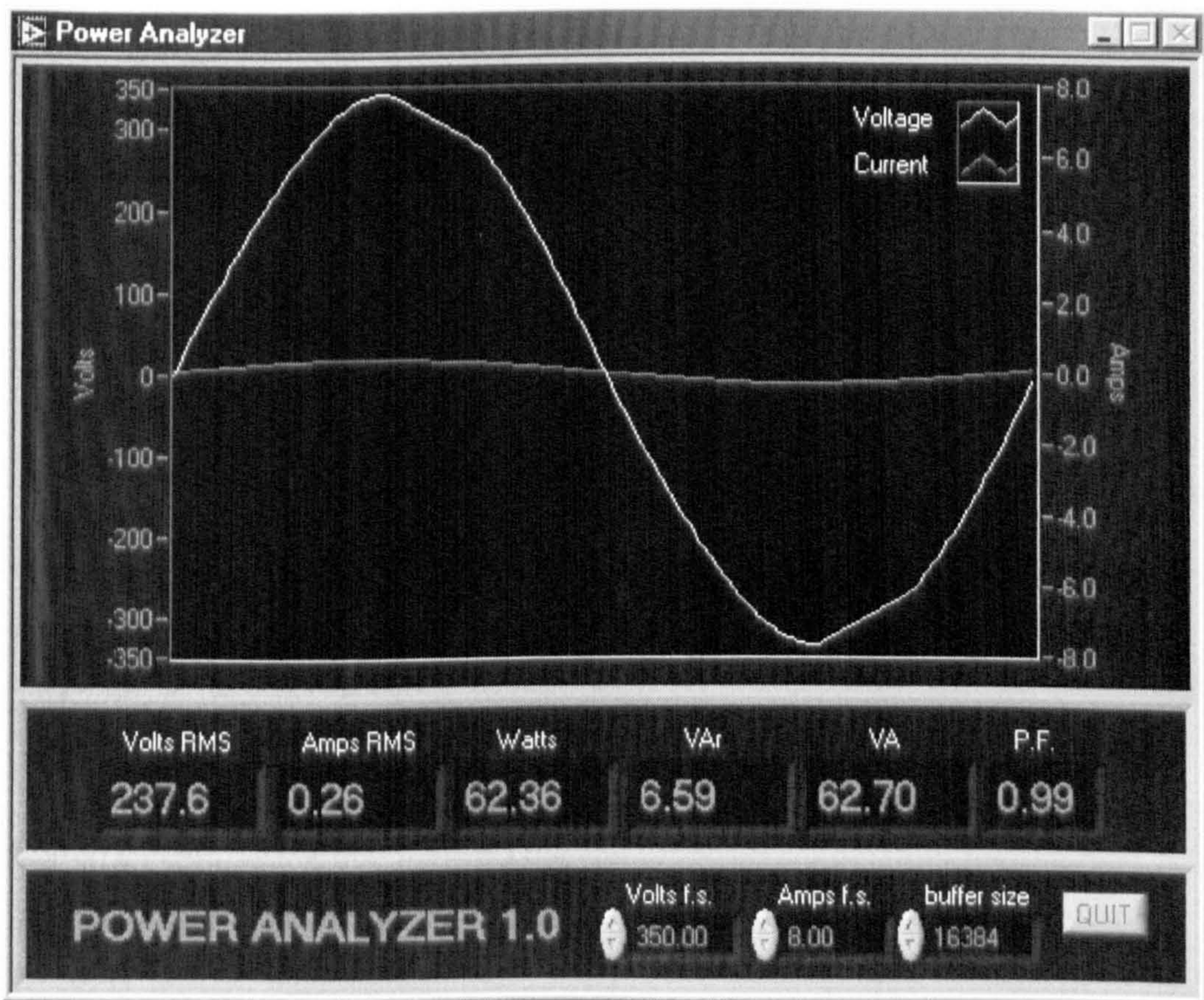

(Fig. D.4: Power analysis of 60-watt light bulb)



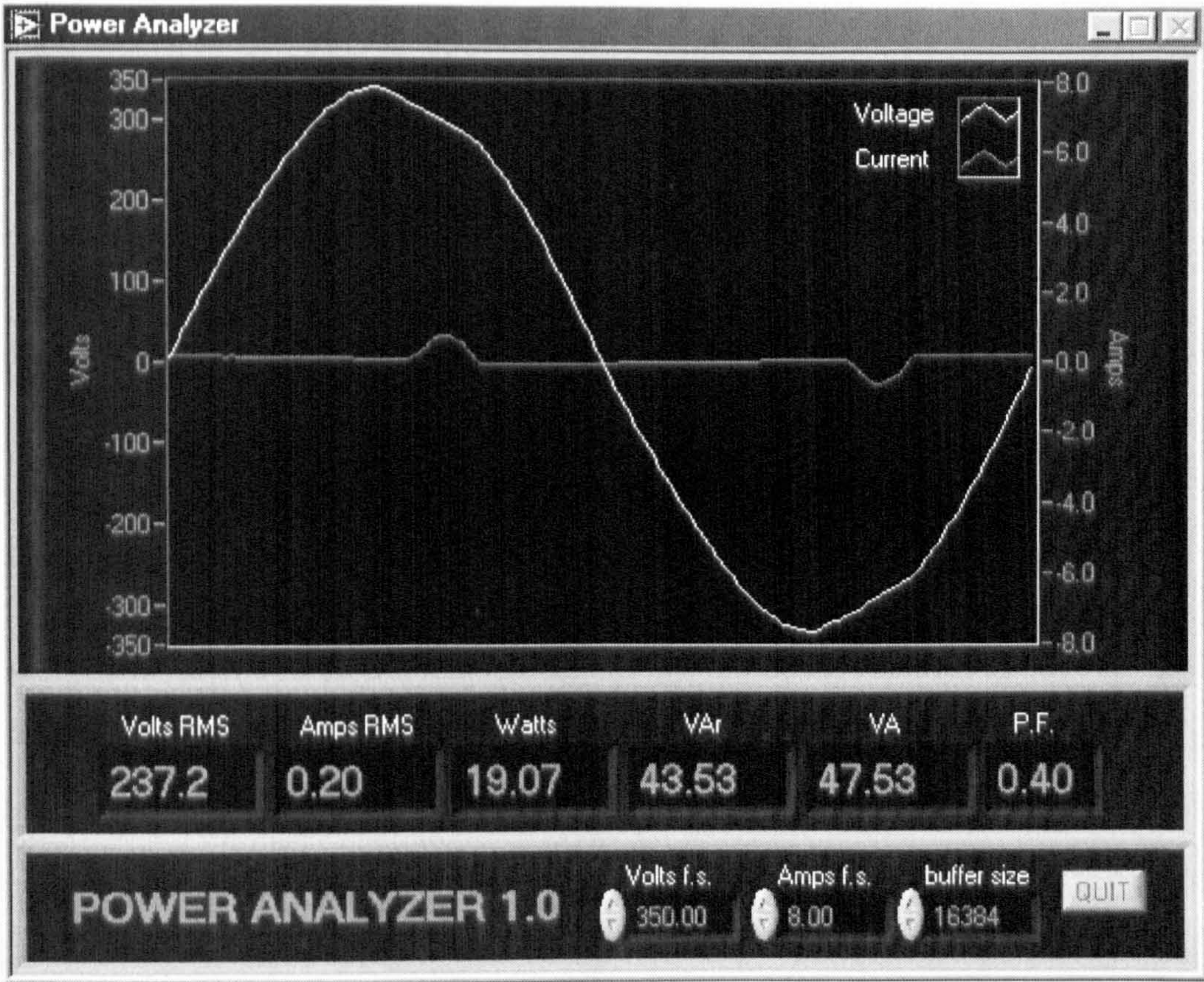

(Fig. D.5: Power analysis of mains power unit of a laptop)



## **Appendix E: Modelling inverters in ESP-r**

As part of this work, various computer tools for modelling renewable energy power systems were investigated. One of these was the integrated simulator, ESP-r. This was originally developed [1] for building simulation, but in the course of time the capabilities were greatly extended. It now aims to perform integrated simulation of all energy systems and processes at work within a building or other environmental system. Of particular interest is the electrical power flow simulation module, which was added quite recently [2].

### ***E.1. About structure of ESP-r***

ESP-r runs on Unix and Linux operating systems with X-Windows or similar GUI. It is a large software suite consisting of more than a million lines of Fortran code. The system is organised into a number of modules, which are of three main kinds. First are the problem definition modules, which are used to create the model. The output from these is a number of text files describing the model.

These files are next read into the simulator, which solves the model and outputs a binary results database. The simulator itself is a single program which performs an integrated solution of the thermal, fluid flow, and electrical domains. It is composed of many modular subroutines which intercommunicate and access shared data by means of a Fortran Common block. The module responsible for the electrical solution is the power flow simulator (PFS).

Once the solution is finished, the results database is read into the results analysis module (RES) which presents the results as graphs, tables, etc. and allows export to other programs.

This greatly simplified description was correct as of Summer 2000. ESP-r is under continuous development and the structure may well change. See ESRU [3] for more details.

## ***E.2. The power flow simulator (PFS)***

PFS is an electrical power system simulator of the traditional kind. The network is represented by a number of nodes, interconnected by components each having resistance and reactance. At run-time, the database of nodes and components is converted to an admittance matrix for solution. As this description suggests, the solution is in the form of phasors and there is no transient capability. The possible kinds of connecting components are limited to sources of power, sinks of power, resistances, and reactances. PFS is integrated with the rest of ESP-r in that sources and sinks of power can be tied to the building and plant simulator. This means, for example, that a PV module modelled in PFS will change its electrical output according to the light intensity on it, as calculated by the building simulator. The opposite is also possible: sinks of electrical power can be made to appear to the building simulator as sources of heat at the appropriate locations and times. Furthermore, the tie-in with the plant simulator means that as electrical plant items are turned on and off by thermostat, etc., PFS will see the load changing in the appropriate manner.

While this integration is certainly very impressive, it does not alter the fact that there is no way of modelling an inverter. This is because an inverter is a non-linear connecting component, which cannot be represented as an impedance. Rather, it looks more like a power sink paired with a power source.

## ***E.3. Active connections***

In order to deal with this, PFS was modified slightly. A new type of connecting component was introduced: the active connection. This was made from a combination of existing PFS components. One node was a power sink, the other a power source, and a very high resistance (equal to the largest number representable by the computer) was also placed between the two nodes in order to keep the solver happy. The power sink and source were connected to a new piece of code which modelled the inverter itself. The configuration of power sink and source would depend on the kind of inverter being modelled.



The initial case tackled was a grid-intertied inverter without battery capability. In operation, this device simply takes the maximum possible power (using MPP tracking) from the PV modules, and dumps it into the grid. Therefore, the start node should be represented by a power sink that eats all the power available at a node. The end node should be a power source that emits whatever power went into the start node, less the losses in the inverter.

The main trick in this respect was specifying “all the power available at a node”. PFS has a few different node types. It is possible to have the node voltage fixed or floating. In the case where it is fixed, the solver imports or exports extra power to the node as needed to preserve the energy balance. The fixed voltage node is normally used to model the power source in an electrical network, because it looks like an ideal voltage source. For this same reason, it also functions as a power sink of the kind required to model the inverter input. Using it as such is just a matter of accounting, that is, picking up the imported/exported power value of the node, excluding it from the normal post-processing calculations (so that it does not look as if the power is leaving the network) instead diverting it to the input of the inverter model.

The only disadvantage to this method is that the inverter input voltage is fixed, hence it stays the same at all times. This is not an accurate model of a real inverter, where the voltage must vary for MPP tracking. Hence, it precludes use with an accurate PV model. This was not a problem in the initial tests, because the existing PV model is idealised with a built-in MPP tracker. It does not really care about the voltage of its output node, and always outputs the maximum power regardless. So, the inverter input node could be fixed at a nominal input voltage selected by the user.

The end node of the inverter, on the other hand, is just a power source. This is implemented using the same routine as for a load, but with the sign reversed. Instead of the “load” getting its magnitude by the ordinary method (i.e. from a model description input by the user or from the building/plant side in the case of a hybrid component) it is set by the output of the inverter model.

To summarise, then, the inverter model is not really part of the power flow network. The input and output nodes are boundary nodes of the network. The results post-

processing was altered to disguise this fact and make it look as if the power flowing through the inverter stayed within the network, instead of leaving it and entering again.

#### ***E.4. Adding new power components***

The inverter itself was modelled as a lookup table of efficiency vs. power. 6 points were specified representing 0, 20, 40, 60, 80 and 100% power. A linear interpolation algorithm was used to find the efficiency at whatever the power level happened to be.

#### ***E.5. Results***

The inverter model was tested on an existing ESP-r exemplar which included PV (the ELSA Building). The efficiency vs. power lookup table was taken from experimental tests of a Mastervolt “Sunmaster 130” grid-intertied inverter. Since the PV capacity of the exemplar building was very large (approx. 15 kWp) the Sunmaster model was simply scaled to 15kW. This is not strictly speaking very accurate, since a larger inverter would probably have a slightly different characteristic, however it was adequate for the purposes of testing the simulator.

The inverters were simply added in series with each PV array. Fig E.1 shows an example output from the simulation: the inverter power output (top trace) is shown along with the losses (bottom trace) over a period of one day. The small “blips” at around 06:30 and 17:30 were unexpected. They were most probably caused by a bug of some sort. Unfortunately, further development and debugging was beyond the scope of this work.



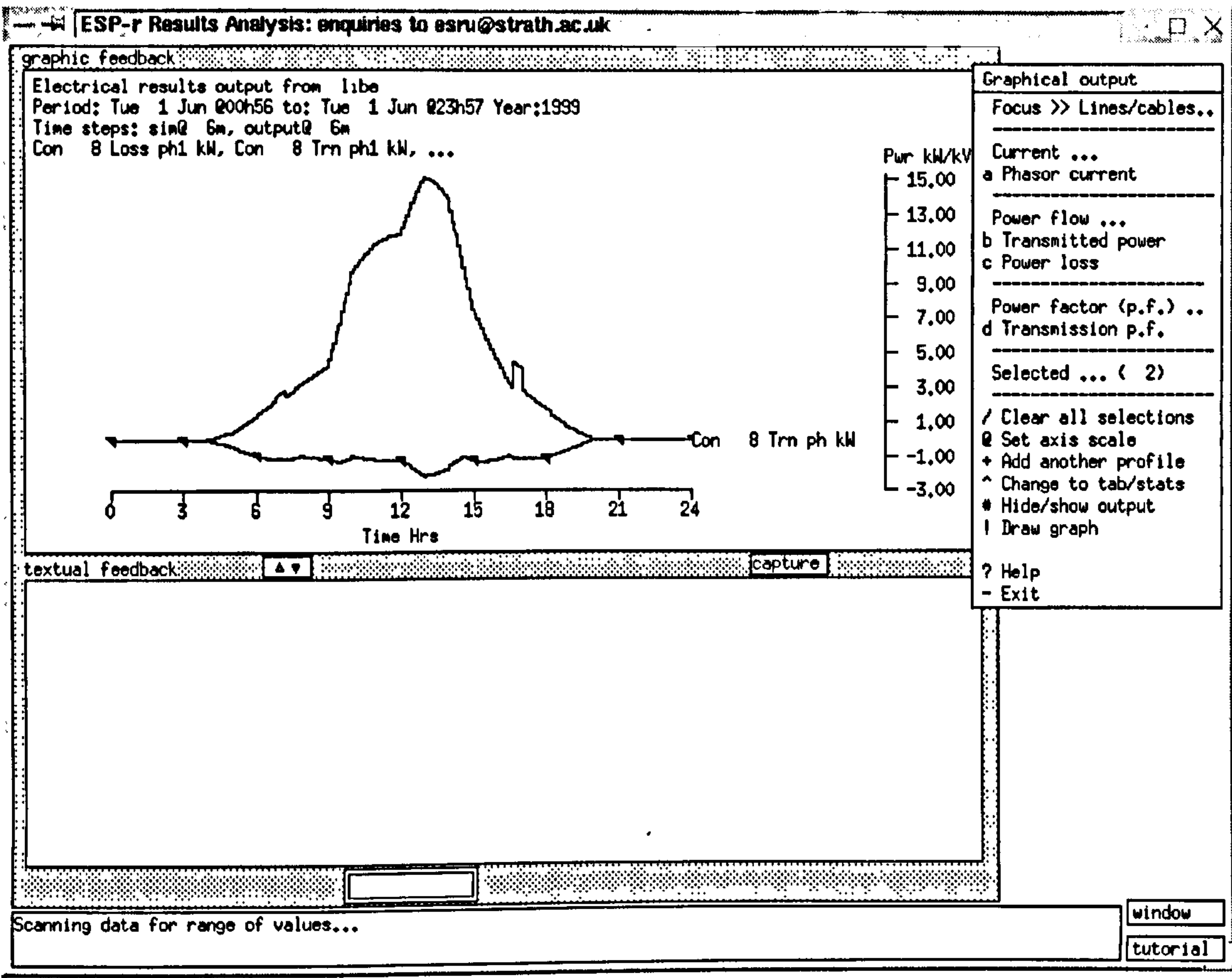

(Fig. E.1: Results analysis from ESP-r showing inverter power output and losses)

## **E.6. Conclusions**

This project provided a rudimentary model of an electrical inverter for the ESP-r simulation environment. It also threw up a lot of difficulties with using ESP-r for the purpose envisaged. It became obvious that a great deal more development work would be required before ESP-r would be capable of modelling the kind of renewable energy systems in question. In particular, control algorithms for electrical network components would need to be added, and to judge by the amount of effort required to implement the inverter model, it seemed that this would be an extremely long and difficult task. Therefore, this line of work was abandoned. A more fruitful alternative might have been to use ATP (the Alternative Transients Program, see [4]) as the electrical simulator, and to create a linkage so that ESP-r provides the boundary conditions, i.e. the amount of renewable energy being generated at any given instant.

## **E.7. Acknowledgements**

I would like to thank Nick Kelly and Iain Macdonald for assistance with ESP-r development, and with the Power Flow Simulator code.

## **E.8. References**

1. Clarke, J. A., 'Energy Simulation in Building Design', Butterworth-Heinemann, London, 2001.
2. Kelly, N. J., 'Towards a Design Environment for Building-Integrated Energy Systems: The integration of electrical power flow modelling with building simulation', University of Strathclyde, 1998.
3. Energy Systems Research Unit website, University of Strathclyde, <http://www.esru.strath.ac.uk/>, 2002.
4. Alternative Transients Program website, Michigan Technical University, <http://www.ee.mtu.edu/atp/>, 2001.



## **Appendix F: Hybrid PV System Controller**

This Appendix contains details of a control unit that was designed for a Hybrid PV project in Glasgow.

### ***F.1. About the system***

Partick Housing Association commissioned this project to demonstrate commitment to the environment. The roof of a tenement block was fitted with two arrays each of eight BP Saturn PV modules. Each module gives 80 Wp, and each array can supply up to 25A at 12V in full sun. The arrays are fitted with a heat recovery system. Fans circulate air over the back surface of the modules, and the heated air is passed into the entrance hall and stairway of the tenement. Electrical energy is stored in six 12V, 75Ah lead-acid batteries. The system supplies power for the door entry systems and TV distribution amplifiers in three tenement blocks.

### ***F.2. Controller requirements***

The controller had to function as an ordinary charge controller, i.e. prevent the batteries from under- or overcharging. It also had to control the heat recovery fans so that they did not run when there was insufficient heat. Battery charge control was to be achieved by turning on a dump load when the voltage became too high, and turning on a backup charger (powered by mains electricity) when it became too low. Fan control was according to the PV array current; the fans were turned on when the current rose above a threshold.

### ***F.3. Design considerations***

For various reasons which will not be covered here, a decision was made to use a traditional analogue-type circuit instead of a microcontroller. A voltage- or current-controlled switch was designed, and four units of it were used for battery charger, dump load, and two fans respectively.

#### ***F.4. Theory of operation***

The basic function performed by the controller is to change the state of a switch according to the value of a voltage or current input. To avoid unnecessary switching, and to implement certain functions, hysteresis is used: in other words, the value of input that turns the controller ON if it was previously OFF is made different to the value that turns it OFF if it was ON. So, for instance, the controller might be set to turn a battery charger ON when the battery voltage falls below 11V, and then switch it OFF when the voltage exceeds 14.4V indicating that the battery is full.

#### ***F.5. Circuit descriptions***

##### **F.5.1. Controller module**

(Refer to Fig. F.1)

The input signal is first amplified by differential amplifier U1, which removes common-mode interference. R1-R4 set the gain of this stage while C1, C2 help to filter out noise. Where a high gain is not required, U1 can be left off the board, and a spare op-amp used instead by fitting J3, J9 and J10.

The amplified signal is fed to the meter switch via R5, and to comparators U2B, U2C. Here it is compared with upper and lower thresholds set by trim pots VR1 and VR2. The threshold voltages are also fed to the meter switch. A stable 3.75V reference is provided by 2.5V reference diode U4 and amplifier U2D. J7 and J8 select the lower extent of the trimpot adjustment to be either 0V (J7) or 2.5V (J8). R13, R14, R15, R16 provide 0.1% hysteresis to help eliminate any remaining noise. The comparator outputs are used to set or reset the S-R latch U3B, U3D, via R17, D1, R18, D2 which convert the bipolar outputs of the comparators to an 0-5V signal. U3A and associated components provide a power-on reset pulse to initialise the latch to a known state. Either the Q or Q' output (depending on which of R21 or R23 is installed) is used to drive power transistor Q2, via predriver Q1, which also lights an indicator LED. If R23 is installed then Q2 and the LED will be ON when the input exceeds the upper threshold (set by VR1) and will go OFF when the input falls below the lower threshold. The power-on initial state will be OFF. If R21 is installed instead, the opposite will happen; the output will be ON below the lower threshold



and OFF above the upper one, and the initial state will be ON. Only one of the two resistors should be fitted.

### F.5.2. Power supply/metering module

(Refer to Fig. F.2)

This module supplies +/- 5V to the other boards and also processes the meter point signals to drive two standard 0-10mA meters. U1 is a standard 3-terminal regulator that reduces the 12V input to 5V. The negative rail is generated by a miniature DC-DC converter, U3. This unit has a maximum input of 14V, but under certain conditions the battery voltage may be more than this. Q1-Q3 and ZD1 form a simple regulator circuit that limits the DC-DC converter input to around 13.7V. The output of the converter is nominally -12V, and is regulated to -5V by U2.

The meter amplifier section is based around U1, a quad op-amp. U5 provides a 2.5V reference which is buffered by U1A to increase the current capability. Likewise, U1B buffers the measured value input from the voltage meter switch. The meter connects between U1A and U1B outputs and so shows the difference between them. This gives an expanded scale where 0% is 10V at the voltage controller input and 100% is 15V.

The current meter operates in a similar way, except that an expanded scale is not required, so the negative end of the meter is grounded.

### F.5.3. System wiring

(Refer to Fig. F.3)

The complete system consists of four controller boards (two configured as voltage controllers and two as current controllers) one power supply/meter board, three meters, two six-way meter switches, and four relays. The third meter always reads Array 2 current. It is not connected to the meter board but directly to the Array 2 current shunt input, with a series resistor for correct scaling. The relays are provided with flywheel diodes to clamp back EMF, and contact suppressors to reduce spikes when switching inductive loads.

## ***F.6. Modifications***

Meter scale resistors on the metering board were replaced with 10-turn trimmers to aid calibration of meters. Another 10-turn trimmer was added to the voltage reference for adjustment of the voltmeter offset.









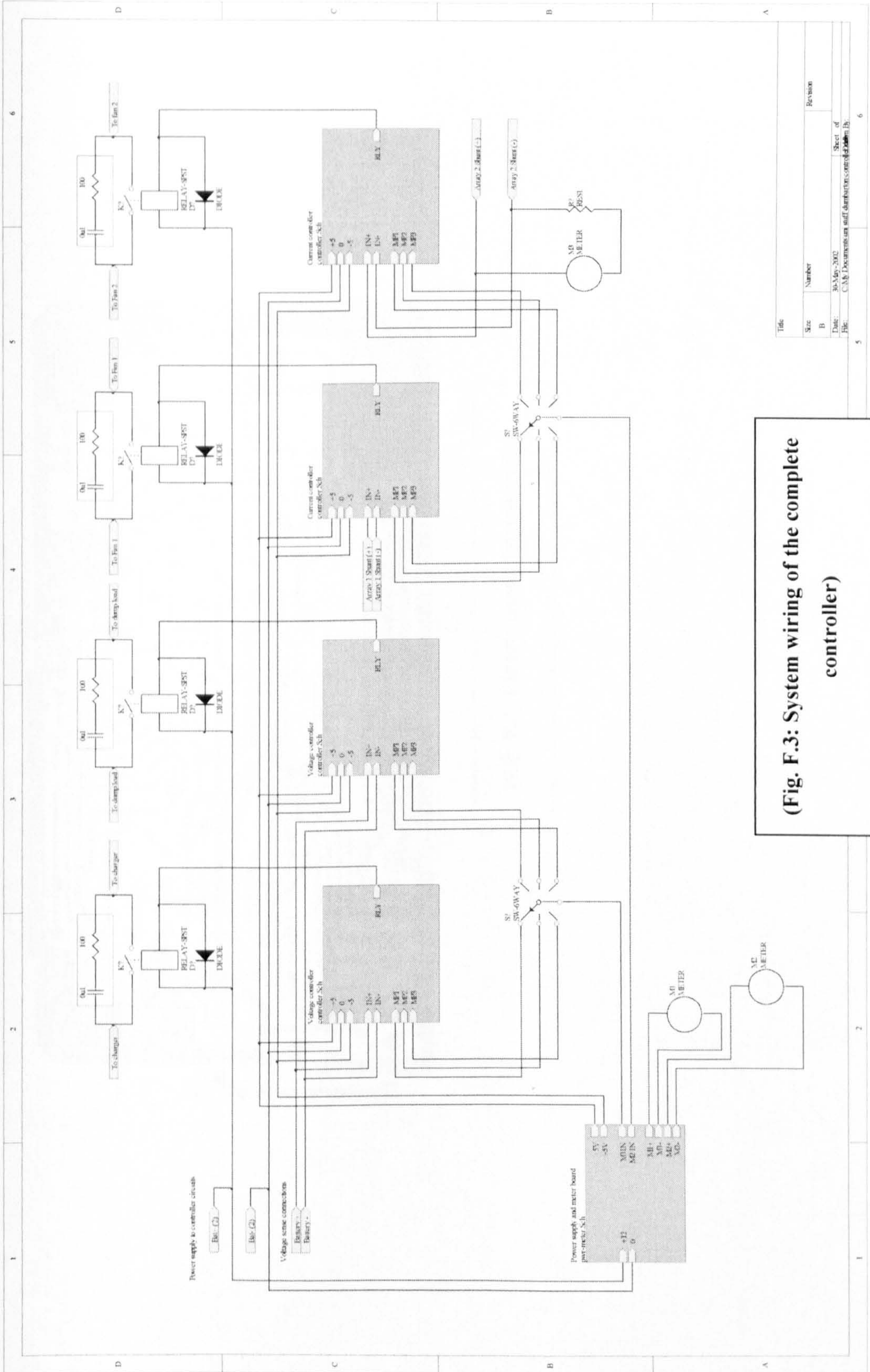

**(Fig. F.3: System wiring of the complete controller)**

Title	
Size	Number
B	
Date:	Rev: 2002
File:	C:\My Documents\staff\distribution\controller\fig F.3
	Sheet of
	6

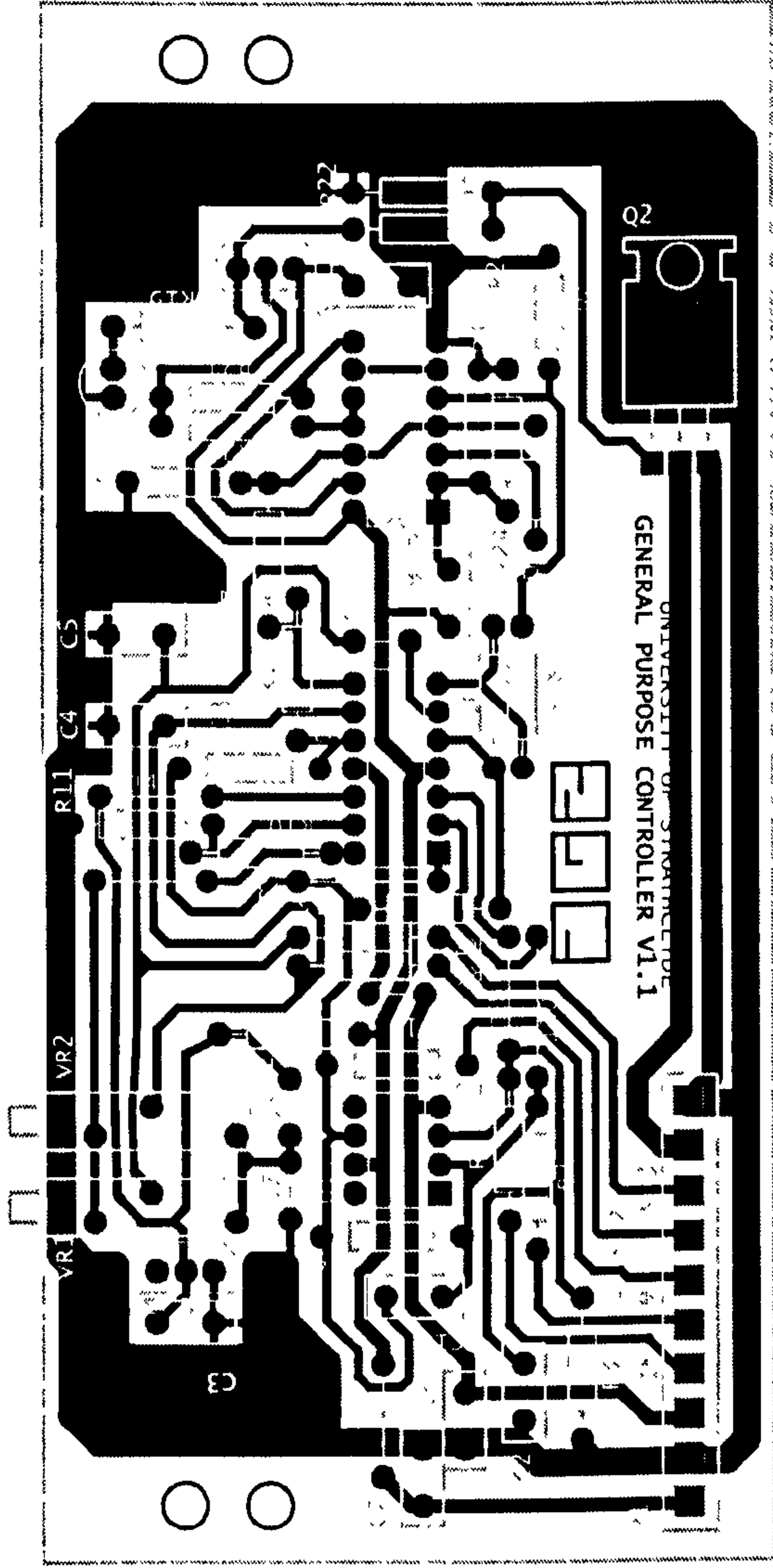

(Fig. F.4: Circuit board for controller)



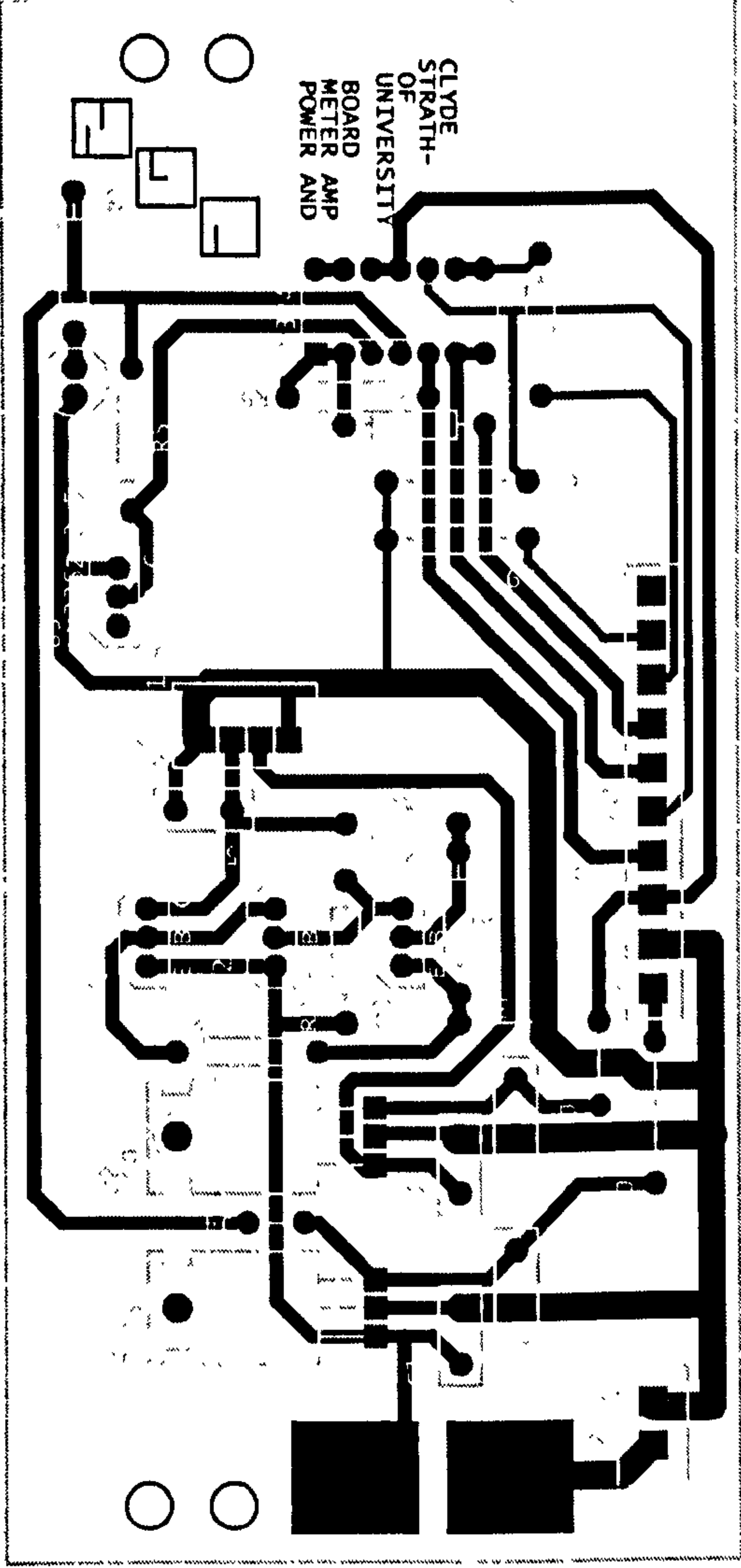

(Fig. F.5: Circuit board for power/meter module)

## **Appendix G: How LabVIEW works**

The National Instruments LabVIEW system was used extensively for this work. LabVIEW is not very well known outside the fields of data acquisition, instrumentation and signal analysis. Accordingly, it was thought that a review of the capabilities and operating principles of LabVIEW would be of use to the reader, if only to help in making sense of the LabVIEW block diagrams printed throughout this work.

### ***G.1. What is LabVIEW?***

LabVIEW is a software program (available for Windows, MacOS and Linux operating systems) intended for data acquisition and analysis tasks. However, it is based on a graphical programming model that allows it to be used for almost anything that other programming languages can do, with the exception of object-oriented programming. It is a commercial product, as opposed to open-source products.

### ***G.2. What is it used for?***

LabVIEW is mainly used in scientific and engineering applications. A very popular use is for the automation of data acquisition, analysis, and testing procedures in research and industry. In these applications, it is usually used to operate, and analyse data from, data acquisition cards or GPIB-enabled scientific instruments connected to a computer. Complex experiments can be carried out with far greater speed and convenience than if the instruments were operated by hand.

Within the University of Strathclyde, applications for LabVIEW have included:

- Monitoring and control of cogeneration plant
- Real-time control of a robot arm
- Sound and vibration analysis
- Weather datalogging
- Recording and analysis of electromyograms



### G.3. Basics of LabVIEW programming

The idea behind graphical programming is that programs are not written, but drawn by placing graphical icons and interconnecting them with lines, all using the mouse. As an example, we can take the famous ‘Hello World’ program:

```
/* The Hello World program */
#include <stdio.h>

int main(void)
{
    printf("Hello world\n");
}
return (0);
```

(Fig. G.1: The Hello World program, in ‘C’)

‘Hello World’ is given above as it would appear in a conventional text-based programming language. It can equally well be written (or rather drawn) in LabVIEW, where it looks like this:

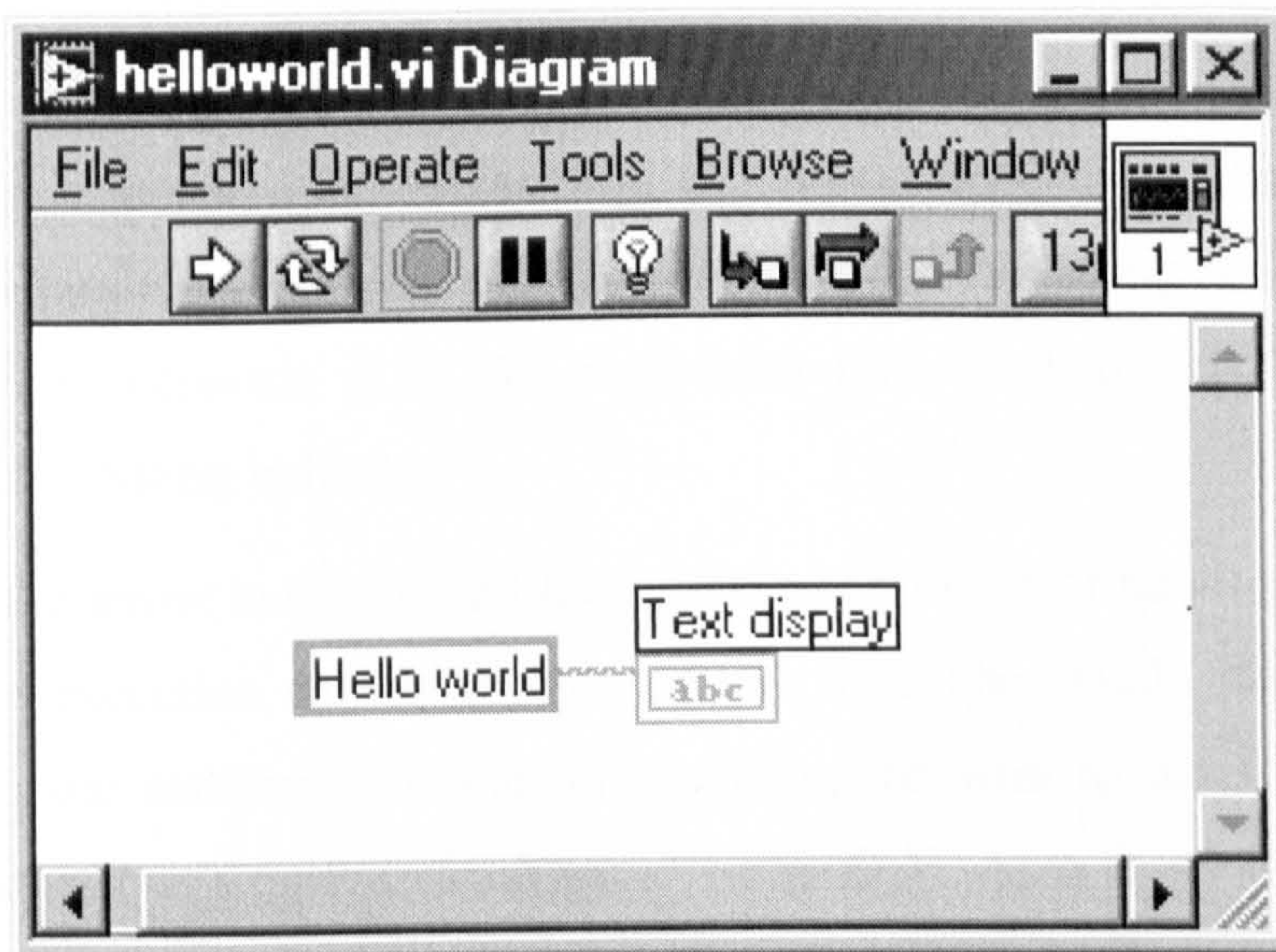

(Fig. G.2: The Hello World program, in LabVIEW)



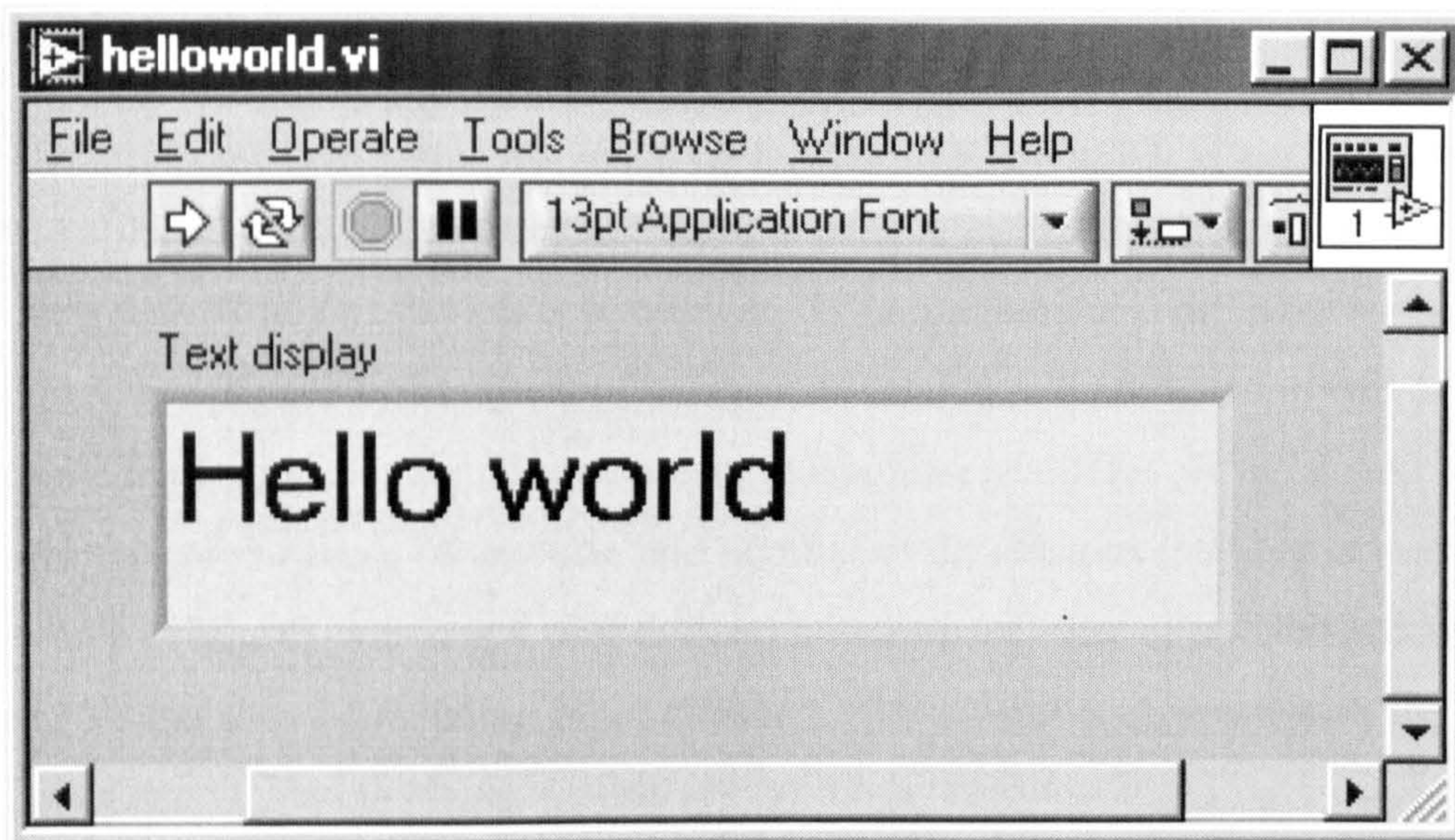

(Fig. G.3: Output from the Hello World program)

Creating a LV program is really more like building a piece of electronic apparatus than writing a conventional program, a deliberate ploy to make it more accessible to engineers and scientists. To clarify: Fig. G.2 shows the “block diagram” of the program. The box containing the phrase “Hello World” is a string constant. A small piece of “wire” connects it to the right-hand box labelled “abc”, which is a “terminal” for a “string indicator”.

Clicking on the arrow in the top left-hand corner causes the program to be compiled and run. The execution can be thought of like this: The “Hello World” string is emitted from the constant box and travels along the wire to the string indicator, which then displays it on the “front panel” (Fig. G.3). As a finishing touch to the electronics metaphor, the complete program is called a “Virtual Instrument” (VI).

As the above description suggested, LV is built on a dataflow model. Unlike normal programming languages, where the order of execution of different code segments is controlled by the order in which they appear in the listing, in LV an object executes whenever data arrives at its input terminal. The dataflow model is very intuitive and convenient for datalogging and analysis applications, which involve moving quantities of data through successive processing operations. However, it can be bothersome in a few other situations, e.g. when writing multithreaded programs.



#### **G.4. Data types**

The wires that carry data around a LabVIEW block diagram are roughly equivalent to variables or data structures in a normal programming language. A single wire can carry data of any of the kinds familiar to 'C' programmers. For instance, it may hold an integer (signed or unsigned of various bit depths), a floating-point real or complex number of single or double precision, a Boolean true/false value, a text string, an array of any of these of any size and number of dimensions (subject to memory), or even a "cluster", which is a user-defined bundling together of any desired mixture of any of the above (including other clusters). The cluster is equivalent to the "typedef struct" in 'C'.

#### **G.5. Conditional execution**

LabVIEW has conditional structures equivalent to all of the familiar ones in conventional languages, such as do/while, for/next, case, etc. They appear as boxes, and the code to be repeated/selected is placed inside the box. Case structures can be confusing, because only one case is visible at a time. (See G.9)

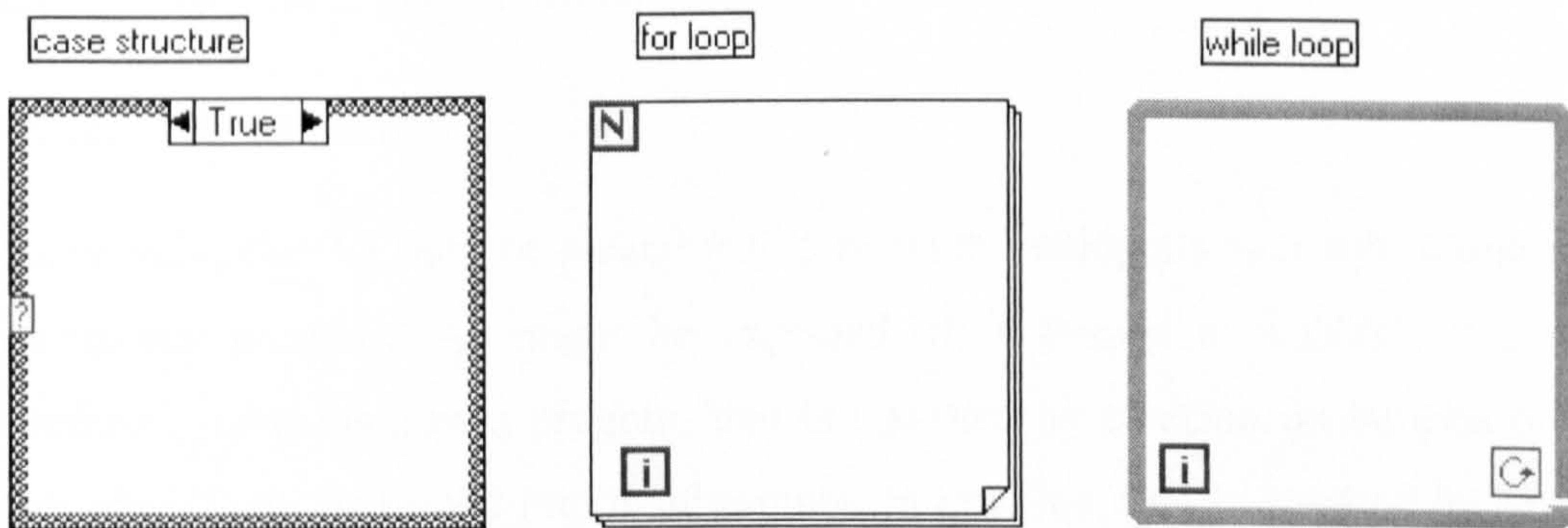

(Fig. G.4: Some conditional structures in LabVIEW)

#### **G.6. Math functions**

Since it is used in datalogging and analysis, LabVIEW has very good math functions. The built-in functions are the same as would be expected in any scientific language such as FORTRAN. However, there are many more routines (or subVIs, see G.8) provided for applications such as statistics, signal analysis, and the like. User-defined



math functions can also be written in a C-like syntax and embedded in the VI using “formula nodes”.

### ***G.7. Multitasking***

LabVIEW is a multitasking system. First of all, it is possible for several parts of the same VI to be running simultaneously. Indeed, if one part of the block diagram is disconnected from the rest, and so is not told when to execute by dataflow, it will execute in parallel with the rest of the diagram. This can be useful, as an easy way of writing multithreaded programs. However, it can also be a source of confusion.

The dataflow model is useless when communicating between multiple threads. To work around this, LabVIEW provides some functionality similar to traditional ‘C’, such as variables of global/local scope, semaphores, etc. Unfortunately, it is easy to get into a tangle when using these alongside dataflow programming, whose order of execution is not always obvious.

It is also possible for several VI s to run simultaneously on the same computer. They may be run independently, with each preserving its own environment, or they may share data through global variables.

### ***G.8. Modularity***

Alternatively, one VI may be placed inside another, analogous to a subroutine in a conventional program. As might be expected, it is termed a “subVI”. It is not immediately obvious how a program that is operated by clicking on buttons on its “front panel” can be turned into a subroutine. In practice, this is handled by giving every VI a second, shrunken version of its front panel, termed the “icon”. The icon sports “terminals”, one corresponding to each control or indicator of the original front panel. When a VI is used as a subVI, its icon appears on the block diagram of the parent VI, and by connecting wires to the terminals, data is passed to and from the subVI.

### ***G.9. Documenting LabVIEW programs***

As a consequence of the graphical model, LV programs (or VI s) are rather more difficult to reproduce in print than conventional listings. There are two main



problems. First is that it is sometimes impossible to display all of the program in a single picture. In some cases, several elements must overlap and so only one of them can be seen at a time. LabVIEW's documentation generator works around this by printing all the hidden parts separately, but this can still be confusing, since it is not always obvious where these parts were hidden in the first place.

Also, where subVIs are used (very often in practice), each subVI appears only as an icon. The block diagram of the subVI must be listed separately, which again may be counter-intuitive.

The second problem is that colour is sometimes important to the understanding of a program. LV datatypes are identified by colour, for instance, strings are pink, Boolean true/false values are green, and floating-point real numbers are orange. (If this had been a colour publication, you could have seen that all the objects in Fig. G.2 were pink.) Colour is not indispensable, however; for instance, the manual that comes with LabVIEW, which includes printed "source code", is in black and white.

Unfortunately, LabVIEW has no alternative way of representing its VIs. The structure and appearance of the block diagram and front panel are saved together in a binary ".vi" file of a proprietary format. This file is essentially the source code, and the only way of viewing/editing/compiling/running it is through the LabVIEW GUI itself. Some other graphical languages do translate the graphical commands into human-readable text-based code, often 'C' or similar, as an intermediate step in the compilation.

### **G.10. References**

For further information, the on-line help within LabVIEW itself is probably the most valuable source. There is also a lot of information available at the National Instruments website: <http://www.ni.com/labview/>

## Appendix H: LabVIEW programs

This appendix provides information about the LabVIEW programs written in this work. All of the programs may be downloaded from the ESRU website at <http://www.esru.strath.ac.uk/>

### H.1. The testbed software

A description of the individual programs that drove the experimental testbed.

Filename	Description	Comments
Bm2.vi	BatMan battery manager version 2. Buys and sells power to control battery state of charge.	Full listing of bm2 (H.2.1) and SOC estimator subVI (H.2.2)
Daq2.vi	Data acquisition version 2. Operates DAQ hardware and makes results available to all other programs through global variables.	
Dumpcon.vi	Agent representing the dumpload in the DC market. Receives data on dumpload current from daq2	
Grid2.vi	Agent representing the power grid in the AC market.	
Invman7.vi	Smart inverter management, version 7. Buys power from DC market and sells to AC market.	Listing in Section H.2
Load2.vi	Agent representing a load. Used for testing.	
Matching15.vi	REDMan dispatching algorithm, version 15.	Listing in Section H.2.
Regen.vi	Agent representing RE generators	



	(PV/wind turbines) in the DC market. Calculates available power using data from daq2	
Server3.vi	REDMan dispatching server, version 3. Handles communication between agent programs and dispatcher (matching15) for the DC market.	
Copy of server3.vi	Same as server3 but for the AC market.	
Socket2.vi	Smart socket software, version 2. Agent representing loads connected to the smart socket strip.	
Statistics.vi	Calculates hourly, daily, and weekly RE generation statistics. Receives data from daq2	

## H.2. Block diagrams (source) of selected Vis

### H.2.1. BatMan battery management (bm2.vi)

bm2.vi

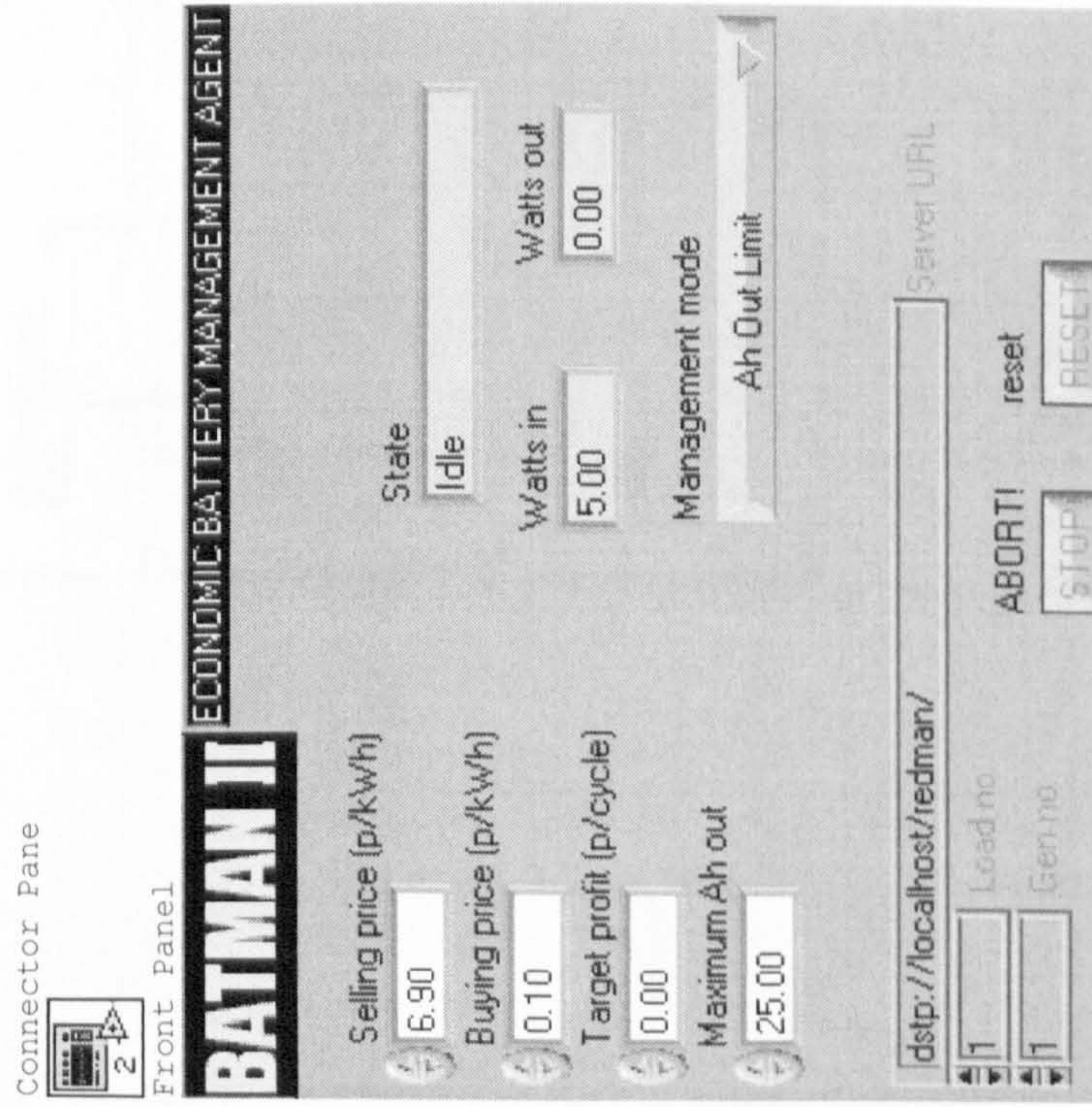





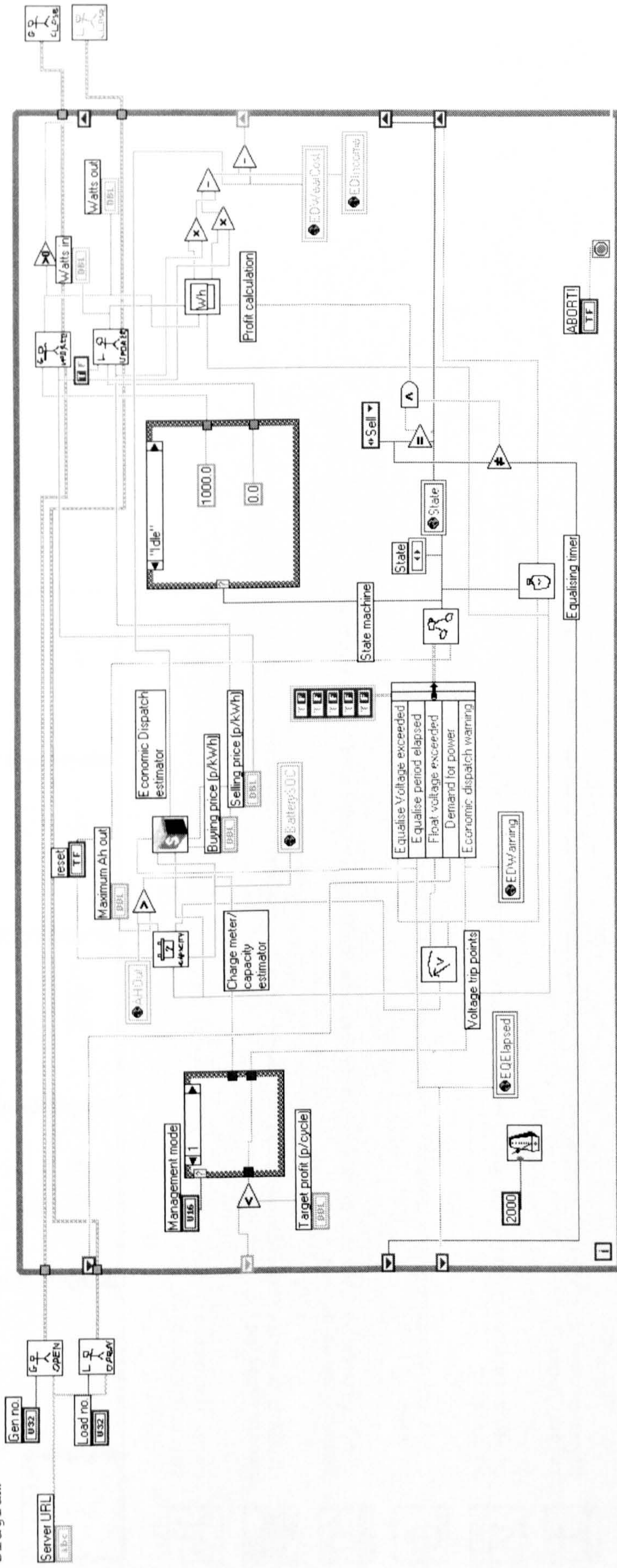



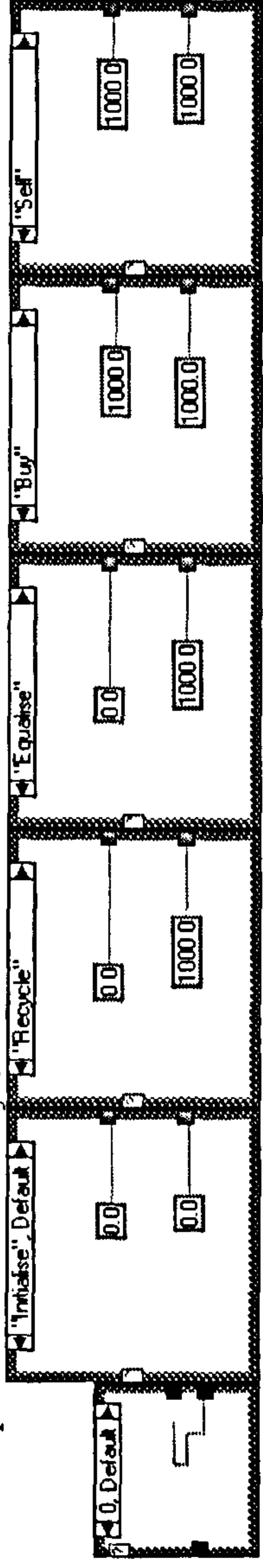

Block Diagram





Hidden parts of block diagram

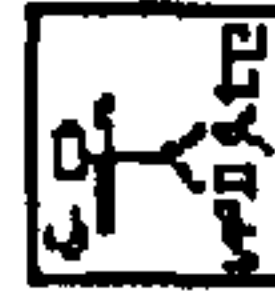

List of SubVIs

-  `bmstatemachine.vi`  
C:\My Documents\labview backup\labview\labview\phd\batman][\bmstatemachine.vi
-  `bmestimator.vi`  
C:\My Documents\labview backup\labview\labview\phd\batman][\bmestimator.vi
-  `bmchargemeter_sub.vi`  
C:\My Documents\labview backup\labview\labview\phd\batman][\bmchargemeter\_sub.vi
-  `bm_time.vi`  
C:\My Documents\labview backup\labview\labview\phd\batman][\bm\_time.vi
-  `bm_volt.vi`  
C:\My Documents\labview backup\labview\labview\phd\batman][\bm\_volt.vi
-  `rm_gen_update.vi`  
C:\My Documents\labview backup\labview\labview\phd\realthing\rm\_gen\_update.vi
-  `rm_load_update.vi`  
C:\My Documents\labview backup\labview\labview\phd\realthing\rm\_load\_update.vi
-  `rm_gen_open.vi`  
C:\My Documents\labview backup\labview\labview\phd\realthing\rm\_gen\_open.vi

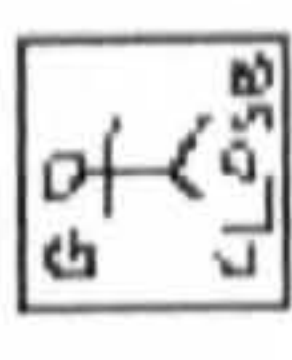
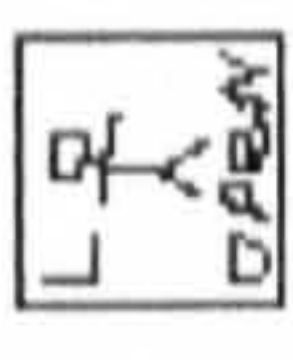
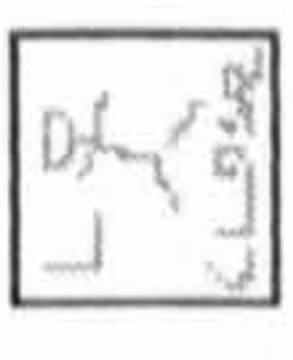
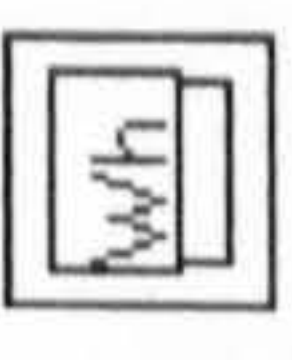

	rm_gen_close.vi C:\My Documents\labview\labview\labview\phd\realthing\rm_gen_close.vi
	rm_load_open.vi C:\My Documents\labview\labview\labview\phd\realthing\rm_load_open.vi
	rm_load_close.vi C:\My Documents\labview\labview\labview\phd\realthing\rm_load_close.vi
	bmenergymeter.vi C:\My Documents\labview\labview\labview\phd\batman][\bmenergymeter.vi
	sysglobal.vi C:\My Documents\labview\labview\labview\phd\realthing\sysglobal.vi
	bmstatusglobal.vi C:\My Documents\labview\labview\labview\phd\batman][\bmstatusglobal.vi

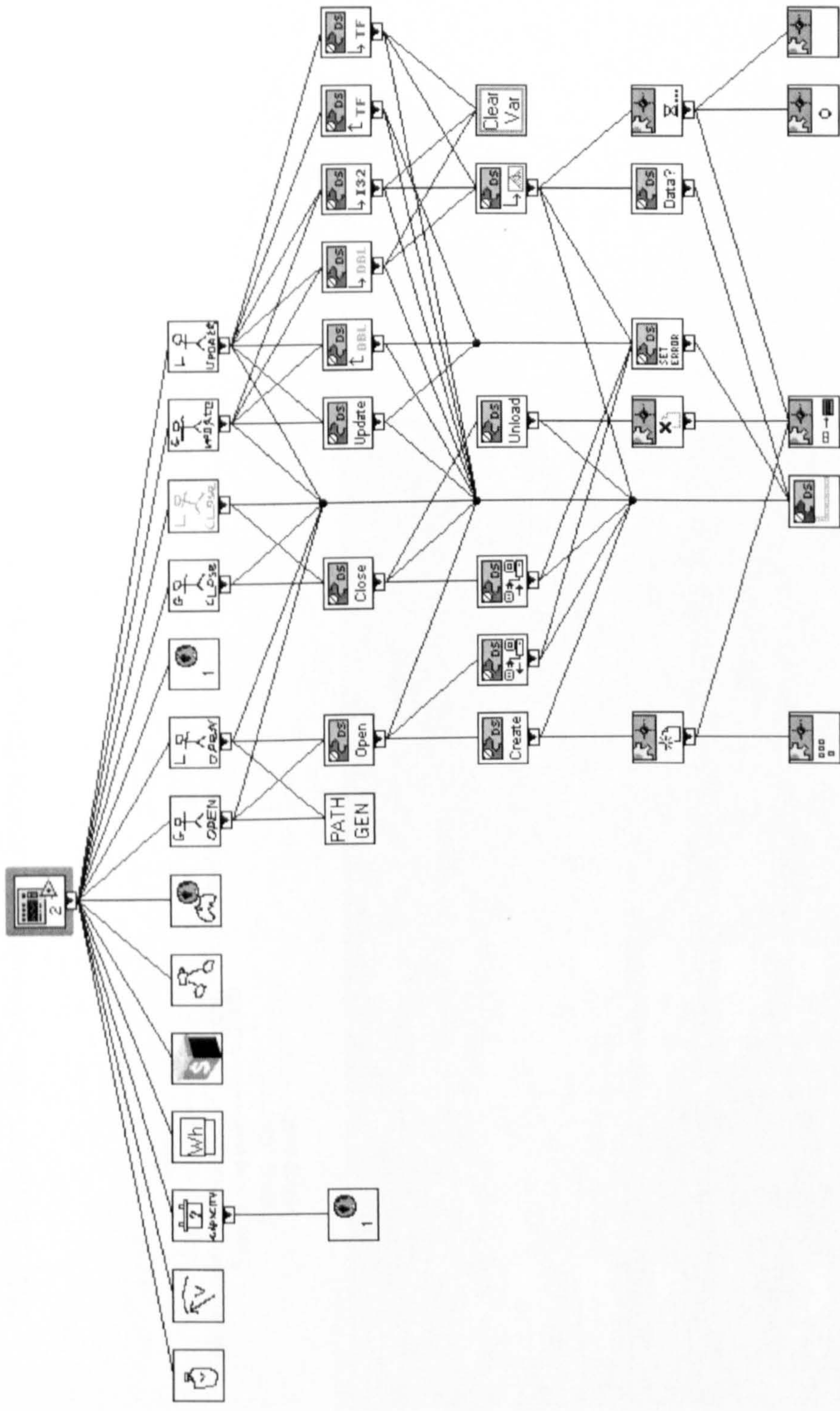



## H.2.2. BatMan state-of-charge estimator (bmestimator.vi)

bmestimator.vi

Connector Pane

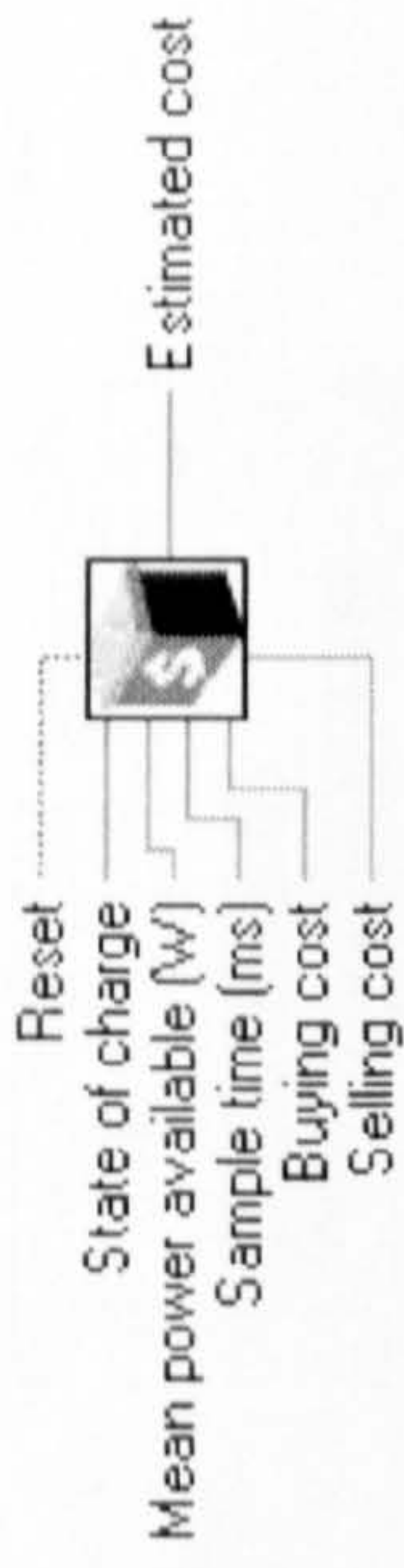

Front Panel

**BATTERY OPERATING COST ESTIMATOR V1.0**

BATTERY DATA	INPUTS	SYSTEM VARIABLES
Nominal voltage (V) 24.00	State of charge 0.00	Peak Depth Of Discharge 0.00
20-Hour Capacity (Ah) 75.00	Mean power available (W) 30.00	Integrated DOD 0.00
First cost (£) 60.00	Sample time (ms) 0.00	<b>RESET</b>
Standing time to failure (h) 1000.00	Buying cost 0.00	
Deep cycles to failure 200	Selling cost 0.00	Estimated cost 0.00



Block Diagram

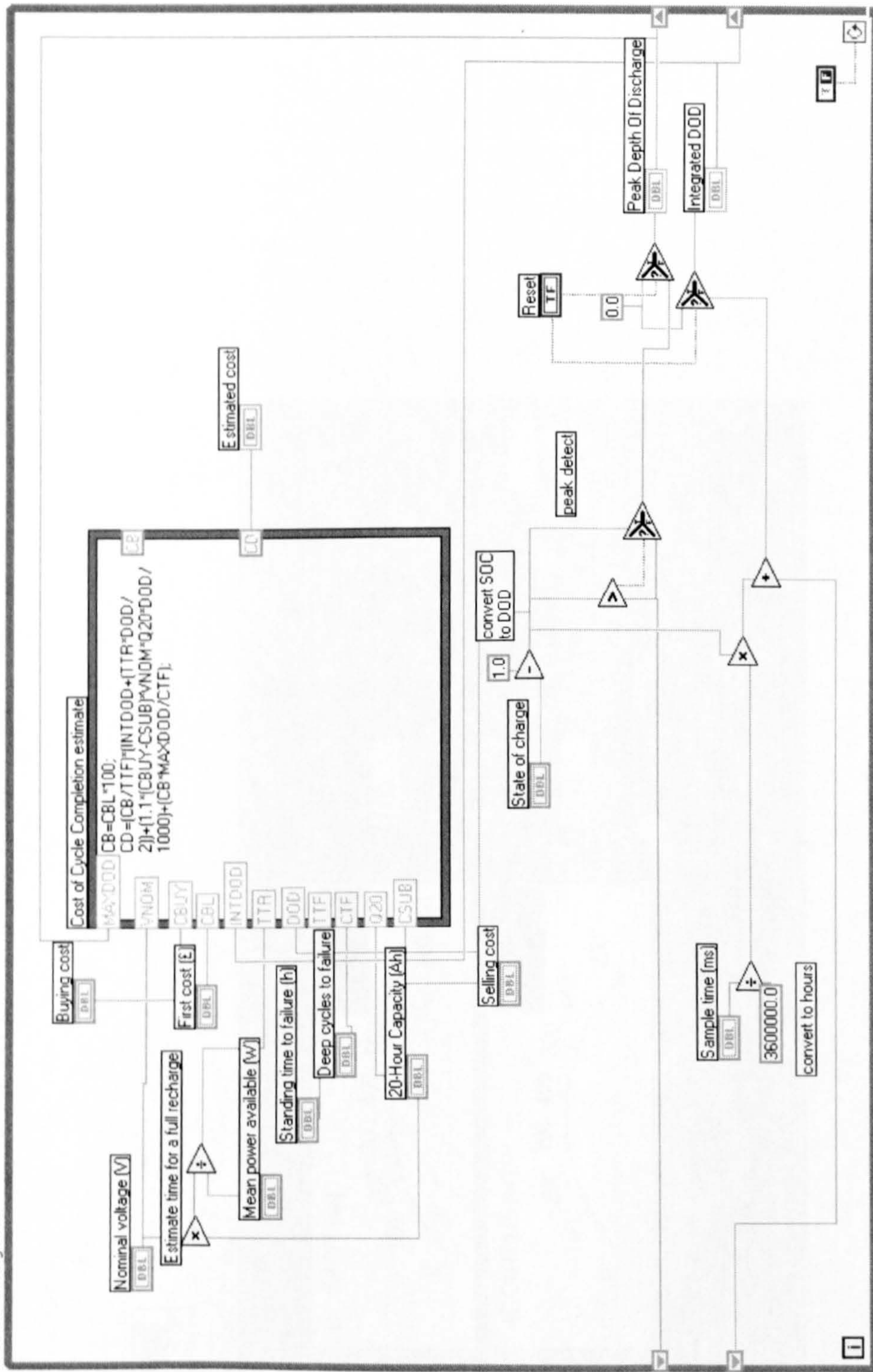



### H.2.3. Smart inverter management (invman7.vi)

invman7.vi

Connector Pane



Front Panel

**SMART INVERTER AGENT**

stop  sell

Buying price  ED BuyPrice  Efficiency  Sell every

DC INPUT (W)  AC OUTPUT (W)

Hand control

Mode

Server URL (load-side domain)  Load no.   
Server URL (gen-side domain)  Gen no.









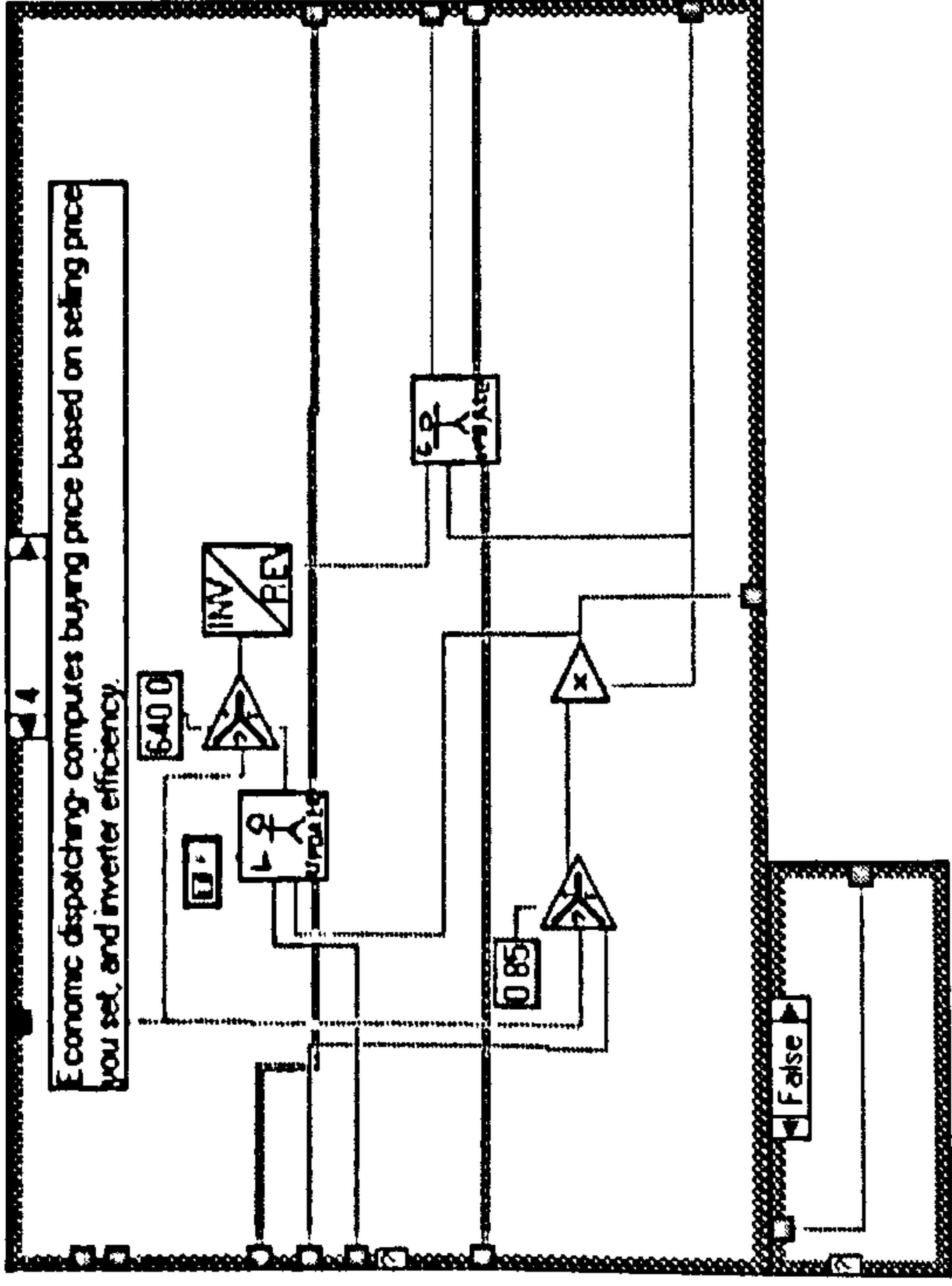



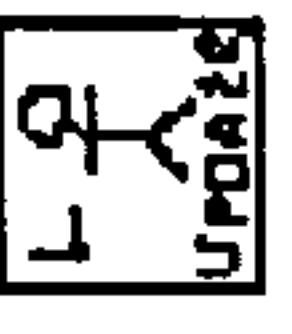

List of SubVIs

- 
 rm\_gen\_open.vi  
 C:\My Documents\labview backup\labview\labview\phd\realthing\rm\_gen\_open.vi
- 
 rm\_load\_open.vi  
 C:\My Documents\labview backup\labview\labview\phd\realthing\rm\_load\_open.vi
- 
 rm\_gen\_update.vi  
 C:\My Documents\labview backup\labview\labview\phd\realthing\rm\_gen\_update.vi
- 
 rm\_load\_update.vi  
 C:\My Documents\labview backup\labview\labview\phd\realthing\rm\_load\_update.vi
- 
 rm\_gen\_close.vi  
 C:\My Documents\labview backup\labview\labview\phd\realthing\rm\_gen\_close.vi



	rm_load_close.vi C:\My Documents\labview backup\labview\labview\phd\realthing\rm_load_close.vi
	invcon.vi C:\My Documents\labview backup\labview\labview\phd\demo\invcon.vi
	sysglobal.vi C:\My Documents\labview backup\labview\labview\phd\realthing\sysglobal.vi
	investimate2.vi C:\My Documents\labview backup\labview\labview\phd\realthing\investimate2.vi
	investimaterev.vi C:\My Documents\labview backup\labview\labview\phd\realthing\investimaterev.vi





## H.2.4. REDMan dispatching server (server3.vi)

server3.vi

Connector Pane



Front Panel

<b>REDMAN SERVER</b>	<input type="text" value="dstp://localhost/redman/"/>	Datsocket URL
	<input type="text" value="2"/>	Number of generators
	<input type="text" value="3"/>	Number of loads
<input type="button" value="STOP"/>	<input type="text" value="Solving"/>	Status



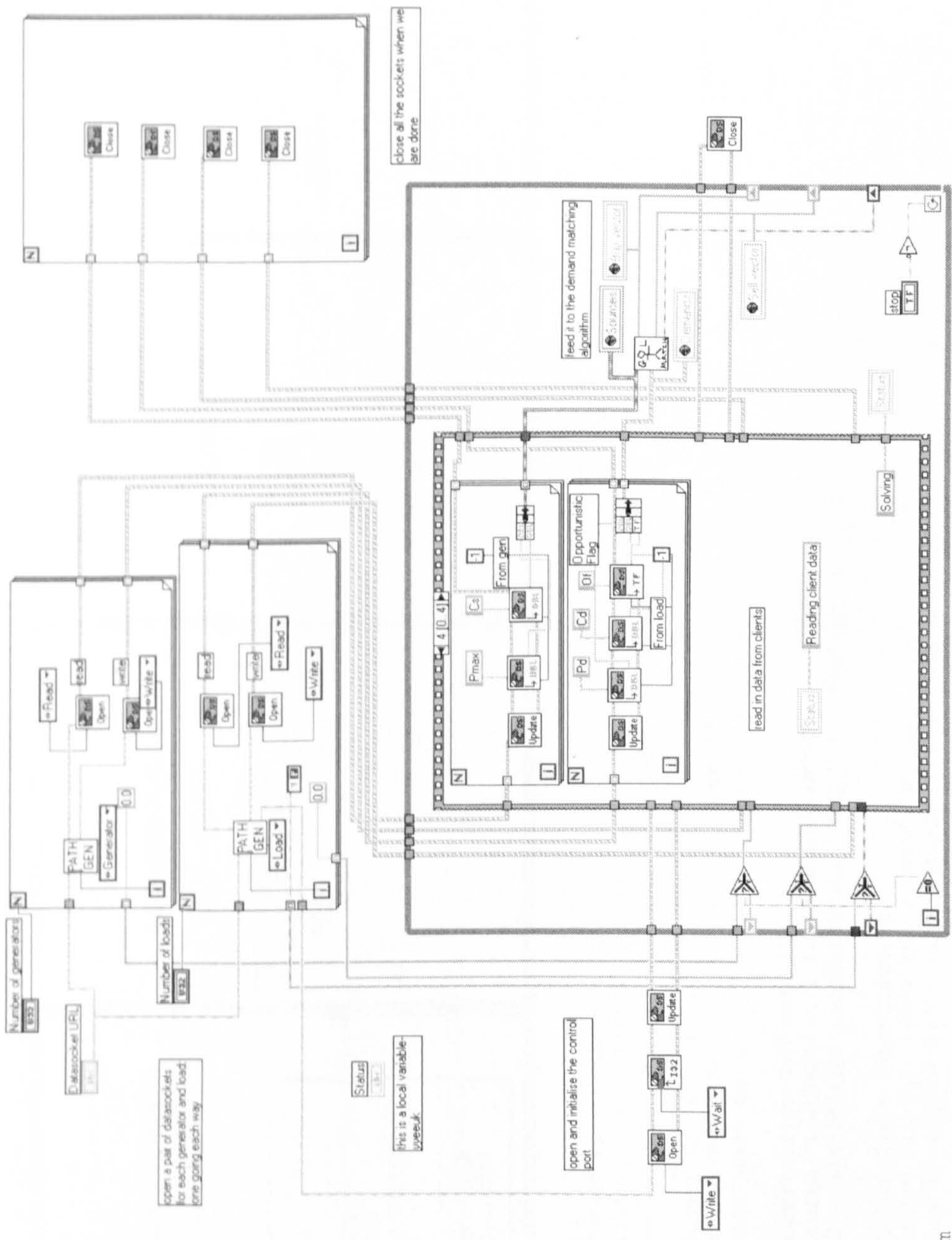





Block Diagram

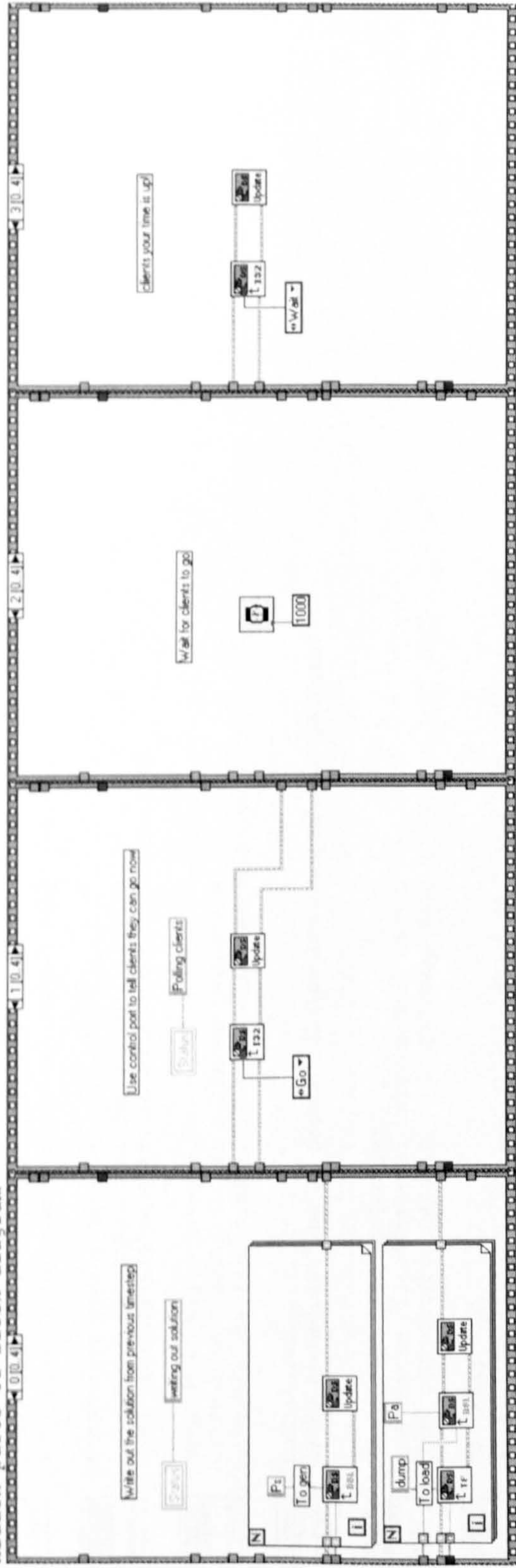

Hidden parts of block diagram

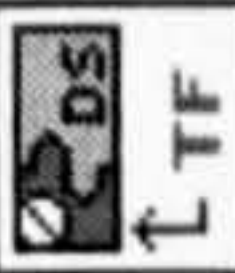

List of SubVIs

-  Open  
DataSocket Open Connection.vi  
C:\Program Files\National Instruments\LabVIEW  
6\vi.lib\platform\datastk.1lb\DataSocket Open Connection.vi
-  DBL  
DataSocket Write Double.vi  
C:\Program Files\National Instruments\LabVIEW  
6\vi.lib\platform\datastk.1lb\DataSocket Write Double.vi
-  TF  
DataSocket Write Boolean.vi  
C:\Program Files\National Instruments\LabVIEW  
6\vi.lib\platform\datastk.1lb\DataSocket Write Boolean.vi
-  Close  
DataSocket Close Connection.vi  
C:\Program Files\National Instruments\LabVIEW  
6\vi.lib\platform\datastk.1lb\DataSocket Close Connection.vi





DataSocket Read Double.vi  
 C:\Program Files\National Instruments\LabVIEW  
 6\vi.lib\platform\datastk.lib\DataSocket Read Double.vi



DataSocket Update Data.vi  
 C:\Program Files\National Instruments\LabVIEW  
 6\vi.lib\platform\datastk.lib\DataSocket Update Data.vi



DataSocket Write Integer.vi  
 C:\Program Files\National Instruments\LabVIEW  
 6\vi.lib\platform\datastk.lib\DataSocket Write Integer.vi

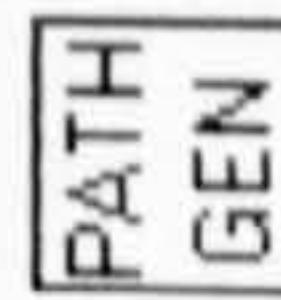

pathgen.vi  
 C:\My Documents\labview backup\labview\labview\phd\demo\pathgen.vi



DataSocket Read Boolean.vi  
 C:\Program Files\National Instruments\LabVIEW  
 6\vi.lib\platform\datastk.lib\DataSocket Read Boolean.vi

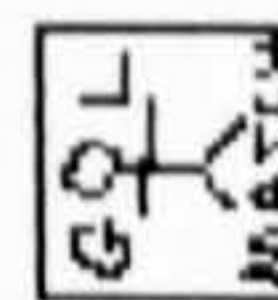

matching15.vi  
 C:\My Documents\labview backup\labview\labview\phd\demo\matching15.vi

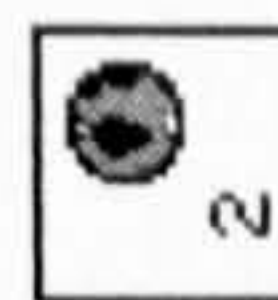

rm\_global\_0.vi  
 C:\My Documents\labview backup\labview\labview\phd\realthing\rm\_global\_0.vi



Position in Hierarchy

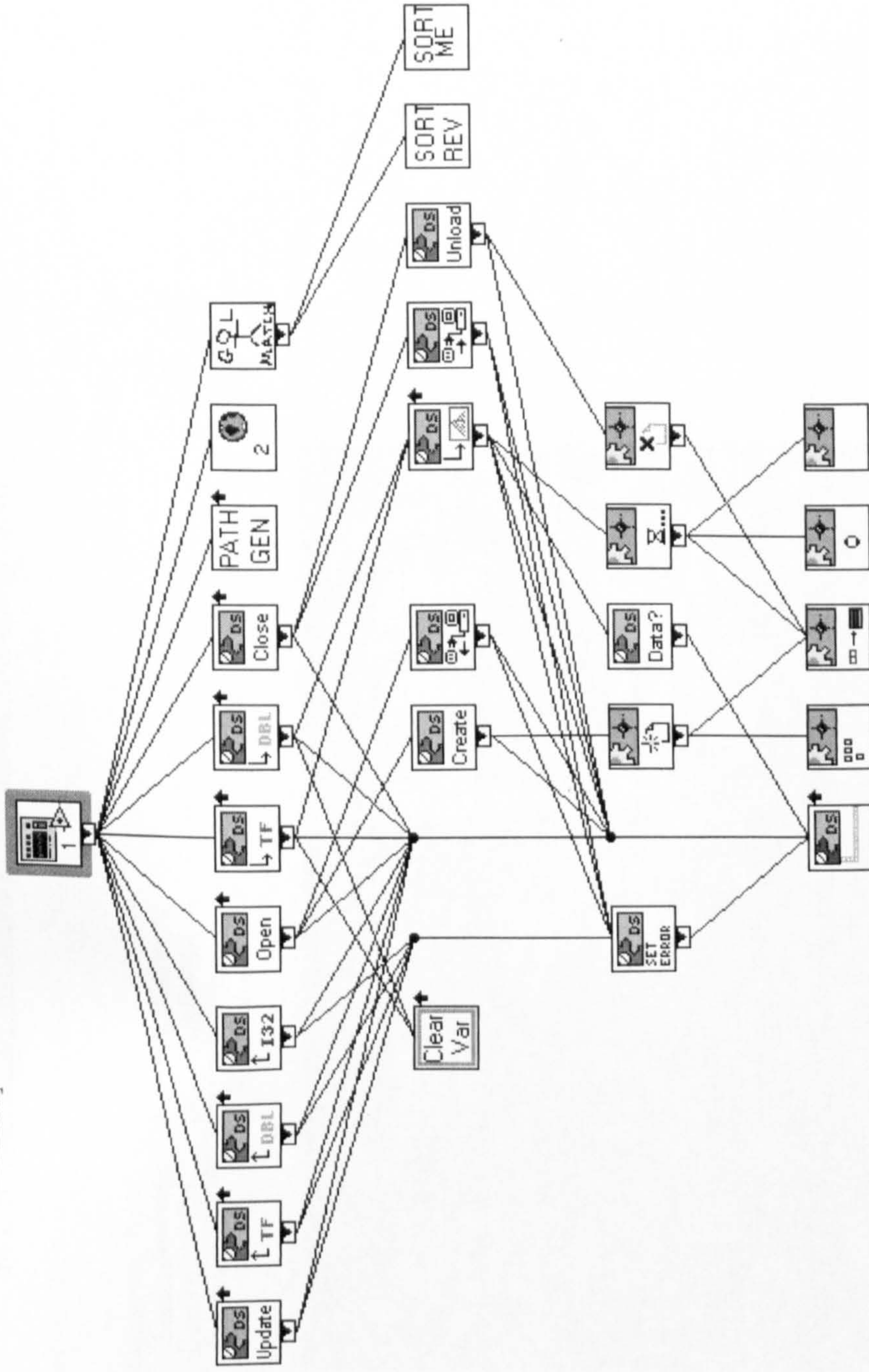







Block Diagram

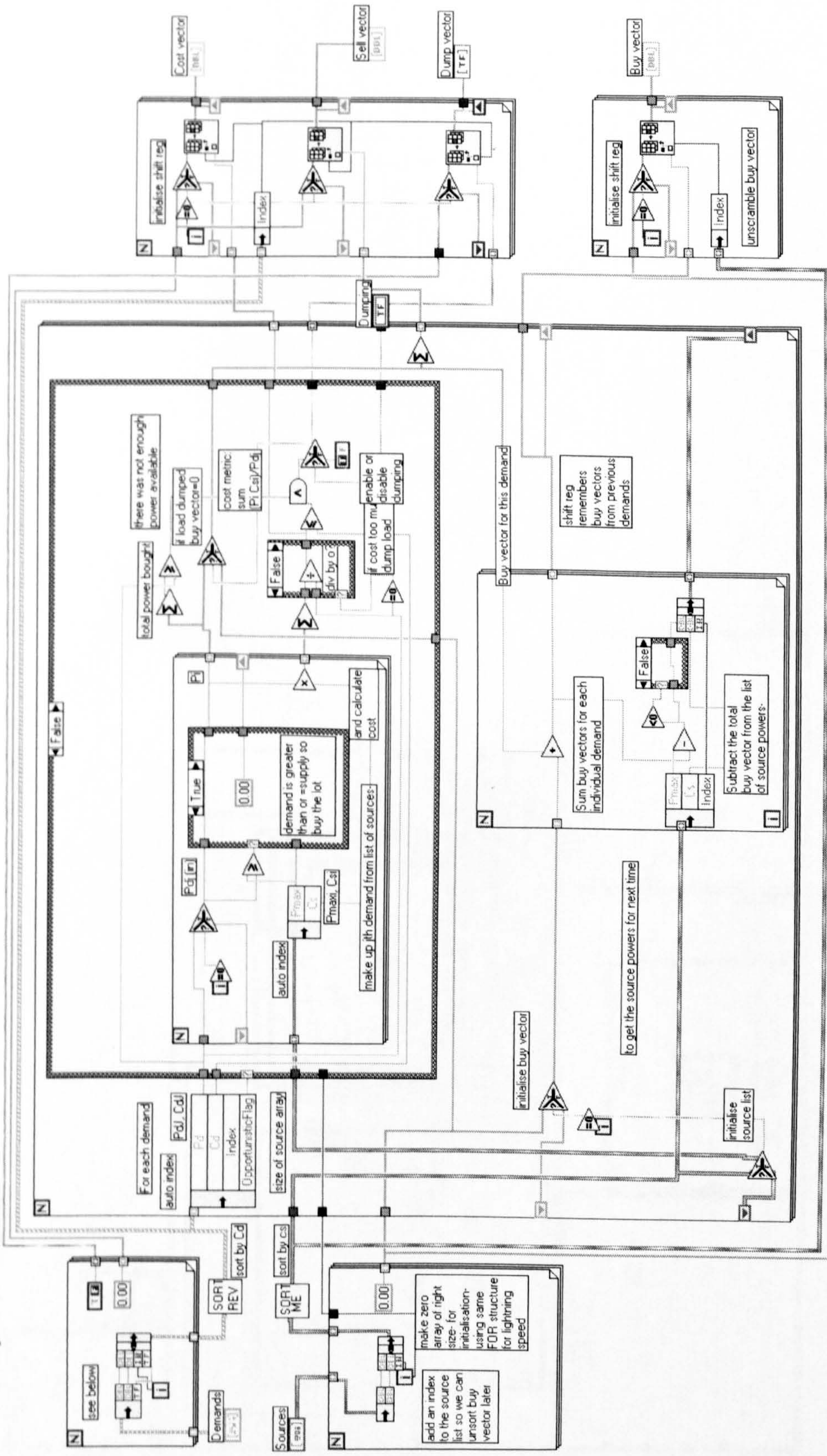



Hidden parts of diagram

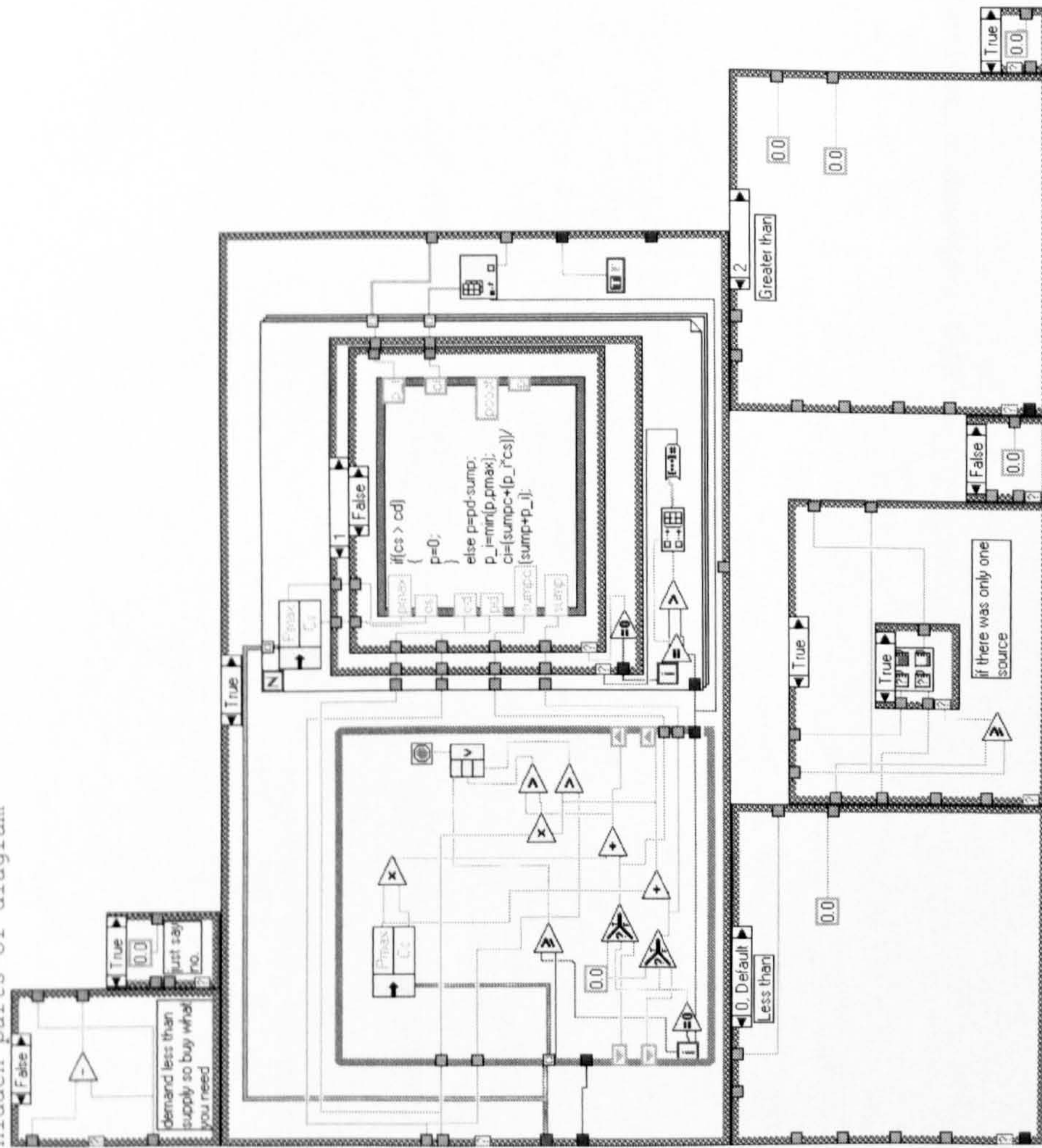



List of SubVIS

**SORI**  
**ME**

sort.vi

C:\My Documents\labview backup\labview\labview\phd\demo\sort.vi

**SORI**  
**REV**

sort-dem2.vi

C:\My Documents\labview backup\labview\labview\phd\demo\sort-dem2.vi