

# **Multi-Objective Network Planning for the Integration of Electric Vehicles as Responsive Demands**

**Steven Inglis**

A thesis presented in fulfilment of the requirements for the degree of Master of Philosophy

September 2019

Institute for Energy and Environment  
Department of Electronic and Electrical Engineering  
University of Strathclyde  
Glasgow  
G1 1XW

## **Declaration**

This thesis is the result of the author's original research. It has been composed by the author and has not been previously submitted for examination which has led to the award of a degree.

The copyright of this thesis belongs to the author under the terms of the United Kingdom Copyright Acts as qualified by University of Strathclyde Regulation 3.50. Due acknowledgement must always be made of the use of any material contained in, or derived from, this thesis.

Signed:

Date:

## **Acknowledgements**

I would like to express my appreciation and thanks to my supervisors, Professors Graham Ault and Stuart Galloway, for their guidance and support. Special thanks also go to Dr Rachael Taljaard for her continued and tireless support in the latter stages of this research. Finally, this work is dedicated to my mother Mary, who always supported me no matter what path I chose in life and finally to my wife Ellen, who made me a better person.

I express thanks to the Highly Distributed Energy Futures (HiDEF) Consortium for funding this research.

# Contents

<b>DECLARATION</b> .....	<b>II</b>
<b>ACKNOWLEDGEMENTS</b> .....	<b>III</b>
<b>TABLE OF FIGURES</b> .....	<b>VIII</b>
<b>TABLE OF TABLES</b> .....	<b>X</b>
<b>ABBREVIATIONS</b> .....	<b>XI</b>
<b>ABSTRACT</b> .....	<b>XIV</b>
REFERENCES FOR ABSTRACT.....	XV
<b>CHAPTER 1 - INTRODUCTION</b> .....	<b>1</b>
1.1 THESIS OBJECTIVES AND METHODOLOGY .....	3
1.2 CONTRIBUTION TO KNOWLEDGE .....	5
1.3 THESIS OVERVIEW.....	6
1.4 ASSOCIATED PUBLICATIONS.....	7
1.5 REFERENCES FOR CHAPTER 1.....	8
<b>CHAPTER 2 - DISTRIBUTED ENERGY RESOURCES AND DISTRIBUTION NETWORKS</b> .....	<b>11</b>
2.1 INTRODUCTION TO DISTRIBUTED ENERGY RESOURCES .....	11
2.2 THE NEED FOR DISTRIBUTED ENERGY RESOURCES .....	12
2.3 BENEFITS AND IMPACTS OF DISTRIBUTED ENERGY RESOURCES & DISTRIBUTED GENERATION .....	15
2.3.1 <i>Benefits of DERs</i> .....	16
2.3.2 <i>Impacts of DERs</i> .....	18
2.3.3 <i>Summary of Benefits and Impacts of DERs</i> .....	22
2.4 THE IMPACT OF EVs ON DISTRIBUTION NETWORKS .....	22
2.5 DISTRIBUTED ENERGY RESOURCE NETWORK PLANNING.....	26
2.6 OPTIMAL INTEGRATION OF DISTRIBUTED ENERGY RESOURCES .....	28
2.7 MULTI-OBJECTIVE NETWORK PLANNING .....	30
2.7.1 <i>Optimisation Methods</i> .....	31
2.8 SUMMARY .....	34
2.9 REFERENCES FOR CHAPTER 2.....	35
<b>CHAPTER 3 - MULTI-OBJECTIVE OPTIMISATION METHODS</b> .....	<b>41</b>
3.1 MULTI-OBJECTIVE OPTIMISATION FOR DER INTEGRATION .....	41
3.1.1 <i>Introduction to Multi-Objective Optimisation</i> .....	41
3.1.2 <i>Decision Making Process</i> .....	43
3.1.3 <i>Summary</i> .....	43

3.2 THE PARETO SET AND PARETO OPTIMALITY.....	44
3.3 GENETIC ALGORITHMS.....	46
3.3.1 <i>Introduction to Genetic Algorithms</i> .....	46
3.3.2 <i>Genetic Algorithm Process</i> .....	47
3.3.3 <i>Advantages and Disadvantages of Genetic Algorithms</i> .....	48
3.4 INTRODUCTION TO MOEA.....	49
3.5 SPEA2.....	50
3.6 MULTI-OBJECTIVE OPTIMISATION IN DER PLANNING.....	51
3.7 SUMMARY.....	51
3.8 REFERENCES FOR CHAPTER 3.....	52
<b>CHAPTER 4 - THE DISTRIBUTION PLANNING PROBLEM FOR ELECTRIC VEHICLES.....</b>	<b>54</b>
4.1 THE ELECTRIFICATION OF TRANSPORT.....	54
4.2 ELECTRIC VEHICLES.....	56
4.2.1 <i>Background to Electric Vehicles</i> .....	56
4.2.2 <i>Impact of EVs on Distribution Networks</i> .....	57
4.2.3 <i>EV Charging and Model Assumptions</i> .....	63
4.3 MODELLING EV BATTERIES AS RESPONSIVE DEMANDS.....	64
4.3.1 <i>EV Load Modelling</i> .....	66
4.3.2 <i>Coordinated Charging of EVs</i> .....	67
4.3.3 <i>Additional EV Load and Charger Power Output</i> .....	67
4.4 SUMMARY.....	69
4.5 REFERENCES FOR CHAPTER 4.....	69
<b>CHAPTER 5 - EV INTEGRATION AND APPLICATION TO THE PLANNING FRAMEWORK.....</b>	<b>73</b>
5.1 STRUCTURE OF THE NETWORK PLANNING TOOL.....	74
5.1.1 <i>Multi-Objective Planning Framework</i> .....	74
5.1.2 <i>Stochastic Simulation</i> .....	74
5.1.3 <i>MODERNE Framework for EV Integration</i> .....	75
5.1.4 <i>Network Planning Objectives</i> .....	77
5.1.4.1 <i>Line Losses</i> .....	77
5.1.4.2 <i>Imported and Exported Energy</i> .....	78
5.1.4.3 <i>Grid Dependency</i> .....	79
5.1.4.4 <i>Thermal Loading in Lines</i> .....	80
5.1.4.5 <i>Overload Probability</i> .....	80
5.1.4.6 <i>Energy Emissions Factor</i> .....	80
5.1.4.7 <i>Dispatched and Curtailed Energy</i> .....	81
5.1.4.8 <i>Penetration Level of Electric Vehicles</i> .....	81
5.1.5 <i>Initial Population</i> .....	82

5.1.6 Encoding and Decoding.....	82
5.1.7 Objective Evaluation and Constraints .....	84
5.1.8 Solution Selection to Populate Mating Pool.....	85
5.1.9 Crossover.....	86
5.1.10 Mutation Operator.....	88
5.2 STRENGTH PARETO EVOLUTIONARY ALGORITHM 2 .....	88
5.2.1 The SPEA2 Process.....	89
5.2.2 SPEA2 Fitness Assignment.....	90
5.2.3 SPEA2 Density Estimation .....	91
5.2.4 SPEA2 Archive Truncation .....	91
5.3 MODIFICATIONS TO MODERNE STRUCTURE FOR EV ANALYSIS .....	92
5.4 SUMMARY .....	93
5.5 REFERENCES FOR CHAPTER 5 .....	93
<b>CHAPTER 6 - EV INTEGRATION CASE STUDIES AND ANALYSIS .....</b>	<b>95</b>
6.1 UKGDS NETWORK MODELS.....	96
6.1.1 EV Types and Decision Variables .....	97
6.1.2 Demand and Generation Data .....	100
6.2 CASE STUDY 1: THE OPTIMAL INTEGRATION OF EVs TO MAXIMISE THE UTILISATION OF WIND GENERATION .....	101
6.2.1 UKGDS 75 Node Rural Network Model.....	101
6.2.2 Objectives, Constraints and Model Inputs.....	104
6.2.3 EV Types and Charging Routines to be used with Case Study 1 .....	105
6.2.4 MODERNE Output and Results.....	106
6.2.5 Discussion and Results .....	106
6.2.6 Trade Offs and Compromises .....	109
6.2.7 Case Study 1 - Conclusions .....	115
6.3 CASE STUDY 2: THE OPTIMAL INTEGRATION OF EVs TO MAXIMISE THE UTILISATION OF PV GENERATION .....	115
6.3.1 UKGDS 95 Node Urban Network Model.....	116
6.3.2 Objectives, Constraints and Model Inputs.....	119
6.3.3 EV Types and Charging Routines to be used with Case Study 2 .....	120
6.3.4 MODERNE Output and Results.....	121
6.3.5 Discussion and Results .....	121
6.3.6 Trade Offs and Compromises .....	124
6.3.7 Case Study 2 - Conclusions .....	130
6.4 SUMMARY .....	131
6.5 REFERENCES FOR CHAPTER 6.....	132
<b>CHAPTER 7 - CONCLUSIONS AND FURTHER WORK .....</b>	<b>134</b>
7.1 OBJECTIVES.....	134

7.2 FINAL CONCLUSIONS.....	135
7.3 FURTHER WORK .....	137
7.4 FINAL SUMMARY .....	138
<b>UKGDS NETWORK DATA.....</b>	<b>139</b>
<b>APPENDIX 1 - CIRCUIT IMPEDANCE (<math>\Omega</math>) DATA CASE STUDY 1.....</b>	<b>139</b>
<b>APPENDIX 2 - LOAD DATA CASE STUDY 1 .....</b>	<b>140</b>
<b>APPENDIX 3 - GENERATION EXPORT DATA CASE STUDY 1 .....</b>	<b>142</b>
<b>APPENDIX 4 - CIRCUIT IMPEDANCE (<math>\Omega</math>) DATA CASE STUDY 2.....</b>	<b>143</b>
<b>APPENDIX 5 - LOAD DATA CASE STUDY 2 .....</b>	<b>145</b>
<b>APPENDIX 6 - GENERATION EXPORT DATA CASE STUDY 2 .....</b>	<b>147</b>

## Table of Figures

FIGURE 1: THE ROLE OF THE DSO IN THE ENERGY SYSTEM .....	14
FIGURE 2: EV REGISTRATIONS BY TYPE (UK) 2015 – 2018 .....	23
FIGURE 3: EV REGISTRATIONS (UK) 2016 – 2018 .....	23
FIGURE 4: HOUSEHOLD ADMD WITH AND WITHOUT EVs.....	25
FIGURE 5: A PARETO SET FOR A TWO OBJECTIVE OPTIMISATION .....	32
FIGURE 6: SIMULATION ACCURACY VS. MOEA SPEED TRADE-OFF .....	33
FIGURE 7: A PARETO SET FOR A TWO OBJECTIVE OPTIMISATION .....	44
FIGURE 8: THE PARETO FRONT CREATED THROUGH N GENERATIONS .....	45
FIGURE 9: PARETO OPTIMALITY AND DOMINANCE .....	45
FIGURE 10: UK CARBON DIOXIDE EMISSIONS 2015.....	56
FIGURE 11: THE IMPACT OF UNMANAGED EV CHARGING (LOW RANGE) .....	59
FIGURE 12: THE IMPACT OF UNMANAGED EV CHARGING (MID-RANGE).....	59
FIGURE 13: THE IMPACT OF MANAGED EV CHARGING (MID-RANGE) .....	60
FIGURE 14: DAILY LOAD PROFILE OBJECTIVES .....	61
FIGURE 15: MULTI-OBJECTIVE PLANNING FRAMEWORK - HIGH LEVEL STRUCTURE.....	74
FIGURE 16: STOCHASTIC SIMULATION.....	75
FIGURE 17: OUTPUT EXAMPLE.....	76
FIGURE 18: BINARY SELECTION PROCESS.....	86
FIGURE 19: PARENT AND CHILD CROSSOVER IMPLEMENTATION.....	87
FIGURE 20: SPEA2 FITNESS ASSIGNMENT PROCEDURE - STRENGTH.....	90
FIGURE 21: SPEA2 FITNESS ASSIGNMENT PROCEDURE - RAW FITNESS.....	91
FIGURE 22: 11kV 75 NODE DISTRIBUTION NETWORK.....	102
FIGURE 23: OVERLOAD PROBABILITY AGAINST ENERGY EMISSIONS FACTOR .....	107
FIGURE 24: OVERLOAD PROBABILITY AGAINST EXPORTED ENERGY .....	107
FIGURE 25: OVERLOAD PROBABILITY AGAINST GRID DEPENDENCY .....	107
FIGURE 26: GRID DEPENDENCY AGAINST ENERGY EMISSIONS FACTOR .....	108
FIGURE 27: EXPORTED ENERGY AGAINST GRID DEPENDENCY .....	108
FIGURE 28: ENERGY EMISSIONS FACTOR AGAINST EXPORTED ENERGY .....	109
FIGURE 29: OVERLOAD PROBABILITY AGAINST ENERGY EMISSIONS FACTOR .....	110
FIGURE 30: OVERLOAD PROBABILITY AGAINST EXPORTED ENERGY .....	110
FIGURE 31: OVERLOAD PROBABILITY AGAINST GRID DEPENDENCY .....	111
FIGURE 32: GRID DEPENDENCY AGAINST ENERGY EMISSIONS FACTOR .....	111
FIGURE 33: EXPORTED ENERGY AGAINST GRID DEPENDENCY .....	111
FIGURE 34: ENERGY EMISSIONS FACTOR AGAINST EXPORTED ENERGY .....	112
FIGURE 35: 11kV 95 NODE DISTRIBUTION NETWORK.....	117
FIGURE 36: OVERLOAD PROBABILITY AGAINST LINE LOSSES .....	122



FIGURE 37: OVERLOAD PROBABILITY AGAINST EXPORTED ENERGY .....	122
FIGURE 38: OVERLOAD PROBABILITY AGAINST GRID DEPENDENCY .....	122
FIGURE 39: LINE LOSSES AGAINST EXPORTED ENERGY.....	123
FIGURE 40: LINE LOSSES AGAINST GRID DEPENDENCY.....	123
FIGURE 41: EXPORTED ENERGY AGAINST GRID DEPENDENCY .....	124
FIGURE 42: OVERLOAD PROBABILITY AGAINST LINE LOSSES .....	125
FIGURE 43: OVERLOAD PROBABILITY AGAINST EXPORTED ENERGY .....	125
FIGURE 44: OVERLOAD PROBABILITY AGAINST GRID DEPENDENCY .....	125
FIGURE 45: LINE LOSSES AGAINST EXPORTED ENERGY.....	126
FIGURE 46: LINE LOSSES AGAINST GRID DEPENDENCY.....	126
FIGURE 47: EXPORTED ENERGY AGAINST GRID DEPENDENCY .....	126

## Table of Tables

TABLE 1: NETWORK PLANNING ATTRIBUTES/OBJECTIVES .....	77
TABLE 2: EXAMPLES OF ENCODING.....	84
TABLE 3: SPEA2 INPUT PARAMETERS FOR CASE STUDY 1 .....	105
TABLE 4: EV TYPES AND CHARGING ROUTINES FOR CASE STUDY 1 .....	105
TABLE 5: SOLUTION DATA FOR CASE STUDY 1 .....	110
TABLE 6: SOLUTION A - CASE STUDY 1.....	113
TABLE 7: SOLUTION B - CASE STUDY 1.....	114
TABLE 8: SOLUTION C - CASE STUDY 1.....	114
TABLE 9: SPEA2 INPUT PARAMETERS FOR CASE STUDY 2 .....	120
TABLE 10: EV TYPES AND CHARGING ROUTINES FOR CASE STUDY 2 .....	120
TABLE 11: SOLUTION DATA FOR CASE STUDY 2 .....	124
TABLE 12: SOLUTION A - CASE STUDY 2.....	128
TABLE 13: SOLUTION B - CASE STUDY 2.....	128
TABLE 14: SOLUTION C - CASE STUDY 2.....	129

## Abbreviations

ADMD	After Diversity Maximum Demand
AH	Ampere Hour
ANM	Active Network Management
BEIS	Business Energy and Industrial Strategy
BESS	Battery Energy Storage System
BEV	Battery Electric Vehicle
BFS	Backwards/Forwards Sweep
CHP	Combined Heat and Power
CI	Customer Interruptions
CIGRE	The International Council on Large Electricity Systems
CLNR	Customer-Led Network Revolution
CML	Customer Minutes Lost
CO <sub>2</sub>	Carbon Dioxide
CPOC	Customer Point of Connection
DECC	Department for Energy and Climate Change
DEFRA	Department for Environment, Food and Rural Affairs
DER	Distributed Energy Resource
DG	Distributed Generation
DNO	Distribution Network Operator
DSO	Distribution System Operator
DSR	Demand Side Response
DUoS	Distribution Use of System
DV	Decision Variable
EA	Evolutionary Algorithm
EHV	Extra-high-voltage
ER	Engineering Recommendation
EU	European Union
EV	Electric Vehicle
FES	Future Energy Scenarios
FIT	Feed-in Tariff

GA	Genetic Algorithm
GB	Great Britain
GM	Ground Mounted
GSP	Grid Supply Point
HV	High Voltage
ICE	Internal Combustion Engine
IIS	Interruptions Incentives Scheme
kW	Kilowatt
kWh	Kilowatt Hours
kWp	Kilowatt peak
Li-ion	Lithium-Ion
LDR	Losses Discretionary Reward
LV	Low Voltage
MCDM	Multi-Criteria Decision Making
MODERNE	Multi-objective Distributed Energy Resource and Network Evaluation
MOEA	Multi-objective Evolutionary Algorithm
MOGA	Multi-objective Genetic Algorithm
MWh	Megawatt hour
MWp	Megawatt peak
NSGA	Non-dominated Sorting Genetic Algorithm
NSGA-II	Fast Non-dominated Sorting Genetic Algorithm
Ofgem	The Office of Gas and Electricity Markets
OFAF	Oil Forced Air Forced
PESA	Pareto Envelope-based Selection Algorithm
PHEV	Plug-in Hybrid Electric Vehicle
PM	Pole Mounted
PV	Solar Photovoltaic
RIIO-ED	Revenue = Incentives + Innovation + Outputs - Electricity Distribution
SMMT	The Society of Motor Manufacturers and Traders
SMETS2	Smart Metering Equipment Technical Specifications 2
SOC	State-of-Charge

SPEA	Strength Pareto Evolutionary Algorithm
SPEA2	Improved SPEA
TSO	Transmission System Operator
TWh	Terawatt Hour
UK	United Kingdom
UKGDS	United Kingdom Generic Distribution System
VEGA	Vector Evaluated Genetic Algorithm
VPP	Virtual Power Plant

## Abstract

The integration of electric vehicles (EVs) into distribution networks presents substantial challenges to Distribution Network Operators (DNOs) internationally. In the 12 months from November 2017, EV registrations in Great Britain have increased by ~22% [A.1], though it is noted that EVs account for only 6% of all UK vehicle registrations [A.1] in 2018. With the UK Government announcement in 2017 [A.2] that “*by 2040 there will be an end to the sale of all conventional petrol and diesel cars and vans*”, the penetration of EVs will require to - unless a new technology emerges - grow exponentially over the next 10 to 20 years towards 100% penetration by 2050. However, the increasing penetration of EVs can provide to the system multiple benefits and assist in mitigating issues; if EV integration is optimally planned using a suitable method. The managed charging of multiple EVs can assist in better utilising power generated by intermittent renewables, which will provide substantial benefits such as peak shifting, deferred reinforcement costs and the reduced requirement for imported energy to support the network at times of need.

Accurately assessing the impact that EVs will have on distribution networks is critical to DNOs [A.3]. In particular, the aim of this thesis is to identify the optimal location, battery size, charger power output and operational envelope for multiple EVs when used as responsive demands in high voltage/low voltage (HV/LV) distribution networks. Societal benefits can include reduced or deferred asset investment costs; reduced technical losses and increasing the utilisation of renewable generation [A.3]. System benefits must be accounted for and can support and inform planning and operational decisions - such as asset investment and network reinforcement. Coordinated smart charging of multiple EVs can assist in managing peaks in the demand curve and increase the utilisation of intermittent renewables.

Unmanaged EV charging at times of peak demand would require the DNO to invest in reinforcement solutions to ensure the required additional capacity is made available. However, one approach is to cluster EV charging in periods when the base load would otherwise be low, to lessen the need for asset reinforcement as EV charging during the period of peak demand would be avoided. Time periods for charging EVs (dependent on the chosen objectives) will be identified and then correlated to times when renewable generation availability is high and when base demand is low. The use of the presented network planning tool will identify EV charging strategies that can be applied to multiple EVs (based on the chosen objectives and with respect to constraints) whilst optimising the type, number and location on a specific modelled network. The planning framework utilises the

Strength Pareto Evolutionary Algorithm 2 (SPEA2); the use of this algorithm will ensure that the network constraints are not breached and that multiple objectives are included in the analyses.

This thesis investigates the impact that the inclusion of multiple EVs (when used as responsive demands); will have on the HV distribution network when the additional EV load is smartly scheduled to meet specific objectives and to correspond with the availability of intermittent renewables. The ultimate aim of this planning approach is to offer DNOs low cost solutions to multi-objective problems relating to EV integration and operation.

## References for Abstract

- [A.1] The Society of Motor Manufacturers and Traders (SMMT), *“Electric Vehicle and Alternatively Fuelled Vehicle Registrations”*, 2018  
<https://www.smmt.co.uk/vehicle-data/evs-and-afvs-registrations/>  
Accessed 18 January 2019
- [A.2] Department of the Environment, Fisheries and Rural Affairs (DEFRA), *“UK plan for tackling roadside nitrogen dioxide concentrations”*, 2017  
[https://assets.publishing.service.gov.uk/government/uploads/system/uploads/attachment\\_data/file/633270/air-quality-plan-detail.pdf](https://assets.publishing.service.gov.uk/government/uploads/system/uploads/attachment_data/file/633270/air-quality-plan-detail.pdf)  
Accessed 08 January 2019
- [A.3] Customer-Led Network Revolution (CLNR), *“Project Closedown Report”*, 2014  
<http://www.networkrevolution.co.uk/wp-content/uploads/2016/09/CLNR-G026-Project-Closedown-Report-FINAL-V2.1-070916.pdf>  
Accessed 11 January 2019

## Chapter 1 - Introduction

The electricity industry has to meet substantial challenges in ensuring that the potential benefits of installed renewable generation are fully utilised. Meeting these challenges and therefore realising the benefits from renewable generation will be a significant step towards both cutting carbon emissions and in meeting the target of 15% of energy being generated from renewables by 2020 [1.1]. Included within this is the requirement that 30% of electricity will be generated from wind, solar photovoltaic (PV) and other low-carbon sources by 2020; and that 12% of heating energy and 10% of energy used for transportation will be produced from “clean” sources by the same date [1.2].

In 2012, renewable generation produced, in GB, the equivalent of 4% of (all) energy consumed [1.3], this had risen to 10% in 2017 [1.4]. This increase was largely driven by electricity generated from renewables, specifically, the observed increase in the installed capacity of wind generation. In 2017, electricity generated from renewable sources accounted for 29% [1.4] of the total electricity consumption; this has risen from 11% [1.3] in 2012.

The integration of DERs; including EVs (when used as responsive demands) will present substantial challenges to DNOs. To maximise benefits and minimise costs, analysis based planning tools are required to inform the decision making process regarding the integration and operation of DERs in distribution networks. Understanding the influence that DERs have on the distribution network is required, as the specifics of the installed DERs may impact upon; control of the network within statutory limits; quality of supply; electrical losses and financial objectives [1.5-1.6]. The optimal placement and size of DERs in a distribution network is desirable as the primary aim of a DNO is to plan, design, construct and operate an economic, secure and safe network, these aims however may not align with maximising the utilisation of DERs; a secondary aim of a DNO is to receive the optimum benefits from the installed DERs or to optimally manage the negative impacts caused by DERs and finally to then identify low cost solutions to be implemented to mitigate these problems.

This thesis proposes the use of responsive EVs, as a method to mitigate the inherent intermittency of renewable energy such as wind/PV and this will assist DNOs to defer or reallocate network investment. The impacts of DERs are well discussed [1.7-1.8] and the technical issues surrounding the placement of DERs on the distribution network have been well defined [1.7], [1.9]. The issues around DERs and the optimal placement and their benefits and impacts will be investigated in the next chapter.



The use of EVs as responsive demands will assist in increasing the utilisation of renewable generation; which will assist in reducing carbon emissions due to EV batteries being (smartly) charged at times of low load and high availability of renewable generation. When used as DERs, EV chargers can provide services to the DNO such as voltage regulation and can assist in shifting the demand curve to reduce the peak demand which can drive deferment of network investment schemes [1.10-1.21]. Scheduled EV charging can be coordinated with times of low load and the high availability of renewable generation (based upon historical data); the renewable generation export from wind/PV, which is curtailed at times of low load, can then be utilised for off peak EV charging, where it would otherwise have been of little value.

The desire for off peak EV charging must be tempered with the need to ensure an acceptable State-of-Charge (SOC) remains in the EV battery to allow the vehicle to perform its primary function. For the EV owner, working in tandem with the DNO, the maximising of the economic/financial value of the EV is the primary objective. For the DNO, minimising losses and designing an economic network are objectives of interest that would require to be optimised simultaneously. It is a Distribution Licence condition - which is enforced by the regulator - that the DNO must design and operate an economic and efficient network; not a minimal cost network. There is a further challenge to the DNO to keep the system within statutory limits without the need to invest (unnecessarily) in the network to ensure constraints are not breached.

The managed charging of EVs and coordinating EV charging times with the availability of renewables such as wind/PV, will assist in mitigating some of the negative impacts of DERs (such as voltage rise) whilst increasing the received benefits from those optimally sited DERs.

The results in this thesis are based on the assumption that the DNO can optimise the numbers of EV types (charger power output & battery size) that are connected at each feeder and distribution substation on the network. In practice, DNOs will be unable to influence customer behaviour as to the location or size of a single EV battery or charger. To produce optimal results, the framework also requires accurate forecasting of the variable output from both wind and PV generation and also the state-of-charge of each EV battery at the start of the charging period, for the purposes of modelling there were some simple assumptions used. In reality, these assumptions limit the practicality of the proposed method, though there is significant value to be realised for DNO to understand the facets of an EV charging scenario that would typically be optimal. The results presented will demonstrate that numerous improvements in network performance are available when EV charging routines are

used to mitigate the intermittency of renewable generation. It has been demonstrated that a reduction in network overloads is possible, as is the increased uptake of renewable generation at times of low load, but it is noted that there are constraints and barriers to overcome, such as the granularity and availability of data and the communications infrastructure in place between the DNO and EV charger.

This thesis will present a framework for the managed integration of EVs into an HV distribution network that will enable the operation and management of EVs to be controlled and optimised for system benefits. This will consequently enable the increased utilisation of renewable generation, which will be facilitated by the use of a managed smart charging approach. A multi-objective planning method was adopted and required; as distribution network planning has both multiple stakeholders and multiple objectives which are addressed simultaneously.

## **1.1 Thesis Objectives and Methodology**

The research presented in this thesis is based around a multi-objective approach to network planning and the hypothesis proposed is that responsive (smart) EV charging can meet multiple stakeholder objectives. The hypothesis that an optimally managed fleet of EVs can provide multiple stakeholder benefits whilst mitigating the problems associated with the integration of the associated additional loads is tested using a planning tool underpinned by a Multi-Objective Evolutionary Algorithm (MOEA). The planning tool has been developed with the functionality to incorporate multiple EVs as responsive demands and to assess the impact of different EV charging schedules on the distribution network. Valuable information for the DNO (and other stakeholders) relating to the optimal (managed) integration of EVs in distribution networks at HV/LV can be provided which will inform decision making and can impact on network investment strategies.

Identifying the optimal placement, capacity and operational envelope for EVs, when used as responsive demands, is desirable for DNOs, the identification of these optimal configurations can mitigate the intermittency of renewable generation; this will assist in the deferring of network investment costs which are borne by the DNO and subsequently the customer. Results will be generated which will enable analyses to be carried out to ascertain which of the previously chosen objectives have been met. Subsequently, this thesis will show how a multi-objective planning method, when designed, developed, and validated, can be used to identify and analyse the optimal integration and operational envelope of multiple EVs in a distribution network.

To provide a useful and real world analysis and impact assessment of managed EV integration in a distribution network, the planning framework used will answer the following:

- What are the optimal economic configurations for integrating (multiple) EVs in a distribution network as responsive demands to meet a range of simultaneous objectives - whilst limited by constraints;
- What is the optimal operational envelope for multiple EVs when used as responsive demands (responsive charging) - to meet multiple objectives and when bound by a maximum battery size and a maximum number of EVs; and
- What are the correlations identified between these objectives; whilst mitigating the intermittency of renewables such as wind or PV (when the potential output of these has been forecast) when EVs are responsively charged.

The following areas of research have been undertaken to achieve these three high level objectives:

- A full understanding of MOEA and Genetic Algorithms (GAs) was gained to appreciate the strengths of SPEA2 and why SPEA2 is appropriate for use to approach this problem;
- The existing techniques for optimal EV integration, network planning, Active Network Management (ANM), and multi-objective planning have been critically reviewed to identify gaps in the literature;
- The main problem space relating to the optimal integration of EVs as responsive demands have been investigated and the bounds of the problem have been framed whilst defining the exact specifications of the multi-objective planning framework;
- An EV integration and operation assessment framework with appropriate analytical and optimisation methods has been developed;
- The planning framework and associated tool has been validated, tested and presented only after it had been applied to a set of appropriate and diverse case studies that will assist in identifying the optimal arrangement of EVs in a distribution network - based upon the chosen objectives and limited by constraints;
- A number of remaining challenges regarding optimal EV integration and operation at distribution network level have been identified and studied in case studies; and
- Analyses of case studies were carried out and results relating to the optimal integration of multiple EVs are presented.

This thesis aims to illustrate how a planning framework and tool can be used to identify optimal EV integration configurations in a distribution network, whilst mitigating the intermittency of renewable generation, subject to objectives and constraints.

## 1.2 Contribution to Knowledge

This thesis presents a novel approach to both mitigate the intermittency of, and to increase the utilisation of, energy generated by renewable sources. This is achieved by combining the scheduled managed charging of EVs with the inherent storage capacity of the EV battery, further; the optimal operational envelope for multiple EVs has been identified. The presented framework will analyse and assess the optimal integration of EVs in the distribution network. Whilst SPEA2 has previously been used to address power system planning, it has not been used to mitigate the intermittency of renewable generation by scheduling the charging times of EVs whilst optimising the number, location, EV battery size and charger power output of this fleet of EVs.

The framework integrates SPEA2 (a state of the art GA), an Alternating Current (AC) power flow algorithm and a load flow analysis together into framework for the siting, sizing and scheduling in operation of one or more EVs in a distribution network. The contributions of this thesis are briefly summarised as follows:

- A comprehensive review of network planning techniques and methods that would assist in mitigating the intermittency of renewable energy by using EV batteries and managed charging schedules was conducted. This review identified existing trends in the research area and gaps that could be exploited for further research;
- An examination of the problem relating to the optimal EV integration in the distribution network and the requirements for a multi-objective planning framework for analyses of different scenarios is presented;
- The development of an analytical method and accompanying tool to be used to identify the optimal location, battery size and operational envelope for multiple EVs when used as responsive demands in distribution networks. The process undertaken and the challenges faced were detailed as an aid for future work;
- Formulation of an optimisation method to tackle the problem of how to accurately assess the impact of a fleet of EVs in a distribution network. This methodology will identify the optimal operational envelope of an EV fleet to meet multiple and conflicting objectives. The formulation of the optimal EV integration problem has multiple objectives, the MOEA approach to the problem of optimal EV integration and the multiple stakeholder view that this approach allows is appropriate to be used for this planning problem;
- This thesis expands the knowledge base regarding the impacts and benefits of various EV charging scenarios and how to mitigate the intermittency of renewable generation by using

scheduling; correlating EV charging schedules with times of low load and high renewable availability. Specifically this thesis presents the network planning tool; and

- Case studies are examined and findings are analysed to establish, assess and present integration configurations of multiple EVs when used to mitigate the intermittency of energy generated from renewable sources.

### **1.3 Thesis Overview**

Chapter 2 provides an overview of, and then a detailed investigation into, the integration of DERs into distribution networks. The issues around the optimal integration of DERs are presented, the concept of multi-objective power system and DER planning is introduced, specifically the chosen multi-objective optimisation method to be used. The development of, and challenges that EVs pose to DNOs are introduced, as are the techniques that are used to mitigate challenges and realise the benefits from the increasing penetration of EVs in distribution networks;

Chapter 3 contains a comprehensive review of existing multi-objective optimisation methods. Further, it details why the specific optimisation method was chosen and the techniques that will be applied to the EV integration and scheduling problem;

Chapter 4 introduces the EV operation and integration problem and the planning horizon regarding the optimal number, EV battery size and charger power output. Further to this, it provides a detailed formulation of the optimal EV integration problem;

Chapter 5 introduces the multi-objective optimisation approach taken to solve the EV integration and operation problem and how the framework fits around the planning environment;

Chapter 6 presents case studies relating to the optimal EV integration and operation used to mitigate the intermittency of renewable generation, which have been applied to the network planning framework and then analyses were undertaken and conclusions were drawn from these results that have real planning implications; and

Chapter 7 highlights the key findings and identifies possible further work to be carried out.

The need for a well-planned distribution network with generation and load centres which have been sited to deliver optimum benefits to multiple stakeholders is clear. The successful interaction between responsive EVs (and managing the associated charging schedules) and the DNO will assist in

increasing the utilisation of renewable generation, whilst ensuring that the network security of supply is maintained. Smart EV charging will enable network investment costs to be deferred and this is achieved by shifting EV charging times to periods of low demand or the high availability of renewable generation; this is undertaken to increase the expected life of distribution assets such as transformers. Furthermore, the scheduled charging of EVs will enable the intermittency of renewables such as wind/PV to be mitigated, which will assist in meeting carbon reduction targets.

The use of MOEA generally and specifically SPEA2 is appropriate as a method of solving this multi-objective planning problem, as it is categorised by both multiple and conflicting objectives and multiple stakeholder perspectives. A MOEA was chosen due to the following; several objectives can be optimised simultaneously and any type of constraints, objectives and either integer or continuous decision variables (DVs) can be incorporated into the problem with ease.

It has been shown that the use of EVs to mitigate the intermittency of renewable generation is a viable solution to a real world problem, and that the use of appropriately managed EVs will assist DNOs in deferring network investment costs. The use of the SPEA2 based network planning tool is well suited to the 'location, sizing and scheduling in operation' problem.

## **1.4 Associated Publications**

The integration of EVs as responsive demands and the associated impacts upon the distribution network is presented in:

- **S. Inglis, G. W. Ault, S. J. Galloway, “Multi-objective network planning tool for networks containing high penetrations of DER”, 45<sup>th</sup> International Universities' Power Engineering Conference (UPEC), Cardiff, Wales, UK, September 2010;**
- **S. Inglis, G. W. Ault, S. J. Galloway, “Multi-Objective Power Network Planning Tool for High Penetrations of Distributed Energy Resources with Specific Emphasis on Electric Vehicles”, 4<sup>th</sup> International Conference on Integration of Renewable and Distributed Energy Resources (IRDER), Albuquerque, New Mexico, USA, December 2010; and**
- **S. Inglis, G. W. Ault, S. J. Galloway, “Multi-Objective Network Planning Tool for the Optimal Integration of Electric Vehicles as Responsive Demand and Dispatchable Storage”, 21<sup>st</sup> International Conference and Exhibition on Electricity Distribution (CIRED), Frankfurt, Germany, June 2011.**

A methodology for the mitigation of renewable wind through the use of scheduled EV charging in conjunction with electrical thermal storage was presented in:

- **S. Inglis**, R. L. Storry, G. W. Ault, S. J. Galloway, “*Methodology for Optimal Integration of Electric Vehicles as Microgeneration and Electric Heat Storage as Responsive Demands*”, Microgen 2011 conference, Glasgow, UK, April 2011.

Additionally, the author has contributed to the following published papers:

- C. Jardine, A. D. Alarcón-Rodríguez, S. J. Galloway, G. W. Ault, **S. Inglis**, “*Modelling and Optimisation of Energy Storage Systems in Power Distribution Networks*”, 21<sup>st</sup> International Conference and Exhibition on Electricity Distribution (CIRED), Frankfurt, Germany, June 2011.

## 1.5 References for Chapter 1

- [1.1] Department for Energy and Climate Change, “*Climate Change Act 2008 Impact Assessment*,” 2009  
<https://www.legislation.gov.uk/ukia/2009/70>  
Accessed 21 January 2019
- [1.2] Department for Energy and Climate Change, “*The UK Renewable Energy Strategy*”, 2009  
[https://www.gov.uk/government/uploads/system/uploads/attachment\\_data/file/228866/7686.pdf](https://www.gov.uk/government/uploads/system/uploads/attachment_data/file/228866/7686.pdf)  
Accessed 17 January 2019
- [1.3] Department for Business Energy and Industrial Strategy, “*Digest of United Kingdom Energy Statistics 2012*”, 2013  
[https://assets.publishing.service.gov.uk/government/uploads/system/uploads/attachment\\_data/file/279523/DUKES\\_2013\\_published\\_version.pdf](https://assets.publishing.service.gov.uk/government/uploads/system/uploads/attachment_data/file/279523/DUKES_2013_published_version.pdf)  
Accessed 05 January 2019
- [1.5] Department for Business Energy and Industrial Strategy, “*Digest of United Kingdom Energy Statistics 2017*”, 2018  
[https://assets.publishing.service.gov.uk/government/uploads/system/uploads/attachment\\_data/file/736148/DUKES\\_2018.pdf](https://assets.publishing.service.gov.uk/government/uploads/system/uploads/attachment_data/file/736148/DUKES_2018.pdf)  
Accessed 07 January 2019
- [1.5] V.H. Mendez, J. Rivier, J.I. De la Fuente, T. Gomez, J. Arceluz, J. Marin, A. Madurga, “*Impact of Distributed Generation on Distribution Investment Deferral*”, International Journal of Electrical Power and Energy Systems, Volume 28, Issue 4, Pages 244-252, May 2006

- [1.6] V.H. Mendez, J. Rivier, T. Gomez, "Assessment of Energy Distribution Losses for Increasing Penetration of Distributed Generation ", IEEE Transactions on Power Systems, Vol. 21, No. 2, May 2006
- [1.7] J. A. Pecas Lopes, N. Hatziargyriou, J. Mutale, P. Djapic, N. Jenkins, "Integrating Distributed Generation into Electric Power Systems: A Review of Drivers, Challenges and Opportunities", Electric Power Systems Research, Volume 77, Number 9, p. 1189-1203, July 2007
- [1.8] G. Strbac, C. Ramsay, D. Pudjianto, "Integration of Distributed Generation into the UK Power System", Summary Report, DTI Centre for Distributed Generation and Sustainable Electrical Energy 2007
- [1.9] G. Pepermans, J. Driesen, D. Haeseldonckxc, R. Belmans, R., D'haeseleer, "Distributed Generation: Definition, Benefits and Issues", Energy Policy, Volume 33, Number 6, pp. 787-798, April 2005
- [1.10] F. Tuffner and M. Kintner-Meyer, "Using electric vehicles to meet balancing requirements associated with wind power," Pacific Northwest National Laboratory (PNNL), Richland, WA, USA, Tech. Rep., 2011.
- [1.11] J. Pecas Lopes, P. Rocha Almeida, and F. Soars, "Using vehicle-to-grid to maximize the integration of intermittent renewable energy resources in islanded electric grids," in Proc. 2009 IEEE Int. Conference. Clean Electric. Power, pp. 290-295.
- [1.12] J. Lopes, F. Soares, P. Almeida, and M. da Silva, "Smart charging strategies for electric vehicles: Enhancing grid performance and maximizing the use of variable renewable energy resources," in Proceedings of the 24th International Battery Hybrid Fuel Cell Electric Vehicle Symposium Exhibition, Stavanger, Norway, 2009.
- [1.13] W. Kempton and J. Tomic, "Vehicle-to-grid power fundamentals: Calculating capacity and net revenue," J. Power Sources, vol. 144, no. 1, pp. 268-279, 2005
- [1.14] W. Kempton and J. Tomic, "Vehicle-to-grid power implementation: From stabilizing the grid to supporting large-scale renewable energy," J. Power Sources, vol. 144, no. 1, pp. 280-294, 2005.
- [1.15] N. Rotering and M. Ilic, "Optimal charge control of plug-in hybrid electric vehicles in deregulated electricity markets," IEEE Trans. Power Syst., vol. 26, no. 3, pp. 1021-1029, August 2010.
- [1.16] S. Han, S. Han, and K. Sezaki, "Development of an optimal vehicle-to grid aggregator for frequency regulation," IEEE Trans. Smart Grid, vol. 1, no. 1, pp. 65-72, 2010.
- [1.17] C. Sndergren, "Edison project: Electric vehicles in future market models," Danish Energy Association, Tech. Rep., 2011.



- [1.18] G. Heydt, *"The impact of electric vehicle deployment on load management strategies,"* IEEE Trans. Power App. Syst., vol. 102, no. 5, pp. 1253-1259, 2007.
- [1.19] R. Green, II, L. Wang, and M. Alam, *"The impact of plug-in hybrid electric vehicles on distribution networks: A review and outlook,"* Renewable Sustain. Energy Rev., vol. 15, no. 1, pp. 544-553, 2011.
- [1.20] J. Lopes, F. Soares, and P. Almeida, *"Identifying management procedures to deal with connection of electric vehicles in the grid,"* Proc. 2009 IEEE Bucharest PowerTech, pp. 1-8.
- [1.21] K. Clement-Nyns, E. Haesen, and J. Driesen, *"The impact of charging plug-in hybrid electric vehicles on a residential distribution grid,"* IEEE Trans. Power Syst., vol. 25, no. 1, pp. 371-380, 2010
- [1.22] O. Sundström, C. Binding *"Optimization Methods to Plan the Charging of Electric Vehicle Fleets"* Proc. ACEEE International Conference on Control, Communication, and Power Engineering (CCPE), pp. 323-328, Chennai, India, July 28, 2010
- [1.23] T. Kristoffersen, K. Capiion, and P. Meibom, *"Optimal charging of electric drive vehicles in a market environment"*. Applied Energy, 88, 1940-1948, 2011
- [1.24] J. Hu, S. You, J. Oestergaard, M. Lind, and Q. Wu, *"Optimal charging schedule of an electric vehicle fleet,"* in Proc. 2011 46th Int. Universities' Power Eng. Conf. (UPEC), pp. 1-6
- [1.25] T. Lan, J. Hu, G. Wu, S. You, L. Wang, and Q. Wu, *"Optimal charge control of electric vehicles in electricity markets,"* Proc. 4th Int. Workshop Intelligent Information Management Systems Technology, 2011

## **Chapter 2 - Distributed Energy Resources and Distribution Networks**

Distributed Generation (DG) has traditionally been thought of as small scale generation that is used onsite by large processes with a connection to the distribution network providing stability and synchronisation. The integration of DG (specifically renewable generation) into distribution networks has changed this understanding and is a complex issue for DNOs. There has been no consensus on the definition of the term DG as was shown by the output of the survey conducted by CIRED [2.1].

The International Council on Large Electricity Systems (CIGRE) defines DG as generation that is not centrally planned or centrally dispatched, which is usually connected to the distribution network and is normally sized at less than 100MVA, however there is no formal upper limit on the size [2.2]. DG sizes range from 2kVA of generation connected to the Low Voltage (LV) network up to 100MVA (typically) which is connected to the High Voltage (HV), Extra-High-Voltage (EHV) or 132kV network (though in Scotland the 132kV network is a defined transmission network voltage).

DG technologies commonly deployed in GB include (but are not limited to); PV, wind turbines and small hydro schemes [2.3]. DG can provide potential system, social and monetary benefits to multiple stakeholders, such as a reduction in losses, network investment deferral or carbon emissions reduction [2.3-2.6]. DG can have a measurable and negative impact on power flow, voltage profile and stability of the distribution network [2.7-2.10], so it is vital that there are adequate control and analysis mechanisms in place to curtail generation when required to ensure the network stays within limits. DG is typically included within the wider portfolio of DERs.

This chapter will detail the requirement for DERs and the benefits and potential impacts of DERs in a distribution network. The fundamentals of DER planning and the principles behind the optimal integration of DERs in distribution networks will be introduced. Finally, multi-objective planning methods for power systems and DER integration are detailed, specifically the chosen multi-objective optimisation method; though these will be explored fully in Chapter 3. The principles of optimal multi-objective planning methods for DERs (specifically EVs as responsive demands) will underpin the remainder of this thesis.

### **2.1 Introduction to Distributed Energy Resources**

DERs include DG (specifically renewables), Battery Energy Storage Systems (BESS) and Demand Side Response (DSR) schemes (responsive demands) [2.11]. It is the use of EVs as responsive demands

(by managed charging regimes) and the intelligent scheduling and operation of the charging routines of EVs that will be the specific focus of this research.

Renewable DERs (wind/PV) will provide environmental benefits such as the reduction of carbon emissions and the diversification of the energy mix. There is an on-going debate about the impact that DERs will have upon security of supply and Engineering Recommendation P2/7 [2.12] (which was implemented in August 2019), introduces a number of changes which take into account the impact of DERs on security of supply; for example the network inertia that can be caused by the installation of generation [2.13]. As the market (or more specifically, UK Government incentives) pushes the installation of wind, PV and more recently large scale BESS, there will be a diversification in the installed energy mix in GB. This will have been unplanned and may be a fortuitous by-product of the regulatory framework over the past 20 years. As there has been a marked increase in the installed capacity of DERs, which are replacing older centrally dispatched large coal and gas power stations, there are new challenges relating to security of supply and network reliability due to the variability of wind and PV.

Inverter connected generation has lower inertia values and lowering the inertia on the network results in the frequency becoming unstable; due to this there is a higher risk of frequency deviations outside permitted tolerances [2.13]. As a general rule, inertia is provided by direct coupled synchronous machines that can respond directly to frequency deviations and as the number of synchronous generators is reduced (which is expected with an increased penetration of DERs), there is a greater risk of frequency issues on the network; purely due to the increased penetration of smaller DER units replacing traditional large (transmission connected) power stations [2.13].

DER units can offer services (such as Fast Frequency Response) to the network which can provide financial benefits to the generation owner [2.14]. It is expected that DERs will play a vital role in the growth and management of GB distribution networks [2.15]. The use of DERs in general and in particular the responsive charging of EVs can be a valuable asset for the DNO to exploit.

## **2.2 The Need for Distributed Energy Resources**

There are a number of reasons for the increased interest in, and penetration, of DERs in GB. Meeting the target of 15% of all energy generated from renewable sources [2.16] and to reduce overall carbon emissions are the two main drivers behind the regulatory drive to integrate a greater proportion of DERs in the energy mix. The costs of reinforcing transmission or distribution networks will ultimately be borne by the customer, but by installing DERs, there is the potential to offset and

delay the need (and cost) of network reinforcement which would be required to respond to the underlying annual load growth [2.17].

In general terms, DNOs do not design networks based upon the contribution of DERs, DNOs do not rely on imports or exports from DERs when designing the network, which must remain within constraints in the event that the DERs are not operational, and that the network then must be able to supply the peak load at all times without any contribution from installed generation [2.18]. The focus for DER developers is to identify quicker and cheaper connections rather than the ensuring the optimal integration of these DERs in the network [2.11]. The financing of DERs has, historically been driven by government who subsidise the price that the electricity generated is traded at; therefore the lower the initial capital outlay, the more financially viable a DER project is, especially if there can be a guaranteed price per MWh for the electricity generated.

Traditionally, DNOs employed a “fit and forget” approach, as the volume of installed DERs was low and this met the requirements of an efficient, economic network. However, with the increased saturation of DERs around “hotspots”, the amount of available capacity has reduced over time and the “fit and forget” approach was no longer viable [2.17]. To ensure new generation connections were offered without a long lead time, or expensive reinforcement costs, there has been a paradigm shift and a “connect and manage” approach is now being taken and DERs can connect quickly and cheaply with certain curtailment clauses; non-firm connection is a commonly used term to describe this type of contractual offer [2.19-2.20].

ANM schemes, coordinated voltage control, dynamic line ratings, enhanced cyclic ratings, power factor control and automatic restoration are all techniques that can enhance the flexibility of the distribution network when there is an increased penetration of DERs [2.19-2.21], [2.23]. DNOs are taking an increasingly central role in the energy system due to the change in the generation mix, the growth in DERs and the need to cost-effectively balance the competing drivers of security of supply and the reduction of carbon emissions. The definition of a DSO is still under discussion, with each of the 6 GB DNOs having a broadly similar aim, which is to securely develop and operate an actively managed distribution system which comprises the network topology, customer demand, distributed generation, flexible DERs and the dynamic management of DSR Customers. See Figure 1 for the central role the DSO takes in managing the energy system.

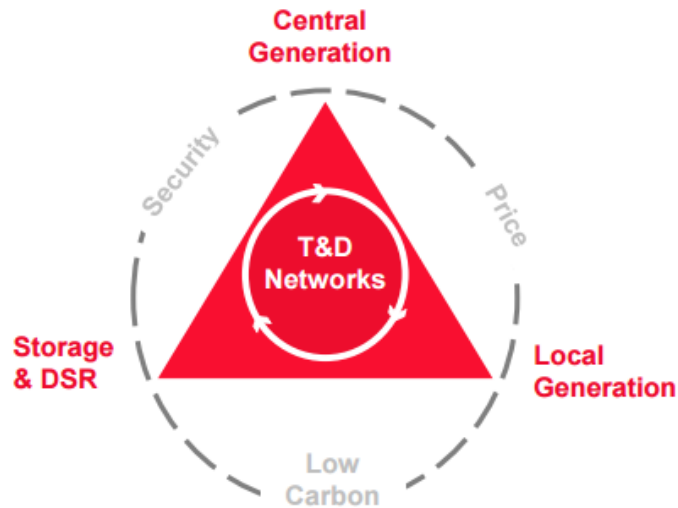

**Figure 1: The role of the DSO in the energy system**

Many electricity network assets (both transmission and distribution), which were installed in the 1960s (or before) and had an expected lifespan of 40 years (which has increased to around 60 years) are now approaching the end of their useful life [2.15]. Significant investment is required to replace or reinforce these assets; the majority of these costs are ultimately borne by the domestic customer [2.17].

DNOs and at transmission level, National Grid (in Scotland Scottish Hydro Electric Transmission and Scottish Power Transmission) have a licence obligation to maintain efficient and economic networks. For that reason, any network investments have to be well planned and coordinated to ensure the best value for the customer; the regulator (Ofgem) will only authorise necessary investment schemes where there has been a demonstrated need and also a benefit to the customer. For example, Ofgem authorised the socialisation of costs (£820m) of the Beaulay - Denny transmission network reinforcement [2.22], rather than these costs being borne by the Transmission Owner.

When there is the opportunity to add significant generation capacity (due to DERs) to the distribution network; this will then reduce the need to immediately reinforce assets (though reinforcement may be the right option as DNOs are asset owning businesses and any new asset will increase the “balance sheet” value of the distribution business) by deferring planned network investment, therefore providing value to the consumer whilst reducing carbon emissions. As there is a need to justify and demonstrate the stakeholder benefits of network investments, the integration of DERs will assist in the avoidance of asset replacement and reinforcement [2.17], whilst increasing the capacity of renewable generation installed on the network. Smarter solutions which prevent the

need to reinforce, for example ‘sweating the assets’ based upon dynamic ratings and seasonal firm capacities would reduce costs as the DNO would not have to reinforce assets to achieve an increase in the available network capacity [2.17].

Commercially, DERs involve a smaller initial outlay (to the developer) than traditional large scale generation would; when engaged in the frequency or capacity market DERs can offer significant revenue streams [2.14]. Additionally, DERs that are sited optimally to serve local loads can have a positive impact on the power flow and voltage profile of the distribution network [2.7], [2.9] and [2.24]. There will be a smaller consequence of failure if a DER was to be unavailable through fault or for scheduled maintenance than when a larger transmission connected power station was to be offline.

While it has been demonstrated that there is a need for installed DERs in distribution networks, without planning there could be significant impacts that will have a detrimental effect to the network. Further to this, there are benefits to be realised that can only be fully utilised if the DERs are optimally sited and sized.

### **2.3 Benefits and impacts of Distributed Energy Resources & Distributed Generation**

The optimal integration of DERs in distribution networks can be a solution to the environmental challenges and security of supply concerns that face the electricity industry. The nominal system frequency in GB 50Hz and this frequency is maintained by the synchronous machines on the system adjusting their power output so that supply and demand remain in balance at each time step. Whilst the rotational inertia is sufficient to ensure the frequency remains within limits, some deviation from 50Hz is expected and tolerated. When a generator trips off the system due to a fault, there is an instantaneous energy imbalance in the system [2.13].

If DERs are optimally integrated and managed, benefits can be realised and the impacts mitigated, then these DERs will assist in meeting targets to both diversify and decarbonise the energy portfolio [2.11]. As DERs are, by definition, installed in distribution networks (though this could be at 132kV or EHV) and certainly closer to load centres than existing large scale generation, there will be a reduction in transmission and distribution losses [2.3], [2.25]. There will be capacity released (for new demand) at primary substations where DERs are installed at lower voltages when generation is used to meet the local load. Therefore, investment can be deferred as there is a reduced need to

reinforce distribution assets due to the underlying demand growth; this offers a clear saving for the DNO and hence the consumer [2.6], [2.26].

In addition to the technical and economic benefits detailed above, there are clear environmental and societal benefits (such as the reduction in emissions from traditional centralised generation) from the increased penetration of renewable generation. Thus the diversifying of the GB generation portfolio and the reduction of carbon emissions due to the move from traditional gas and coal power stations to smaller capacity and locally sited renewable DERs is a desirable outcome.

Despite the numerous benefits, there are potential impacts of DERs that must be accounted for and when possible mitigated by planning the location and operation of the installed DERs. As the penetration of DERs increases within distribution networks, there are technical issues such as voltage rise, protection concerns, power quality issues (voltage flicker and harmonics) and system stability [2.24]. As the penetration of both small EV batteries and large scale BESS increases, due to the increase in electricity demand to charge these batteries, there is the potential for voltage drop at times of peak [2.24]

As the export from renewable DERs is typically intermittent and unpredictable, it cannot be relied upon when calculating the firm capacity at primary substations; which could negate the benefit of deferred investment, this investment may not be required if the DER export could be controlled. The contra-argument against DERs is that the DNO must consider the peak demand and the intermittency of the installed generation together in the context that additional load cannot be dispatched at times of peak demand if the local DERs are not exporting sufficient power; however, the short term cyclic and emergency ratings of transformers can mitigate this.

### 2.3.1 Benefits of DERs

The main benefits of DERs that have been identified from the literature ([2.3], [2.11-2.12], [2.24-2.26]) can be summarised as follows:

- Technical: Reduction in line losses;
- Economic: Investment deferral;
- Technical/Economic: Diversity of generation portfolio (reliability); and
- Environmental: Reduction of carbon emissions.

The technical and economic benefits can be further expanded below:

- Technical
  - Improvement of voltage control;

- Reduction of losses;
- Reduction of transmissions losses due to lower demand at a Grid Supply Point (GSP);
- Increased reliability of distribution network; and
- Reduction of peak demands at primary substations.
- Economic
  - Reduction of costs (as reduced losses increase the electricity supplied);
  - Investment deferral (as DERs will meet local load without degrading higher voltage assets); and
  - Increased revenue for developers as start-up and on-going costs associated with DERs are lower than conventional generation in some cases.

The specific benefits of each installed DER vary, dependent on location, type of prime mover, daily generation profile and local load profile [2.15]. DERs located close to an area of high load that has a generation profile similar to the underlying demand will result in lower power flow and therefore a reduction in distribution and transmission network losses [2.3].

The optimal placement and operation of DERs to coincide with demand peaks will benefit the distribution network (by deferring investment required) and reduce the import of electricity from the transmission network at GSP level and therefore negate the need for Short Term Operating Reserve (STOR) or Capacity Market Units (CMU) to generate at times of peak demand. If there is an economic benefit to be realised, National Grid will then defer investment in the transmission network and avoid the high costs per MW that are associated with STOR/CMU generation. However, the challenge (which remains dynamic and intertemporal) is for the DNO is to ensure that there is a sufficient mix of DERs and that the distribution network has sufficient capacity so that it is capable of meeting demand at times of peak such that distribution assets are not placed at risk of overload, damage or failure.

If load can be scheduled to coincide with periods of DER operation, then the technical, economic and environmental benefits of the installed DERs will be greater. This is especially true for generation export from PV as, typically, the peak export from PV is at times of low load (mid-afternoon) [2.27]. If however, new load can be scheduled at this time, there will be additional benefits to the DNO by the levelling of the demand curve and the PV generation export is then used to supply load that would otherwise require expensive, generation purchased from the capacity market [2.14]. In addition to levelling the load curve, the intention is to load shift by increasing the base load in the afternoon (or another time of low load); which will shift the load from times of peak to these times



of both low load and when there is high availability of generation export. It is not sufficient to increase demand at times of low load without ensuring that additional generation can be utilised also.

As the technical benefits of DERs are realised, the subsequent economic results will benefit both the DNO and the consumer. For example, the reduction of distribution losses where local generation is being used to supply local demand will reduce the burden on higher voltage assets, especially if the DER export is coincident with the time of peak demand and this will reduce the cost of energy supplied or defer investment costs required to reinforce the network which will benefit the DNO and ultimately the consumer with lower Distribution Use of System (DUoS) tariffs in the short to medium term.

Over the period 2020-2050, it has been forecast in one study, that with the adoption of the full suite of smart technologies, there could be savings of “*between £3.25bn and £17.7bn*” in the cost of GB network reinforcements [2.17]. However, the magnitude of these savings is highly dependent on the uptake rate of LCTs [2.17]. The extreme values of these ranges correspond to the low and high scenarios for future LCT penetration rates from the “*DECC Scenarios*” [2.17].

### 2.3.2 Impacts of DERs

Transmission and distribution networks were historically designed for power to flow from higher voltages to lower voltages, and despite the benefits detailed above, there are issues raised by the installations of DERs and the bi-directional power flows they produce [2.9]. Thermal limits are at risk due to the magnitude of the power-flow, which will place the distribution network under stress and overload and degrade assets which will reduce the time to reinforcement; this will necessitate further unplanned network investment [2.26]. Reverse power flow may cause problems with protection control equipment designed on the assumption that there is only forward power flow.

The improvement of the local voltage profile and a reduction in distribution line losses (due to the location of the DERs) were identified as potential benefits of DERs [2.11]. The sub-optimal location or operation of DERs at HV/LV can, in addition to the reverse power flows, cause technical issues such as voltage rise (at times of high generation export and low load), poor power quality, protection concerns and the system stability is required to be monitored and actively managed [2.24]. Where they have been installed and operated sub-optimally, there could be a degradation of the voltage profile and an increase in distribution line losses; though the unmanaged additional demand expected to be realised from the uptake and the increased penetration of multiple EVs (which, when

operated as responsive demands can be advantageous to the DNO) could result in local voltage drop, which could push customer volts out of limits.

As the installed capacity of DERs on the distribution network grows, the potential for voltage rise increases - assuming coincident generation export. Typically, the active voltage control point is at EHV (i.e. at the primary substation) and the voltage drops along the HV/LV networks when loaded. In GB, HV/LV transformers typically have a nominal voltage of 11kV to 400/230V. The winding ratio of these transformers is 11kV to 433/250V. The statutory voltage which DNOs are compelled to supply to LV connected customers is 230V +10% -6% (ESQCR 2002), this is a range of between 253V to 216V.

On an LV distribution network, under a load scenario, the voltage drops across the HV feeder and the HV/LV transformer giving an LV voltage of 240V at the transformer secondary. The voltage drop along the LV feeder would result in a feeder end voltage of up to 216V (ESQCR 2002 limits are 230V +10% -6% - so this gives an upper limit of 253V). In this load scenario, LV connected customers are supplied with a voltage ranging from 240V to 216V (voltage drop is planned to ensure that the limits are met, but 216 V would be a worst-case example rather than the expected voltage) depending on their location on the LV feeder the stochastic behaviour of the other connected loads.

Under a lightly loaded scenario, the HV network and HV/LV distribution transformer voltage drop is negligible, meaning the HV/LV transformer secondary voltage is closer to 250V and the LV feeder end voltage is close to 250V. However, when the export of LV connected DER coincides with minimum load and reverse power flow occurs; there could be voltage rise on the LV circuit. With a moderate amount of DER export, the HV/LV transformer secondary voltage will remain close to 250V, however the LV feeder end voltage may increase towards the upper voltage limit (i.e. 253V).

If the HV/LV network has significant DER export, the HV/LV transformer secondary voltage may increase above 250V, thus compounding the LV feeder end voltage rise and risk breaching voltage limits. This issue has only recently been observed in the UK (but this is a more common problem with PV in Germany) and investigations into methods of mitigation have not yet been concluded.

There is the possibility that, as more DERs are installed, there could be impacts upon power quality such as voltage flicker and harmonics. With the exception of directly connected synchronous machines, DERs such as PV, wind or BESS are connected behind inverters. This causes waveform

distortion as the inverter, simplistically, rebuilds a sinusoidal waveform through thyristor switching [2.9], [2.10] and [2.24]. Harmonic distortion caused by thyristor switching is a non-linear event, and the understanding of multiple coincident units firing at the same time has not been studied in depth. If DERs are not installed on the distribution network in a managed way then there is a risk of system instability (or an increase in instability due to the low inertia of some types of DERs) [2.13]. Instability could be attributed to larger generators losing synchronism with other generators nearby and this will have a greater impact on the network than if smaller generators were to become unstable. However, as large generators are replaced (in the medium to longer term) by DERs with a smaller installed capacity, there is an increased risk to the system, for the following reasons [2.13]:

- Large generators would only lose stability in the event of a significant disturbance and low network inertia;
- When large generation units are operating there is an increase in the inertia and there is a reduced potential of secondary tripping due to the loss of a single generator;
- With increasing penetration of inverter connected DERs, there will not be an increase of the inertia in the network; and
- Replacing larger generation units with smaller DERs has the effect of reducing the inertia, and thus increasing the risk of a consequential trip.

The increased capacity of DERs in distribution networks will have negative impacts upon fault currents and fault levels. DERs located close to existing substations where the break duty or make duty of the switchgear is close to or breaching ratings may require either new re-rated switchgear to be installed (at a significant cost) or a fault level reduction solution. This solution could be in the form of running busbars split or auto-close schemes to be commissioned. The magnitude of fault level impacts of DERs should be assessed on a case by case basis dependent upon the contribution from the DER and the specifics of the connection [2.7-2.8].

Islanding can be an issue with DERs and hard wired protection schemes (such as intertripping) are expensive and complex. Whilst cheaper loss of mains alternatives such as Rate of Change of Frequency (RoCoF) and Vector Shift are available, they are generally less reliable and may operate when not required (causing nuisance tripping) and this can cause unnecessary disconnection of DERs in response to a non-loss of mains event [2.30].

The main impacts of DERs that have been identified [2.4], [2.7-2.10], [2.28-2.31] can be summarised as follows:

- Technical: Voltage rise, protection and fault level issues;

- Economic: Increased network investment costs due to fault level solutions to be installed and reinforcement investment which is required to accommodate DERs (such as to mitigate the reverse power flows breaching thermal constraints); and
- Environmental: Pollution, this includes, noise, visual and additional emissions from conventional DERs (which are not renewable) installed close to load centres on the HV/LV networks.

The technical and economic impacts which were summarised above can be expanded to give a comprehensive list below:

- Technical
  - Voltage regulation (rise or drop) outside of statutory limits (dependent on generation or unmanaged demand);
  - Increase in losses;
  - Reverse power flows;
  - Unbalance;
  - Harmonics;
  - Exceeding fault levels;
  - Risk of islanding; and
  - If fault levels reduce because conventional plant is displaced by inverter connected sources this can cause power quality problems.
- Economic
  - Increased investment in asset reinforcement due to impact of generation on thermal constraints or the ability of transformers to accommodate large reverse power flows; and
  - Increased investment in fault level solutions which are required to be installed at primary substations with high penetrations of DERs.

The intermittent nature of renewable DERs will cause issues when calculating headroom in a passive fashion at primary substations and may require further network investments before additional load is connected. However, over time it may be clear that the additional load was mitigated by the export from the intermittent DERs and the investment was not required. The over engineering of distribution assets is not encouraged (but networks do need to include allowance for the uncertainty of future load connections so some level of over-engineering is inevitable). This is not an efficient or economic way to operate a distribution network and this is a view held by the regulator who takes this into account when DNO allowed revenues are then calculated for each subsequent price control period.

Despite the potential for negative technical and economic impacts , both on the network and those that will affect DNO long term investment planning, when there are appropriate planning methods and tools supported by optimal DER operation schedules, these impacts can be mitigated and managed.

### 2.3.3 Summary of Benefits and Impacts of DERs

Despite the numerous benefits from the installation of DERs in distribution networks, these can only be fully realised if the DERs are both optimally sited and intelligently managed to meet load or to operate at times of system need. DERs may realise lower network reinforcement costs by deferring investment in distribution assets, but the sub-optimal integration of DERs could increase costs, as when the location is close to fault points, there will be an increased contribution to fault currents which will necessitate further network investment to resolve the fault level issue.

If significant new load is introduced to the network in an unmanaged form, then there could be issues that impact on the network such as voltage drop. By actively managing the network there will be an increase in operational costs, but by deferring reinforcement there will be a larger reduction in both network investment and reinforcement costs. It is clear, that whilst there are technical and economic benefits that can be realised from optimally installed DERs, there are also significant issues that, when unmanaged and not accounted for, could result in both technical and financial implications for the DNO. However, there are planning approaches that can be used to assist in the optimal integration of DERs; it is the use of these planning approaches that will be tested in this thesis for the multiple stakeholder benefits - with minimal impacts.

## 2.4 The Impact of EVs on Distribution Networks

There is an increasing focus on reducing carbon emissions to comply with the challenging EU environmental targets, such as the target that 15% of energy is to be generated from renewable sources by 2020 [2.16], [2.32].

When this research commenced in 2009, the EV world was in its infancy and it was (now optimistically) forecast that 10% of the 33.3 million vehicles in the UK would be electric powered by 2020 [2.33]. As has been seen, these predictions were incorrect, the worldwide recession and the reduction in the price of oil, which negatively impacted multiple sectors over the past decade, were both reasons for the slower than expected uptake of EVs. However, the last 5 years have seen a surge in demand for EVs in the UK; new registrations of EVs have increased from 3,500 in 2013 to ~140,000 in 2018 [2.34], Figure 2 below [2.34] shows the growth in EV registrations since 2015 in the UK.

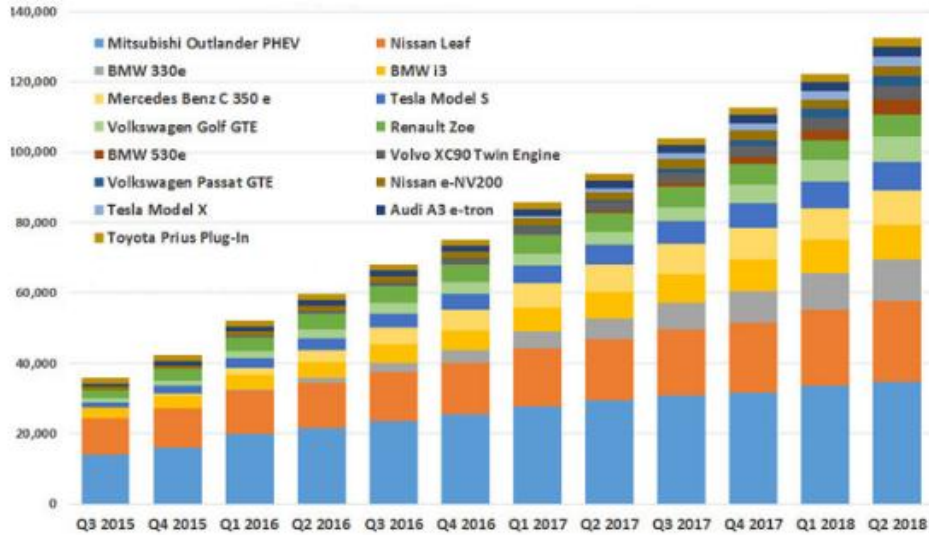

Figure 2: EV registrations by type (UK) 2015 – 2018

There has been an observed 300% increase in the number of EVs registered in the UK, when comparing total EV registrations from January 2016 with January 2019 (from 50,000 to ~200,000) [2.35]. National Grid’s Future Energy Scenarios (FES) 2018 predicts that in the UK there will be 36m EVs by 2040 [2.36]. These timescales and projections dovetail with the UK Government undertaking that “by 2040 there will be an end to the sale of all conventional petrol and diesel cars and vans” [2.37]. While only around 500 EVs were registered each month during the first half of 2014, this has now risen to an average of almost 5,000 per month during 2018 [2.35]. See Figure 3 below [2.35] for a representation of the EV registrations (absolute) and also as a percentage of total vehicle registrations, for the previous 24 months.

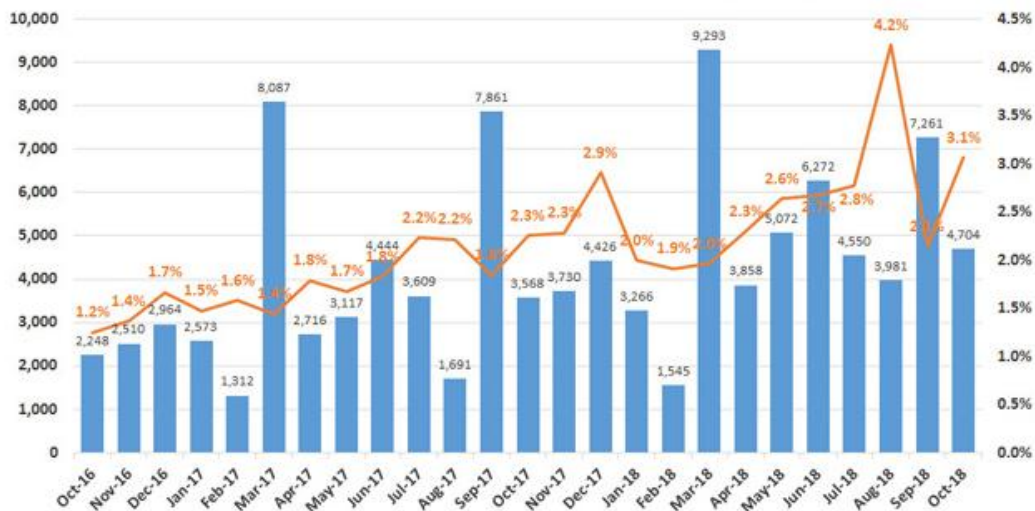

Figure 3: EV registrations (UK) 2016 – 2018

When the EV penetration does increase to the levels predicted both DNOs and TSOs must be prepared to meet the challenges associated with this increased load and the stress on the network. To ensure that the network remains secure and that there is no requirement for immediate and unplanned expensive network investments, a robust planning tool should be used to schedule and manage EV charging.

It is noted however, that this continuing increase in EV penetration year on year is dependent upon the incentives currently being offered and if they were to cease, then the high uptake would only continue if there was then a significant reduction in the cost of EVs (or more specifically a reduction in the cost of the EV battery technology). If however, the cost of battery technology was to drop and the incentives remained in place, there would then be a faster than expected increase in EV uptake and DNOs will have to proactively prepare for this worst-case scenario (from a network perspective), but perhaps best-case from an environmental perspective.

As the number of EVs in the UK increases, there will be a significant burden placed upon DNOs. As consumers are expected to charge the EV battery daily, this will result in capacity issues on distribution substations and feeders, which, unless addressed will cause overloads and place the network at risk and customers will be at risk of losing supply. The cost to customers (in GB) to accommodate this increase in (peak) demand (due to EVs) was estimated in 2016 to be around £2.2 billion [2.38] by 2050. These asset investment costs would include significant cable and transformer reinforcements, which would ultimately be passed onto customers through their DUoS charges - with agreement from Ofgem through the DNO allowed revenue calculations for each RIIO-ED period [2.39].

The unmanaged charging of a single EV at a domestic property, for the average household (before taking account of Heat Pumps), means a doubling of the after diversity maximum demand (ADMD) to a peak of 2kW [2.38], which would not pose a problem individually, but the aggregated unmanaged charging of multiples EVs sharing the same LV feeder will increase the “evening peak”. Figure 4 shows a typical daily load profile with and without the addition of EVs [2.38].

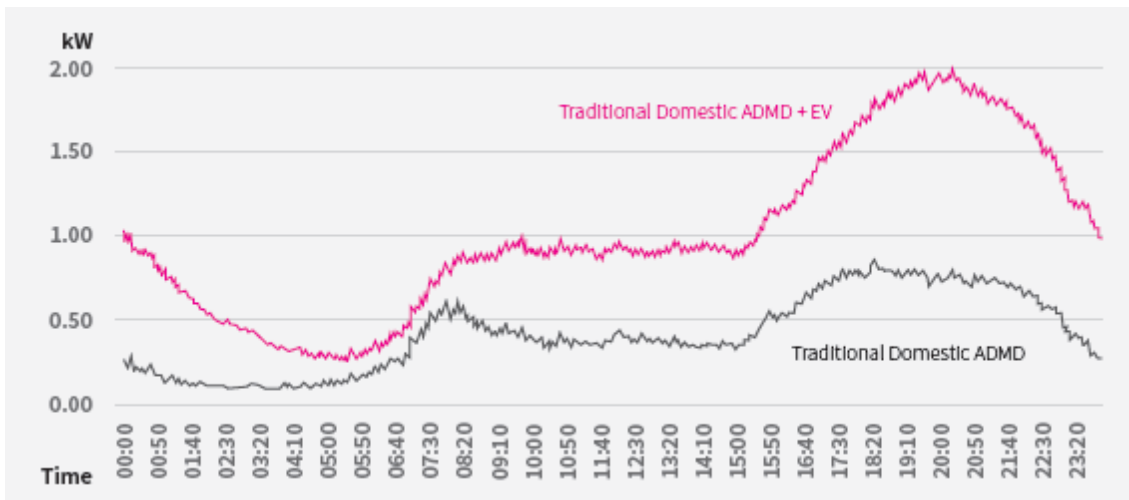

**Figure 4: Household ADMD With and Without EVs**

Large clusters of EV penetrations could result in adverse effects on the network [2.40] and unchecked, there would be a requirement for significant DNO investment to meet the new capacity requirements.

In addition to the network capacity issues, unmanaged/uncoordinated EV charging will impact upon the performance of the distribution network in terms of power losses and power quality [2.41]. Shifting EV charging times - by scheduling charging to times of low demand or times of high renewable generation - will assist in avoiding overloads and other related distribution level constraints and this can be an asset to the network [2.40].

As EVs can now be used as responsive demands (with managed/scheduled charging) and as these are included in the wider set of DER options, there can be value in using EV charging schedules to smartly manage load profiles [2.40]. The use of EVs as DERs will enable significant network investment to be deferred and these savings will be passed on to the consumer in the form of lower tariffs [2.39]. EV charging conducted during off-peak periods, typically 10pm-6am in GB (or when load is low and wind/PV export is high), is an efficient use of the generating plant and will assist in flattening the daily demand profile, which will improve generation efficiency [2.40] and remove demand spikes which otherwise would necessitate costly reinforcement schemes in the Ofgem approved Investment Plan to be brought forward.

There have been a number of studies conducted into the impacts of EVs on load profiles and the need to smartly manage charging schedules [2.17], [2.24], and [2.40]. The effect of large penetrations of EVs and how this will impact on distribution assets, efficiency and the distribution



network generally were examined. Various scenarios have been simulated, such as unmanaged charging [2.43], clustering charging to either peak or off peak times [2.44] and varying the charging speed through increased and reduced power levels [2.45]. Findings suggested that the existing distribution networks will be sufficiently sized to accommodate the expected increased (to around 40%) penetration of EVs, if charging is conducted at off peak times or times of low load generally [2.45-2.49].

Unmanaged EV charging will likely result in a rise in the number of network events - overloads, voltage deviations - if the charging of EVs occurs at times of peak. In simple terms, having randomly selected EVs on each feeder starting charging at various times will assist in avoiding these issues whilst ensuring that there are no spikes in the demand profile caused by the additional EV load. The impact of unmanaged charging on local voltage levels was discussed in [2.45-2.46] and it was observed that clusters of EVs charging concurrently will cause voltages to drop below pre-determined limits if charging is undertaken at times of high demand. As EVs are used only 4% of the time for transportation [2.46], this will enable - hypothetically - EVs to be used as responsive demands - DERs - for the remainder of the time.

As it has been established that EVs - or more correctly, the responsive charging of EVs - belong to the wider portfolio of DERs, it will only be possible to fully exploit the benefits from multiple EVs with a robust DER network planning methodology. Without DER network planning, the impacts of EVs on distribution networks will cause significant technical and financial issues for the DNO and ultimately the consumer.

## **2.5 Distributed Energy Resource Network Planning**

In general, the aim of DER network planning in distribution networks is to optimise the location, size, type, and operational envelope of an individual DER with respect to a number of objectives and real world constraints [2.21]. Network planning is essential for the optimal integration of the increasing penetration of DERs [2.51-2.53]. However, it is the process of multi-objective optimisation; which presents the decision maker with a suite of options where the chosen option will be dependent on the desired planning goals that can be of most value when network planning, as there is a degree of freedom when decisions are made [2.53].

The responsive charging of EVs is included in the wider portfolio of DERs, this will utilise the inherent energy storage capability of EV batteries and will assist in mitigating the intermittency of renewable sources of generation such as wind and PV. The precise siting, sizing and operation of EVs can

provide benefits to the network, the DNO and other stakeholders. However, if the location and charging schedules for multiple EVs are unmanaged, there could be issues such as excessive voltage drop and an increase in peak demand at distribution substations (which may not be appropriately sized) which will cause capacity issues and require investment to reinforce the assets. Unmanaged EV charging can pose a risk to the DNO and the consumer, but there are benefits for multiple stakeholders when EV charging schedules are intelligently managed to coincide with times of low load and the high availability of renewable generation export from DERs [2.53].

DER network planning can be of value to DNOs as it can assist in the identification of the optimal location to site new generation and also the type and size to be installed for maximum system benefits [2.53]. At each point of the network, the optimal amount of DER to be installed could be identified. The DNO has an obligation to provide a connection to the network, and while the DNO cannot refuse a connection enquiry, they can only charge the customer the (reasonable) cost to provide an economic and efficient connection, planning tools can assist in identifying these low cost connections.

DER network planning can be used to mitigate the detrimental effects of connected generation as networks approach saturation and one option to connect new generation could then be to offer “non-firm” or constrained connection offers. DER developers can benefit from the outputs of network planning tools and frameworks, as locations where there could be the greatest return - for least cost investment - from new generation can be identified. The DNO has an obligation to act in the interests of all customers, not just the customer who made the connection enquiry under consideration. Identifying “hotspots” where DERs could be sited quickly and cheaply will encourage the installation and increase the utilisation of renewable DERs and therefore move new generation connections away from congested networks which are more expensive to connect to as reinforcement is needed in advance of the connection being technically feasible.

To maximise the benefits and minimise the costs associated with the integration of DERs, analysis based planning tools are required to indicate exactly where on the network responsive DERs should be sited and how they should be operated. A planning methodology is required that should take into account the stochastic nature of power systems such as the fluctuations in DER export and the variability in the load curve. In this work, stochastic refers to the variability in both wind and PV generation export.

For network planning to be both effective and future proofed it must have a long term planning horizon and utilise a framework which is able to encompass the following examples of variability;

Variability in system properties:

- Increases in peak demand at primary substations (which will reduce available headroom);
- Changes in customer behaviour and the available technologies which will influence demand profiles (e.g. deployment of EVs, installation of PV or small scale domestic BESS);
- Changes in network topology - new substations or interconnection;
- Connection/disconnection of load/generation;
- Novel network management techniques such as ANM; and
- Changes in the regulatory environment.

Variability in decision variables:

- Changes in monetary value per MW of generation exported or curtailed demand due to DSR incentives; and
- Cost of reinforcement of distribution assets.

DER planning has been defined as finding the optimal DER size, type, operational envelope and/or location to achieve a variety of objectives whilst limited by constraints [2.24]. DER planning can provide valuable information for multiple stakeholders and inform planning decisions with regard to realising the potential benefits from installed DERs whilst minimising system impacts.

## **2.6 Optimal Integration of Distributed Energy Resources**

For the benefits from DERs in distribution networks to be fully utilised, the specific integration and operation must be optimal; with respect to the desired outcomes. As described previously, the optimal integration of DERs can provide benefits such as reduced losses and the deferral of network investment reinforcement costs. However, if DERs are not optimally integrated, there can be issues with reverse power flows, fault level, waveform distortion, and a requirement for increased investment to ensure generation export does not breach thermal constraints [2.21]. There are clearly financial and technical drivers and benefits to ensure a robust planning approach is taken and used.

As defined in Section 2.5, DER planning strives to optimise the location, size, type, and operational envelope of DERs with respect to a number of objectives and real world constraints. However, planning is not just a process carried out on an ad hoc basis, when a long term view of the network is taken and the objectives are well defined, planning tools and methods can be used to ensure that all network activities (design, investment, interconnection, DER placement) are only undertaken (at the cost of the DNO) if there are clear benefits and that these meet the stated design objectives [2.24].

Most network changes are driven by commercial customer requests and so need to be accommodated at a cost fully funded by the third party.

The focus of this work is to design, test and present a network planning framework which will optimally integrate EVs by identifying the optimal location, size and operational envelope of a number of EVs when used as responsive demands; this will encompass the optimisation of a number of objectives simultaneously, e.g. to minimise line losses whilst maximising exported energy and maximising the penetration level of EVs, bounded by a set of constraints.

Historically, generation was connected under a 'fit and forget' policy where firm connections were offered where the generation unit was able to export its full capacity regardless of network configuration or the specific network conditions. However, the impact of new generation is assessed based upon worst case scenario planning, such as maximum export from every generator at each GSP at the time of minimum demand [2.50].

Due to the increasing penetration of PV, which broadly reaches maximum export mid-afternoon, which is typically a time of low load [2.27], this worst case scenario becomes more likely and therefore must be accounted for in design studies prior to connection. However, when a quicker and cheaper connection is desired, a DNO may offer a generator a non-firm quote with certain curtailment clauses where the export may be constrained at times of low load (or high generation from existing generation units who have previously connected under a standard connection agreement) [2.19-2.20].

As well as a simple curtailment scheme, the use of real time control and two way communications (between the generator and the network/agent) will form an ANM scheme which will exploit and utilise distribution assets (at no significant additional cost) to ensure the benefits from DERs are realised. Schemes such as coordinated voltage control, dynamic line ratings, power factor control and automatic restoration can increase the utilisation of the distribution network [2.19-2.20].

As DERs typically supply local loads at HV and below, the optimal location will reduce the electricity imported from the transmission network and therefore reduce both transmission losses and also distribution line losses from GSP to EHV and then to primary substations.

As wind farms are typically located on long rural radial feeders (either at 11kV or 33kV), if intermittent generation comes online at times of low load, there can be unexpected issues with voltage rise outside of accepted tolerances [2.20-2.21]; to remedy this, generation must be curtailed which is not acceptable to either the DNO or the generation owner [2.21].

Optimising the integration of multiple EVs - as responsive demands - on the distribution network could involve finding the optimal EV battery size, location, and operational envelope for a number of EVs based upon objectives and constraints. It is not expected that the location of EVs can be controlled as it is anticipated that consumers will continue to have the freedom to use the network as they do at this time. The challenge is to identify EV integration and operation configurations that yield the greatest value for the DNO and other stakeholders.

The DNO is obligated to run an economic and efficient network and as such may wish to minimise network investment costs whilst the generator owner may require maximising the utilisation of renewables with no curtailment; these objectives are clearly conflicting. The main driver for the use of a multi-objective optimisation technique is that conflicting objectives can be optimised simultaneously. Planning objectives cannot be examined in isolation, but a multi-objective approach should be taken. There is clearly a requirement to evaluate objectives with consideration as to how one objective interacts with every other objective.

Traditional mathematical optimisation methods which are used to optimise a single objective will not be sufficient to solve complex multi-objective problems, for this reason an optimisation technique which has the ability to approach multi-objective problems will be required. The selected technique will be required to incorporate multiple and conflicting objectives, technical constraints and integer and continuous variables [2.53].

The integration and operation of multiple EVs is a multi-objective problem and using the selected multi-objective approach ensures that all objectives can be examined simultaneously, then the optimal solution can be chosen by the Network Planner (or the DNO in conjunction with the developer) - based upon the specific objectives chosen and the network constraints [2.53].

## **2.7 Multi-Objective Network Planning**

When planning distribution networks at LV, HV and EHV, different stakeholder viewpoints and multiple conflicting objectives have to be reconciled - e.g. to minimise investment costs while maximising revenue and building a network that is economic, safe, secure and efficient for all users -

and used to inform decision making. Solutions are limited by thermal and voltage constraints and in the example given of managed EV charging, a fixed battery capacity, charger size and a maximum number of EVs that can be sited on each HV/LV node (based upon assumptions).

As traditional single objective optimisation methods are not appropriate to be used in this scenario, a multi-objective method which will consider multiple and conflicting objectives with rigid constraints simultaneously, is appropriate [2.53]. Each DER benefit or impact that the DNO wishes to maximise or minimise can be formulated into a planning objective. The actual decision to be made relating to the optimality of the multi-objective solution chosen is subjective to the decision maker based upon exactly which objectives have the most importance based upon the business objectives and for DNOs, the legislation in force at that time.

Whilst mathematical optimisation techniques can be utilised, they are only of use when dealing with a single objective (or multiple objectives encoded as a single objective metric) and the representation of the physical system they model is usually simplified which will mean that accuracy (and value) is lost. An effective way to approach complex, non-linear optimisation problems is to use a Genetic Algorithm (GA). A GA is a search method based on the principles of evolutionary theory and is the most popularly used Evolutionary Algorithm (EA) [2.53].

#### 2.7.1 Optimisation Methods

This section will introduce GAs, MOEA and SPEA2; however there will be a more detailed exploration of these in Chapter 3. GAs can be used with non-differentiable objective and constraint functions and non-convex objective functions. Heuristic techniques have the ability to use more complex models, but in doing this the accuracy of the result can be lessened since while the model is richer, the required time for simulation is increased (it is noted that the SPEA2 method has a long simulation time).

In general, to solve a multi-objective DER planning problem the framework must include an optimisation method that is able to:

- Optimise multiple objectives simultaneously;
- Handle any type of constraints and objectives; and
- Handle both integer and continuous decision variables.

MOEA are able to meet all of these pre-requisites. The fitness assignment procedure that is inherent in MOEA will permit the selection of any attribute (for example to maximise or minimise any of the following cost/losses/emissions) as a planning goal and/or planning constraint. The addition of constraint functions (such as a fixed battery size) does not in any way increase the complexity of the

problem for a GA. The GA search process is separate from the model and the objective evaluation [2.54].

A multi-objective problem does not have a single solution, but a group of optimal solutions named the Pareto Set. A solution belongs to the Pareto Set if it cannot improve in one objective without an increasing degradation to other objectives. The Pareto Set is the optimal set of solutions; each square dot on the Pareto Front represents a chromosome with (say) a specific size and location of an EV that is optimal in its own way with regard to the chosen objectives.

A Pareto Front can be of use to decision makers as it provides a visual representation of the solutions and the trade-offs between them. In some cases, a single solution from the Pareto Front will be all that is required when siting EVs as responsive demands. However, a diverse spread of solutions taken from the complete Pareto Front will offer the decision maker a wider choice of options. This will enable a solution to be chosen that best fits the specific objectives at that time - see Figure 5 below.

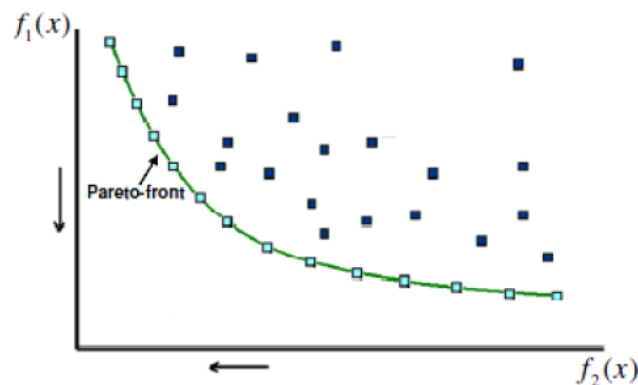

Figure 5: A Pareto Set for a two objective optimisation

These techniques have the ability to find several solutions of the Pareto Set simultaneously. MOEA are able to analyse complex objective functions and offer a “true” multi-objective approach where each objective of interest is analysed and optimised with respect to every other objective. However, multi-objective optimisation problems have a different concept of optimality to that which is commonly understood; Pareto Optimality, where it is impossible to make any one solution better without making at least one other solution worse.

Pareto optimisation does not make any statements on equality or preferential bias to any other solution; therefore any secondary bias would need to be accounted for either as a parameter/decision variable or by yielding optimised solutions based on the trade-off within the

Pareto Set. To obtain optimum results, MOEA are based on the evaluation of hundreds of chromosomes over hundreds of generations; hence, tens of thousands of evaluations are required to produce the most accurate results. As can be seen from Figure 6 below, the accuracy of MOEA will increase as the number of generations evaluated increases.

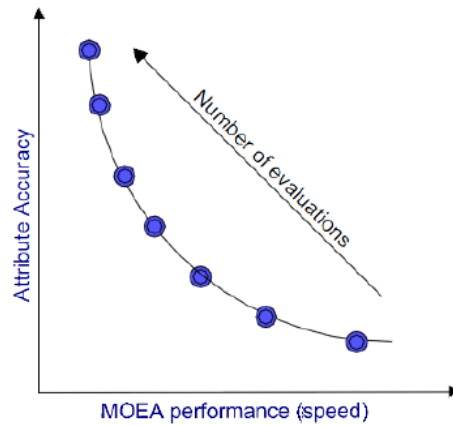

Figure 6: Simulation Accuracy vs. MOEA Speed Trade-off

SPEA2 is the selected technique for the presented DER planning tool and this belongs to the family of MOEA and is based upon the principles of EAs. SPEA2 is an elitist technique that preserves good solutions by making use of a novel fitness assignment where the fitness of each individual solution is modified according to the distance to its neighbours [2.55]. The technique ensures that as much of the search space as possible is explored and that “good” solutions are not lost in the iteration process but instead stored until the next generation. The focus on elitism in the SPEA2 algorithm (along with some other modifications) eliminates some of the limitations that had been recognised in the original SPEA [2.54].

In order to ensure that useful results are generated, the selected optimisation method must be able to deal with multiple and conflicting objectives and provide an optimal set of solutions which are situated on the Pareto Front [2.55]. To achieve an optimal set of results which are as close as possible to the Pareto Front, the MOEA must evaluate hundreds of alternatives over hundreds of generations [2.56]. Thus, a small saving in the simulation time for each generation represents a large saving in the total amount of computation time.

The presented planning framework and associated tool that will be used to optimise the integration of multiple EVs in the distribution network is based around the SPEA2 MOEA [2.56]. When comparing SPEA2 to other state of the art MOEA such as NSGA-II, MOGA and VEGA, it has been



shown that SPEA2 is more accurate [2.55], computationally faster and outperforms in both theoretical and practical applications and is the most efficient; even in a small number of generations [2.56].

## **2.8 Summary**

This chapter has introduced DERs in distribution networks and detailed the benefits that they can provide to the DNO and other stakeholders; however, there are network impacts from the sub-optimal integration of DERs with additional costs to be borne and technical issues to be mitigated.

An overview and introduction has been provided relating to the development and penetration of EVs and the challenges that this will place upon DNOs and TSOs. These impacts can be mitigated (by optimally managed EV charging) and there are additional network benefits (such as the increased utilisation of renewables) from this increasing penetration of EVs.

There are clear technical, economic, and environmental benefits to be realised when DERs are installed on distribution networks, but there are impacts which have to be mitigated and managed. It is the optimal integration of multiple EVs, when they are used as responsive demands (when included in the wider DER portfolio) which will be the focus of this work.

It will be demonstrated that (when EVs are used as responsive demands) the presented planning framework can be used to approach the EV integration and operation problem and can optimise the:

- Location on the network;
- Number of EVs;
- EV battery size; and
- Operational envelope of multiple EVs.

The case studies optimise the location and selection of EVs with pre-defined types. The battery size and operational envelope are not directly optimised in the presented case studies, but have been pre-defined by other work

When considering the optimal integration of EVs in a distribution network, which is a problem, encompassing both multiple and conflicting objectives, the use of a MOEA - specifically SPEA2 - is appropriate to underpin the presented planning framework and tool.

## 2.9 References for Chapter 2

- [2.1] CIRED, "*Dispersed Generation; Preliminary Report of CIRED (International Conference on Electricity Distribution)*", Working Group WG04, Brussels, Belgium, June 1999
- [2.2] CIGRE, "*Impact of increasing contribution of dispersed generation on the power system*"; CIGRE Study Committee no 37, Final Report, September 1998
- [2.3] N. Jenkins, R. Allan, P. Crossley, D. Kirschen, and G. Strbac, "*Embedded Generation*," London: Institute of Electrical Engineers, 2000
- [2.4] P. P. Barker and R. W. De Mello, "*Determining the impact of distributed generation on power systems: Part 1 - radial distribution systems*," in Proc. 2000 IEEE Power Engineering Society Summer Meeting, pp. 1645-1656
- [2.5] R. A. Walling, R. Saint, R. C. Dugan, J. Burke, and L. A. Kojovic, "*Summary of distributed resources impact on power delivery systems*," IEEE Trans. on Power Systems, vol. 23, no. 3, pp. 1636-1644, July 2008
- [2.6] D. Wang, L. F. Ochoa, G. P. Harrison, C. J. Dent, and A. R. Wallace, "*Evaluating investment deferral by incorporating distributed generation in distribution network planning*," in Proc. 2008 16th Power Systems Computation Conference (PSCC'08), pp. 7
- [2.7] E. J. Coster, J. M. A. Myrzik, B. Kruimer, and W. L. Kling, "*Integration Issues of Distributed Generation in Distribution Grids*," Proceedings of the IEEE, vol. 99, pp. 28-39, 2011
- [2.8] J. Morren and S. W. H. de Haan, "*Impact of distributed generation units with power electronic converters on distribution network protection*," in Developments in Power System Protection, 2008. IET 9th International Conference on DPSP, 2008, pp. 664-669
- [2.9] T. Ackermann and V. Knyazkin, "*Interaction between distributed generation and the distribution network: operation aspects*," in Transmission and Distribution Conference and Exhibition 2002: Asia Pacific. IEEE/PES, 2002, pp. 1357-1362 vol.2
- [2.10] R. G. Ellis, "*Power System Harmonics: A Reference Guide to Causes, Effects and Corrective Measures*," An Allen-Bradley Series of Issues and Answers, Rockwell Automation, 2001
- [2.11] G. Perpermans, J. Driesen, D. Haeseldonckx, R. Belmans, and W. D'haeseleer, "*Distributed Generation: Definition, benefits and issues*," Energy Policy, vol. 33, pp. 787-798, 2003
- [2.12] Energy Networks Association "*Engineering Recommendation P2 Issue 7 2019 Security of Supply*" 2019  
[http://www.dcode.org.uk/assets/files/Qualifying%20Standards/ENA\\_EREC\\_P2\\_Issue%207\\_\(2019\).pdf](http://www.dcode.org.uk/assets/files/Qualifying%20Standards/ENA_EREC_P2_Issue%207_(2019).pdf)

Accessed 29 August 2019

- [2.13] Engineering Recommendation G59 “*Recommendations for the Connection of Generating Plant to the Distribution Systems of Licensed Distribution Network Operators*”, 2018  
[http://www.energynetworks.org/assets/files/electricity/engineering/distributed%20generation/ENA\\_EREC\\_G59\\_3\\_Issue\\_4\\_\(2018\).pdf](http://www.energynetworks.org/assets/files/electricity/engineering/distributed%20generation/ENA_EREC_G59_3_Issue_4_(2018).pdf)  
 Accessed 19 December 2018
- [2.14] Ofgem, “*An assessment of the economic value of demand-side participation in the Balancing Mechanism and an evaluation of options to improve access*” 2017  
[https://www.ofgem.gov.uk/system/files/docs/2017/07/an\\_assessment\\_of\\_the\\_economic\\_value\\_of\\_demand-side\\_participation\\_in\\_the\\_balancing\\_mechanism\\_and\\_an\\_evaluation\\_of\\_options\\_to\\_improve\\_access.pdf](https://www.ofgem.gov.uk/system/files/docs/2017/07/an_assessment_of_the_economic_value_of_demand-side_participation_in_the_balancing_mechanism_and_an_evaluation_of_options_to_improve_access.pdf)  
 Accessed 19 December 2018
- [2.15] G. Strbac, C. Ramsay and D. Pudjianto, “*Integration of distributed generation into the UK power system*”, DTI Centre for Distributed Generation and Sustainable Electrical Energy, Imperial College London, 2007
- [2.16] Department for Energy and Climate Change, “*Climate Change Act 2008 Impact Assessment*,” 2009  
<https://www.legislation.gov.uk/ukia/2009/70>  
 Accessed 12 January 2019
- [2.17] Customer-Led Network Revolution (CLNR), “*Project Closedown Report*”, 2014  
<http://www.networkrevolution.co.uk/wp-content/uploads/2016/09/CLNR-G026-Project-Closedown-Report-FINAL-V2.1-070916.pdf>  
 Accessed 16 January 2019
- [2.18] National Grid “*National Electricity Transmission System Security and Quality of Supply Standard*”, 2017  
<https://www.nationalgrid.com/sites/default/files/documents/NETS%20SQSS%20V2.3.pdf>  
 Accessed 26 January 2019
- [2.19] S. N. Liew and G. Strbac, “*Maximising penetration of wind generation in existing distribution networks*,” IEE Proceedings Generation, Transmission and Distribution, vol. 149, no. 3, pp. 256-262, May 2002.
- [2.20] R. A. F. Currie, G. W. Ault, R. W. Fordyce, D. F. MacLeman, M. Smith, and J. R. McDonald, “*Actively managing wind farm power output*,” IEEE Trans. on Power Systems, vol. 23, no. 3, pp. 1523-1524, Aug. 2008

- [2.21] G. W. Ault, R. A. F. Currie, and J. R. McDonald, "Active power flow management solutions for maximising DG connection capacity," in Proc. IEEE Power Engineering Society General Meeting, pp. 1-5, 2006
- [2.22] Ofgem, "Determination on SHE Transmission's additional funding request and Opening Asset Value for the Beaulieu-Denny electricity transmission project", 2017  
[https://www.ofgem.gov.uk/system/files/docs/2017/01/decision\\_on\\_she\\_transmissions\\_request\\_for\\_additional\\_funding\\_for\\_its\\_beaulieu-denny\\_project\\_0.pdf](https://www.ofgem.gov.uk/system/files/docs/2017/01/decision_on_she_transmissions_request_for_additional_funding_for_its_beaulieu-denny_project_0.pdf)  
 Accessed on 27 December 2018
- [2.23] P. Djapic, C. Ramsay, D. Pudjianto, G. Strbac, J. Mutale, N. Jenkins, and R. Allan, "Taking an active approach," IEEE Power and Energy Magazine, vol. 5, no. 4, pp. 68-77, July-Aug. 2007.
- [2.24] J. A. Pecas Lopez, N. Hatziaargyriou, J. Mutale, P. Djapic, and N. Jenkins, "Integrating Distributed Generation into Electric Power Systems: A Review of Drivers, Challenges and Opportunities," Electric Power Systems Research, vol. 77, pp. 1189-1203, 2007
- [2.25] V. H. Mendez, J. Rivier T. Gomez, "Assessment of Energy Distribution Losses for Increasing Penetration of Distributed Generation", IEEE Transactions on Power Systems, Vol. 21, No. 2, May 2006
- [2.26] V. H. Mendez, J. Rivier, J. I. De la Fuente, T. Gomez, J. Arceluz, J. Marin, A. Madurga, "Impact of Distributed Generation on Distribution Investment Deferral", International Journal of Electrical Power and Energy Systems, Volume 28, Issue 4, pp. 244-252, May 2006
- [2.27] Customer-Led Network Revolution (CLNR), "A guide to the load & generation profile datasets Technical Note: Solar Photovoltaic (PV) Installations", 2014  
<http://www.networkrevolution.co.uk/wp-content/uploads/2014/08/CLNR-L071-Guide-to-load-and-generation-profile-datasets.pdf>  
 Accessed 15 January 2019
- [2.28] K. Kauhaniemi and L. Kumpulainen, "Impact of distributed generation on the protection of distribution networks," Developments in Power System Protection, Eighth IEE International Conference, pp. 315-318 Vol.1.
- [2.29] C. L. Masters, "Voltage rise: the big issue when connecting embedded generation to long 11kV overhead lines," Power Engineering Journal, vol. 16, pp. 5-12, 2002.
- [2.30] D. Tzelepis, A. Dysko, and C. Booth, "Performance of loss-of-mains detection in multi-generator power islands," The 13th IET International Conference on Development of Power System Protection, 2016
- [2.31] T. Tran-Quoc, L. Le Thanh, C. Andrieu, N. Hadjsaid, C. Kieny, J. C. Sabonnadiere, et al., "Stability Analysis for the Distribution Networks with Distributed Generation," in

- Transmission and Distribution Conference and Exhibition, 2005/2006 IEEE PES, 2006, pp. 289-294.
- [2.32] United Kingdom Department for Energy and Climate Change, "*The UK Renewable Energy Strategy*"  
[https://www.gov.uk/government/uploads/system/uploads/attachment\\_data/file/228866/7686.pdf](https://www.gov.uk/government/uploads/system/uploads/attachment_data/file/228866/7686.pdf)  
Accessed 29 December 2018
- [2.33] Department for Trade "*Vehicle licensing statistics: 2006,*"  
<https://webarchive.nationalarchives.gov.uk/20080109120820/http://www.dft.gov.uk/pgr/statistics/datatablespublications/tsgb/edition2006.pdf>  
Accessed 28 December 2018
- [2.34] The Society of Motor Manufacturers and Traders (SMMT), "*Electric Vehicle and Alternatively Fuelled Vehicle Registrations*", 2018  
<https://www.smmt.co.uk/vehicle-data/evs-and-afvs-registrations/>  
Accessed 11 January 2019
- [2.35] The Society of Motor Manufacturers and Traders (SMMT), "*EV Registrations*", 2018  
<https://www.smmt.co.uk/2018/09/august-ev-registrations/>  
Accessed 19 January 2019
- [2.36] National Grid, "*Future Energy Scenarios*", 2018  
<http://fes.nationalgrid.com/fes-document/>  
Accessed 27 January 2019
- [2.37] Department of the Environment, Fisheries and Rural Affairs (DEFRA), "*UK plan for tackling roadside nitrogen dioxide concentrations*", 2017  
[https://assets.publishing.service.gov.uk/government/uploads/system/uploads/attachment\\_data/file/633270/air-quality-plan-detail.pdf](https://assets.publishing.service.gov.uk/government/uploads/system/uploads/attachment_data/file/633270/air-quality-plan-detail.pdf)  
Accessed 08 January 2019
- [2.38] EA Technology "*Summary Report My Electric Avenue*", 2016  
<http://myelectricavenue.info/sites/default/files/Summary%20report.pdf>  
Accessed 12 January 2019
- [2.39] Ofgem "*RIO-2 Framework Decision*", 2018  
[https://www.ofgem.gov.uk/system/files/docs/2018/07/riio2\\_july\\_decision\\_document\\_final\\_300718.pdf](https://www.ofgem.gov.uk/system/files/docs/2018/07/riio2_july_decision_document_final_300718.pdf)  
Accessed 26 December 2018

- [2.40] P. Richardson, D. Flynn, A. Keane, "*Optimal Charging of Electric Vehicles in Low-Voltage Distribution Systems*" Power and Energy Society General Meeting, 2012 IEEE
- [2.41] BERR and Department for Trade Investigation into the Scope for the Transport Sector to Switch to Electric Vehicles and Plug-in Hybrid. Vehicles October 2008
- [2.42] J. P. Barton and D. G. Infield "*Energy Storage and its Use with Intermittent Renewable Energy*", IEEE Transactions on energy Conversion, Vol. 19, No. 2, June 2004.
- [2.43] S. Rahman and G. B. Shrestha, "*An investigation into the impact of electric vehicle load on the electric utility distribution system,*" IEEE Trans. Power Del., vol. 8, no. 2, pp. 591-597, April 1993.
- [2.44] J. Taylor, A. Maitra, M. Alexander, D. Brooks, and M. Duvall, "*Evaluation of the impact of plug-in electric vehicle loading on distribution system operations,*" in Proc. IEEE Power and Energy Soc. General Meeting, Calgary, AB, Canada, July 2009.
- [2.45] K. Schneider, C. Gerkenmeyer, M. Kintner-Meyer, and R. Fletcher, "*Impact assessment of plug-in hybrid vehicles on Pacific Northwest distribution systems,*" in Proc. IEEE Power and Energy Soc. General Meeting, Pittsburgh, PA, July 2008.
- [2.46] C. Gerkenmeyer, M. Kintner-Meyer, and J. G. DeSteele "*Technical Challenges of Plug-in Hybrid Electric Vehicles and Impacts to the US Power System: Distribution System Analysis, Pacific Northwest National Laboratory Report*", 2010.  
[http://www.pnl.gov/main/publications/external/technical\\_reports/PNNL-19165.pdf](http://www.pnl.gov/main/publications/external/technical_reports/PNNL-19165.pdf)  
Accessed 28 December 2018
- [2.47] S. Shao, M. Pipattanasomporn, and S. Rahman, "*Challenges of PHEV penetration to the residential distribution network,*" in Proc. IEEE Power and Energy Soc. General Meeting, Calgary, AB, Canada, July 2009.
- [2.48] G. A. Putrus, P. Suwanapingkarl, D. Johnston, E. C. Bentley, and M. Narayana, "*Impact of electric vehicles on power distribution networks,*" in Proc. IEEE Vehicle Power and Propulsion Conf., Dearborn, MI, September 2009.
- [2.49] W. Kempton and J. Tomic, "*Vehicle-to-grid power fundamentals: Calculating capacity and net revenue,*" J. Power Sources, vol. 144, no. 1, pp. 268-279, June 2005.
- [2.50] H. L. Willis, W.G. Scott, "*Distributed Power Generation. Planning and Evaluation*", Dekker, New York, USA, 2000, ISBN 0-8247-0336-7
- [2.51] R.B Hiremath, S. Shikha and N.H Ravindranath, "*Decentralised Energy Planning; Modelling and Application - a Review*", Renewable and Sustainable Energy Reviews, Volume 11, Issue 5, pp. 729-752, June 2007

- [2.52] S. Inglis, G. W. Ault, A. Alarcon-Rodriguez, and S. J. Galloway, "*Multi-objective network planning tool for networks containing high penetrations of DER*" in Universities Power Engineering Conference (UPEC), 2010 45th International, 2010, pp. 1-6.
- [2.53] G. Celli, E. Ghiani, S. Mocci and F. Pilo, "*A Multi-objective Formulation for the Optimal Sizing and Siting of Embedded Generation in Distribution Networks*", Power Tech Conference Proceedings, 2003 IEEE Bologna Volume: 1, pp. 23-26 June 2003
- [2.54] E. Zitzler, M. Laumanns, M. and L. Thiele, "*SPEA2: Improving the Strength Pareto Evolutionary Algorithm*", Technical Report 103, Swiss Federal Institute of Technology (ETH) Zurich, 2001
- [2.55] S. Rajashekar and G. A. Vijayalakshmi., "*Neural Networks, Fuzzy Logic and Genetic Algorithms: Synthesis and Applications*", Prentice Hall, 2004, ISBN 8120321863
- [2.56] P. Skolpadungket, K. Dahal, and N. Harnpornchai, "*Portfolio Optimization using Multi-objective Genetic Algorithms*", Proceedings of Computation, IEEE Press, Singapore, September 2007. IEEE Congress on Evolutionary Techniques

## **Chapter 3 - Multi-Objective Optimisation Methods**

With the increased penetration of DERs (including multiple EVs when used as responsive demands) in distribution networks, it is vital that a structured and flexible planning framework is in place to optimise their integration. The planning framework should encompass both multiple objectives and constraints and the outcome of the framework will be a suite of feasible and optimal solutions to a specific problem. Within this work, the aim will be to identify the optimal number, battery size and operational envelope for multiple EVs when integrated into the distribution network as responsive demands. This framework will be used to optimise multiple objectives simultaneously.

To underpin this planning framework a multi-objective optimisation method will be required. The EV operation and integration problem, which is the focus of this work, is a complex multi-objective optimisation problem with both integer and continuous decision variables. For this reason, it is appropriate that the method chosen is a MOEA, specifically, SPEA2.

This chapter will introduce the principle of optimisation methods in power system planning. It will outline and review; multi-objective optimisation, the concept of GAs and the principles behind MOEA are introduced, as is Pareto Optimality. Finally, there is a full description including SPEA2 and the strengths and weaknesses of this algorithm. The reasoning behind the choice of SPEA2 to be used to underpin the planning tool and framework in the EV operation and integration problem; along with the techniques used by this optimisation method are also fully detailed.

### **3.1 Multi-Objective Optimisation for DER Integration**

With the increased penetration of many types of DERs, (including EVs as responsive demands) Network Planners and DNOs have to ensure that a structured and flexible planning framework is in place to ensure that the DERs are not installed to the detriment of the network. The framework should be used to approach problems which have both multiple objectives and constraints and this will ensure that there are a number of feasible and optimal solutions to a specific problem are offered.

#### **3.1.1 Introduction to Multi-Objective Optimisation**

DERs have many potential impacts and benefits each of which can be modelled as an objective that is required to be optimised. Due to the interactions between these planning objectives, they should not be examined in isolation, but a multi-objective approach should be taken to ensure that they are considered concurrently. It is prudent to ensure that each objective is evaluated with equal



consideration and not weighted - any weighting can be carried out by the decision maker based upon the relative importance of each objective after the solutions have been created - as the interaction between the objectives impacts upon the potential solutions. If there are a number of conflicting objectives, then there will be multiple solutions, the specifics of which will be unique. Ultimately, the decision maker will have the freedom to choose which solution should be implemented.

The Pareto Set (which is expanded on in Section 3.2) will provide a number of optimal solutions from which the 'best fit' solution can be chosen to meet a specific planning problem. When planning the integration of multiple EVs on the distribution network, the desired outcomes could consist of optimising the battery size and location of a single EV unit, or finding the optimal number and location for multiple EVs.

The objectives of interest to the DNO when the optimal integration of EVs is studied may include (but are not limited to):

- Minimise losses;
- Maximise revenue;
- Minimise cost (of network reinforcement);
- Improve power quality;
- Improve voltage regulation;
- Maximise utilisation of renewables; and
- Reduce carbon emissions.

The planning problem which is defined by requirement to optimise the integration of multiple EVs as responsive demands in the distribution network will be categorised by the following:

- Multiple and conflicting objectives;
- Multiple perspectives;
- The stochastic nature of the power system;
- The dynamic nature of the network planning problem;
- Integer and continuous variables; and
- Any type and number of constraints and objectives.

To ensure that the optimisation method encompasses all of the conditions above, a more complex type of optimisation technique will have to be utilised; multi-objective optimisation. To identify a single solution for a true multi-objective problem requires solving the optimisation problem which will produce a suite of technically feasible solutions. After all feasible and optimal solutions have

been observed, a subjective decision making process has to be undertaken where the objectives that are of the most importance can be prioritised. Only then can the chosen solution be presented and evaluated against the objectives. Previously, multi-objective methods were over simplified by converting the problem into a single objective by focusing on only one solution of interest iteratively. By doing this, there would be a loss of accuracy and less value would be placed on the final outcome [3.1]. The reasons for not simplifying a multi-objective problem are detailed in Section 3.1.2 below.

### 3.1.2 Decision Making Process

The multi-objective optimisation process will present the decision maker with a suite of feasible solutions. There is then a choice to be made regarding which of these solutions (which are all in their own way optimal) should be used to approach the specific planning problem. It is more effective to delay the decision on which solution should be used until after the optimisation process has been completed; rather than using, for example a weighted sum method where the problem is converted to a single-objective by changing the multi-objective function into a weighted-sum of the objectives because:

- Objectives will not all have the same baseline (e.g. investment deferred would be measured in monetary terms, but access to renewables would be measured in MWh) for this reason a normalisation process would be applied and this would result in lost accuracy [3.2];
- This is a more practical and less subjective method (to get to the suite of feasible and optimal solutions) [3.2];
- A full range of solutions, each with an alternative is provided, this will allow a more informed decision to be taken [3.3];
- Keeping the multi-objective problem with no simplification ensures that there is no loss of accuracy [3.3]; and
- The interaction between objectives can be seen clearly.

### 3.1.3 Summary

DER planning and specifically, the placement, number and operation of multiple EVs is a multi-objective optimisation problem, with nonlinear and non-convex objectives and constraints; and with continuous and integer variables. To solve this would either require to simplify the problem to the extent that a solution would lose value or to use a complex multi-objective optimisation method.

To ensure that the results generated are appropriate to be used and will provide value to the DNO, the EV planning and integration problem must be approached with a multi-objective optimisation

method that can provide a suite of optimal solutions; these results are taken from the Pareto Set which is fully explored in Section 3.2 below.

### 3.2 The Pareto Set and Pareto Optimality

In an optimisation problem with both multiple and conflicting objectives, there will not be an individual solution that meets all the objectives equally; but a set of optimal solutions where no one solution is dominated by any other. This is called the Pareto Set which was popularised by Vilfredo Pareto in the late 1800s [3.1]. A solution belongs to the Pareto Set when it cannot improve in one objective without this improvement causing detriment to another of the objectives. The Pareto Set is the final set of solutions that cannot be improved upon (after the stopping criteria have been satisfied) - see Figure 7 below [3.4].

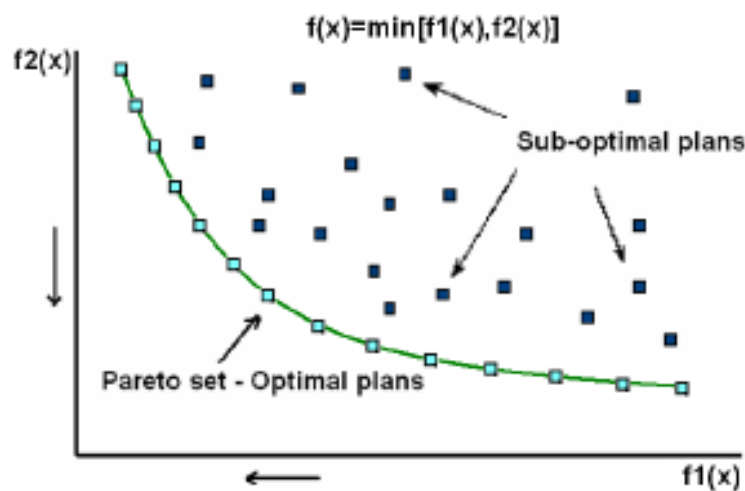

Figure 7: A Pareto Set for a two objective optimisation

The Pareto Front provides a visual representation of all the solutions and will enable the decision maker to decide exactly where the chosen solution lies compared to the other possible optimal solutions; essentially this shows which objectives can be prioritised. As there are a number of objectives to be satisfied, a diverse search space will enable a larger suite of solutions to be created, thus ensuring that all of the chosen objectives are addressed equally. The optimal set of solutions are to be found on the Pareto Front and solutions belong to this if there is no other solution that can be improved in one objective without a detriment to another - see Figure 8 [3.5].

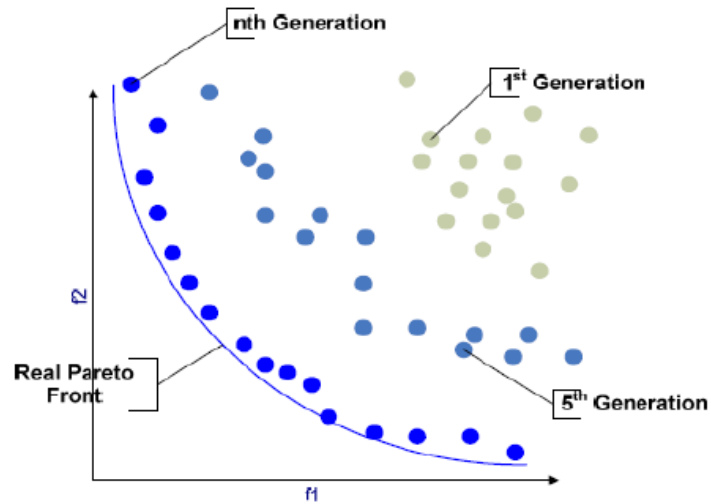

Figure 8: The Pareto Front created through n generations

As the number of generations increases towards  $n$ , the Pareto Front is improved upon and then becomes more accurate with each generation until either a stopping criterion is met or the maximum number of generations has been reached. In multi-objective optimisation, Pareto Optimality is achieved through the principle of dominance, i.e. “is solution A better than solution B”? The non-domination relationship determines the concept of Pareto Optimality. A solution is defined to be Pareto Optimal if it is not dominated by any other solution [3.1]. A Pareto Optimal solution cannot be improved in any one objective without this causing a detriment to another. A simple two objective minimisation is used to demonstrate this and the process is as follows, if:

- Solution 2 dominates solutions 1, 3 and 5; and
- Solution 3 dominates solution 5 and solution 4 dominates solution 5; then
- Solutions 2 and 4 are non-dominated and are both on the Pareto Front.

Based upon the above, in Figure 9 [3.5], solutions 2 and 4 are Pareto Optimal.

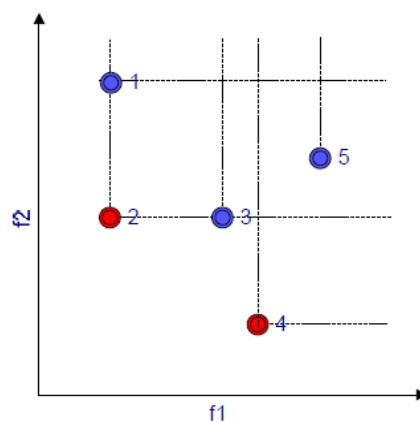

Figure 9: Pareto Optimality and Dominance

When the Pareto Front is created, analysis is carried out relating to the interactions between the objectives and how the improvement of one objective can impact on another. Different objectives can be attributed to separate stakeholder groups and therefore a choice can be made to optimise the objectives that are of most importance to specific stakeholder groups. This separation of objectives is of value as, dependent upon the objectives under consideration, there can be a visual representation of the Pareto Front used to assist in decision making.

### **3.3 Genetic Algorithms**

GAs are a particular type of Heuristic Method based upon evolutionary theory, that a population of individuals will, over time improve in one or more of their desirable characteristics (after a number of generations). As possible solutions are iteratively combined and refined using probabilistic rules, they converge towards the global optima which may take hundreds of iterations. The main advantage of GAs is that they can be used to successfully approach optimisation problems that traditional methods find difficult. For example, GAs can be used to solve problems with integer variables and non-convex and non-differentiable functions [3.6].

#### **3.3.1 Introduction to Genetic Algorithms**

An effective way to approach multi-objective optimisation problems is to use GAs; a GA is a search method based on the principles of evolutionary theory. GAs belong to a family of powerful search techniques called EAs; which are based upon simple concepts found in nature. The optimal (best) members of each generation are stronger and fitter than the last, as the strongest characteristics survive from one generation to the next. The family of EAs include GAs, and Evolutionary Strategies and Evolutionary Programming; but GAs are the most popularly used; the term “Genetic Algorithm” is now used interchangeably in place of “Evolutionary Algorithm” [3.6]. GAs can be used with non-differentiable objective and constraint functions and non-convex objective functions.

GAs follow the principle of evolution in nature, when there is reproduction between the solutions, the “best” characteristics of each solution (which are stored in chromosomes) are kept in the “pool” and there is a mutation of other sub-optimal chromosomes which modifies the characteristics. Over each iteration/reproduction stage, only strong members of the population will remain in the “pool” until the next generation. Not every mutation/modification will be of benefit to the population and weaker members will not survive multiple generations. This means that only the “best” individuals remain in the population over the long term; those which have the strongest characteristics in each chromosome.

A GA is based upon the premise that two (or more) 'fit' chromosomes (containing a number of genes each corresponding to an attribute) have a higher probability of producing a fitter 'offspring' at the next generation. The offspring that each generation has produced are evaluated and then are either stored or discarded based upon their 'fitness'. Using simple evolutionary theory, each new generation will have (on the whole) fitter offspring than the previous generation. GAs are based on a stochastic search through a population of solutions with a stopping criteria to be met; then the best performing solutions are stored in an external archive and combined with each other using a crossover operator. The purpose of this is to identify better solutions until they are either deemed to be suitable to be used or there has been a pre-set number of iterations reached.

To ensure that global optima are identified and the problem space is not confined to local optima, a random search operator is used (to mutate each solution) to expand the search space. In a similar way to evolutionary theory, the GA will only combine genes from good solutions and discard those genes that do not have the required attributes. Therefore, two solutions that have a number of desirable attributes, when combined, will produce a better offspring/solution with an improvement in at least one desirable attributes; then the process can continue until the stopping criteria is met. A fuller description of the GA process is given in Section 3.3.2 below.

### 3.3.2 Genetic Algorithm Process

Firstly, an initial population of solutions is created; each chromosome represents a different solution which will contain information relating to, for example, the EV battery size and the number of EVs. The initial population is crucial for diversity and speed of convergence towards the final set of solutions. Secondly, each chromosome is assigned a fitness value relative to the success of that chromosome with respect to meeting the chosen set of objectives.

GAs utilise a group of potential solutions which have been created after each generation/iteration, which will ensure that the whole search space is explored and the problems of local optima are avoided [3.4]. The use of a mutation operator provides an additional search element to the GA. This is vital to the process because it provides a means to ensure that the diversity of the population is maintained by exploring regions of the decision space that had not yet investigated [3.1]. The mutation operator is applied to the offspring that are produced after each generation, only once crossover has taken place is information interchanged between the "good" chromosomes; this will result in (after a number of iterations) a better solution being created.

Crossover consists of combining pairs of chromosomes from the mating pool (called “parents”) by “swapping” their genes to produce a pair of new chromosomes (called “offspring”). The process of crossover is repeated until every pair of chromosomes in the mating pool has been chosen. Individuals are then selected from the population and “copied” to the mating pool.

Each mutation/iteration ensures a change in the chromosomes of each fitter solution; this will impact (for example, the size of the EV battery or the operational envelope of a number of EVs) the specifics of each solution and after the iteration has been completed a new set of solutions are created. The addition of constraint functions (for example a maximum battery size) does not increase the difficulty of the problem for a GA. The GA search process is separate from the model and the objective evaluation [3.7].

The concept of elitism ensures GAs have a powerful advantage in the creation of ‘fit’ solutions; the ‘fittest’ individuals from the old population will be stored and then survive into the new population [3.1]. In practice, elitism works by comparing both offspring and parents and then choosing the fittest and storing them for the next generation, or by directly copying the fittest individuals and storing them until the next generation [3.9]. This process will ensure that fit solutions are never lost during the crossover or mutation process and they will be stored in the mating pool until they are replaced by a ‘fitter’ solution [3.1]. It has been documented that elitism is a key factor in a GA converging to a global optima [3.1].

An advantage of using GAs is that they can be coded without a deep mathematical knowledge of the problem; something that traditional mathematical optimisation lacks. For this reason, time can be spent modelling a realistic representation of the problem and not spent coding the optimisation. A disadvantage of GAs is that there is no guarantee of convergence towards global optima. An extensive list of advantages and disadvantages of GAs is given below.

### 3.3.3 Advantages and Disadvantages of Genetic Algorithms

As with other Heuristic Methods, there are a number of advantages and disadvantages to using GAs [3.6-3.8].

Advantages:

- They can be used with integer variables, non-convex and non-differentiable functions;
- The search process is separate from the remainder of the GA;
- They are simple to implement and modify, with a clear set of results that can be graphically presented to inform decision making;

- As GAs run a number of searches simultaneously, there is less risk of local optima, thus the simultaneous search process requires fewer iterations; and
- The addition of constraints within the process is straightforward.

Disadvantages:

- When a set number of iterations has been reached, there is no certainty that an optimal solution has been identified;
- Finding global optima is time consuming, hence this is not appropriate for problems such as generation scheduling in real time. However, when approaching planning problems there is no real time criticality;
- The initial set up has to be efficient, with the initial population, number of iterations and crossover and mutation rate all vital to the success of the GA. If the initial set up is incorrect, there is the risk of Genetic Drift, when the GA will only produce local optima, or if the mutation rate is too high, then the search will become random;
- If the initial population, or number of iterations is too large, then the overall computation time required to evaluate solutions becomes inefficient; and
- Simpler Heuristic Methods are more effective with linear functions.

For these reasons, a deep understanding of the problem space is required and methods such as GAs should only be used for complex multi-objective problems. The EV integration and operation problem, which is the focus of this thesis, has all the attributes that necessitate the use of a GA to identify optimal solutions which will inform the network planning and investment decisions.

### **3.4 Introduction to MOEA**

Optimisation techniques which use GAs or EAs are referred to as MOEA. MOEA do not combine a number of objectives into one single objective, as doing so would lose the detail of the problem. MOEA are suitable to be used for problems with both discrete and integer variables, such as the EV operation and integration problem.

SPEA2 which was developed by Zitzler is one of the most popular and advanced MOEA [3.9]. It is suitable to be used to approach multi-objective problems and is the best performing of the current suite of MOEA, based upon the distribution of solutions found and its success when being used to approach problems with conflicting objectives [3.9-3.11]. SPEA2 and its strengths and weaknesses will be explored in Section 3.5, and then the use of MOEA in network planning will be explored in Section 3.6. However, the remainder of this section will examine other popular MOEA and the reasons for choosing SPEA2 as the algorithm to underpin the presented planning framework are detailed.



However, it is the second generation of SPEA, SPEA2 that is currently used within network planning and DER integration that was utilised when the presented EV integration and operation tool was developed. Due to the observed accuracy, speed and the ability of SPEA2 to solve problems with multiple objectives and constraints, SPEA2 was appropriate to be used to underpin the planning framework and tool.

### **3.5 SPEA2**

SPEA [3.12] was first presented in 1999; however it is the second generation, SPEA2 which will be used to underpin this work [3.9]. It is an elitist technique that preserves good solutions by making use of a novel fitness assignment procedure where the fitness of each individual solution is modified according to the distance to its neighbours. This technique ensures that the entire search space is explored and 'good' solutions are not lost but are stored until the next iteration (generation). SPEA2 has a focus on elitism which, (along with other modifications) eliminates some of the faults that had been identified in SPEA [3.9].

In the original SPEA, good solutions are stored in a secondary population, the external archive. This is to ensure that these solutions will not be lost through the crossover or mutation process after each generation. As the elite population participates in the selection and crossover, the convergence towards the Pareto Front and global optima is faster. The SPEA fitness assignment procedure considers the diversity of the solutions over the search space. SPEA2 uses a population (P) of size N and an external archive (A) of size N that stores non-dominated solutions.

Accuracy, diversity and spread are the goals of MOEA generally and SPEA2 achieves these by implementing an enhanced fitness assignment procedure that increases selective pressure. The fitness assignment includes density information, thus regions of the search space which are less dense are fully explored. SPEA2 uses a truncation operator to ensure that a diverse set of non-dominated solutions is stored before each new iteration. Another feature of SPEA2 is that only members of the elite archive participate in the reproduction step, which ensures that only 'fit' solutions are stored to reproduce to the next generation.

The network planning tool that will be used to optimise the inclusion of EVs is underpinned by the SPEA2 algorithm. When comparing SPEA2 to other popular MOEA, SPEA2 was shown to be more accurate, computationally faster and outperforms other MOEA in both theoretical and practical applications [3.13]. SPEA2 is the most efficient MOEA, even in a small number of generations and for these reasons, it will be the used to underpin the optimisation method which is implemented in

the Multi-Objective Distributed Energy Resource and Network Evaluation (MODERNE) framework (which will be more fully explored in Chapter 5) which was developed initially by A. D. Alarcon-Rodriguez for his doctoral thesis in 2009 [3.5].

### **3.6 Multi-Objective Optimisation in DER Planning**

In recent years, MOEA, and specifically, SPEA2 have been used in real power system planning problems, and it is the output of these examples that support the use of SPEA2 as the method to underpin the presented planning framework.

The use of SPEA2 in power system and network planning has been studied extensively in recent years. In [3.14] when two objectives (total cost and energy not supplied) are optimised it was concluded that SPEA2 is more able to tackle complex problems such as distribution system planning. However MOEA are used [3.15] to identify the optimal location for DERs, with a view to establish those locations which provide the optimal benefits with regard to improving the voltage profile and reducing distribution losses; both objectives of interest in this thesis. SPEA was utilised [3.16] to minimise both investment costs and line losses and it was shown that this will produce a set of optimal solutions. However, these methods do not outperform SPEA2. In [3.17], when three objectives are proposed: installation cost, cost of losses and network voltage profile, SPEA2 is compared with the NSGA-II it was shown that SPEA2 performed better in terms of the quality (accuracy and spread of the solutions) and computational speed. This work will utilise SPEA2 to explore further, at a micro level, the optimal integration of multiple EVs in a distribution network.

The performance of SPEA2 - when compared to other MOEA - and the multiple stakeholder viewpoint that is output, all reinforce the position that the SPEA2 is the only MOEA appropriate to be used to underpin the network planning tool which is used to approach the EV operation and integration problem.

### **3.7 Summary**

In this chapter, the principles of multi-objective optimisation and the use of this technique in power system planning were presented, before an in-depth review of the use of Genetic Algorithms and Pareto Optimality in MOEA was undertaken. The benefits and limited drawbacks to SPEA2 were identified and the reasons for utilising SPEA2 as the optimisation method were detailed. The limitations of SPEA2 were minor when compared with the benefits and the previous success of SPEA2 in identifying optimal solutions to power system planning problems.

The next chapter introduces the EV operation and integration problem which will be the focus of this work. The planning horizon regarding identifying the optimal number, EV battery size and charger power output that are required to meet the chosen multi-objectives will be described. The existing techniques for EV integration (along with the advantages of using the planning framework) will be presented.

### 3.8 References for Chapter 3

- [3.1] K. Deb, *"Multi-Objective Optimization using Evolutionary Algorithms"*, John Wiley and Sons, 2001, ISBN 047187339X
- [3.2] F. Rivas-Dávalos, M. R. Irving, *"Multi-objective Optimization Challenges in Power System: The Next Step Forward"*, Electronics, Robotics and Automotive Mechanics Conference, 2007. CERMA 2007, 25-28 Sept. 2007 pp. 681 - 686
- [3.3] D. Savic, *"Single-objective vs. Multi-objective Optimization for Integrated Decision Support"*, Proceedings of the First Biennial Meeting of the International Environmental Modelling and Software Society, 24-27 June, 2007, Lugano, Switzerland, pp. 7-12
- [3.4] S. Inglis, G. W. Ault, A. D. Alarcon-Rodriguez, and S. J. Galloway, *"Multi-objective network planning tool for networks containing high penetrations of DER"* in Universities Power Engineering Conference (UPEC), 2010 45th International, 2010, pp. 1-6.
- [3.5] A. D. Alarcon-Rodriguez, *"A Multi-objective Planning Framework for Analysing the Integration of Distributed Energy Resources,"* Doctoral Thesis, University of Strathclyde, 2009.
- [3.6] V. Miranda, D. Srinivasan, D.M. Proenca, *"Evolutionary Computation in Power Systems"*, International Journal of Power and Energy Systems, Vol. 20, No. 2, pp. 89-98, February 1998
- [3.7] S. Rajashekar, G.A. Vijayalakshmi, *"Neural Networks, Fuzzy Logic and Genetic Algorithms: Synthesis and Applications"*, Prentice Hall, 2004, ISBN 8120321863
- [3.8] K.F. Man, K.S. Tang, S. Kwong, *"Genetic Algorithms: Concepts and Applications"*, IEEE Transactions on Industrial electronics, Vol. 43 No. 5, October 1996
- [3.9] E. Zitzler, M. Laumanns, M. and L. Thiele, *"SPEA2: Improving the Strength Pareto Evolutionary Algorithm"*, Technical Report 103, Swiss Federal Institute of Technology (ETH) Zurich, 2001
- [3.10] H. Mori, Y. Yamada, *"An Efficient Multi-objective Meta-heuristic Method for Distribution Network Expansion Planning"*, Proceedings of the 2007 IEEE Power Tech Conference, Lausanne, Switzerland, 1 - 5 July 2007
- [3.11] D. Kunkle, *"A Summary and Comparison of MOEA Algorithms"* North Eastern University, Boston, MA, 2005

- [3.12] E. Zitzler, L. Thiele, "*Multi-objective Evolutionary Algorithms: A Comparative Case Study and the Strength Pareto Approach*", IEEE Transactions on Evolutionary Computation, Vol. 3, No. 4, November 1999
- [3.13] P. Skolpadungket, K. Dahal, and N. Harnpornchai, "*Portfolio Optimization using Multi-objective Genetic Algorithms*", Proceedings of the 2007 IEEE Congress on Evolutionary Computation, IEEE Press, Singapore, September 2007
- [3.14] F. Rivas-Davalos, E. Moreno-Goytia, G. Gutierrez-Alacarez, J. Tovar-Hernandez, "*Evolutionary Multi-objective Optimization in Power Systems: State-of-the-Art*", Proceedings of the 2007 IEEE Power Tech Conference, Lausanne, Switzerland, 1 - 5 July 2007
- [3.15] L. Ochoa, A. Padilha-Feltrin, and G. P. Harrison, "*Evaluation of a multi-objective performance index for distribution systems with distributed generation*," CIRED 2005. 18th International Conference and Exhibition, 2005, pp. 1-4.
- [3.16] E. Haesen, J. Driesen, and R. Belmans, "*A Long-Term Multi-objective Planning Tool for Distributed Energy Resources*," in Power Systems Conference and Exposition, 2006. PSCE '06. IEEE PES, 2006, pp. 741-747.
- [3.17] H. Mori and Y. Yamada, "*An Efficient Multi-objective Meta-heuristic Method for Distribution Network Expansion Planning*", Proceedings of the 2007 IEEE Power Tech Conference, Lausanne, Switzerland, July 2007

## Chapter 4 - The Distribution Planning Problem for Electric Vehicles

As the number of EVs in the UK is now increasing rapidly after a number of years of slow growth, the unmanaged charging of high penetrations of EVs will cause significant capacity issues and requirements for reinforcement which DNOs will be required to manage. Recent industry predictions are that there could be as many as 36m by 2040 [4.1]. These timescales and projections dovetail with the UK Government undertaking that *“by 2040 there will be an end to the sale of all conventional petrol and diesel cars and vans”* [4.2].

GB DNOs may be required to invest £2.2bn in reinforcement solutions by 2050 to support the EV uptake (and associated demand) and assist in managing the impact upon the distribution network [4.3]. There exists sufficient spare demand capacity on the network to accommodate a high penetration of EVs, though only if EV charging is managed and takes place out with times of existing peak demand [4.3]. In 2018, there were approximately 200,000 EVs registered in the UK [4.4]. Despite the stress on the network that EVs can cause and the capacity issues that DNOs will be required to manage, EV batteries can be utilised to mitigate the intermittency of renewable generation export; and it is this that can provide significant value to the DNO and other stakeholders.

This chapter will further explore the EV operation and integration problem and will introduce the planning horizon regarding the optimal number, EV battery size and charger power output. A detailed formulation of the problem is provided and the demand model, which has been developed to assist with correlating the (additional) EV demand with the intermittent renewable generation export, is presented.

### 4.1 The Electrification of Transport

In the UK, it has been observed that there has been a significant increase in the uptake of EVs - which are vehicles powered either exclusively by batteries; Battery Electric Vehicles (BEVs) - or vehicles, powered in part by batteries combined with an Internal Combustion Engine (ICE), called Plug-In Hybrid Electric Vehicles (PHEVs). There has been an observed 300% increase in the number of EVs registered in the UK, when comparing total EV registrations from January 2016 with January 2019 (from 50,000 to ~200,000) [4.4]. National Grid's FES 2018 predicts that in the UK there will be 36m EVs by 2040 [4.1].

However, the benefit/impact of EVs will depend upon both the generation mix (renewable/fossil) when the EV battery is being charged and also the time of day charging takes place. If “smart” EV charging is undertaken at times of low load and is also planned to coincide with times of high renewable generation export, then there will be no requirement for expensive network reinforcements. Unmanaged EV charging, which is expected to take place at the existing time of peak demand, will require network investment and reinforcement to ensure that the additional demand (from EV charging) does not damage or overload distribution assets; if this was to be the case there would be safety and security of supply issues. To facilitate the increased penetration of EVs and to ensure that unmanaged EV charging can be accommodated, expensive quick response generation will be required to meet this additional demand in the short term. In the longer term there will be the need for new large generation units with significant new capacity to be planned and installed to meet EV demand.

The Department for Energy and Climate Change (DECC now BEIS) publication in 2007; *“Meeting the Energy Challenge”* suggests that there could be a decrease in carbon emissions and an improvement in network losses when local load is supplied by DERs sited close to load centres. The continuing electrification of the transport sector - which will result in a higher penetration of EVs - will pose challenges to DNOs but could assist in cutting UK carbon emissions. With the improved utilisation of DERs, the target of 15% of energy from renewables by 2020 becomes achievable [4.5]. To realise this will require both fewer traditional motor vehicles (which will result in lower carbon emissions) and an increase in the utilisation of electricity generated from renewables being used to charge EV batteries (at times of low load/high renewable export).

When EVs are used as responsive demands, a large number of small EV batteries - when aggregated - can assist in mitigating the intermittency of wind and PV; specifically at times of low load. Excess renewable generation which is not used or stored is curtailed under ANM schemes to keep voltage within statutory limits.

As the UK transportation sector accounted for (in 2015) around quarter of carbon emissions [4.6], addressing and reducing this is desirable. It can be seen from Figure 10 below [4.6], the contribution which transportation made in 2015 towards the overall UK CO<sub>2</sub> emissions. It is desirable that the transportation sector is no longer reliant on fossil fuels and that the renewable generation export is fully utilised (to charge EV batteries at times of low load) and not curtailed or exported to the higher voltage levels.

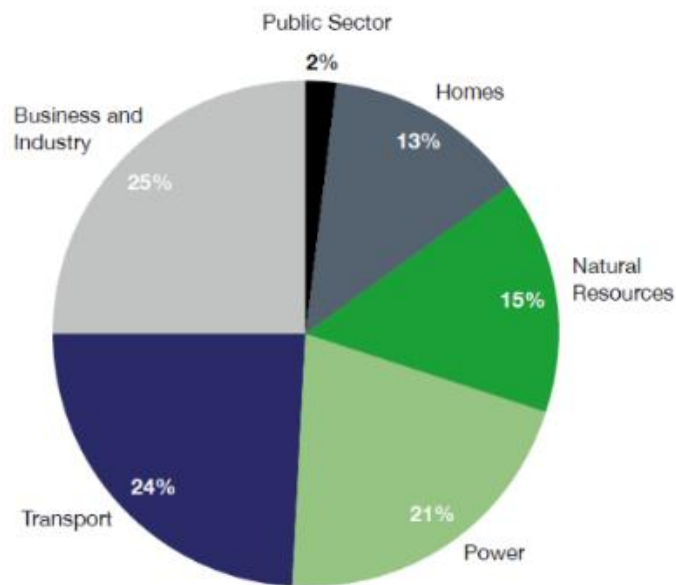

Figure 10: UK Carbon Dioxide Emissions 2015

It is clear that the benefits to be realised by the smart scheduling of EV charging will be greater as the penetration of renewables in the generation mix in the distribution network increases. An area of the network with high penetrations of both EVs and intermittent renewable generation (wind/PV) will benefit from the scheduled smart charging of EVs to ensure that the best value from renewables is achieved [4.7]. It is the adoption and evaluation of these charging strategies, when used to optimise multiple (and conflicting) objectives that will be the focus of this work

## 4.2 Electric Vehicles

### 4.2.1 Background to Electric Vehicles

EVs have existed in one form or another for around 200 years, but it was a number of breakthroughs in technology such as the development of the storage battery and the electric motor that led to EVs becoming widely available for use as a mode of transport. However, at the turn of the 20<sup>th</sup> century and as the USA became more prosperous, the motor vehicle became more popular (both the petrol and electric vehicle), it was the development of the Model T Ford in 1908 (which sold 15 million units and was approximately one third of the cost of an equivalent EV) that made the traditional motor vehicle both affordable and accessible; it was at this time that the popularity of the EV decreased.

During the 20<sup>th</sup> century the ICE powered almost all mass market motor vehicles. Despite a growing interest and research into EVs (prompted by rising oil prices) during the 1970s, a number of

prototypes were developed though there was no widespread increase in the sale of EVs; this was primarily due to the poor performance of EVs and the consumer's "range anxiety" which impacted significantly on the purchasing decisions made.

The perception and uptake of EVs changed in the late 1990s with the release of the Toyota Prius (which was a PHEV) and had a Nickel-metal Hydride (NiMH) battery. The Prius was released 10 years in advance of the Tesla Roadster which had an extended range of 200 miles on a full EV battery charge. There were now fewer issues relating to "range anxiety" and EVs became a viable option; it was then only the cost of the EV and easy access to EV charge points that were barriers to growth. The Tesla Roadster utilised a Lithium-Ion (Li-Ion) battery, which then became industry standard in most EVs over the next 10 years.

The last 10 years have seen a significant increase in the variety of EVs and PHEVs available in the UK; with large traditional motor manufacturers (e.g. Mitsubishi, Nissan, BMW and Renault) and new high profile developers such as Tesla - who aim to disrupt the existing marketplace and bring low(er) cost but high performance EVs to market - investing heavily in EV research, the installation of charging infrastructure and marketing. As the cost of an EV battery continues to drop (due to improvements in efficiencies and economies of scale) whilst battery performance increases, the gap between the cost of a traditional motor vehicle and an EV continues to narrow, thus making the purchase of an EV more accessible and attractive.

As described in Section 2.4, new registrations of EVs have increased from 3,500 in 2013 to a ~140,000 during 2018 [4.4]. Even small penetrations of EVs which are clustered around highly loaded distribution assets will result in capacity management issues which will impact upon GB DNOs. Either new regulatory frameworks will be required to ensure that there is no unmanaged charging of EVs permitted or (more realistically) there will be significant network investment required from the DNOs to reinforce infrastructure assets. The potential system impacts of multiple EVs upon the distribution network will be investigated in the next section.

#### 4.2.2 Impact of EVs on Distribution Networks

The detrimental impact on the distribution network of one EV being charged at a domestic property will be negligible, this is due to:

- The low power rating of the EV charger;
- The existing headroom available at distribution substations; and
- The known diversity of domestic loads.



It has been shown that the unmanaged charging of a single EV at a domestic property (for the average household) will double the theoretical (ADMD) peak demand [4.3]. As the number of EVs on an LV distribution feeder increases, the impact on the network becomes more significant and the DNO will be required to manage voltage, thermal and capacity issues. The unmanaged charging of multiple EVs is expected to negatively impact on the performance of the distribution network, in terms of power losses and a reduction in power quality (voltage profile, harmonics etc.) [4.8]. Conversely the managed charging of multiple EVs can assist in the delivery of network benefits to the DNO.

A paradigm shift in EV charging, where there is a movement from unmanaged charging to scheduled charging to coincide with the expected times of low demand and excess renewable generation export will assist in the avoidance of network overloads and will increase the utilisation of DERs. The widespread adoption of EVs will introduce new customer load profiles and a significant EV penetration at LV could result in adverse impacts upon the network [4.9]. The smart scheduling of EV charging will assist in achieving both peak demand reduction as well as the flattening of the load profile [4.10].

If EVs were clustered and located at a small number of distribution substations and charging was undertaken immediately when EVs returned to their charge points (during the evening peak), there would be significant investment required to increase the capacity of the local distribution network [4.11]. EV batteries may also be used as dispatchable storage units that will enable energy to assist the network at times of need; this is known as vehicle-to-grid (V2G) power [4.10]. A detailed study of this will be outside the scope of this work.

The unmanaged charging of EVs during the weekday peak period; typically 5pm - 10pm would result in an increase on the distribution transformer's peak load or the peak load observed on an LV feeder; this peak could be reduced with smartly managed EV charging schedules. Smart charging can assist in the deferment of asset reinforcement schemes at both LV and HV, though the benefit at HV is greater as the savings to be made are more significant. This will result in cost savings for the consumer and ensure that targeted network investment (at areas of reduced headroom) to ensure the optimal return (available capacity increase versus reinforcement cost incurred) for the DNO.

Figures 11 and 12 [4.12] below show the impact upon the distribution network and the increase in power consumption (on a typical day - during the peak demand period) as the number of EVs in a

managed area increases from an 11% penetration to a 61% penetration; which is an additional demand of almost 700kW at the time of peak. *Note the variance in the scale on the x-axis.*

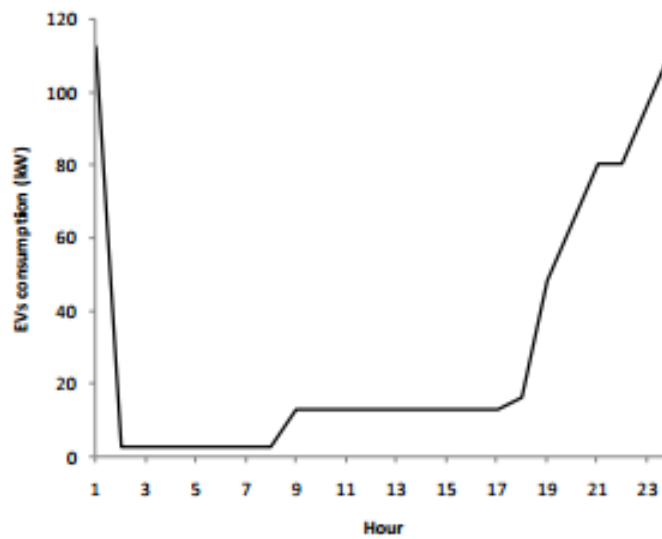

Figure 11: The Impact of Unmanaged EV Charging (low range)

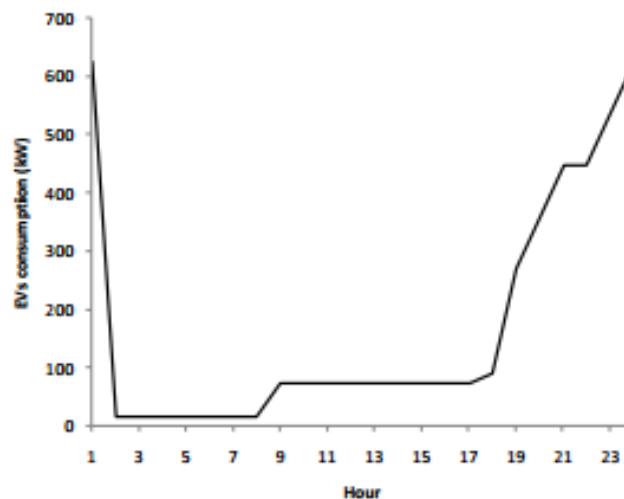
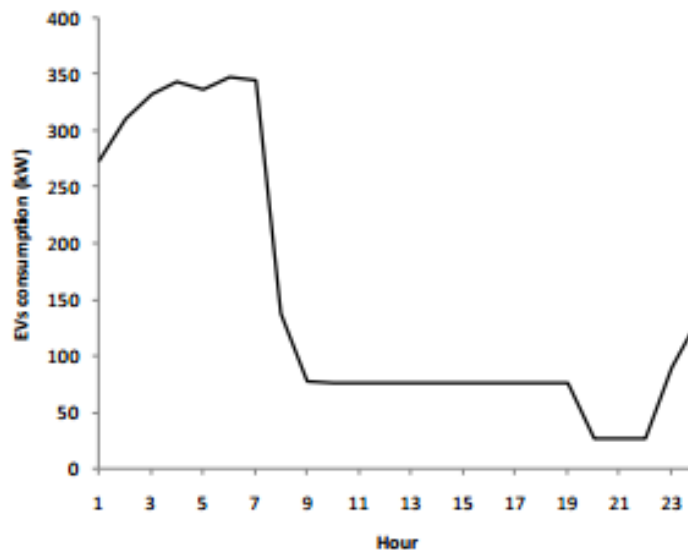

Figure 12: The Impact of Unmanaged EV Charging (mid-range)

In this work, the aim is to minimise the impacts of multiple EVs on the distribution network by optimising, based upon the chosen objectives, EV charging schedules. This is achieved by comparing various smart strategies including observing the impact of a variance in the number of EVs, EV battery size, charger power output and location of EV charging. Areas of the network can then be identified where managed EV charging will have increased value to multiple stakeholders and this can be used to inform investment planning and real time operational decision making.

The charging of EVs in off-peak periods (typically 10pm - 6am or 10am - 4pm) when renewable generation export is high (in proportion to base load) and base load is low is an efficient use of both the installed generation and the distribution assets; a flattening of the daily load profile will improve the overall generation efficiency [4.13]. There have been a number of historical studies conducted into the impacts of EVs on load profiles and the requirement to manage the charging of EVs at LV will minimise the risk to network assets [4.13-4.14].

Figure 13 [4.12] below shows the actual shifting of load that can be achieved when smart charging strategies are applied; note that the actual penetration of EVs is the same as in Figure 12 above, but the peak demand is lower due to the change in the demand curve.

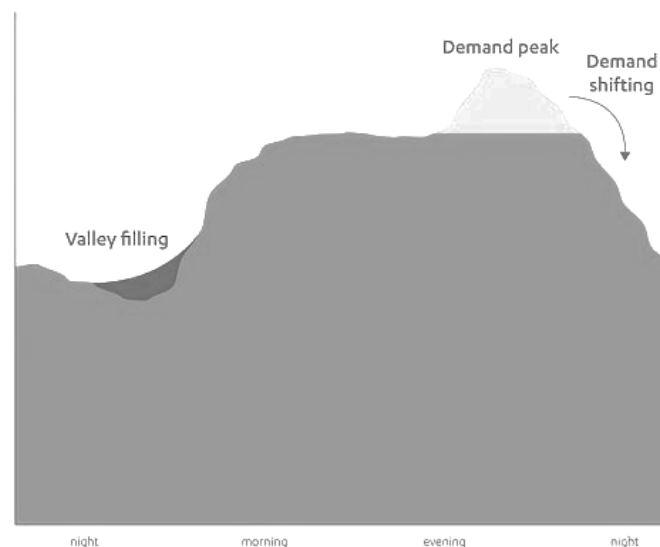

**Figure 13: The Impact of Managed EV Charging (mid-range)**

The impact of large penetrations of EVs on distribution assets and the impact that EV charging will have on the efficiency of the distribution network have been explored extensively in the literature. Dependent upon the studies examined, various scenarios have been simulated including unmanaged charging, clustering charging to peak/off peak times and varying the charging speed by altering the power output of the EV charger. Studies have shown that the existing GB distribution networks will be sufficiently sized and rated to accommodate a significant increased penetration of EVs. However, this is only the case when EV charging is undertaken at off-peak times; times of low load generally [4.15-4.18]. If EV charging was to take place at times of peak demand, there would be an additional stress on the network and as was stated previously the reinforcements required to mitigate this have a projected cost of £2.2bn by 2050 [4.3].

The impact of unmanaged EV charging on local voltage levels was studied [4.19] and it was observed that clusters of EVs on the same radial feeder, when connected to an individual distribution substation and charging concurrently, will result in voltage drop to below pre-determined limits, this issue is magnified when EV charging occurs at times of high load and low generation export at 11kV or below. Unmanaged EV charging will result in an increase in the number of observed network events; such as thermal overloads and voltage deviations. If EV charging coincides with times of peak load, the additional demand from EVs will cause network constraints to be breached. It is clear that unmanaged EV charging would necessitate significant network investment to reinforce distribution assets.

A method which could be implemented to introduce a level of mitigation would be to randomly select EVs on each feeder which would then commence charging at staggered time intervals and this would reduce the probability of spikes in the demand profile caused by EV charging. However, this procedure is neither smart nor scheduled charging, just the use of randomness to reduce peaks in demand. The presented network planning tool is used to identify the optimal operational envelope when scheduling the charging of multiple EVs. EV charging can enable the local load profile to be shifted and for the time dependency to be reduced [4.20-4.21]. The typical view of how the daily load profile can be manipulated (by smart charging/load management) is illustrated in Figure 14 below.



**Figure 14: Daily Load Profile Objectives**

Using appropriate communication and control technologies, it is technically feasible for the DNO or an aggregator to remotely manage and control EV charging. Managed EV charging can be used to minimise energy flows and demand at times of high energy costs and low renewable generation

export [4.22]. Analysing the impact upon the distribution network of the charging of multiple EVs requires a multi-objective optimisation approach which will ensure conflicting objectives and multiple stakeholder viewpoints are accounted for. To ensure the approach is appropriate to be used with a real world problem, results will be produced which are bound by rigid constraints, such as maximum battery size or maximum EV charger power output. EVs are yet to be deployed on a widespread scale, therefore it is important that analytical tools are developed and tested to enable the evaluation of the optimal integration strategies ahead of the expected mass market penetration of EVs.

An existing network planning tool has been further developed by the author to support the work of this thesis and is used to approach the problem of identifying optimal EV integration strategies. There have been analyses carried out on the impact of unmanaged EV charging to identify when and where network constraints would occur (based upon the worst case scenario) and which areas of the network will have the greatest need for intervention; based upon the magnitude of overload and expected time to reinforcement.

Once the base case of unmanaged charging has been established, there will be multiple scenarios simulated with the DVs being incorporated into each scenario. The DVs will be limited to:

- The location of the EV;
- The EV charger power output;
- The optimal number of EVs (at each node);
- The EV battery size; and
- The optimal charging time periods.

These DVs will be assessed against predetermined criteria (for fitness), the optimal operational envelope to be used when charging multiple EVs will be identified to maximise the utilisation of renewable generation export, whilst being limited by network constraints.

In simple terms, the presented planning framework will identify the optimal EV integration and operation configurations that yield the greatest value for the DNO and other stakeholders. Results will be presented that offer insights into the optimal integration of multiple EVs into a distribution network at HV/LV when used as responsive demands.

This will illustrate the impact on a typical distribution network of the inclusion of multiple EVs. Furthermore, the benefits to be realised when the specific placement and charging schedules of EVs

has been optimised will be identified. The exact placement and the operational envelope of EVs will be crucial to ensure the optimal network benefits are realised, whilst minimising the potential adverse effects on the network of the inclusion of multiple EVs.

The impact of EVs on the distribution network has been fully explored in the literature and it is clear, that without intervention, traditional distribution networks will not have sufficient demand capacity to incorporate the unmanaged charging of multiple EVs at times of peak. However, as has been shown, with scheduled smart charging, network overloads, voltage issues and network investment due to EV penetration can be avoided. The next section will introduce the planning horizon regarding the EV battery size, EV charger power output and also the assumptions made and the constraints which bound the problem.

#### 4.2.3 EV Charging and Model Assumptions

The impact of uncoordinated EV charging on a simulated network will be assessed and this will then be the base case that all other charging scenarios shall be measured against. Uncoordinated charging could be described as a “no control” approach, but it will provide a measure for a comparative assessment of the efficacy of the various smart charging strategies which are studied. In the unmanaged charging scenario, it is assumed that EV owners will charge their vehicles whenever they choose (which is expected to be when they return home at 6pm) and then the EV will charge for 8 hours or until the EV battery is full (based upon certain metrics and assumptions to be stated).

A 13 Amp domestic mains socket (which most standard EV charging units will be connected to) can provide 3kW of power which would result in a charging time of 8 hours to fully charge a 24kWh EV battery (from empty to full). An EV battery of this size would be sufficient for a driving range of 75 miles before there was a need for additional recharging. Due to uncertainties regarding the behaviour of EV owners, the battery size and the charger power output; a worst case scenario where all EVs charge their batteries from empty to full (24kWh) concurrently at 6pm; for the full 8 hours; a charger power output of 3kW was used to set the base case.

With the broad assumption used that an EV can travel 3 miles on 1kWh of charge, an overnight (full) charge would provide a 70 mile driving range [4.3]. If the EV had a yearly mileage of 7,900 miles, this would relate to approximately 22 miles per day [4.23]. Based upon this data, an EV with a full battery charge would return to the charge point at the end of the day with approximately two thirds

of the battery charge remaining, this would require only 8kWh of charge for to return the EV battery to full.

For the purposes of this work, an EV battery was characterised by the maximum storage capacity being available (at all times) and the maximum charging power being delivered at a constant level. To study the impact, a single EV battery was modelled in Matlab and this was characterised by the use of a Li-Ion phosphate battery (LiFePO<sub>4</sub>) battery. For the avoidance of doubt, the size of the battery will refer to the stored energy within the battery (kWh), though the battery capacity will be measured in Ah. However, it is the size (and therefore available power) of the battery that will be optimised, not the capacity.

The EV load model will be presented and these specifics include the basic formulae used to calculate the charging power required to fully charge one EV battery and then these are used to ascertain the magnitude of the additional load to be added to the baseline demand; dependent upon the chosen scenario and the EV assumed EV penetration.

### **4.3 Modelling EV Batteries as Responsive Demands**

The research in this work is underpinned by the simulated charging of a modelled EV battery (which can be varied in size - within limits), the power of the EV charger and the interactions between the EV batteries and the distribution network (based upon location, base demand and impact upon the distribution assets).

Li-Ion EV batteries, which have been shown to produce the greatest power output, have the highest energy density, are almost 100% efficient and have an estimated number of lifetime cycles that is equivalent to the expected useful life of a typical EV [4.24]. In this work, EVs are modelled as responsive demands and can easily be aggregated in number to increase the multiple system benefits to be realised by the DNO [4.25]. In general terms, EV batteries operate by importing electricity which will then be used to perform a chemical reaction and then that reaction is reversed to be used to export electricity when required [4.26].

In most batteries, the size is limited by the fact that the chemical reaction generally involves producing a solid material on the electrodes which eventually inhibits any further reaction from occurring [4.27]. The power rating and storage capacity of batteries are not independent of each other; they and the other characteristics depend upon the materials used in the electrodes. For

simplicity, and the purposes of this research, the EV battery will be modelled as a standard Li-Ion EV battery with the size (in kWh) being one of the DVs to be studied.

The adoption of batteries to be used in large scale energy storage projects, even in an aggregated form (using smaller batteries) as a Virtual Power Plant (VPP), is still in the early stages of research. However, the concept of using EV batteries as responsive storage has been gaining interest in recent years, as there is the potential to offer support to the network at times of need and to assist in managing the daily load curve. There is also a potential income stream for the battery owner to exploit when these services are sold to the National Grid. With the expected electrification of transportation and the projections for the uptake of EVs increasing, when coupled with the significant installed capacity of renewable generation, there is the opportunity for DNOs to utilise EV batteries (as a form of responsive storage) for multiple system and network benefits [4.25].

If a number of EV batteries are to be used as responsive demands or as a VPP, then there would need to be clear benefits which were put in place to incentivise the EV owner to take part in a DSR scheme. Because the EV would be unavailable at times when the battery is being used to support the distribution network, the EV owner would expect to be compensated. In addition, the EV would require a form of active management or control system to optimally dispatch the stored energy from the battery to the network when required.

EV batteries have been modelled extensively in recent years and have been explored in depth within the literature. The impact of multiple EVs on a distribution network and the use of EV batteries to utilise the V2G concept to create a VPP for system benefits was investigated in both [4.25] and [4.28]. The coordinated charging and discharging of multiple EVs to minimise power losses and to improve the voltage profile was explored in [4.29]. In [4.25] an aggregator was used to increase the network benefits from EVs, with frequency regulation being the first strategic approach for the aggregator. Although V2G, when used for local network support, is an existing area of study [4.30-4.33], the bi-directional flow of electricity from an EV battery to the local distribution network has been deemed out of scope for this work.

However, the main aim of this research is not to quantify the specific system benefits to the DNO that the aggregation of EV batteries can provide, but the aim is to identify the operational envelope for multiple EVs, so that (based upon certain predefined objectives) the optimal number of EVs can be incorporated on a typical HV network for multiple stakeholder benefits. The following sub-



sections detail the approach taken, the assumptions that were required to underpin the demand model and the parameters of the EV demand model.

#### 4.3.1 EV Load Modelling

To develop a model of the EV battery and to quantify the additional demand on the distribution network, it was required to first simulate the general characteristics of an EV charger and the interaction of this charger with a typical EV battery. The actual parameters (charge rate and battery size) will be varied in this work, which will then be used to identify the Pareto Optimal values for the charge rate and battery size which best meet certain pre-defined multi-objectives. EV batteries are modelled as constant power loads with unity power factors and it is assumed that each EV charger is connected at each domestic property through a domestic service cable at the Customer Point of Connection (CPoC) and a standard single phase supply.

The total additional load, as a result of the EV charging, at each HV/LV node will depend upon a number of independent variables such as:

- The total number of EVs connected at each HV/LV node;
- The size of the EV battery;
- The power of the EV charger; and
- The initial SOC of the EV battery.

A worst case scenario is assumed for the purpose of this study; that is, each EV battery will require a full charge and be empty at the commencement of the charging routine (either by being driven until empty or being fully discharged in a suitable manner before starting the charging process). In this work, it will be demonstrated that smart EV charging can provide multiple stakeholder benefits and meet multiple objectives, therefore the impact of the additional EV charging load upon the distribution network is what is primarily of interest.

The decision maker must - whilst being informed by the output from the presented framework - choose between; either a reduced EV charger power output and therefore a longer charging time or an EV charger which supplies more power and result in an increased load but for a shorter time period. This planning horizon is further complicated by the variability in size of the available EV battery and the intermittent availability of the export from renewable wind/PV, which could be used to mitigate the impact of the EV charging load.

This work will identify the optimal EV charger power output and battery size, but also the optimal number of EVs per managed area and the operational envelope (charging routine start time and length) to realise multiple system benefits.

#### 4.3.2 Coordinated Charging of EVs

The coordinated charging of EVs to mitigate the issues associated with the additional load observed from EV charging could be achieved in a number of ways. It is assumed that EV owners would be incentivised to charge their vehicles at off-peak times when base load will generally be lower. Once the off-peak charging period has begun, no additional EVs will connect or disconnect from the network before reaching a full SOC. Smart technology with load control capability is also assumed to be present at each domestic property to ensure that the start time of the charging routine is not dependent upon the actions of the EV owner. It is further assumed that this capability can be utilised by the DNO (or a third-party) to manage the EV charging routines.

For the purposes of this work, the ability to manage load extends to EV charging only and both the start time and the charging rate of a number of EVs at each HV/LV node (which is deemed to have a number of EVs connected) may be varied. In addition to this, the optimal EV battery size will be identified along with the other DVs. The ability to vary the charging rate of multiple EVs (by varying the power rating of each EV charger) has been studied for use in optimal EV charging strategies previously [4.8], [4.34] and will also underpin this work.

The coordinated charging of EVs, as described above, with variable start times, will assist in increasing the utilisation of the export of renewable generation, as the aim will be to schedule the EV charging to coincide with periods when the export from wind/PV is expected to be high. There is a clear need for forecasting wind and PV, as this is a major factor in determining whether the charging of a fixed period of demand can be initiated.

#### 4.3.3 Additional EV Load and Charger Power Output

The impact of one EV charger with no control strategy applied, on a single LV feeder will be minimal, however, it is the aggregation of multiple EVs on the HV network and the impact of clustering that will cause network issues that must be managed and mitigated. As has been stated, EVs are assumed to be responsive demands with the main characteristics being:

- Power demand, which is based upon battery size;
- Power output of the EV charger; and
- Number of EVs per network area.

In this thesis, dynamic models (with a variable battery size and power output of the EV charger) of the EV battery are assumed, where the battery can be approximated by a voltage source in series with an equivalent constant resistance of the battery cell where the active power characteristic of the EV battery represents the charging process.

The time required to charge one EV battery can be calculated by using the following;

$$t_c = q_t / i_{batt} \quad (1)$$

Where  $t_c$  is the charging time,  $q_t$  is the charged battery capacity expressed in Ah and  $i_{batt}$  is the bulk charging current as per the charging rate. To obtain the charging power required for one EV battery, the battery terminal voltage is calculated. A model of the Li-Ion battery was used to calculate the required charging power. Depending on the charging rate, the battery open circuit voltage of Li-Ion batteries can be obtained using;

$$v_t = V_0 - K \times C / (C - q_t) \times i_t + A_e (-B \times q_t) \quad (2)$$

which was derived from [4.35]. Where  $v_t$  is the open circuit voltage at time  $t$  during the EV charging process,  $V_0$  is the constant voltage,  $K$  is the polarisation constant (1/Ah),  $C$  is the maximum battery capacity (Ah),  $A$  is the exponential voltage and  $B$  is the exponential capacity (V/Ah). The battery terminal voltage can be determined by;

$$v_{batt} = v_t - R \times i_{batt} \quad (3)$$

Where  $v_{batt}$  is the battery terminal voltage at time  $t$  during charging,  $R$  is the battery internal resistance and  $i_{batt}$  is the bulk charging current which is negative during charging.

The charge accepted by the EV battery (W) can now be determined by;

$$p_{charge} = v_{batt} \times i_{batt} \quad (4)$$

which is a function of the battery terminal voltage ( $v_{batt}$ ) and the bulk charging current ( $i_{batt}$ ). In this work, the additional load to be accommodated will be a function of; the charger power output ( $p_{charge}$ ), the total charging time ( $t_c$ ), and the number of EVs at each HV/LV node.

The additional EV load, which is an input into the network planning tool, is calculated using the method above based upon the variation of certain input data; number of EVs, EV battery size and the charger power output. A representative 24 hour demand profile which simulates the load observed at an HV/LV node is integral to the model and consequently the outputs of the planning tool. As the base load varies over a typical day, the start time of the charging routine is as important as the magnitude of the additional load to be accommodated. Finally, a simulated realistic HV network topology underpins the planning framework to ensure that results are kept within sensible real world limitations and only the feasible solutions are used to inform planning decisions.

The planning framework will be used to assess the impact of the additional EV load when mitigated by responsive charging; it has been further adapted to include the assessment of the export of wind/PV generation to evaluate the times when managed EV charging has the least negative impact on the network (or the most benefit to the network).

#### **4.4 Summary**

In this chapter, the drivers behind the increase in the penetration of EVs in the UK were explored and EV growth forecasts were presented where it was clear that there were potential significant network impacts and costs to be borne by the DNO, due to the unmanaged charging of multiple EVs; which is expected to become an issue for DNOs to manage within the next 10 years. However, there are system benefits to be realised by utilising the inherent storage capacity of EVs and scheduling EV charging to coincide with times of high renewable generation export and low base load. This will result in a more efficient use of the distribution assets and will enable investment and reinforcement costs to be deferred whilst also assisting in meeting UK carbon reduction targets.

The EV operation and integration problem and the planning horizon regarding the optimal EV battery size and EV charger power output were defined. A formulation of the EV demand model which was used to calculate the impact of multiple EVs as responsive demands on a typical distribution network and the parameters which constrain this model were presented. Finally, the assumptions that were used to underpin this demand model were stated.

The next chapter will introduce the MODERNE framework and planning tool. SPEA2 which is utilised within the framework will be described and the structure of the tool and the planning objectives that are available within the tool will be formally presented.

#### **4.5 References for Chapter 4**

- [4.1] National Grid, "*Future Energy Scenarios*", 2018  
<http://fes.nationalgrid.com/fes-document/>  
Accessed 12 January 2019
- [4.2] Department of the Environment, Fisheries and Rural Affairs (DEFRA), "*UK plan for tackling roadside nitrogen dioxide concentrations*", 2017  
[https://assets.publishing.service.gov.uk/government/uploads/system/uploads/attachment\\_data/file/633270/air-quality-plan-detail.pdf](https://assets.publishing.service.gov.uk/government/uploads/system/uploads/attachment_data/file/633270/air-quality-plan-detail.pdf)  
Accessed 31 January 2019
- [4.3] EA Technology "*Summary Report My Electric Avenue*", 2016

<http://myelectricavenue.info/sites/default/files/Summary%20report.pdf>

Accessed 15 January 2019

- [4.4] The Society of Motor Manufacturers and Traders (SMMT), "EV Registrations", 2018

<https://www.smmt.co.uk/2018/09/august-ev-registrations/>

Accessed 11 January 2019

- [4.5] Department for Energy and Climate Change, "Climate Change Act 2008 Impact Assessment," 2009

<https://www.legislation.gov.uk/ukia/2009/70>

Accessed 27 January 2019

- [4.6] Department for Business Energy and Industrial Strategy, "Clean Growth Strategy," 2018

<https://www.gov.uk/government/publications/clean-growth-strategy/clean-growth-strategy-executive-summary>

Accessed 10 January 2019

- [4.7] A. Estanqueiro, J. Ferreira de Jesus, J. Ricardo, Amarante dos Santos, J. A. Pecos Lopes, "Barriers and Solutions to Very High Wind Penetration in Power Systems", Power Engineering Society General Meeting 2007, pp. 1-7, 24-28 June 2007.

- [4.8] K. Clement-Nyns, E. Haesen, and J. Driesen, "The impact of charging plug-in hybrid electric vehicles on a residential distribution grid," IEEE Trans. Power Syst., vol. 25, no. 1, pp. 371-380, 2010.

- [4.9] P. Richardson, D. Flynn, A. Keane, "Optimal Charging of Electric Vehicles in Low-Voltage Distribution Systems" Power and Energy Society General Meeting, 2012 IEEE.

- [4.10] W. Kempton and J. Tomic, "Vehicle-to-grid power fundamentals: Calculating capacity and net revenue," J. Power Sources, vol. 144, no. 1, pp. 268-279, 2005.

- [4.11] Department for Business Enterprise and Regulatory Reform and the Department for Transport "Investigation into the Scope for the Transport Sector to Switch to Electric Vehicles and Plugin Hybrid Vehicles", 2008

<https://www.cenex.co.uk/wp-content/uploads/2014/02/CenexEoT.pdf>

Accessed 09 January 2019

- [4.12] J. A. Pecos Lopes et al, "Smart Charging Strategies for Electric Vehicles: Enhancing Grid Performance and Maximizing the Use of Variable Renewable Energy Resources" Proceedings 24th International Electric Vehicle Symposium and Exposition (EVS24) May 2009

- [4.13] V. H. Mendez, J. Rivier, J. I. De la Fuente, T. Gomez, J. Arceluz, J. Marin, A. Madurga, "Impact of Distributed Generation on Distribution Investment Deferral", International Journal of Electrical Power and Energy Systems, Volume 28, Issue 4, pp. 244-252, May 2006

- [4.14] P. Djapic, C. Ramsay, D. Pudjianto, G. Strbac, J. Mutale, N. Jenkins, and R. Allan, "Taking an active approach," IEEE Power and Energy Magazine, vol. 5, no. 4, pp. 68-77, July-Aug. 2007.
- [4.15] J. Taylor, A. Maitra, M. Alexander, D. Brooks, and M. Duvall, "Evaluation of the impact of plug-in electric vehicle loading on distribution system operations," in Proc. IEEE Power and Energy Soc. General Meeting, Calgary, AB, Canada, Jul. 2009.
- [4.16] K. Schneider, C. Gerkenmeyer, M. Kintner-Meyer, and R. Fletcher, "Impact assessment of plug-in hybrid vehicles on Pacific Northwest distribution systems," in Proc. IEEE Power and Energy Soc. General Meeting, Pittsburgh, PA, Jul. 2008.
- [4.17] C. Gerkenmeyer, M. Kintner-Meyer, and J. G. DeSteeze, "Technical Challenges of Plug-in Hybrid Electric Vehicles and Impacts to the US Power System: Distribution System Analysis, Pacific Northwest National Laboratory Report", 2010  
[https://www.smartgrid.gov/files/phev\\_distribution.pdf](https://www.smartgrid.gov/files/phev_distribution.pdf)  
 Accessed 26 December 2018
- [4.18] S. Shao, M. Pipattanasomporn, and S. Rahman, "Challenges of PHEV penetration to the residential distribution network," in Proceedings. IEEE Power and Energy Society General Meeting, Calgary, AB, Canada, Jul. 2009.
- [4.19] G. A. Putrus, P. Suwanapongkarl, D. Johnston, E. C. Bentley, and M. Narayana, "Impact of electric vehicles on power distribution networks," in Proc. IEEE Vehicle Power and Propulsion Conf., Dearborn, MI, Sep. 2009.
- [4.20] C. E. T. Foote, A. J. Roscoe, R. A. F. Currie, G. W. Ault, and J. R. McDonald, "Ubiquitous energy storage," International Conference on Future Power Systems, 18 November 2005.
- [4.21] C. W. Gelling's, W. M. Smith, "Integrating Demand-Side Management into Utility Planning", Proceedings of the IEEE Volume 77 Issue 6, June 1989.
- [4.22] J. P. Barton and D. G. Infield "Energy Storage and its Use with Intermittent Renewable Energy", IEEE Transactions on energy Conversion, Vol. 19, No. 2, June 2004.
- [4.23] Department for Transport, "Vehicle mileage and occupancy", 2018  
<https://www.gov.uk/government/statistical-data-sets/nts09-vehicle-mileage-and-occupancy>  
 Accessed 05 January 2019
- [4.24] T. Horiba, "Lithium-Ion Battery Systems" Proceedings of the IEEE Volume 102, Issue 6, June 2014
- [4.25] C. Binding et al, "Electric vehicle fleet integration in the Danish EDISON project-a virtual power plant on the island of Bornholm". In Power and Energy Society General Meeting, 2010 IEEE (pp. 1-8).

- [4.26] K.C. Divya, J. Oestergaard, "Battery Energy Storage Technology for Power Systems - An Overview". Electric Power Systems Research, Vol. 79, pp. 511-520.
- [4.27] H. Ibrahim et al, "Energy storage systems - Characteristics and comparisons". Renewable and Sustainable Energy Reviews, Vol. 12, June 2008
- [4.28] M. Musio, A. Damiano, "Analysis of Vehicle to Grid and energy storage integration in a virtual power plant", Industrial Electronics Society IECON 2014 - 40th Annual Conference of the IEEE, pp. 3094-3100, 2014
- [4.29] S. Deilami et al, "Real-Time Coordination of Plug-In Electric Vehicle Charging in Smart Grids to Minimize Power Losses and Improve Voltage Profile" IEEE Transactions on Smart Grid Volume: 2, Issue: 3, Sept. 2011
- [4.30] J. A. P. Lopes, S. A. Polenz, C. L. Moreira, and R. Cherkaoui, "Identification of control and management strategies for LV unbalanced microgrids with plugged-in electric vehicles" Journal of Electrical Power Systems., vol. 80, no. 8, pp. 898-906, Aug. 2010.
- [4.31] S. Acha, T. C. Green, and N. Shah, "Effects of optimised plug-in hybrid vehicle charging strategies on electric distribution network losses" in Proc. IEEE Power and Energy Soc. Transmission and Distribution Conf. Expo., New Orleans, LA, Apr. 2010.
- [4.32] K. Clement-Nyns, E. Haesen, and J. Driesen, "Analysis of the impact of plug-in hybrid electric vehicles on residential distribution grids by using quadratic and dynamic programming," in Proc. EVS24 International Battery Symposium, Norway, May 2009.
- [4.33] E. Sortomme and M. A. El-Sharkawi, "Optimal charging strategies for unidirectional vehicle-to-Grid" IEEE Trans. Smart Grid, vol. 2, no. 1, pp. 131-138, Mar. 2011.
- [4.34] A. Brooks, E. Lu, D. Reicher, C. Spirakis, and B. Wehl, "Demand dispatch: Using real-time control of demand to help balance generation and load" IEEE Power Energy Magazine, vol. 8, no. 3, pp. 20-29, May/Jun. 2010.
- [4.35] SimPowerSystems "Battery model", 2008  
[uk.mathworks.com/help/physmod/sps/powersys/ref/battery.html](http://uk.mathworks.com/help/physmod/sps/powersys/ref/battery.html)  
 Accessed 05 January 2019

## Chapter 5 - EV Integration and Application to the Planning Framework

The planning framework, which will optimise the inclusion of multiple EVs on distribution networks, is the “Multi-Objective Distributed Energy Resource and Network Evaluation” (MODERNE) planning tool which was developed initially by A. D. Alarcon-Rodriguez for his doctoral thesis in 2009 [5.1] and has since been further developed by the author for this work (see Section 5.3). MODERNE takes as inputs various models of distribution networks along with associated demand and generation profiles. When the planning objectives have been defined, numerous evaluations of different configurations of the sizes, types and locations of EVs are then carried out to assess optimality.

There are benefits to be realised by both the DNO and consumer from the various smart charging strategies. Smart EV charging regimes will enable DNOs to manage voltage or thermal constraints more effectively and provide the consumer with more cost effective energy by minimising network investment costs whilst also increasing the utilisation of energy generated from renewable sources. There are rigid constraints that frame this problem, such as the thermal and voltage limits of distribution assets, the maximum EV battery size and the maximum number of EVs which can realistically be charged at each HV/LV node.

SPEA2 is suitable to be used to approach this multi-objective problem and has been shown to produce a greater distribution of solutions, solutions than other MOEA. The EV integration problem under consideration has numerous conflicting objectives which poses no issues for SPEA2 [5.2]. The planning framework enables multiple stakeholder viewpoints to be incorporated within the problem specification whilst ensuring that the solutions stay within realistic bounds to provide real world applications.

The planning framework has been developed to enable the optimal number, EV battery size, charger power output and operational envelope for multiple EVs to be determined based upon a given modelled network and the associated input data, including 4 EV types, each of which has been identified after initial analysis was undertaken. The framework has the functionality to optimise 4 different types of EVs simultaneously and each EV type will be decoded based upon the EV battery size, charger size, charging routine and the additional load to be added to the daily load profile at each node. The results from the planning framework will be used to identify the number and configuration of the 4 EV types (and the associated additional load) which will be assigned to each



node; and which charging routine (start time) should be used to maximise the utilisation of the generation export.

## 5.1 Structure of the Network Planning Tool

### 5.1.1 Multi-Objective Planning Framework

The planning framework will be used to optimise the location, battery size, charger power output and operational envelope for multiple EVs, to meet conflicting objectives, whilst being bound by a number of rigid constraints (e.g. maximum battery size, voltage/thermal limits of the distribution assets) to ensure that a real world planning horizon was taken.

Figure 15 [5.1] below illustrates the structure of the MODERNE framework and details the required building blocks and information flows – this demonstrates the interactions between the various modules and also the inputs required. The multi-objective optimisation element and the objective evaluation are both key components of the planning framework and tool.

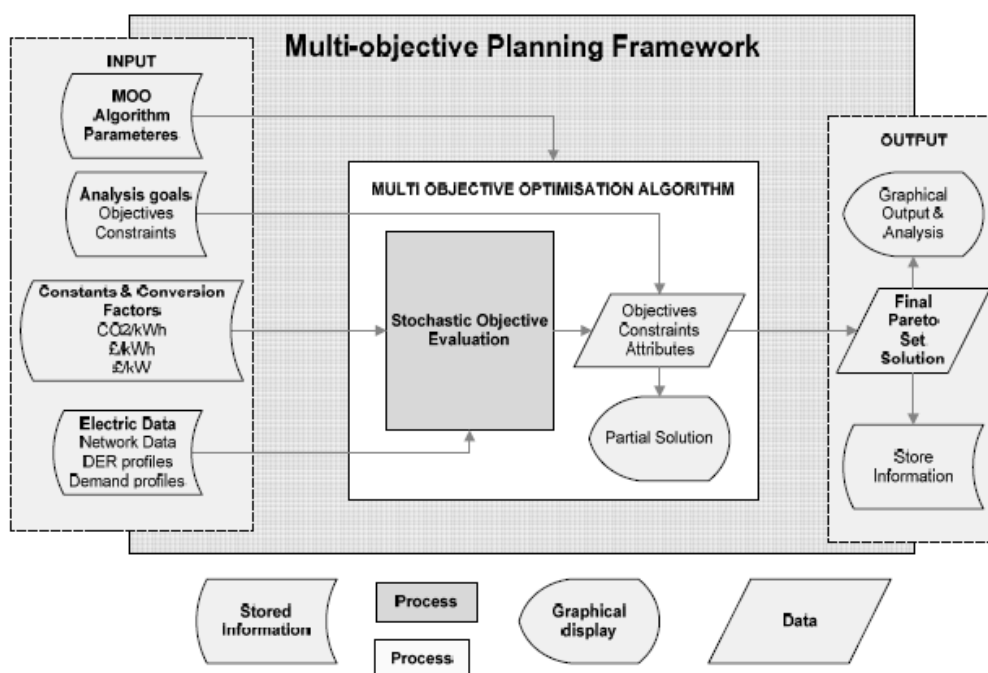

Figure 15: Multi-Objective Planning Framework - High Level Structure

### 5.1.2 Stochastic Simulation

The stochastic objective evaluation module of the MODERNE tool is described below and the structure is shown in Figure 16. Deterministic power flow calculations of the modelled network are performed repeatedly, with the associated profiles; demand, generation and the additional EV demand, which together replicate the power system. When the technical characteristics of the network, such as voltage and power flow are observed, the calculation of (for example) the line

losses and imported energy can then be carried out and these calculations will then provide a basis for the optimisation module to calculate the economic and environmental attributes.

As described in Section 3.5, SPEA2 ensures that there is a faster convergence towards the Pareto Front (incorporating global optima) than would be expected with other popular MOEA. As the number of generations increases towards  $n$ , the Pareto Front is iteratively improved upon and will then become more accurate with each new generation until a predefined stopping criterion is met or the maximum number of generations has been reached.

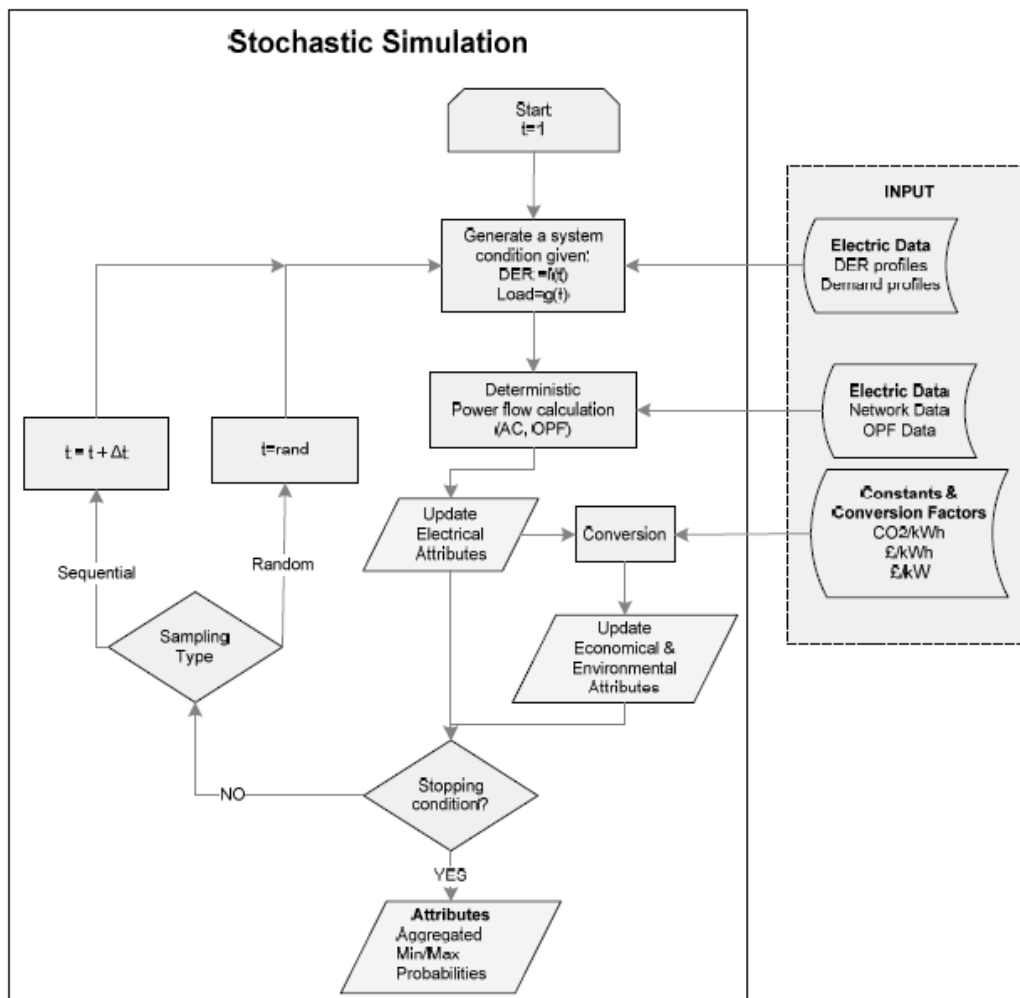

Figure 16: Stochastic Simulation

### 5.1.3 MODERNE Framework for EV Integration

The chosen distribution network topology is required (in a format readable by the planning tool) and the corresponding generation and demand profiles (including the additional EV demand data at each half-hour) are all key inputs to the planning tool. In addition to the network data, there are a number of specific SPEA2 parameters which the user is required to define, these include:

- The first population size;
- The maximum number of generations;
- The crossover probability;
- The mutation operator; and
- The size of the external archive.

The choice of these will have a significant impact upon the optimality of the final solution. However, as described in Section 2.7, the SPEA2 GA process involves thousands of chromosome evaluations (e.g. 40,000 evaluations for a 200 chromosome population over 200 generations); the overall computational time is therefore non-trivial. A very large initial population, will, over several hundred generations require significant resource and this will dissuade the use of this tool in real world planning applications and therefore the size of the initial population is integral.

To assess the feasibility of each of the solutions, a load flow is carried out to ensure thermal and voltage constraints are not breached and then the fitness of each solution is calculated according to the fitness assignment procedure of SPEA2 as described in Section 3.5. The load flow produces a dispatch/curtailment solution for both dispatched ( $P_{disp_t}$ ) and curtailed ( $P_{curt_t}$ ) power. Since the problem is nonlinear; voltages and currents depend on the injected power ( $P_{disp_t}$ ) and ( $P_{curt_t}$ ), using the load flow only provides an approximation of the dispatched and curtailed power at each time step. Using the solution vectors, the power injected in each node at each time step is corrected and the power flows are recalculated using the AC power flow procedure [5.1].

When the maximum number of generations has been reached (as defined during the input of the SPEA2 parameters), the Pareto Optimal solutions are displayed graphically as shown in Figure 17 and it is the individual solutions which lie on the Pareto Front that are of interest.

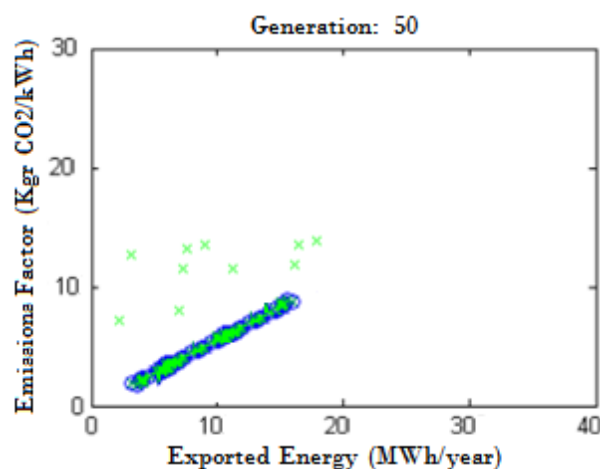

Figure 17: Output Example

#### 5.1.4 Network Planning Objectives

The choice of the planning objectives, as detailed in Table 1 below, enable a focus to be placed upon the attributes of interest to the Network Planner, based upon a minimisation or maximisation of a combination of a number of these planning objectives. It is the precise selection of these planning objectives that is vital to the analysis of the case studies that will be studied in Chapter 6. Table 1 details the full suite of objectives available within the MODERNE framework, it is clear that these are diverse (technical/environmental/economic) and dependent upon the requirements at that time a number of these can be grouped together. In the following sub-sections, each of the Planning Objectives/Attributes in Table 1 will be discussed in further detail to evidence the reasoning for inclusion within the planning framework.

**Table 1: Network Planning Attributes/Objectives**

Planning Objective/Attribute	Categorisation
Minimise Line Losses (MWh/year)	Technical/Environmental/Economic
Minimise Imported Energy (MWh/year)	Technical/Economic
Maximise Exported Energy (MWh/year)	Technical/Economic
Minimise Grid Dependency (MWh/year)	Technical/Environmental/Economic
Minimise Thermal Loading in Lines (%)	Technical/Economic
Minimise Overload Probability (%)	Technical/Economic
Minimise Energy Emissions Factor (Kg CO <sub>2</sub> /kWh)	Environmental
Minimise Dispatched Energy	Technical/Environmental/Economic
Minimise Curtailed Energy	Technical/Environmental
Maximise Penetration Level of Electric Vehicles (%)	Technical/Environmental/Economic

##### 5.1.4.1 Line Losses

As the minimisation of line losses (and the environmental and economic benefits when this is achieved) is of interest to both DNOs and the regulator, this will be a planning objective where there can be significant value to be realised. Ofgem have introduced during RIIO-ED1 the Losses Discretionary Reward (LDR) scheme which aims to encourage and incentivise DNOs to undertake additional actions to better understand and manage the technical losses on their networks. DNOs now share best practice with stakeholders relating to losses and undertake to apply innovative approaches to reduce losses [5.3]. As an example of the innovation that has been implemented, one DNO now has the policy of installing a minimum cable size of 300mm<sup>2</sup> at 11kV where practical (rather than 185mm<sup>2</sup>) to reduce losses, this is achieved without a significant increase in cost [5.4] and the cost/benefit analysis shows a break-even period of 5 years. Tranche One of the LDR awarded £3.8m to all 6 DNOs and Tranche Two is potentially worth up to £10m [5.3].

The hypothesis to be tested in this work is that the MODERNE planning tool, when used to optimally integrate EVs at HV/LV, can assist in reducing the total imported energy (from a GSP) and also increase the utilisation of the export of renewable generation at 11kV or below. Together, this will

result in the reduction of the observed (net) peak demand at HV/LV nodes, which will reduce line losses and provide multiple stakeholder benefits. The total line losses in the modelled network at each simulation time step  $t$  are calculated using

$$\text{Losses}_t = 3|I_{\text{line}}|^2 \times R \quad (5)$$

Where the magnitude (absolute) value of the line current is represented by  $|I_{\text{line}}|$ ;  $R$  represents the line resistance and  $t$  represents each simulation iteration time step and the annual losses can then be calculated.

$$\text{AnnualLosses} = \frac{8760}{n} \sum_t^n \text{Losses}_t \quad (6)$$

The total number of simulations is represented by  $n$  and 8760 is the number of half-hour periods in a modelled year. It is then trivial to calculate the annual power losses (kWh/year) when the total line losses (kW) are known. Losses (copper losses) are caused by the current and impedance of the lines (electrical losses), however only active energy (real power) losses are calculated and as DNOs are being incentivised to move towards a DSO model (with active network management and the real time balancing of the network), the minimisation of losses will be of interest and value to Network Planners.

#### 5.1.4.2 Imported and Exported Energy

To calculate the total energy imported and exported annually at DNO connection points (such as GSPs) a summation of the total energy flow at each GSP/connection point is carried out.

$$\text{ImportedEnergy} = \frac{8760}{n} \sum_t^n \text{GridPower}_t \quad \forall \text{GridPower}_t > 0 \quad (7)$$

$$\text{ExportedEnergy} = \frac{-8760}{n} \sum_t^n \text{GridPower}_t \quad \forall \text{GridPower}_t < 0 \quad (8)$$

Minimising the total imported energy is a planning objective which will reduce costs to the DNO (and the consumer) and the corresponding increased utilisation of renewable generation will also have environmental and societal benefits. Imported energy is formulated as a minimisation objective and to do this will then maximise the utilisation of renewable generation within the local network. To maximise the energy exported from the distribution network will ensure that the financial value of renewable generation is also maximised (as there will be no curtailment or export from the network), specifically at times of high generation credits being paid.

To determine GridPower, equation 9 below is used. It should be noted here that the “Gridpower” is the real part of the complex value defined by  $(V_{\text{grid}}(I_{\text{grid}}))^*$ .

$$\text{GridPower}_t = 3\Re(V_{\text{grid}}(I_{\text{grid}})^*) \quad (9)$$

Where  $I_{\text{grid}}$  is the current and  $V_{\text{grid}}$  is the voltage measured within the network with  $R$  being the line resistance as previously defined. To calculate  $I_{\text{grid}}$ , equation 10 below is used.

$$I_{\text{grid}} = \sum_{\text{node}} I_{\text{node}} \quad (10)$$

$I_{\text{node}}$  is calculated by utilising a backward forward sweep (BFS) power flow method for balanced radial distribution systems. If the sum of  $I_{\text{node}}$  is positive after all simulations have been carried out, then overall, energy is being imported to the distribution network. Conversely, a negative value of  $I_{\text{node}}$  shows energy being exported from the distribution network, which, from the generation owner's viewpoint, will be an efficient and financially attractive use of the installed generation plant.  $I_{\text{node}}$  is a phasor quantity so need to determine the phase relative to the voltage when considering import/export. When the aim is to maximise the exported energy, it is desirable for the value of  $I_{\text{node}}$  to be the lowest negative value on the Pareto Front.

#### 5.1.4.3 Grid Dependency

Grid dependency calculates the self-sufficiency of a distribution network; when a network is not dependent on the imported energy from the National Grid transmission network, there will be increased resiliency to both faults and outages. Engineering Recommendation P2/7 [5.5] (which was implemented in August 2019), specifies the minimum supply restoration times following an asset failure.

A varied generation mix incorporating intermittent renewables such as wind/PV and also other non-intermittent technologies such as CHP and biomass will improve the overall network "Security of Supply" and increase the resiliency of the network (and reduce the number of customers who suffer from loss of supply due to asset failures) under an "n-1" scenario. This will ensure that the DNO is enabled to financially benefit from the Ofgem "Interruptions Incentives Scheme" (IIS). For a DNO who can reduce the number of Customer Interruptions/Customer Minutes Lost (CI/CML) below certain thresholds there is an available income in the region of £10m each year (per DNO licence area). In the regulatory period 2015/16, GB DNOs earned approximately £160 million under the IIS [5.6]; this was in addition to the significant DNO income (allowed revenue) calculated by Ofgem for each year of the 8 year RII0-ED1 (2015-2023) price control period. The minimisation of grid dependency can be achieved by minimising the sum of the total imported and exported energy, as shown below in equation 11;

$$\begin{aligned} \text{GridDependency} &= \text{ImportedEnergy} + \text{ExportedEnergy} & (11) \\ &= \frac{8760}{n} \sum_t^n |\text{GridPower}_t| \end{aligned}$$

#### 5.1.4.4 Thermal Loading in Lines

The thermal loading of the lines in the network is calculated for each simulation carried out and is expressed as a percentage. ThermLoading can be calculated by using equation 12 below;

$$\text{ThermLoading}_{\max} = \max_t \left[ \max_{\text{line}} \left( \frac{|I_{\text{line}_t}|}{I_{\max}} \right) \right] \times 100 \quad (12)$$

These results provide a measure of the worst “likely” event, given the number of simulations, the duration of the analysis and the longer term planning horizon.

#### 5.1.4.5 Overload Probability

To calculate the probability of thermal limit violations on any line within the network, the total number of overload events (the sum of all excursions based upon breaching thermal constraints once) is divided by the total number of simulations which have been carried out. This is expressed in equations 13 and 14;

$$\text{ThermLoading}_{\text{prob}} = \frac{\sum_t \text{Ibreak}_t}{n} \times 100 \quad (13)$$

$$\text{Ibreak}_t = \begin{cases} 1 & \text{if (any } I_{\text{line}_t} > I_{\max}) \\ 0 & \text{otherwise} \end{cases} \quad (14)$$

To reduce the risk of asset failure (with associated CI/CML impacts) and also to ensure that there is no rapid degradation of distribution assets, this value should be minimised.

#### 5.1.4.6 Energy Emissions Factor

The value obtained for TotalCO<sub>2</sub> represents the carbon emissions which are the result of both the demand and generation within the distribution network (which is based upon the sum of the total energy flowing through the GSP bi-directionally plus the contribution from the installed DERs). This is calculated as being the sum of all emissions within the modelled network area. The TotalCO<sub>2</sub> emissions are expressed as in equation 15 below;

$$\text{TotalCO}_2 = \frac{\text{ImportedEnergy} \times \text{grid}_{\text{CO}_2} + \text{TotalDEREnergy}}{\text{ExportedEnergy} + \text{TotalLoad} + \text{AnnualLosses}} \quad (15)$$

The carbon emissions within the distribution network (as a result of both the imported/exported and generated energy) are accounted for in the numerator of equation 15, while the denominator details the total energy flow within the network. The value obtained for TotalCO<sub>2</sub> is the equivalent overall emissions factor for the total energy flow within the modelled network. In equation 16 below, the

value obtained for LoadCO<sub>2</sub> provides an indication of the carbon emissions which are a result of only the imported energy;

$$\begin{aligned} \text{Load}_{\text{CO}_2} & \quad (16) \\ & = \frac{\text{ImportedEnergy} \times \text{grid}_{\text{CO}_2} + (\text{TotalDEREnergy} - \text{ExportedEnergy})}{\text{TotalLoad} + \text{AnnualLosses}} \end{aligned}$$

Grid self-sufficiency and a high utilisation of generation at times of peak demand will assist in minimising this value; which will be a desirable planning aim when integrating high penetrations of EVs. To achieve this, MODERNE optimises the EV battery size, the EV charger power output and the operational envelope of multiple EVs to coincide the expected availability of renewable generation export.

#### 5.1.4.7 Dispatched and Curtailed Energy

After the load flow has been completed, a vector is created which represents both the dispatched ( $P_{\text{disp}_t}$ ) and curtailed ( $P_{\text{curt}_t}$ ) energy. The sum of these vectors' elements for one simulation which is carried out over 8760 time periods is then used to calculate the annual (total) dispatched and (total) curtailed energy. This is calculated as shown in both equations 17 and 18 below;

$$\text{DispatchedEnergy} = \frac{8760}{n} \sum_t \sum_{\text{node}} P_{\text{disp}_t} \quad (17)$$

$$\text{CurtailedEnergy} = \frac{8760}{n} \sum_t \sum_{\text{node}} P_{\text{curt}_t} \quad (18)$$

If the utilisation of DERs are maximised, this will have the effect of minimising the annual curtailed energy. There is value to be gained when the scheduled charging of EVs coincides with the export of intermittent renewable generation and times of low base load; as the result of this will be to reduce the imported energy required, which is an efficient use of the generation plant. The minimisation of dispatched energy aims to reduce the requirement for National Grid to call upon expensive generation units (including STOR/CMU) at times of need to meet demand peaks, the costs of which would be passed onto the consumer. This objective is treated as a minimisation function which will reduce the requirement for energy generated from diesel and gas generators (and by extension, the costs of calling upon this generation).

#### 5.1.4.8 Penetration Level of Electric Vehicles

The penetration level of EVs is defined as the percentage of the overall locations where EV charging can be sited by the Network Planner in the modelled network. For example, if an LV network has 100 domestic properties (nodes) then a 30% penetration of EVs will equal 30 EVs. However, in this work, a number of EVs are aggregated at each HV/LV node; it is the impact of the additional EV load upon the HV system that is to be assessed. To achieve this in the simulation, a number of HV/LV



nodes will have an additional load added at each half-hourly period in addition to the base load, for a set time period. This additional load is based upon the charger power output and the EV battery size and the number of EVs assumed to be at each node in the model.

The motivation to study the impact upon the HV network is that the overload/failure of HV assets will negatively impact the reliability of the network more so than the failure of LV assets and the subsequent capital cost of replacement of HV distribution assets is significantly higher than the relatively trivial replacement costs of LV assets [5.7].

The penetration level is used in a maximisation function; however, the bounds of the problem space are both the minimum available capacity for additional demand (defined by the firm capacity at the node minus the peak demand) and the maximum available capacity for additional demand at times of minimum load. These lower and upper bounds should be used when maximising the penetration of EVs in the modelled network. Essentially, this simulates both a best and worst case planning scenario for the DNO; the minimum available headroom (capacity) at an HV/LV node; based upon the firm capacity minus the peak demand and the maximum available headroom; based on the observed minimum demand (with a further reduction to be made that will take account of the installed generation capacity at the node).

#### 5.1.5 Initial Population

The first step in the SPEA2 process is the requirement for a diverse initial population; MODERNE has functionality where the Network Planner is required to manually generate a number of (random) solutions that will comprise a subset of the entire initial population. Each of these solutions must be feasible and will be limited by:

- The maximum size of the EV battery;
- The minimum and maximum charger power; and
- The maximum and also the target penetration of EVs.

The remainder of the initial population is created by adding a number of EVs with configurations of the DVs to all nodes in the network. This process will ensure that solutions are only created (and survive to the next iteration) if they are feasible and this will also result in the search space being fully explored, thereby reducing the risk of results produced being limited by local optima [5.8].

#### 5.1.6 Encoding and Decoding

To optimise the number, location, EV battery size, charging routine and charger power output of EVs; the MODERNE framework requires that this multi-objective problem is presented in the form of

a system of equations; a matrix. Each HV/LV node is represented by an integer value and it is assumed that each node in the network is able to accommodate an additional EV load; however, this load is the aggregated increase in demand at the node due to the additional demand from a number of EVs. It is the system impact/benefits relating to the managed charging of multiple EVs that will be assessed in conjunction with obtaining the optimal number, EV battery size, charging routine and charger power output.

Each possible solution; or number of EVs of each type, is encoded as one gene within each chromosome and this chromosome can be represented by a vector with a number of elements equal to the number of nodes in the network model.

Each integer number  $G_{ij}$  corresponds to the  $j^{th}$  EV type; with the “type” referring to the EV battery size, charger power output and charging routine, which is sited at the  $i^{th}$  node, where  $G$  represents the number of EVs. A chromosome could be written as below, which is the notation required in the output of MODERNE:

- $17_{23}12_{34}41_{42}11_{23}$ .

This would be interpreted as follows;

- 17 EVs of type 3 at node 2;
- 12 EVs of type 4 at node 3;
- 41 EVs of type 2 at node 4; and
- 11 EVs of type 3 at node 2;

It is expected that over time there will be less flexibility as to both the EV battery size and charger power output; as these are not yet standardised. This module of MODERNE will continue to have real world application as there is still the freedom for Network Planners to ensure that the best value from EVs can be achieved whilst not being constrained by a limited number of products (EV battery sizes/charger power output). The EV battery size, charger power output and charging routine, which together comprise the EV types, are investigated in advance of the requirement for network reinforcements.

As the number of EVs, EV battery size, charger power output and charging routine are DVs which will be optimised (within constrained limits), it was found that the most effective technique was to create a demand model of each of the 4 EV types, with both the EV battery size and charger power output (and by extension the time taken to charge each EV) fixed for each EV type which has been defined. The derived equations for the demand model (Section 4.3.3) were used to inform the

specifics of each of the four EV types. MODERNE is then used to identify the optimal number and configuration of EV types in the modelled network, along with the location and charging routine to be used to meet certain predefined objectives. As can be seen in Table 2 below, the encoding/decoding process is central to the analysis.

**Table 2: Examples of Encoding**

<b>Analysis Type</b>	<b>G<sub>ij</sub></b>	<b>Decoding</b>	<b>Example</b>
Optimisation of the location and type for a number of EVs.	0,1,2,...n	The number of EVs of type <i>i</i> located at node <i>j</i> .	Find the optimal EV battery size, location and operational envelope for a number of EVs. This number will be constrained by real world planning limitations.

This decoding process translates the vector into a matrix of EVs which details the location, battery size and operational envelope for a number of EVs within for the modelled network. In the example below, EV<sub>ij</sub>, as shown in the matrix below, in the *i*<sup>th</sup> row and *j*<sup>th</sup> column directly relates to the number of EVs of type *i* to be sited at node *j*.

This can be seen in equation 19 below;

$$\text{Decoding Matrix} = \begin{bmatrix} EV_{11} & EV_{12} & \dots & EV_{1j} & EV_{1Node} \\ EV_{21} & \dots & \dots & \dots & \dots \\ EV_{i1} & \dots & \dots & EV_{ij} & EV_{iNode} \\ EV_{Type1} & \dots & \dots & EV_{Typej} & EV_{TypeNode} \end{bmatrix} \quad (19)$$

Finally, the framework will output results which will detail the optimal type (EV battery size/ charger power output) and operational envelope of a number of EVs when charged at a specific HV/LV node. This will enable the Network Planner to incorporate these results within load forecasting and operational planning and asset investment decision making.

### 5.1.7 Objective Evaluation and Constraints

The Network Planning Objectives/Attributes that are available to be used within MODERNE were detailed in Section 5.1.4 (Table 1) and each was further discussed in Sections 5.1.4.1-5.1.4.7. To evaluate these objectives and ensure that the solutions are bounded by constraints, the MODERNE tool generates a matrix of all attributes. These are stored in an attribute matrix which ensures that all network planning attributes, including those that were not planning objectives at that time, can be later studied and visualised. Within the matrix, each attribute is represented by a column and each solution is represented by a row.

When the constraints for the analysis have been “*declared*”, the overall constraint violation value is then calculated.  $C_j$  is calculated for every  $j^{\text{th}}$  chromosome; where  $a_{ij}$  is the  $i^{\text{th}}$  objective of the  $j^{\text{th}}$  chromosome and  $c_i$  is the constraint value, which is the sum of all the relative constraint violations.

$C_j$  is calculated as shown below in equation 20;

$$C_j = \sum_i \left| \frac{a_{ij} - c_i}{c_i} \right| \quad (20)$$

Finally, when the dominance relationships (as described in Section 3.2) have been observed, the fitness of each solution is then assessed (after each generation). A fitness score is assigned based upon the fitness procedure as described in Section 3.5; where SPEA2 utilises a population (P) of size N and an external archive (A), also of size N that stores all non-dominated solutions (as discussed in Section 5.2.2). These solutions are used to form the Pareto Front which is where the Pareto Optimal solutions will be chosen from.

#### 5.1.8 Solution Selection to Populate Mating Pool

To ensure that only the “best” (or fittest) solutions survive to populate the mating pool, SPEA2 undertakes a process where a number of binary tournaments take place, with survival the aim. The use of a binary tournament to produce “fitter” offspring, from two “fit” parents in a GA, has “superior convergence” to other methods [5.10]. Figure 18 below illustrates the binary tournament process which is used to ensure that that only “good” solutions survive to produce “better” solutions after each generation.

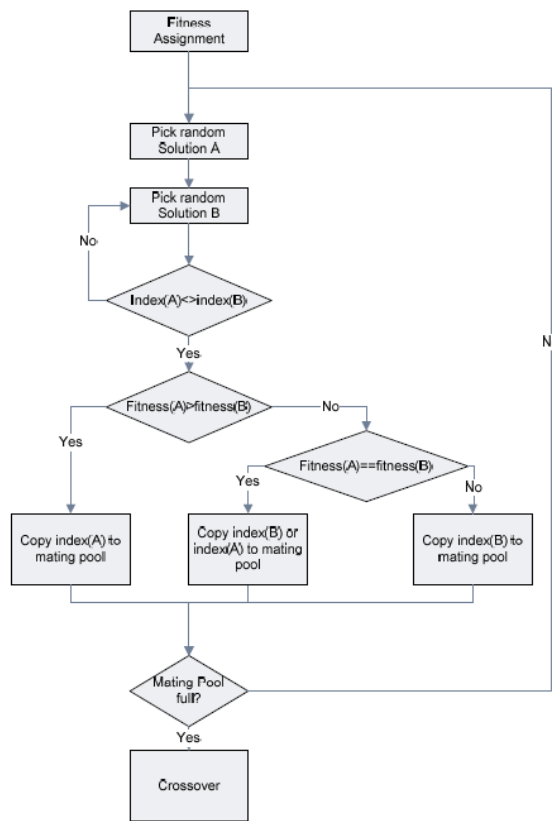

**Figure 18: Binary Selection Process**

The process that the algorithm undertakes is as follows:

- The fitness values of two randomly chosen solutions are compared;
- When the fitness of one solution is greater than the other, it “survives” and is stored within the mating pool to be used as a parent solution for the next generation;
- When two solutions have identical fitness values then one is stored within the mating pool to be used as a parent solution for the next generation and the other is discarded; and
- This process will continue with all solutions assessed until the mating pool is fully populated which is the stopping criteria.

#### 5.1.9 Crossover

Uniform crossover, single point crossover and two point crossover are the three crossover algorithms which are regularly utilised within GAs. The crossover algorithm process is critical as it ensures that genes are passed from both adult solutions to then produce a child solution which is then assessed for fitness.

The uniform crossover method has been shown to outperform both single point crossover and two point crossover [5.9]. The mutation operator (which will be explored further in Section 5.1.10) is used to introduce “random” solutions to the mating pool and this randomness, when incorporated into the process, has been viewed as being disruptive; as introducing a random operator means that a “fit” parent gene is then lost [5.8-5.9].

As the MODERNE planning tool is underpinned by the SPEA2 algorithm, uniform crossover is the method used in SPEA2 to swap various configurations of the number, type and location of EVs (and their associated charging routines) between two parent solutions to produce (hopefully) fitter child solutions. The fittest of each of these solutions will survive to the next generation to produce (eventually) the optimal Pareto Front.

Within MODERNE an additional feature has been added to the uniform crossover process. Two vectors are created; one stores the actual number of nodes within the modelled network and the other stores the nodes where an aggregated EV load could feasibly be located (based upon initial available headroom at HV/LV nodes). The length of each vector is limited by the constraint; that being the maximum number of nodes within the network. If an aggregated EV load (based upon a number of EVs at LV) was located at every HV/LV node, with both a large EV battery size and a high charger power output, there would be an immediate issue of overload on the network assets. However, the MODERNE framework would discard results which were produced that would result in overloads on the network. Figure 19 [5.1] below illustrates the crossover process when the number of additional EV loads that can (feasibly) be incorporated within a network is limited.

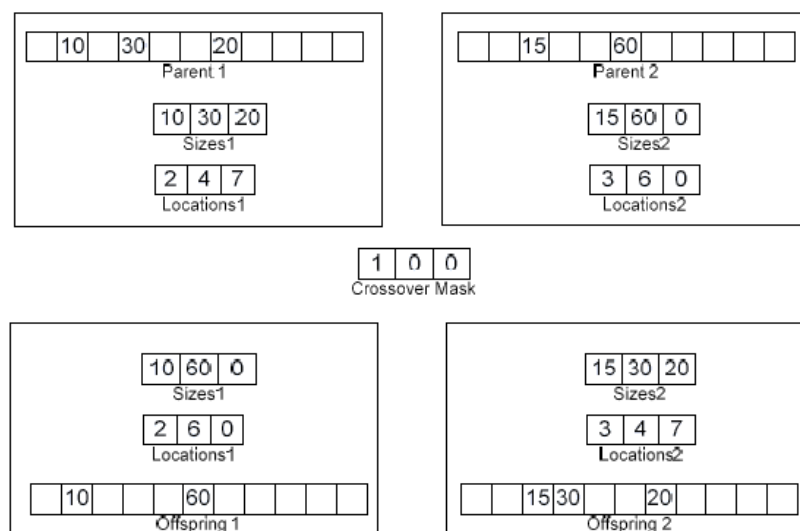

Figure 19: Parent and Child Crossover Implementation

### 5.1.10 Mutation Operator

The introduction of the mutation operator into the SPEA2 algorithm ensures that there is the addition of new genes (solutions) to the mating pool and this will result in more of the search space being explored; the outcome of this is that the entire population maintains a level of diversity. As previously described, the maximum number of aggregated EV loads to be incorporated within the analysis will be strictly limited to be not greater than the total number of HV/LV nodes within the network model under consideration. When the number of aggregated loads is limited in this way, two vectors are created for both the aggregated EV load type and the chromosome.

When a gene is mutated, the process that MODERNE uses is as follows. Note that the 50% probability below can be varied to increase/decrease the likelihood of the EV type changing or the node changing:

- If an aggregated EV load of type  $j$  exists at node  $i$  (when  $G_{ij}>0$ ), then either;
  - The node that the aggregated EV load is sited at is changed but the EV type does not change (with 50% probability); or
  - The node that the aggregated EV load is sited at remains unchanged, but the EV type is varied (with 50% probability).
- If there is not an EV load of type  $j$  at node  $i$  (when  $G_{ij}=0$ ), then one additional aggregated EV load of a random type is added to a random node on the modelled network.

## 5.2 Strength Pareto Evolutionary Algorithm 2

As MODERNE is underpinned by SPEA2, it is of value to understand the SPEA2 process and the building blocks that comprise the algorithm. SPEA2 was developed to address a number of weaknesses which were perceived to exist within the original SPEA [5.2]. It is noted that since the inception of this work in 2008, SPEA2 is no longer as popular or well used in academia as it was; however the benefits of SPEA2 are enduring and well documented in the literature [5.4]. The three main improvements to the algorithm observed in the updated SPEA2 are detailed below and these can be classified as belonging to one of three discrete areas [5.2]:

- Dominance;
  - The fitness assignment procedure has been upgraded in order to include the number of individual solutions that each solution is dominated by.
- Density; and
  - To improve the structure of the search process, a density estimation function has been developed; and
- Boundary solutions.

- To ensure the preservation of boundary solutions, a truncation operator was included.

### 5.2.1 The SPEA2 Process

SPEA2 utilises a population ( $P$ ) and an external archive ( $A$ ) of size  $N$ . It is the external archive that stores all non-dominated solutions. The SPEA2 process is as follows [5.1-5.2]:

- Initialisation;
  - The initial population ( $P_t$ ) and an empty archive ( $A_t$ ) are created.
- Fitness Assignment;
  - The fitness values of  $P_t$  and  $A_t$  are determined based upon the initial population.
- Environmental Selection;
  - All non-dominated solutions from  $P_t$  and  $A_t$  are replicated in  $A_{t+1}$  (the next generation);
  - If  $A_{t+1}$  is greater than  $N$ , then the total size of  $A_{t+1}$  will be reduced (truncated); and
  - If  $A_{t+1}$  is not greater than  $N$ , then the fittest of the dominated solutions are included in  $A_{t+1}$ .
- Termination;
  - When the number of iterations has reached a pre-determined value, the process is complete.
- Mating Selection; and
  - Binary tournaments are carried out to populate the mating pool with the next generation.
- Variation.
  - The new population ( $P_{t+1}$ ) is created by applying both crossover and mutation operators to the mating pool.
  - The counter is incremented by one and the process continues at the Fitness Assignment stage.

As described in Section 3.5, accuracy, diversity and the spread of the solutions are the goals of MOEA generally and SPEA2 specifically. SPEA2 achieves all of these by implementing an enhanced fitness assignment procedure that ensures that only the best solutions survive to populate the next generation.

Due to the inclusion of the truncation operator, a diverse set of solutions is created and when new solutions are created only the “fittest” of these which are contained within the external archive are utilised. This will ensure that each generation will (overall) be fitter than the previous and as the



process moves towards completion, only the fittest solutions will survive to populate the Pareto Front.

### 5.2.2 SPEA2 Fitness Assignment

In the original SPEA, a perceived weakness was that individual solutions which were dominated by the same members of the external archive were assigned the same fitness values. There is a reduction in functionality in the original SPEA when the external archive contains only one solution. All members of the population which are to be assessed for fitness are then assigned the same value, with no cognisance given to the existing dominance relationships between them.

SPEA2 has rectified this by implementing a more complex fitness assignment procedure which now includes a sub-routine which calculates both the number of solutions a specific solution is dominated by and the number of solutions that solution dominates. The improved SPEA2 fitness assignment process is illustrated in Figures 20 [5.1] and Figure 21 [5.1] below.

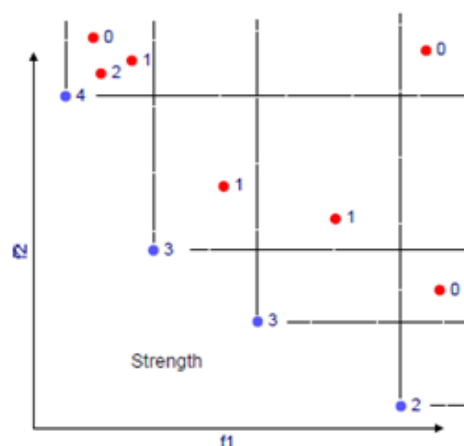

Figure 20: SPEA2 Fitness Assignment Procedure - Strength

In Figure 20, each solution is assigned a strength value; which represents the number of solutions that are dominated by each specific solution. In Figure 21, the fitness of the dominators of each specific solution in both the population (P) and the external archive (A) is used to establish a raw fitness value. This is calculated by summing the strength of all the solutions dominating each other solution. A high raw fitness value indicates that a specific solution is “highly” dominated; which shows that many other solutions are fitter, the aim is to minimise this value [5.2] to be as close to zero as is reasonably practicable. As only “fit” solutions are used to populate the Pareto Front, this fitness assignment procedure is integral to the process and also to ensuring the high quality of the solutions used to inform the network planning decisions.

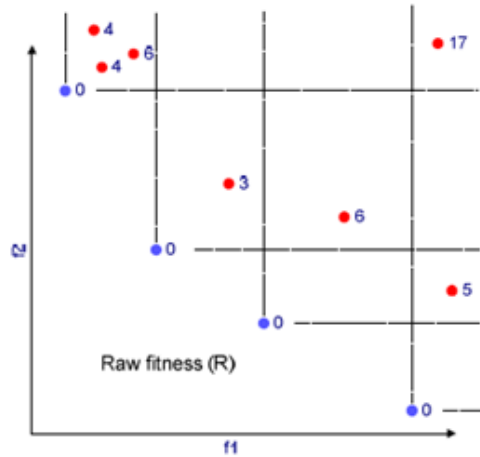

Figure 21: SPEA2 Fitness Assignment Procedure - Raw Fitness

### 5.2.3 SPEA2 Density Estimation

When two individual solutions have identical raw fitness values, a density estimation technique is utilised by SPEA which calculates the inverse of the distance to the  $k^{th}$  nearest neighbouring solution. Formally this can be expressed as

$$D(i) = \frac{1}{\sigma_i^k + 2} \quad (21)$$

where  $\sigma_i^k$  is the distance to the  $k^{th}$  nearest neighbouring solution. To ensure that the calculated value of  $D(i)$  is always  $> 0$ , there is the addition of the value 2 in the denominator. The fitness of a solution is improved when, in addition to the previously calculated density and raw fitness values, each individual solution has no (close) neighbouring solutions.

### 5.2.4 SPEA2 Archive Truncation

The addition of the truncation operator ensures that boundary solutions survive each new generation which will result in the search space being fully explored. This avoids the issue of solutions being limited to local optima and exploring the entire search space to obtain global optima will be both achievable and desirable.

During environmental selection there are a number of possible scenarios when non-dominated solutions are replicated from the population ( $P$ ) and the archive ( $A_t$ ) to populate the external archive at the next generation -  $A_{t+1}$ . These are either:

- When the size of  $A_{t+1}$  is equal to the size of  $A_t$ , then the environmental selection process is complete; or
- When the number of non-dominated solutions to be copied into  $A_{t+1}$  is less than the size of  $A_t$ , then  $A_{t+1}$  is populated with the fittest of the dominated solutions from both  $P_t$  and  $A_t$  that would otherwise have been discarded; or

- When the number of non-dominated solutions to be copied into  $A_{t+1}$  is greater than the size of  $A_t$ , then a truncation operator is applied, as previously described.

During each iteration an assessment is carried out and the individual solution which has the shortest distance to a neighbouring solution is deleted. In the event of there being multiple solutions with identical minimum distances, then the second minimum distance is the discriminatory factor to be used when deletion is the desired outcome.

### **5.3 Modifications to MODERNE Structure for EV Analysis**

There have been a number of changes made to the structure of MODERNE to enable it to be used to optimise the siting, sizing and operational envelope of multiple EVs. Rather than optimising DERs to be integrated within a distribution network, the structure and input files of MODERNE were adapted to enable it to be used to calculate the configuration of multiple EVs when the following are the DVs:

- EV battery size;
- Charger power output;
- Number of EVs;
- Location; and
- Operational envelope.

When the configuration of the five DVs above is obtained (based upon the chosen multi-objectives), this can be used to ensure that the additional demand from multiple EVs does not result in the breaching of (for example) the thermal/voltage limits of the distribution assets; the mitigation of this will require significant investment in reinforcement solutions.

The impact of the additional EV demand is based upon the time of the EV charging routine and the length of the charging routine; which will be a function of the number of EVs, the EV battery size and the charger power output. To ensure the optimal integration of EVs, the time of the EV charging routine is then correlated to match times of expected renewable generation availability which will provide the best value to the DNO.

The original MODERNE framework analysed four different DER technologies concurrently and it was appropriate to replicate this procedure for EV integration by simulating four unique EV types (with fixed EV battery size and charger power output) which were assigned to each EV type. Structural changes were made, both to the method used by MODERNE to analyse the model inputs and to the construction of the various calculation matrices.

## 5.4 Summary

This chapter contains a description of SPEA2; which underpins the MODERNE framework and details the key aspects of SPEA2 which have been utilised within the MODERNE framework. Further, the component parts of SPEA2 were explored with reference to the EV integration problem, which will be the focus of this work.

The detail relating to the available EV planning objectives/attributes within the framework were discussed as were the rigid constraints which bound the problem.

This chapter identified the importance of:

- The diversity of the initial population;
- The encoding and decoding of data;
- The objective evaluation;
- The environmental selection; and
- The practical application of the crossover and mutation operators.

There were a number of modifications to the structure implemented within the MODERNE framework; it is these changes that are vital when the EV optimisation and integration problem is to be considered.

The following chapter will discuss the results and analysis from a number of case studies relating to the optimal EV integration problem; these were carried out using the updated MODERNE framework as described above.

## 5.5 References for Chapter 5

- [5.1] A. D. Alarcon-Rodriguez, "A *Multi-objective Planning Framework for Analysing the Integration of Distributed Energy Resources*," Doctoral Thesis, University of Strathclyde, 2009.
- [5.2] E. Zitzler, M. Laumanns, M. and L. Thiele, "*SPEA2: Improving the Strength Pareto Evolutionary Algorithm*", Technical Report 103, Swiss Federal Institute of Technology, Zurich, 2001
- [5.3] Ofgem "*RIIO-ED1: Losses Discretionary Reward decision for tranche two*" 2018  
<https://www.ofgem.gov.uk/publications-and-updates/riio-ed1-losses-discretionary-reward-decision-tranche-two-2018>  
Accessed 21 December 2018
- [5.4] Northern Powergrid "*Strategy for losses*" 2017  
<https://www.northernpowergrid.com/downloads/4144>

Accessed 21 December 2018

- [5.5] Energy Networks Association "*Engineering Recommendation P2 Issue 7 2019 Security of Supply*" 2019

[http://www.dcode.org.uk/assets/files/Qualifying%20Standards/ENA\\_EREC\\_P2\\_Issue%207\\_\(2019\).pdf](http://www.dcode.org.uk/assets/files/Qualifying%20Standards/ENA_EREC_P2_Issue%207_(2019).pdf)

Accessed 29 August 2019

- [5.6] Ofgem, "*RIO-ED1 Annual Report 2015/16*" 2016

<https://www.ofgem.gov.uk/ofgem-publications/111716>

Accessed 05 January 2019

- [5.7] Customer-Led Network Revolution (CLNR), "*Project Closedown Report*", 2014

<http://www.networkrevolution.co.uk/wp-content/uploads/2016/09/CLNR-G026-Project-Closedown-Report-FINAL-V2.1-070916.pdf>

Accessed 11 January 2019

- [5.8] R. L. Haupt and S. E. Haupt, "*Practical Genetic Algorithms*," ISBN 0471455652, John Wiley and Sons, 2004

- [5.9] K. Deb, "*Multi-objective Optimisation using Evolutionary Algorithms*," Wiley 2001

- [5.10] D. Beasley, D. Bull, and R. Marting, "*An Overview of Genetic Algorithms: Part 2: Research Topics*," University Computing, Vol. 15, pages 170-181, 1993.

## Chapter 6 - EV Integration Case Studies and Analysis

In this chapter, the efficacy of the planning framework is demonstrated by applying the network models and the accompanying datasets to MODERNE when evaluating the optimal managed integration of EVs in distribution networks. The case studies and the results generated by MODERNE are discussed within this chapter; these results are used to demonstrate how the output from MODERNE can be used to inform the asset investment decision making process when multiple EVs are integrated into distribution networks to mitigate the intermittency of renewable generation. The MODERNE framework was applied to two simulated distribution networks, which are both based upon the United Kingdom Generic Distribution System (UKGDS) network model and utilised the accompanying demand and generation datasets which were provided (though these were adapted).

MODERNE was used to identify the optimal number, location, EV battery size, charger power output and operational envelope for multiple EVs at each node in the model, when EVs are used as responsive demands (to mitigate the intermittency of renewables) in HV/LV distribution networks. The output from the case studies will evidence that the framework is flexible and can be utilised to approach differing networks (rural/urban or radial/meshed) and will also demonstrate the impact of EV integration upon network assets. The approach proposed in this thesis enables the decision maker to identify, in a single study, the optimal number, type and operational envelope of multiple EVs at each node, in a distribution network, when EV charging was used to mitigate the intermittency of the renewable generation export. It will be demonstrated that the proposed method is appropriate to be used with both rural radial networks and urban meshed networks to mitigate the intermittency of renewable generation.

This chapter will present the case studies used to underpin this research, the network models used will be formalised, the objectives and decision variables will be detailed and the results and the output from the planning tool will be analysed and the conclusions and findings will be examined.

In the first case study, the optimal integration of multiple EVs in a rural HV distribution network, when used to mitigate high penetrations of intermittent wind, is examined, as the continuing increase in the capacity of installed wind in rural networks (without a significant increase in demand) could cause generation to be constrained at times of low load. This case study demonstrates the concepts of multi-objective optimisation and the application of these techniques within the planning

framework; to both increase the number of EVs that can be accommodated in a distribution network and to increase the utilisation of renewable generation.

The second case study explores the use of the managed charging of EVs to maximise the utilisation of PV export in an urban network as there is value in ascertaining how to improve the utilisation of the generation export. Specifically, this case study relates to identifying the optimal configuration of EVs to increase the utilisation of PV in an urban HV distribution network. These results expand the existing knowledge base when the managed charging of EVs is used to maximise the export of PV at times of low base load.

## **6.1 UKGDS Network Models**

To carry out the analysis required for this research and to explore the proposed case studies, the UKGDS network was utilised to create two reduced HV networks for a number of reasons:

- The UKGDS network is based upon the statistical analysis of actual distribution networks in GB [6.1];
- The network characteristics (topology and technical specifications) were readily available in a tabular format which was appropriate to be input directly into MODERNE;
- The UKGDS network model was straightforward to modify for the purpose of creating two bespoke HV networks to be used in the analysis; and
- The UKGDS network models and data sets (demand and generation) are well described in the literature and have been previously used to study the impact/benefits of traditional DERs on distribution networks.

It is noted that the UKGDS are older models, however they have been modified for use in these studies, for example, a scaling factor has been applied to the UKGDS demand data and additional circuits were incorporated within the model to be representative of GB DNO networks at these voltage levels. The topology of these networks did not require to be updated significantly as the GB networks they were based on have not changed significantly in the past 40 years, though the way distribution networks are operated by DNOs has changed.

The technical parameters of the circuits (cables/lines) which underpin these network models are average values [6.1] which have been normalised to avoid unintended breaches of thermal and voltage constraints [6.2]. The MODERNE framework was applied to the networks and was used to produce results for each EV integration case study based upon the assumptions and the chosen objectives with respect to constraints. The modelled networks which were used in the analysis to produce the case studies will each be described in further detail in Sections 6.2 and 6.3.

The complete UKGDS is comprised of overhead lines and underground cables at various GB distribution voltages (132kV, 33kV and 11kV) with 281 busbars and 322 branches supplied by 4 GSPs with a generation contribution at 5 nodes; it is noted that in Scotland, 132kV is a transmission voltage level. The networks utilised within these case studies were based upon the UKGDS using the data available, but the topology was modified to ensure that whilst they differed in structure (one being radial and one being meshed containing rings) they were both typical of real DNO networks at HV in GB; with accompanying load and generation datasets used to underpin the networks. Both modelled networks contain a number of 11kV underground cables, overhead lines and a 33/11kV connection point which is used to import or export to the 33kV distribution network; finally, to ensure that the networks are representative, they both contain high penetrations of renewable generation.

It is the use of the managed charging of multiple EVs to mitigate the intermittency of renewable generation export that will form the basis of the case studies. Previously EVs (as responsive demands) were defined as belonging to the wider family of DERs and as the EV charging rate can be varied through the use of communications, metering and a control strategy, it is the aim of this work to demonstrate that the managed charging of EVs can assist the DNO in realising multiple network benefits. However, the aim is not only to shift demand away from times of peak, but to use managed EV charging strategies to mitigate the intermittency of renewable generation at times of low base load; this can reduce the dependency of the 11kV network on imports from the EHV network (with associated distribution losses) and to increase the self-sufficiency of the 11kV network.

#### 6.1.1 EV Types and Decision Variables

Before the case studies were undertaken, simulation based modelling was carried out external to MODERNE, where the optimal EV battery size, charger power output and operational envelope were obtained (based upon the network data). These variables would inform the specifics of each solution relating to the EV type (EV battery size, charging routine and charger power) which were used as building blocks to inform the solutions that comprise the Pareto Front (see Section 4.3.3). This was used to inform the specifics of each of the four EV types used in the analysis.

When the aim is to maximise the penetration of EVs, the problem space is constrained by the maximum number of EVs that can be sited within the network; this is limited by the number of domestic properties in each network, i.e. urban off street charging. For both these case studies, it is assumed that only one EV will be charged at each property at any half-hourly period and the



penetration level of EVs to be sited in the network will be given. The headroom available for EV charging, which informs the maximum number of EVs which could potentially be sited at each node, is dependent upon the daily demand profile, the start time of the charging routine, the length of the charging routine (which varies based upon the EV battery size and the charger power) and the rating of the transformer which are all detailed fully in the technical data and the output of the model. The expected availability of export at the nodes where generation is installed can be predicted based upon historic data and it is desirable to coordinate EV charging at times of higher generation export availability as this will be an efficient use of the generation plant. There is still significant uncertainty relating to the behaviour patterns which will underpin future energy use and the corresponding demand curves when the penetration of EVs (and Heat Pumps) is widespread.

The total time taken to complete the EV charging routine is dependent upon the initial battery SOC (which is assumed to be zero for each EV to encompass worst case scenario planning), the size of the EV battery and the charger power. There are upper and lower bounds placed upon the EV battery size (14kWh - 35kWh) and the charger power (3kW - 7kW) to ensure the results generated are realistic and can be implemented to inform planning and investment decisions. The values in the studies are chosen to be rigidly within these ranges, however when the standard charger power output used and battery size vary, new values can be assigned to the planning framework.

Whilst EV fast charging will require chargers sized at greater than 7kW, these are not expected to be installed at domestic properties due to the requirement for reinforcement. If an EV battery was to be significantly reduced in size, there would be a reduced driving range and if it were increased in size, the purchase cost of the EV would become prohibitive.

In this work, an EV battery is modelled as a constant power load with a unity power factor as with the expected improvement in both battery technology and the developments in Smart EV chargers; this will be desirable to the consumer. A lossless demand model of the battery is assumed (a single EV battery which was modelled in Matlab and discussed in Section 4.2) with the full capacity being available (due to worst case scenario planning - an empty battery) and the charger delivering the required power at a constant level.

In advance of the MODERNE framework being used to determine optimality with respect to the chosen multi-objectives, the author carried out work to identify the 4 EV types to be used in each case study. However, the specifics of each EV type can be amended if required and then the case

studies can be repeated. The aim was to identify 4 EV types with each one defined by; the EV battery size, the charger power output and the operational envelope (charging times). Simple calculations were carried out with the base data being the chosen network topology and the daily demand and generation profiles which are assigned to each node at each half hour (of one day). Specifically, to evaluate the EV battery size and charger power output (to be used in the EV types), additional EV load (based upon the number of EVs at each node and the charger power output) was added to each node where there was additional demand headroom (this continues until the EV battery was fully charged - based upon the EV battery size and the charger power output). The impact of the EV types at various nodes on the network was observed until the rating of a transformer was breached. However, despite the success of this methodology in a small modelled network, this was a labour intensive task where a working knowledge of the network topology and the loading on each node were all required to create the 4 EV types. The operational envelope (charging routine start time) was assigned to each EV type based upon times of low load (generally) or the high availability of renewable generation. Ideally, the process to identify the 4 EV types would have been created in a bespoke software tool external to MODERNE as this would be more efficient and robust.

The maximum (best case) additional load which could be accommodated at each node (due to EV charging) was also calculated to observe the maximum threshold value. To achieve this, the minimum demand at each node was obtained based upon the daily demand profile; the rating of the transformer and the demand profile were analysed to inform the maximum number of EVs of each type that feasibly could be sited at each node in the network. When the additional EV load breaches any of the network constraints (such as the transformer rating) at any half-hour, MODERNE will not utilise these results and these results will be discarded from the archive.

Obtaining the DVs to be used to configure each EV type required analysis to be undertaken when the additional load from the EV charging process (based upon the stated DVs) was added to the daily base load at each node at each half-hour. The maximum EV battery size, charger power and the additional load (based upon the stated EV penetration in each scenario) which will be assigned to the network must not breach certain predefined limits, though these limits can be varied. Finally, four charging routines to be analysed by the MODERNE framework are identified by correlating the requirement to incorporate the magnitude of the additional EV demand (based upon the EV penetration) with the availability of the generation export based upon the daily profiles.

If, for example, the charger power output was reduced, then the time taken to charge a single EV battery would increase. There would then be the potential for a number of additional EVs to be sited at each node, as the demand at each half-hour attributed to EV charging would have decreased. However, caution must be taken as the decrease in charger power would result in the time taken to charge the EVs at that node increasing. There could be the unintended consequence that the EV charging routine which was intended to take place at a time of low demand could then continue into the peak demand period; this would then introduce additional capacity issues. It is the evaluation of these trade-offs which the MODERNE framework will be used to analyse.

### 6.1.2 Demand and Generation Data

The UKGDS provides annual generic demand data (relating to four defined customer archetypes) which is then used with the MODERNE framework and the simulated network models [6.1]. In this work, the underlying demand data used is based upon the UKGDS demand data for each of the four customer types (standard profiles), which is then aggregated at each half-hourly period (with a load growth factor having been applied as this data is over 10 years old). This demand is spread (based upon the data in Appendix 2 and Appendix 5) over each node in the modelled networks.

To assess the impact of multiple EVs upon the HV network, the additional aggregated EV demand is then included (based upon the number of EVs at each node, the EV battery size and the charger rated power) at each half-hour commencing at the start time of the charging routine.

This work will quantify the benefits to be realised when EV charging routines are coordinated to utilise the export from intermittent generation. In the first case study, a daily wind profile based upon UKGDS measured wind data [6.1] is used to create half-hourly samples and therefore generation export models which can be combined with the yearly aggregated demand profiles. In the urban network used for the second case study, the generation export data from PV used was created based upon historical DNO FiT (Feed-in Tariff) data and is the aggregation of a number of domestic PV panels at each HV/LV node (based upon an assumed penetration level and the number of domestic properties) [6.3].

The increased penetration of G83/G98 [6.4] (small scale domestic) PV will offer network benefits to the DNO which can be realised when the managed charging of EVs correspond with times of high PV availability and minimum demand. It is expected that over time, the utilisation of EV batteries as small scale storage will drive the continued increase in the installed capacity of domestic PV.

The presented case studies will demonstrate the benefits to be realised by the DNO from the managed integration of multiple EVs in an HV network, in both a radial rural network and a meshed urban network, with both networks incorporating high penetrations of intermittent renewable generation.

## **6.2 Case Study 1: The Optimal Integration of EVs to Maximise the Utilisation of Wind Generation**

This case study will analyse the optimal integration of multiple EVs in a rural 11kV network with radial overhead lines and underground cables, when the aim is to mitigate intermittency whilst increasing the utilisation of the installed wind generation. The UKGDS defines DG over a period of one day. The case studies have therefore been tested with intermittency over a 24-hour period, but not for the more extreme variations over a longer period. To do this, it will be desirable to minimise the energy emissions factor and the grid dependency, whilst maximising the exported energy and the penetration of EVs to be not greater than a certain predefined limit. The optimal EV battery size, charger power and operational envelope will be identified, as will the nodes on the network where there will be the most benefit from the siting of multiple EVs and the managed charging of these; when EVs are used to maximise the utilisation of the renewable generation. The results from the optimisation process will be limited by the operational constraints of the network, such as the overload probability of the thermal loading in the lines, the charger power output and the maximum EV battery size. This case study will detail the optimal operation configurations to be applied to multiple EVs in a rural 11kV network when the managed charging of EVs is used to mitigate the intermittency of wind generation.

### **6.2.1 UKGDS 75 Node Rural Network Model**

An 11kV distribution network model was developed; see Figure 22 below, this was based upon the UKGDS which was chosen to demonstrate the robustness and the effectiveness of the MODERNE network planning tool. This network was designed to be representative of a typical GB distribution network as it contains both urban and rural feeders with load and generation profiles to be applied to each node.

The network consists of a 33/11kV primary substation which connects the 11kV network to the EHV network (which will be treated as a grid infeed) and the imported energy will be modelled as a generation unit supplying the 11kV network, which is only limited by the rating of the two 12/24MVA (OFAF) transformers at the 33/11kV primary substation. Eight HV feeders are connected to the 11kV outlets at the primary substation busbars and these are comprised of 3 urban feeders

(urban underground cables; circuits 01-03, 07-09 & 10-14) and the remaining 5 feeders in the network are rural feeders (overhead lines); see Appendix 1 for circuit impedance data. Demand data was obtained from the UKGDS [6.2] as were the technical parameters of the lines and cables.

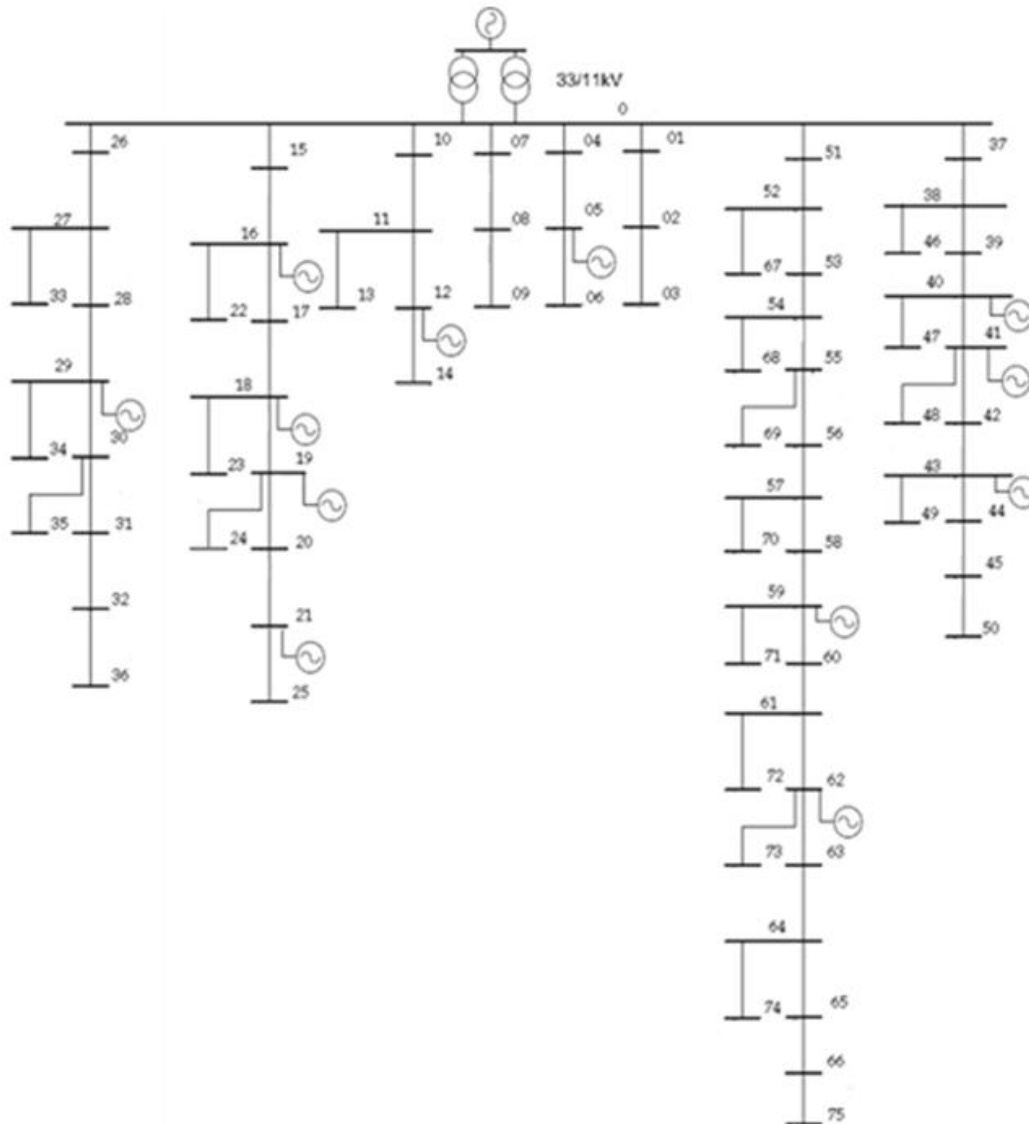

**Figure 22: 11kV 75 Node Distribution Network**

Each HV/LV node in the 11kV network is assumed to be either an urban 11/0.4kV ground mounted (GM) transformer rated at 1MVA or a rural 11/0.4kV pole mounted (PM) transformer rated at 0.315MVA. Each GM transformer in the network could typically supply, on average 200 domestic customers, while a PM transformer could typically supply, on average 100 domestic customers. However as the penetration of EVs increases, there will be an impact upon the maximum number of domestic customers that can be served by either a GM or PM transformer and there will be significant network investment in reinforcement required to uprate the assets. To create the demand profiles an assumed ADMD of 2kW [6.5] is assigned to each domestic customer (without

EV). It has been shown that the unmanaged charging of a single EV at a domestic property (for the average household) will double the observed (ADMD) peak demand [6.5]. However, it is assumed that there are 2,500 domestic properties in the modelled network as well as numerous other large industrial and commercial properties which contribute to the base load.

Based upon concurrent peak demands, with no contribution from installed generation, the peak at the 33/11kV primary substation was calculated to be 16.09MVA and the firm capacity of the primary substation is 24MVA (without utilising short term emergency ratings). Based upon this, there is 7.91MVA of total headroom available to accommodate the additional EV load, assuming no contribution from the installed generation. However, the capacity for an additional EV load at each HV/LV node is dependent upon the time of the EV charging routine and the daily load profile at the 11/0.4kV transformer.

The network model used for the case study has 75 HV/LV nodes, with each node having a load assigned to it, based upon the customer numbers as stated above. Peak demands and daily demand profiles have been obtained, which are appropriate to be used for worst case scenario planning and these were based upon UKGDS demand data and further adapted for use in this work [6.2]; see Appendix 2 for load data which was used in Case Study 1. A diversity factor would typically be applied to each peak demand to enable the increased utilisation of the distribution network; however, as has been stated previously, it will be assumed for worst case scenario planning, that each peak will be concurrent, so no diversity scaling will be applied.

The UKGDS demand data was modified and load profiles were created and scaled based upon the peak demand at each node, the aggregation of the 4 UKGDS customer types and the load profiles were assigned to each node. EV batteries are modelled as constant power loads (demands) with unity power factors. However the power factor at each HV/LV node is assumed to be 0.95, which is the standard target power factor in GB distribution networks. The demand at each HV/LV node is not sufficiently large that varying this power factor would not have significant impact.

Within the simulated network, there are 12 wind farms (modelled as generators) with an installed capacity of 1MW each, sited at various nodes on the 11kV network (on the HV side of the 11/0.4kV transformers); see Appendix 3 for generation data. The export from each generation unit, at each half-hour is dependent upon the time of day and based upon readily available data from UKGDS [6.2].

The UKGDS half-hourly generation data was modified to be representative of the capacity of the installed generation within this network and the average export (based upon the 48 half-hourly periods) was measured to be 0.285MWh which was equivalent to the standard windfarm capacity factor of 27%.

The firm capacity of the transformers at each node in the modelled network is either 1MVA or 0.315MVA. The challenge to the Network Planner is to increase the utilisation of the network assets at each node by increasing the penetration of EVs (within limits) and in doing so minimising the energy emissions factor and the grid dependency whilst maximising the exported energy. In addition to maximising the penetration of EVs (without breaching network constraints), the responsive charging of EVs can increase the utilisation of intermittent renewable generation export.

In this case study, based upon the presented demand and generation profiles and to meet the stated multi-objectives, the number and configuration of EVs to be sited at each HV node will be presented, as will the optimal EV battery size, charger power output and the operational envelope; the time periods that the charging routines should take place in to ensure that the penetration of EVs and the exported energy are maximised whilst the energy emissions factor and the grid dependency are minimised; though remaining aware that the overload probability is limited to not be greater than 2%.

### 6.2.2 Objectives, Constraints and Model Inputs

This case study is defined by the following chosen objectives:

- Minimise energy emissions factor;
- Maximise exported energy; and
- Minimise grid dependency.

These objectives were chosen as they represent real world planning objectives of interest to multiple stakeholders; to receive the optimal benefit from the installed generation within the network and to reduce the costs of energy imported to meet peak demand when the generation output is not sufficient. In this study, the penetration of EVs in the network would be limited to 10% which corresponds to 250 EVs. A 10% penetration of EVs is reasonable as in the short to medium term; the penetration of EVs is not expected to be greater than 15%. The MODERNE framework is utilised to obtain the optimal number of EVs to be sited at each node without breaching network constraints. The SPEA2 parameters in this case study are shown in Table 3 below. As has been stated previously, the time taken to complete the optimisation module and carry out a load flow for

each solution was significant; therefore restricting the population size, archive size and number of generations all to 50 was desirable, as this will reduce the overall computational time required to complete each case study. During the initial setup of MODERNE, there is a requirement for the user to restrict the maximum overload probability. DNOs do not plan for network assets to be overloaded, but during this case study, this value is set to not be greater than 2% (of the time) which is reasonable as, in practice, network assets can be overloaded for approximately 300 half-hourly periods a year as excursions from asset ratings are efficient and can reduce reinforcement costs.

**Table 3: SPEA2 Input Parameters for Case Study 1**

Total Size	50
Archive Size	50
Crossover Probability	0.8
Mutation Probability	0.01
Minimum Number of Generations	50
Maximum Number of Generations	50
Overload Probability	0.02

Assigning a non-zero positive value to the overload probability enables solutions to be observed which are out with the bounds of the real world planning horizon, as this could influence asset investment decisions where reinforcement could add significant value to the solution set.

### 6.2.3 EV Types and Charging Routines to be used with Case Study 1

In advance of utilising the MODERNE framework to obtain the optimal EV configurations at each node in the network with respect to the chosen multi-objectives, work was carried out by the author to create the four EV types (see Table 4 below) to be used; where the DVs were chosen by the decision maker (using the techniques as described in Section 6.1.1) to be both realistic and sufficiently varied to ensure that the results could be applied to inform investment planning and operational decision making. As stated previously, upper and lower constraints are placed upon the EV battery size (14kWh - 35kWh) and the charger power (3kW - 7kW).

**Table 4: EV Types and Charging Routines for Case Study 1**

EV Type	Battery Size (kWh)	Charger Power Output (kW)	Charging Routine Length (hours)	Charging Routine Start Time
1	28	4.12	6.79	0830
2	35	5.71	6.12	1000
3	30	6.45	4.65	0900
4	15	5.04	2.97	1230



In addition to the EV types, which are required when solutions are decoded, 4 EV charging routines were also chosen and assigned to an EV type based upon the charging routine length, the daily demand profiles and the availability of generation export. Together, the EV types and charging routines (with the network topology, demand and generation profiles) were combined and applied to MODERNE, where the framework will be used to assign the EV types and charging routines to each node to meet the stated multi-objectives.

#### 6.2.4 MODERNE Output and Results

The results, when the framework is applied to the rural network, are graphically presented below in Figures 23 to Figure 28. The output being displayed in this way enables the solutions and the Pareto Front to be presented and also easily interpreted.

The four EV types are optimised within the MODERNE framework and with each iteration the number of EVs of each type are assigned to nodes in the network (based upon the fitness of each solution) which are required to meet the multi-objectives stated above. This is carried out whilst ensuring the overload probability is not greater than 2% and the constraints - transformer ratings, EV battery size and charger power output - are not breached. The maximisation of exported energy has been chosen to ensure the optimal financial benefit of the installed generation in the network will be realised. When grid dependency is minimised, solutions will show that the 11kV network becomes more self-sufficient and less reliant on imports from the 33kV network at the time of peak demand and this objective should dovetail with the minimisation of the energy emissions factor objective.

The graphs in Figures 23 to Figure 28 display the solutions which the optimisation tool have defined to be optimal (given the number of iterations and the stopping criteria) for the multi-objective optimisation problem, showing overload probability against energy emissions factor, overload probability against exported energy, overload probability against grid dependency, grid dependency against emissions factor, exported energy against grid dependency and energy emissions factor against exported energy.

#### 6.2.5 Discussion and Results

When the MODERNE framework was applied to the radial 11kV rural network (based upon UKGDS data), the Pareto Front shows that in every optimisation scenario the thermal overload probability is zero; see Figures 23 to Figure 25 below, this is expected as the maximum penetration of EVs in this case study is too low to be problematic (assuming a reasonable spread of EVs). As there is interconnection to the 33kV distribution system, the modelled network is automatically balanced

and any solutions which produced overloads in the network were discarded from the archive in advance of the stopping criteria being met.

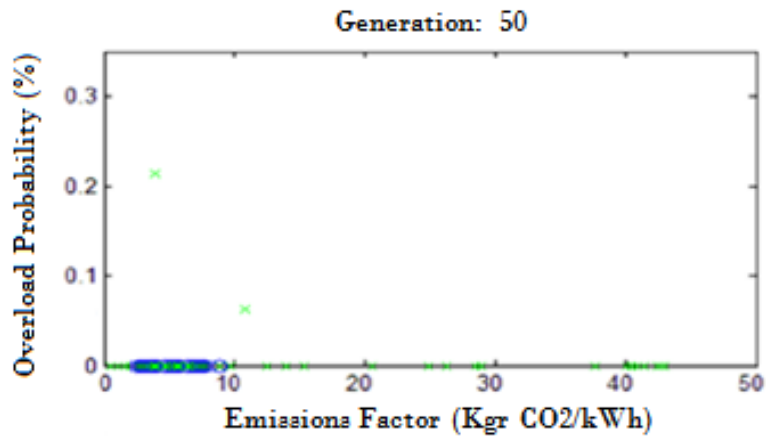

Figure 23: Overload Probability against Energy Emissions Factor

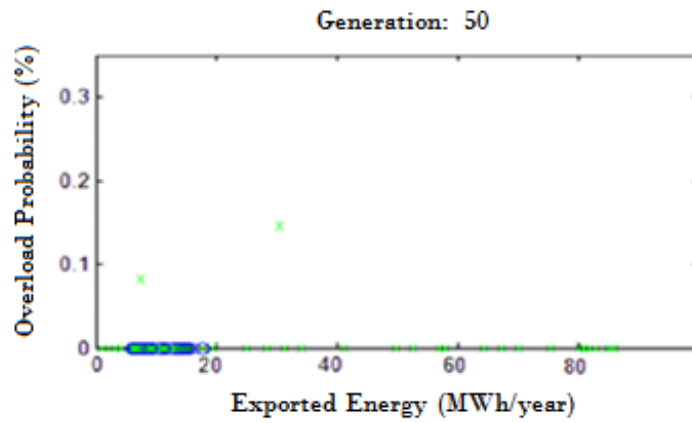

Figure 24: Overload Probability against Exported Energy

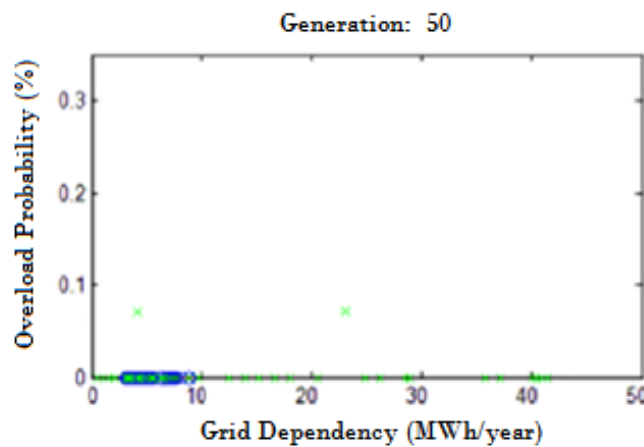

Figure 25: Overload Probability against Grid Dependency

Figure 26 shows the grid dependency (as previously defined in Section 5.1.4.3 - equation 11) against energy emissions factor and it is clear that when the network's dependency on imported energy from the 33kV network decreases, the energy emissions factor also decreases. As the times of EV

charging have been correlated to match the availability of the generation export, the installed generation capacity can then be better utilised locally and this will result in the in a reduction in the energy required from the 33kV network to meet demand and as a consequence, the energy emissions factor within the 11kV network also reduces.

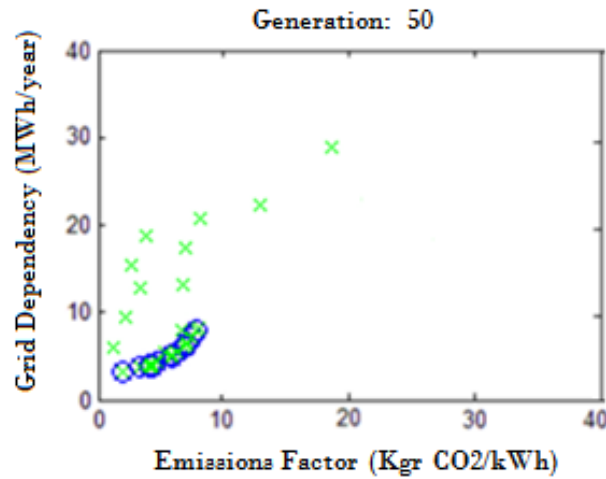

Figure 26: Grid Dependency against Energy Emissions Factor

Figure 27 shows that as exported energy decreases, the grid dependency also decreases. When the energy generated within the 11kV distribution system is used locally and not exported to the 33kV network, then the installed generation is being efficiently utilised to meet the additional EV demand within the 11kV network. If EV charging times are not correlated with times of generation availability and the generation export is not utilised locally, then there will be a generation surplus which is then exported to the 33kV network. However, this will mean that when EV charging does not coincide with the availability of generation export; then to meet the additional EV demand at times of peak, there will be an increased dependency on energy required from the 33kV distribution system.

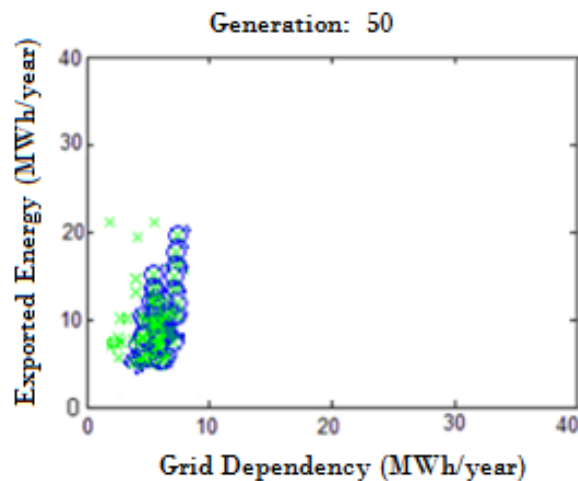

Figure 27: Exported Energy against Grid Dependency

Figure 28 shows that as the energy emissions factor decreases, the exported energy also decreases; as the utilisation of the installed generation within the 11kV network was improved by the use of the generation capacity to meet the additional demand during times of EV charging, therefore the energy exported from the 11kV network will be reduced, as it is required to be used within the local network to meet demand from EV charging. The figure below shows a high linear dependency and this is both expected and an artefact of the underlying modelling. As the energy generated within the network is used locally (and not exported) then the emissions factor also reduces as there is a lower requirement to import energy from the 33kV network.

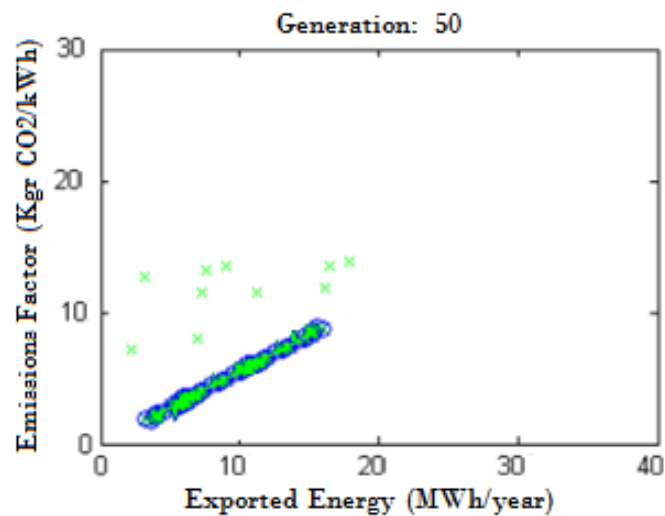

Figure 28: Energy Emissions Factor against Exported Energy

However, as MODERNE can incorporate multiple (and conflicting) stakeholder viewpoints, when it is desirable that the exported energy (to the 33kV network) is maximised to ensure an increased revenue for the generation owner, then the Network Planner is required to compromise the requirement to increase the exported energy with the trade-off that the energy emissions factor and grid dependency will also increase concurrently. This trade-off and the decisions to be made will be explored in Section 6.2.6 below.

### 6.2.6 Trade Offs and Compromises

When the Network Planner has to choose which solution from the Pareto Front best meets the objectives under consideration, a decision must be made with the solution to be implemented being chosen from the Pareto Front. Essentially the choice becomes, what objectives are qualitatively less important and what level of detriment in those objectives is acceptable to the decision maker when MCDM and post-hoc analyses are carried out. Table 5 presents the results for each objective and the detail for each of the three solutions at either end of the Pareto Front (and a mid-point value).

**Table 5: Solution Data for Case Study 1**

Planning Objective	Solution		
	A	B	C
Energy Emissions Factor (Kg CO <sub>2</sub> /kWh)	2.14	5.10	9.61
Exported Energy (MWh/year)	3.01	11.57	18.70
Grid Dependency (MWh/year)	2.38	4.87	9.81
Overload Probability (%)	0.00	0.00	0.00

It is this process of comparing trade-offs and the following decision making that is undertaken which fully utilises the output from MODERNE and the graphically displayed Pareto Front. Figures 29 to Figure 34 present the solutions with two extreme values from either side of the Pareto Front chosen and a mid-point solution used to illustrate the range of options available to the decision maker.

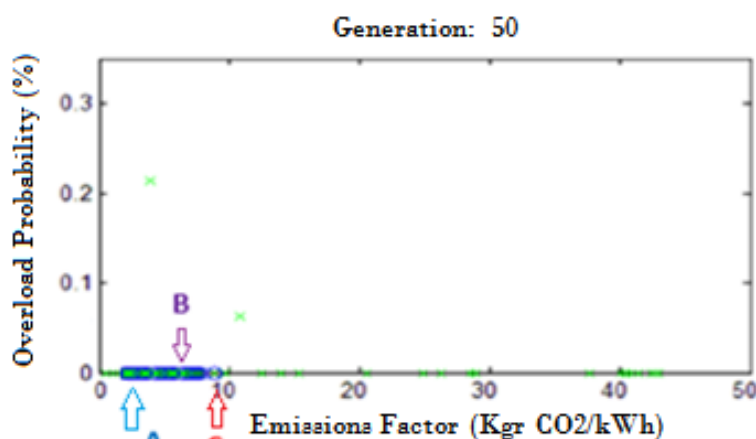

**Figure 29: Overload Probability against Energy Emissions Factor**

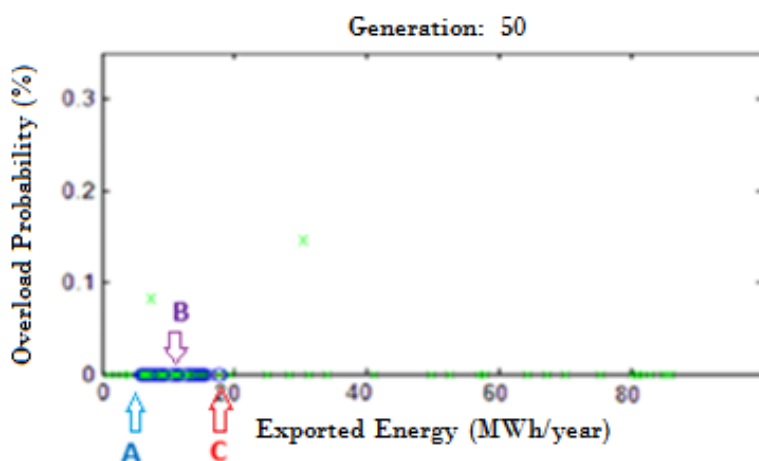

**Figure 30: Overload Probability against Exported Energy**

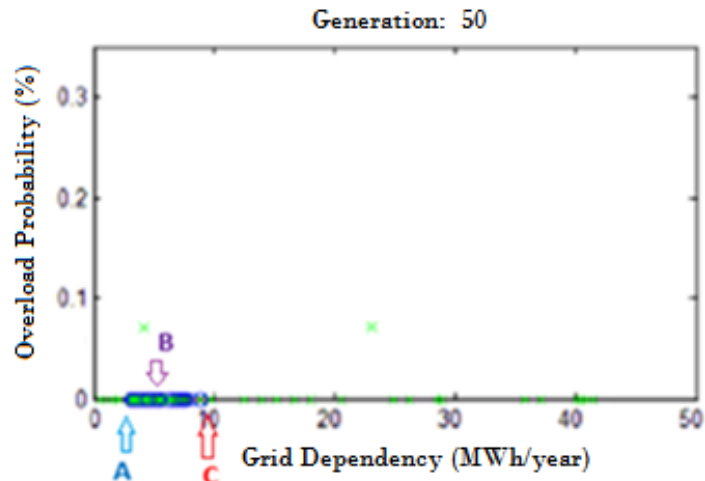

Figure 31: Overload Probability against Grid Dependency

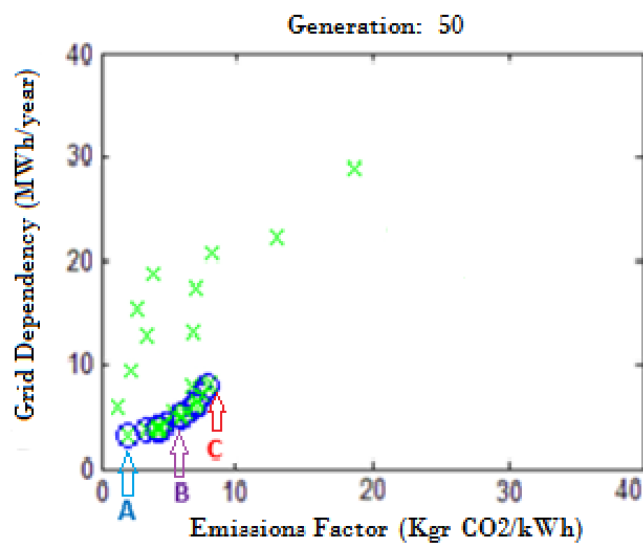

Figure 32: Grid Dependency against Energy Emissions Factor

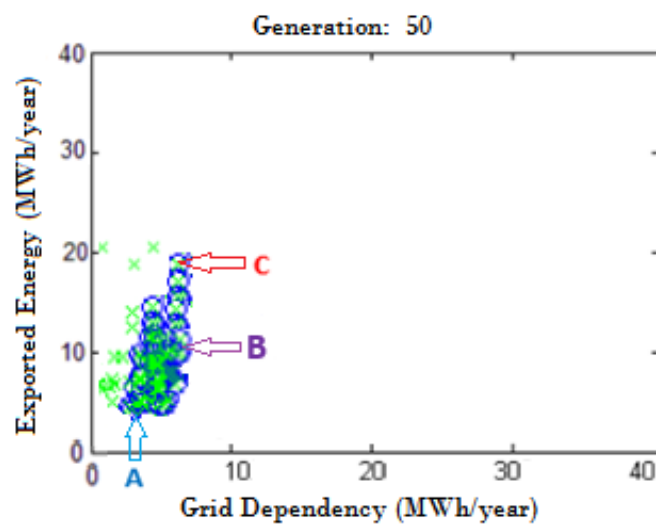

Figure 33: Exported Energy against Grid Dependency

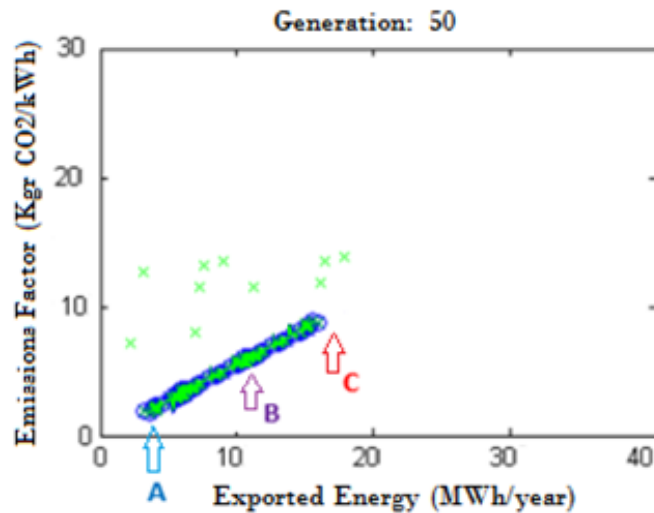

Figure 34: Energy Emissions Factor against Exported Energy

Solutions A, B and C are graphically represented in Figures 29 to Figure 34 and the three solutions correspond to the values contained within Table 5. As the solutions were chosen from the extremities of the Pareto Front for each planning objective, it can be seen that the specifics of each solution for each objective are different; with the exception of the overload probability which has a value of zero for all scenarios.

The values in Table 5 were obtained for all three solutions for the planning objectives studied, and based upon a target penetration of 500 EVs to be incorporated within the modelled network. The results show that the solutions obtained are varied and encompass the entirety of the Pareto Front. For the energy emissions factor, the solutions range from 2.14 to 9.61 Kg CO<sub>2</sub>/kWh, for exported energy the range is from 3.01 to 18.70MWh/year and the grid dependency ranges from 2.38 to 9.81MWh/year.

The data contained within Table 5, coupled with output from MODERNE is used to show the compromises that the Network Planner must make when conflicting objectives impact on the choice of solution to be implemented. If maximising the exported energy was desired (which would increase the revenue for the generation owner), then the trade-off is that the energy emissions factor and grid dependency would also increase, neither of which is desirable. The DNO would be required to decide if the revenue to be realised from export was greater than the cost of grid dependency and the associated imports. If this was the case, solution C would give an exported energy value of 18.70MWh/year, however the environmental impacts of the increased energy emissions factor (9.61 Kg CO<sub>2</sub>/kWh) would have to be assessed also.

Conversely, if the minimisation of the energy emissions factor was the primary planning objective, solution A returned a value of 2.14 Kg CO<sub>2</sub>/kWh which is the lowest value observed. The trade-off in this scenario is that the exported energy (to the 33kV network) is only 3.01MWh.

If the Network Planner wished to choose a solution where the objectives were all equally “good”, then solution B does not return any extreme values but all objectives were acceptable and the multiple stakeholder viewpoints would all be satisfied, but no planning objective would be optimal.

The numerical results for solutions A, B and C are displayed in Tables 6 to Table 8 below, where the number, type and location of the EVs in the network are detailed. When evaluated concurrently, the data relating to the chosen solution from Table 5 with the graphical output from MODERNE (Figures 29 to Figure 34) can be utilised and assist the Network Planner in deciding which of the solutions are to be implemented (regarding the specifics of the number of EVs of each type to be sited at a specific node) to mitigate the intermittency of wind generation. These tables, when taken together with the output from the planning framework allow the Network Planner to choose the specific configuration of EV types and numbers where the chosen multi-objectives are best met.

**Table 6: Solution A - Case Study 1**

Solution A		
Node	EV Type	Number of EVs
5	1	32
7	4	61
12	1	47
13	2	31
16	4	29
18	2	10
19	3	27
21	2	20
24	3	27
26	2	19
29	1	24
41	4	10
42	2	12
43	1	27
49	4	10
59	3	27
62	2	35
67	3	28



Solution A		
Node	EV Type	Number of EVs
73	1	24

**Table 7: Solution B - Case Study 1**

Solution B		
Node	EV Type	Number of EVs
5	2	17
7	1	80
12	2	33
14	3	41
17	1	17
18	3	8
19	2	34
20	1	13
24	4	20
26	1	18
28	3	27
29	4	19
35	3	28
36	1	14
41	2	9
42	1	15
43	2	18
49	3	28
59	2	26
62	4	35

**Table 8: Solution C - Case Study 1**

Solution C		
Node	EV Type	Number of EVs
1	2	48
5	1	32
7	4	55
8	2	20
9	3	16
12	2	47
13	1	31
16	2	22
19	1	20

Solution C		
Node	EV Type	Number of EVs
24	1	17
26	2	19
29	1	12
41	2	20
42	1	15
43	2	35
49	2	12
59	1	16
62	1	25
67	3	26
68	2	12

### 6.2.7 Case Study 1 - Conclusions

The aim of this case study was to optimise the integration of multiple EVs in a rural 11kV network whilst using managed charging schedules to mitigate the intermittency of wind. The three planning objectives chosen were to minimise the energy emissions factor and grid dependency whilst maximising the exported energy and penetration of EVs and being bound by technical constraints such as the rating of the circuits and transformers, the specifics of each EV type and the overload probability was limited to not be greater than 2%.

The findings from Case Study 1 are:

- No solutions were obtained where there is a greater than 0% probability of thermal overloads;
- To maximise the exported energy will result in the energy emissions factor also increasing (which is not desirable) as the energy generated within the network will not be used locally, so there is a requirement for energy to be imported from the 33kV network at times of need.
- To minimise the energy emissions factor and the grid dependency will result in the benefit to the generation owner also being minimised as the value obtained for exported energy is also an observed minima.

### 6.3 Case Study 2: The Optimal Integration of EVs to Maximise the Utilisation of PV Generation

This case study will analyse the optimal integration of multiple EVs in an urban 11kV meshed network, when the aim is to mitigate intermittency whilst also increasing the utilisation of PV

generation, both domestic installations and at two large PV farms which export energy directly into the 11kV network. For this case study, it will be desirable to minimise line losses and grid dependency, whilst maximising the exported energy and the penetration of EVs to be not greater than a certain predefined limit. The EV battery size, charger power and operational envelope will be identified, as will the nodes on the network where there will be the most benefit from the siting of multiple EVs and the managed charging of these; when EVs are used to maximise the utilisation of the installed renewable generation. The results from the optimisation process will be limited by the operational constraints of the network, such as the overload probability of the thermal loading in the lines, the charger power output and the maximum EV battery size. This case study will detail the optimal operation configurations to be applied to multiple EVs in an urban 11kV meshed network containing both underground and overhead lines, when the managed charging of EVs is used to mitigate the intermittency of PV generation export.

#### 6.3.1 UKGDS 95 Node Urban Network Model

An 11kV distribution network model was developed (see Figure 35 below) based upon the UKGDS which was chosen to demonstrate the robustness and the effectiveness of the MODERNE network planning tool. This network was designed to be representative of a typical GB distribution network as it contains urban feeders, rings, overhead lines and both domestic and large scale generation, with load profiles to be applied to each node.

The network consists of a 33/11kV primary substation which connects the 11kV network to the EHV network (which will be treated as a grid infeed) and the imported energy will be modelled as a generation unit supplying the 11kV network, which is only limited by the rating of the two 12/24MVA (OFAF) transformers at the 33/11kV primary substation. Two HV feeders are connected to the 11kV outlets at the primary substation busbars and these are used to import and export power throughout the 11kV network. The network consists of 95 buses and 97 circuits all at 11kV (see Appendix 4 for circuit impedance data). Demand data was obtained from the UKGDS [6.2] as were the technical parameters of the lines and cables.

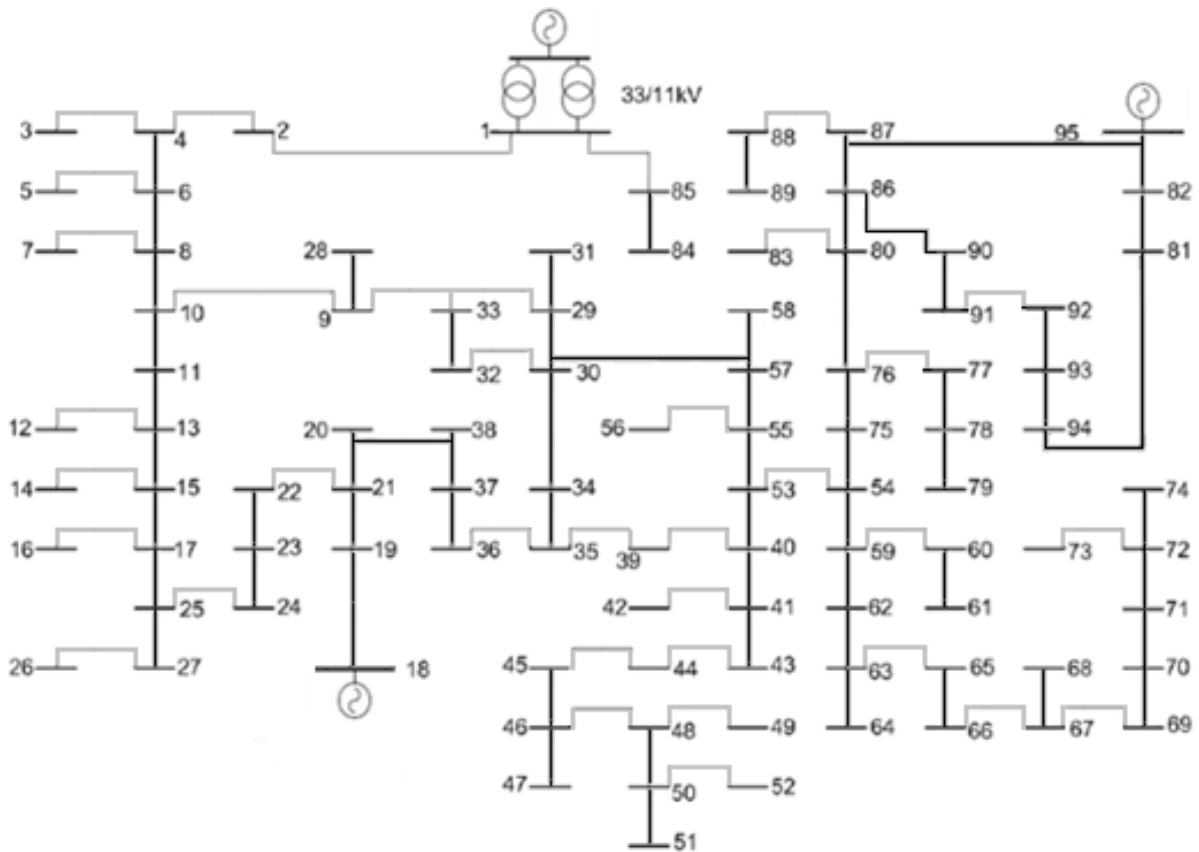

Figure 35: 11kV 95 Node Distribution Network

Each HV/LV node in the 11kV network is assumed to be either an 11/0.4kV GM transformer rated at 1MVA or 0.5MVA or an 11/0.4kV PM transformer rated at 0.315MVA. Each GM transformer in the network could typically supply on average 200/125 domestic customers, while a PM transformer could typically supply on average 100 domestic customers. The same demand profiles were used as in Case Study 1.

Based upon concurrent peak demands, with no contribution from installed generation, the peak at the 33/11kV primary substation was calculated to be 10.75MVA and the firm capacity of the primary substation is 24MVA (without utilising emergency ratings). Based upon this, there is 13.25MVA of total headroom available to accommodate the additional EV load, assuming no contribution from the installed generation. However, the capacity for an additional EV load at each HV/LV node is dependent upon the time of the EV charging routine and the daily load profile at the 11/0.4kV transformer.

The network model used for the case study has 95 HV/LV nodes with each having a load assigned to it, based upon customer numbers as stated above. Peak demands and daily demand profiles have been obtained, which are appropriate to be used for worst case scenario planning and these were

based upon UKGDS demand data and further adapted for use in this work [6.2]; see Appendix 5 for load data which was used in Case Study 2. A diversity factor would typically be applied to each peak to enable the increased utilisation of the distribution network; however, as has been stated previously, it will be assumed for worst case scenario planning, that each peak will be concurrent, so no diversity scaling will be applied.

The UKGDS demand data was modified and load profiles were created and scaled based upon the peak at each node, the aggregation of the 4 UKGDS customer types and the load profiles were assigned to each node. EV batteries are modelled as constant power loads (demands) with unity power factors, however the power factor at each HV/LV node is assumed to be 0.95, which is the standard target power factor in GB distribution networks. The demand at each HV/LV node is not sufficiently large that varying this power factor would not have significant impact.

Within the simulated network, there are 2 PV farms (modelled as generators) with an installed capacity of 6MWp each; see Appendix 6 for representative generation data for each of the PV farms. The export from each generation site, at each half-hour is dependent upon the time of day and is based upon historical DNO data and this data was reproduced in a format which was suitable to be used within the MODERNE network planning tool. In addition to the two large PV farms, there is small-scale domestic PV generation at each HV node and this is modelled as an aggregation of all the generation export at each half-hour. It was found that the most efficient way to incorporate this within the data that underpin the models was to reduce the demand profile at each node by the magnitude of the PV generation, though only at each half-hourly period where solar irradiance was producing energy.

It is assumed that each domestic PV system will be sized at 4kWp (kilowatt-peak) which is broadly equivalent to 4kWh, which is the size of a standard domestic installation. The export from each PV installation ramps up to peak output quickly and this continues (on a typical July day) for 16 hours, with a capacity factor of 10% (over the year) is used to calculate output. It is further assumed that 25% of domestic dwellings per node each have a 4kWp PV installation which is equivalent to a total of 750 domestic installations. In this work it is noted that a capacity factor is typically applied to PV export and in GB, a representative figure of 10% is used, which is broadly equivalent to that which would be observed in practice [6.6].

The capacity factor represents the ratio of actual energy produced and the energy that would be produced if the system was export energy at constant rated power [6.7]. The installed PV at each domestic dwelling was assumed to produce 1MWh/year of energy [6.8] which can either be used to fulfil the electrical demand at that dwelling or be exported to the distribution network when there is a surplus of generation export that is not required to meet demand at the CPOC where the generation is sited. PV export data for the month of July is used, as this represents peak output in GB. PV installations typically export for 16 hours a day (in July) and as there would be little value in carrying out analyses based upon winter output, July data is used in this work.

Unmanaged EV charging introduces the potential for capacity issues at distribution substations; the firm capacity of the GM transformers at each node in the network is either 1MVA or 0.5MVA and the PM transformers are rated at 0.315MVA [6.9]. The challenge to the Network Planner is to increase the utilisation of the network assets at each node by increasing the penetration of EVs (within limits) and in doing so minimising the line losses and the grid dependency whilst maximising the exported energy. In addition to maximising the penetration of EVs (without breaching network constraints), the responsive charging of EVs can increase the utilisation of intermittent renewable generation export at times of low base load.

In the case study presented in this section, the number and configuration of EVs to be sited at each HV node, based upon the demand and generation profiles and to meet the stated multi-objectives is given. The optimal EV battery size, charger power output and the operational envelope; the time periods that the charging routines should take place in to ensure that the penetration of EVs and the exported energy are maximised whilst the line losses and the grid dependency are minimised; however, the overload probability is limited to not be greater than 2%.

### 6.3.2 Objectives, Constraints and Model Inputs

This case study is defined by the following chosen objectives:

- Minimise line losses;
- Maximise exported energy; and
- Minimise grid dependency.

These objectives were chosen as they represent real world planning objectives of interest to multiple stakeholders and this will ensure that the output of the planning tool remains realistic and of value when implemented. The aim here is to ascertain the optimal benefit from the installed DG within the network and to reduce the costs associated with distribution line losses which are passed on to consumers. In this study, the penetration of EVs in the network would be limited to 15% which

corresponds to 450 EVs. A 15% penetration of EVs is reasonable as in the short to medium term; the penetration of EVs is not expected to be greater than this. The MODERNE framework is utilised to obtain the optimal number of EVs to be sited at each node without breaching network constraints.

The SPEA2 parameters in this case study are shown in Table 9 below and have not changed from Case Study 1.

**Table 9: SPEA2 Input Parameters for Case Study 2**

Total Size	50
Archive Size	50
Crossover Probability	0.8
Mutation Probability	0.01
Minimum Number of Generations	50
Maximum Number of Generations	50
Overload Probability	0.02

Assigning a non-zero positive value to the overload probability enables solutions to be observed which are out with the bounds of the real world planning horizon, as this could influence asset investment decisions where reinforcement could add significant value to the solution set.

### 6.3.3 EV Types and Charging Routines to be used with Case Study 2

In advance of utilising the MODERNE framework to obtain the optimal EV configurations at each node in the network with respect to the chosen multi-objectives, work was carried out by the author to create the four EV types (see Table 10 below) to be used; where the DVs were chosen (using the techniques as described in Section 6.1.1) to be both realistic and sufficiently varied to ensure that the results could be applied to inform investment planning and operational decision making. As stated previously, upper and lower constraints are placed upon the EV battery size (14kWh - 35kWh) and the charger power (3kW - 7kW)

**Table 10: EV Types and Charging Routines for Case Study 2**

EV Type	Battery Size (kWh)	Charger Power Output (kW)	Charging Routine Length (hours)	Charging Routine Start Time
1	35	3.74	9.35	0830
2	30	6.81	4.40	1100
3	27	4.05	6.66	0930
4	24	5.04	4.76	1130

In addition to the EV types which are required when solutions are decoded, 4 EV charging routines were also identified and assigned to an EV type based upon the charging routine length, the daily demand profiles and the availability of generation export. Together, the EV types and charging routines (with the network topology, adapted demand and generation profiles) were combined and applied to MODERNE, where the framework will be used to assign the EV types and charging routines to each node to meet the stated multi-objectives.

#### 6.3.4 MODERNE Output and Results

The results, when the framework is applied to the rural network are graphically presented below in Figures 36 to Figure 41. The output being displayed in this way enables the solutions and the Pareto Front to be presented and also easily interpreted.

The four EV types are optimised and then a number of EVs of each type are assigned to nodes in the network to meet the multi-objectives stated above, whilst ensuring the overload probability is not greater than 2% and the constraints - transformer ratings, EV battery size and charger power output - are not breached. The maximisation of exported energy has been chosen to ensure the optimal financial benefit of the installed generation in the network will be realised. When grid dependency is minimised, solutions will show that the 11kV network becomes more self-sufficient and less reliant on imports from the 33kV network at the time of peak demand and this objective should dovetail with the minimisation of line losses as there is less requirement for energy to flow through the 11kV network and through the 33kV connection point.

Figures 36 to Figure 41 present the solutions for the multi-objective optimisation problem, showing overload probability against line losses, overload probability against exported energy, overload probability against grid dependency, line losses against exported energy, line losses against grid dependency and exported energy against grid dependency.

#### 6.3.5 Discussion and Results

When the MODERNE framework was applied to the meshed 11kV urban network (based upon UKGDS data), the Pareto Front shows that in every optimisation scenario, the thermal overload probability is zero; see Figures 36 to Figure 38 below. As there is interconnection to the 33kV distribution system, the modelled network is automatically balanced and any solutions which produced overloads in the network were discarded from the archive in advance of the stopping criteria being met.



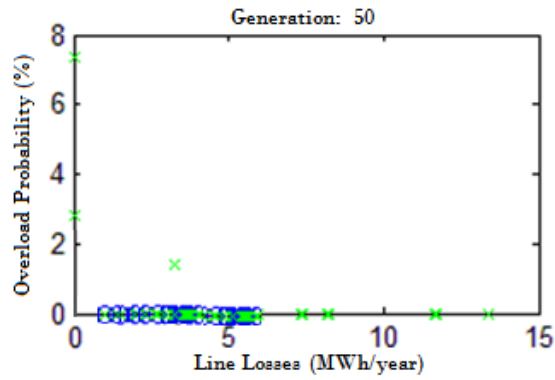

Figure 36: Overload Probability against Line Losses

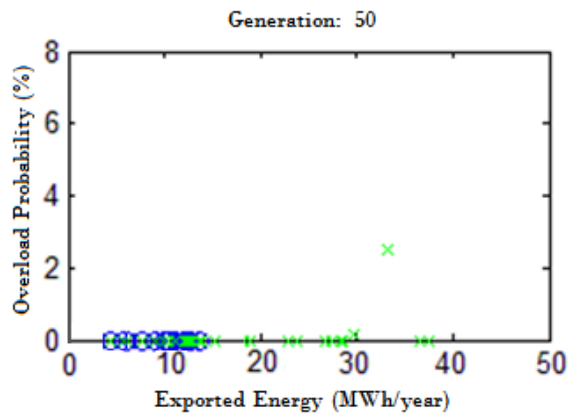

Figure 37: Overload Probability against Exported Energy

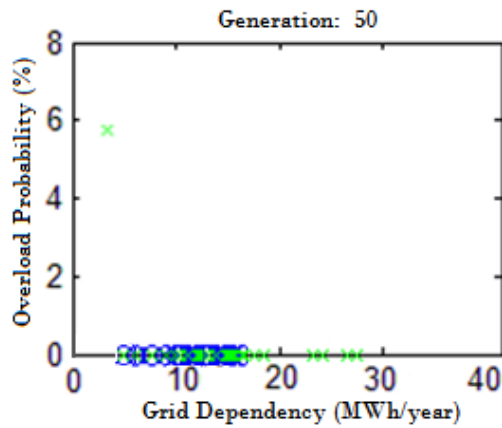

Figure 38: Overload Probability against Grid Dependency

Figure 39 shows line losses against exported energy and it is clear that when the aim is to maximise the export of energy to the 33kV network, then the line losses (copper losses) will increase as there is a higher flow of energy in the network (both to the 11kV network at times of need and from the 11kV network at times of high PV availability and low base load). However, if the aim is to reduce

line losses, which will be desirable for the DNO, then the energy exported - and the accompanying revenue stream - from the 11kV network will be minimised as a consequence of this.

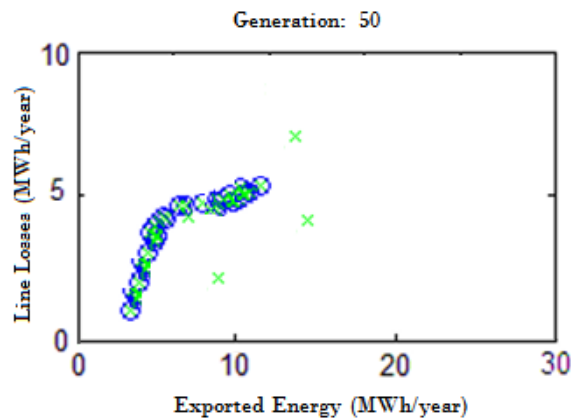

Figure 39: Line Losses against Exported Energy

Figure 40 shows that as grid dependency decreases, there is an observed reduction in the line losses observed within the network annually. As DNOs are transitioning to the DSO model, increasing the energy generated within the 11kV distribution system is desirable, and this energy will be used locally and not exported to the 33kV network. Therefore, the installed generation is being efficiently utilised to meet the additional EV demand that is now sited within the 11kV network and further, there are significantly reduced line losses as there is a lower requirement to import energy from the 33kV network or to transport energy through the 11kV circuits.

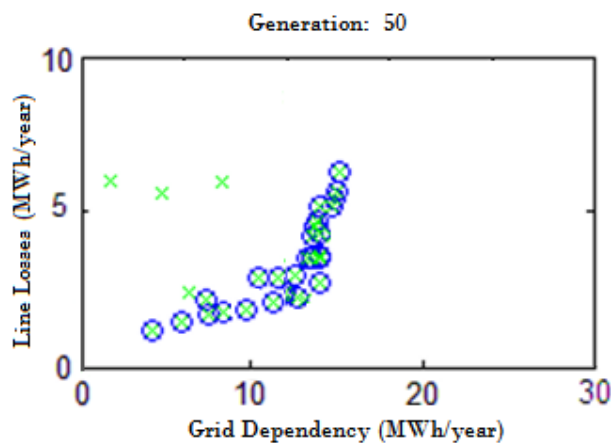

Figure 40: Line Losses against Grid Dependency

Figure 41 shows that as the exported energy to the 33kV network decreases, and then the grid dependency is also reduced as the PV output will be used within the 11kV network to meet the additional demand from EV charging. Prior to this additional demand from EVs, there would not be the requirement for PV output to be used within the 11kV network and this would have been exported to the 33kV network during times of low base load with associated line losses and degradation of distribution assets.

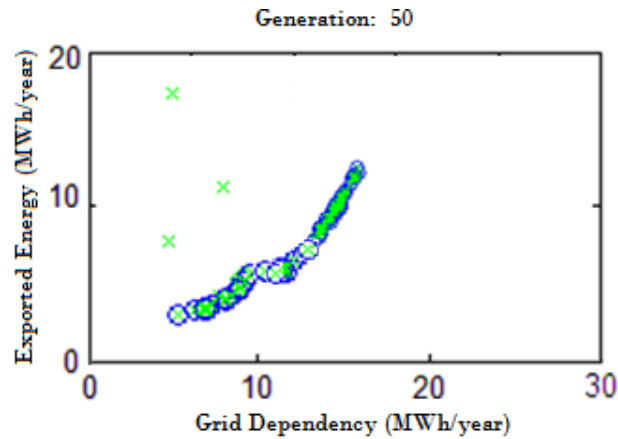

Figure 41: Exported Energy against Grid Dependency

However, as MODERNE can incorporate multiple (and conflicting) stakeholder viewpoints, when it is desirable that the exported energy (to the 33kV network) is maximised to ensure an increased revenue for the PV owner, then the Network Planner is required to compromise the requirement to increase the exported energy with the trade-off that the line losses and grid dependency will also increase concurrently. This trade-off and the decisions to be made will be explored in the next section.

### 6.3.6 Trade Offs and Compromises

When the Network Planner has to choose which solution from the Pareto Front best meets the objectives under consideration, a decision must be made with the solution to be implemented being chosen from the Pareto Front. Essentially the choice becomes, what objectives are qualitatively less important and what level of detriment in those objectives is acceptable to the decision maker when MCDM and post-hoc analyses are carried out. Table 11 presents the results for each objective and the detail for each of the three solutions at either end of the Pareto Front (and a mid-point value).

Table 11: Solution Data for Case Study 2

Planning Objective	Solution		
	A	B	C
Line Losses (MWh/year)	0.78	3.17	6.31
Exported Energy (MWh/year)	3.03	7.14	12.76
Grid Dependency (MWh/year)	4.81	11.01	17.38
Overload Probability (%)	0.00	0.00	0.00

It is this process of comparing trade-offs and the following decision making that is undertaken which fully utilises the output from MODERNE and the graphically displayed Pareto Front. Figures 42 to Figure 47 present the solutions with two extreme values from either side of the Pareto Front chosen and a mid-point solution used to illustrate the range of options available to the decision maker.

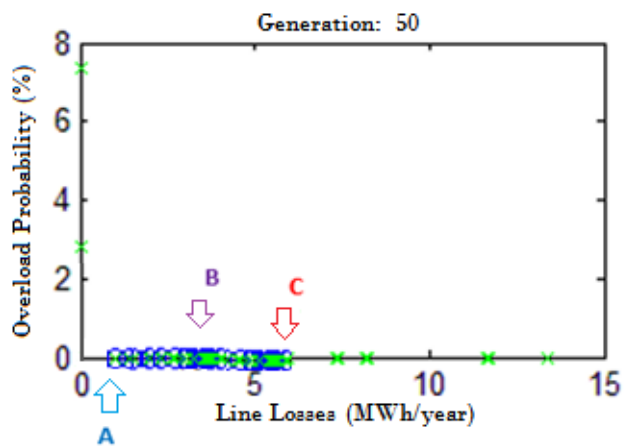

Figure 42: Overload Probability against Line Losses

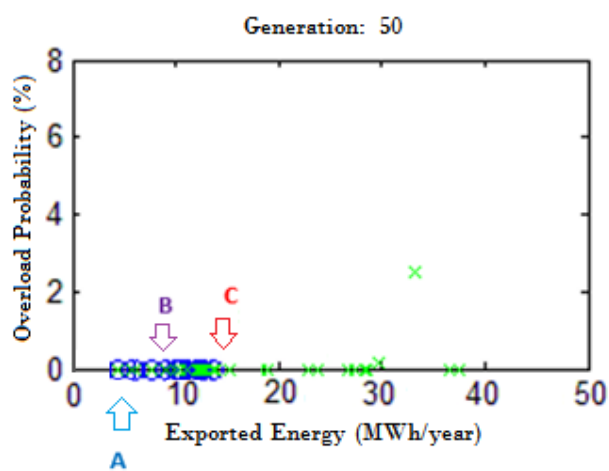

Figure 43: Overload Probability against Exported Energy

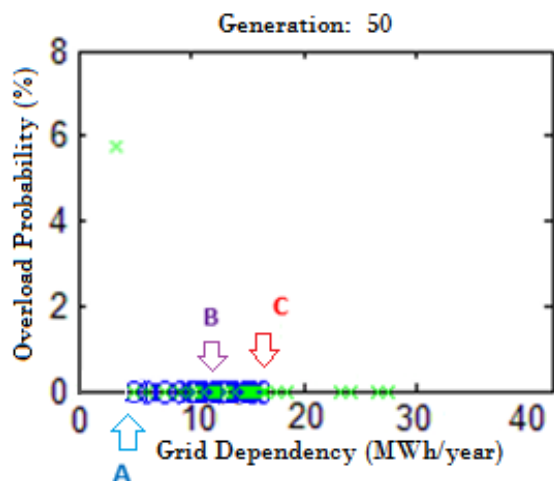

Figure 44: Overload Probability against Grid Dependency

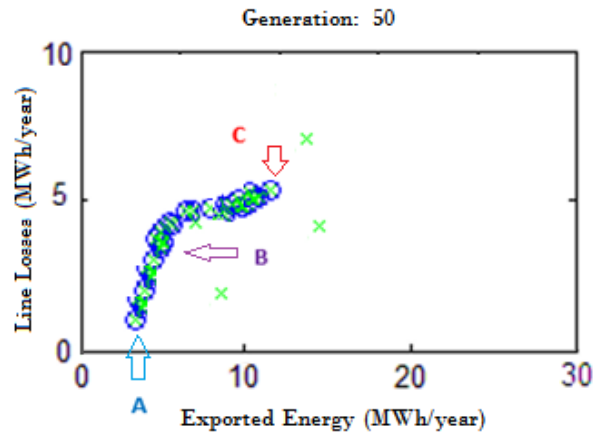

Figure 45: Line Losses against Exported Energy

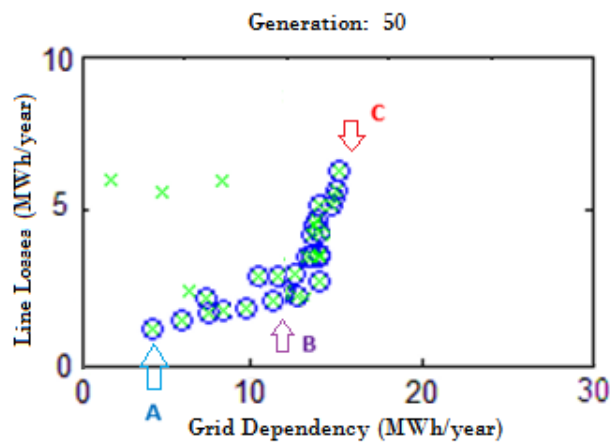

Figure 46: Line Losses against Grid Dependency

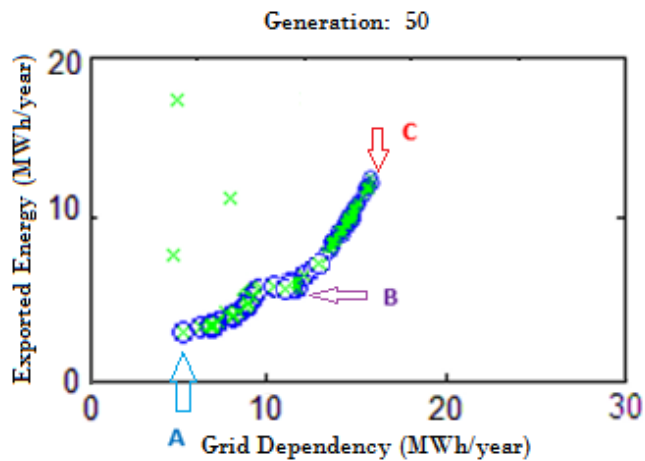

Figure 47: Exported Energy against Grid Dependency

Solutions A, B and C are graphically represented in Figures 42 to Figure 47 and the three solutions correspond to the values contained within Table 11. As the solutions were chosen from the extremities of the Pareto Front for each planning objective, it can be seen that the specifics of each

solution for each objective are different; with the exception of the overload probability which has a value of zero for all scenarios. The values in Table 11 were obtained for all three solutions for the planning objectives studied, and based upon a target penetration of 450 EVs to be incorporated within the modelled network. The results show that the solutions obtained are varied and encompass the entirety of the Pareto Front. For line losses, the solutions range from 0.78 to 6.31MWh/year, for exported energy the range is from 3.03 to 12.76MWh/year and the grid dependency ranges from 4.81 to 17.38MWh/year.

The data contained within Table 11, coupled with output from MODERNE is used to show the compromises that the Network Planner must make when conflicting objectives impact on the choice of solution to be implemented. If maximising the exported energy was desired (which would increase the revenue for each householder with a PV installation), then the trade-off is that the line losses and grid dependency would also increase, neither of which is desirable. The DNO would be required to decide if the revenue to be realised from export was greater than the cost of grid dependency and the associated imports. If this was the case, solution C would give an exported energy value of 12.76MWh/year, however the environmental impacts of the increase in line losses (6.31MWh/year) and grid dependency (17.38MWh/year) would have to be assessed also.

Conversely, if the minimisation of the line losses was the primary planning objective, solution A returned a value of 0.78MWh/year which is the lowest value observed. The trade-off in this scenario is that the exported energy (to the 33kV network) is only 3.03MWh. If the Network Planner wished to choose a solution where the objectives were all equally “good”, then solution B does not return any extreme values but all objectives were acceptable and the multiple stakeholder viewpoints would all be satisfied, but no planning objective would be optimal.

The numerical results for solutions A, B and C are displayed in Tables 12 to Table 14 below, where the number, type and location of the EVs in the network are detailed. When evaluated concurrently, the data relating to the chosen solution from Table 11 with the graphical output from MODERNE, Figures 42 to Figure 47, can be utilised to assist the Network Planner in deciding which of the solutions are to be implemented (regarding the specifics of the number of EVs of each type to be sited at a specific node) to mitigate the intermittency of PV output.

**Table 12: Solution A - Case Study 2**

Solution A		
Node	EV Type	Number of EVs
3	2	6
5	3	14
6	1	27
9	4	21
12	2	29
18	1	55
19	4	11
22	3	27
24	4	1
27	4	15
31	1	5
35	4	10
39	1	12
42	3	23
45	3	17
54	4	10
55	1	18
59	1	17
62	2	25
67	1	8
71	2	18
77	4	7
82	1	9
83	3	20
95	1	45

**Table 13: Solution B - Case Study 2**

Solution B		
Node	EV Type	Number of EVs
4	1	6
6	2	5
9	4	21
11	1	17
18	3	37
19	1	11
22	3	23
24	4	17

Solution B		
Node	EV Type	Number of EVs
27	2	15
31	4	8
33	1	13
42	3	24
45	1	41
51	1	21
53	4	17
55	2	10
60	1	16
64	3	14
71	1	13
74	3	4
79	2	15
81	2	18
82	4	7
83	1	9
91	3	20
95	1	48

**Table 14: Solution C - Case Study 2**

Solution C		
Node	EV Type	Number of EVs
4	1	6
7	2	5
10	4	21
11	2	17
18	3	31
19	1	4
22	3	21
24	4	5
27	3	1
31	1	4
32	1	10
35	4	8
37	2	17
41	1	8
42	3	9
44	1	12
48	3	21



Solution C		
Node	EV Type	Number of EVs
49	2	12
51	2	11
52	3	13
55	1	24
61	2	38
63	3	23
72	1	13
75	3	14
78	4	15
80	3	18
82	1	7
85	1	9
90	4	20
95	2	34

### 6.3.7 Case Study 2 - Conclusions

The aim of this case study was to optimise the integration of multiple EVs in an urban 11kV network whilst using managed charging schedules to mitigate the intermittency of both domestic and large scale PV. The three planning objectives chosen were to minimise the line losses and grid dependency whilst maximising the exported energy and being bound by technical constraints such as the rating of the circuits and transformers, the specifics of each EV type and the overload probability was limited to not be greater than 2%.

The findings from Case Study 2 are:

- The network is self-balancing and no solutions were obtained where there is a greater than 0% probability of thermal overloads. It is noted that the parameters used in the initial set up of the study ensured that solutions which were obtained where there was a reasonable likelihood of thermal overloads were discarded and not used to populate the archive;
- To maximise the exported energy will result in the line losses also increasing (which is not desirable) as the energy generated within the network will not be used locally. As a result, the magnitude of the copper losses will increase as more power is required to be transported to the higher voltage levels. With the increase in the installed capacity of DG in GB, especially at HV & LV, when the desire is to maximise the exported energy, network reinforcements such as cable & transformer replacement schemes will be required. The

need for these schemes (and the benefit) will have to be demonstrated and then these schemes need to be authorised by Ofgem before the DNO is permitted to pass these costs onto the consumer;

- To minimise the energy emissions factor and the grid dependency will result in the financial benefit to the PV owner also being minimised as the value obtained for exported energy at this point is also an observed minima. As PV penetration increases, the mass deployment of domestic battery storage in domestic properties can be utilised to realise the benefit of PV. Specifically, the installation of domestic batteries, when charged at times of low base load when there is no requirement (due to a low penetration of EVs) for the export from PV to be used to meet domestic/EV demand will ensure the energy emissions factor, the grid dependency and the exported energy will remain de-minimis with no increase in losses.

## **6.4 Summary**

This chapter detailed the case studies that were used to evidence the efficacy of the planning framework and also presented results that show the benefits to multiple stakeholders that the managed charging of multiple EVs can deliver. Results were displayed for both simulated networks which show the variances in the Pareto Front which were produced. The importance of analysing the entirety of the Pareto Front to ensure that the compromises which must be made when choosing a planning objective are fully understood was also formalised.

Tables 5 and 11 display the results for three solutions from the Pareto Front for each case study and it was made clear previously that when choosing any solution from the extremity of the Pareto Front caution must be taken. The reason for this is that whilst choosing an extreme solution will optimise the benefit in one planning objective, there will be a significant detriment in at least one other planning objective. Therefore, to ensure all stakeholders viewpoints and planning objectives are addressed; there will be value in choosing a solution from the Pareto Front that does not contain any extreme values.

The main difference in the case studies was the one study was underpinned by a rural network which contained a number of windfarms and was comprised mainly of overhead lines and the second study was underpinned by an urban network with PV generation (both large scale at two distinct nodes and domestic G83/G98 PV at each node in the model) and this network is comprised mainly of underground cables.

## 6.5 References for Chapter 6

- [6.1] C. Foote, P. Djapic, G. Ault, J. Mutale, G. Burt G. Strbac. “*United Kingdom Generic Distribution System Phase One Final Report*”, 2005.  
<https://github.com/sedg/ukgds>  
Accessed 05 June 2018
- [6.2] C. Foote, P. Djapic, G. Ault, J. Mutale, G. Burt G. Strbac. “*United Kingdom Generic Distribution System*”, 2010.  
<https://github.com/sedg/ukgds>  
Accessed 05 June 2018
- [6.3] Customer-Led Network Revolution (CLNR), “*A guide to the load & generation profile datasets*”, 2014  
<http://www.networkrevolution.co.uk/wp-content/uploads/2014/08/CLNR-L071-Guide-to-load-and-generation-profile-datasets.pdf>  
Accessed 15 January 2019
- [6.4] Energy Networks Association “*Connection of Generation < 3.68kW*”, 2018  
<http://www.energynetworks.org/electricity/engineering/distributed-generation/engineering-recommendation-g83.html>  
Accessed 25 January 2019
- [6.5] EA Technology “*Summary Report My Electric Avenue*”, 2016  
<http://myelectricavenue.info/sites/default/files/Summary%20report.pdf>  
Accessed 11 January 2019
- [6.6] Customer-Led Network Revolution (CLNR), “*A guide to the load & generation profile datasets Technical Note: Solar Photovoltaic (PV) Installations*”, 2013,  
[http://www.networkrevolution.co.uk/wp-content/uploads/2015/02/CLNR\\_L095-Solar-PV-Installations-Technical-Note.pdf](http://www.networkrevolution.co.uk/wp-content/uploads/2015/02/CLNR_L095-Solar-PV-Installations-Technical-Note.pdf)  
Accessed 23 December 2018
- [6.7] M. Campbell, J. Blunden, E. Smeloff. “*Minimizing utility-scale PV power plant LCOE through the use of high capacity factor configurations*”, 34th IEEE Photovoltaic Specialists Conference (PVSC), 7-12 June 2009
- [6.8] Customer-Led Network Revolution (CLNR), “*Insight Report: Domestic Solar PV Customers*” 2013, <http://www.networkrevolution.co.uk/wp-content/uploads/2015/01/CLNR-L090-Insight-Report-Domestic-Solar-PV.pdf>  
Accessed 27 December 2018
- [6.9] Regen “*Harnessing\_the\_electric\_vehicle\_revolution*”, 2018

[https://www.regen.co.uk/wp-content/uploads/Harnessing\\_the\\_electric\\_vehicle\\_revolution\\_-\\_Regen\\_market\\_insight\\_series\\_FINAL\\_2\\_pages.pdf](https://www.regen.co.uk/wp-content/uploads/Harnessing_the_electric_vehicle_revolution_-_Regen_market_insight_series_FINAL_2_pages.pdf)

Accessed 21 December 2018

## Chapter 7 - Conclusions and Further Work

This chapter details the objectives that were met during this research and also the further work that has been identified that could add value to the EV operation and integration problem to a DNO to plan and operate a network in real time.

### 7.1 Objectives

When this research commenced, the high-level objectives were:

- **Objective 1:** To gain a full understanding of multi-objective optimisation;
- **Objective 2:** To demonstrate the benefits when EV charging is managed and used to mitigate the intermittency of renewable generation;
- **Objective 3:** To develop a network planning tool which could be used to approach the EV operation and integration problem; and
- **Objective 4:** To generate results which demonstrate the ability of the framework to approach the EV operation and integration problem.

The literature review presented in Chapter 2 and the study of optimisation methods which was undertaken and then detailed in Chapter 3 was sufficient to ensure that Objective 1 was met. The value to this work was that a full understanding of MOEA and GAs was gained, and the strengths of SPEA2 and the justifications for this method to be used to approach the EV integration and operation problem were formalised. Finally, the current techniques for optimal EV integration, network planning, ANM and multi-objective planning were critically reviewed to identify the value that this research would add to the existing knowledge base for network planning.

When the EV planning horizon was mathematically formulated and the case studies were carried out (Chapters 4 and 6), together these demonstrated the benefits to multiple stakeholders which could be realised when the presented multi-objective network planning tool was used to optimise EV charging schedules to mitigate the intermittency of renewable generation; taken together this ensured that Objective 2 was fulfilled.

Objective 3 was to develop a network planning tool which could be used to approach the EV operation and integration problem successfully. When the work in Chapter 4 and Chapter 5 are considered concurrently, it was evidenced that the planning framework, when applied to diverse case studies (rural/urban) then identified the optimal arrangement of EVs in simulated distribution networks. In addition to the design and development of the planning tool, the work which was

detailed within Chapter 4 included a load model of an EV battery which had been developed. When combined with the work undertaken in Chapter 5 where the MODERNE framework was introduced and the specific exhaustive network planning objectives were formalised, together this was sufficient to ensure Objective 3 was fulfilled.

Finally, the output from the case studies presented in Chapter 6, both graphically and in a tabular form, is sufficient to meet the requirements of Objective 4 which was to generate results where the value of the planning framework, when used to approach the EV operation and integration problem, was demonstrated. It was clear from the results produced that the network planning framework could be used to smartly schedule EV charging periods to mitigate the intermittency of renewable generation for high penetrations of EVs, without the requirement for costly network reinforcements and where there were no safety issues which had occurred, such as assets being operated outwith their ratings or times where load customers were being curtailed to reduce peak demand.

## **7.2 Final Conclusions**

In this thesis, the presented network planning tool, which was based upon multi-objective optimisation, was developed to optimise the inclusion of multiple EVs in distribution networks to mitigate the intermittency of DG. The planning tool would optimise the EV type, where each EV type comprised of the EV battery size and charger power, and the number, location and operational envelope which should be applied to EV charging to mitigate the intermittency of renewable generation, within an 11kV network, without the requirement for any additional costs (of reinforcement) to be borne by the consumer.

When the planning framework was applied to two simulated 11kV networks (both rural and urban), case studies were produced. It was shown in the output from the case studies, that a significant increase in the penetration of EVs can be incorporated within distribution networks without the need for network reinforcements, assuming that the charging of the EVs was smartly scheduled to correspond with times of low load and high renewable availability. In a regulated utility such as a DNO, any network reinforcements have to be well planned and the need for reinforcements have to be demonstrated and the benefits should be clear. However, only if EV charging is smartly scheduled was it shown that consumers will benefit from a reduction in DUoS (by deferred investment costs) and generation owners will observe an increase in revenue (as a result of the increase in the utilisation of DG at times of low load where DG would otherwise be constrained under ANM schemes). Despite the increase in demand due to the penetration of EVs, there will be

no requirement to invest in new network assets which would be required for a only a small number of half-hours each year, as the scheduled EV charging will avoid existing times of peak demand.

In addition to being used to integrate multiple EVs in 11kV networks without the requirement for network reinforcements, it was shown in the case studies that the network planning tool could be used to mitigate the intermittency of renewable generation at times of low base load (by increasing demand - from EV charging - at these times) and this will therefore increase the financial benefit to the generation owner (by increasing the utilisation of the installed generation).

When planning and operating a network in real time, a DNO control room could (with appropriate control and communications techniques), in a similar way to ANM constraint schemes which are implemented and applied at times of high generation and low(er) base load, utilise in real time the network planning framework to ensure that EV charging at times of local network peaks are avoided and the installed DG is then used to meet the demand from multiple EVs at times of low load rather than being “curtailed off”.

The use of the planning framework would assist in the avoidance of overloads on distribution assets; this would have positive safety implications, alternatively, non-firm demand customers would be required to be curtailed to ensure the distribution system stayed within limits. There are clear safety, societal and financial benefits to be realised, which will add value for multiple stakeholders. When the presented planning framework is used to optimise EV charging routines to mitigate the intermittency of renewable generation, it has been demonstrated that a reduction in network overloads is possible, as is the increased uptake of renewable generation at times of low load, which has environment and societal benefits. However, as DNOs are unable to influence (in the short term) the location and power output of EV chargers and battery size, and without knowledge of the EV battery SOC and accurate forecasting of wind & PV, it is clear that there are constraints to achieving these benefits in reality.

In the longer term, the use of the GA based planning framework when applied as “business-as-usual”, for large penetrations of EVs in areas of the network where capacity for new demand connections is low (or zero) will be valuable to schedule EV charging. This has the potential to reduce peak load (which will defer network investment) and could assist in DNOs being able to offer new demand connections as opposed to asset reinforcement being required in advance of any new load being added to the local network.

This will reduce the requirement for significant network reinforcements and this will mean that investment can be targeted to other areas of the network where the use of the EV planning framework is not appropriate due to a low penetration of EVs.

### **7.3 Further Work**

This work has not examined or quantified the control mechanisms (such as EV Smart Chargers) and the significant new communication infrastructure that would be required to implement a scheme where the charger power and the charging routine could be remotely controlled by the DNO (or the DSO). However, it is understood that the technical specifications of the next generation of EV Smart Chargers will require the capability to interact with SMETS2 Smart Meters and this functionality can be “bolted-on” as required.

The value of the export from the 11kV network (to the EHV network) would have to be clearly defined (though this will vary dependent upon the exact location of DG and time of DG export). DNOs publish DUoS tariffs annually and these will indicate the typical export credit that could reasonably be expected to be realised per kWh exported. Further, the impact that time-of-use tariffs may have upon consumer behaviour and EV charging patterns was not investigated within this work. There may be greater financial benefit to the generation owner if larger domestic batteries (rather than EV batteries) are installed and used to store the energy generated from DG, this energy can then be sold to the grid at times of peak demand and therefore higher DUoS export tariffs. The cost of EV charging at off peak times may also be significantly lower than the value of the export (from the HV network) from the installed DG at times of system peak. The bi-directional flow of electricity from an EV battery to the local distribution network and the impacts were deemed out of scope, but are worthy of further study.

The network planning framework could be further developed to improve the speed of processing and an identified weakness is the time taken to evaluate solutions, which for a complex network and multiple objectives and 50 generations, can be in the order of many days. In previous simulations, it has typically taken at least 30 generations until the solution set started to form what would be recognised as a Pareto Front.

If, rather than using MATLAB, the planning framework was further adapted and the load flow was carried out external to the analysis and the planning objectives were evaluated in a bespoke software tool, there would be more value to the DNO and the tool could then be used for real-time planning and decision making. Obtaining the Pareto Front as the solution set by using a robust study



of at least 50 generations would be valuable for network planners and would inform asset investment strategies when time was not an issue, however, there would be limited value in carrying out exhaustive (>30 generations) studies for day to day operational planning and asset switching due to the length of time taken for the model to complete each study.

## **7.4 Final Summary**

This thesis has presented a network planning framework that was underpinned by principles of multi-objective optimisation, specifically SPEA2, a genetic algorithm. This planning framework was used to optimise the integration of multiple EVs into simulated (whilst realistic) distribution networks. During this work, a load model of an EV battery was developed and this was used with the planning framework and the simulated networks (and annual DG output profiles) to assess the impact of multiple EVs on distribution networks.

It was demonstrated, by the use of case studies, that the framework is an effective and flexible tool for both network planning and multiple EV integration. Results have shown that multiple EVs can be incorporated into HV networks without the requirement for network reinforcements, whilst also increasing the utilisation of the installed DG in the distribution network. The use of the planning framework has significant value to multiple stakeholders; there are both societal benefits to be observed when there is an increased uptake of renewable DG and there are financial benefits to both the consumer (through reduced reinforcement costs) and the generation owner (when generation is utilised to meet load rather than being curtailed when demand is low) when the planning framework is used to smartly schedule EV charging periods.

Finally, the planning framework can (through the multi-objective view taken) be tailored by the network planner to ensure that the requirements of multiple stakeholders can be addressed simultaneously, such that each objective is considered with respect to every other objective whilst incorporating those requirements which are of the most interest at that time; this view is also dynamic and can be adjusted in real time based upon the specific planning and operational requirements.

## UKGDS Network Data

These appendices present the network data which underpins the for both the UKGDS networks which were used in Case Study 1 & Case Study 2. These networks were derived from the UKGDS then modified and updated to ensure they were appropriate to be used in the EV integration problem at LV. These networks were applied to the MODERNE framework and then used to optimise the integration of EVs in both Case Study 1 and Case Study 2. All data shown is given on a 100MVA base.

Appendices 1 to Appendix 6 present the technical data which were used to underpin both case studies.

### Appendix 1 - Circuit Impedance ( $\Omega$ ) Data Case Study 1

From	To	R	X	From	To	R	X
0	1	0.2038	0.1056	38	39	0.0665	0.0512
1	2	0.2038	0.1056	39	40	0.0665	0.0512
2	3	0.0624	0.0171	40	41	0.0665	0.0512
0	4	0.0665	0.0512	41	42	0.0665	0.0512
4	5	0.0665	0.0512	42	43	0.0665	0.0512
5	6	0.0729	0.0198	43	44	0.0665	0.0512
0	7	0.2038	0.1056	44	45	0.0729	0.0198
7	8	0.2038	0.1056	38	46	0.0729	0.0198
8	9	0.0624	0.0171	40	47	0.0729	0.0198
0	10	0.0624	0.0171	41	48	0.0729	0.0198
10	11	0.2038	0.1056	43	49	0.0665	0.0512
11	12	0.2038	0.1056	45	50	0.0665	0.0512
11	13	0.2038	0.1056	0	51	0.0665	0.0512
12	14	0.0624	0.0171	51	52	0.0665	0.0512
0	15	0.0665	0.0512	52	53	0.0665	0.0512
15	16	0.0665	0.0512	53	54	0.0665	0.0512
16	17	0.0665	0.0512	54	55	0.0665	0.0512
17	18	0.0665	0.0512	55	56	0.0729	0.0198
18	19	0.0665	0.0512	56	57	0.0729	0.0198
19	20	0.0665	0.0512	57	58	0.0729	0.0198
20	21	0.0665	0.0512	58	59	0.0729	0.0198
16	22	0.0665	0.0512	59	60	0.0665	0.0512
18	23	0.0665	0.0512	60	61	0.0665	0.0512
19	24	0.0665	0.0512	61	62	0.0665	0.0512
21	25	0.0665	0.0512	62	63	0.0665	0.0512
0	26	0.0665	0.0512	63	64	0.0665	0.0512

From	To	R	X	From	To	R	X
26	27	0.0729	0.0198	64	65	0.0665	0.0512
27	28	0.0729	0.0198	65	66	0.0665	0.0512
28	29	0.0729	0.0198	52	67	0.0665	0.0512
29	30	0.0729	0.0198	54	68	0.0665	0.0512
30	31	0.0729	0.0198	55	69	0.0729	0.0198
31	32	0.0665	0.0512	57	70	0.0729	0.0198
27	33	0.0729	0.0198	59	71	0.0729	0.0198
29	34	0.0729	0.0198	61	72	0.0729	0.0198
30	35	0.0665	0.0512	62	73	0.0729	0.0198
32	36	0.0729	0.0198	64	74	0.0665	0.0512
0	37	0.0729	0.0198	66	75	0.0729	0.0198
37	38	0.0729	0.0198				

## Appendix 2 - Load Data Case Study 1

Node	Maximum Demand (MVA)	Transformer Rating (MVA)
1	0.403	1.000
2	0.402	1.000
3	0.387	1.000
4	0.187	0.315
5	0.196	0.315
6	0.177	0.315
7	0.403	1.000
8	0.402	1.000
9	0.401	1.000
10	0.401	1.000
11	0.387	1.000
12	0.382	1.000
13	0.375	1.000
14	0.368	1.000
15	0.187	0.315
16	0.210	0.315
17	0.203	0.315
18	0.181	0.315
19	0.156	0.315
20	0.146	0.315
21	0.197	0.315
22	0.187	0.315
23	0.210	0.315

<b>Node</b>	<b>Maximum Demand (MVA)</b>	<b>Transformer Rating (MVA)</b>
24	0.203	0.315
25	0.181	0.315
26	0.203	0.315
27	0.181	0.315
28	0.203	0.315
29	0.181	0.315
30	0.156	0.315
31	0.146	0.315
32	0.197	0.315
33	0.187	0.315
34	0.181	0.315
35	0.203	0.315
36	0.181	0.315
37	0.203	0.315
38	0.181	0.315
39	0.156	0.315
40	0.146	0.315
41	0.187	0.315
42	0.210	0.315
43	0.203	0.315
44	0.181	0.315
45	0.156	0.315
46	0.146	0.315
47	0.197	0.315
48	0.187	0.315
49	0.210	0.315
50	0.203	0.315
51	0.181	0.315
52	0.203	0.315
53	0.181	0.315
54	0.203	0.315
55	0.181	0.315
56	0.156	0.315
57	0.146	0.315
58	0.197	0.315
59	0.187	0.315
60	0.181	0.315
61	0.203	0.315
62	0.181	0.315

Node	Maximum Demand (MVA)	Transformer Rating (MVA)
63	0.181	0.315
64	0.203	0.315
65	0.181	0.315
66	0.203	0.315
67	0.181	0.315
68	0.156	0.315
69	0.146	0.315
70	0.197	0.315
71	0.187	0.315
72	0.181	0.315
73	0.203	0.315
74	0.181	0.315
75	0.182	0.315

### Appendix 3 - Generation Export Data Case Study 1

Period	Wind Export MWh
0	0.0150
0.5	0.1040
1	0.2400
1.5	0.2010
2	0.1324
2.5	0.1980
3	0.0570
3.5	0.1557
4	0.2101
4.5	0.1050
5	0.2200
5.5	0.2014
6	0.2200
6.5	0.2254
7	0.2420
7.5	0.3221
8	0.4981
8.5	0.4452
9	0.4757
9.5	0.4478
10	0.4470
10.5	0.3210

Period	Wind Export MWh
11	0.4410
11.5	0.4470
12	0.4221
12.5	0.3886
13	0.5480
13.5	0.5820
14	0.4450
14.5	0.4014
15	0.3288
15.5	0.5454
16	0.4010
16.5	0.5010
17	0.2001
17.5	0.1040
18	0.1141
18.5	0.1224
19	0.1224
19.5	0.1421
20	0.1874
20.5	0.1564
21	0.1602
21.5	0.1507
22	0.3188
22.5	0.2014
23	0.1020
23.5	0.0190

#### Appendix 4 - Circuit Impedance ( $\Omega$ ) Data Case Study 2

From	To	R	X	From	To	R	X
1	2	0.0590	0.0612	46	47	0.2856	0.1452
1	85	0.0664	0.0688	46	48	0.4283	0.2178
2	4	0.1180	0.4027	48	49	0.4283	0.2178
3	4	0.2096	0.0918	48	50	0.3354	0.1469
4	6	0.2541	0.2456	50	51	0.2583	0.1104
5	6	0.2934	0.1286	50	52	0.6458	0.2761
6	8	0.3129	0.2138	53	54	0.3650	0.2495
7	8	0.4192	0.1837	53	55	0.2515	0.1102
8	10	0.1565	0.1069	54	59	0.4419	0.1845
9	10	0.3570	0.1815	54	75	0.3129	0.2138

From	To	R	X	From	To	R	X
9	28	0.2515	0.1102	55	56	0.3354	0.1469
9	29	0.4283	0.2178	55	57	0.5030	0.2204
10	11	0.3650	0.2495	57	58	0.3354	0.1469
11	13	0.2347	0.1604	59	60	0.2096	0.0918
12	13	0.2096	0.0918	59	62	0.1767	0.0738
13	15	0.2868	0.1960	60	61	0.3773	0.1653
14	15	0.2515	0.1102	62	63	0.3093	0.1291
15	17	0.3129	0.2138	63	64	0.2515	0.1102
16	17	0.1677	0.0735	63	65	0.2209	0.0922
17	25	0.1565	0.1069	65	66	0.3535	0.1476
18	19	0.1452	0.1404	66	67	0.3093	0.1291
19	21	0.4356	0.4211	67	68	0.1138	0.0435
20	21	0.1592	0.0609	67	69	0.5302	0.2213
20	38	0.1180	0.4027	69	70	0.2651	0.1107
21	22	0.1089	0.1053	70	71	0.0910	0.0348
22	23	0.3650	0.2495	71	72	0.1767	0.0738
23	24	0.2347	0.1604	72	73	0.3535	0.1476
24	25	0.2608	0.1782	72	74	0.4860	0.2029
25	27	0.2086	0.1426	75	76	0.1565	0.1069
26	27	0.1304	0.0891	76	77	0.2209	0.0922
29	30	0.3354	0.1469	76	80	0.2608	0.1782
29	31	0.2934	0.1286	77	78	0.3535	0.1476
30	32	0.3129	0.2138	78	79	0.5302	0.2138
30	34	0.1349	0.0892	80	83	0.1565	0.1069
30	57	0.1180	0.4027	80	86	0.2347	0.1604
32	33	0.3773	0.1653	81	82	0.3297	0.0485
34	35	0.4188	0.2499	81	94	0.1825	0.1247
35	36	0.1889	0.1249	82	95	0.5934	0.0874
35	39	0.4172	0.2851	84	85	0.0470	0.1258
36	37	0.2698	0.1785	86	87	0.3354	0.1469
37	38	0.2583	0.1104	86	90	0.3129	0.2138
39	40	0.1565	0.1069	87	88	0.5869	0.2571
40	41	0.1428	0.0726	87	95	0.1180	0.4027
40	53	0.2086	0.1426	88	89	0.2737	0.0567
41	42	0.2515	0.1102	90	91	0.0782	0.0535
41	43	0.2856	0.1452	91	92	0.3297	0.0485
43	44	0.2142	0.1089	92	93	0.1978	0.0291
44	45	0.1138	0.0435	93	94	0.1043	0.0713
45	46	0.2142	0.1089				

## Appendix 5 - Load Data Case Study 2

Node	Maximum Demand (MVA)	Transformer Rating (MVA)
1	0.130	1.000
2	0.168	1.000
3	0.161	0.315
4	0.078	1.000
5	0.081	0.315
6	0.074	1.000
7	0.168	1.000
8	0.168	1.000
9	0.168	1.000
10	0.168	1.000
11	0.161	1.000
12	0.159	0.500
13	0.156	1.000
14	0.154	0.500
15	0.078	1.000
16	0.088	0.500
17	0.085	1.000
18	0.075	1.000
19	0.065	1.000
20	0.061	1.000
21	0.083	1.000
22	0.078	1.000
23	0.088	1.000
24	0.085	1.000
25	0.075	1.000
26	0.085	1.000
27	0.075	0.500
28	0.085	1.000
29	0.075	1.000
30	0.065	1.000
31	0.061	1.000
32	0.083	0.500
33	0.078	1.000
34	0.075	1.000
35	0.085	1.000
36	0.075	1.000
37	0.085	1.000



<b>Node</b>	<b>Maximum Demand (MVA)</b>	<b>Transformer Rating (MVA)</b>
38	0.075	1.000
39	0.065	1.000
40	0.061	1.000
41	0.078	1.000
42	0.088	1.000
43	0.085	1.000
44	0.075	1.000
45	0.065	1.000
46	0.061	1.000
47	0.083	1.000
48	0.078	1.000
49	0.088	1.000
50	0.085	1.000
51	0.075	1.000
52	0.085	1.000
53	0.075	1.000
54	0.085	1.000
55	0.075	1.000
56	0.065	1.000
57	0.061	1.000
58	0.083	1.000
59	0.078	1.000
60	0.075	1.000
61	0.085	1.000
62	0.075	1.000
63	0.075	1.000
64	0.085	1.000
65	0.075	1.000
66	0.085	1.000
67	0.075	1.000
68	0.065	1.000
69	0.061	0.500
70	0.083	0.500
71	0.078	0.500
72	0.091	0.500
73	0.099	1.000
74	0.108	0.500
75	0.116	1.000
76	0.125	1.000

<b>Node</b>	<b>Maximum Demand (MVA)</b>	<b>Transformer Rating (MVA)</b>
77	0.134	1.000
78	0.143	1.000
79	0.150	1.000
80	0.159	1.000
81	0.168	1.000
82	0.171	0.315
83	0.179	1.000
84	0.188	1.000
85	0.195	1.000
86	0.203	1.000
87	0.210	0.315
88	0.218	1.000
89	0.225	1.000
90	0.233	1.000
91	0.241	1.000
92	0.249	1.000
93	0.256	1.000
94	0.264	1.000
95	0.271	1.000

## **Appendix 6 - Generation Export Data Case Study 2**

<b>Period</b>	<b>PV Export kWp</b>
0	0.000
0.5	0.000
1	0.000
1.5	0.000
2	0.000
2.5	0.000
3	0.000
3.5	0.000
4	0.000
4.5	0.000
5	0.004
5.5	0.018
6	0.045
6.5	0.085
7	0.129
7.5	0.180

Period	PV Export kWp
8	0.228
8.5	0.279
9	0.345
9.5	0.379
10	0.407
10.5	0.421
11	0.410
11.5	0.433
12	0.501
12.5	0.484
13	0.540
13.5	0.467
14	0.533
14.5	0.536
15	0.474
15.5	0.471
16	0.456
16.5	0.423
17	0.341
17.5	0.291
18	0.241
18.5	0.182
19	0.119
19.5	0.063
20	0.023
20.5	0.005
21	0.000
21.5	0.000
22	0.000
22.5	0.000
23	0.000
23.5	0.000