



**Development of a diagnostic device  
to predict clinically significant  
inflammation associated with  
cardiac surgery**

**By**

**Mohammed Yahya Majrashi**

**Supervisor: Professor. Terry Gourlay**

**This thesis is submitted in accordance with the regulations governing the award  
of the Degree of Doctor of Philosophy in Biomedical Engineering**

## **Declaration**

This thesis is the result of the the author's original research. It has been composed by the author and has been previously submitted for examination which led to the award of a degree.

The copyright of this thesis belongs to the author under the terms of the United Kingdom Copyright Acts as qualified by University of Strathclyde Regulation 3.50.

Due acknowledgment must be made of the use of any material contained or derived from this thesis.

Signed

Date :



## **Acknowledgement**

I would like deeply to thank my hero supervisor Professor. Terry Gourlay for his advice, support and help throughout my PhD studies at the University of Strathclyde. His wealth experience and knowledge in the cardiovascular area guided me to produce this piece of work. Without his vision, the project could not have begun.

I would like also to express my grateful thanks to Dr. Craig Robertson and Dr. Monica for their support over my writing up stage. Your recommendations and advices helped me to improve the quality of this work.

Thanks to Dr. Baker from chemistry department for his help and support during FTIR work.

Thanks to Professor. Serdar Gunyidin and all colleagues at memorial hospital in Ankara, Turkey.

Thanks to my parents, my lovely wife and my children for their support and encouragements over my study.

Thanks to all my friends at biomedical engineering department for their support and encouragements.

I would like to acknowledge my sponsor (Saudi Food and Drug Authority) for their financial funding of my Doctorate study.

**Figure and table permissions:** where figures and tables have been included from other sources, permission has been obtained for their use and the original authors given due acknowledgment within the legend.

## **Abstract**

### **Background**

Cardiopulmonary bypass deployment is known to cause an inflammatory response during open heart surgery. Inflammation involves the activation of different cascades such as coagulation, the complement system and cytokines. Although the immune system is the body's key defense mechanism against external assault, it can be injurious to the patient when the immune system is over-expressed, particularly in cohort of patients that experience a heightened and uncontrolled response. This exaggerated response results in autoimmune injury and may lead to poor post-operative outcomes, such as systemic inflammatory response syndrome and multi-organ failure.

### **Aim of the work**

This project was aimed to develop a predictive screening technology that enables clinicians to specify patients who may be at risk prior to open heart surgery. This project suggests a new approach to identifying these patients, through the development of a novel technology that will measure the extent of the inflammatory response following blood contact with extracorporeal systems. This work focuses on cardiopulmonary bypass, but the technology may also extend to other treatments and interventional modalities in which tissues, in particular blood, comes into contact with foreign surfaces.

### **Approach**

A series of in-vitro studies on bovine blood were performed to investigate the role of two initiators of the inflammatory response (DEHP plasticised PVC and liquid DEHP itself) and the exaggeration of different pro-inflammatory cytokines levels. A

clinical study was then undertaken in open heart surgery patients to confirm the preliminary outcomes from the in vitro studies and to specify the most appropriate plasma marker that predict patients at-risk of developing SIRS (focusing on IL-6, TNF- $\alpha$  and C-reactive protein). The clinical study was aimed to outline the most appropriate initiator and measuring technique for cytokine concentration (ELISA versus Fourier Transform Infrared Spectroscopy (FTIR)) and we sought to establish a final design configuration of the proposed screening technology.

## **Results**

The in vitro studies showed that both DEHP plasticised PVC and liquid DEHP are effective initiators of the inflammatory response. This was verified by the clinical investigations, and the data suggested that IL-6 with DEHP plasticised PVC is the most sensitive diagnostic marker that can identify patients prior to open heart surgery who are at risk of developing SIRS. Both analysing techniques (ELISA and FTIR) were shown to be suitable for the intended device development. However, FTIR – with its reduced complexity and processing time - was considered to be the best analytical modality for future ongoing development of the intended POC screening device. A basic prototype for this screening device (an activation chamber, separation and wicking membrane and device schematics) was developed and future work is necessary to deliver the device to the clinic.

## **Thesis outline**

**In chapter 1**, Cardiopulmonary bypass system is explained in terms of the history, development and the essential integrated parts of the machine. In addition, a brief description about the pathophysiological issues with CPB was mentioned at the end of this chapter.

**In chapter 2**, we discussed the integration between the cardiopulmonary bypass and the inflammatory response over the surgery which leads to development of the systemic inflammatory response syndrome (SIRS). This syndrome was addressed in more detail including the onset of the syndrome, cellular and humoral pathway activation and the anti-inflammatory strategies used to attenuate the deleterious outcomes from SIRS.

**Chapter 3:** Hypothesis and the objectives of this work.

**Chapter 4:** Describing in-vitro methodology.

**Chapter 5:** Presenting the data from the series of in-vitro bovine studies. The results were expressed in terms of IL-6 and TNF- $\alpha$  levels.

**Chapter 6:** Describing the clinical study methodology.

**Chapter 7:** Clinical study data were presented in relation to the three tested molecules (IL-6, TNF- $\alpha$  and CRP). Further analysis was performed on the data to choose the most appropriate cytokine that can detect high risk patients prior to the surgery and specify the suited technology for measuring cytokine concentration (ELISA or FTIR) to be used in the device development stage.

**Chapter 8:** The proposed screening test technology was developed based on the significant outcomes from both laboratory and clinical studies.

**Chapter 9:** Discussion of the findings and the outcomes from laboratory, clinical studies and the device development stage.

**Chapter 10:** Overall conclusion and the future work recommendations.

## LIST OF FIGURES

<b>Figure 1:</b> Cross circulation technology.....	3
<b>Figure 2:</b> Gibbon’s heart lung machine.....	4
<b>Figure 3:</b> Cardiopulmonary bypass components .....	6
<b>Figure 4:</b> Smart Cannula. ....	8
<b>Figure 5:</b> Membrane oxygenators workflow.....	10
<b>Figure 6:</b> Cardinal signs of inflammation. ....	17
<b>Figure 7:</b> Schematic diagram of the sequences of events that lead to the development of systemic inflammatory response syndrome SIRS. ....	25
<b>Figure 8:</b> Inflammatory and oxidative stress during CPB.....	27
<b>Figure 9:</b> Adhesion molecules phases.....	29
<b>Figure 10:</b> Complement system pathways. ....	32
<b>Figure 11:</b> Primary and secondary haemostasis phases. ....	34
<b>Figure 12:</b> Coagulation pathways .....	35
<b>Figure 13:</b> Contact system activation cycle. ....	36
<b>Figure 14:</b> Anti-inflammatory strategies to attenuate inflammatory response to CPB. .....	47
<b>Figure 15:</b> Cantharidin induced blister.....	48
<b>Figure 16:</b> Drew-Anderson technique.....	49
<b>Figure 17:</b> Schematic of the miniaturized extracorporeal circuit (MECC) on the left and conventional extracorporeal circulation (CECC) on the right. ....	51
<b>Figure 18:</b> Medtronic Resting heart system .....	52
<b>Figure 19:</b> Minimally invasive incision. ....	59
<b>Figure 20:</b> Progression of SIRS.. ....	68
<b>Figure 21:</b> Balance between pro-inflammatory and anti-inflammatory cytokines... ..	69
<b>Figure 22:</b> Diagram of a typical CPB system in use in operating.....	72
<b>Figure 23:</b> CPB in the theatre.....	72
<b>Figure 24:</b> Schematic diagram of the laboratory work process. ....	80
<b>Figure 25:</b> Image of the ground machine that used to ground DEHP plasticised PVC tube.....	82
<b>Figure 26:</b> DEHP molecule structure .....	84

<b>Figure 27:</b> The formation of DEHP plasticised PVC .....	84
<b>Figure 28:</b> Bovine blood experiment set up .....	86
<b>Figure 29:</b> Sandwich ELISA general principle.....	88
<b>Figure 30:</b> Spectrophotometer principle of operation.....	89
<b>Figure 31:</b> Multiscan plate reader and the computer interface system. ....	91
<b>Figure 32:</b> Representative IL-6 standard curve.....	94
<b>Figure 33:</b> IL-6 levels pg/ml with grounded DEHP plasticised PVC at different agitation times (n=3).....	95
<b>Figure 34:</b> IL-6 concentrations pg/ml versus the mean of different loading liquid DEHP at different agitation times (n=3).....	95
<b>Figure 35:</b> Static control(SC) and dynamic control (DC) IL-6 levels (DEHP plasticised PVC samples.....	96
<b>Figure 36:</b> Dynamic controls minus static controls (IL-6 DEHP plasticised PVC)...	96
<b>Figure 37:</b> Static control(SC) and dynamic control (DC) IL-6 levels (liquid DEHP samples). ....	97
<b>Figure 38:</b> Dynamic controls and static controls (IL-6 liquid DEHP).....	97
<b>Figure 39:</b> Representative TNF- $\alpha$ standard curve .....	98
<b>Figure 40:</b> TNF- $\alpha$ concentrations pg/ml versus different weights of DEHP plasticised PVC at different agitation times (n=3). ....	99
<b>Figure 41:</b> TNF- $\alpha$ concentrations versus different liquid DEHP volume at different agitation times (n=3).....	99
<b>Figure 42:</b> Static and dynamic control samples (TNF- $\alpha$ DEHP plasticised PVC). .	100
<b>Figure 43:</b> Dynamic control minus static control values (TNF- $\alpha$ DEHP plasticised PVC) . ....	100
<b>Figure 44:</b> Static and dynamic control samples (TNF- $\alpha$ liquid DEHP).....	101
<b>Figure 45:</b> Dynamic controls minus static controls (TNF- $\alpha$ liquid DEHP).....	101
<b>Figure 46:</b> Fourier transform infrared technique (principle of operation).....	112
<b>Figure 47:</b> FTIR system employed in this study.....	113
<b>Figure 48:</b> Representative IL-6 standard curve used in the assessment of patients' samples.....	122
<b>Figure 49:</b> IL-6 measurements in pg/ml for all patients.....	124
<b>Figure 50:</b> IL-6 Static and dynamic control values for all patients' samples. ....	125

<b>Figure 51:</b> IL-6 (Dynamic minus static control values) for all patients.....	126
<b>Figure 52:</b> IL-6 maximum, minimum and median values for all patients' samples.	127
<b>Figure 53:</b> Representative TNF- $\alpha$ standard curve used in the assessment of patients' samples.....	128
<b>Figure 54:</b> TNF $\alpha$ - measurements in pg/ml for all patients.....	129
<b>Figure 55:</b> TNF- $\alpha$ static and dynamic control values for all patients' samples. ....	130
<b>Figure 56:</b> TNF- $\alpha$ (dynamic minus static control values) for all patients. ....	131
<b>Figure 57:</b> TNF- $\alpha$ minimum, maximum and median values for all patients' samples. ....	132
<b>Figure 58:</b> Representative CRP standard curve used in the assessment of patients' samples.....	133
<b>Figure 59:</b> CRP measurements in pg/ml for all patients. ....	134
<b>Figure 60:</b> CRP static and dynamic control values for all patients' samples.....	135
<b>Figure 61:</b> CRP (dynamic minus static control values) for all patients. ....	136
<b>Figure 62:</b> CRP maximum, minimum and median values for all patients' samples.	137
<b>Figure 63:</b> IL-6 DEHP plasticised PVC normality distribution ( $p<0.05$ ).....	145
<b>Figure 64:</b> IL-6 liquid DEHP normality distribution ( $p<0.05$ ) .....	145
<b>Figure 65:</b> TNF- $\alpha$ DEHP plasticised PVC normality distribution ( $p<0.005$ ).....	146
<b>Figure 66:</b> TNF- $\alpha$ liquid DEHP normality distribution( $p<0.005$ ) .....	146
<b>Figure 67:</b> CRP DEHP plasticised PVC normality distribution ( $p=0.198$ ) .....	147
<b>Figure 68:</b> CRP liquid DEHP normality distribution( $p<0.005$ ).....	147
<b>Figure 69:</b> IL-6 DEHP Plasticised PVC model.....	150
<b>Figure 70:</b> IL-6 liquid DEHP model. ....	150
<b>Figure 71:</b> TNF-alpha DEHP plasticised PVC model .....	151
<b>Figure 72:</b> TNF alpha liquid DEHP model.....	151
<b>Figure 73:</b> CRP DEHP plasticised PVC model .....	152
<b>Figure 74:</b> CRP liquid DEHP model.....	152
<b>Figure 75:</b> Patients' ages receiver operating curve. ....	158
<b>Figure 76:</b> Representative FTIR spectrum results.....	160
<b>Figure 77:</b> FTIR standard control curve.....	160
<b>Figure 78:</b> Patients' IL-6 DEHP plasticised PVC scores with ELISA and FTIR. ...	164
<b>Figure 79:</b> Lateral flow strip (LFS) components .....	169



<b>Figure 80:</b> Gemini Analyser by Thermo Fisher.....	170
<b>Figure 81:</b> Schematic diagram of the measurement procedure.....	171
<b>Figure 82:</b> 3D design of the activation chamber.....	172
<b>Figure 83:</b> Ultimaker 2 extended 3D printer.....	174
<b>Figure 84:</b> Experimental set up.....	175
<b>Figure 85:</b> Representative IL-6 standard calibration curve.....	176
<b>Figure 86:</b> IL-6 concentrations in pg/ml with 1.5 Volt and 3 Volt at different agitation times (10 min,30 min and 60 min) (n=3).....	177
<b>Figure 87:</b> IL-6 static control concentrations at different agitation times.....	177
<b>Figure 88:</b> Electron microscope scanning system (Hitachi, TM-1000).....	180
<b>Figure 89:</b> Different scans of the three different grades of separation membranes (plasma separation).....	183
<b>Figure 90:</b> Schematic diagram of the proposed screening test configuration steps.	185
<b>Figure 91:</b> Schematic of the proposed device for clinical testing.....	186

## LIST OF TABLES

<b>Table 1:</b> Differences between CPB and MECC.....	50
<b>Table 2:</b> Complement inhibitors.....	62
<b>Table 3:</b> The common pro-inflammatory cytokines and their functions.....	80
<b>Table 4:</b> Bovine blood samples protocol.....	85
<b>Table 5:</b> Exposure protocol of the bovine blood with DEHP plasticised PVC and liquid DEHP.....	85
<b>Table 6:</b> Sampling time description.....	86
<b>Table 7:</b> Sandwich ELISA steps.....	88
<b>Table 8:</b> Bovine blood samples' distribution in the ELISA plate.....	88
<b>Table 9:</b> Multiscan plate reader steps.....	91
<b>Table 10:</b> Basic Patient Demographic Data collected.....	108
<b>Table 11:</b> Basic CPB parameters recorded in all patients.....	108
<b>Table 12:</b> Post-operative observations recorded.....	109
<b>Table 13:</b> Destination of each aliquot of patient blood.....	109
<b>Table 14:</b> Blood processing protocol performed on all patient blood samples.....	110
<b>Table 15:</b> Plasma sample distribution map for all ELISA plates.....	111
<b>Table 16:</b> Area under curve (AUC) classification.....	115
<b>Table 17:</b> Summary of the basic patient demographics of the clinical study group.....	118
<b>Table 18:</b> Post-operative clinical observations in all 52 patients studied.....	119
<b>Table 19:</b> Post-operative clinical observations with patients considered to have complications or signs of possible inflammatory SIRS.....	120
<b>Table 20:</b> Comparison of patient demographic data between those patients identified with signs of an exaggerated inflammatory response to CPB and those with a normal and uncomplicated clinical course.....	121
<b>Table 21:</b> Comparison of known IR status in the patient population with the assay results for all configurations of initiator and marker.....	139
<b>Table 22:</b> Analysis of Euroscore as an identifier of post-operative complications of inflammatory origin.....	141
<b>Table 23:</b> Analysis of the predictive capability of all configurations of markers and initiators.....	142

<b>Table 24:</b> Wilcoxon test for IL-6 patients results.....	143
<b>Table 25:</b> Wilcoxon tests for TNF- $\alpha$ patients results.....	144
<b>Table 26:</b> Wilcoxon test for CRP patients' results .....	144
<b>Table 27:</b> Significance test for IL-6,TNF- $\alpha$ and CRP on SIRS and non-SIRS patients. .....	148
<b>Table 28:</b> Summary findings from the models (IL-6 DEHP plasticised PVC, IL-6 liquid DEHP, TNF- $\alpha$ DEHP plasticised PVC, TNF- $\alpha$ liquid DEHP,CRP DEHP plasticised PVC and CRP liquid DEHP). .....	153
<b>Table 29:</b> Predictors threshold values based on the sensitivity and specificity analysis.....	155
<b>Table 30:</b> Comparison of known IR status in the patient population with the statistical results (regression analysis).. .....	156
<b>Table 31:</b> Analysis of the predictive capability of all configurations of markers and initiators based on the regression analysis models. ....	157
<b>Table 32:</b> Observed ELISA SIRS prediction Vs Statistical analysis prediction. ....	157
<b>Table 33:</b> ELISA and FTIR data for IL-6 DEHP plasticised PVC. ....	162
<b>Table 34:</b> Patients who develop SIRS with both ELISA and FTIR techniques. ....	165
<b>Table 35:</b> Activating chamber printing steps. ....	173
<b>Table 36:</b> Bovine blood protocol(activation chamber) .....	175
<b>Table 37:</b> Plasma separation membranes' specifications .....	179
<b>Table 38:</b> Wicking membrane specifications. ....	184

## **LIST OF ABBREVIATIONS**

CPB- Cardiopulmonary bypass

OHS-Open heart surgery

IR-Inflammatory response

PVC-Polyvinyl chloride

DEHP- (Di-2-ethylhexyl) phthalate

DEHPPVC- DEHP Plasticised PVC

CABG-Coronary Artery Bypass Graft

MIDCAB-Minimally Invasive Direct Coronary Artery Bypass

IL-1 – interleukin 1

IL-6- interleukin 6

IL-8- interleukin 8

IL-10- interleukin 10

IL-12- interleukin 12

Il-13- interleukin 13

TNF- $\alpha$  - Tumor necrosis factor alpha

CRP-C-reactive protein

RBCs-Red blood cells

WBCs – White blood cells

ARDS-Acute respiratory distress syndrome

SIRS-Systemic Inflammatory Response Syndrome

PMN- Polymorphonuclear neutrophils

ITU-Intensive Tension Unit

MBL- mannose binding lectin

NO- nitric oxide

iNO-inducible nitric oxide

cNOS- constitutive nitric oxide synthase

LPS- lipopolysaccharide

ROS-reactive oxygenation species

MBL-Mannose binding lectin

Mini-CPB- Minituarised Cardiopulmonary bypass

ECMO-Extracorporeal membrane oxygenator

MECC- Minimized extracorporeal circuit

CCPB-Conventional cardiopulmonary bypass

MiECC-Minimized invasive extracorporeal circulation

RHS-resting heart system

HCC-Heparin coated circuit

CUF- Conventional Ultrafiltration

MUF-Modified Ultrafiltration

MIDCAB-Minimally invasive cardiac surgery

PDEI-Phosphodiesterase inhibitors

SNP- Sodium nitroprusside

SOFA-sequential organ failure assessment

ELISA-Enzyme linked immunosorbent assay

FTIR- Fourier transform Infrared Spectroscopy

ASD-Arterial septal defect

HVR-Heart valve replacement

AOG-Ascending aorta graft

TCA-Thoracic and arcus aorta replacement

LFS-Lateral Flow Strips

LFD-Lateral Flow Device

3D -3 Dimensional

SEM-Scanning Electron microscope

POC-Point of Care

AUC- Area Under Curve

AIC-Akaike information criterion

SEM-standard error of the mean

## Table of Contents

<b>Declaration.....</b>	<b>i</b>
<b>Acknowledgement.....</b>	<b>ii</b>
<b>Abstract.....</b>	<b>iii</b>
<b>Thesis outline.....</b>	<b>v</b>
<b>List of figures.....</b>	<b>vii</b>
<b>List of tables .....</b>	<b>xi</b>
<b>List of abbreviations.....</b>	<b>xiii</b>
<b>Chapter 1: Cardiopulmonary bypass.....</b>	<b>1</b>
<b>1 : Cardiopulmonary bypass (CPB).....</b>	<b>2</b>
1.1 Introduction.....	2
1.2 Cardiopulmonary bypass history (CPB) .....	2
1.3 CPB circuit (Principle of operation) .....	5
1.4 Pathophysiology of the CPB.....	13
1.5 Summary .....	14
<b>Chapter 2: Cardiopulmonary bypass and the development of inflammatory responses.....</b>	<b>15</b>
<b>2 : Cardiopulmonary bypass and the development of inflammatory responses.....</b>	<b>16</b>
2.1 The concept of inflammation.....	16
2.2 Inflammation.....	16
2.3 Basic components of the blood .....	21
2.4 Inflammatory cells .....	23
2.5 Immune system and inflammatory responses .....	24
2.6 Potential trigger of inflammatory responses during CPB .....	25
2.7 Cellular pathway of inflammatory responses .....	29
2.8 Humoral pathways of inflammatory responses.....	31
2.9 Cytokines and chemokines .....	38
2.10 Anti-inflammatory strategies to attenuate the inflammatory response .....	47
2.11 CPB's post-operative complications.....	66
2.12 Summary .....	69

<b>Chapter3: Hypothesis and objectives of the work.....</b>	<b>71</b>
<b>3 : Hypothesis and objectives of the work .....</b>	<b>72</b>
3.1 Introduction.....	72
3.2 Hypothesis of the project .....	75
3.3 Aims and objectives of the project.....	75
3.4 Objectives .....	77
<b>Chapter 4: In-vitro laboratory studies methodology.....</b>	<b>78</b>
<b>4 : In-vitro laboratory studies methodology.....</b>	<b>79</b>
4.1 Background.....	79
4.2 Determination of the initiators .....	84
4.3 Blood samples.....	85
4.4 Activation of blood samples .....	85
4.5 Enzyme Linked Immunoassay Sorbent Assay (ELISA).....	87
4.6 Statistical analysis.....	92
4.7 Summary .....	92
<b>Chapter 5: In-vitro laboratory studies results.....</b>	<b>93</b>
<b>5 : In-vitro laboratory studies results.....</b>	<b>94</b>
5.1 Introduction.....	94
5.2 IL-6 measurments .....	94
5.3 TNF- $\alpha$ measurements .....	98
5.4 Summary .....	102
<b>Chapter 6: Clinical study methodology.....</b>	<b>103</b>
<b>6 : Clinical study methodology.....</b>	<b>104</b>
6.1 Objectives .....	104
6.2 The clinical protocol .....	106
6.3 Statistical analysis.....	114
6.4 Summary .....	115
<b>Chapter 7: Clinical study results .....</b>	<b>116</b>
<b>7 : Clinical study results.....</b>	<b>117</b>
7.1 Introduction.....	117



7.2	Patient Demographics .....	117
7.3	Results of Cytokine measurement using the ELISA technique. ....	121
7.4	Analysis of the accuracy of each cytokine in predicting heightened IR to the surgical procedure .....	138
7.5	Statistical analysis .....	143
7.6	Fourier transform infrared spectroscopy (FTIR) Results.....	159
7.7	Summary .....	165
<b>Chapter 8: Device development.....</b>		<b>167</b>
<b>8 : Device development.....</b>		<b>168</b>
8.1	Device development.....	168
8.2	Summary .....	186
<b>Chapter 9: Discussion.....</b>		<b>188</b>
<b>9 : Discussion .....</b>		<b>189</b>
9.1	Achieved objectives .....	189
9.2	Why developing a POC screening technology?.....	190
9.3	Laboratory and clinical studies .....	190
<b>Chapter 10: Conclusion and future work.....</b>		<b>196</b>
<b>10 : Conclusion and future work .....</b>		<b>197</b>
10.1	Conclusion .....	197
10.2	Future work.....	199
<b>References.....</b>		<b>200</b>
<b>Appendices.....</b>		<b>249</b>

**Chapter 1**

**Cardiopulmonary bypass**

**(CPB)**

## **1 : Cardiopulmonary bypass (CPB)**

### **1.1 Introduction**

Cardiovascular diseases are the leading cause of death globally. Different types of cardiac operations are performed every day in hospitals varying in complexity to treat several lesions such as coronary artery bypass graft, heart valve replacement and total heart replacement. Cardiopulmonary bypass (CPB) is a crucial technique employed in the majority of these operations (Punjabi and Taylor 2013). It takes over the function of the heart and lungs during the surgery to maintain the adequate circulation of oxygen and nutrients over the procedure.

#### **1.1.1 Coronary artery bypass graft (CABG)**

CABG is a common procedure that used CPB to treat the blockage of the coronary arteries. It diverts blood around an obstructed artery in order to improve or restore blood flow and oxygen to the heart. The left and right coronary arteries play a crucial role in the controlling of the supplied amount of oxygen to the body. If these arteries are blocked or narrowed, (risk factors include obesity, high cholesterol and smoking) blood flow is occluded and the patient may suffer from atherosclerosis. Patients with atherosclerosis after experience severe angina and are at risk of myocardial infarction. Hence, the surgical intervention in this situation involves grafting a vessel in the taking of a new vessel from the arm, chest or leg and attaching to the coronary artery below the blockage area.

### **1.2 Cardiopulmonary bypass history (CPB)**

The concept of perfusing organs during surgery originated in the late 18<sup>th</sup>, early 19<sup>th</sup> century. Several studies on animal models were conducted to investigate the effectiveness of dynamic blood flow via organs (Belanger et al. 2002; Rickards and

Tzeng 2015). Subsequently, Lillehei reported a novel successful technology of cross circulation (figure 1), using a clinical study on 32 patients with cross circulation system (Lillehei 1993).

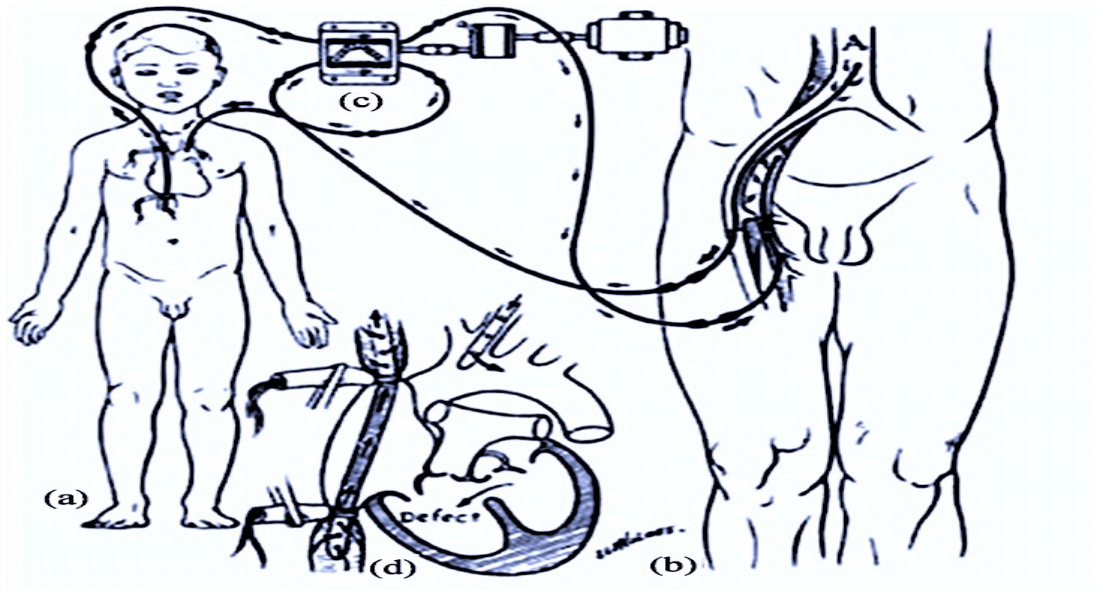

**Figure 1:** Cross circulation technology (a) the patients, ( b) the donor, (c) motor pump and (d) close up of the patients heart. Basically, the adult's femoral artery was connected to the child's left artery. A single superior vena cava cannula was used in order to drain blood between patients. Also, a motor pump was used to control the blood flow and maintain the adequate blood volume during the procedure (Hessel 2015).

Dr Gibbon pioneered the development of CPB with his research group in the United States (figure 2). In 1931, he developed a pump oxygenator which would be a key mechanism in the technology. The first successful use of Gibbon's heart lung machine was on dogs (Gibbon Jr et al. 1954). 12 out of 20 dogs survived the surgery. In 1953, he attempted this in humans, and connected the patient to the CPB for 26 minutes in order to repair an arterial septal defect (Cohn 2003). After this successful operation, surgeons and bioengineers considered the technical feasibility of applying CPB to many conditions within the cardiac surgery, including open-heart surgery. Now, more than 1 million open-heart surgery operations are performed using CPB every year (Punjabi and Taylor 2013).

CPB uses a number of technologies (pumps and oxygenators). The first major development of CPB involved the use of roller pumps and bubble oxygenators were in the 1950s, and, in the 1960s, disposable oxygenators were developed to expand their blood capacity. In the 1970s, the first generation of membrane oxygenators and centrifugal pumps were introduced to CPB technology. Following these advancements, in the 1990s, researchers studied the post-operative outcomes that resulted from CPB in particular, the onset of an inflammatory response. This initiated major studies on the area of biocoating (Galletti and Mora 1995) (Edmunds 2002). Nowadays, CPB is considered to be the most effective and successful assisting device that can take over heart and lung function during surgical procedures. Technological iterations are still ongoing to optimise life support systems by reducing the mortality and morbidity rates (John W Mulholland 2012).

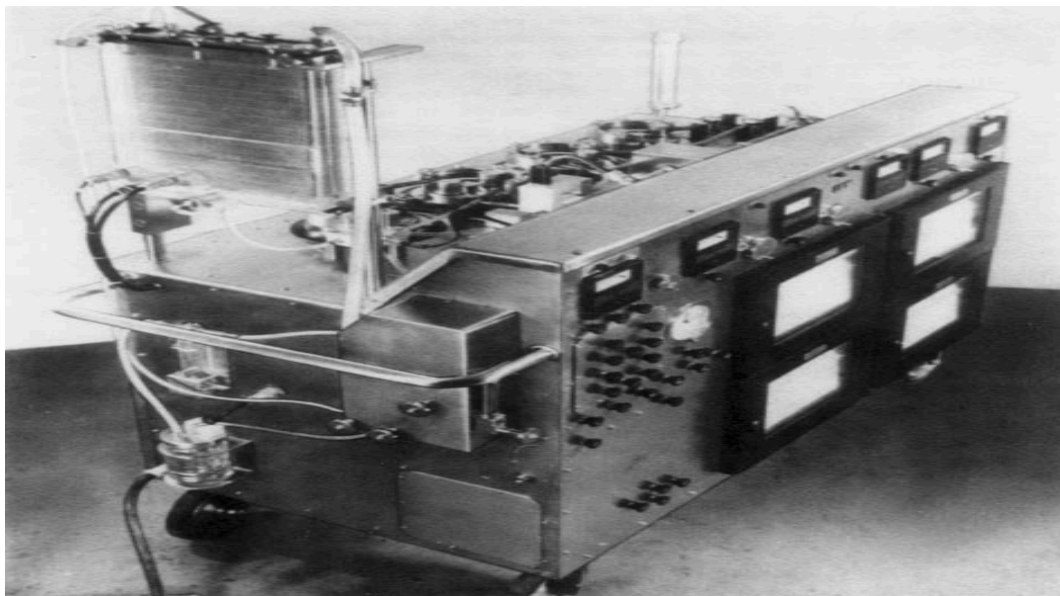
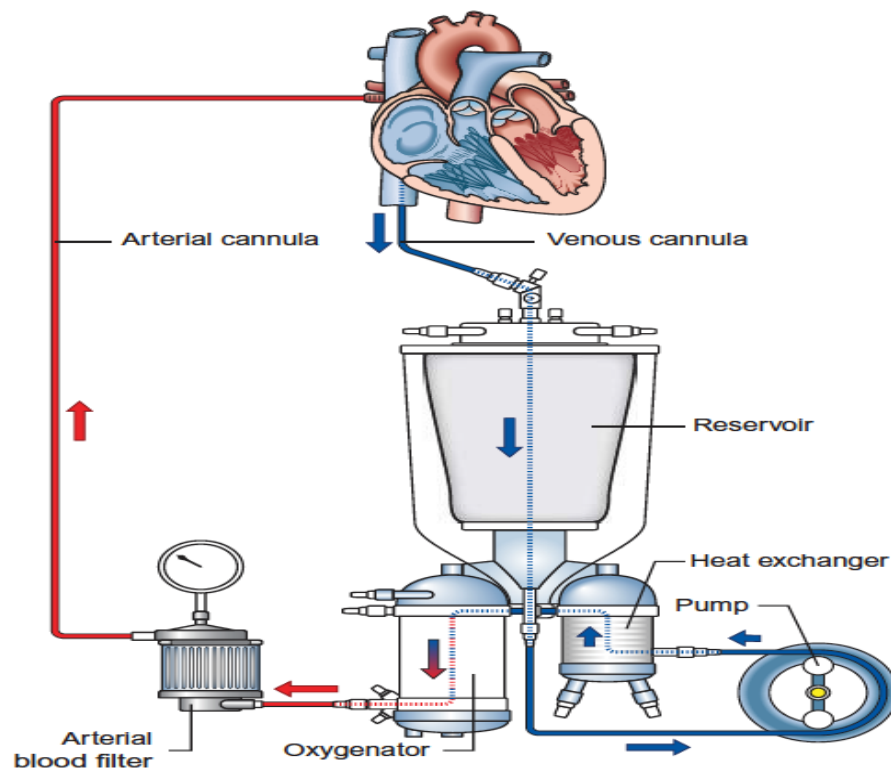

**Figure 2:**Gibbon's heart lung machine (Cohn 2003).

### **1.3 CPB circuit (Principle of operation)**

The early preparation step before connecting the patient to CPB is blood anticoagulation. Patient's blood is heparinized in order to prevent blood clotting. The normal dose of heparin is between 300 and 400 IU/ kg (O'Carroll-Kuehn and Meeran 2007). Venous cannula is then connected to the heart via median sternotomy. Insertion pathways of the cannula include the femoral vein, axillary artery and both ascending and descending aorta.

Venous blood is drawn from the right atrium via a polyvinyl chloride pipe to the venous reservoir to perform two main functions: to filter the blood and act as a capacitance chamber to manage the acute volume shift resulting from the use of CPB. To achieve the adequate blood volume drainage via venous cannula, it is very important to select appropriate cannula radius size. Basically, high blood pressure with a small cannula diameter leads to turbulent flow of the blood according to Reynolds number (Machin and Allsager 2006). The correct position of the cannula also plays an essential role in the blood volume drainage. Practically, the adequate venous blood volume is achieved by releasing the venous line clamp and allow the pump to receive the adequate volume that play a crucial role in the elimination of the air embolism risk. Then, the venous blood is pumped via a roller pump to the blood gas exchanger in order to purify and oxygenate the incoming blood before returning to return it back to the patient. Inside the hollow fibre membrane chambers, blood is flushed through a hollow fibre membrane in order to allow blood gas exchange and purification of the deoxygenated blood. Finally, the purified blood is returned back to the patient via the arterial cannula. The schematic diagram below shows the blood flow cycle within the heart lung machine during the operation (figure 3).



**Figure 3:**Cardiopulmonary bypass components(Punjabi and Taylor 2013) .

### **Tubing**

CPB tubes are made from different materials (Poly vinyl chloride (PVC), silicon and latex rubber). PVC is developed by the formation of the polymer chain (Carbon-Chlorine), and this bond makes the tube rigid and strong. Therefore, a plasticizer is incorporated to PVC in order to enhance the flexibility of the tube and to make it softer. PVC is more sensitive to the temperature fluctuations, unlike silicon and latex rubber. However, PVC is still used commonly in medical applications due to its durability and acceptable level of hemolysis (Ma, Lu, and Gao 2002).

### **Arterial cannula**

The arterial cannula connects the arterial side of the CPB machine and the patient. It works to transport the oxygenated purified blood from the machine to the patient.

There are different variations of cannula regarding thickness and size, and thin walled cannula is preferred due to its low resistance to blood flow.

### **Arterial filter**

Arterial filters are one of the basic integrated CPB components. It is made from hydrophilic polyester material with an exposure area to the blood ranging from 400-800cm<sup>2</sup>(Hawkins et al. 2010).

Arterial filter acts to remove air and other detritus from the purified and oxygenated blood before returning to the patient (Kaza et al. 2003). This feature continues to work with CPB system with no direct return of shed blood. However, the new developed life support systems-such as minimized extracorporeal circulation-consists of a closed system that has air removal and automated blood flow control. This new features reduces the need for using arterial filter in the circuit (Brian 2008).

### **Venous cannula**

This cannula is placed in the right atrium of the heart. The venous reservoir is placed 40cm to 70 cm below the heart. Basically, gravity plays an essential role in draining blood to the system. In terms of the venous cannula, it is made of flexible plastic in order to avoid the risk of kinking. The disadvantage of this cannula is the inability to stop all blood and its interference with the right atrium.

Currently, Smart Cannula is considered as the best optimal design used in a variety of applications in the medical field (Mueller, Mallabiabrena, et al. 2002). As seen in figure 4, the design allows self-expansion of the cannula within the vein which leads to enhanced flow rates and improved vascular access to the patient(Jegger et al. 2002; Jegger et al. 2003).



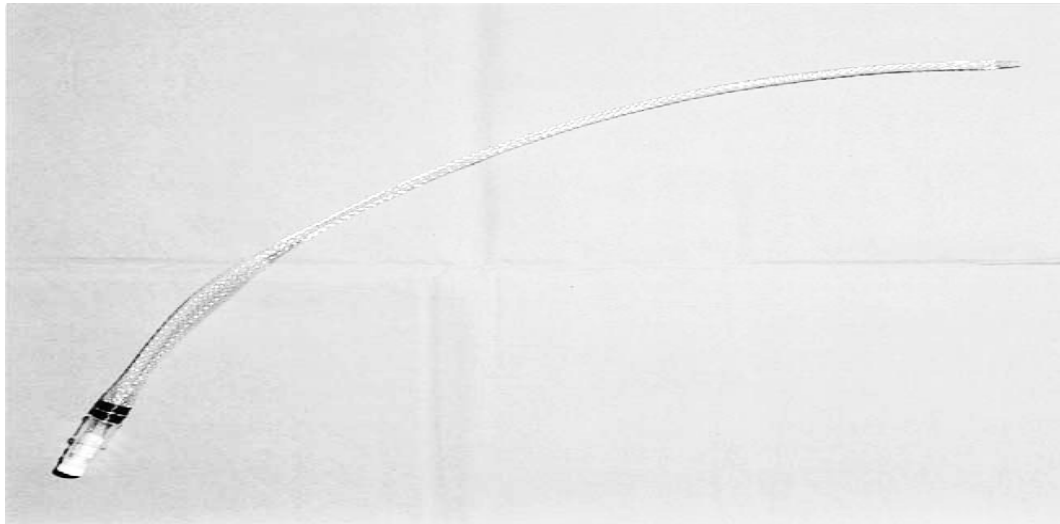

**Figure 4:** Smart Cannula (Mueller, Tevæarai, et al. 2002) .

### **Venous reservoir**

The venous reservoir is considered as an essential part of the whole CPB system. It is performing two main functions: accumulate the coming blood from the patient's vein and remove any air/ bubbles from the venous blood. It is connected between the patient and the arterial pump. The blood is drained by the effect of gravity into the oxygenators for oxygenation purposes and removing the carbon dioxide.

Clinically, there are two types of venous reservoir (open and closed). Closed reservoir is considered as the best standard type in the market due to its high biocompatibility rather than open system (Schönberger, Everts, and Hoffmann 1995).

### **Pumps**

During CPB, the deoxygenated blood is pumped to the machine for oxygenation and returning back to the patient via a mechanical pump. The pump configuration considers the relationship between two important factors (resistance and pressure) in order to achieve a constant blood flow. The Hagen-Poiseuille equation is described below:

$$\text{Blood flow rate} = \text{Pressure} / \text{resistance}.$$

There are two types of pumps: roller and centrifugal pumps. Both types are widely used due to their accuracy and the ability to generate different blood flow rates (Machin and Allsager 2006).

A roller pump is a curved metal shape surrounded by length of PVC and silicon tube. This pump is based on the forward blood flow (positive displacement device). A centrifugal pump instead consists of a plastic cone with a vaned impeller. This cone is powered by electrical motor that generates centrifugal force which is converted into kinetic energy to deliver the blood through the circuit. It has many advantages compared to the roller pump, such as reducing the likelihood of rupture and the disconnection of other circuit components, flow obstruction, and reducing blood trauma.

### **Oxygenators**

Oxygenators take over the lung function to provide purified blood to the patient (figure 5). Historically, the first used oxygenator in the theatre was by Dr. Gibbon in 1953. Bubble oxygenators were used during that period. However, the increase in the number of patients and demand on OHS led to an increased demand of developing a new membrane technology which can enhance the surgical procedure.

In 1980, Mitsubishi introduced a new membrane technology that comprises three layers (polyurethane and polypropylene). This membrane has three main advantages: firstly, high productivity, secondly self-supporting and thirdly, high recovery rate.

In some cardiac operations, a micro filter bubble trap is added to the arterial outflow in order to achieve high levels of filtration before returning the blood to the patient. (Punjabi and Taylor 2013).

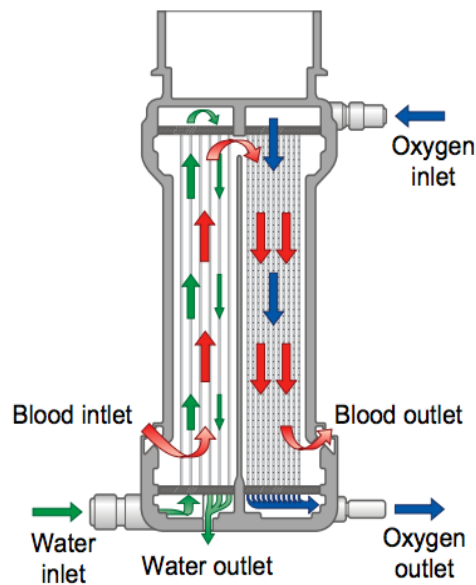

**Figure 5:** Membrane oxygenators workflow Deoxygenated blood enters through the blood inlet port and comes in contact with hollow fibre membrane for blood-gas exchange. Finally, the purified blood leaves through the blood outlet port (Punjabi and Taylor 2013).

### Heat exchange

Maintaining acceptable temperature levels during surgery plays a crucial role in eliminating the risk of developing unwanted complications with CPB. (Stump 2005) reported that the optimal perfusion temperature is between (32-35°C).

Heat exchangers control temperature via an integrated heater and cooler device attached to the oxygenator. This device is composed of a water circuit in addition to the blood circuit. Adjusting the temperature at the water circuit manually during the surgery can thus control the blood temperature (Schmidt et al. 2003). In relation to cardioplegia cooling system, mixed blood/ crystalloid is delivered from CPB to the aortic roots every 15 to 30 min during the aortic cross clamping procedure in order to maintain heart arrest and hypothermic condition over the surgery. The cardioplegic dosage can be administered based on the patient's weight and body surface area (Durandy 2015).

### **Anticoagulants**

CPB components must be coated to increase biocompatibility with the blood. Direct contact between the blood from the patient and the tube materials lead to the activation of inflammatory cascades such as complement and coagulation cascades. Therefore, an anticoagulant is necessary to prevent clotting factors during surgery that are associated with these cascades (O'Carroll-Kuehn and Meeran 2007). Heparin is a popular anticoagulant that used in different operations. The required amount is 300 units/kg, and this is given to the patient and to the CPB circuit (Michelsen et al. 1996).

### **Priming solutions and CPB circuit**

It is essential to use prime solutions and fluids in CPB to prevent any risk of air embolism. The required volume of the priming solutions is determined by the caliber and length of the tube used in both sides (venous and arterial) and the CPB design. The normal priming solution range for adult patients is between 1400 -1800 ml (Gu and Boonstra 2006).

### **Priming solutions classification**

Choosing the appropriate prime solution for CPB has been a concern for a number of decades (Boonstra and Gu 2004). Basically, priming solutions can be classified into two groups: crystalloids and colloids (Gu and Boonstra 2006). The prime solution varies throughout different medical centres based on the cost and ease of use. A comprehensive survey was conducted in 31 cardiac centers in United Kingdom and Ireland showed that surgeons recommended using crystalloids during cardiopulmonary surgery (Lilley 2002).

## **Crystalloids**

Crystalloids are considered an ideal priming fluid due to similarities in tonicity and electrolyte composition with blood plasma. Tonicity is crucial due its role in the preventing red cell lysis during CPB. There are three types of crystalloids based on the solute concentrations and its relation to the plasma: isotonic(solute concentrations are equal to the solute concentration of plasma, hypotonic(less than the solute concentration of plasma) and hypertonic(greater than the solute concentration of plasma) (Frumento and Bennett-Guerrero 2008).

## **Dextrose**

Cooley and colleagues stated that using dextrose with priming solution lead to improved clinical outcomes(Cooley, Beall, and Grondin 1962). It is considered as one of the first crystalloid priming solutions used for CPB. It has a beneficial effect in reducing mechanical damage to the red blood cells and improving post-operative outcomes (Quinn et al. 2006).

## **Mannitol**

Mannitol is a hypertonic solution used widely in clinical practice in order to stimulate diuresis. Adding 5% mannitol may help to reduce the impact on organs such as kidney and reduce the effect of having renal failure after the surgery. Fisher and his research team conducted study to determine the effect of mannitol in the post CPB renal functions, and it showed an improvement in renal functions after the operation (Fisher et al. 1998).

## **Colloids**

Colloids contain 4.5 % albumin, gelatins and starches. These solutions are used in CPB due their role in the decreasing the colloid oncotic pressure. This reduction leads to eliminating the shift of water and other fluids to the intracellular spaces.

### **1.4 Pathophysiology of the CPB**

Although CPB administration is considered a successful technology in most cardiac surgeries, it can lead to significant pathophysiological processes with regards to: haemodynamics, hypothermia and blood cell activation (Smith, Smith, and Taylor 1993).

#### **Haemodynamics**

The flow rate during CPB is adjusted by the perfusionist. Blood flow rate during CPB ranges from 2-2.5 l/m<sup>2</sup> at normal temperature but it decreases as the temperature decreases (Cook et al. 1997; Schima et al. 1997). It is vital to achieve the moderate flow rate by CPB in order to avoid the risk of blood cell trauma. The used of moderated hypothermia during cardiac surgery leads to reduced blood flow rate in the CPB system. Practically, maintaining a lower temperature can lead to a decrease in the oxygen consumption rate. For example, lowering the temperature from 37°C to 20 °C resulted in oxygen reduction to 120 ml/m<sup>2</sup> per minute at flow rate 2.4 l/m<sup>2</sup> (Smith, Smith, and Taylor 1993).

#### **Hypothermia**

Hypothermia may lead to an increase in the ischaemic thresholds. The optimal temperature is achieved during CPB by using either an external cold solution around the heart or a cardioplegic technique (cold solution infused into the coronary circulation).

## **Blood cell activation**

CPB requires patient's blood to come in contact with a large surface area during the 1-2 hour procedure. This contact may trigger the activation of different inflammatory cascades and inflammatory mediators that contribute to the development of an inflammatory response syndrome and other deleterious effects (Gourlay et al. 2001). This is predominantly due to blood's interaction with surface, which is normally DEHP Plasticised PVC.

### **1.5 Summary**

1. CPB is a life support system used in cardiac surgery since 1953. It consists of many integrated parts including roller pump and oxygenators. It takes over heart and lung function throughout the surgery
2. CPB system is managed by a professional perfusionists and directed over the surgery by surgeons. Although, it is considered as the gold standard technology in the cardiac operations due to its efficacy and lower mortality and morbidity rates, it is associated with number of complications that may produce deleterious outcomes. The following chapter will discuss these complications in details, in relation to the development of an inflammatory response.

**Chapter 2: Cardiopulmonary  
bypass and the development of  
inflammatory responses**



## **2 : Cardiopulmonary bypass and the development of inflammatory responses**

### **2.1 The concept of inflammation**

Inflammation is the body's adaptive response to insult and injury (Majno and Joris 1996). This response varies from normal to severe. The first description of inflammation was presented by a Roman physician called Celsus in the first century, who stated that inflammation is characterised by four common signs which are redness, heat, pain and swelling. Inflammation has been recognised throughout the ages as the defence of the body against the foreign insult, from Galen in the 3<sup>rd</sup> century to John Hunter in the 18<sup>th</sup> century.

At the beginning of the 20<sup>th</sup> century, the concept of inflammation was expanded by immunologists who demonstrated the essential role of both antibodies and antigens in the developing of the inflammatory cascades (cellular and humoral)(S.H.Ferreira 1978). Subsequently, there was a noticeable understanding of inflammation and its role in the prognosis of different pathogens. They highlighted the importance of chemical mediators in the inflammatory cycle and how they affect controlling the development of disease.

The inflammatory response level varies from patient to patient based on the severity of the insult and other factors related to the patient's physiology. The early stage of inflammation is characterised by three processes which are: changing the calibre of flow in small blood vessels, increased vascular permeability, and increased adhesion molecules with vascular endothelium interactions.

### **2.2 Inflammation**

There are six common signs of the inflammation (figure 6) which are:

- Fever, which means an increase in the temperature of the body and can be detected under the skin. This results from the increase of blood flow at the inflamed /injured site.
- Swelling, which results from the accumulation of fluid under the skin due to the comprehensive process of the inflammatory responses.
- Tiredness is characterized by increased inactivity and feeling of lethargy.
- Pain normally results from stretching and distortion of the tissue as a by-product of the inflammatory response (such as oedema)
- Loss of function
- Redness at the site of inflammation.

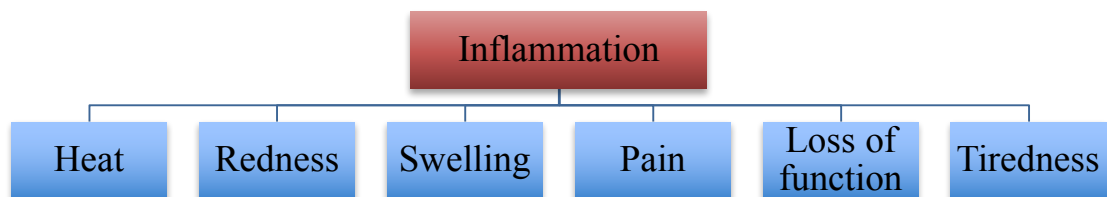

**Figure 6:** Cardinal signs of inflammation.

### **2.2.1 Causes of inflammation**

Although inflammation is a normal reaction at the site of injury, the overexpression of inflammatory mediators can result from a number of factors (microbial infections, hypersensitivity, physical and chemical agents and necrosis).

## **Microbial infections**

The majority of inflammatory diseases are triggered by microbes such as viruses, bacteria, fungi and parasites. Viral infections spread to the intracellular cells and lead to cell death or sometimes explosion the cells (phagocytosis and apoptosis). Phagocytosis is the process of ingesting the cells and particles, whereas apoptosis is a programmed cell death which can be initiated through two main pathways: intrinsic (cell death by the cell itself ) and extrinsic (cell death by a signal from other cell) (Elmore 2007).

## **Hypersensitivity**

This refers to an excessive reaction of the immune system, and it is divided into four types: immediate, antibody mediated, immune-complex mediated and cell mediated (Sherman 1968).

### **Type 1: immediate reaction**

This is the rapid reaction to external stimuli. It involves skin(eczema), eye reactions, and other common diseases such as asthma. This response usually takes 15-30 minutes following stimulation but in exceptional cases the response may delayed to 10-12 hours (Samuelsson 1983; Ghaffar 2006).

The mechanism of type 1 hypersensitivity is characterized by the mediation of immunoglobulin IgE (a specific antibody produced by the immune system which is an over reaction to an allergy). This mediation leads to initiate the activation of specific inflammatory cells (mast and basophil immune cells).

### **Type 2: antibody mediated**

This is characterized by the process of an antibody binding to a specific targeted antigen which leads to the process of cell destruction. It plays a pivotal role in

several diseases such as rheumatic heart disease and autoimmune hemolytic anemia. Moreover, the reaction time of this type ranges from minutes to hours.

### **Type 3: Immune complex disease**

This is defined as the binding of antibodies to a specific soluble antigen in order to form the circulating immune complex. This reaction is classified as general (such as serum sickness) and individual (such as extrinsic allergic alveolitis). The normal onset of this response occurs from 3 to 8 hours post-exposure.

### **Type 4: Delayed type hypersensitivity**

This is known as cell mediated hypersensitivity due to its effect on cell structures. This type contributes to the development of common diseases such as tuberculosis, toxoplasmosis and blastomycosis. The onset time of this ranges from 48-72 hours (Ghaffar 2006).

### **Physical and chemical agents**

Inflammation may occur from trauma and exposure to chemicals or physical agents such as radiation and burns. These agents and others provoke the inflammatory mediators at the site of injury via different inflammatory pathways including cellular and humoral cascades.

### **Necrosis**

Necrosis refers to tissue's death due to a lack of oxygen and nutrients. This occurs because of a limited blood flow at the site of injury due to the exposure to different factors that can cause cell death such as infections, trauma and exposure to toxins (Kroemer et al. 2009).

### **2.2.2 Acute phase of inflammation**

The acute phase of inflammation occurs within seconds after injury and damage to the tissue. The damage may be physical to the body or involving the activation of the immune system and other immunity cellular cascades. This phase increases blood flow to the site of the injury, increases permeability of proteins and fluid to move into the interstitial spaces.

### **2.2.3 Chronic inflammation**

Chronic inflammation refers to an inflammation over a long period of time (weeks to months). It can be divided into two groups: granulomas and non-granulomas depending on the stimuli agent (infection or non-infection)(Majno and Joris 1996). Chronic inflammation is productive and proliferative, and it involves the adaptive immune system (subsystem from the overall immune system that is composed of different specialized cells to prevent the pathogen growth) and contributes to many other diseases such as cardiovascular disease, diabetes, atherosclerosis, obesity and rheumatoid arthritis.

Clinically, the symptoms of chronic inflammation are similar to the acute inflammatory symptoms. Some of the chronic inflammatory symptoms start at early onset and progress slowly. For example, irritating pain, allergy, asthma, fatigue and skin problems are common chronic inflammation signs.

Cytokines, a large group of proteins, peptides or glycoproteins secreted by specific cells of the immune system, are strongly associated with acute and chronic inflammation. Tumor necrosis factor- $\alpha$  (TNF- $\alpha$ ) and interleukin-1 (IL-1) cytokines stimulate the production of collagenase and other enzyme which accumulate at the

site of injury in order to repair the tissue damage and enhance the healing process (Verschure and Van Noorden 1989).

## **2.3 Basic components of the blood**

### **2.3.1 Red blood cells (erythrocytes)**

Red blood cells (RBCs) are considered the essential part of blood. They represent approximately 45% of the whole blood volume and contain two important elements of the blood (haemoglobin and iron). RBCs play a crucial role in carrying oxygen and removing unwanted elements such as carbon dioxide.

In the context of CPB, RBC hemolysis (rupture of RBCs) is considered as one of the predominant problems that contribute to deleterious outcomes. Many factors contribute to the damaging of RBC structure and cause hemolysis such as shear stress, pressure, blood exposure time to the non-endothelial surface of the CPB tube and other cellular factors (Vercaemst 2008; Vieira Junior et al. 2012).

Patients who suffer from hemolysis during CPB may at risk of developing unwanted complications during the surgery (Yousafzai et al. 2010).

### **2.3.2 White blood cells (leukocytes)**

White blood cells (WBCs) are immune cells circulating in the blood to protect the body from foreign attack and infections (bacteria, viruses, parasites). WBCs are classified into two main categories based on structure (presence of cytoplasmic granules): granulocytes and agranulocytes.

Granulocytes are granules containing white blood cells (neutrophils, basophils and eosinophils). Conversely, agranulocytes do not have cytoplasmic granules in their structure. The two common types of a granulocytes are monocytes and lymphocytes.

Monocytes are the largest WBCs in the blood, and their main function is to carry out phagocytosis of foreign particles. A smaller subtype of WBCs are lymphocytes, which are formed in bone marrow. There are three main types of lymphocytes: T cells (cell mediated immunity that mature in the thymus gland), B cells (humoral immunity that mature in the bone marrow) and natural killer cells (cytotoxic). Both T and B cells types produce antibodies to attack a specific targeted antigen and destroy it (Abul K.Abbas 1991).

### **2.3.3 Platelets**

Platelets are fragmented cells that circulate in the blood and bind together when there is an exciting injury and damage to the blood vessels. They originate in the bone marrow with normal range between 150,000 and 450,000 per milliliter of the blood. If the patient's platelets number is lower than 150,000, the condition is called thrombocytopenia (in which the patient experiences fatigue and weakness) while if the number is over 450,000, it is called thrombocytosis (which often presents with inflammatory disease) (Michelson 2006).

In the context of CPB, there are a number of factors that trigger the activation of the platelets, such as hypothermia, shear forces, blood contact with non-endothelial surfaces and the release of endogenous chemicals (Day et al. 2002; Day, Landis, and Taylor 2004; Weerasinghe and Taylor 1998). It was reported by Day and colleagues that platelet activation during CPB promotes the process of neutrophils adhesion and transmigration by attaching the activated platelets to the vascular wall of the endothelium (Day and Taylor 2005).

## **2.4 Inflammatory cells**

### **2.4.1 Neutrophils**

Neutrophils are immune cells which are made in the bone marrow and circulate in the blood stream. They form around 70% of the white blood cells and considered as the first defense line against any foreign attackers to the body (Kumar and Sharma 2010). A series of inflammatory cascades promote the activation of neutrophils cells such as complement mechanisms, endotoxins and cytokines (Asimakopoulos et al. 1999).

### **2.4.2 Basophils**

Basophils are inflammatory mediator cells described as a small population of peripheral blood leukocytes that contain cytoplasmic granules. They play an important role in the development of inflammatory reactions to stimuli, and they are vital cellular components that trigger inflammatory cascades. During basophilic activation by internal or external stimulation, there is a secretion of a chemical called histamine. This chemical enhances the vascular permeability of basophils to migrate at the local site of injury.

### **2.4.3 Mast cells**

Inflammatory cells play an important role in the development of the inflammatory response cycle. Mast cells are derived from the haematopoietic progenitor cells and circulate in the blood in an immature form (Urb and Sheppard 2012). These cells are found in the most of body tissues, specifically located on the outer surface layers (such as the skin) to enable contact with external stimuli. When the mast cells activate, they release different pro-inflammatory cytokines to the blood, and they can also be activated by thrombin, a crucial chemical in the coagulation cascades.



#### **2.4.4 Monocytes**

These are incompletely differentiated phagocytes in the blood stream. During the activation stage, monocytes settle in the tissue and are known as macrophages. They can be activated via different stimulation factors such as complement, endothelial cells, endotoxins and the presence of pro-inflammatory cytokines. The degree of inflammatory damage to the organ is related to the accumulation of the macrophages in the skin and the tissue (Ernofsson, Thelin, and Siegbahn 1997).

#### **2.5 Immune system and inflammatory responses**

The immune system plays a crucial role in the initiation of inflammatory responses. Activation of both cellular and humoral cascades leads to the secretion of pro-inflammatory and anti-inflammatory cytokines which promote the inflammatory mediators in the blood.

The factors that can lead to trigger the inflammatory responses are classified into nonspecific and specific factors. Surgical trauma, hypothermia and blood loss are nonspecific factors, while CPB activates the inflammatory mediators specifically via three different mechanisms: contact between the blood and the non-endothelial surface of the PVC tube, ischemia reperfusion because of aortic cross clamping; and the release of endotoxins (Ebadi et al. 2015; Warren, Smith, et al. 2009; Jofré et al. 2006; Hall, Stafford Smith, and Rocker 1997). These factors activate multiple humoral and cellular cascades (neutrophils, complement, coagulation and kallikrein) which contribute to the initiation of the immune system to release pro-inflammatory and anti-inflammatory cytokines and may ultimately trigger systemic inflammatory response syndrome (Figure 7).

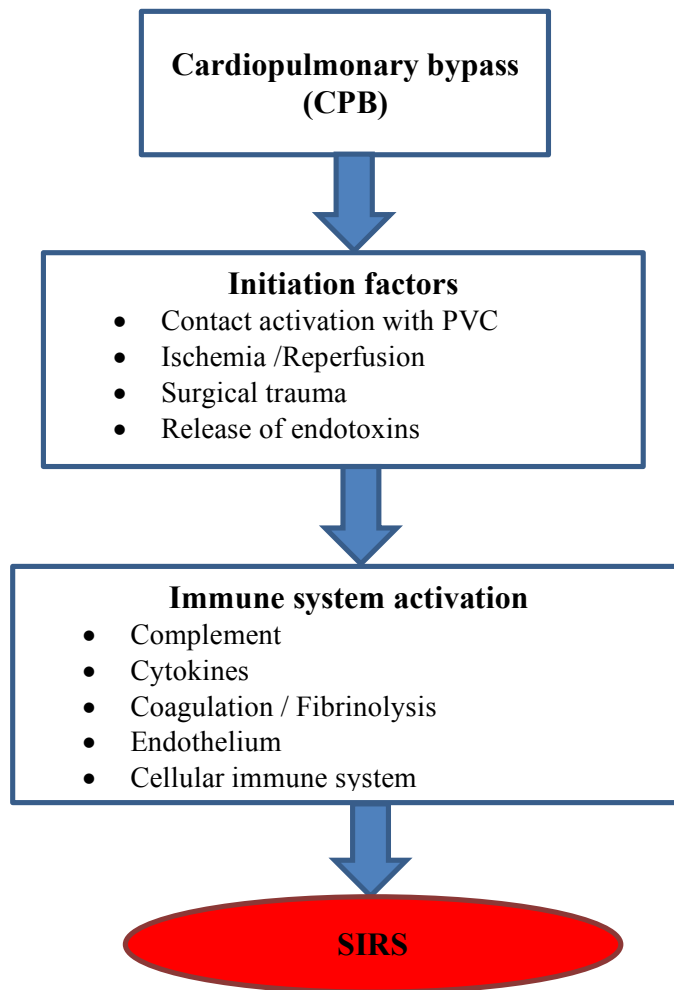

**Figure 7:** Schematic diagram of the sequences of events that lead to the development of systemic inflammatory response syndrome SIRS. Adopted from (Laffey 2002).

## 2.6 Potential trigger of inflammatory responses during CPB

### 2.6.1 Endotoxins

Endotoxins are one of the most potent known activators of innate immunity of the inflammatory response. The main source of endotoxins are the gram negative bacteria cell wall (Jaffer 2010; Ohri et al. 1991). Lipopolysaccharide molecules (LPS) are considered as the essential components of gram negative bacteria. The combination between LPS and other plasma proteins leads to stimulate the secretion of a series of pro-inflammatory cytokines such as IL-6 and TNF- $\alpha$ . Several studies demonstrated the strong correlation between the presence of endotoxins in the blood

and the post-operative complications. For example, a study on 100 patients with sepsis confirmed the presence of gram negative bacteria in 12% of those patients (Willatts, Speller, and Winter 1994). Riddington and colleagues stated that 40% of patients admitted for open heart surgery experienced increasing levels of endotoxins (Riddington et al. 1996).

### **2.6.2 Ischemia and reperfusion injury**

During cardiac surgery operations with the use of CPB, ischemia occurs because of the stopped circulation of blood to the living organs such as kidney, liver and brain. This triggers the secretion of unwanted substances from these organs to the blood which results in the formation of ROS (reactive oxygen species). The major source of ROS is neutrophils. It contributes to cellular damage, inducing of adhesion molecules and inflammatory cytokines (Den Hengst et al. 2010).

Reperfusion occurs when the blood return back to the living organs after a period of ischemia and lack of oxygen (Schofield et al. 2013). Following reperfusion, neutrophils mediate the vascular endothelium interaction with leukocytes that mediate the generation of poor post-operative outcomes (Angus et al. 2004). In addition, several studies demonstrated abnormalities of pro-inflammatory cytokines (IL-6 and TNF- $\alpha$ ) following reperfusion. TNF- $\alpha$  levels have been shown to increase following 3 hours of bilateral lower limb ischemia in rats and increased 1 hour after reperfusion (Yassin et al. 2002). Moreover, a clinical study performed on patients undergoing open heart surgery demonstrated that both TNF- $\alpha$  and IL-6 levels were increased following reperfusion (Edrees et al. 2003).

### 2.6.3 Oxidative stress

It is defined as the imbalance between the release of free radicals and the ability of the body to mitigate the harmful effects caused by these free radicals. It occurs when there is a significant uncontrolled secretion of reactive oxygen species (ROS). Inflammatory responses over CPB procedure trigger the secretion of ROS and the increase of oxidative stress. Also, pre-operative diseases such as diabetes may provoke the excessive secretion of oxidative stress and ROS (Giustarini et al. 2009). Haemolysis, ischemia, reperfusion and the activation of neutrophils during the use of CPB play a crucial role in the oxidative stress and stimulation of pro-inflammatory cytokines (figure 8) (Zakkar et al. 2015).

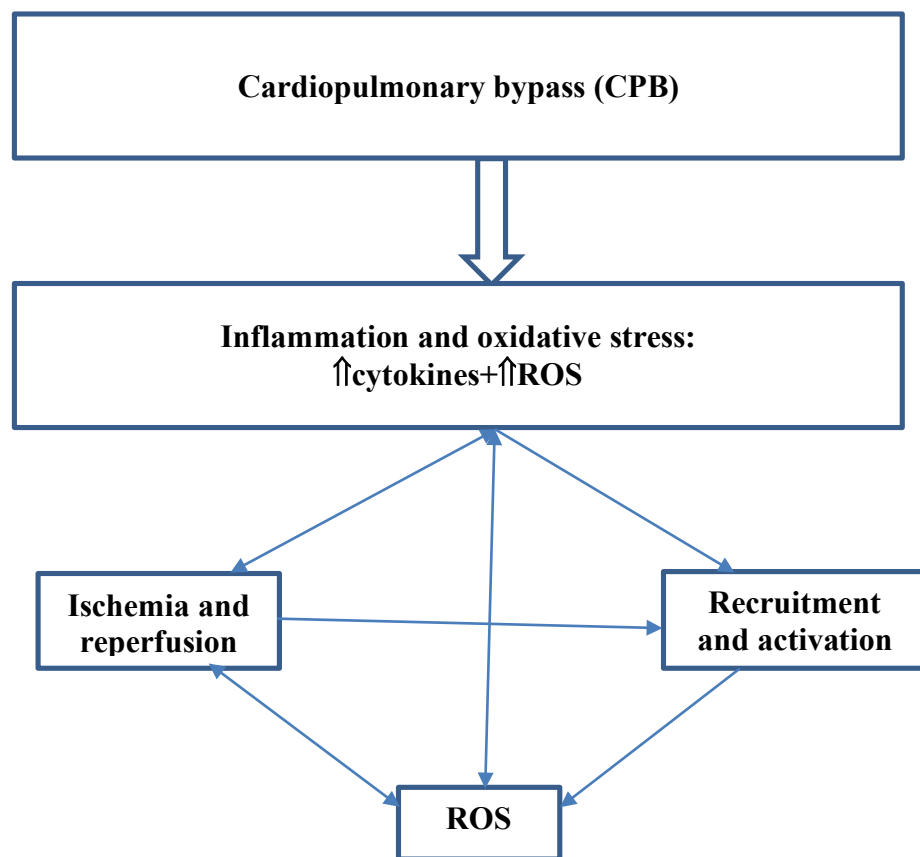

**Figure 8:**Inflammatory and oxidative stress during CPB. Adopted from (Zakkar et al. 2015).

#### **2.6.4 Anticoagulants**

Although anticoagulants such as heparin are considered as an important factor in the blood clot during the surgery, they can be associated with a number of complications post-surgery. A clinical study was conducted on 32 patients who were admitted for open heart surgery using CPB. 12 patients developed systemic inflammatory response syndrome whereas 20 patients had normal post-operative outcomes. The study investigated the relationship between heparin and the complications after the surgery. The result showed a strong correlation between the post-operative complications and reduced intraoperative heparin dose (Feindt et al. 2005).

#### **2.6.5 DEHP plasticised PVC and the trigger of inflammatory cascades**

Plasticised PVC is a blood contacting biomaterial. It is involved in widespread applications in the medical field such as storage bags, catheters and tubing. In the context of CPB, DEHP plasticised PVC tubes play a pivotal role in the initiation of different cellular and humoral inflammatory cascades (Gourlay et al. 2003). Several clinical studies reported the significance of DEHP plasticised PVC when it comes in contact with the blood. Takashi and colleagues conducted a clinical study on sixteen patients undergoing elective coronary artery bypass grafting. The patients were divided into two groups (group A had DEHP plasticised PVC tube in the CPB circuit and group B had non-DEHP plasticised PVC). Blood samples were taken before anaesthesia induction and after the termination of CPB. The study concluded that using non-DEHP plasticised PVC tube reduced the initiation of inflammatory cascades (Takahashi et al. 2008). Also, it was reported that the reduction of plasticizer surface of PVC lead to decreased fibrinogen adsorption (Zhao and Courtney 1999).

## 2.7 Cellular pathway of inflammatory responses

It involves endothelial cell (a type of epithelium that form an interface between blood and the vessel wall) and leukocytes.

Endothelial cells are activated by a variety of agonists such as cytokines, thrombin and C5a. IL-1 $\beta$  and TNF- $\alpha$  pro-inflammatory cytokines stimulate the expression of P and E selectins (proteins that mediate the migration of cells to sites of inflammation) within a short period of time (2-4 hours) (Etzioni 1996; Kraft et al. 2015).

### Leukocytes and endothelial cell interaction

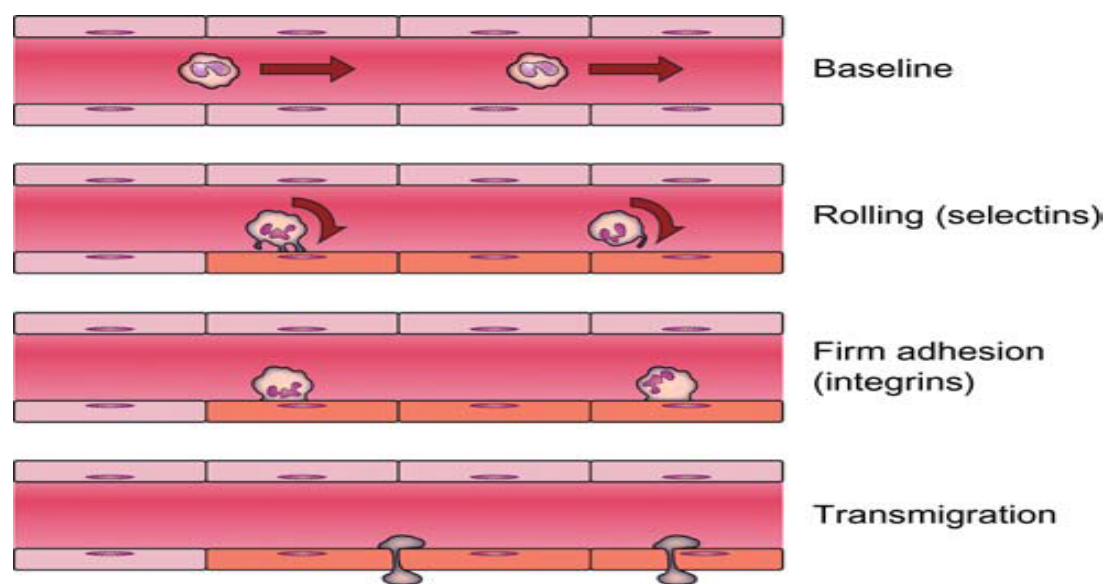

**Figure 9:** Adhesion molecules phases (Punjabi and Taylor 2013).

The movement of leukocytes, out of the circulatory system to the site of injury is known as leukocyte extravasation. This process occurs according to the following phases.

#### Phase 1: Attachment (early phase)

Resident Macrophages at the injured area releases pro-inflammatory cytokines ( such as IL-1 and TNF- $\alpha$ ) into the blood stimulating endothelial cell for adhesion process.

Both expression of intracellular adhesion molecule1(ICAM1) and vascular cell

adhesion molecule1(VCAM1) play a crucial role in the binding of leukocytes to the endothelial cells' surfaces and the initiation of trafficking to the extravascular space(Ley et al. 2007; Patel, Cuvelier, and Wiehler 2002)

### **Phase 2: Rolling of leukocytes**

This stage is stimulated by members of the selectin family-selectin L, selectin E and selectin P (Albelda, Smith, and Ward 1994). All selectins have a binding affinity (refers to the measurement of the strength attraction between receptor and ligand): oligosaccharide, polysaccharide and sulphate polysaccharide and lipids.

### **Slow rolling of leukocytes**

Following inflammation, the leukocytes rolling velocity decreases (average between 5 and 10 micrometers per second)(Jung and Ley 1999). Release of E selectin from the endothelial cell and CD18 integrins on the rolling leukocytes are essential to pursue this phase.

The aim of this phase is to promote the contact between leukocytes (neutrophils) and the endothelial cell which lead to further activation by chemokines and other pro-inflammatory cytokines (Muller 2013).

### **Phase 3: Firm adhesion**

After the rolling phase, leukocytes adhere to the blood vessels under a flow condition. The process starts from the releasing of chemokines by macrophages which promotes the activation of leukocytes on the endothelial cells surface. This mechanism also motivates and P and E selectins with integrins to upgrade and move from the low affinity binding with ligands to high affinity binding state (Muller 2003).

#### **Phase 4: Transmigration**

Leukocytes migrate across the barrier during the resting condition of the endothelium. This penetration of the basement membrane involves two mechanisms (mechanical force and proteolytic digestion of the membrane) (Sorokin 2010).

### **2.8 Humoral pathways of inflammatory responses**

Humoral immunity is defined as the aspect of immunity that is mediated by series of macromolecules such as cytokines, complement proteins and coagulation pathways.

#### **2.8.1 Complement system**

The word 'complement' refers to a set of proteins that cooperate with the immune system in order to eliminate blood and tissue pathogens. It represents one of the most powerful defense systems against any external and internal insult. Complement systems may act to bind and mediate the phagocytes while other complement proteins elicit the inflammatory response and induce the releasing of pro-inflammatory cytokines into the blood.



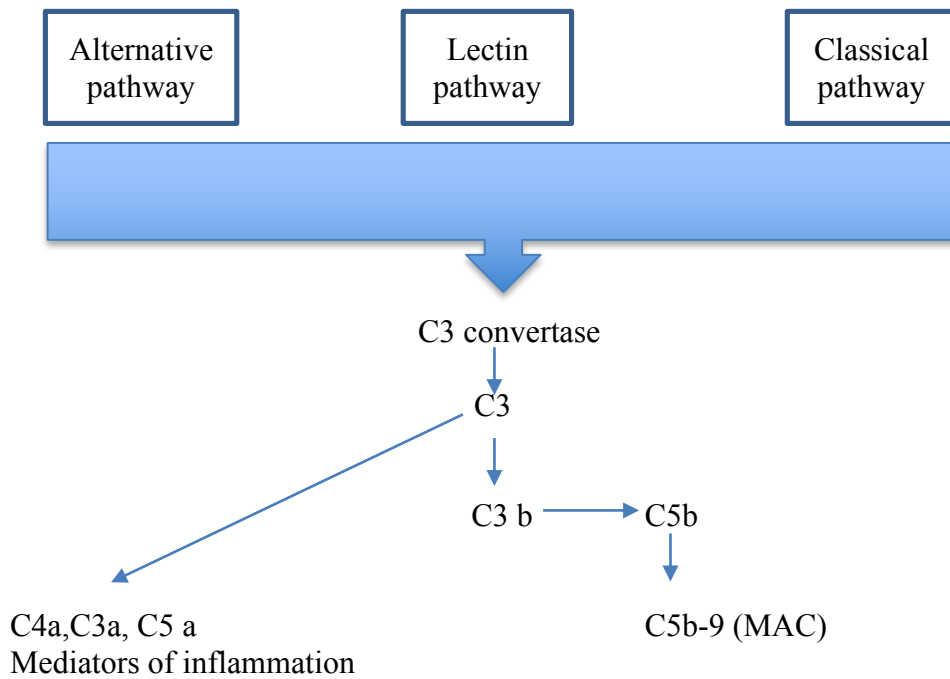

**Figure 10:** Complement system pathways. Adopted from (Thurman and Holers 2006).

The complement cascade is activated during CPB, ischemia-reperfusion and heparin neutralization with protamine (Laffey 2002). It is considered to be the early mechanism that triggers the acute inflammation phase and other inflammatory cascades. The activation of the complement system is performed via three different pathways (figure 10): classical pathway (activated by binding antibodies to antigens), alternative pathway (activated by the microbial cell surface) and lectin pathway, (activated by plasma lectin)(Day and Taylor 2005). Inactive form of the complement system, there are 9 components starting from C1-C9 while during the activation phase the number increased to over 20 cleavages.

Complement protein functions can be classified into seven groups, which are :

1. Initiator complement components: the protein initiates the complement cascade via binding to a specific soluble.
2. Enzymatic mediators.

3. Membrane binding components.
4. Inflammatory mediators: complement components enhance the supply of blood to the site of the injury via binding to the receptors in the endothelial cells. They also attract other cells to migrate and move to the injury site.
5. Membrane attack proteins.
6. Complement receptor proteins.
7. Regulatory complement components.

### **Complement Pathways**

These pathways lead to the cleavage of C3 convertase (Rittirsch, Redl, and Huber-Lang 2012). Alternative pathways play a role in the defense against the infection while the classical pathway is involved in the clearance of the pathogenic factor (Charchafieh et al. 2012).

As seen in figure 10, the classical pathway is initiated by antibodies binding to C1 and it is considered as part of the adaptive immune system. It leads to the formation of antigen-antibody complex C3 and C5 with the production of C3b and C5b. Moreover, the classic pathway produces the anaphylatoxins C3a and C5a.

The formation of anaphylatoxins play a crucial role in the acute inflammatory cascades such as vasodilation, leukocyte activation and adhesion molecule activation (Asimakopoulos 1999).

The activation of the alternative pathway is promoted and increased by the presence of a fungal and bacterial wall. It also depends on the change of specification of C3(Frank 1987). Alternative pathway leads to the formation of C3 convertase and C5. The two components join together to form the C5a and C5b. Further interactions occur to form finally the product C5b-9 which is called membrane attacking

complex(Tegla et al. 2011).The lectin pathway is activated by the binding of mannose-binding lectin (MBL) to mannose residues on the pathogen surface.

## 2.8.2 Coagulation – fibrinolytic cascade

### Coagulation mechanism

Blood coagulation refers to a series of processes to stop the bleeding (haemostasis) at the site of injury, and can be achieved via two main haemostasis phases primary and secondary (figure 11) (Palta, Saroa, and Palta 2014).

### Primary haemostasis

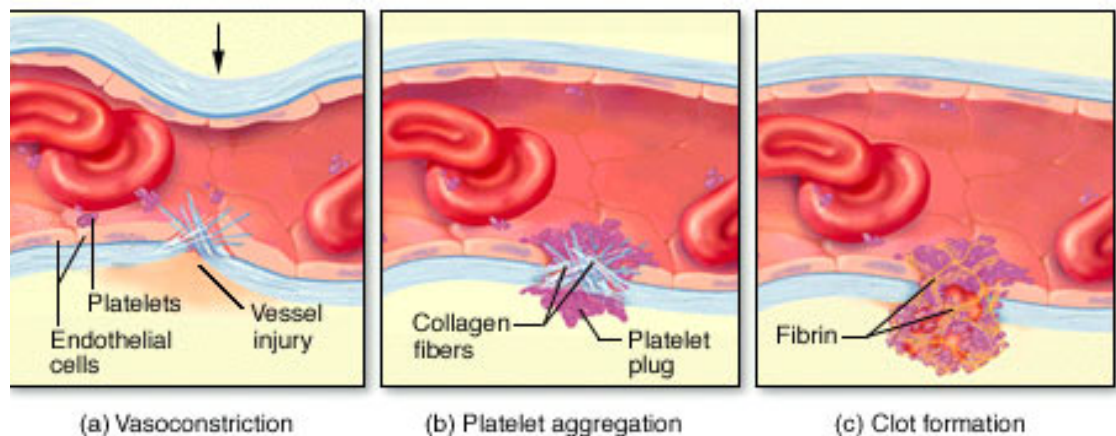

**Figure 11:**Primary and secondary haemostasis phases. Starting from vasoconstriction until clot formation. (Taken from (<http://intranet.tdmu.edu.ua/>))

### Vasoconstriction

Vasoconstriction is the first response to the stimulation at the site of injury. The vascular wall is constricted and reduce the blood supply to the site which is considered as an early stage of clot formation.

### Platelet plug

This is the second step in the clot formation. It is characterized by the platelets aggregation at the site of injury and stick together to initiate a series of activation process of forming fibrin.

## Secondary haemostasis

Following the primary phase, the secondary haemostasis is characterized by the continuation of many coagulation factors and platelets aggregation in order to form the clot.

## Coagulation pathways

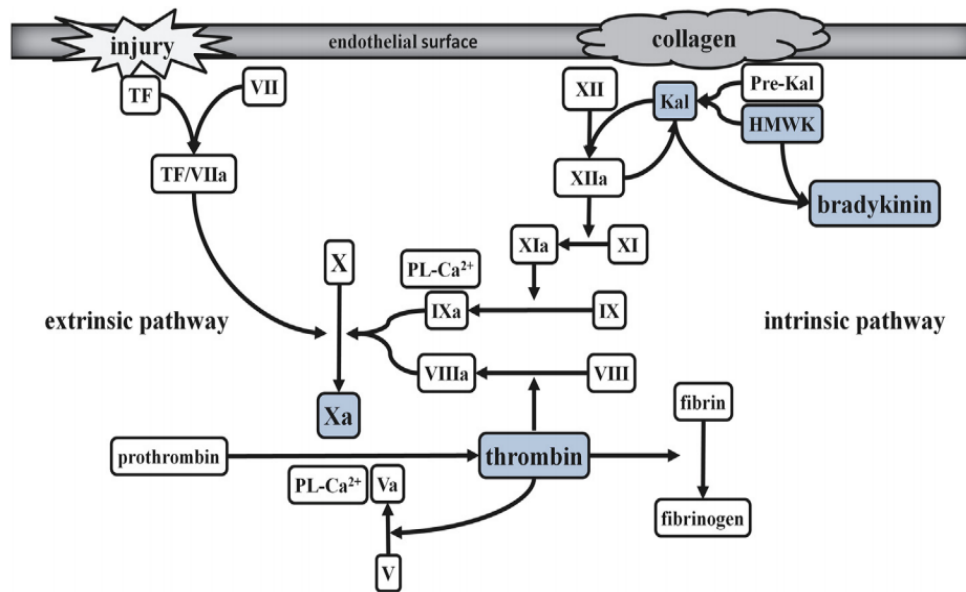

**Figure 12:**Coagulation pathways (intrinsic , extrinsic and common pathway) (Kraft et al. 2015).

This is classified into intrinsic and extrinsic pathways that finally lead to a common pathway resulting in the formation of fibrin (Figure 12). Firstly, the intrinsic pathway starts after contact activation between blood and the non-endothelial surface and is activated by trauma inside the vascular wall. It involves factor XII, XI, IX,VIII. Secondly, the extrinsic pathway (tissue factor) occurs following vascular wall trauma and is considered as quicker than intrinsic pathway and it involves factor VII. Finally, the common pathway combines intrinsic and extrinsic pathway in order to complete the process of clot formation. The common cascades activities of this pathway are factor I,II,V,X (Day and Taylor 2005).

### 2.8.3 Contact system

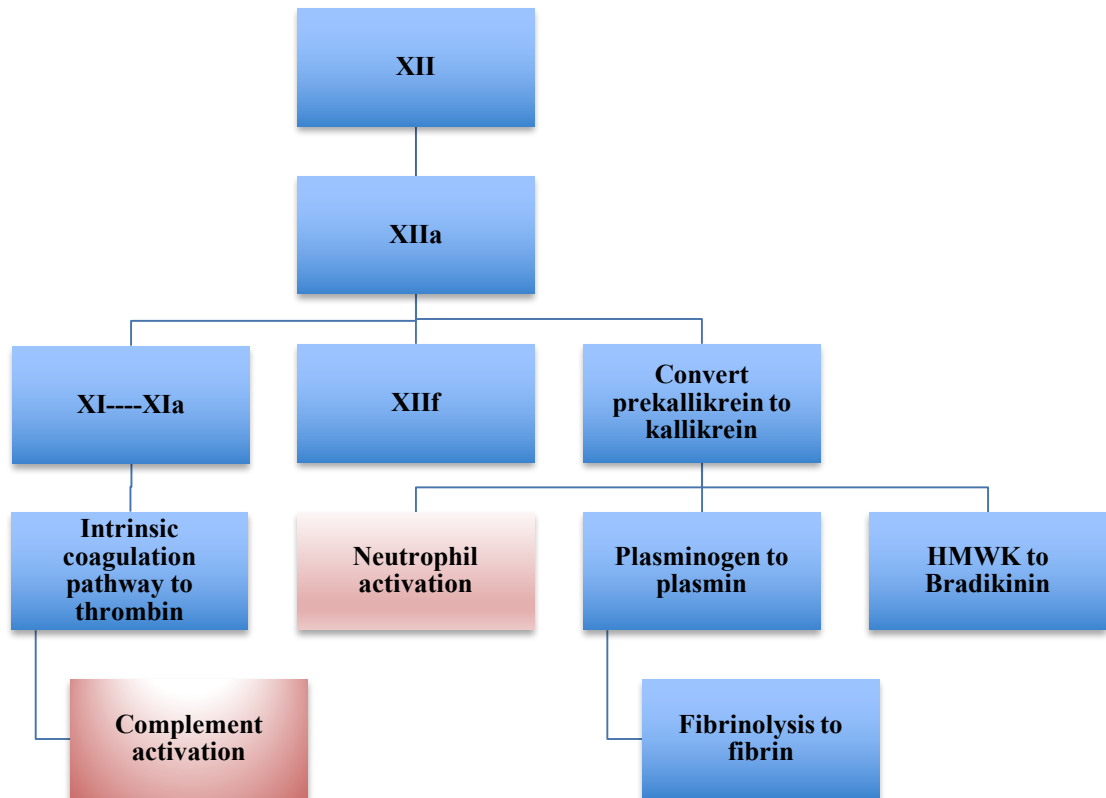

**Figure 13:**Contact system activation cycle.

The contact system contains four primary plasma proteins: Hageman factor XII, XI, prekallikrein and high molecular weight kininogen (figure 13). The activation of inflammatory mediators occurs when the patient's blood comes in to contact with the non-endothelial surface (DEHP plasticised PVC tube) of CPB. The activation leads to the production of XIIa and XIIIf. Factor XIIa plays a role in the initiation of the intrinsic coagulation pathway with other factors such as Hk and XI. The result from these activations is the formation of bradykinin that converts to kallikerin which is considered the initiator and a major mediator of the cellular components such as neutrophils(Lefkowitz 2008).

### **Factor XII (Hageman factor)**

Hageman factor is considered as an initiator of both inflammatory responses and the intrinsic pathway. The active form of factor XII converts prekallikrein to kallikrein and initiates the intrinsic coagulation cascade that leads to the formation of thrombin (Palta, Saroa, and Palta 2014).

### **Kallikrein –kinin system**

The kinins are protein groups of serum which are synthesized in the liver. These proteins enter the blood stream as inactive state called kininogens. In addition, there are two different forms of kininogens: high molecular weight and low molecular weight.

### **Activation of the kallikrein**

Following kallikreins activation, the tissue acts on the low molecular weight kininogens to release kallidin, that finally convert into bradykinin. This form of bradykinin attached to the receptors on the endothelial cells and secrete nitric oxide and prostacyclin which result in the releasing of the pro-inflammatory mediators.

### **2.8.4 Thrombin and plasmin**

Activation of the coagulation pathways trigger the generation of thrombin, which results from the thrombus formation. Plasmin is an important enzyme that degrades plasma protein into fibrin. Also, it is considered as the major fibrinolytic protease (Cesarman - Maus and Hajjar 2005).

Thrombin can initiate the immune system to release pro-inflammatory cytokines such as IL-6, TNF- $\alpha$  and IL-8 from the inflammatory cellular mediators monocytes, macrophages and endothelial cells. Plasmin cleaves C3 to form C3 convertase via the classical pathway.

### **2.8.5 Platelets and inflammation**

During CPB, platelets are activated by surgical trauma, hypothermia and heparinisation (Kraft et al. 2015). Once activated, their shapes and structures differ from the normal platelets.

Platelets activation play a crucial role in the development of the inflammatory cascades via inducing the inflammatory mediators such as cytokines. It induces upregulation of P selectin and integrin family which promote the leukocytes-endothelial cells interactions (Maugeri et al. 2006).

## **2.9 Cytokines and chemokines**

### **2.9.1 Chemokines**

Chemokines are small proteins responsible for the migration of WBCs throughout the body. The most important chemokine is CXCL8, which is produced in response to different chemical stimuli from the inflammatory cells (neutrophils, macrophages, dendrites cells and endothelial cells). It acts in the early stage of the inflammation and works as a chemoattractant for neutrophils to the injury site (Kobayashi 2007).

### **2.9.2 Cytokines**

Cytokines are soluble protein hormones and polypeptide that are secreted in response to stimuli. They are classified into three main groups: growth factors, lymphokines and colony stimulating factor. The source of cytokines are the inflammatory cells such as monocytes, macrophages, neutrophils and endothelial cells (Brix - Christensen 2001). Cytokines can be protective or damaging based on their concentrations, the cell type and the presence of other cytokines. In the context of cardiac surgery, the most important pro-inflammatory cytokines are IL-1, IL-6 ,IL-8 and TNF- $\alpha$  and anti-inflammatory cytokines IL-10 and IL-1ra (Brix - Christensen

2001). These cytokines can be measured in blood samples, and it can be detected in bronchoalveolar lavage (Brix - Christensen et al. 1998; Kotani et al. 2000; Doughty, Kaplan, and Carcillo 1996).

Pro-inflammatory cytokines act locally to increase vascular permeability during inflammation in order to recruit leukocytes to the site of infection. These cytokines also stimulate the production of neutrophils from the bone marrow, which contribute to the infection site and enhance the healing process. Conversely, anti-inflammatory cytokines such as IL-10, IL-12 and IL-4 are secreted in order to control the inflammation and inhibit the activation of macrophages that prevents pro-inflammatory cytokines activation (Zhang and An 2007).

This is essential for immunologic and physiologic homeostasis. Some cytokines are activated directly as a result of direct contact between the blood and CPB tubing and other cytokines are activated indirectly through thrombin, kallikrein and C5a (Day and Taylor 2005; landis 2009). Increased levels of pro-inflammatory cytokines are generally associated with poor post-operative outcomes. Paparella and colleagues stated that the elevations in the pro-inflammatory cytokines (IL-6, IL-8 and TNF- $\alpha$ ) after surgery and uncontrolled balance with anti-inflammatory cytokines (IL-10, IL-12) play a role in the development of whole body inflammation (Paparella, Yau, and Young 2002).

### **Cytokines and myocardial injury**

Complications associated with myocardial tissue are common after cardiac surgery, and more predictable in elderly patients and patients who are re-operated (Vinten-Johansen et al. 2007; Marchant et al. 2012).



The correlation between pro-inflammatory cytokines and the changes in the myocardial functions are well known. Myocardium plays an essential role in the production of TNF- $\alpha$  (Sablitzki et al. 1997). Excessive release of TNF- $\alpha$  contributes to stimulate the secretion of other cytokines (IL-1 and IL-6) and finally to cause myocardial injury (Fahim, Halim, and Kamel 2003). In addition, excessive circulation of pro-inflammatory cytokines in the blood during CPB may lead to the development of further complications such as organ failure and severe conditions resulting in death (Bown et al. 2001).

### **Time course of releasing cytokines in the blood after CPB cessation**

Several studies suggested that the fastest acting pro-inflammatory cytokines that appear in the blood are TNF- $\alpha$  and IL-1 and IL-6 (Meng et al. 2008; Brøchner and Toft 2009). They are secreted within 1 hour of CPB cessation. Peak values of these pro-inflammatory cytokines can be obtained within the period between 2 hours and 24 hours after CPB cessation. TNF- $\alpha$  activation reaches peak between 60-90 minutes and remains in the plasma for approximately 24 hours, whereas IL-1 reaches peak within 24 hours (Kan, Xie, and Finkel 1999; Socha et al. 2006; Meng et al. 2008), and IL-6 peak values can be detected after 1 hour and reaches peak within 6-24 hours (Royston 1997). Moreover, Giannoudis stated that IL-6 can be detected in the blood up to 5 days after the surgery (Giannoudis et al. 2008).

### **Pro-inflammatory cytokines**

#### **Interleukin 6 (IL-6)**

IL-6 is a 26 kDa glycoprotein consisting of 184 amino acids (Wojdasiewicz, Poniatowski, and Szukiewicz 2014). It is a sensitive inflammatory marker for the early and acute phases of inflammation (Wan et al. 1996) and, considered as the first

detectable cytokine in the plasma within 60 min after the trauma and the cessation of CPB (Ferguson et al. 1997). Also, its concentration begins to increase within 2-4 hours after the operation and reaches to peak within 6-24 hours (Royston 1997). Finally, it returns to the normal levels within 3 to 5 days.

IL-6 is considered a good predictor of clinical outcomes (Donati et al. 1998). Hauser and colleagues suggested a strong correlation between the serum levels of IL-6 and mortality rate after paediatric cardiac surgery (Hauser et al. 1998). In addition, a high level of IL-6 is associated with renal and hepatic failure after surgery (Kapoor and Ramachandran 2004; Jofré et al. 2006).

Previous studies have strongly suggested that IL-6, which is upregulated early in the immune response, is a subtle indicator of the propensity for patients to illicit a heightened immune response after open-heart surgery, and indeed it is a good prognostic indicator in these patients (Giannoudis et al. 2008). Moreover, Oda and colleagues investigated the effect of sequential measurements of IL-6 in the blood for systemic inflammatory response syndrome patients (SIRS). The study showed a strong significant correlation between high levels of IL-6 (peak value) and the maximum sequential organ failure assessment score (SOFA), and IL-6 levels with the lowest platelets count (Oda et al. 2005).

### **Interleukin 1 (IL-1)**

Interleukin 1 is a form of two polypeptides (IL-1 $\alpha$  and IL-1 $\beta$ ). It is secreted from different nucleated cells such as macrophages dendritic cells, neutrophils, central nervous system microglia and endothelial cells. Also, platelets may produce IL-1 (Thomson 1992). IL-1 is a pro-inflammatory cytokine that is produced at the site of the inflammation in response to trauma other inflammatory mediators. It is an

endogenous pyrogen (fever-producing substance) due to its essential role in fever induction. It is involved in the initiation of different cascades during the acute inflammatory phase by acting as a lymphocyte activating factor, a thymocyte proliferation factor and a monocular cell factor. Abnormality levels of IL-1 may play a role in the development of systemic inflammatory response syndrome(Wajant, Pfizenmaier, and Scheurich 2003).In addition, in the acute phase of the inflammation, it is secreted in a large amount earlier than other cytokines in the blood and appear in the circulation within 1 hour (Nyström 1998).However, it's half-life is 6 minutes (Ferguson et al. 1997).

### **Interleukin 8 (IL-8)**

IL-8 is produced by a response to the stimulation of both IL-1 and TNF- $\alpha$  (Tønnesen, Christensen, and Toft 1996).The production increases in the lungs following hypoxia (Kunkel et al. 1991). In addition, its level increases in the patient after surgery and is increased in patients who have septic shock(Van Devort and Danner 1990). Moreover, IL-8 post-surgery level is correlated with the duration of CPB and the occurrence of systemic inflammatory response syndrome (SIRS) (Kretzschmar et al. 1998; Rasmussen et al. 2007). IL-8 is considered as a controller of different chemoattractant activities for neutrophils and adhesion molecules phases (Ivey et al. 1995).

### **Tumor necrosis Factor (TNF)**

TNF is a potent inducer of IL-1 in different cells. This cytokine has two species: TNF- $\alpha$  and TNF- $\beta$ , which are produced by the activated macrophages and T lymphocytes (Bradley 2008). It plays a significant role in the regulation of systemic

inflammatory response syndrome via the control of leukocyte-endothelium interaction and the release free oxygen radicals (Jansen et al. 1990).

TNF- $\alpha$  reaches a peak between 60-90 min post-CPB (Kan, Xie, and Finkel 1999; Socha et al. 2006). Some reports demonstrated significant increase in TNF- $\alpha$  after release of cross clamping and cessation of CPB (Seghaye, Duchateau, Bruniaux, et al. 1996; Plötz et al. 1993). Nystrom reported that TNF- $\alpha$  is significantly higher and secreted in a large amounts in the blood within 1 hour after CPB termination (Nyström 1998). Conversely, other studies stated that TNF- $\alpha$  levels did not show any significant change with systemic inflammatory response syndrome patients (Finn et al. 1993; Wang et al. 1998).

### **C-reactive protein (CRP)**

CRP is secreted from the liver as a reaction to the stimulation of different inflammatory mediators such as IL-6 (Brøchner and Toft 2009). Clos and colleagues stated that the measurement of CRP is used to monitor the inflammatory status (Du Clos 2000). CRP is classified as an important cytokine in the prediction of inflammatory reactions with renal failure patients during the hemodialysis (Bergstrom et al. 1995). CRP normally circulates in the blood at approximately 0.8 mg/l in healthy people but in cases of acute phase stimulation, the level increases and reaches the peak within 48 hours (Pepys and Hirschfield 2003).

CRP can act as an anti-inflammatory cytokine due to its essential role in regulating PMN (polymorphonuclear neutrophils) chemotaxis (Mortensen and Zhong 2000; Zhong et al. 1998). Also, in clinical practice, it can be used as unspecific marker of infection and its plasma concentration correlates with the extended period of surgical trauma (Brix - Christensen 2001).

### **Interleukin 5 (IL-5)**

IL-5 is a pro-inflammatory cytokine secreted by mast cells (Plaut et al. 1989). B Cells are considered as other source of IL-5 (Paul et al. 1990). It plays a crucial role in the generation of cytotoxic T cells and eosinophils granulocyte activation during the inflammatory cycle (Zhou et al. 2010).

### **Interferon (IFN- $\gamma$ )**

Interferon is an important antiviral cytokine that plays a crucial role in regulating inflammation (Chalise et al. 2013). It is secreted by natural killer cells in response to the acute phase of inflammation. It leads to promote the natural killer activity and leukocytes migration in addition to stimulate macrophage activity (Schroder et al. 2004).

### **Interleukin 17A(IL-17A)**

IL-17A is secreted by Th17(T helper 17) cells. It stimulates IL-6 secretion and nitric oxide. High levels of IL-17A in the blood correlates with severity of the inflammatory response (Jin and Dong 2013).

### **Anti-inflammatory cytokines**

The human immune system is regulated by different cytokines. Anti-inflammatory cytokines may either control inflammation with pro-inflammatory cytokines or inhibit the immune system (Opal and DePalo 2000).

### **Interleukin 10 (IL-10)**

IL-10 is a cardioprotective cytokine acting as a suppressor to the immunological activities in the blood to maintain equilibrium status. IL-10 is produced from different cells such as TH2(T helper 2) lymphocytes, monocytes and neoplastic B cells (Jorens et al. 1992). It is a regulator cytokine in the blood which stimulates the secretion of

the IL-1 receptor antagonist (IL1-ra) and suppresses both IL-8 and IL-6 (Gastl et al. 1993).IL-10 plays a fundamental role in the diagnosis of systemic inflammatory response syndrome (SIRS) and sepsis patients. Montz study suggested that IL-10 level is correlated with the severity of disease (Montz et al. 1994). IL-10 showed a significant effect in the inhibition of TNF- $\alpha$  and nitric oxide, and this inhibition also suppressed neutrophils accumulation (Yang, Zingarelli, and Szabó 2000). Moreover, a study conducted by Rodriquez- Gasper showed a strong association between IL-10 as anti-inflammatory cytokine with TNF- $\alpha$  of patients who have fatal and worse outcomes (Rodríguez-Gaspar et al. 2001).

#### **Interleukin- 1ra (IL-1ra)**

IL-1ra is produced by monocytes and macrophages. It acts to block the functions of both IL-1  $\alpha$  and IL-1  $\beta$  by competitive inhibitor at the IL-1 receptor (Opal and DePalo 2000). In the context of CPB, IL-1ra plays a pivotal role in the controlling of the balance situation between pro-inflammatory and anti-inflammatory cytokines(McBride et al. 1995). In addition, Sikora's study on 37 burned children showed a significant association between IL-ra levels and the prognosis of systemic inflammatory response syndrome(Sikora et al. 2008).

#### **Interleukin 4 (IL-4)**

IL-4 is a pleiotropic cytokine (cytokine that affects the activity of other cell types) which leads to the activation of T helper cell differentiation (T helper is an immune cell plays a role in the adaptive immune system). It is a protein secreted from the mast cells and T helper cells, and its most important function is to block and inhibit the release of pro-inflammatory cytokines such as IL1, TNF- $\alpha$  IL-6,IL-8 and macrophage inflammatory protein (MIP)(Opal and DePalo 2000).

### **Interleukin12 (IL-12)**

IL-12 is anti-inflammatory immunoregulatory cytokine produced by antigen presenting cells (Chehimi and Trinchieri 1994; Beadling and Slifka 2006). Historically, IL-12 was identified as a product of a specific virus called Epstein barr virus and also was known as natural killer cell stimulatory factor (Horiuchi et al. 1999), it plays a crucial role in the regulating and managing the innate inflammatory responses at the site of injury by inhibition of inflammatory cascades and pro-inflammatory mediators (Hamza, Barnett, and Li 2010). Recently, IL-12 has expanded to include many cytokine members working under the same umbrella of IL-12. These cytokines are IL-23, IL-27, IL-35, and they all lead to innate development of Th1 cells(Brombacher, Kastelein, and Alber 2003; Beadling and Slifka 2006)

### **Interleukin 13 (IL-13)**

IL-13 is a potent modulator for human monocytes and B cells which is secreted by the stimulation of T lymphocytes. It is produced in order to suppress and regulate the production of TNF, IL-1, and IL-8. It is also suppresses the inflammatory injury of the lung(Lentsch et al. 1999).

### **Interleukin11(IL-11)**

IL-11 is 178 amino acid peptide cytokine secreted by different cells such as osteoblasts, fibroblasts and chondrocytes (Putoczki and Ernst 2010).This protein plays a crucial role in many cellular activities such as regulating macrophages differentiation, binding of antigen antibodies, the inhibition of lipoproteins lipase induces synthesis of the acute phase of protein and performing anti-inflammatory response during the inflammatory pathways(Dinarelo 1999). It is rarely detected in

the healthy subjects' serum(Schwertschlag et al. 1999),whereas it can be detected in patient who are developing inflammation and cancers(Zheng et al. 2001; Hanavadi et al. 2006).

## 2.10 Anti-inflammatory strategies to attenuate the inflammatory response

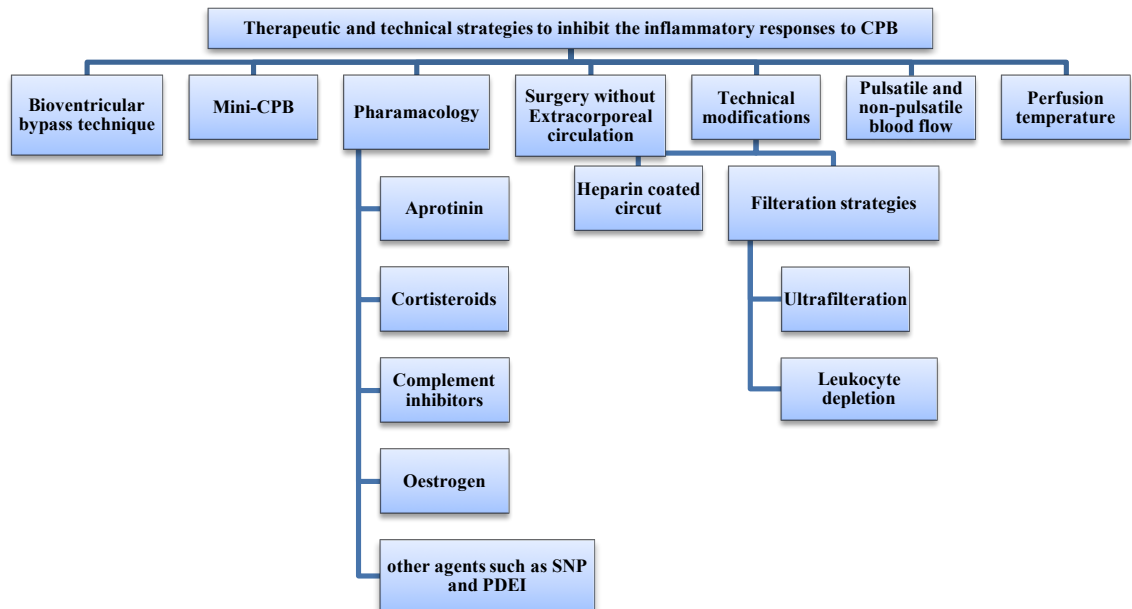

**Figure 14:**Anti-inflammatory strategies to attenuate inflammatory response to CPB.

Several therapeutic strategies have been used over the past 50 years to attenuate the poor outcomes that may result from using CPB. Current strategies are aimed to maintain a safe environment and less complications after the surgery (Figure 14).

Mechanical and technical modifications to CPB system include: hemofiltration, circuit miniaturization to reduce the priming volume and area of blood /tube contact, leukocyte filtration and heparin coated circuits.

In terms of the therapeutic agents, cortisteroids have been used for many years to attenuate the inflammatory response. Charette and colleagues demonstrated that the administration of steroids lead to the inhibition of inflammatory cells gene



transcription (Charette et al. 2008). In addition, aprotinin (Trasylol) is an effective drug that is used in most cardiac operations (Jansen et al. 1996).

Other potential pharmacological inhibitors include: complement inhibitors, antioxidants, phosphodiesterase inhibitors and NO donors (sodium nitroprusside). These techniques and therapeutic agents will be explained in details in the following sections.

### 2.10.1 Cantharidin blister model

Acute inflammatory response can be assessed by in vitro and in vivo methods. Several in vivo methods were developed in the last 20 years. These include systemic inflammatory reaction after endotoxin inhalation (Michel et al. 1997), negative pressure induced by a skin blister model (Follin 1999) and finally the novel cantharidin blister model (Day et al. 2001). The cantharidin technique is considered a quick and non-invasive technology that provides access to cells under the skin to investigate leukocytes trafficking and cytokines production at the site of injury.

The technique can be maintained for several days in order to characterize the innate of inflammatory responses (figure 15).

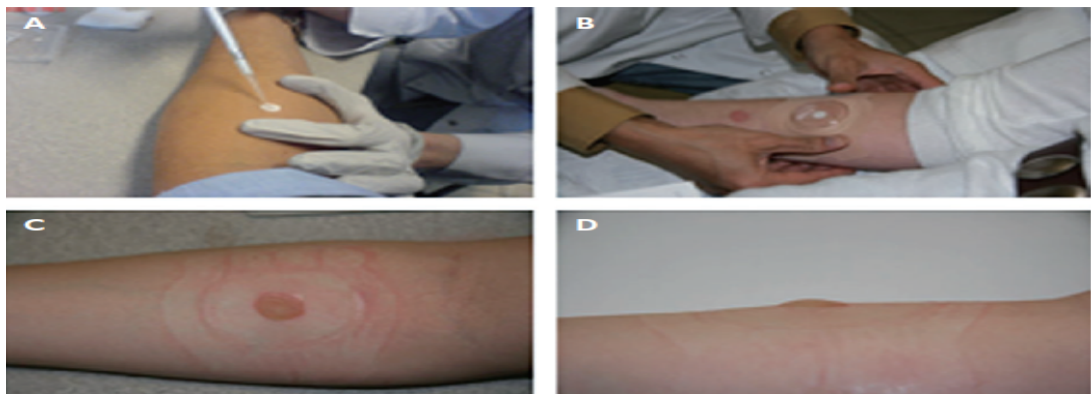

**Figure 15:** Cantharidin induced blister. (A) Placing a filter paper disc on the forearm after adding 25µl of 0.1% cantharidin solution to the disc. (B) Cover the disc. (C) by 24 h there is a significant inflammation. (D) Blister shape (Dinh et al. 2011).

### 2.10.2 Biventricular bypass technique (Drew-Anderson technique)

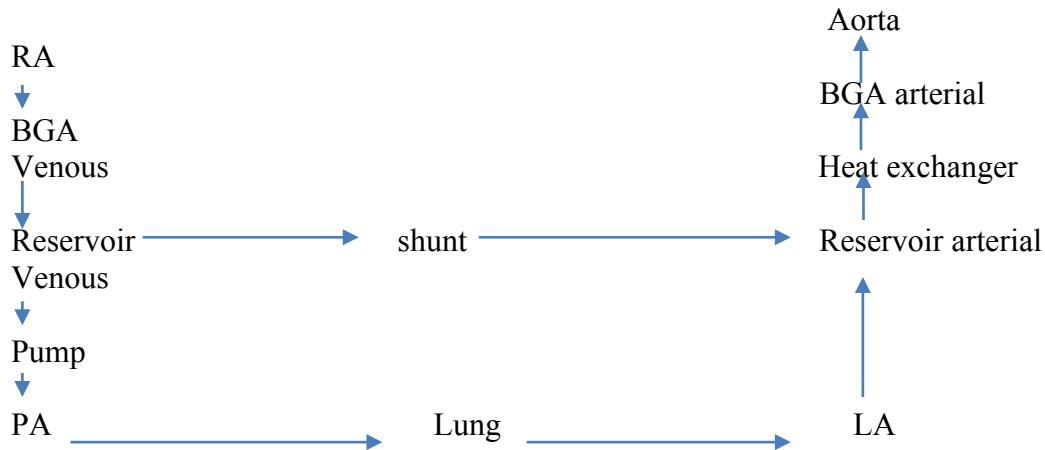

**Figure 16:** Drew-Anderson technique. (LA =Left atrium, PA= pulmonary artery, RA: right atrium, BGA=Blood-gas analysis. the concept is based on purifying the blood during the surgery in patient's own lung). Adopted from (Richter et al.2000).

The Drew-Anderson technique is a promising technology in the majority of cardiac operations particularly for high risk patients (Paparella, Yau, and Young 2002). The technique is based on using the patient's own lung instead of the oxygenators which may enhance the pulmonary functions over the surgery (figure 16). Several clinical and animal studies reported the benefits of Drew-Anderson technique. A study conducted by Mendler on dogs showed a significant improvement in the lung functions (Mendler, Heimisch, and Schad 2000). Richter and colleagues studied the effect of using Drew-Anderson technique on 30 patients. They reported the significant reduction in the circulating pro-inflammatory cytokines (IL-6 and IL-8), and increasing in IL-10 levels (Richter et al. 2000).

### 2.10.3 Mini-CPB techniques

Several manufacturers developed mini-cardiopulmonary bypass systems to reduce the implications of conventional CPB. These new small systems consist of: closed circuit, centrifuge pump, hollow fibre membrane oxygenators, suction and reduced

amount of membrane surfaces. The biocompatibility and the new design of mini-CPB (not including venous reservoir, the reservoir is the patients and entering air into the venous cannula is avoided) reduces thrombin formation and limits the development of poor complications after the surgery (Baikoussis, Papakonstantinou, and Apostolakis 2014). Moreover, reducing the circuit size leads to a significant reduction in the hemodilution (Hickey et al. 2006).

### **Minimized extracorporeal circuit (MECC)**

Minimized extracorporeal circuit is a promising technology in cardiac surgery. The results from many operations showed a significant reduction in the morbidity rates and lowers pre-operative mortality (Anastasiadis et al. 2013).

MECC consists of a shorter PVC tube in length (80-150 cm), a centrifugal pump and membrane oxygenators. A minimized circuit aims to reduce the priming volume and the contact area between the blood and PVC tube (figure 17). The major differences between CCPB and MECC are shown in below table (table 1).

<b>Conventional CPB(CCPB)</b>	<b>Minimized Extracorporeal circuit(MECC)</b>
PVC tube length is 160 cm-300 cm	PVC tube length is 80-150 cm
Prime volume 1700-2200 ml	Prime volume 450-500 ml
Platelets activation is lower due to the tube length	Platelets activation is higher due it the shorter tube length
Roller pump increase the zones of stagnant blood flow	Centrifugal pump reduces the stagnant blood flow
Blood reservoir increase the blood volume and increase the risk of triggering inflammatory cascades	No blood reservoir

**Table 1:** Differences between CPB and MECC. (Curtis, Vohra, and Ohri 2010).

Interestingly, MECC lead to greater improvements in the post-operative outcomes compared to CCPB (Anastasiadis et al. 2013). In terms of the mortality rates, there is no significant difference between the MECC and CCPB (Remadi et al. 2004; Stalder

et al. 2006). However, the cytokines concentrations such as CRP, IL-6 and TNF- $\alpha$  are lower with MECC than CCPB (Wippermann et al. 2005).

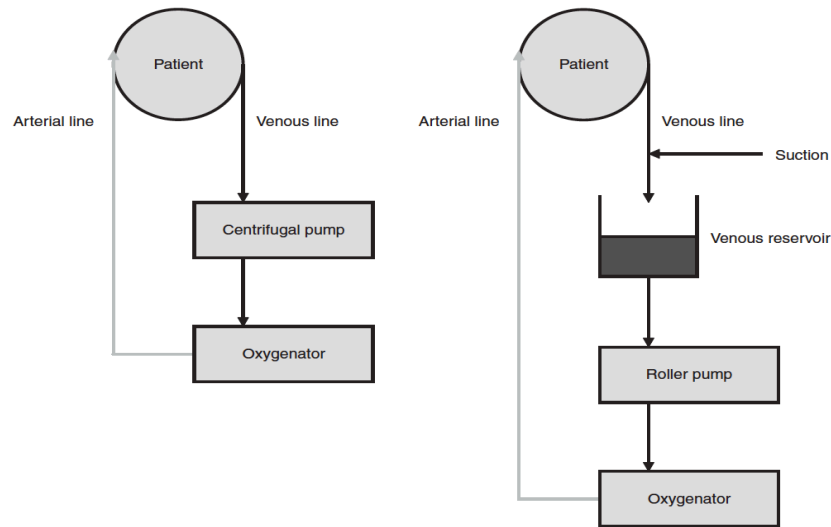

**Figure 17:** Schematic of the miniaturized extracorporeal circuit (MECC) on the left and conventional extracorporeal circulation (CECC) on the right (Vohra et al. 2010).

### **Minimal invasive extracorporeal circulation (MiECC)**

MiECC is an extracorporeal life support system used to perform coronary artery bypass graft procedures (Wiesenack et al. 2004). It consists of the same components of the mini-CPB which are biological inert contact surface, reduced prime volume, centrifugal pump, heat exchanger, membrane oxygenators, cardioplegia system, venous bubble trap, venous air removal and shed blood system (Anastasiadis et al. 2016).

Several studies have investigated the impact of the inflammatory responses with conventional cardiopulmonary bypass compared to the MiECC system. MiECC showed a significant reduction in the severity of systemic inflammatory response syndrome (Anastasiadis et al. 2016). This may be due to its coating and smaller circuit size that limits the initiation of inflammatory mediators in the blood.

MiECC deployment showed a strong association with IL-6 significant reduction after the surgery (Fromes et al. 2002; Immer et al. 2007; Liebold et al. 2002) and lower peak values of neutrophils elastase (a marker of the neutrophils activation) (Fromes et al. 2002; Abdel-Rahman et al. 2005; Ohata et al. 2007). A recent meta study on 24 studies stated that MiECC leads to decrease the mortality rate significantly rather than conventional cardiopulmonary bypass system (Anastasiadis et al. 2013).

### **Resting heart system (RHS)**

RHS is an integrated, closed loop system with low prime volume (600 ml) offering a minimum contact between blood and artificial surfaces of the circuit, with the rationale that it would lead to reduction of further complications post-surgery (figure 18). The system has a unique feature which is a detector that can detect smaller bubbles in the circuit (Benedetto et al. 2009).

A study conducted Kamiya and colleagues suggested that using resting heart system leads to decrease number of leukocytes in the blood after the operation and significantly reduced CRP levels after 72 hours (Kamiya et al. 2006).



**Figure 18:** Medtronic Resting heart system (Anastasiadis, Antonitsis, and Argiriadou 2012).

#### **2.10.4 Technique modifications for CPB**

##### **Heparin coated circuit (HCC)**

It has been established that the contact between the blood and non-physiological surface layer (PVC tube) during CPB is a mechanism that initiates the inflammatory response (Landis 2010). Coating the CPB surface with biocompatible materials showed a significant improvement in the clinical profile. Several materials have been coated to the CPB tube including heparin, synthetic proteins and phosphorylcholine. However, heparin is the most widely coated material used which mimics the endothelial surface that contains heparin sulfate (Apostolakis et al. 2010).

Heparin has an anti-inflammatory role (Tyrrell et al. 1998). Nelson and coworkers stated that heparin can inhibit the adhesion molecules via blocking the activity of P and L selectins (Nelson et al. 1993). IL-6 and IL-10 levels were significantly reduced with heparin coated circuit (Giomarelli et al. 2000).

Commercially, there are two heparin coated methods: firstly, the Duraflo II heparin coated circuit from Baxter company, which uses ionic bonded unfractionated heparin. This reduces complement activation but is not efficient in inhibiting the coagulation pathways. Secondly, the Carmeda bioactive system from Medtronic which is based on the end attached bonded heparin and considered a more efficient method than Duraflo in terms of the regulation of both complement and coagulation cascades (Lundblad, Moen, and Fosse 1997; Baufreton et al. 1998).

##### **Perfusion Temperature**

It is well established that inflammatory mediators are affected by the temperature (Birdi et al. 1999). Normothermic CPB increases the release of cytokines, cellular

and soluble mediators of inflammation, whereas hypothermia reduces the production and release of these mediators during the operation(Fairchild et al. 2000).

### **Pulsatile and non-pulsatile blood flow**

Several studies reported the importance of pulsatile flow rather than non-pulsatile flow in terms of decreasing adhesion molecules and attenuating inflammatory responses after the termination of CPB(Haines et al. 2009; Sievert and Sestino 2012). The key behind this is the improvement of microcirculation and diffusion between cells (Poswal et al., 2004). Neil and colleagues measured the microcirculation levels for 20 patients who were admitted to London Health Sciences Centre between August 2008 and April 2010 for CABG surgery. The results suggested that pulsatile flow is better than non-pulsatile flow in terms of attenuating the inflammatory responses (O'Neil et al. 2012).

### **Filtration techniques**

#### **Ultrafiltration**

CPB deployment leads to hemodilution (Warren, Watret, et al. 2009). Hemodilution is triggered by the excessive accumulation of fluids and the body water after CPB termination, which is caused by the returning of diluted blood back to the patient.

Hemodilution can be reduced by using ultrafiltration techniques. In north America, around 75% of cardiac operations deploy ultrafiltration techniques (Groom et al. 2005). There are three integrated ultrafiltration techniques with CPB, which are: conventional ultrafiltration technique (CUF), modified ultrafiltration filtration technique (MUF) and zero-balance ultrafiltration(Wang, Palanzo, and Ündar 2012). These techniques are widely different but they have the same benefits in the removing of the excess free water and inflammatory mediators such as pro-

inflammatory cytokines (IL-6, TNF- $\alpha$ , IL-8) and complement cascades (Mahmoud et al. 2005).

Conventional ultrafiltration techniques (CUF) are commonly used for paediatric CPB operations to maintain moderate hemodilution. The inlet line of this filter is connected to the arterial line and the outlet to the venous reservoir. The filtration process is started after the rewarming phase of bypass (Maluf 2003). This technique showed a significant impact in the reduction of circulatory inflammatory cytokines and reduced need for blood transfusions (Journois et al. 1996). Additionally, many clinical benefits were reported such as improving cardiovascular performance (Bog'a et al. 2000) and increasing the haematocrit (Kiziltepe et al. 2001).

Modified ultrafiltration technique (MUF) was developed by Naik and colleagues (Naik, Knight, and Elliott 1991). This filtration process is deployed after CPB termination. The filter is positioned in the bypass circuit. The inlet line is placed close to the arterial cannula and the outlet line is kept free in a sterile tube to be inserted into the right atrium. MUF filter is considered as a safe and reliable technology which achieves hemoconcentration, lower blood loss and significant reduction in post-operative bleeding (Torina et al. 2010; Pérez-Vela et al. 2008). Kiziltepe and colleagues found that the combination between CUF and MUF is effective and more safe for adult patients (Kiziltepe et al. 2001).

A third ultrafiltration method is called zero-balance which is similar to the conventional ultrafiltration. It is usually performed after rewarming phase (Wang, Palanzo, and Ündar 2012). A clinical study conducted by Tallman and coworkers demonstrated the efficacy of zero-balance ultrafiltration during CPB in the removal of inflammatory mediators (Tallman, Dumond, and Brown 2002).



## **Leukocyte depletion**

The first leukocyte depletion filter was created by Pall company (LG6B; Pall Biomedical Products, East Hills, NY) in 1991 (Boodram and Evans 2008). State-of-the-art leukocyte depletion filters are classified into four groups: leukocyte filters in the arterial line, leukocyte filters in the venous line, leukocyte filtration of blood cardioplegia and leukocyte filters of the suction blood (Matheis et al. 2001). These filters aim to protect heart and lung from any damage via the attenuation of neutrophil activation and inflammatory cytokines (Di Salvo et al. 1996; Gu, Boonstra, and van Oeveren 1996; Gu, De Vries, et al. 1999).

A series of animal and human studies were conducted to determine the significant effect of leukocyte depletion filter in the improvement of post-operative outcomes.

Animal models have shown significant beneficial outcomes from using leukocyte depletion filters. A comparison study was performed between isolated rabbit heart in order to assess a leukocyte depletion filter efficacy in reperfusion rates and reduction of inflammatory mediators in the blood. The first group was perfused with whole blood while the second group was perfused with the leukocyte depletion filter. The results showed higher recovery rates in the second group and better outcomes in terms of the removal of pro-inflammatory cytokines and other mediators (Sawa et al. 1994). In addition, in pigs, the technique showed a significant reduction in ischemia injury when it was deployed before cardioplegia arrest (Lazar et al. 1995).

From the clinical point of view, studies evaluated the leukocyte depletion filter to investigate its performance during CPB in terms of reducing the circulating inflammatory cytokines and the morbidity rate. It was reported by Sawa and colleagues that leukocyte depletion filter attenuate reperfusion injury during cardiac

surgery (Sawa and Matsuda 2001). Another study was conducted on 32 patients undergoing elective cardiac surgery, and confirmed the noteworthy effect of leukocytes depletion filter in the reduction of IL-8, P selectin and ICAM-1(Chen et al. 2004).

Leukocyte depletion filter appears to improve post-operative respiratory outcomes after CPB, particularly with patients who have low pre-operative oxygenation before the surgery (Morioka et al. 1996; Sheppard, Gibbs, and Smith 2004; Johnson et al. 1995). This improvement reduces the ventilation time and the intensive tension unit length of stay (Ohto, Yamamoto, and Nakajima 2000).

### **2.10.5 Surgery without extracorporeal circulation**

#### **Off pump coronary artery bypass (OPCAB)**

OPCAB has been used in cardiac surgery since 1964 (Kolessov 1967). Operating while the heart is beating is the safest approach to avoid post-operative complications and unwanted implications (Uyar et al. 2014). There is no contact between blood and non-endothelial surface tubes and the degree of ischemia and reperfusion are less than CPB. The trigger of inflammatory cascades and production of pro-inflammatory cytokines are less than other surgical approaches (Rasmussen et al. 2007).

A series of clinical studies were focused on measuring the difference between using CABG surgery with or without CPB. Patients who underwent OPCAB had less circulating TNF- $\alpha$  and IL-8 with less production and activation of other inflammatory mediators (Asimakopoulos 2001; Biglioli et al. 2003).

Avoiding CPB improves the post-operative outcomes. IL-6 levels remain consistent in patients with and without CPB and other inflammatory mediators such as the complement system(Tarnok et al. 1999; Gu, Mariani, et al. 1999). These findings

suggest that modulating the inflammatory response during cardiac operations is possible with or without CPB deployment.

Despite the benefits of using OPCAB, there are also some disadvantages in using this technique, such as:

1. The connection of the graft to the coronary artery is more difficult due to movement of the heart.
2. A myocardial stabilization device must be used with the off pump.
3. The surgeon may have to perform many bypass grafts due to the heart moving (Peter and Suyker 2002).

### **Minimally invasive cardiac surgery (MIDCAB)**

Minimally invasive cardiac surgery techniques have been introduced into the cardiac surgery field over the last few decades which have been shown to decrease pain and surgical trauma (Walther et al. 1999). Performing surgery without opening the sternum or the chest contributes to minimizing inflammatory responses. Incisions can be made using central aortic cannulation or peripheral cannulation via the femoral or axillary artery, although the disadvantage of an incision via the femoral artery is an increased risk of stroke (Gammie et al. 2010).

As seen in figure 19, MIDCAB does not require opening the sternum and placing 10-12 incisions at the end of the operation. It requires a small incision between the ribs with 3-5 incisions. This technique has many advantages such as shorter time of recovery and hospital stay, few complications and implications after operation, less bleeding and low risk of infection (Iribarne et al. 2011).

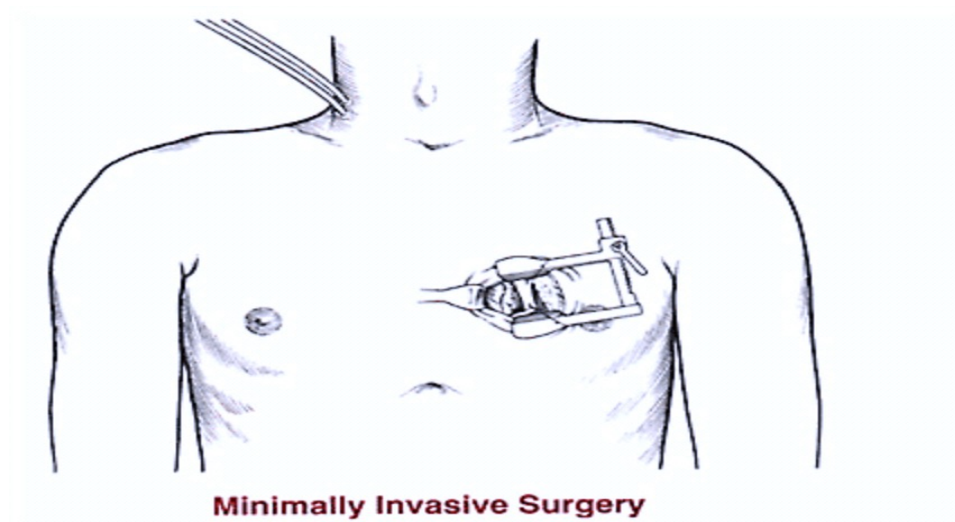

**Figure 19:**Minimally invasive incision.(Taken from (<http://www.cts.usc.edu/hpg-midcab.html>)).

### **Multivessel grafting**

Multivessel grafting is an approach used during off-pump technology. This involves an incision through the sternum that allows surgeons access to all vessels. Several studies stated its efficacy in the elimination of developing inflammatory response during the surgery (Benetti et al. 1991; Buffolo et al. 1996).

### **2.10.6 Pharmacological agents**

#### **Aprotinin**

Aprotinin (trade name trasylol) is defined as a nonspecific serine inhibitor (bovine version of the small protein basic pancreatic trypsin inhibitor). For more than 30 years, surgeons have used aprotinin as an anti-fibrinolytic agent in cardiac surgery due to its role in stopping bleeding and inhibiting inflammatory responses by regulating both cellular and humoral inflammatory cascades that lead to SIRS (Royston 1996; Englberger et al. 2002; Hill et al. 1995).

In terms of the suppressing activities of aprotinin, it can decrease concentrations of both IL-6 and IL-10 after the cardiac operation (Tassani et al. 2000). Also, the cellular

interaction activation between neutrophils and endothelial cells are decreased (Asimakopoulos et al. 2000). Aprotinin suppresses the production of IL-8 during CPB and reduces both neutrophils accumulation and adhesion molecules (Hill, Whitten, and Landers 1997). In terms of drug dosage, it has been reported that a full dose of aprotinin contributes to improving the anti-inflammatory responses after CPB termination (Brown et al. 2009). This response is characterized by activating the anti-inflammatory cytokines specifically IL-10.

Despite all of the above advantages of aprotinin, there are some arguments regarding the deleterious outcomes from the excessive using of aprotinin such as blocking of blood vessels, stroke, renal failure and saphenous vein graft closure (Mangano, Tudor, and Dietzel 2006).

### **Corticosteroids**

Corticosteroids have long been used in cardiac surgery to suppress the impact of inflammation associated with cardiac surgery (Paparella, Yau, and Young 2002). The well-known corticosteroids used in the clinical and surgical field are methylprednisolone and dexamethasone. Basically, steroids can inhibit the phospholipase activation and lead to improve myocardial function (Engelman et al. 1989). They act to reduce the damaging effect of pulmonary and myocardial activities after the termination of CPB (Wan, LeClerc, and Vincent 1997).

Glucocorticosteroids can suppress inflammatory cascades specifically, in the cases of chronic inflammation (Coutinho and Chapman 2011). The suppression is achieved by activating anti-inflammatory genes and inhibiting the pro-inflammatory cytokines in the blood (Barnes 2011). Administration of glucocorticosteroids prior to the surgery suppresses the complement activation system and attenuates the production of the

common pro-inflammatory cytokines such as TNF- $\alpha$ , IL-6 and IL-8 (Andersen et al. 1989). Furthermore, methylprednisolone before the surgery produces a significant reduction in the IL-6 and IL8 levels (Kawamura et al. 1995).

Several studies have found that steroid administration during OHS with CPB reduces inflammatory responses via inhibition the humoral and cellular cascades (Kozik and Tweddell 2006; Levy et al. 1998). This improves patient post-operative outcomes and reduces ITU length of stay (Yilmaz et al. 1999). Wan and colleagues stated that the best time of steroid administration is prior to the surgery (Wan et al. 1996)

### **Complement inhibitors**

The central role of the complement system in the acute inflammatory response to CPB provides sufficient rationale for its inhibition. The anaphylatoxins and C5b-9 are direct mediators of the inflammatory response, and C5a is the principal agonist for activating neutrophils, and is a potent chemoattractant for neutrophils, monocytes, macrophages, eosinophils, basophils, and microglial cells.

During cardiac surgery, the complement system induces the release of cytokines and chemokines leading to damage to tissues and organ dysfunction. The severity of post-operative outcomes is correlated with the activation levels of the complement system (Amara et al. 2008). Hence, the demand for complement inhibitors increased over many decades. Researchers and pharmaceutical manufacturers developed multiple types of inhibitors that can lead to blockages of complement system activation during surgery. Some examples of the most common inhibitors are shown in table 2.

<b>Complement inhibitor</b>	<b>Mechanism of action</b>
Complement activation blocker -2 (CAB-2)	Inhibit C3 and C5 convertase
Soluble complement	Inhibit C3 and C5 convertase
Factor D antibody	Inhibit alternative pathway
Properdin antibody	Inhibit stabilization of C3
C5 antibody	Inhibit C5 activation
Compstatin	Inhibit C3 activation

**Table 2:** Complement inhibitors (Franco and Verrier 2003).

## **Oestrogen**

Oestrogen are a group of steroid hormones that play a crucial role in maturation development and maintenance of female characteristics. Women have significantly lower rates of mortality and infection compared to men (Oksuzyan et al. 2008). This rate slightly changes in case of inflammatory response during CPB (Straub 2007). Dulos and colleagues introduced oestrogen in rats and investigated its ability to suppress the inflammatory response. The results showed a significant decrease in the circulating pro-inflammatory cytokines such as TNF-  $\alpha$  (Dulos et al. 2010).

## **Phosphodiesterase inhibitors (PDEI)**

Phosphodiesterase inhibitors are therapeutic agents with an anti-inflammatory action. PDEIs include amrinone, milrinone and pentoxifylline. All those inhibitors play a crucial role in the suppression of inflammatory mediators, pro-inflammatory cytokines in the blood and the cellular activation such as adhesion molecules (Banner et al. 1996).

Numbers of studies have demonstrated the effect of all PDE inhibitors in the cytokines levels. Takeuchi and colleagues introduced amrinone to a group of rabbits to determine its role in the controlling of TNF- $\alpha$  and IL-1 levels. They reported a significant suppression of these cytokines (Takeuchi et al. 1999). Another animal study on mice by Nemeth proven the inhibition effect of this drug on the of IL-6 and IL-10 concentrations (Németh et al. 1997).

Milrinone is another agent that inhibits the action of inflammatory cytokines. It is characterized by the elevating of adenosine levels in the blood. It has been recommended to administer this agent before CPB in order to achieve a successful inhibition of the cytokines (Hayashida et al. 1999).

Pentoxifylline is a non-specific inhibitor with anti-inflammatory effects. It has an attenuation effect on the neutrophils elastase, C- reactive protein and inflammatory cytokines (IL-6, IL-8 and IL-10) in elderly people who are undergoing CPB (Boldt et al. 2011). This inhibitor plays a key role in the attenuation of many inflammatory activities and inflammatory cytokines such as TNF- $\alpha$ , neutrophils activation with endothelium and decreases the release of endotoxins.

### **Sodium nitroprusside (SNP)**

As stated earlier, pro-inflammatory cytokines and endotoxins promote inducible nitric oxide (iNO) production. The administration of NO suppresses the activation of pro-inflammatory cytokines which result in the inhibition of iNO (Kessler et al. 1997).

SNP is NO donor. It is a potent and effective anti-inflammatory therapeutic agent. It was discovered in 1850, and its first therapeutic use was reported in 1951 (Drover et al. 2015). It plays a key role in the suppression of hypertension and inflammatory mediators. Several studies elucidate its significant impact in the inflammatory response with the use of CPB. Seghaye and colleagues administered SNP on 16 children undergoing CPB, and the results showed a significant reduction in the complement activation (Seghaye, Duchateau, Grabitz, et al. 1996). A study conducted by Massoudy and colleagues confirmed the inhibitory effect of SNP in the IL-6 and IL-8 concentrations (Massoudy et al. 1999). Also, in clinical profile, the



administration of SNP during CPB leads to a significant reduction in neutrophil accumulation, complement system components and the number of white blood cells (Massoudy et al. 2000).

### **Anti- cytokine monoclonal antibodies**

Monoclonal antibodies are the newest agent introduced into cardiac surgery in order to attenuate the deleterious effects of inflammatory responses after the surgery (Dybdahl et al. 2002). This agent is developed in order to suppress the activity of the common inflammatory cytokines (TNF- $\alpha$ , IL-1 and IL-8)(Waykole et al. 2009).

In the context of cardiac surgery, the administration of this agent during open heart surgery showed a significant reduction in the pro-inflammatory cytokines. A study conducted by Gurevitch and colleagues investigated the effect of monoclonal TNF-  $\alpha$  on rats. The results showed a significant reduction in TNF-  $\alpha$  levels, and improved post-clinical outcomes (Gurevitch et al. 1997).

### **Free radical scavengers and antioxidants**

Reactive oxygen species such as hydrogen peroxide and hydroxyl radicals are generated in the blood upon reperfusion following CPB surgery. It plays an essential role in tissue injury(Barta et al. 1990). Raja and colleagues demonstrated the importance of free radical scavengers such as enzymatic scavengers and antioxidants in the control of inflammatory responses after CPB (Shahzad G Raja 2005).

### **High dose Vitamin C and Vitamin E**

Vitamin C and vitamin E are antioxidants agents given to the patient prior to cardiac surgery. A high dose of vitamin C decreases the cell membrane's lipid peroxidation, improves the hemodynamics and reduces length of hospital stay following surgery (Dingchao et al. 1994; Barta et al. 1990). Vitamin E reduces the plasma concentration

of hydrogen peroxide and decreases cells' membrane lipid peroxidation which result in the inhibition of inflammatory mediators (Cavarocchi et al. 1986; Barta et al. 1990).

### **Mannitol**

Mannitol is a hexhydric alcohol related to the mannose group. Due to its physicochemical characterizations, it causes a fluid shift from the intracellular side to the extracellular side, causing to dehydration of the tissue (Cavone et al. 2012). In the clinical context, mannitol plays an essential role in the management of inflammatory mediators during cardiac surgery. Ziegeler and colleagues evaluated the ability of mannitol to modulate immunosuppression after CPB. They administered mannitol on forty-five patients and the results showed a significant suppression of the inflammatory cascades (Ziegeler et al. 2009).

### **Cyclooxygenase inhibitors**

Aspirin is a non-steroidal anti-inflammatory drug (NSAID) used in the majority of cardiac operations as a pain killer and antiplatelet activator. The common version of the non-steroidal anti-inflammatory drug is called indomethacin. This traditional drug inhibits two types of cyclooxygenase (COX-1 and COX-2). A group of nonspecific COX inhibitors increase the pulmonary vascular resistance and acute lung dysfunction with CPB (Cave et al. 1993; Shafique et al. 1993).

Studies have demonstrated its direct effect in decreasing post-operative fever and chest pain after CPB termination (Heindl and Becker 2001; Möbert and Becker 1998).

## **N-Acetylcysteline**

A high dose of N-Acetylcysteline inhibitor before or during CPB reduces the activation of both neutrophils and pro-inflammatory cytokines. N-Acetylcysteline improved the oxygenation and did not produce any negatively impact of the acute respiratory distress syndrome (Shahzad G Raja 2005).

### **2.11 CPB's post-operative complications**

#### **2.11.1 Postcardiotomy syndromes**

Postcardiotomy syndrome is an autoimmune response against damaged cardiac tissue. The first description was in 1953 for a patient having a closed mitral commissurotomy (Soloff et al. 1953). Three years later, surgeons realized that the syndrome can result from the valvetomy and can be treated by cortisone. Then, it was recognized that the trauma was a part of the syndrome and the reactivation of the fever was not the cause of the syndrome (Larson 1957; Lisan, Reale, and Lokoff 1959).

Postcardiotomy is developed within a week to six weeks after the surgery and characterized by high fever, chest pain and dyspnoea(difficulty breathing)(Scarfone, Donoghue, and Alessandrini 2003).The standard treatment for postcardiotomy syndrome is the administration of non-steroidal anti-inflammatory drugs that lead to inhibition of disease progression of the diseases (Eguchi et al. 2010).

#### **2.11.2 Acute respiratory distress syndrome (ARDS)**

Acute respiratory distress syndrome (ARDS) is defined as a medical condition where patients have excess fluid in the alveoli in conjunction with widespread inflammation in the lung. The first description of ARDS was introduced by Ashbaugh and

colleagues in 1967(Ashbaugh et al. 1967). The syndrome is characterized by severe hypoxia and stiff lungs (Ware and Matthay 2000).

ARDS involves two major mechanisms that injure the lung; firstly, alveolar damage and secondly;pulmonary epithelial and cellular damage that is characterized by series of inflammatory cascades (Fanelli et al. 2013). In the context of CPB, this syndrome occurs in 0.5-1.7% of patients and can associated with the multi-organ failure and death in 50-92% of patients (Asimakopoulos et al. 1999). Clinically, to treat ARDS patients, they are connected to mechanical ventilation. The future trend of the ARDS treatment will focus on the development of therapeutic agents based on the gene description and the mesenchymal stem cell.

### **2.11.3 Systemic inflammatory response syndrome (SIRS)**

Systemic inflammatory response syndrome (SIRS) is a non-specific inflammatory state affecting the whole body defined as a complex related to systemic inflammation, organ dysfunction and organ failure. This insult may be infection, trauma, burn or other injury. In the United States, it is reported that SIRS is a leading cause of mortality and morbidity. More than 400,000 patients develop SIRS every year and approximately 100,000 of those patients die (Levy et al. 1998). SIRS may also lead to further consequences such as sepsis (new definition of SIRS which is separate from sepsis as SIRS overly-sensitive and nearly all (over 90%) of patients admitted to ITU met SIRS criteria) and multiple organ failure (figure 20) (Shankar-Hari et al. 2016).Clinical criteria allow clinicians to identify SIRS patients.The American College of Chest/Physicians / Society of Critical Care Medicine defined four criteria to determine SIRS in patients. These are: temperature of  $>38^{\circ}\text{C}$  or  $<36^{\circ}\text{C}$ ; heart rate  $>90$  beat per minute; respiratory rate  $>20$  breath per minute; and

WBC  $>12000 \text{ mm}^3$  or  $<4000 \text{ mm}^3$ ) or  $>10\%$  immature band). If two of these four factors met together, the patient is classified as having SIRS (Bone 1996).

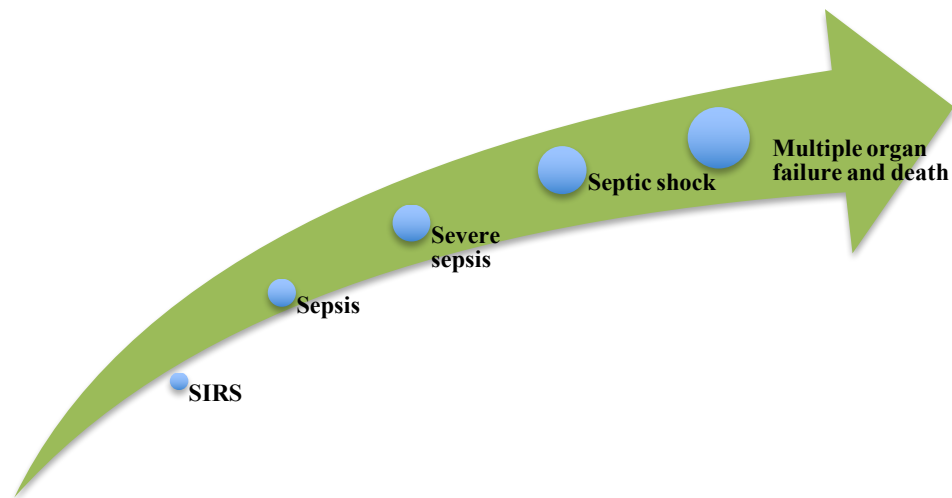

**Figure 20:**Progression of SIRS. sepsis (SIRS + infection), severe sepsis (organ dysfunction, hypotension and hypoperfusion), septic shock( severe sepsis+ hypotension) and multiple organ failure (2 or more organ failing).

The intensity and time course of SIRS is influenced by a balance situation between pro-inflammatory and anti-inflammatory cytokines at the local site of the inflammation (figure 21). The body reacts to this phenomena by the activation of reaction process called counter inflammatory response syndrome(CARS)which limits the duration of SIRS to avoid any further complications (Jaffer 2010).

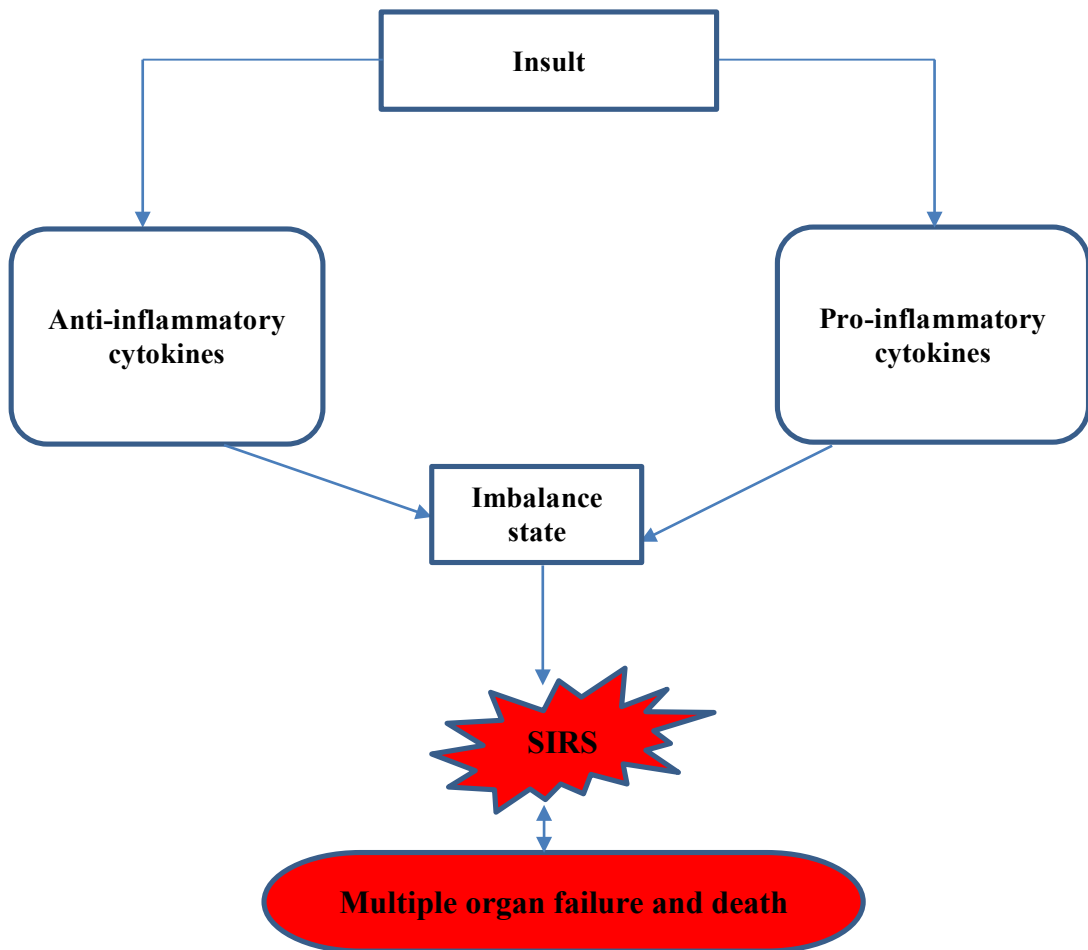

**Figure 21:** Balance between pro-inflammatory and anti-inflammatory cytokines. Adopted from (Jaffer 2010).

## 2.12 Summary

1. CPB deployment is associated with the development of SIRS as a response to the early contact between the blood and non-endothelial cell surface of CPB equipment. Also, ischemia resulting from CPB deployment, post-CPB reperfusion injury, the release of endotoxins from the gut and surgical trauma are key contributors to the onset of SIRS.
2. These factors initiate different cellular and humoral inflammatory cascades which activate the innate immune system to release pro-inflammatory and anti-inflammatory cytokines.

3. Downstream upregulation of these pro-inflammatory and anti-inflammatory cytokines triggers SIRS and results in severe deleterious post-surgical outcomes.
4. The current approaches to attenuate SIRS are classified into three main groups: surgery without CPB, technical modifications to the CPB and the administration of pharmacological agents such as aprotinin and steroids.
5. The literature demonstrated that these strategies are not patient-specific. We suggest that diagnostic modalities may be implemented prior to the surgery that can predict a subset of at-risk patients.

# **Chapter 3: Hypothesis and objectives of the work**



### 3 : Hypothesis and objectives of the work

#### 3.1 Introduction

CPB is the technique employed during open heart surgery as a temporary substitute for the patient's heart and lungs, diverting blood from the systemic circulation through an extracorporeal system, to allow the blood to be oxygenated and returned to the patient (figure 22 and figure 23).

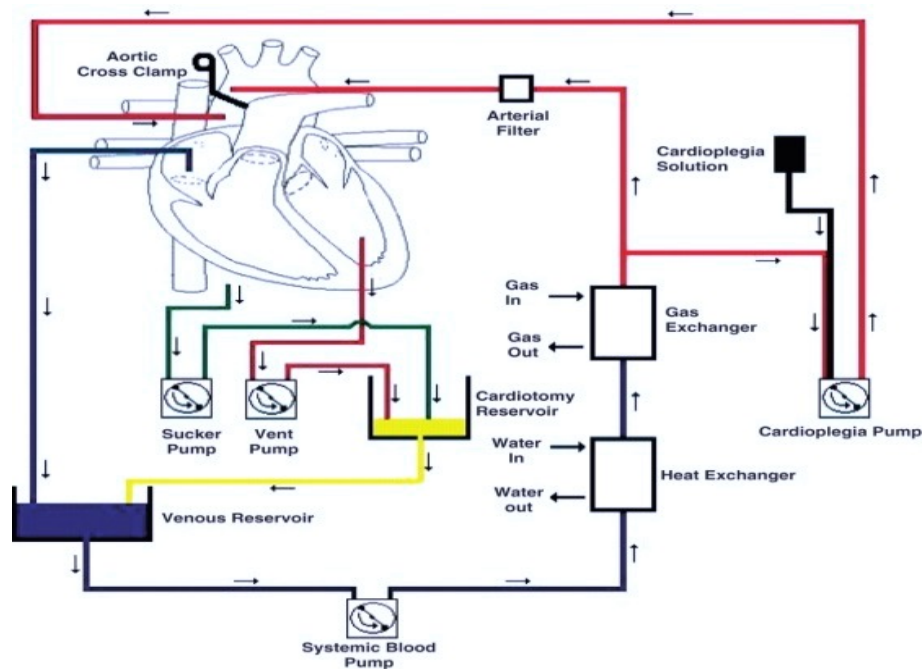

**Figure 22:**Diagram of a typical CPB system in use in operating. Showing the complexity of the apparatus (Bennett et al. 2015).

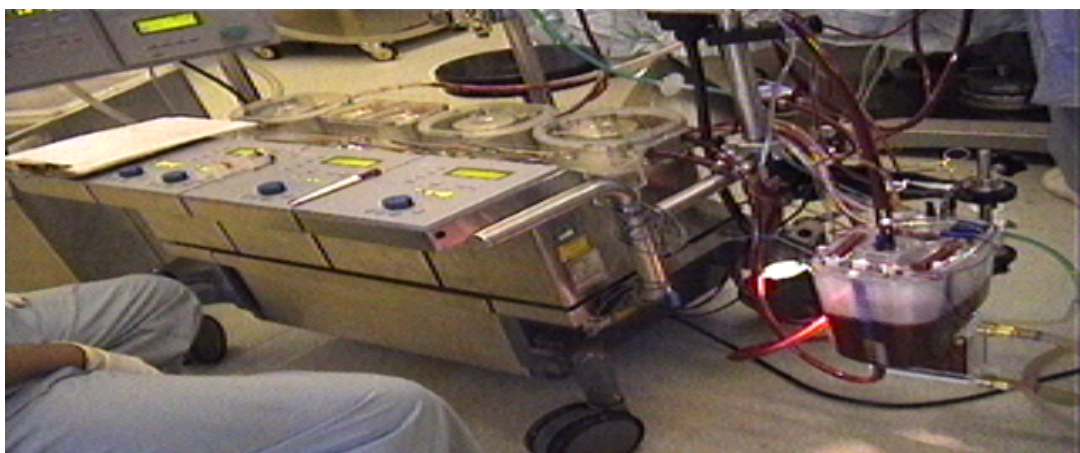

**Figure 23:**CPB in the theatre.

CPB is a complex system that can comprises very large surface areas of foreign materials such as PVC, polyamide, polyurethane, stainless steel, and aluminum (Asimakopoulos 2003) with which the patient's blood continually contacts. The extracorporeal surface area varies, but generally blood will come into contact with up to 12 m<sup>2</sup> of these foreign materials. CPB has been the underpinning technology for open heart surgery for over half of a century and its associated pathophysiology has been intensively studied throughout that time. However, the relationship between the blood- foreign materials contact and the triggering of a deleterious immune response was not identified until the mid 1970's (John Bulter 1993). In the ensuing years a number of strategies, were attempted to moderate the immune response to CPB. These largely fall into two categories, advancement of medical technologies and the administration of drugs, aimed at either suppressing or minimizing the impact of the immune response. These approaches include; the application of surface treatments to the surface of the blood contacting materials, typically using materials that are either inhibitory or biomimetic (Gunaydin et al. 2010) to moderate its contact mediated initiation; filtration technologies, particularly leukocyte filters which remove activated neutrophils in an effort to prevent their interaction with the endothelium, a key step in the immune response; non-specific kallikrein inhibitory drugs which inhibit neutrophil transmigration; mini-CPB systems which reduce the CPB system contact surface area and extent of haemodilution. These approaches to moderating and preventing the impact of the immune response to CPB during open heart surgery are based on sound laboratory evidence (Gourlay et al. 2001; Sun et al. 2013; Yii et al. 1996), and have been associated with some degree of improvement in recovery in the wider patient population as measured by established outcome measures

(Gunaydin et al. 2009). However, despite some fairly clear clinical evidence of a general clinical advantage associated with technologies, there remain a number of challenges associated with their deployment. In particular, these are expensive technologies, certainly too expensive to be generally deployed in all open heart surgery patients, particularly as most patients, with or without these devices tend to fare well in modern clinical practice. The current trend with these new techniques is to deploy them in "high-risk" patients, generally older, female, and re-do patient cohorts. However, it is unclear whether there is a true relationship between risk scoring in the conventional sense and the occurrence of heightened immune complications. Rather, the challenge of controlling the heightened immune reaction to CPB is currently unpredictable and does not correlate with current scoring or patient stratification techniques. Bearing this in mind, there is a dilemma in reducing the impact of the heightened immune response, and that is, in the absence of any accurate scoring or screening technique, the only approach to mitigating its impact given current inability to stratify patients for this specific risk, is to apply all of the moderating techniques and technologies to all patients. This is economically challenging for a national healthcare economy, and would impact considerably on the cost of open heart surgery globally. In recognition of the potential benefit of these technologies, a more appropriate approach to their deployment would be to adopt a more bespoke strategy, targeted at those patients who are predisposed to the inflammatory responses. Presently, we are not able to predict which of the general patient population fall into this heightened inflammatory responses category. However, there is evidence that as the patient population presenting for open heart surgery is increasing, particularly at the extremes of age, and the risk of

inflammatory mediated complications is also increasing (Davis et al .2004). It is clear that some form of screening technology would be of great benefit to the open heart surgery community, reducing the risk to patients with heightened propensity for immune response and reducing the cost to the healthcare providers by enabling the targeting of anti-immune strategies rather than encouraging ethical general deployment of these. In addition, considerable savings can be made by reducing the need for extended intensive tension unit length of stay for patients recovering from heightened immune response. This can be a considerable cost, with patients languishing in ITU facilities and costing healthcare providers upwards of 2000 euro per day(Tan et al. 2012).

### **3.2 Hypothesis of the project**

Biomaterial activated cytokines can be employed in a screening test for the propensity of patients undergoing open-heart surgery to develop a heightened response to the intervention.

### **3.3 Aims and objectives of the project**

The project aims to develop a screening technology which will enable the identification of patients with a heightened immune response before they undergo the open heart surgery procedure. The overwhelming problem with currently available anti-inflammatory strategies as we have discussed is our current inability to carefully measure and account for how an individual patient will respond to CPB from the perspective of the immune response. There is an enormous variability in this response. Whenever a study demonstrating lack of clinical effect of a theoretically promising strategy or significant contribution to the clinical outcome is discussed, we should wonder whether the patient population is of high or low enough risk and if the

individual biological variability is fully or equally accounted in the design. We need to focus our research efforts to better understand patients' biologic profiles before choosing a specific treatment strategy, in full knowledge of the fact that contact with the CPB system will elicit an immune response. This may avoid the current relatively crude, blind and potentially expensive, broad and unfocused application of mechanical, technical and pharmacological approaches to a biologically diverse patient population. Key to the successful deployment of expensive technological or pharmaceutical anti-inflammatory strategies is the identification of the patients for whom this will be of benefit, or indeed life sparing. Currently there are no procedures which enable the identification of these patients prior to surgery, rather the approach currently taken in normal clinical practice which is to treat the patients after surgery, but in the cohort of patients with a greatly heightened inflammatory response to CPB, this approach is both expensive in terms of intensive care unit time and is often unsuccessful. This project suggests a new approach to identifying these patients, through the development of a novel technology which will measure the propensity for inflammatory response to blood contact with extracorporeal systems. The overall focus of this work is in the cardiopulmonary bypass domain, but other treatments and interventional modalities in which tissues, in particular blood, comes into contact with foreign surfaces may also benefit. These might include renal dialysis, haemofiltration and possibly implantation of orthopaedic prosthesis where heightened immune processes are a known failure mode.

### 3.4 Objectives

1. To study the effect of DEHP Plasticised PVC and liquid DEHP in the initiation of inflammatory response on bovine blood and measure the response in terms of IL-6 and TNF- $\alpha$ .
2. To determine the effect of different agitation times in the upregulation of pro-inflammatory cytokines.
3. To conduct a clinical study to investigate the clinical impact of DEHP plasticised PVC and liquid DEHP initiators on the patients' blood samples prior to the surgery. The results were expressed in terms of the rapid pro-inflammatory cytokines (IL-6, TNF- $\alpha$  and C-reactive protein).
4. To determine the most appropriate and sensitive pro-inflammatory marker from the three rapid cytokines by using the suitable statistical methodologies.
5. To specify the most appropriate initiator (DEHP plasticised PVC/liquid DEHP) based on the laboratory and clinical studies.
6. To specify the most suitable approach to measure the heightened cytokine marker based on using two measurements methods (ELISA and FTIR).
7. To develop the screening test technology for measuring the heightened inflammatory marker.

# **Chapter 4: In-vitro laboratory methodology**

## **4 : In-vitro laboratory studies methodology**

### **4.1 Background**

Cardiac surgery with a supportive heart lung machine promotes the initiation of cellular and humoral interactions that lead to produce unwanted complications after the operation. Cytokines are considered as the essential humoral components that initiate the immune system to achieve a systemic balance through the secretion of pro-inflammatory and anti-inflammatory cytokines. However, overexpression of cytokine species leads to a systemic imbalance leading to the development of a systemic inflammatory response syndrome (SIRS). When this amplified response is uncontrolled, it can progress to multiple organ failure and death. The initiator of this syndrome can be multi-factorial and it is unpredictable in the clinical setting.

The aim of this work is therefore to develop a predictive diagnostic device that can enable the clinicians to identify high risk patients prior to the surgery. Such a device may reduce the number of patients who go on to have SIRS as a response to the procedure by directing them to alternative strategies. To achieve this aim, it is essential to identify the best indicator of the syndrome in the blood. Based on the literature review (Giannoudis et al. 2008) stated that IL-6 is a good indicator of inflammation and is overexpressed in patients who may develop SIRS. However, there are a number of cytokines that may also present prognostic targets and these also need investigation.

The present work will study the response of these cytokines to inflammation stimuli (IL-6 and TNF- $\alpha$ ). Several studies supported the importance of these pro-inflammatory cytokines and their major role in the mediation of the inflammatory responses due to their rapid appearance in the blood during the inflammation cycle.



For example, Meng and his research group performed a clinical study on forty patients and stated that IL-6 with TNF- $\alpha$  levels were increased significantly one hour after the cessation of CPB and reached peak within 6 hours (Meng et al. 2008).

The below table summarizes these cytokines and their functions.

Cytokines	Peak time	Function
TNF- $\alpha$	Peak about 1 hours after cessation of cardiopulmonary bypass	<ul style="list-style-type: none"> <li>• Initiating the production of other pro-inflammatory cytokines such as IL-1 and IL-6</li> <li>• Induction of hepatic acute phase</li> <li>• Endothelial dysfunctions</li> <li>• Stimulation of adhesion molecules</li> </ul>
IL-6	Increase levels after 1 hours of the CPB and peak after 4 hours	<ul style="list-style-type: none"> <li>• Induction of acute phase of inflammation</li> <li>• Strong correlation between the peak level and post-operative outcomes ( ischemic)</li> </ul>

**Table 3:**The common pro-inflammatory cytokines and their functions(Meng et al. 2008).

### Materials and Methods

The basis of this diagnostic device is to measure the upregulation of cytokines (IL-6, TNF- $\alpha$  and C-reactive protein) in response to an inflammatory stimulus to a sample of blood. The device should be capable of indicating overexpression of the cytokines in response to the stimulus, thus indicating the at-risk patients (see schematic below).

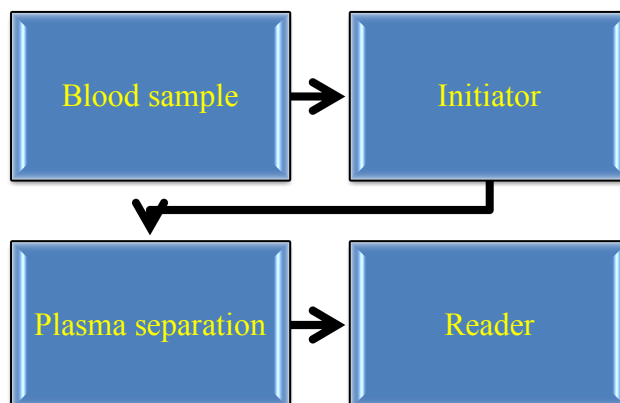

**Figure 24:**Schematic diagram of the laboratory work process.

The combination of initiator and selected cytokine should ideally produce an early rapid and measurable response. It is desirable that the instrument should be capable of delivering a near real time measure of this response. However, before developing the device itself the current work focused on ascertaining the best combination of the initiator and the cytokine. For this purpose, as previously discussed, we selected IL-6, TNF- $\alpha$  as the targeted markers of inflammation and DEHP plasticised PVC and DEHP itself as the initiators.

#### **4.1.1 Initiators**

The medical literature has shown that there are a number of materials, both synthetic and biological, that can trigger the inflammatory response in the blood (Lappegård et al. 2008). However, in the context of cardiac surgery we consider it important that the initiator should be one that the blood will commonly come into contact with during the surgical procedure to eliminate any false positive results. Recent studies have shown that PVC, more specifically DEHP has significant pro-inflammatory properties and is a major element of the cardiopulmonary bypass circuitry (Gourlay et al. 2001; Gourlay et al. 2010; Gourlay et al. 2003). It is for this reason PVC and DEHP were selected as the initiators in the study. Both DEHP plasticiser PVC and DEHP itself were selected for a number of purposes, but primarily to ascertain whether there is any added value using the solid PVC material as it may be safer to use in the final device configuration. In addition, as the previous studies did not investigate the effect of employing different amount of PVC and liquid DEHP to the blood in terms of the upregulation levels of the targeted molecules (IL-6 and TNF- $\alpha$ ), the present study covers different PVC weights and different liquid DEHP volumes as see in section 4.4.

## Polyvinyl chloride (PVC)

The concept plasticiser means a substance that is added to materials such as plastic to make it flexible resilient and easy to use in many applications. There are more than 300 types of plasticisers but the common types are phthalates and adipates.

PVC is a rigid material in its nature due to a short distance between molecules. However, when adding plasticiser to the PVC, the distance between molecules becomes wider and the material becomes softer.

PVC is the third most produced synthetic plastic polymer, after polyethylene and polypropylene and it has been shown to be associated with the initiation of inflammatory responses (Gourlay et al. 2003).

For the purpose of this work, ground DEHP plasticised PVC will be used, derived from medical grade PVC tubing. This configuration was selected due to the fact that in this state, it presents a high surface area for interaction with the blood, to take place and thus may result in a relatively low volume of final activator product for using the diagnostic device.

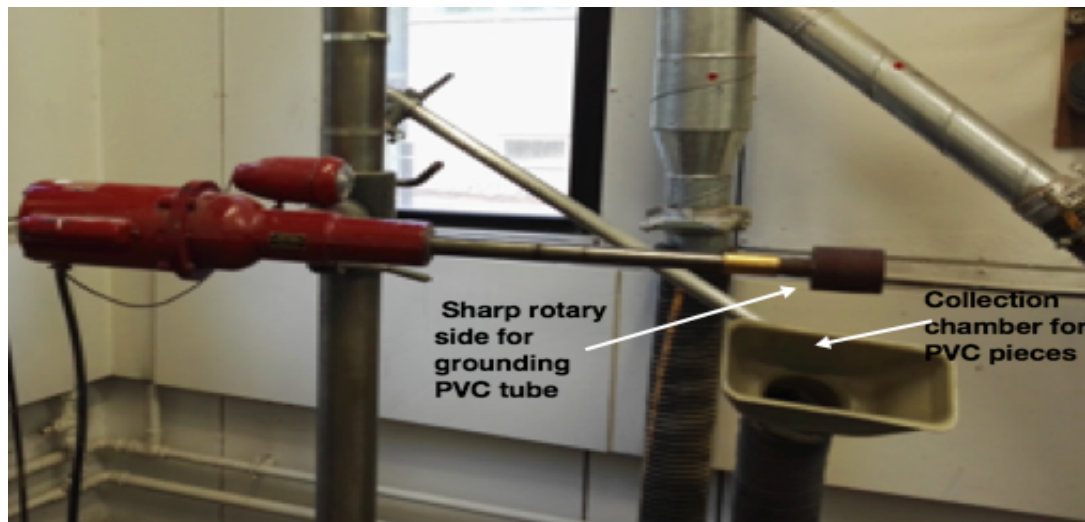

**Figure 25:** Image of the ground machine that used to ground DEHP plasticised PVC tube ( source: biomedical engineering department workshop, University of Strathclyde). The tube is placed on the sharp edge of the machine and it is rotated a clockwise direction to produce a small grounded pieces of DEHP plasticised PVC.

## **DEHP**

DEHP is the most common plasticiser used in medical applications. Di-(2-ethylhexyl) phthalate is an endocrine disruption chemical used worldwide as a plasticiser for medical and non-medical applications. It is known as phthalates and is used to make the tube softer and more flexible (Sampson and De Korte 2011). This chemical can produce several toxic effects to the blood and is considered as an initiator of the inflammatory responses (Chang, Lin, and Chang 2013). However, its toxic effects continues to be investigated. A study suggested that its effect are of little importance in short term adult CPB but they are more significant where the body mass ratio is much higher (Gourlay 2001). On the other hand, DEHP does produce an innate inflammatory response during CPB surgery. A study conducted by Zhao demonstrated the effect of the presence of DEHP in the initiation of the inflammatory response. Interestingly, the reduction of the DEHP resulted in the reduction of the fibrinogen adsorption on the material surface which reduced the impact of inflammatory mediators in terms of the SIRS development (Zhao and Courtney 1999).

As outlined above, both DEHP plasticised PVC and DEHP itself may represent controllable and relevant initiators for a diagnostic/prognostic tool. A series of experiments was therefore designed to test this hypothesis and determine the best initiator.

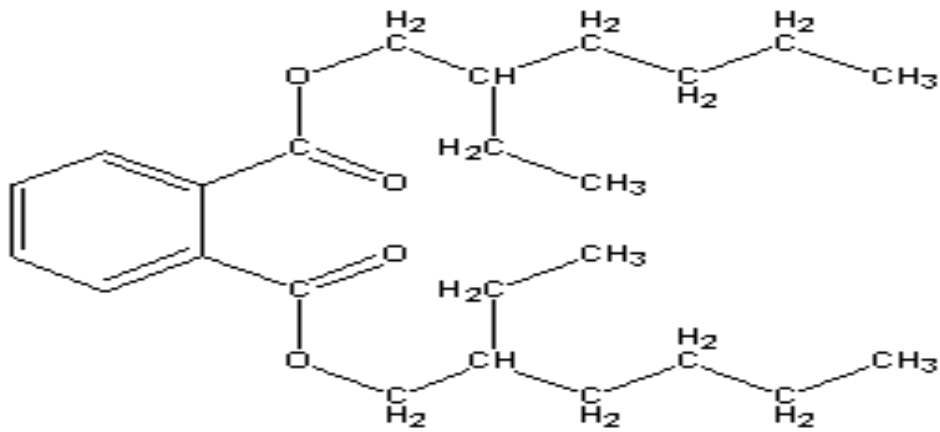

Figure 26: DEHP molecule structure (Taken from: <http://wwwcourses.sens.buffalo.edu/>)

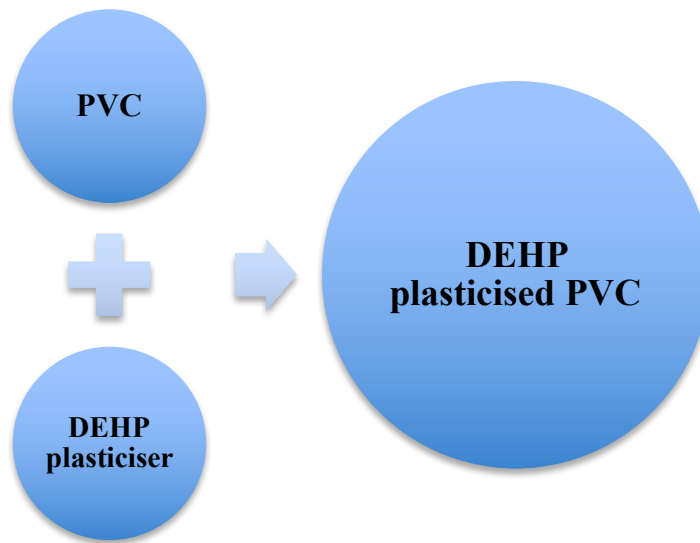

Figure 27: The formation of DEHP plasticised PVC .

#### 4.2 Determination of the initiators

A series of experiments were carried out in the laboratory to determine whether liquid DEHP itself or DEHP plasticiser represent the most predictable and sensitive initiator of the upregulation of pro-inflammatory cytokines in the blood. Different quantities of both DEHP itself and DEHP plasticiser were employed in these experiments with the objective of determining the effect of quantity and response in order that the smallest quantity of material can be employed in the final device configuration. In addition, the optimal exposure time was investigated at all levels of

material exposure to determine the best agitation time for the final device configuration.

### 4.3 Blood samples

Bovine blood was obtained according to established procedure in our lab. It was brought to the lab on the same day of the experiment from the local abattoir using the following protocol table (table 4).

Steps	Description
1	Collect a bovine blood from the local abattoir (Sandyford farm,Paisley,UK) in a sealed 5L container immediately after animal was sacrificed.
2	In order to prevent clotting, the blood must be treated with 10,000IUs of heparin sodium from porcine mucosa ( <i>Sigma Aldrich</i> )
3	This heparinisation is achieved by mixing heparin sodium with 50ml of 0.9% NaCl saline and placing this solution in the 5L container before the blood is collected.

**Table 4:**Bovine blood samples protocol.

### 4.4 Activation of blood samples

Blood samples (5 ml heparinized bovine blood) were placed in 6 well plate. The activating agent was introduced into the blood containing wells in accordance to the following exposure protocol (table 5). As shown in table 5, bovine blood was contacted with different weights of DEHP plasticised PVC and different volumes of liquid DEHP. They were agitated for different times (0 min, 10 min, 30 min, 60 min and 90 min) and samples were taken from each well in addition to the static and dynamic control samples.

Time (min)	DEHP Plasticised PVC (gram)						Liquid DEHP (ml)						
	0.5	0.4	0.3	0.2	0.1	0.05	0.5	0.4	0.3	0.2	0.1	0.05	
0	✓	✓	✓	✓	✓	✓	✓	✓	✓	✓	✓	✓	✓
10	✓	✓	✓	✓	✓	✓	✓	✓	✓	✓	✓	✓	✓
30	✓	✓	✓	✓	✓	✓	✓	✓	✓	✓	✓	✓	✓
60	✓	✓	✓	✓	✓	✓	✓	✓	✓	✓	✓	✓	✓
90	✓	✓	✓	✓	✓	✓	✓	✓	✓	✓	✓	✓	✓

**Table 5:**Exposure protocol of the bovine blood with DEHP plasticised PVC and liquid DEHP.

Static and dynamic control samples were introduced into the experiment but with no material exposure. Static control samples were placed in a 5 ml container with no agitation while dynamic control samples were placed in 6 well plate and agitated with an orbital shaker. This experiment was carried out at room temperature and blood samples were taken in accordance to the following sample protocol table 6.

Time(min)	Description of the blood collection
0	1 ml blood is taken from each well by using 2 ml polycarbonate syringe and put in 1.5 ml eppendorf tube.
10	
30	
60	
90	

**Table 6:**Sampling time description.

The blood samples harvested from the process were centrifuged (using a servall pico centrifuge) immediately (13000 rpm for 10 min), the plasma was removed and snap-frozen, and then stored at -80°C for future analysis.



**Figure 28:**Bovine blood experiment set up from left to right (Centrifuge, orbital shaker, weight balance, liquid DEHP, ground DEHP plasticised PVC and blood samples).

## **4.5 Enzyme Linked Immunoassay Sorbent Assay (ELISA)**

The plasma samples were defrosted and the concentration of the molecules of interest were measured using the ELISA technique.

The enzyme-linked immunosorbent assay (ELISA) is an immunological assay commonly used to measure antibodies, antigens, proteins and glycoproteins in biological samples. The technique since its first introduction to the medical field 40 years ago, has become a gold standard for the diagnosis of many diseases (Lequin 2005). Some examples include: diagnosis of HIV infection, pregnancy tests, and measurement of cytokine concentration in plasma and serum.

In an ELISA, an antigen must be immobilized to the micro plate wells and then attached with an antibody that is linked to an enzyme. For example, if we are looking for IL-6 cytokine in the plasma, the 96 wells of the microplate should be coated with IL-6 antibodies and then the assay process performed in order to capture only IL-6 while other cytokines will be removed by washing steps. Detection is accomplished by assessing the conjugated enzyme activity via incubation with a substrate to produce a measureable product in a color form (yellow). Subsequently, the optical density of this color is measured by using an appropriate spectrophotometer technique.

### **4.5.1 ELISA steps**

The sandwich ELISA technique is accomplished via four essential steps: Coating, capturing, detection and measuring the absorbance as seen in figure 29. These steps are explained in details in table 7.



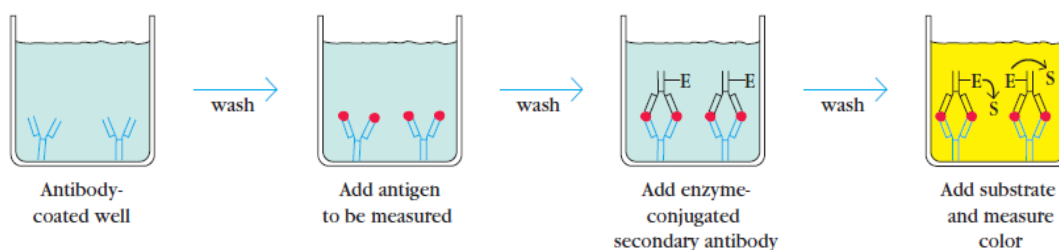

**Figure 29:** Sandwich ELISA general principle. (Taken from <http://laboratoryinfo.com/elisa/>).

Steps	Description
1	Coat the plate with the capture antibodies to allow capturing the targeted antibodies only and other antibodies are removed by washing.
2	Add all samples to the plate according to the planned experiment sheet.
3	Add detection antibodies to bind with the targeted antigen that already bound to the plate
4	Add substrate solution to stop the reactions and develop the color in the samples.
5	Place the plate into the plate reader to measure the samples absorbances.
6	Generate the standard curve based on the absorbance of the standard samples from the plate and known concentrations. then ,the concentration of each absorbance antigen can be calculated from the standard curve equation.

**Table 7:** Sandwich ELISA steps.

In this work, for both IL-6 and TNF- $\alpha$  , the bovine plasma samples were arranged in the ELISA microplate according to table 8. The adopted ELISA protocols for both IL-6 and TNF- $\alpha$  were bought from RD systems a biotechnie brand, Abingdon Science Park UK. Details of the procedures are contained in the supplier data sheets, Appendix A.

	DEHP plasticized PVC							Liquid DEHP				
	0 min	10 min	30 min	60 min	90 min	0 min	10 min	30 min	60 min	90 min		
	1	2	3	4	5	6	7	8	9	10	11	12
A	Standard	Standard	SC	SC	SC	SC	SC	SC	SC	SC	SC	SC
B	Standard	Standard	DC	DC	DC	DC	DC	DC	DC	DC	DC	DC
C	Standard	Standard	0.5 g	0.5 g	0.5 g	0.5 g	0.5 g	0.5 ml	0.5 ml	0.5 ml	0.5 ml	0.5 ml
D	Standard	Standard	0.4 g	0.4 g	0.4 g	0.4 g	0.4 g	0.4 ml	0.4 ml	0.4 ml	0.4 ml	0.4 ml
E	Standard	Standard	0.3 g	0.3 g	0.3 g	0.3 g	0.3 g	0.3 ml	0.3 ml	0.3 ml	0.3 ml	0.3 ml
F	Standard	Standard	0.2 g	0.2 g	0.2 g	0.2 g	0.2 g	0.2 ml	0.2 ml	0.2 ml	0.2 ml	0.2 ml
G	Standard	Standard	0.1 g	0.1 g	0.1 g	0.1 g	0.1 g	0.1 ml	0.1 ml	0.1 ml	0.1 ml	0.1 ml
H			0.05 g	0.05 g	0.05 g	0.05 g	0.05 g	0.05 ml	0.05 ml	0.05 ml	0.05 ml	0.05 ml

**Table 8:** Bovine blood samples' distribution in the ELISA plate. From the table SC is the static control and DC is dynamic control.

All measurements were carried using three separate sources of blood, providing n=3.

A spectrophotometric assay was used to determine the protein's concentration of

each sample using the reference calibration curves derived from the standard solutions.

#### 4.5.2 Plate reader (spectrophotometer)

A multiscan spectrophotometer reader is an instrument used widely for many clinical and research purposes to measure the optical density of the yellow color of each well. Basically, a light source illuminates the sample at a specific wavelength and the light detector is located at the other side of the well to measure the actual transmitted light via the sample (Figure 30). The specific wavelength is adjusted from a computer control interface system via a specific software of the technique. For example, in ELISA, the most recommended wavelength for cytokines IL-6, TNF- $\alpha$  is 450nm.

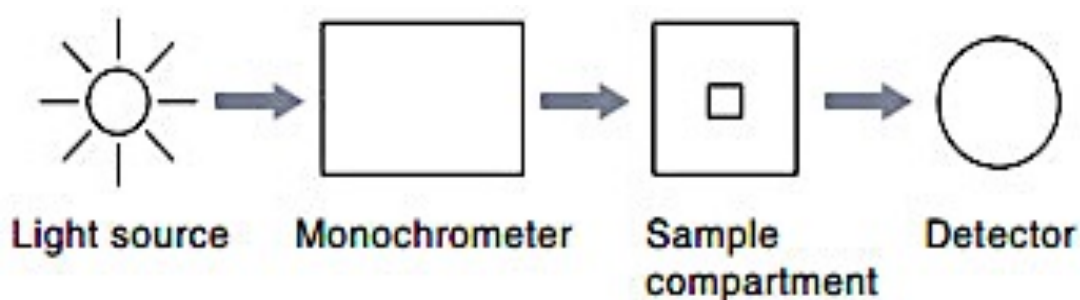

Figure 30: Spectrophotometer principle of operation. (Taken from <http://www.shimadzu.com>)

#### Spectrophotometer components:

##### Light source

It is required to be stable over the time and should be bright across the wide range of wavelengths. The commonly used light source in spectrophotometers are halogen and deuterium lamps due to their visibility and long service life.

### **Monochrometer**

Unlike spectrometer technique which allows the process of capturing the whole light spectrum at different wavelengths across the sample, monochrometer narrows the capturing area. It is used to measure the intensity of light via capturing a specific spectrum at particular wavelengths.

### **Sample compartment**

Fundamentally, the spectrophotometer technique is based on the theory of splitting the emitting light into different components at different wavelengths that can pass over the sample, and detecting it by a specific silicon or photomultiplier detector at the end of the process.

### **Detector**

Simple silicon or photomultiplier detectors can be used for ultraviolet and visible light range. It is the last element of the spectrophotometer and it can measure the intensity of the absorbed light via the samples.

### **Description of the plate reader software and how it measures absorbance**

Spectrophotometer is connected to a computer interface system in order to control all functions and adjustments by a powered software for this purpose (figure 31). Ascent multiscan software provides a wide range of measuring different spectral wavelengths from 340-850 nm. The system is also designed to measure the absorbances of either 96 wells or 384 wells. It is possible to generate results within 9 seconds for 96 wells and 20 seconds for 348 well plate.

In this work, the measurements were done according to the following steps (table 9).

Steps	Description
1	Set the specific wavelengths for the measurement (450 nm and 540 nm). The recommended wavelengths for IL-6 and TNF- $\alpha$ is 450 nm. According to the provided protocol, the obtained optical density at 450 nm will be corrected to be more accurate by subtracting the optical density at 540 nm from the 450 nm (see appendix A for RD bioscience ELISA protocol).
2	Insert the 96 wells plate into the reader.
3	Run the analysis and wait for 9 seconds to get the results.
4	Copy the results into spreadsheet file and save it for future analysis.

**Table 9:**Multiscan plate reader steps



**Figure 31:**Multiscan plate reader and the computer interface system.

### Standard curve

The ELISA standard curve is prepared by making serial dilutions of standard samples with known concentrations from the stock solution according to the provided protocol from the supplier (RD systems a biotechne brand, Abingdon Science Park, UK).The standard solution should covers the full standard range. Practically, the standard samples should be prepared prior to the experiment and used immediately.

After getting the absorbances from the plate reader, the standard curve is constructed by plotting the mean absorbance of each standard against the known concentration.

Then, we can add trendline and display  $R^2$  with the curve equation. Higher  $R^2$  indicates the best fit of the curve and the mathematical equation of the curve was used to calculate the concentration for each sample.

#### **4.6 Statistical analysis**

The samples' absorbances were measured three times by ELISA to ensure precision and accuracy of the measurements. Hence, the results are presented as mean  $\pm$  SEM. Statistical significance is specified by paired t-test ( $p < 0.05$ ).

#### **4.7 Summary**

1. A series of in-vitro laboratory studies will investigate the effect of employing two initiators (DEHP plasticised PVC and liquid DEHP) with bovine blood samples.
2. The response was measured in terms of IL-6 and TNF- $\alpha$  levels by using the ELISA technique.

# **Chapter 5: In-vitro laboratory results**

## 5 : In-vitro laboratory studies results

### 5.1 Introduction

The objective of this aspect of the work was to determine the impact of two potential initiators of the inflammatory response (ground DEHP plasticised PVC and liquid DEHP) in constrained blood samples, to determine whether there is a dose response to the exposure and to investigate the impact of the activation process on two cytokines, IL-6 and TNF- $\alpha$ . This work was carried out in a series of in-vitro experiments using fresh heparinized bovine blood. The primary objective of this aspect of the thesis was to determine the most appropriate initiator and marker for the intended screening technology.

### 5.2 IL-6 measurments

Standard curves were generated based on the standards provided in the commercial assay kits. This standard curve and the associated trendline equation were used to calculate IL-6 concentration in each sample (figure 32).

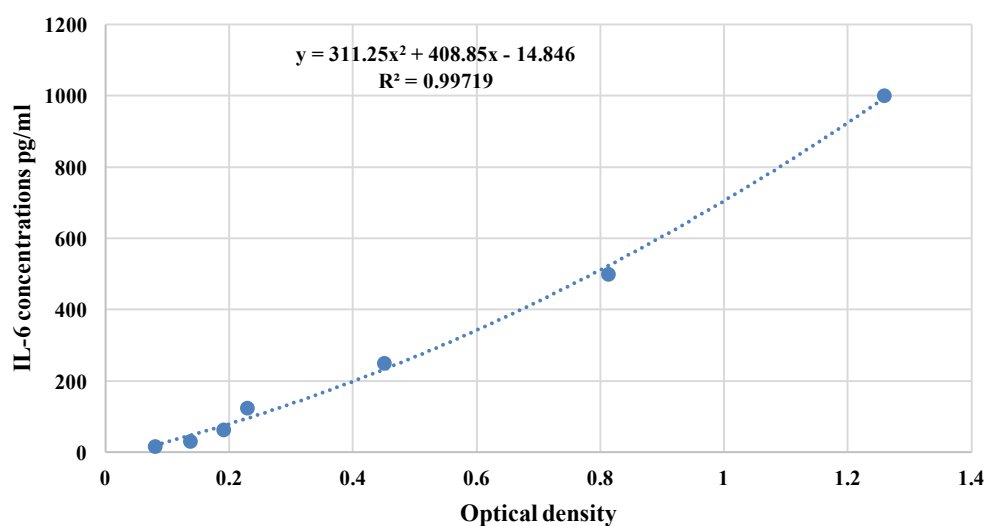
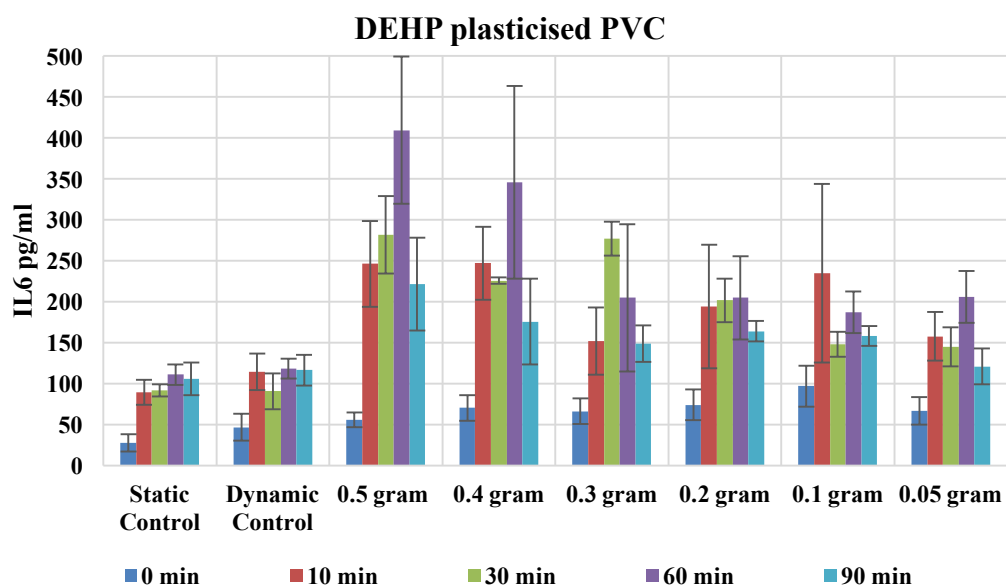
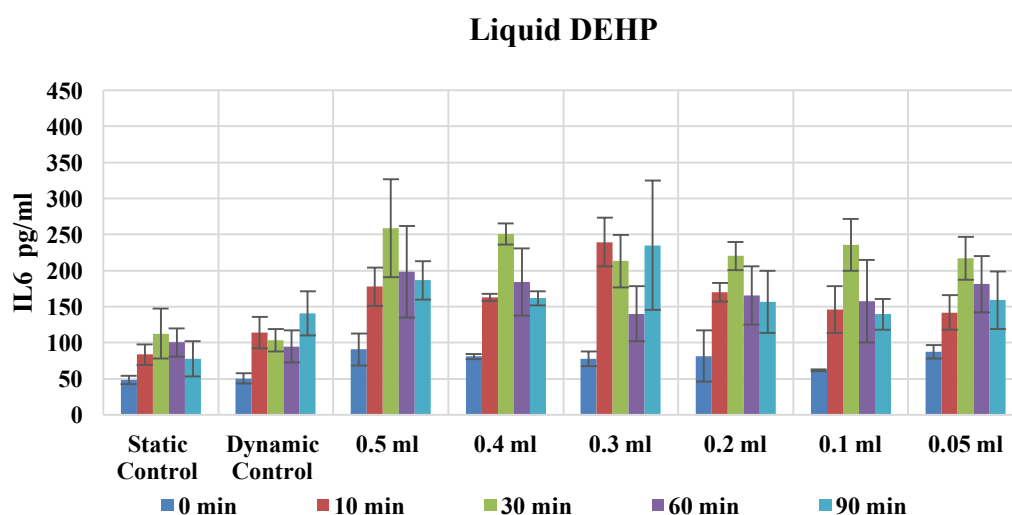

Figure 32: Representative IL-6 standard curve. All IL-6 standard curves can be seen in appendix B.

The activation process was carried out on all samples with parallel with static and dynamic control samples as described in the study protocol earlier in chapter 4. Control samples were used to determine the significant effect of different agitation times and the results of these processes are expressed in figure 33, 34 and 35 and 36,37 and 38.



**Figure 33:**IL-6 levels pg/ml with grounded DEHP plasticised PVC at different agitation times (n=3).



**Figure 34:**IL-6 concentrations pg/ml versus the mean of different loading liquid DEHP at different agitation times (n=3).



### IL-6 DEHP plasticised PVC Static control and dynamic control

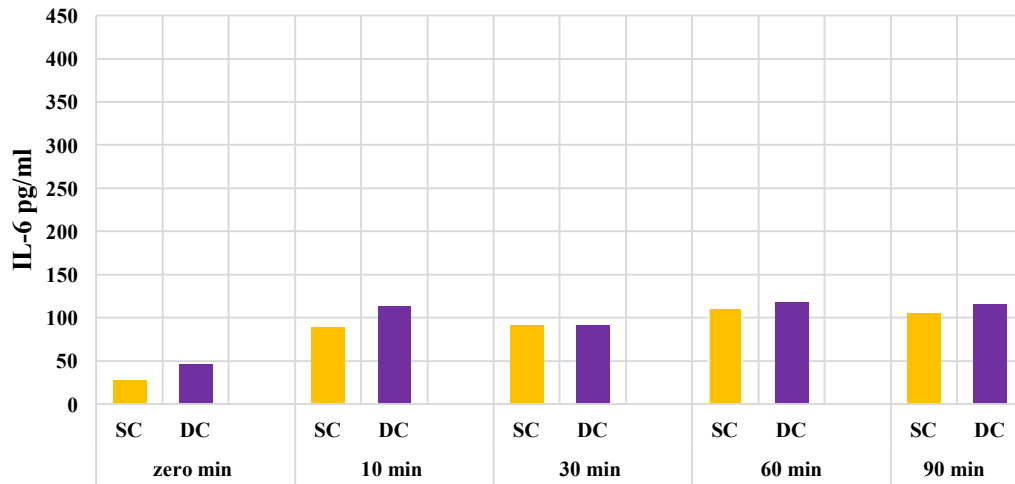

Figure 35: Static control(SC) and dynamic control (DC) IL-6 levels (DEHP plasticised PVC samples)

### DEHP plasticised PVC (Dynamic control -static control)

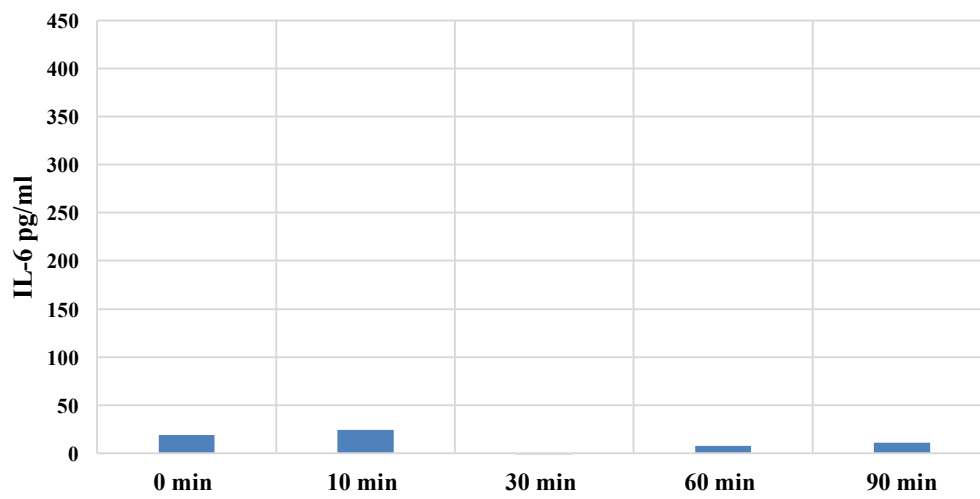

Figure 36: Dynamic controls minus static controls (IL-6 DEHP plasticised PVC).

### IL-6 liquid DEHP static control and dynamic control

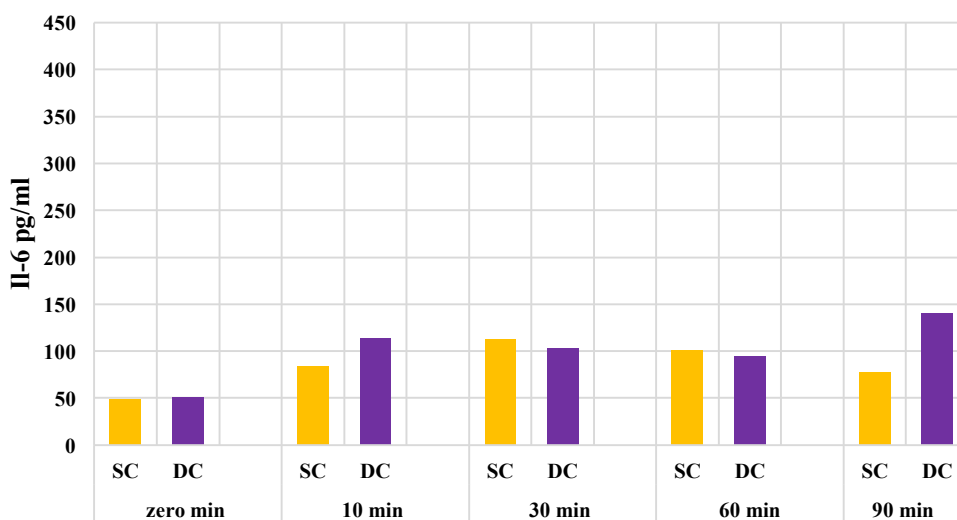

Figure 37: Static control(SC) and dynamic control (DC) IL-6 levels (liquid DEHP samples).

### Liquid DEHP ( Dynamic control -Static control )

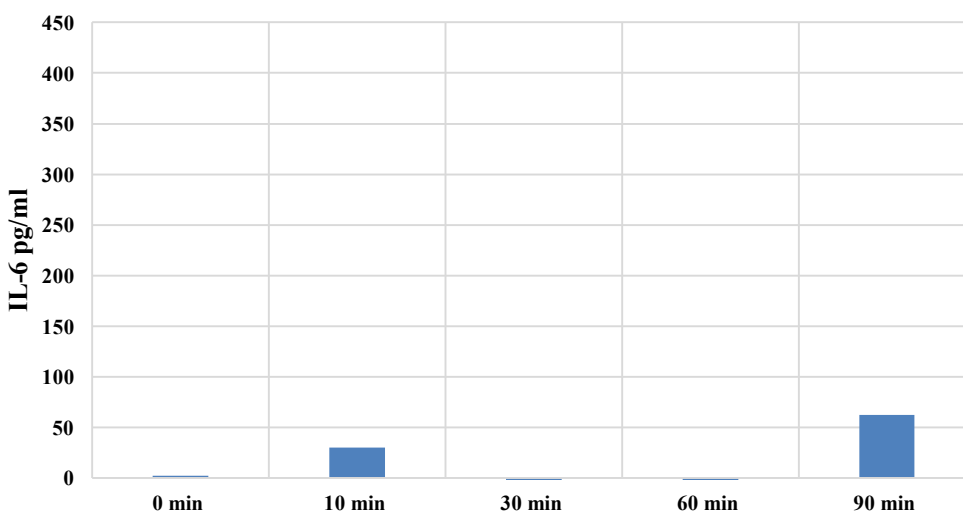

Figure 38: Dynamic controls and static controls (IL-6 liquid DEHP).

It can be seen from the above figures that there is a variation in response to different agitation times and weights and volumes of initiators. These outcomes suggested that both initiators are associated with the upregulation of IL-6 levels across the agitation times. Interestingly, statistical analysis of these data t-test showed statistical

significance with increasing weights and volumes of initiators, with the most significant differences associated with the highest weight and volume levels (0.4 gram DEHP plasticised PVC (p=0.0005) and 0.4 ml liquid DEHP (p=0.0004) after 30 min agitation time. Control samples confirmed lower IL-6 levels which suggest a strong effect of the initiators in the upregulation of IL-6 concentrations.

### 5.3 TNF- $\alpha$ measurements

Similar to the IL-6 measurements in this study, TNF- $\alpha$  standard curves were generated according to the ELISA protocol in order to calculate the concentration levels of each sample, figure 39.

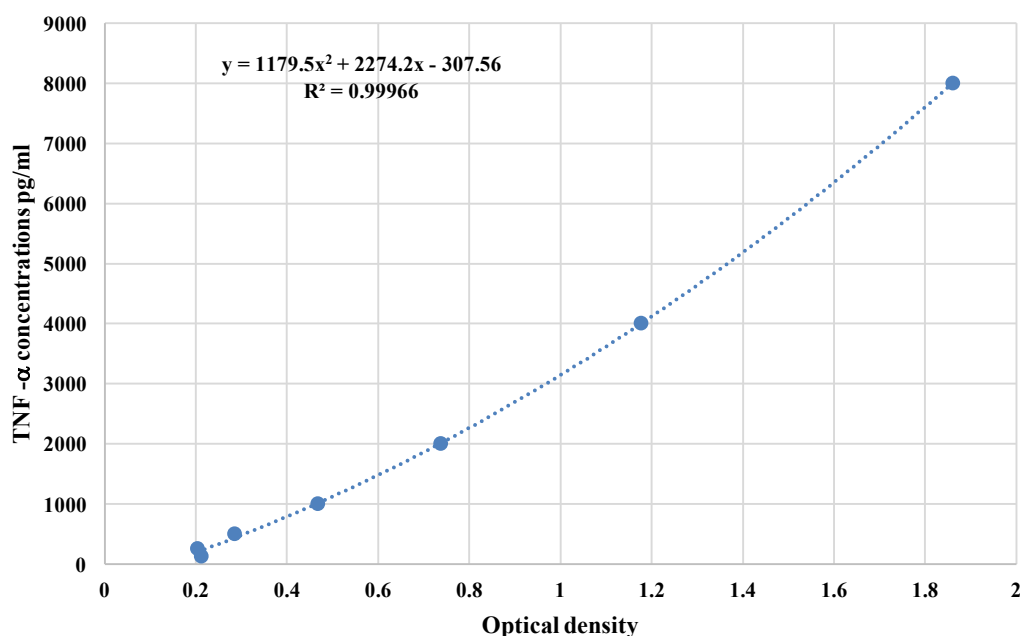

**Figure 39:** Representative TNF- $\alpha$  standard curve . All TNF- $\alpha$  standard curves can be seen in appendix C.

TNF- $\alpha$  results were expressed in the following figures (40,41,42,43,44 and 45). The activation process of all samples were performed as the outlined explained protocol in chapter 4.

### DEHP plasticised PVC

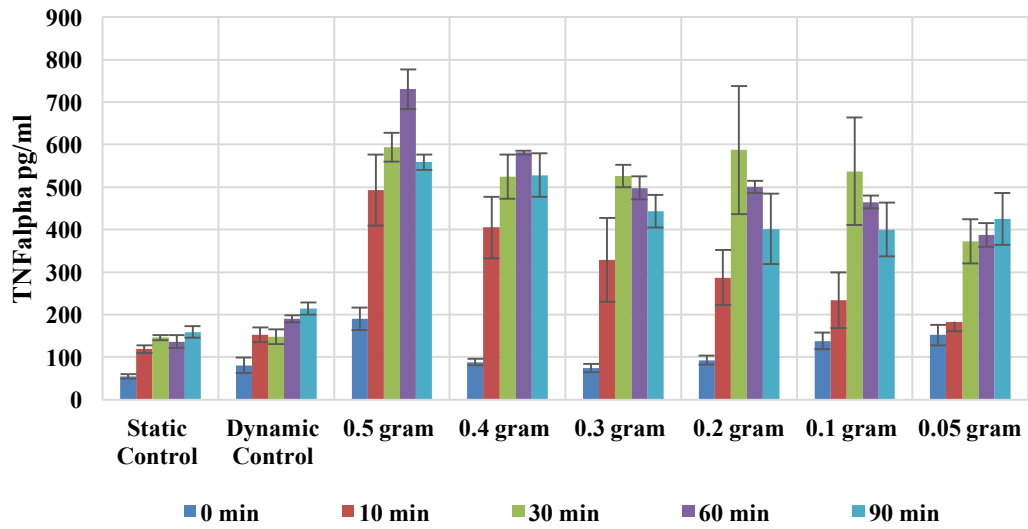

**Figure 40:** TNF- $\alpha$  concentrations pg/ml versus different weights of DEHP plasticised PVC at different agitation times (n=3).

### Liquid DEHP

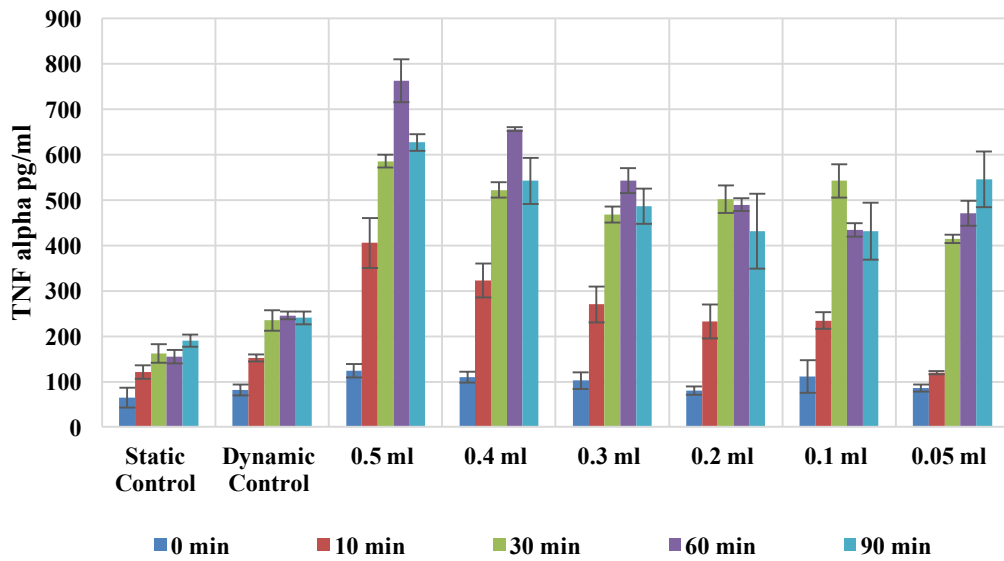

**Figure 41:** TNF- $\alpha$  concentrations versus different liquid DEHP volume at different agitation times (n=3).

### TNF-alpha DEHP plasticised PVC static control and dynamic control

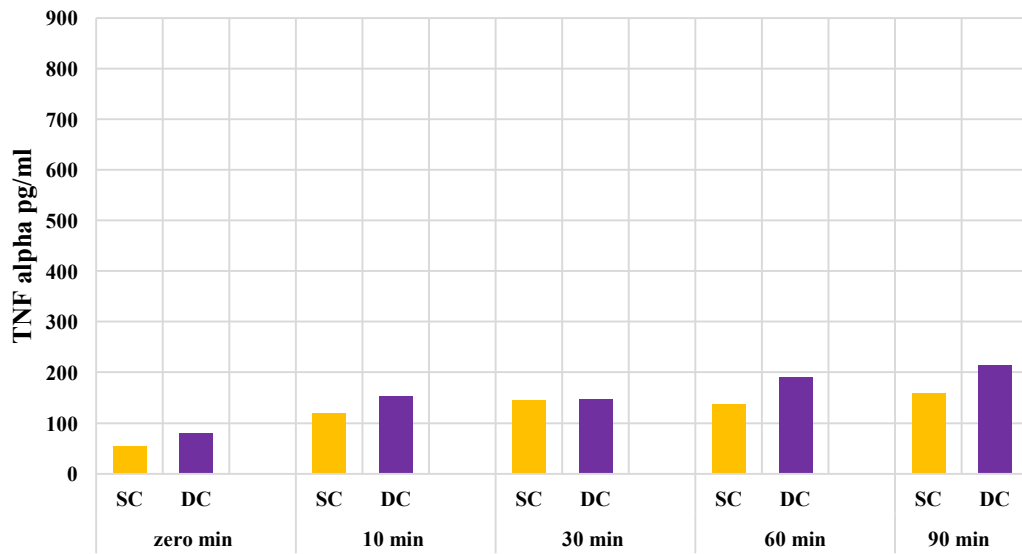

Figure 42: Static and dynamic control samples (TNF- $\alpha$  DEHP plasticised PVC).

### DEHP plasticised PVC (Dynamic control-Static control)

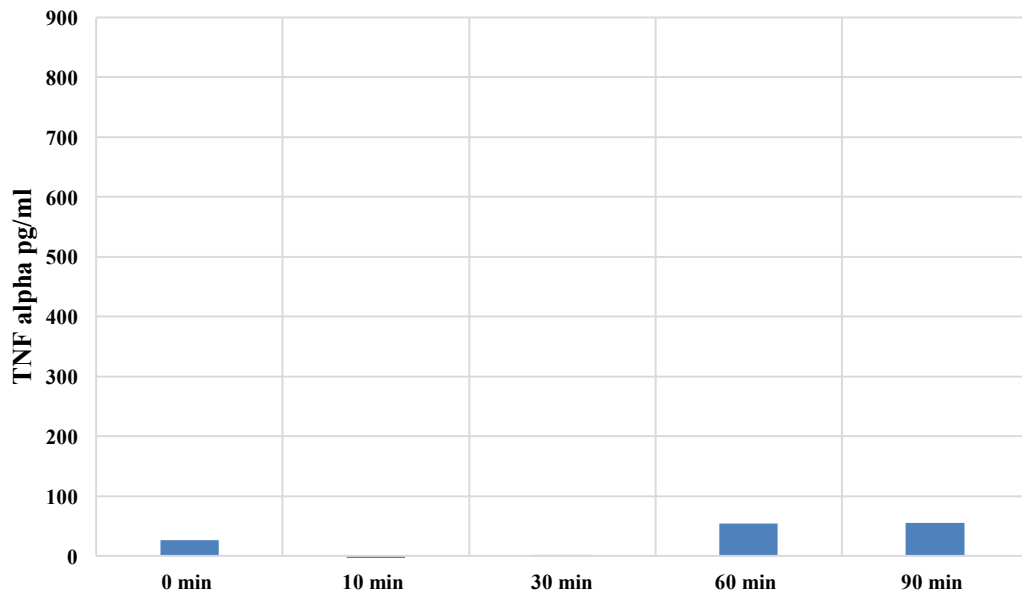

Figure 43: Dynamic control minus static control values (TNF- $\alpha$  DEHP plasticised PVC).

### TNF alpha liquid DEHP static control and dynamic control

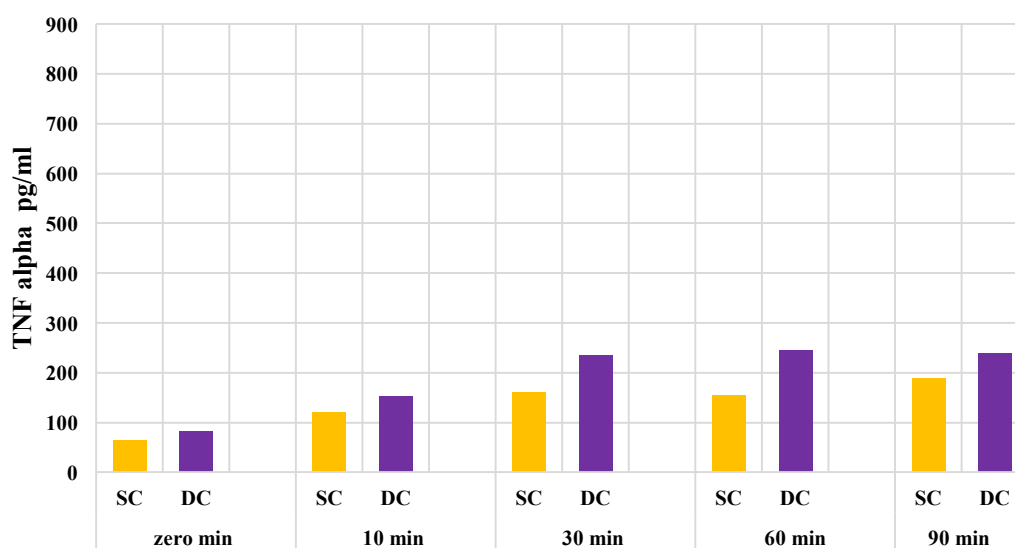

Figure 44: Static and dynamic control samples (TNF- $\alpha$  liquid DEHP).

### Liquid DEHP (Dynamic control -Static control)

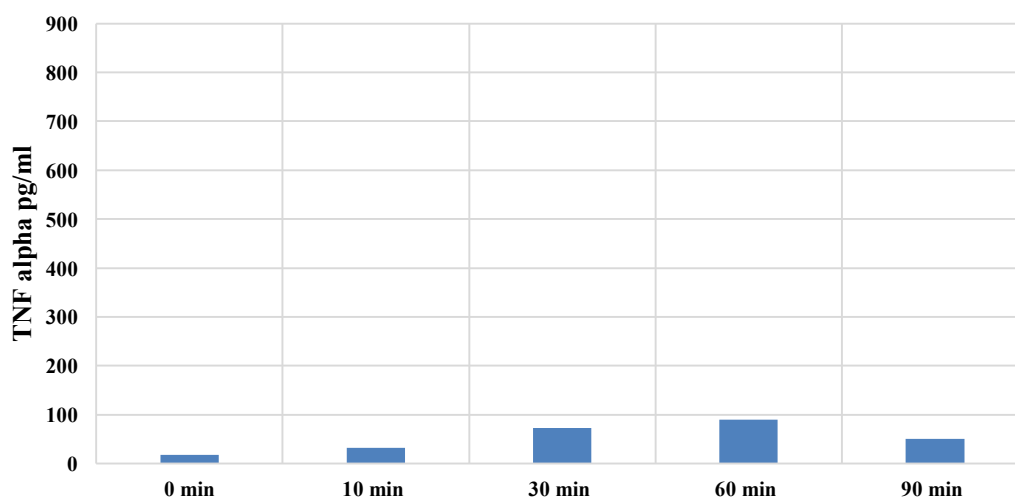

Figure 45: Dynamic controls minus static controls (TNF- $\alpha$  liquid DEHP).

From the above figures, TNF- $\alpha$  with both initiators (DEHP plasticised PVC and liquid DEHP) confirmed a response which demonstrates an activation process for this cytokine with exposure to the initiator. T-test analysis was performed across the in different weights and volumes of initiators. In common with the study of IL-6,

TNF- $\alpha$  shows an upregulation associated with exposure and further suggests that higher weights and volumes of initiator are associated with a greater response, the most significant responses were observed with 0.5 gram, 0.4 gram and 0.3 gram DEHP plasticised PVC and 0.5 ml ,0.4 ml and 0.3 ml liquid DEHP  $p < 0.005$  in all cases when compared to baseline. These levels were correlated with agitation time starting from 30 min onwards.

Static and dynamic control samples as compare to the other samples with initiators showed lower levels and the difference between control samples as seen in figure 43 and figure 45 confirmed the effect of initiators in the expression of the cytokine of interest.

#### **5.4 Summary**

1. IL-6 and TNF- $\alpha$  results suggested that DEHP plasticised PVC and liquid DEHP itself are considered as pro-inflammatory initiators leading to the triggering of inflammatory cascades in the blood.
2. Exposing blood to different weights of DEHP plasticised PVC and liquid DEHP showed a significant increase in the cytokine levels. Higher weights and volumes are associated with higher overexpression peaks of IL-6 and TNF- $\alpha$ .
3. The optimal agitation time which is associated with the upregulation of both cytokines occurs starting from 30 min onwards.

# **Chapter 6: Clinical study methodology**



## **6 : Clinical study methodology**

### **6.1 Objectives**

The objective of this section of the current project is to determine a number of factors relating to the suitability of our proposed approach to assessing the propensity for patients to exhibit a heightened inflammatory response to open-heart surgery, prior to the operative procedure. These factors include the following;

- 1. The most appropriate plasma marker.**
- 2. The most appropriate initiator**
- 3. The most appropriate detector approach**
- 4. The correlation between measured cytokine species and adverse clinical outcomes of known inflammatory origin.**

Although a similar, very small scale study, had been carried out in the past by this research group, highlighting some degree of correlation between measured IL-6 in contact activated blood samples and clinical outcome (Gourlay 2006), it was thought essential to repeat this procedure on a larger scale under similar clinical conditions and using additional potential markers and initiators to ensure that we see the same effect and to optimize the overall process. To this end, in the present study we investigated the upregulation of the following plasma markers of the inflammatory response and blood initiators:

#### **Initiators**

1. Ground DEHP plasticised PVC
2. Liquid DEHP

#### **Markers**

1. IL-6
2. TNF- $\alpha$
3. CRP

Two methods of measuring the markers in the blood samples were utilized to identify the quickest and most suitable approach in terms of delivering a clinical device for patient screening. In addition to assessing the most appropriate technique in terms of processing time, the results of these studies will enable the assessment of the correlation between the two techniques in terms of measured values. The two techniques employed were, conventional enzyme linked immunosorbent assay ELISA measurement and Fourier Transform Infrared Spectroscopy (FTIR). Both of these techniques are widely available, used in the measurement of biological markers, but differ in terms of the complexity of the process and the time from sample collection to data output.

#### **6.1.1 ELISA assay technique**

The ELISA technique is now considered to be the industry standard for the measurement of biomolecules in blood, both under laboratory and clinical conditions. The technique has been described in detail in chapter 4, but is considered to be an accurate methodology in this field. The kits required to perform ELISA assays are commercially available and are relatively easy to perform. However, the technique is somewhat complex, requires multiple steps and is very time consuming. Most laboratory ELISA assays take in excess of 8 hours to complete and derive data. Despite the complexity of the ELISA approach, the reliability of this technique suggests that it may lend itself to the development of a handheld device for molecular measurement in the field.

#### **6.1.2 Fourier Transform Infrared Spectroscopy (FTIR)**

FTIR is a rapid, label free and non-destructive technique for the measurement of a broad range of molecules, both of biological and non-biological origin. Currently its

most important area of application is in measuring the fingerprint region (very small quantity)(Baker et al. 2014), but its use in biomarker detection is growing significantly, particularly in the detection of cancers (Diem, Griffiths, and Chalmers 2008; Bellisola and Sorio 2012; Farhane et al. 2015). The technique, carried out on plasma or serum samples generally, produces multiple spectrums with high sensitivity that identify various molecular markers in the sample.

Both techniques generate molecular measurement of various species and are dependent upon known concentrations of known molecules to create calibration curves for accurate measurement. In the context of the proposed POC assay device, both techniques offer some promise of success, but generally the FTIR technique is faster and requires fewer steps in the measurement process. However, ELISA is the laboratory standard against which any new technique must be measured and some high degree of correlation between a new technique such as FTIR and ELISA is essential if any degree of confidence in measurement can be obtained.

## **6.2 The clinical protocol**

The clinical study was carried out at the University of Kirrikkale associated hospital in Ankara, Turkey under local ethics approval. The study was carried out on patients undergoing elective first time open heart surgery for a broad range of cardiovascular lesions, including coronary and valvular diseases. It is crucial to this project that we study sequential patients with no influence of procedure type or gender. The primary focus is to see by assay the propensity of these patients to exhibit an inflammatory response prior to surgery and to assess those with an apparent heightened propensity in terms of the clinical signs of inflammatory impact in the post surgical period. As the focus of this work is to develop a screening assay technology, the peri-surgical

response was not considered and additional blood samples during the surgical procedure were not taken in an effort of mimic the actual intended clinical application of the device.

### **6.2.1 Patient Population**

Patients undergoing first time elective open-heart surgery for the correction of coronary or valvular lesions were recruited to the study. These patients were sequential and all were recruited in accordance with the local ethics committee requirements. All patients provided written consent to the study. 52 patients were selected for the study, this number being determined by the available timeframe for the study.

### **6.2.2 Clinical Procedures**

All patients underwent cardiopulmonary bypass supported open-heart surgery for the repair of either coronary or valvular lesions. The CPB system consisted of a roller pump with a membrane oxygenator (Dideco Compactflo Evo, Sorin Group, Mirafidola, Modena, Italy). A priming volume 1500 ml Isolyte-S (Ec-Baxter, Istanbul, Turkey) was used to prime the system and a flow index of 2.4 was employed during the procedure. 5000 units of heparin was added. After anticoagulation with heparin (300U/kg), Activating clotting time (ACT) was kept over 400 seconds. Core temperature was reduced to 33°C during CPB and rewarmed at release of the aortic cross clamp. 1000 ml cardioplegia was employed with 500 ml given as an initial dose and further 500 ml doses given every 20 minutes. This is the standard CPB protocol at this clinical. During the procedures CPB time, aortic cross clamping time and other perfusion related metrics were recorded.

### 6.2.3 Patient Data Harvesting

The normal range of patient demographics were collected prior to surgery and broad surgical and perfusion parameters were recorded from the CPB record. Post-surgery the patients clinical course was recorded with an emphasis on markers of inflammatory response.

#### Patient Demographics

The following parameters were recorded;

Age (years)
Gender (Male/Female)
Height (cm)
Weight (kg)
BSA (m <sup>2</sup> )
Operative Procedure
Euroscore (Low/Medium/High)

**Table 10:** Basic Patient Demographic Data collected.

#### Cardiopulmonary Bypass Parameters.

The following CPB parameters were recorded.

Blood Flow (L/min)
Cardiopulmonary Bypass Time (min)
Aortic Cross Clamp Time (min)
Patient Core Temperature (°C)
Volume of Fluid Transfused

**Table 11:** Basic CPB parameters recorded in all patients.

#### Post-operative observations recorded.

The focus of this study was the identification of significant post-operative complications associated with an inflammatory origin. The measured parameters were as follows, and are in keeping with the consensus on SIRS(landis 2010).

Temperature (°C)
WBC Count (mm <sup>3</sup> )
Blood Pressure (High/Low/Normal)
ITU stay (days)
Heart Rate (High/Low/Normal)
Respiratory Rate (High/Low/Normal)
Total Hospital stay (days)

**Table 12:**Post-operative observations recorded.

#### 6.2.4 Blood sampling protocol

Blood (8ml) was taken by venipuncture from all patients prior to the surgery. The blood samples were transferred from the aspiration syringe to EDTA tubes for transfer to the laboratory for processing. All samples were labelled with the patient's unique identifier and kept on ice during the transfer period, following the local safety protocols for the handling of patient blood and blood products.

#### 6.2.5 Blood processing protocol

The blood was split into 4 aliquots and each aliquot was processed in the following manner;

<b>Static Control</b>	2 ml blood only
<b>Dynamic Control</b>	2 ml blood only
<b>Ground DEHP plasticised PVC</b>	2 ml blood + 0.5 gram DEHP plasticised PVC
<b>Liquid DEHP</b>	2 ml blood + 0.5 ml liquid DEHP

**Table 13:**Destination of each aliquot of patient blood. One 2ml aliquot was processed for each step as outlined above.

Once each activation well was primed with 2 ml of patient blood, the following steps were initiated.

<b>Blood Processing Step</b>	<b>Description</b>
<b>1</b>	Agitation at room temperature (for 30 min)
<b>2</b>	Remove blood (1 ml from each well in addition to the static control and dynamic control samples by using polycarbonate syringe and Eppendorf tube ).
<b>3</b>	Separate plasma by spinning the blood in a centrifuge (13000 RPM in 10 min).
<b>4</b>	Transfer plasma to cryovial tubes and store at -80°C for further analysis

**Table 14:** Blood processing protocol performed on all patient blood samples.

Once all samples had been gathered, they were transferred from Turkey to Glasgow in dry ice and immediately transferred to -80°C upon arrival. The samples were ultimately defrosted and prepared for the two assay procedures. Three assays were carried out using the ELISA technique for the assessment of TNF- $\alpha$ , IL-6 and CRP and once these values had been determined and compared with the clinical outcome, FTIR assay of the molecule with the best correlation to the clinical outcomes was performed.

### **6.2.6 ELISA assay planning and procedure**

As described earlier in chapter 4, ELISA is the standard laboratory technique for the measurement of a vast array of biomolecules. In the present study, three kits, IL-6, TNF- $\alpha$  and C-reactive protein molecules were purchased from (RD systems a biotechne brand, Abingdon Science Park, UK) to carry out the analysis. The company IFU's were followed for all measurements, largely as described in Chapter 4 (ELISA assay). Details of the procedures are contained in the supplier data sheets, Appendix D.

### **Samples distribution in the ELISA plates**

As the ELISA plates have 96 wells, the first 2 columns were used for standard samples and the remaining for the patient plasma samples. Due to the number of

samples for processing, the samples were distributed to three plates of ELISA for each molecular species as outlined below.

PLATE 1												
	1	2	3	4	5	6	7	8	9	10	11	12
A	Standard	standard	P1 SC	P3 SC	P5 SC	P7 SC	P9 SC	P11 SC	P13 SC	P15 SC	P17 SC	P19 SC
B	Standard	standard	P1 DC	P3 DC	P5 DC	P7 DC	P9 DC	P11 DC	P13 DC	P15 DC	P17 DC	P19 DC
C	Standard	standard	P1 DEHP PPVC	P3 DEHP PPVC	P5 DEHP PPVC	P7 DEHP PPVC	P9 DEHP PPVC	P11 DEHP PPVC	P13 DEHP PPVC	P15 DEHP PPVC	P17 DEHP PPVC	P19 DEHP PPVC
D	Standard	standard	P1 DEHP	P3 DEHP	P5 DEHP	P7 DEHP	P9 DEHP	P11 DEHP	P13 DEHP	P15 DEHP	P17 DEHP	P19 DEHP
E	Standard	standard	P2 SC	P4 SC	P6 SC	P8 SC	P10 SC	P12 SC	P14 SC	P16 SC	P18 SC	P20 SC
F	Standard	standard	P 2 DC	P 4 DC	P 6 DC	P8 DC	P 10 DC	P 12 DC	P14 DC	P 16 DC	P18 DC	P 20 DC
G	Standard	standard	P2 DEHP PPVC	P4 DEHP PPVC	P6 DEHP PPVC	P8 DEHP PPVC	P10 DEHP PPVC	P12 DEHP PPVC	P14 DEHP PPVC	P16 DEHP PPVC	P18 DEHP PPVC	P20 DEHP PPVC
H			P2 DEHP	P4 DEHP	P6 DEHP	P8 DEHP	P10 DEHP	P12 DEHP	P14 DEHP	P16 DEHP	P18 DEHP	P20 DEHP
PLATE 2												
	1	2	3	4	5	6	7	8	9	10	11	12
A	Standard	standard	P21 SC	P23 SC	P25 SC	P27 SC	P29 SC	P31 SC	P33 SC	P35 SC	P37 SC	P39 SC
B	Standard	standard	P21 DC	P23 DC	P25 DC	P27 DC	P29 DC	P31 DC	P33 DC	P35 DC	P37 DC	P39 DC
C	Standard	standard	P21 DEHP PPVC	P23 DEHP PPVC	P25 DEHP PPVC	P27 DEHP PPVC	P29 DEHP PPVC	P31 DEHP PPVC	P33 DEHP PPVC	P35 DEHP PPVC	P37 DEHP PPVC	P39 DEHP PPVC
D	Standard	standard	P21 DEHP	P23 DEHP	P25 DEHP	P27 DEHP	P29 DEHP	P31 DEHP	P33 DEHP	P35 DEHP	P37 DEHP	P39 DEHP
E	Standard	standard	P22 SC	P24 SC	P26 SC	P28 SC	P30 SC	P32 SC	P34 SC	P36 SC	P38 SC	P40 SC
F	Standard	standard	P 22 DC	P24 DC	P 26 DC	P28 DC	P30 DC	P32 DC	P34 DC	P36 DC	P38 DC	P40 DC
G	Standard	standard	P22 DEHP PPVC	P24 DEHP PPVC	P26 DEHP PPVC	P28 DEHP PPVC	P30 DEHP PPVC	P32 DEHP PPVC	P34 DEHP PPVC	P36 DEHP PPVC	P38 DEHP PPVC	P40 DEHP PPVC
H			P22 DEHP	P24 DEHP	P26 DEHP	P28 DEHP	P30 DEHP	P32 DEHP	P34 DEHP	P36 DEHP	P38 DEHP	P40 DEHP
PLATE 3												
	1	2	3	4	5	6	7	8	9	10	11	12
A	Standard	standard	P41 SC	P43 SC	P45 SC	P47 SC	P49 SC	P51 SC				
B	Standard	standard	P41 DC	P43 DC	P45 DC	P47 DC	P49 DC	P51 DC				
C	Standard	standard	P41 DEHP PPVC	P43 DEHP PPVC	P45 DEHP PPVC	P47 DEHP PPVC	P49 DEHP PPVC	P51 DEHP PPVC				
D	Standard	standard	P41 DEHP	P43 DEHP	P45 DEHP	P47 DEHP	P49 DEHP	P51 DEHP				
E	Standard	standard	P42 SC	P44 SC	P46 SC	P48 SC	P50 SC	P52 SC				
F	Standard	standard	P42 DC	P44 DC	P46 DC	P48 DC	P 50 DC	P52 DC				
G	Standard	standard	P42 DEHP PPVC	P44 DEHP PPVC	P46 DEHP PPVC	P48 DEHP PPVC	P50 DEHP PPVC	P52 DEHP PPVC				
H			P42 DEHP	P44 DEHP	P46 DEHP	P48 DEHP	P50 DEHP	P52 DEHP				

**Table 15:** Plasma sample distribution map for all ELISA plates.

All measurements were carried out in duplicate using spectrophotometric assay and the concentrations calculated using the reference calibration curves derived from the standard solutions.

### Plate reader and standard curve

The plates were read using an Ascent spectrophotometry system (Thermo fisher scientific UK) as described in Chapter 4, section 4.5.2 of this thesis. Standard concentration were plotted for each ELISA microplate for all molecules of interest. The derived mathematical equation for the trendline curve was used for each sample measurement to derive the actual relative concentration of each sample and molecule.



### 6.2.7 Fourier transform infrared spectroscopy (FTIR)

Fourier transform infrared spectroscopy (FTIR) is a label-free and non-destructive technique. The technique is rapid (between 1 and 10 minutes, depending on whether the sample is wet or dry during measurement). In the present study both wet and dry measurements were taken for comparison with the ELISA data and to determine which approach provided the most accurate data.

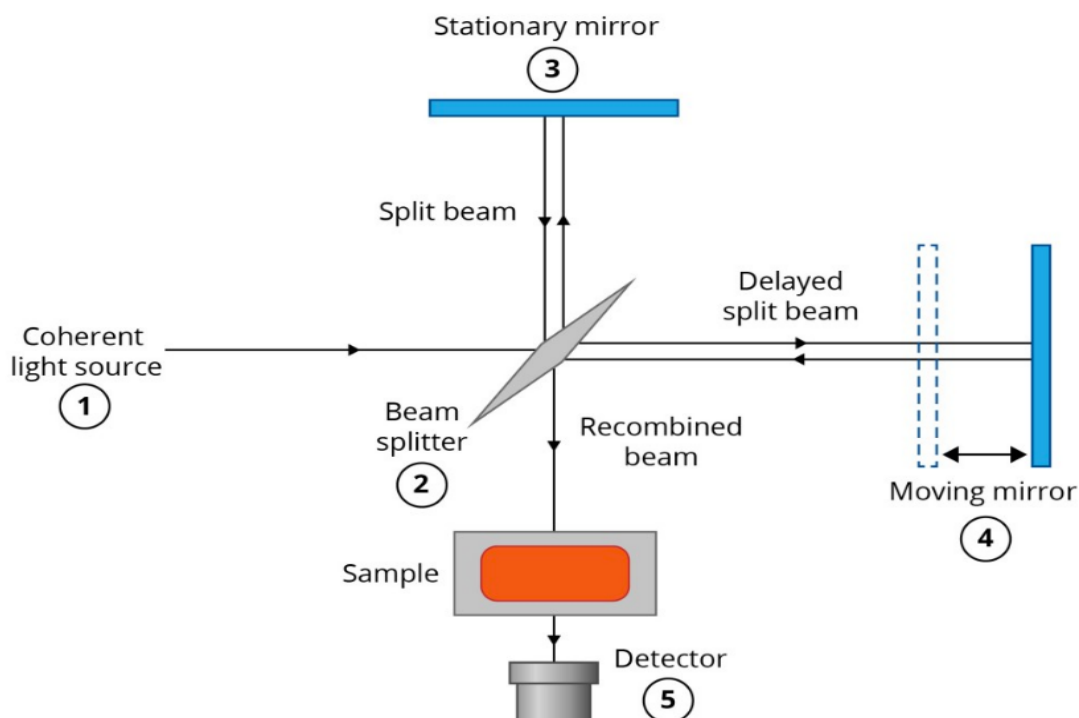

**Figure 46:** Fourier transform infrared technique (principle of operation). The incoming light beam from the light source is divided by the beam splitter into two beams, the first beam is reflecting from the stationary mirror whereas the second beam is reflecting from the moving mirror. Both beams are combined and pass through the sample. The results are displayed in a wide range of spectra wavelengths. (Taken from: <http://keit.co.uk/>)

#### Sample preparation for FTIR assessment

FTIR measurement does not require complex sample preparation. The technique can be carried out using plasma or serum samples and measurements can be performed when the sample is both wet and dry. The advantage of processing samples when wet is time related, wet samples will produce results within 1 minute, whereas dry

samples may take up to 10 minutes. The technique requires only microliters of plasma/serum, therefore analysis can be performed on very small blood samples, for example a needle stick will produce enough whole blood to carry out this assay technique.

### **Protocol for the work**

1. Clean the diamond crystal by virkon and ethanol to ensure a clean pathway.
2. Open background page in the FITR software to allow gathering of all spectra that resulting from the sample.
3. Drop 1 microliter of the sample onto the crystal.
4. Scan to collect the wet scan wavelengths of the sample (wet scan).
5. Wait 10 minutes and rescan again (for dry scan). This step allows the water to be evaporated from the sample and increases the accuracy of the scan.

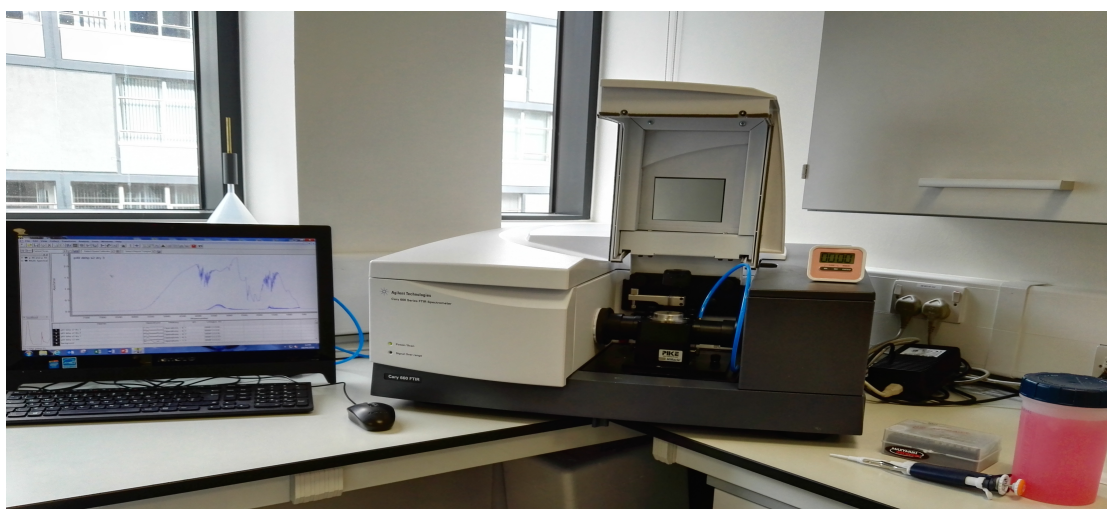

**Figure 47:** FTIR system employed in this study. (Fourier transform infrared spectrometer (Agilent Technology UK), Timer, Virkon disinfectant liquid ). Using standard solutions, it is possible to create a concentration curve for the FTIR scans and to accurately determine the spectral component of interest.

### **FTIR results analysis**

Patients absorbances were calculated in terms of the mean of two dry scans for two spots. MATLAB (Mathworks, USA) was used to plot all data as seen in the appendix I. Subsequently, we can specify the peak values of DEHP plasticised PVC for each patient from the data, Then, calculate the concentrations for these peaks based on the standard curve trendline equation.

The standard curve was generated based on the provided data sheet from the supplier (RD systems a biotechne brand, Abingdon Science Park, UK). Standard samples absorbances were plotted against the known IL-6 concentrations. The standard curve equation was then used to calculate IL-6 concentrations in all patients' samples.

### **6.3 Statistical analysis**

Statistical analysis of the data, comparing measured molecular data with recorded clinical data was carried out using Minitab 17 software (Minitab Inc, Pennsylvania,USA). All patient data was divided into two groups:SIRS and non-SIRS based on the post-operative clinical observations. For the analysis of patients, data descriptive statistics were used. For continuous variables, normality tests were checked. An appropriate non – parametric test was chosen, since the data was not normally distributed. Comparisons of continuous variables between groups were applied using the Mann–Whitney ,Wilcoxon tests and t-test. A p value < 0.05 was considered statistically significant.

### **Regression analysis**

In order to identify the sensitive inflammatory marker in blood prior to OHS, we used a binary logistic regression technique. This permits the modelling of the relationships between a dependent variable and a number of predictor variables. The

aim here was to develop a model, which can predict SIRS patients. To do this, the data was be divided into two groups: model and prediction group.

The model fit, (how well we capture the variability) was assessed using the Akaike Information Criterion (AIC) and the area under the curve (AUC): smaller AIC values indicate better models while higher AUC indicates the best model to fit the data (Akaike 1974) (Hosmer Jr and Lemeshow 2004).

AUC = 0.5	No discrimination (i.e., might as well flip a coin)
$0.7 \leq \text{AUC} < 0.8$	Acceptable discrimination
$0.8 \leq \text{AUC} < 0.9$	Excellent discrimination
$\text{AUC} \geq 0.9$	Outstanding discrimination

**Table 16:**Area under curve (AUC) classification.

#### 6.4 Summary

1. The clinical study will investigate the effect of DEHP plasticised PVC and liquid DEHP on the blood samples of a cohort of patients prior to open heart surgery.
2. The response will be measured in terms of the three rapid molecules IL-6, TNF- $\alpha$  and CRP by using two different techniques (ELISA and FTIR).
3. A proper statistical analysis will be performed to choose the most appropriate sensitive cytokine, initiator and the best technique of measuring cytokine concentration to be used in the device development phase.

# **Chapter 7: Clinical study results**

## **7 : Clinical study results**

### **7.1 Introduction**

The objectives of the clinical study are outlined in the previous chapter and revolve around determining the following factors, and are related to the destination technology that is the focus of the present study, and the sensitivity of the selected markers in identifying the propensity for inflammatory response in a population to Open-heart surgery patients;

1. What is the most appropriate initiator of the IR in isolated patient samples with the objective of deployment in a patient screening test.
2. What is the most sensitive marker of the IR in isolated patient blood samples from the molecules available to our laboratory.
3. What is the most appropriate measurement technique for markers of inflammation in isolated clinical samples.
4. What is the correlation between a heightened response to blood contact activation in an isolated patient blood sample taken prior to OHS and the indicators of IR in the post-operative period.

### **7.2 Patient Demographics**

All 52 patients underwent open-heart surgical repair of a number of cardiac lesions. The patient demographics of this sequential group of patients is shown in table 17.

<b>Demographical and CPB parameters</b>	
<b>Gender (Male/Female)</b>	36 male and 16 female
<b>Age (Years )</b>	58.3 ± 11.4
<b>Height (cm)</b>	167.9 ± 8.8
<b>Weight (kg)</b>	77.5 ± 12.3
<b>BSA (m2)</b>	1.87 ± 0.17
<b>Blood flow rate ( L/min)</b>	4.47 ± 0.41
<b>Aortic cross clamping time ( min)</b>	79.38 ± 42.57
<b>CPB time (min)</b>	139.75± 72.05
<b>Core temperature during the surgery (°C)</b>	34.33 ± 3.46
<b>Procedure</b>	42 CABG, 5 HVR, 2 ASD, 2 AOG and 1TCA

**Table 17:** Summary of the basic patient demographics of the clinical study group. CABG (Coronary artery bypass graft), HVR (heart valve replacement), ASD (Arterial septal defect), AOG (ascending aorta graft), TCA(Thoracic and arcus aorta replacement). All patients' demographical data can be seen in appendix H.

As the objective of the study was to investigate a correlation between the measured cytokine response taken pre-surgery and the clinical markers of observed inflammatory response post-surgery, the clinical study also collected data relating to the observation of inflammatory processes post-surgery. These markers were discussed in the previous chapter, and the clinical observations during the post-operative period are detailed in table 18 below.

Post-operative clinical data									
P.No	Temperature (°C)	WBCs (mm <sup>3</sup> )	Heart rate	Blood pressure	Respiratory rate	Hospital stay (Days)	ITU Stay (Days)	SIRS	Complications
1	36.7	8300	Normal	Normal	Normal	8	2	NO	
2	36	10400	Normal	Normal	Normal	9	2	NO	
3	38.5	14000	High	Normal	Normal	7	4	YES	
4	37.1	11000	High	Normal	Normal	7	2	NO	
5	36	6600	Normal	Normal	Normal	7	3	NO	
6	36.5	8700	Normal	Normal	Normal	6	3	NO	
7	39.5	13000	Normal	High	Normal	7	4	YES	
8	38.6	15700	Normal	Normal	Normal	10	4	YES	
9	36.2	7200	Normal	Normal	Normal	14	3	NO	
10	39.4	12700	Normal	Normal	Normal	8	5	YES	
11	37.3	14300	Normal	Normal	Normal	6	2	NO	
12	38	15600	Normal	Normal	High	7	5	YES	
13	38.3	13400	Normal	Normal	Normal	8	4	YES	
14	37.2	5500	Normal	Normal	Normal	8	2	NO	
15	36.6	11200	Normal	Normal	Normal	5	2	NO	
16	36.1	6900	Normal	Normal	Normal	6	1	NO	
17	36	14800	Normal	Normal	Normal	5	2	NO	
18	37.2	8200	Normal	Normal	Normal	6	1	NO	
19	36.5	9000	Normal	Normal	Normal	6	1	NO	
20	37	7400	Normal	Normal	Normal	5	1	NO	
21	36.8	7700	Normal	Normal	Normal	9	2	NO	
22	37.2	12100	Normal	Normal	Normal	7	2	NO	
23	36.7	7800	Normal	Normal	Normal	5	2	NO	
24	38.7	13700	High	High	Normal	6	3	YES	
25	39.5	18800	Normal	Normal	Normal	6	4	YES	
26	36.3	6300	Normal	Normal	Normal	7	1	NO	
27	38.5	15200	Normal	Normal	Normal	7	4	YES	
28	40	13800	Normal	Normal	High	8	4	YES	ARDS
29	36.6	11000	Normal	Normal	Normal	6	3	NO	
30	37.5	9400	Normal	Normal	Normal	10	1	NO	
31	36.3	8300	Normal	Normal	Normal	6	3	NO	
32	36	10100	Normal	Normal	Normal	7	1	NO	
33	38	20400	High	High	Normal	9	4	YES	Died in ITU
34	36	15100	High	High	Normal	8	5	YES	Liver failure
35	36.5	5300	Normal	Normal	Normal	5	2	NO	
36	37.3	9000	Normal	Normal	Normal	7	2	NO	
37	37	14600	Normal	Normal	Normal	7	1	NO	
38	36	11300	High	Normal	Normal	7	2	NO	
39	36.8	9000	Normal	Normal	Normal	6	1	NO	
40	37.2	11000	Normal	High	Normal	6	3	NO	
41	37	5100	Normal	Normal	Normal	5	1	NO	
42	36.8	7600	Normal	Normal	Normal	7	1	NO	
43	37.3	10700	Normal	Normal	Normal	7	2	NO	
44	37	11300	Normal	Normal	Normal	6	1	NO	
45	36.5	10200	Normal	Normal	Normal	9	1	NO	
46	36.2	12700	Normal	Normal	Normal	7	2	NO	
47	37.6	10100	Normal	Normal	Normal	8	1	NO	
48	36.5	8500	Normal	Normal	Normal	5	3	NO	
49	37.4	13200	Normal	Normal	Normal	6	4	NO	
50	37.5	9000	Normal	Normal	Normal	8	1	NO	
51	36.8	11400	Normal	Normal	Normal	6	1	NO	
52	37	12500	Normal	Normal	Normal	6	1	NO	

**Table 18:** Post-operative clinical observations in all 52 patients studied.



Upon analysis of this data we were able to identify those patients who exhibited clear signs of the inappropriate activation of inflammatory processes that were impacting on clinical recovery. These patients are highlighted in table 19.

Complicated patients' post-operative data									
P.No	Temperature (°C)	WBCs (mm <sup>3</sup> )	Heart rate	Blood pressure	Respiratory rate	Hospital stay	ITU Stay	SIRS	Complications
3	38.5	14000	High	Normal	Normal	7	4	YES	
7	39.5	13000	Normal	High	Normal	7	4	YES	
8	38.6	15700	Normal	Normal	Normal	10	4	YES	
10	39.4	12700	Normal	Normal	Normal	8	5	YES	
12	38	15600	Normal	Normal	High	7	5	YES	
13	38.3	13400	Normal	Normal	Normal	8	4	YES	
24	38.7	13700	High	High	Normal	6	3	YES	
25	39.5	18800	Normal	Normal	Normal	6	4	YES	
27	38.5	15200	Normal	Normal	Normal	7	4	YES	
28	40	13800	Normal	Normal	High	8	4	YES	ARDS
33	38	20400	High	High	Normal	9	4	YES	Died in ITU
34	36	15100	High	High	Normal	8	5	YES	liver failure

**Table 19:** Post-operative clinical observations with patients considered to have complications or signs of possible inflammatory SIRS. Those patients were identified based on the defined criteria by the American College of Chest/Physicians / Society of Critical Care Medicine.

The patient demographic data associated with these "complicated" patients were then extracted and compared with the "uncomplicated" patients to determine whether there were any apparent demographic factors that might influence these findings. This analysis is summarised in table 20 below.

Demographic and CPB parameters	Complicated	Uncomplicated	P
Age (years)	57.75 ± 13.7121	58.475 ± 10.8107	0.84
Height (cm)	164.5 ± 7.2425	169.025 ± 9.0340	0.73
Weight (kg)	78 ± 10.9544	77.4 ± 12.7878	0.97
Euroscore (Low ,medium and high )	1.3333 ± 0.6513	1.25 ± 0.4385	0.61
Gender	1.4166 ± 0.5149	1.275 ± 0.4522	0.36
Blood flow rate	4.4166 ± 0.356	4.4855 ± 0.427	0.91
Aortic cross clamp	111.67 ± 68.8	69.7 ± 24.859	0.62**
CPB time	194.16 ± 117.11	123.425 ± 41.66	0.63**
Temperature during the surgery	33.53 ± 5.13	34.43 ± 2.832	0.99
Operation	6 CABG, 1 ASD, 2 HVR, 2 AOG and 1 TCA	35 CABG, 3 HVR and 2 ASD	

**Table 20:** Comparison of patient demographic data between those patients identified with signs of an exaggerated inflammatory response to CPB and those with a normal and uncomplicated clinical course. The data are represented by mean ± Standard deviation. Unpaired t-test was performed to determine the significant differences between complicated and uncomplicated groups. CABG (coronary artery bypass graft), ASD(Arterial septal defect), AOG( Ascending aorta graft), HVR(Heart valve replacement),TCA (Thoracic and arcus aorta replacement).

\*\*Aortic cross clamping and CPB time skewed due to one patient with highly complex and lengthy procedure ( patient 33).

It was clear from this analysis that there were no statistically significant differences between the patient groups in terms of the demographic factors analysed. This would suggest that there were no demographic factors that might indicate any observed inflammatory response, whether recorded prior to, or during the operative procedure. The patient populations were similar in terms of demographics and the analysis confirmed that there were no differences between the patient groups in terms of Euroscore, a factor thought to be indicative of post operative complication rate.

### 7.3 Results of Cytokine measurement using the ELISA technique.

As described in the chapter 6, all patients underwent an activation screening test in which patient blood was exposed to both liquid DEHP and ground DEHP plasticised polyvinylchloride (DEHPPVC). The results of these tests and the analysis process

for the 3 cytokines studied are shown in the section 7.3.1, section 7.3.2 and section 7.3.3.

### 7.3.1 IL-6 measurement

Standard curves were produced using standard concentrations of IL-6 supplied by the kit manufacturer. This standard curve and the associated curve equation were utilised to calculate the IL-6 concentration in each blood sample. Below is a representative IL-6 standard curve. All IL-6 standard curves can be seen in appendix E.

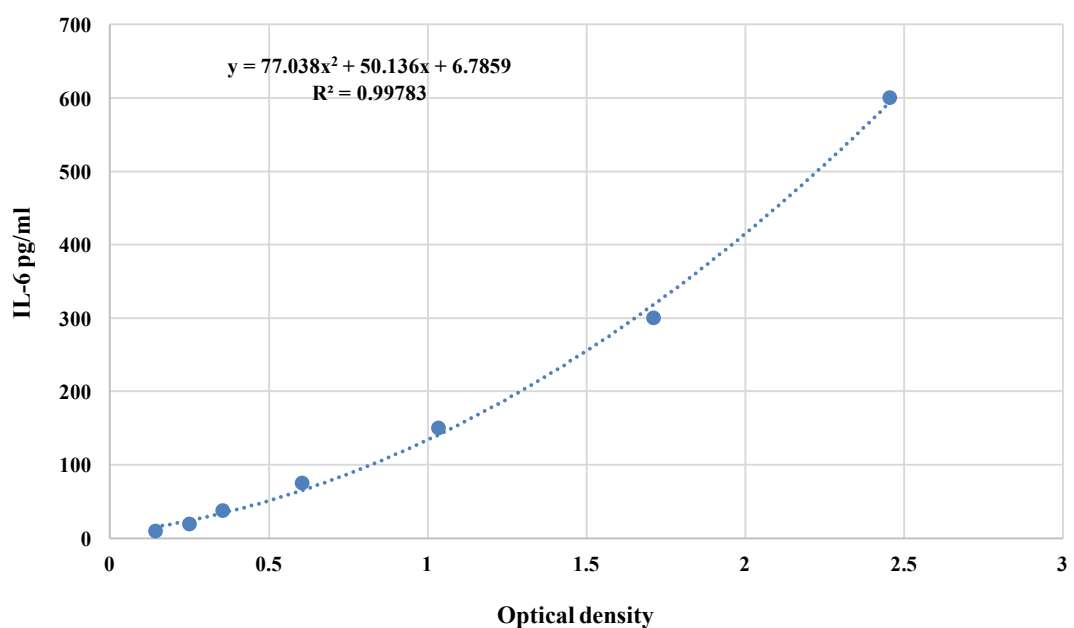

**Figure 48:** Representative IL-6 standard curve used in the assessment of patients' samples. Using the standard curves, the concentration of IL-6 in each blood sample was assessed post activation cycle. The results of this analysis for all 52 patients is shown in Figure 49 below.

The activation process was performed on all blood samples and in parallel both static and dynamic control samples were processed as outlined in the previous chapter. The principle behind this control measurement was to ascertain the impact of the agitation process in the expression of the cytokines of interest. In assessing the impact of the agitation, the measured cytokine value associated with the non-agitated

sample was subtracted from that of a non-exposure agitated sample. The results of this process are shown in figures 50 and 51.

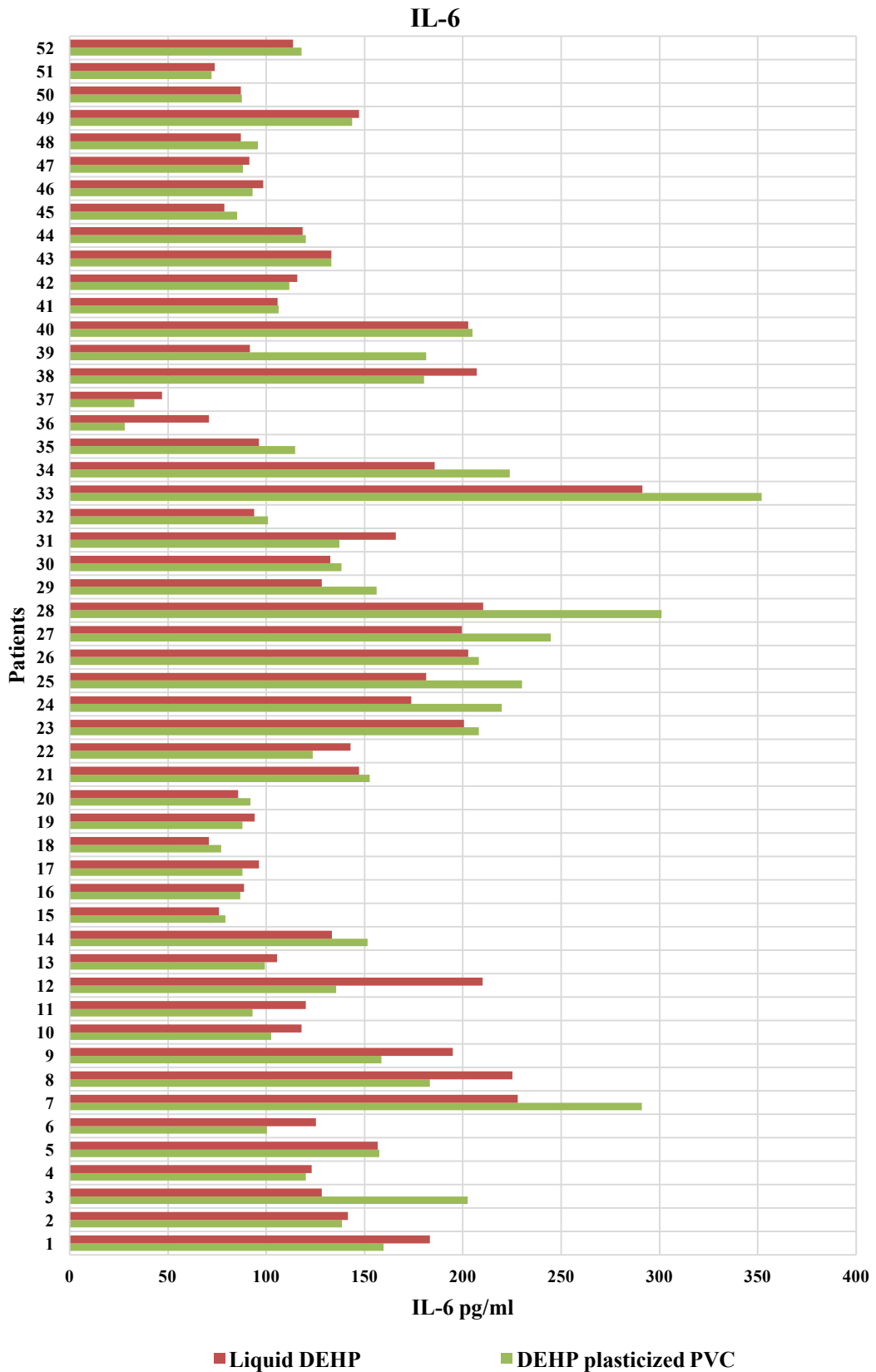
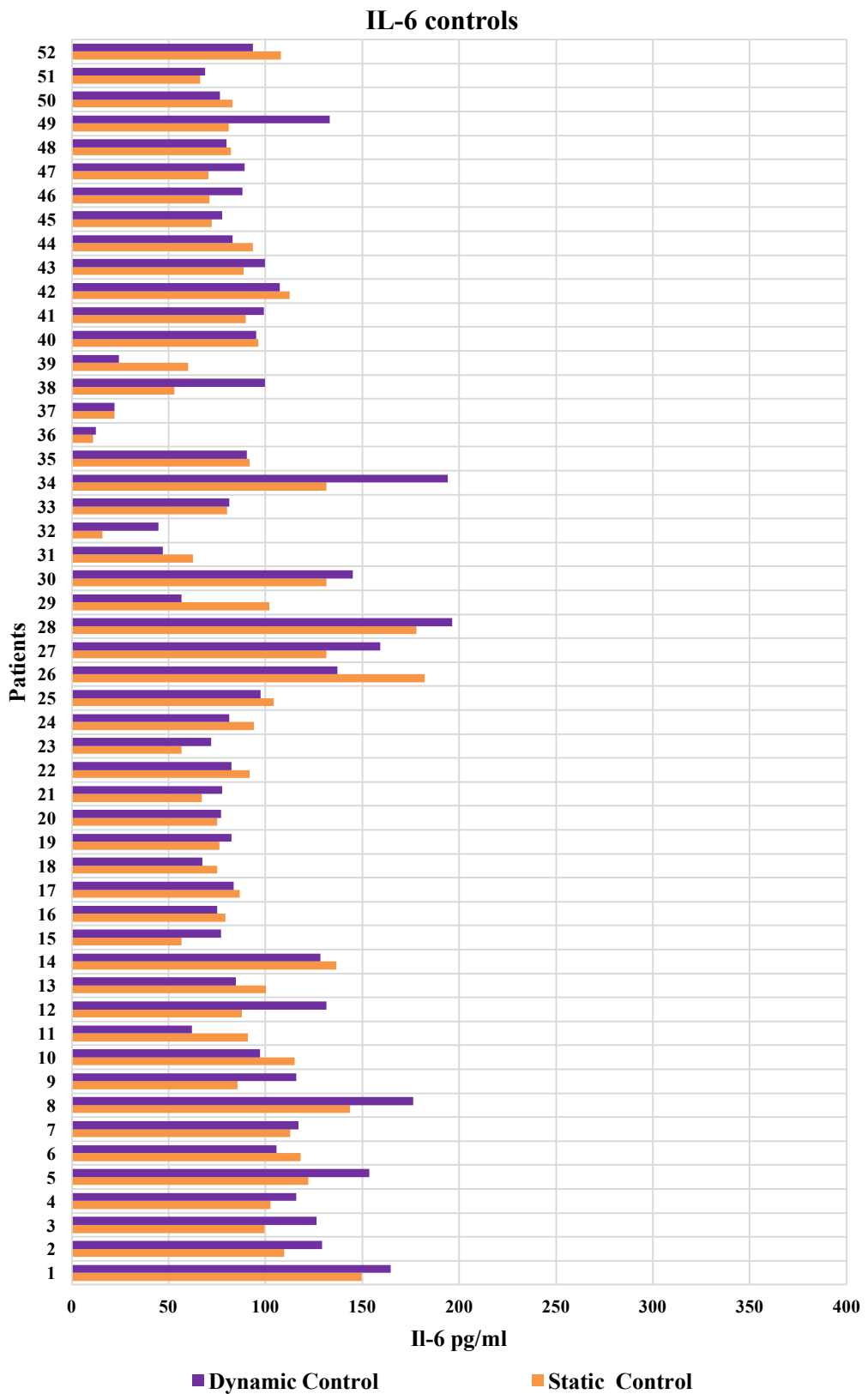
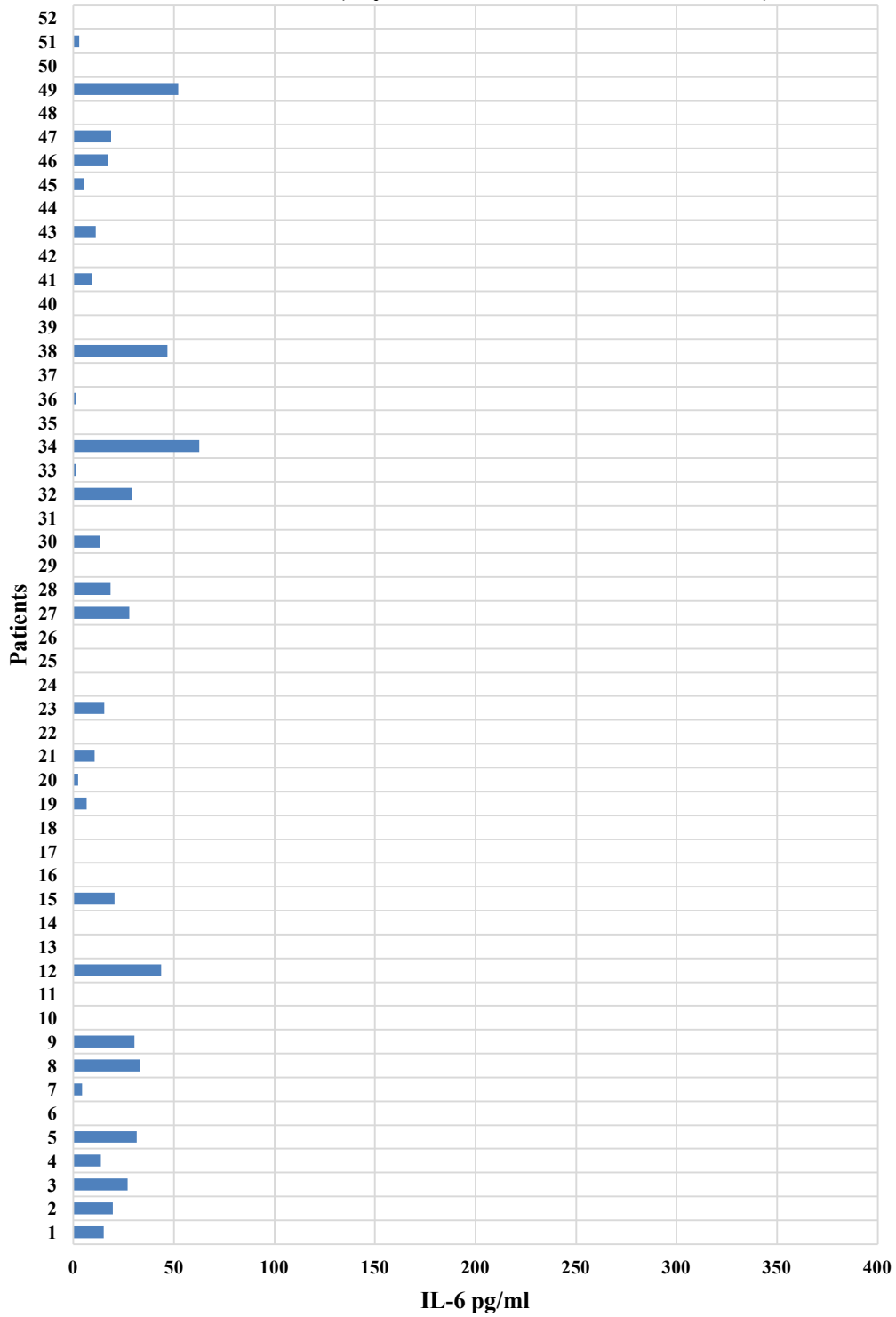

Figure 49:IL-6 measurements in pg/ml for all patients.



**Figure 50:**IL-6 Static and dynamic control values for all patients' samples.

### IL-6 ( Dynamic controls - Static controls)



**Figure 51:**IL-6 (Dynamic minus static control values) for all patients. This factor is indicative of the impact of the agitation process alone on the expression of cytokines in the blood sample.

It can be seen from figures 49, 50 and 51 that there are a wide range of responses to the activation process, together with a wide ranging control response. These findings are summarized in figure 52 which shows the maximum, minimum and median values for each process and for each initiator (DEHP plasticised PVC or Liquid DEHP). The control groups showed a lower response than the exposed agitated specimens, suggesting that the exposure to the materials elicits a response.

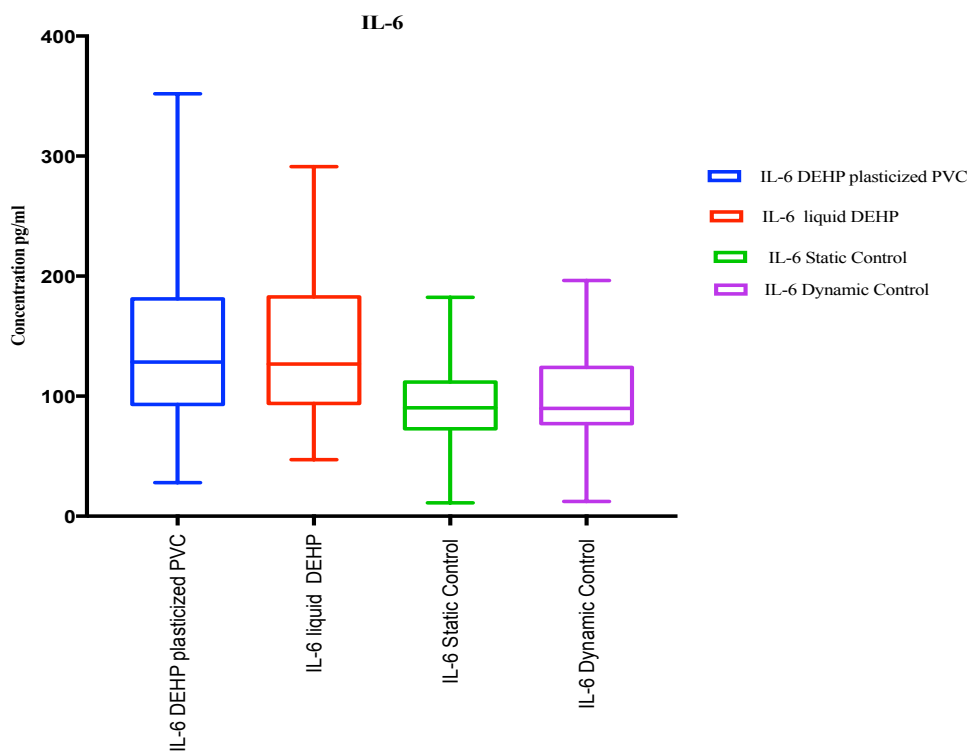

**Figure 52:** IL-6 maximum, minimum and median values for all patients' samples.

However, these levels require to be tested for significance and correlation with apparent systemic inflammatory response syndrome (SIRS) observations in the patient population of interest. This analysis will be demonstrated in the latter part of this chapter (section 7.5.2) by using Mann-Whitney and t-test for two sample based on the normality distribution of the data. If the p value is  $<0.05$  the data follows non normality distribution while if  $p > 0.05$  the data follows normal distribution.



### 7.3.2 TNF- $\alpha$ measurement

Standard curves were produced using standard concentrations of TNF- $\alpha$  supplied by the kit manufacturer. This standard curve and the associated curve equation were utilised to calculate the TNF- $\alpha$  concentration in each blood sample. Below is a representative TNF- $\alpha$  standard curve. All TNF- $\alpha$  standard curves can be seen in appendix F.

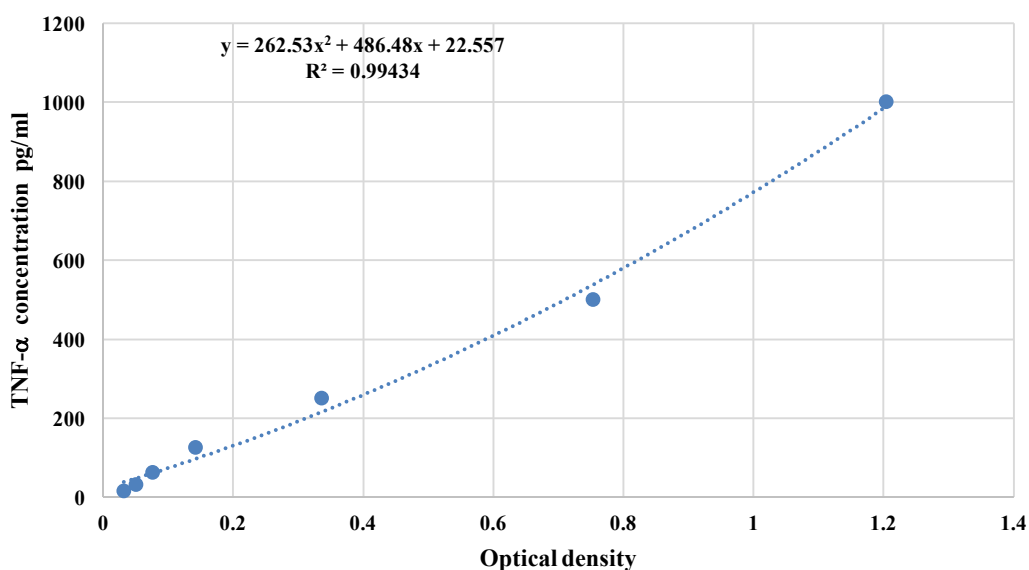

**Figure 53:** Representative TNF- $\alpha$  standard curve used in the assessment of patients' samples. Using the standard curves, the concentration of TNF- $\alpha$  in each blood sample was assessed post activation cycle. The results of this analysis for all 52 patients is shown in Figure 54 below.

The activation process was performed on all blood samples and in parallel both static and dynamic control samples were processed as outlined in the previous chapter. The principle behind this control measurement was to ascertain the impact of the agitation process in the expression of the cytokines of interest. In assessing the impact of the agitation, the measured cytokine value associated with the non-agitated sample was subtracted from that of a non-exposure agitated sample. The results of this process are shown in figures 55 and 56.

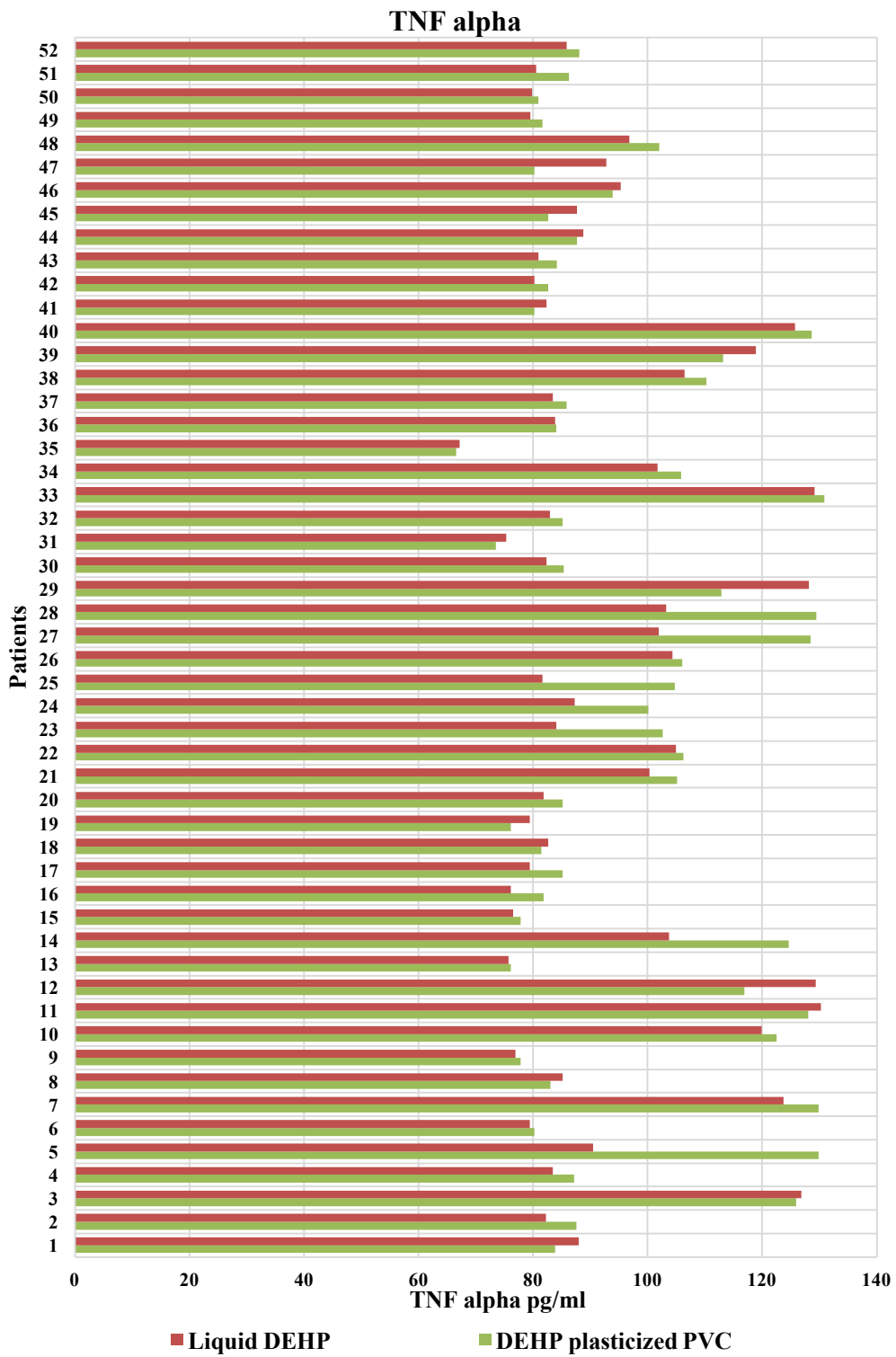
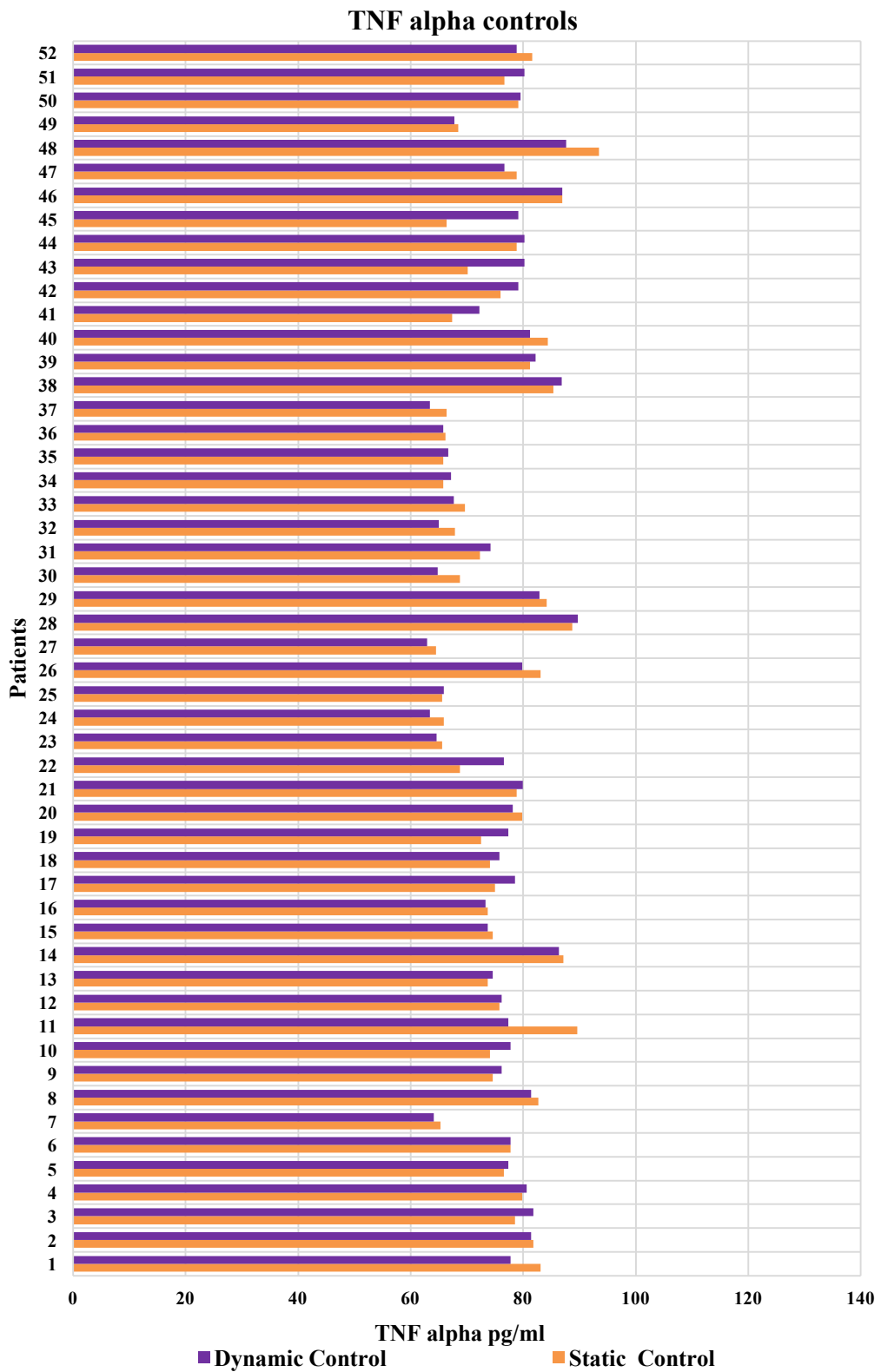
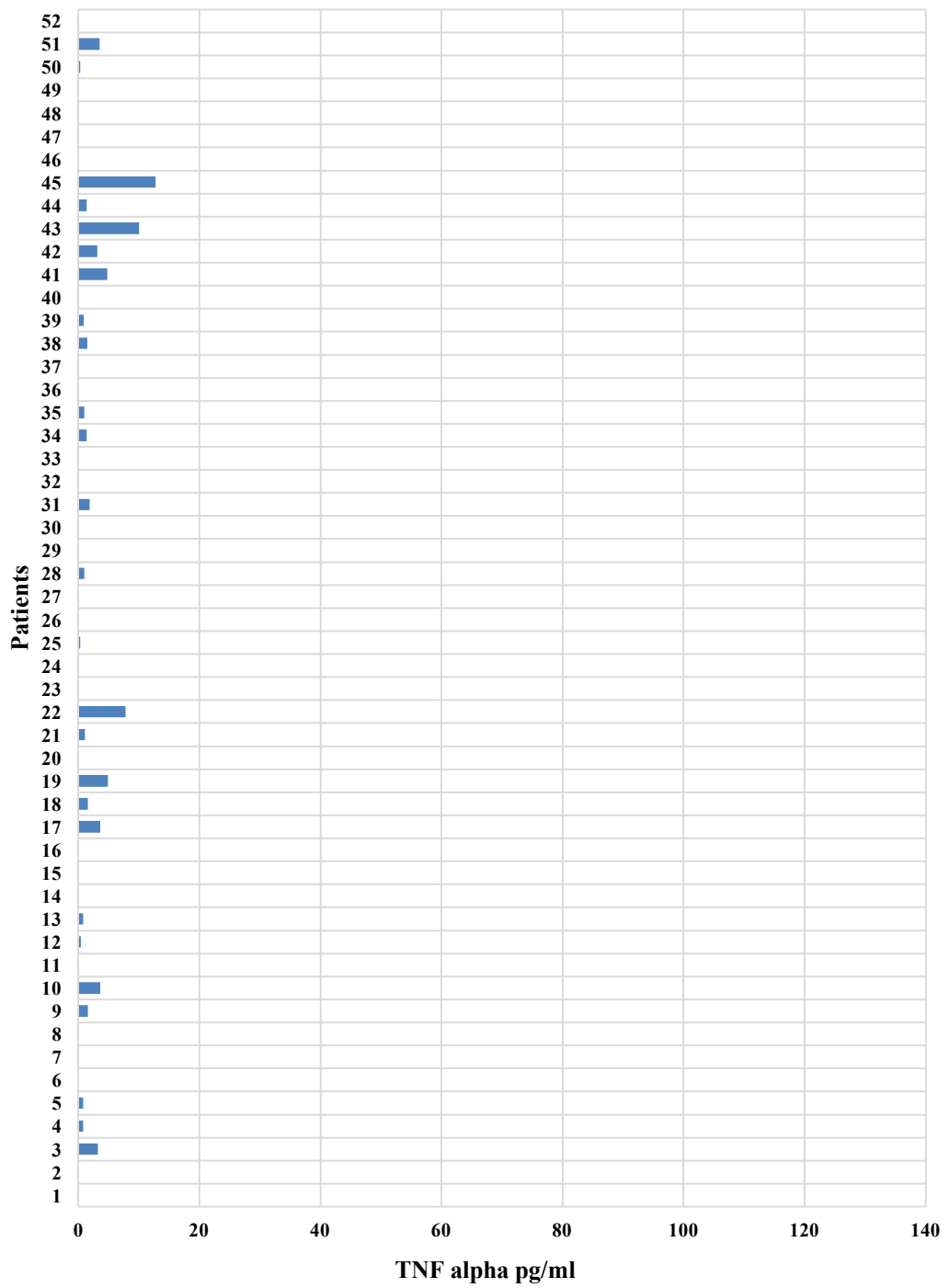

Figure 54: TNF $\alpha$ - measurements in pg/ml for all patients.



**Figure 55:** TNF- $\alpha$  static and dynamic control values for all patients' samples.

### TNF alpha ( Dynamic controls -Static controls )



**Figure 56:** TNF- $\alpha$ (dynamic minus static control values) for all patients. This factor is indicative of the impact of the agitation process alone on the expression of cytokines in the blood sample.

It can be seen from figures 54,55 and 56 that there are a wide range of responses to the activation process, together with a wide ranging control response. These findings are summarized in figure 57 which shows the maximum, minimum and median values for each process and for each initiator (DEHP plasticised PVC or liquid DEHP). The control groups showed a lower response than the exposed agitated specimens, suggesting that the exposure to the materials elicits a response.

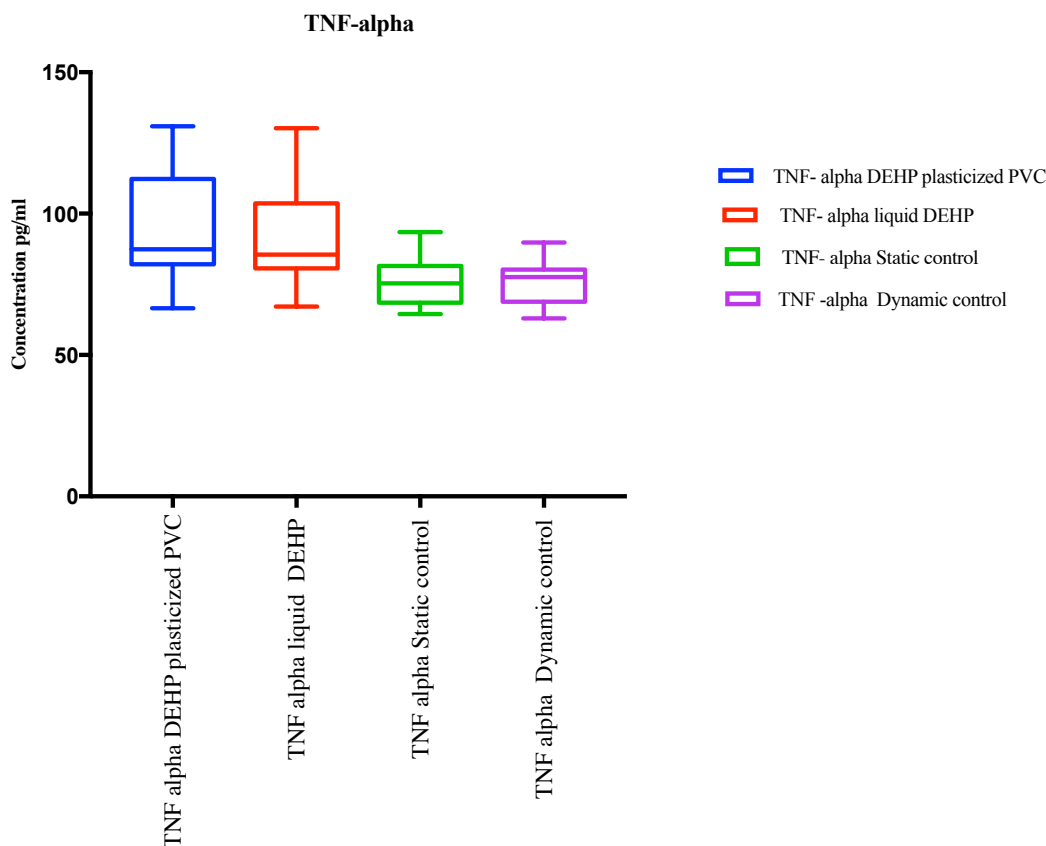

**Figure 57:** TNF- $\alpha$  minimum, maximum and median values for all patients' samples.

However, these levels require to be tested for significance and correlation with apparent systemic inflammatory response syndrome (SIRS) observations in the patient population of interest. This analysis will be demonstrated in the latter part of this chapter (section 7.5.2) by using Mann-Whitney and t-test for two sample based

on the normality distribution of the data. If the p value is  $<0.05$  the data follows the non-normality distribution while if  $p > 0.05$  the data follows normal distribution.

### 7.3.3 C-reactive protein results

Standard curves were produced using standard concentrations of CRP supplied by the kit manufacturer. This standard curve and the associated curve equation were utilised to calculate the CRP concentration in each blood sample.

Below is a representative CRP standard curve. All CRP standard curves can be seen in appnedix G.

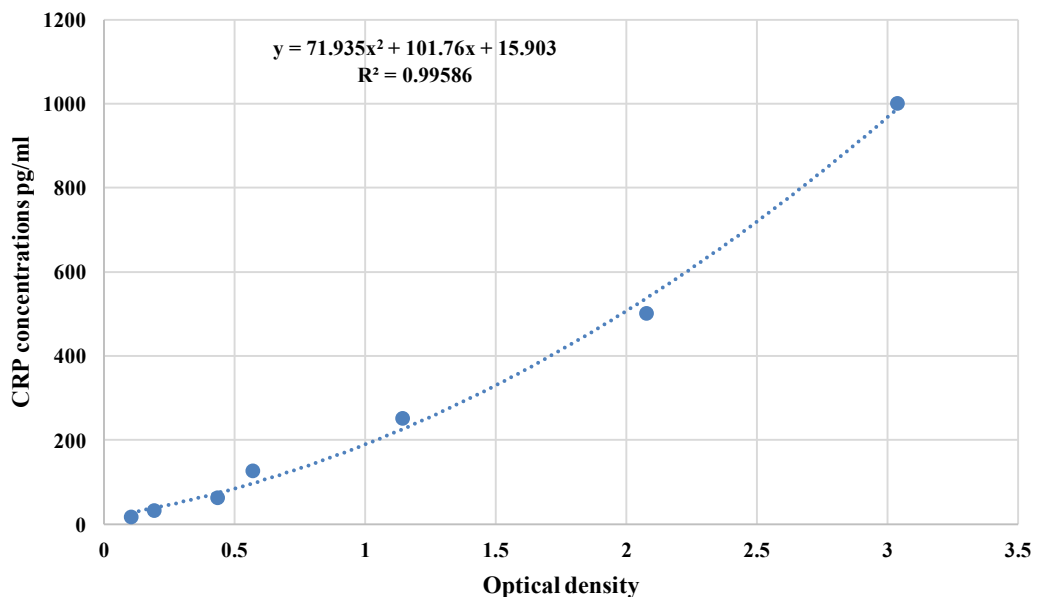

**Figure 58:** Representative CRP standard curve used in the assessment of patients' samples. Using the standard curves, the concentration of CRP in each blood sample was assessed post activation cycle. The results of this analysis for all 52 patients is shown in figure 59 below.

The activation process was performed on all blood samples and in parallel both static and dynamic control samples were processed as outlined in the previous chapter. The principle behind this control measurement was to ascertain the impact of the agitation process in the expression of the cytokines of interest. In assessing the impact of the agitation, the measured cytokine value associated with the non-agitated

sample was subtracted from that of a non-exposure agitated sample. The results of this process are shown in figures 60 and 61.

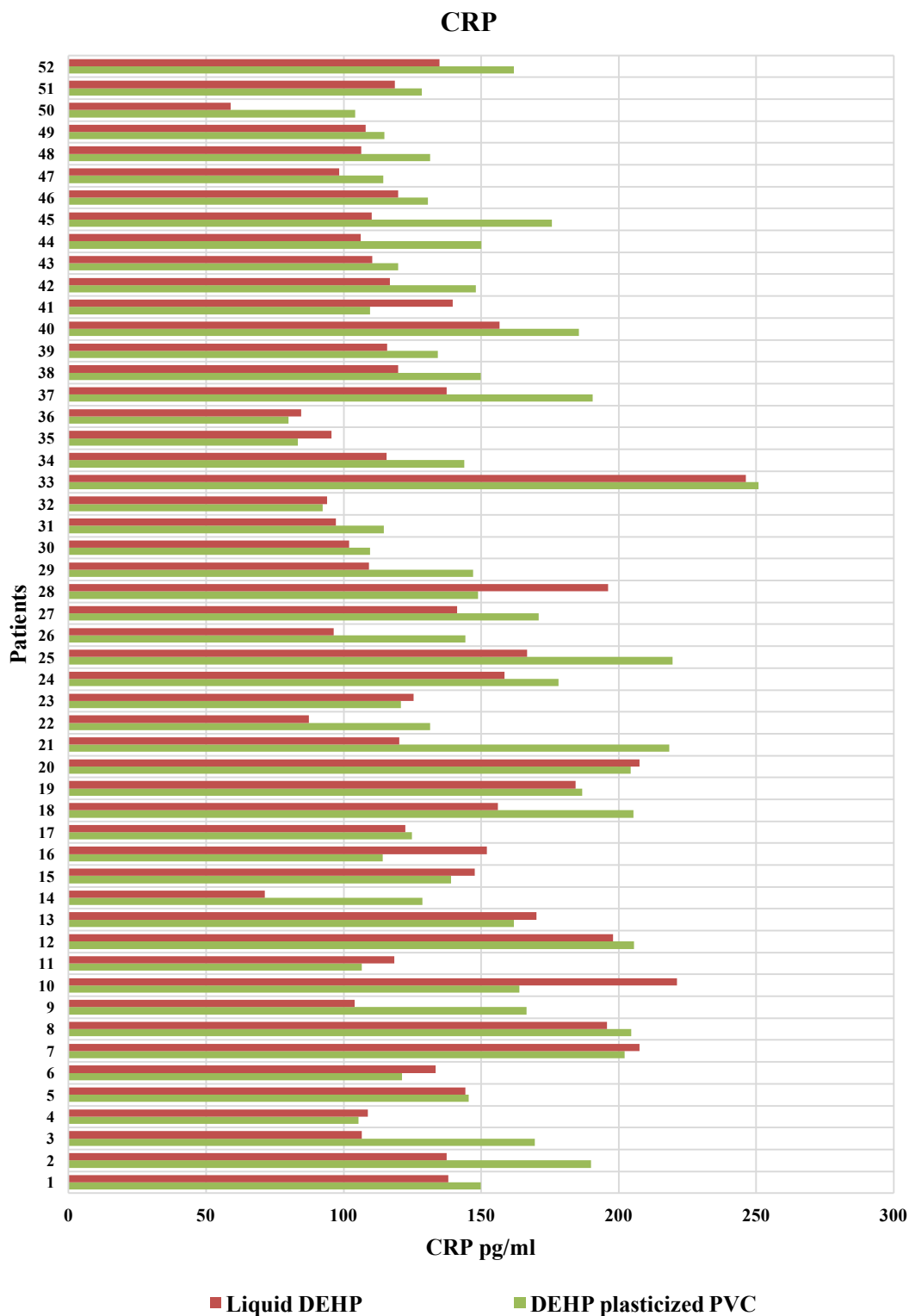

Figure 59: CRP measurements in pg/ml for all patients.

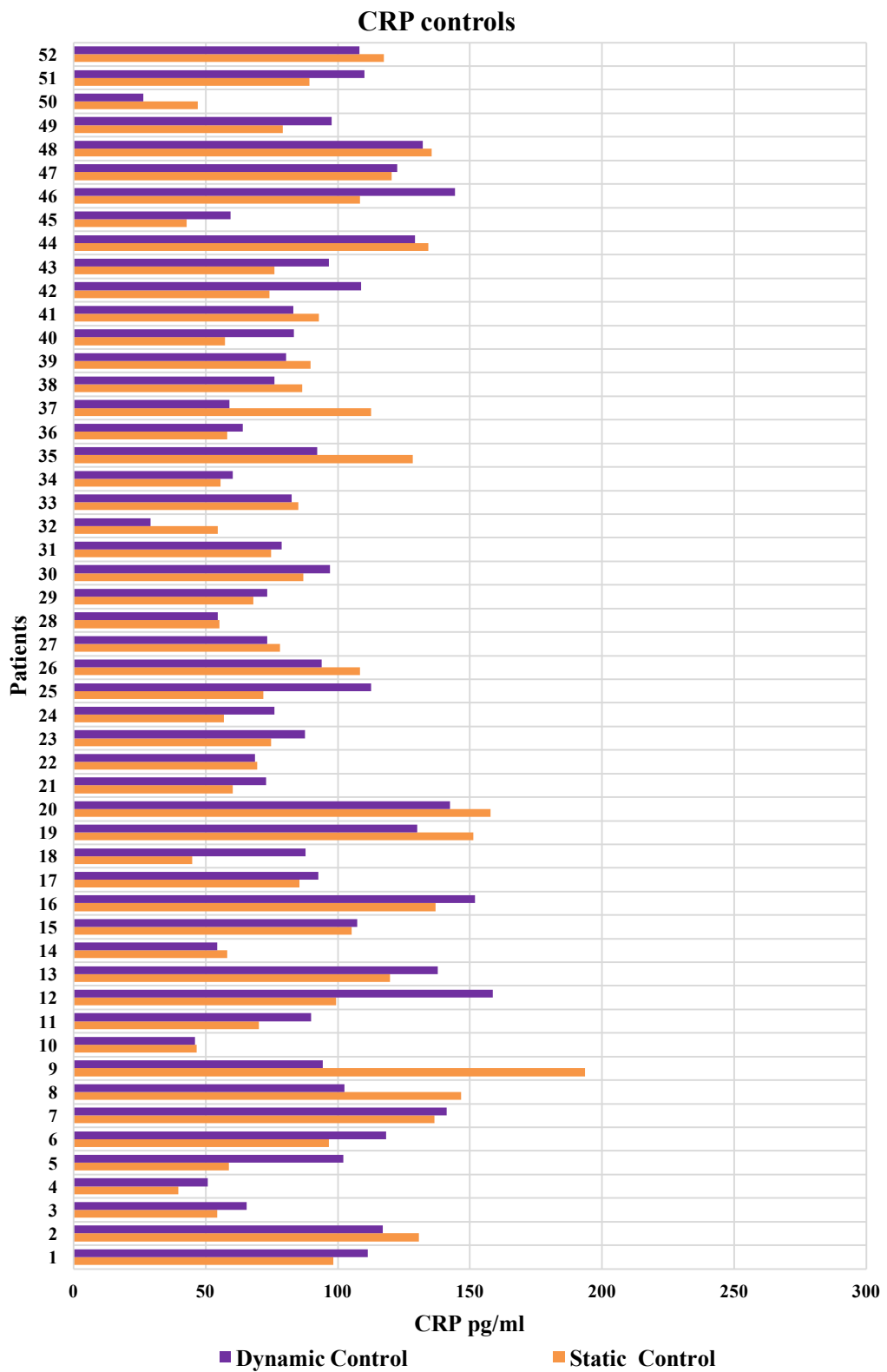
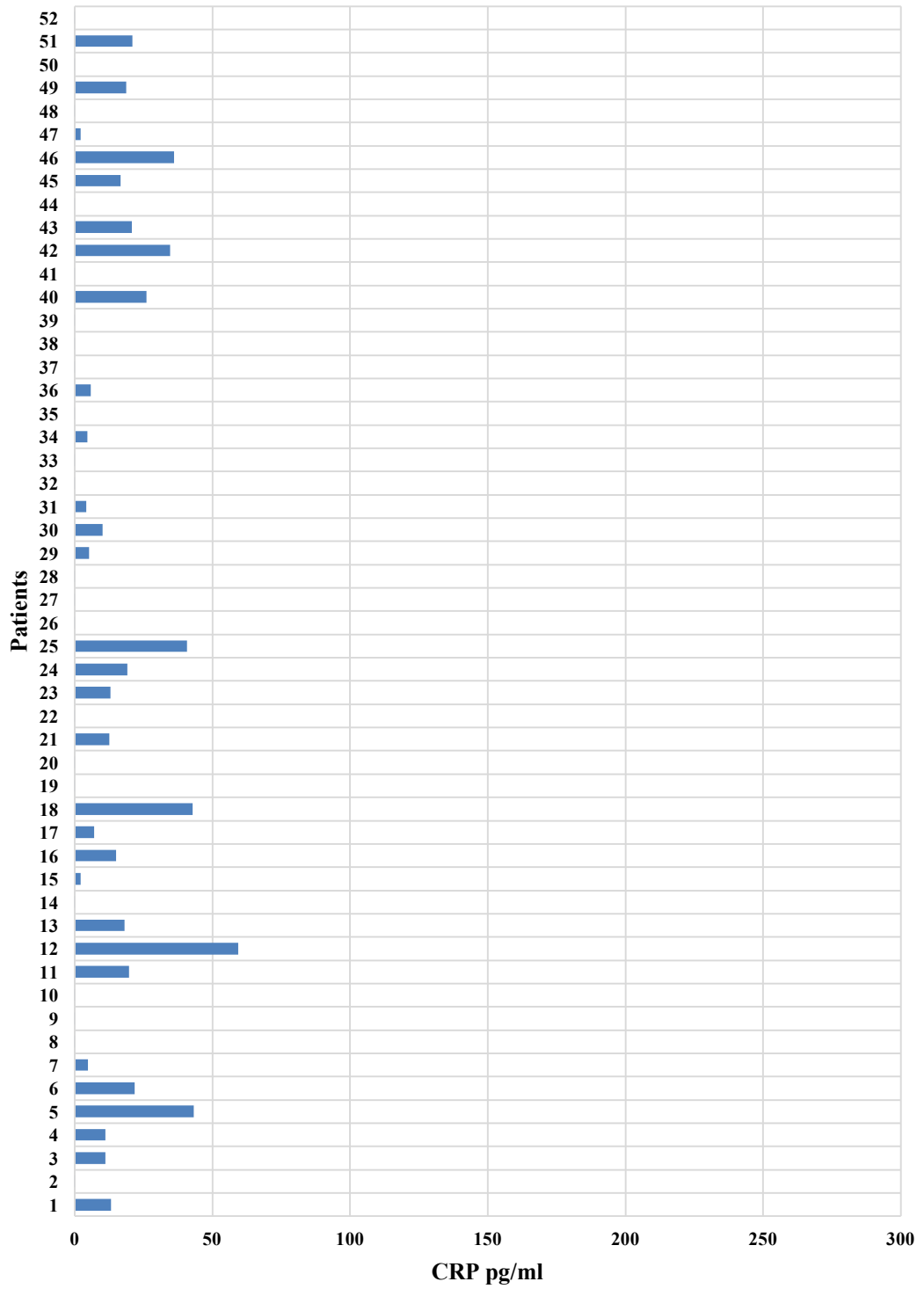

Figure 60: CRP static and dynamic control values for all patients' samples.



### CRP (Dynamic controls-Static controls)



**Figure 61:** CRP (dynamic minus static control values) for all patients. This factor is indicative of the impact of the agitation process alone on the expression of cytokines in the blood sample.

It can be seen from figures 59,60 and 61 that there are a wide range of responses to the activation process, together with a wide ranging control response. These findings are summarized in figure 62 which shows the maximum, minimum and median values for each process and for each initiator (DEHP plasticised PVC or liquid DEHP). The control groups showed a lower response than the exposed agitated specimens, suggesting that the exposure to the materials elicits a response.

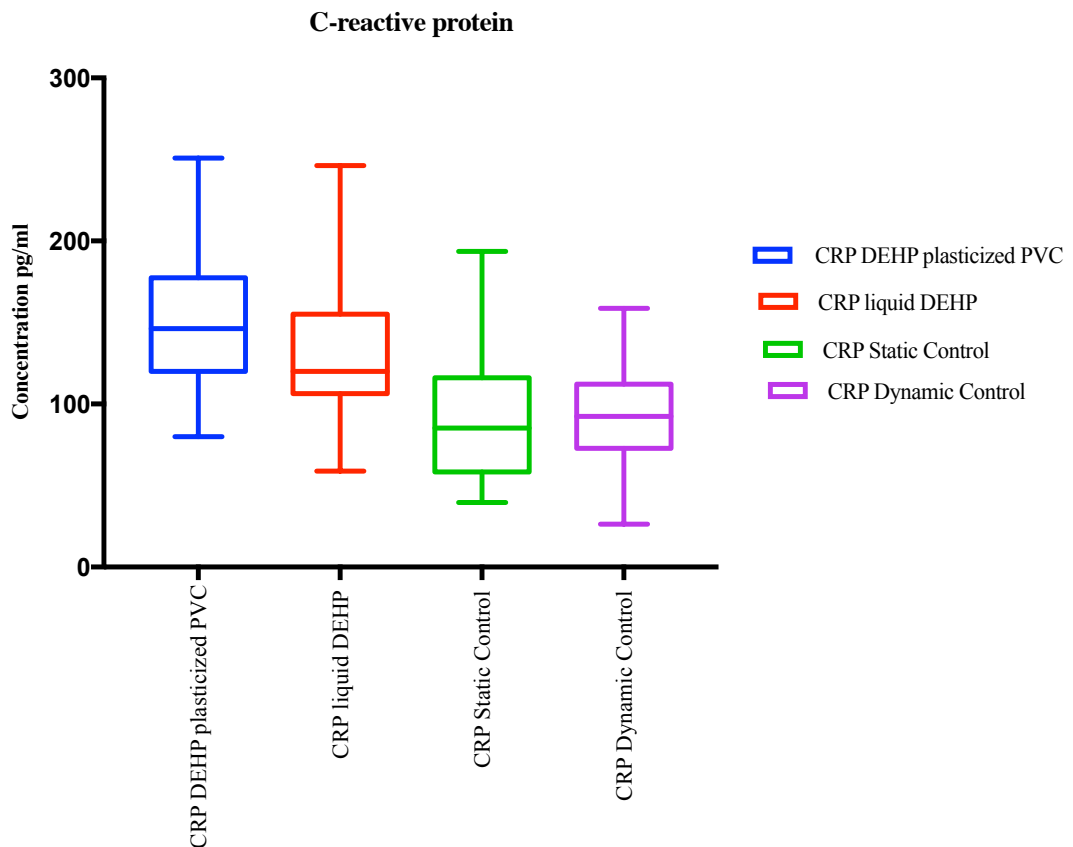

**Figure 62:** CRP maximum, minimum and median values for all patients' samples.

However, these levels require to be tested for significance and correlation with apparent systemic inflammatory response syndrome (SIRS) observations in the patient population of interest. This analysis will be demonstrated in the latter part of this chapter (section 7.5.2) by using Mann-Whitney and t-test for two sample based

on the normality distribution of the data. If the p value is  $<0.05$  the data follows the non-normality distribution while if  $p > 0.05$  the data follows normal distribution.

#### **7.4 Analysis of the accuracy of each cytokine in predicting heightened IR to the surgical procedure**

The patients with known IR complications post-surgery as indicated by the battery of clinical markers have been identified. The screening process for all markers and initiators was analysed and compared to the known IR status of the patient population. These data are indicative of the most suited initiator and markers for clinical deployment and incorporation into the proposed screening technology. The result of this process is shown in table 21. Yellow color indicates the corrected predictions, green color indicates false positive and red color indicates the negative false.

Patients numbers	SIRS (Y/N)	IL-6 DEHP plasticized PVC >190 pg/ml	IL-6 liquid DEHP >190 pg/ml	TNF-alpha DEHP plasticized PVC >90 pg/ml	TNF-alpha liquid DEHP >90 pg/ml	CRP DEHP plasticized PVC > 190 pg/ml	CRP liquid DEHP > 190 pg/ml
1	N	N	N	N	N	N	N
2	N	N	N	N	N	N	N
3	Y	Y	N	Y	Y	N	N
4	N	N	N	N	N	N	N
5	N	N	N	Y	Y	N	N
6	N	N	N	N	N	N	N
7	Y	Y	Y	Y	Y	Y	Y
8	Y	N	Y	N	N	Y	Y
9	N	N	Y	N	N	N	N
10	Y	N	N	Y	Y	N	Y
11	N	N	N	Y	Y	N	N
12	Y	N	Y	Y	Y	Y	Y
13	Y	N	N	N	N	N	N
14	N	N	N	Y	Y	N	N
15	N	N	N	N	N	N	N
16	N	N	N	N	N	N	N
17	N	N	N	N	N	N	N
18	N	N	N	N	N	Y	N
19	N	N	N	N	N	N	N
20	N	N	N	N	N	Y	Y
21	N	N	N	Y	Y	Y	N
22	N	N	N	Y	Y	N	N
23	N	Y	Y	Y	N	N	N
24	Y	Y	N	Y	N	N	N
25	Y	Y	N	Y	N	Y	N
26	N	Y	Y	Y	Y	N	N
27	Y	Y	Y	Y	Y	N	N
28	Y	Y	Y	Y	Y	N	Y
29	N	N	N	Y	Y	N	N
30	N	N	N	N	N	N	N
31	N	N	N	N	N	N	N
32	N	N	N	N	N	N	N
33	Y	Y	Y	Y	Y	Y	Y
34	Y	Y	N	Y	Y	N	N
35	N	N	N	N	N	N	N
36	N	N	N	N	N	N	N
37	N	N	N	N	N	Y	N
38	N	N	Y	Y	Y	N	N
39	N	N	N	Y	Y	N	N
40	N	Y	Y	Y	Y	N	N
41	N	N	N	N	N	N	N
42	N	N	N	N	N	N	N
43	N	N	N	N	N	N	N
44	N	N	N	N	N	N	N
45	N	N	N	N	N	N	N
46	N	N	N	Y	Y	N	N
47	N	N	N	N	Y	N	N
48	N	N	N	Y	Y	N	N
49	N	N	N	N	N	N	N
50	N	N	N	N	N	N	N
51	N	N	N	N	N	N	N
52	N	N	N	N	N	N	N

**Table 21:** Comparison of known IR status in the patient population with the assay results for all configurations of initiator and marker. The table describes conforming results, false positive results (green) and false negative results (red) for all configurations.

In normal clinical practice, clinicians utilize a number of predictive scoring systems to determine the level of risk a particular patient has for the surgical procedure. The most commonly used scoring system in cardiac surgery is the EuroScore ('European System for Cardiac Operative Risk Evaluation'). The basis of this scoring system is an analysis of a range of risk factors and patient specific and lifestyle measures to assess the risk of mortality and morbidity associated with cardiac surgery. The process returns a EuroScore number from 1-6, but clinicians often report this as Low, Medium and High risk. In the context of the present study, we considered a EuroScore in the Medium and High categories as indicative of possible post-operative complications. The high category was considered separately as a possible more subtle indicator of complications. The result of this process is shown in table 22 below.

These data confirm that the EuroScore pre-clinical assessment bears no significant correlation with the clinical outcome in terms of complications associated with SIRS. The EuroScore predicted only 25% of the SIRS complicated patients correctly, and was associated with 10 false positive predictions and 21 false negative complications. We surmise from this process that the Euroscore is not a good predictor of SIRS complicated outcomes.

Patient number	SIRS (Y/N)	High EuroScore	Medium EuroScore
1	N	N	N
2	N	N	N
3	Y	N	N
4	N	N	Y
5	N	N	N
6	N	N	N
7	Y	N	N
8	Y	N	N
9	N	N	N
10	Y	N	N
11	N	N	N
12	Y	N	Y
13	Y	N	N
14	N	N	N
15	N	N	N
16	N	N	N
17	N	N	N
18	N	N	N
19	N	N	N
20	N	N	N
21	N	N	Y
22	N	N	Y
23	N	N	N
24	Y	N	N
25	Y	N	Y
26	N	N	Y
27	Y	N	N
28	Y	N	N
29	N	N	N
30	N	N	N
31	N	N	N
32	N	N	N
33	Y	Y	N
34	Y	N	N
35	N	N	N
36	N	N	Y
37	N	N	Y
38	N	N	N
39	N	N	N
40	N	N	N
41	N	N	Y
42	N	N	N
43	N	N	Y
44	N	N	N
45	N	N	Y
46	N	N	N
47	N	N	N
48	N	N	N
49	N	N	Y
50	N	N	N
51	N	N	N
52	N	N	N

**Table 22:** Analysis of Euroscore as an identifier of post-operative complications of inflammatory origin. The data shows quite clearly that the EuroScore is ineffective in this regard, with a correlation with outcome of only 25% and 10 false positives, 21 false negatives.

The data derived from the assessment of cytokine screening pre-operatively are further analysed in table 23 and the apparent best fit configuration is derived from the combination of conforming results and the minimum number of false positives and negatives.

Predictors	Prediction percentage	False positive	False negative
<b>IL-6 DEHP plasticised PVC</b>	66.70%	3	3
<b>IL-6 liquid DEHP</b>	50%	5	6
<b>TNF-alpha DEHP plasticised PVC</b>	83.30%	13	2
<b>TNF-alpha liquid DEHP</b>	75%	12	4
<b>CRP DEHP plasticised PVC</b>	41.60%	4	7
<b>CRP liquid DEHP</b>	50%	1	6

**Table 23:** Analysis of the predictive capability of all configurations of markers and initiators. The objective is to determine the most accurate marker/initiator configuration in terms of conforming results and false values.

These data suggest that the combination of IL-6 and DEHP plasticised PVC has the best overall predictive potential. This combination resulted in the identification of 66.7% (8 out of the 12 confirmed IR patients) and only 6 false positives out of the 40 non IR patients (13%). TNF- $\alpha$  in combination with both initiators had the best predictive quality in terms of the confirmed patients (83.3% DEHP plasticised PVC, 75% Liquid DEHP), but both were associated with a much higher degree of false readings in the non-IR population (37% and 40% respectively). The CRP results did not produce particularly promising results in terms of the predictive qualities of either configuration.

These findings will be tested statistically in section 7.5.

## 7.5 Statistical analysis

### 7.5.1 Association between control samples (static and dynamic) and samples with both initiators (DEHP plasticised PVC and liquid DEHP)

Before analyzing the patient screening data in terms of statistically significant predictive qualities, it is important to assess whether, when compared to static and dynamic control values, there is a significant activation of the various cytokines associated with contact with the two initiators (liquid DEHP and DEHP plasticised PVC). A one sample Wilcoxon test was performed to both IL-6 DEHP plasticised PVC and IL-6 DEHP scores. The results showed a positive association between the IL-6 DEHP plasticised PVC and IL-6 DEHP with both static and dynamic control groups as seen in the below table 24. DEHP plasticised PVC lead to increase the IL-6 levels approximately 43 times when compared to static and dynamic control groups. Liquid DEHP followed the same pattern by increasing the concentration 35 times which confirms the role of both initiators in the elevations levels of IL-6. Moreover, from the confidence interval, it can be reported that 95% confidence there are significant effect of PVC and DEHP in the elevation of IL-6 concentrations.

Test	Median	95%CI
IL-6 DEHP plasticised PVC -SC	43.1	(23.3, 62.6)
IL-6 DEHP plasticised PVC-DC	35.6	(17.5, 53.3)
IL-6 liquid DEHP-SC	38.3	(24.8, 53.6)
IL-6 liquid DEHP-DC	35	(19.8, 46.7)

**Table 24:** Wilcoxon test for IL-6 patients results. IL-6 scores for all patients with both initiators (Plasticised PVC and liquid DEHP ) were subtracted from the control scores in order to determine the effect of these initiators in terms of the overexpression of IL-6 levels.

A similar analysis was carried out on the TNF- $\alpha$  data using static, dynamic and Liquid DEHP and PVC results. The results in table 25 show the effect of initiators in TNF- $\alpha$  levels. These data confirm that, when compared to the IL-6 results, TNF- $\alpha$



produces a less significant effect. As can be seen TNF- $\alpha$  with DEHP plasticised PVC reported an increase by 20.6 times while IL-6 with DEHP plasticised PVC increase the concentration by 40 times, suggesting a stonger activation effect.

Test	Median	95%CI
TNF- $\alpha$ DEHP plasticised PVC-SC	20.6	(13.4, 25.5)
TNF- $\alpha$ DEHP plasticised PVC-DC	20.2	(13.6, 25.5)
TNF- $\alpha$ liquid DEHP-SC	15	(10.4, 21.5)
TNF- $\alpha$ liquid DEHP-DC	14.6	(10.1, 21.7)

**Table 25:** Wilcoxon tests for TNF- $\alpha$  patients' results. TNF- $\alpha$  scores for all patients with both initiators (Plasticised PVC and liquid DEHP) were subtracted from the control scores in order to determine the effect of these initiators in terms of the overexpression of TNF- $\alpha$  levels.

From the CRP results, it can be summarized that both initiators DEHP plasticised PVC and liquid DEHP lead to increased CRP levels with varying response across the patient group. By performing the Wilcoxon test, seen in table 26, it can be seen that there is a strong effect of both initiators in increasing CRP levels.

Test	Median	95%CI
CRP DEHP plasticised PVC-SC	56.7	(44.1, 71.8)
CRP DEHP plasticised PVC-DC	55.7	(43.4, 68.3)
CRP liquid DEHP-SC	40.3	(30.9, 52.1)
CRP liquid DEHP-DC	36.4	(27.0, 46.4)

**Table 26:** Wilcoxon test for CRP patients' results. CRP scores for all patients with both initiators (Plasticised PVC and liquid DEHP) were subtracted from the control scores in order to determine the effect of these initiators in terms of the overexpression of CRP levels.

### 7.5.2 Determine the difference between clinically observed SIRS and NON SIRS in terms of the cytokine levels

All patient ELISA data were entered into a Minitab worksheet and then separated into two groups (SIRS groups and non-SIRS groups) based on the post-operative clinical data. A Mann-Whitney and/or t-test was performed on the data based on its normality distribution. This analysis is shown in the below figures (63, 64, 65, 66, 67 and 68).

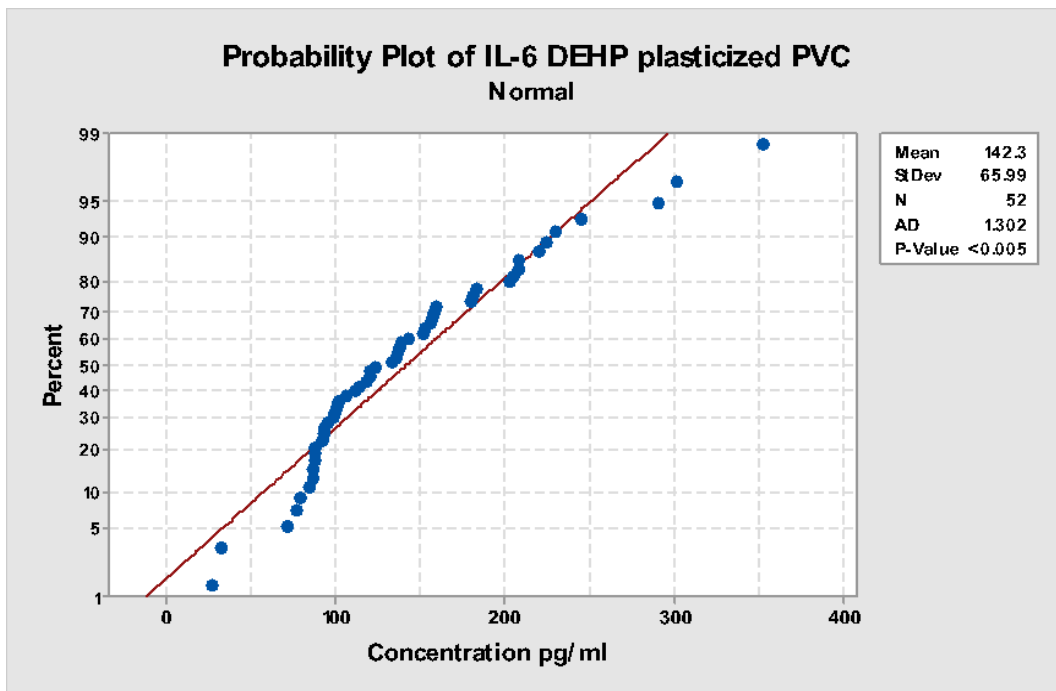

Figure 63:IL-6 DEHP plasticised PVC normality distribution ( $p<0.05$ )

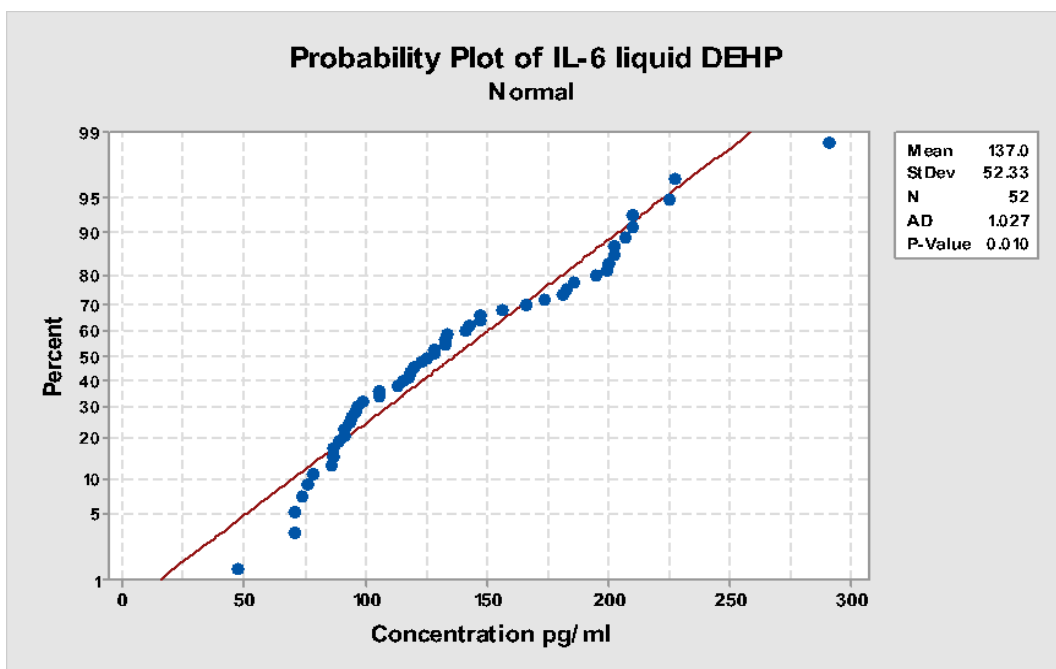
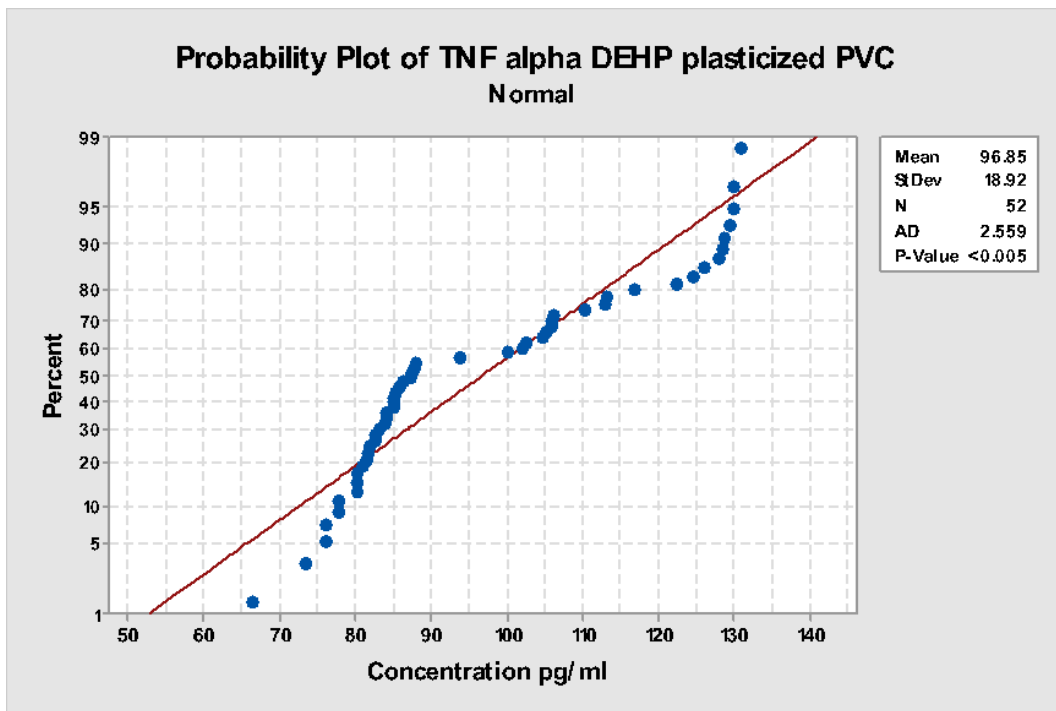
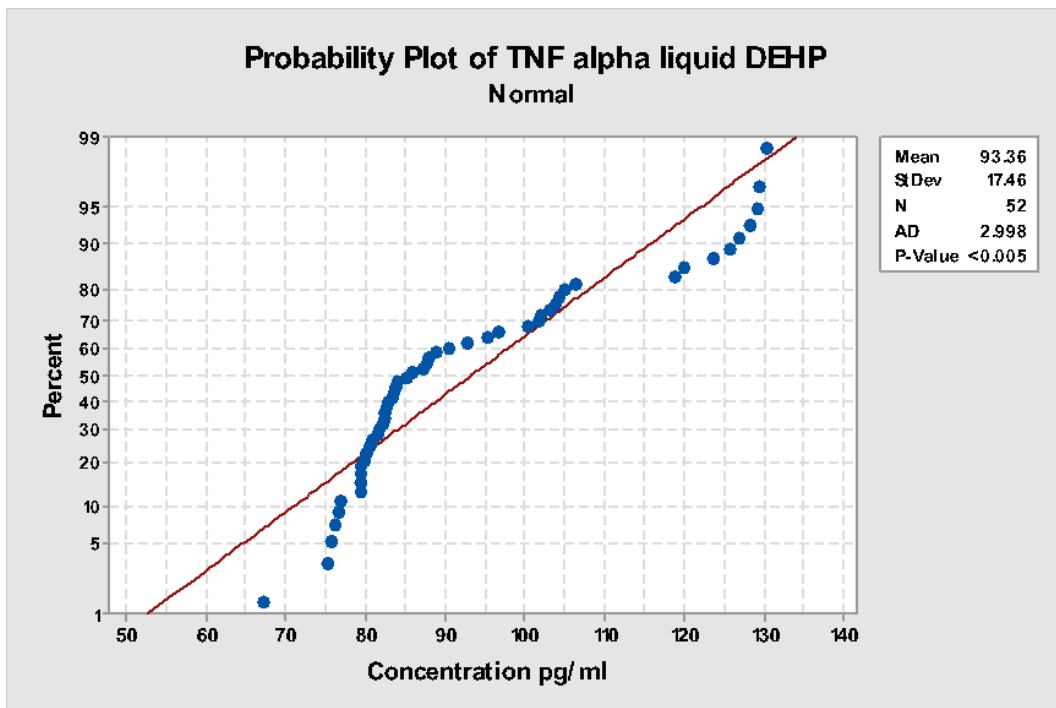

Figure 64:IL-6 liquid DEHP normality distribution ( $p<0.05$ )



**Figure 65:** TNF- $\alpha$  DEHP plasticised PVC normality distribution ( $p < 0.005$ )



**Figure 66:** TNF- $\alpha$  liquid DEHP normality distribution ( $p < 0.005$ )

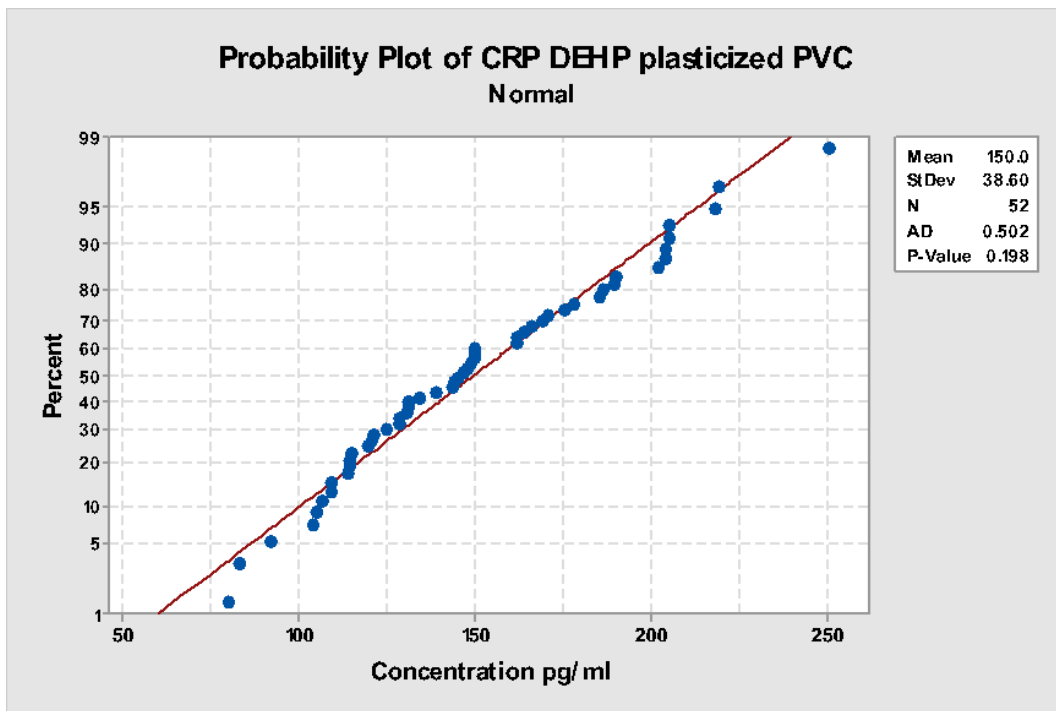

**Figure 67:**CRP DEHP plasticised PVC normality distribution (p=0.198)

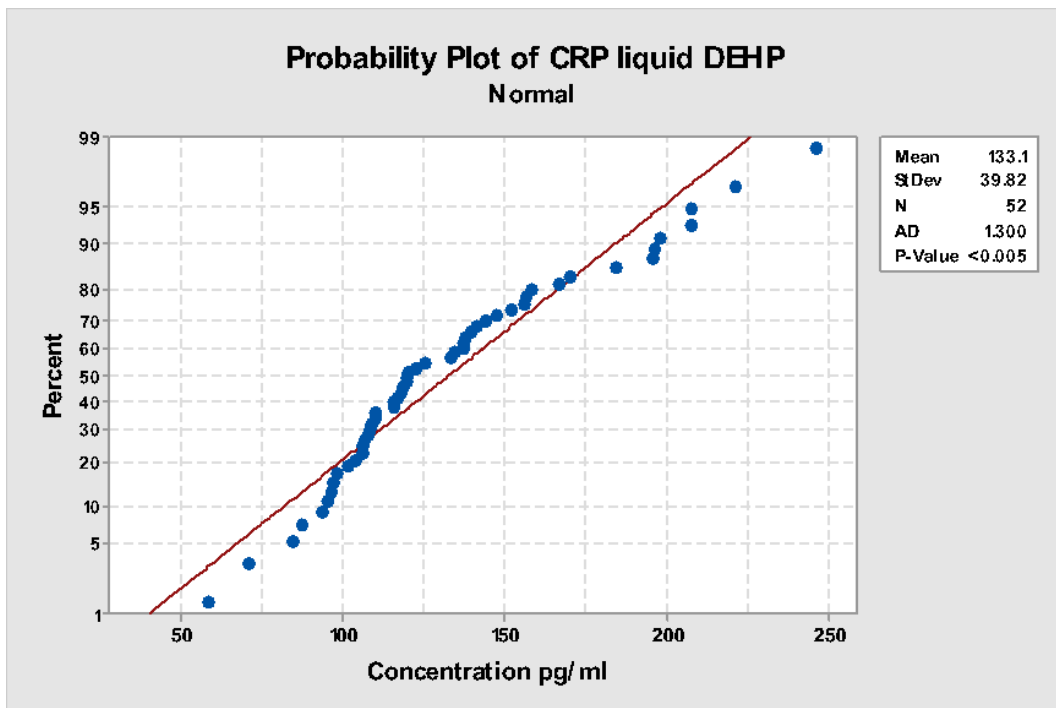

**Figure 68:**CRP liquid DEHP normality distribution(p<0.005).

The normality distribution analysis showed that all data followed a non-normal distribution with  $p < 0.005$  except CRP DEHP plasticised PVC that had  $p > 0.05$  which

is considered to be normal. Therefore a conventional two sample t-test was performed for CRP DEHP plasticised PVC on both SIRS and non-SIRS groups while Mann-Whitney test performed on IL-6 DEHP plasticised PVC ,IL-6 liquid DEHP, TNF- $\alpha$  DEHP plasticised PVC,TNF- $\alpha$  liquid DEHP ,CRP liquid DEHP with SIRS and non-SIRS patients. The results of this analysis are shown in table 27 below.

Test	SIRS	NON -SIRS	CI	P
Mann-Whitney Test and CI: IL-6 DEHP plasticised PVC SIRS, IL-6 DEHP plasticised PVC NON- SIRS	Median =221.82	Median=116.28	(48.71,138.16)	0.0002
Mann-Whitney Test and CI: IL-6 liquid DEHP SIRS, IL-6 liquid DEHP NON -SIRS	Median =192.57	Median= 117.13	(32.07,101.02)	0.0005
Mann-Whitney Test and CI: TNF- $\alpha$ DEHP plasticised PVC SIRS, TNF- $\alpha$ DEHP plasticised PVC NON -SIRS	Median =119.69	Median = 85.23	(10.63,39.12)	0.0046
Mann-Whitney Test and CI: TNF- $\alpha$ liquid DEHP SIRS, TNF- $\alpha$ liquid DEHP NON – SIRS	Median =102.61	Median= 83.46	(2.20,31.13)	0.0196
Two-Sample T-Test and CI: CRP DEHP plasticised PVC SIRS, CRP DEHP plasticised PVC NON –SIRS	Mean=185	Mean=139.5	(23.2, 67.8)	0.0003
Mann-Whitney Test and CI: CRP liquid DEHP SIRS, CRP liquid DEHP NON- SIRS	Median=182.98	Median= 117.57	(33.23,85.70)	0.0002

**Table 27:**Significance test for IL-6,TNF- $\alpha$  and CRP on SIRS and non-SIRS patients.

The above table confirmed that IL-6, TNF- $\alpha$  and CRP can be used as a predictor for SIRS based on the significance difference between the two groups ( $p < 0.05$ ) and 95 confidences in both arms of the study interval support this assertion.

### **7.5.3 Regression analysis to specify the best model that can be used as a predictor of SIRS**

We carried out a binary logistic regression to investigate the relationship between response variables and predictors. The analysis was performed using 6 variables; IL-6 DEHP plasticised PVC; IL-6 liquid DEHP; TNF- $\alpha$  DEHP plasticised PVC; TNF- $\alpha$  liquid DEHP ; CRP DEHP plasticised PVC; CRP liquid DEHP. The response is SIRS which equates to either a yes or no response. Both AIC and AUC can predict the best fit model of the data. Other indicators of the fit of the model will also be tested, including, predictive power and goodness of fit tests (deviance, Pearson and Hosmer- Lemeshow).

#### **Method**

The patients were randomly separated into two groups, a regression group and a predicted group, in a ratio in the order of 2:1 respectively (Hosmer Jr and Lemeshow 2004). The sensitivity and specificity of the test is crucial in specifying the SIRS patients, achieved by determining the probability cut off value (p cut off). The resultant Receiver Operating Curve, sensitivity (true positive, known SIRS patients) v 1-specificity (false positive, non-SIRS patients). To select p cut off value, high sensitivity and high specificity probabilities will be specified from the probabilities values. To determine the sensitivity only the highest values of each assay were employed. High sensitivity indicates that only true SIRS patients are named as SIRS while high specificity means non-SIRS patients are named as SIRS. Therefore, according to the ROC structure, X axis is presenting the values of 1-specificity. Hence, we need to select the high specificity value to lower the values of false positive and achieve the best cut off value. In analysing this data, the AUC of each plot is calculated and the higher value suggests the best fit model.

### Model 1: IL-6 DEHP plasticised PVC

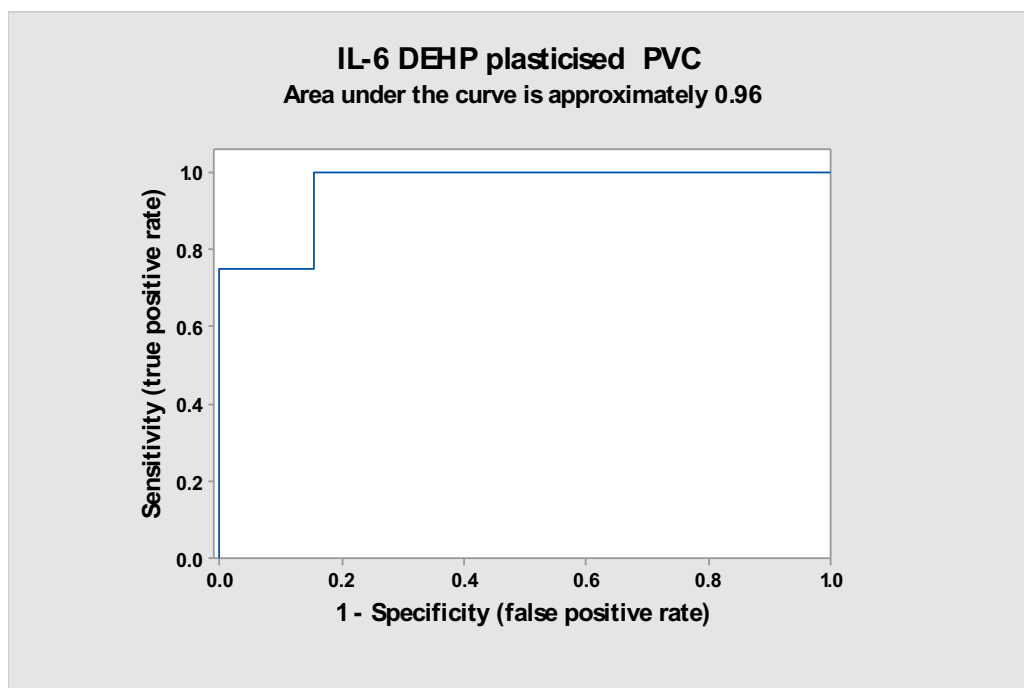

Figure 69:IL-6 DEHP Plasticised PVC model.

### Model 2: IL-6 liquid DEHP

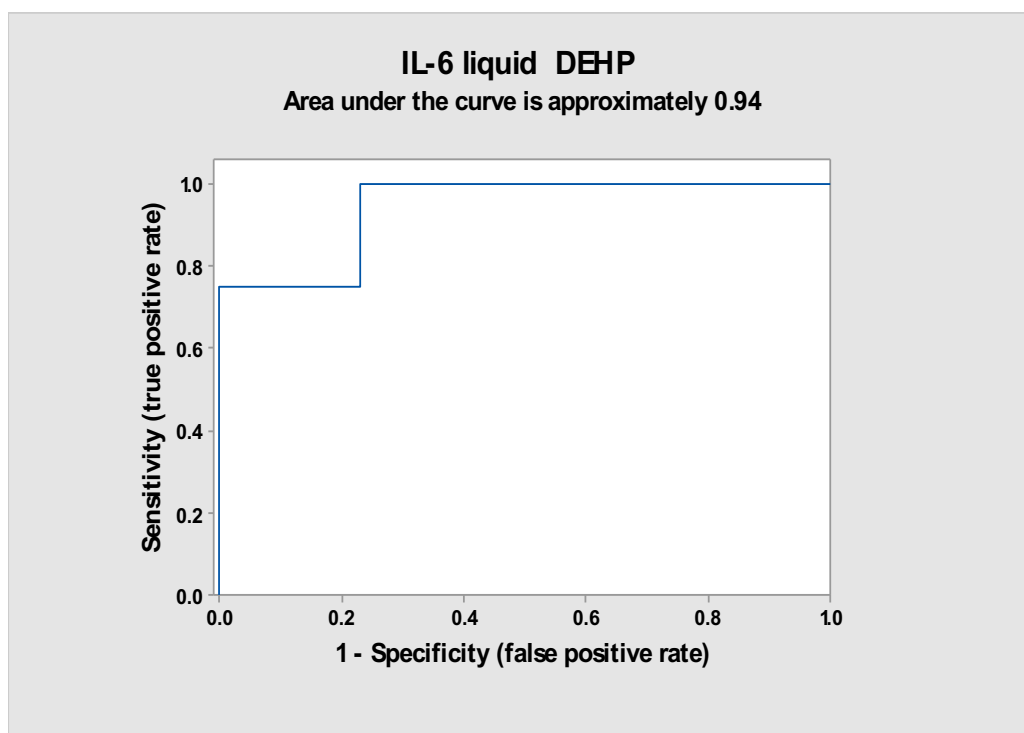

Figure 70:IL-6 liquid DEHP model.

### Model 3: TNF- $\alpha$ DEHP plasticised PVC

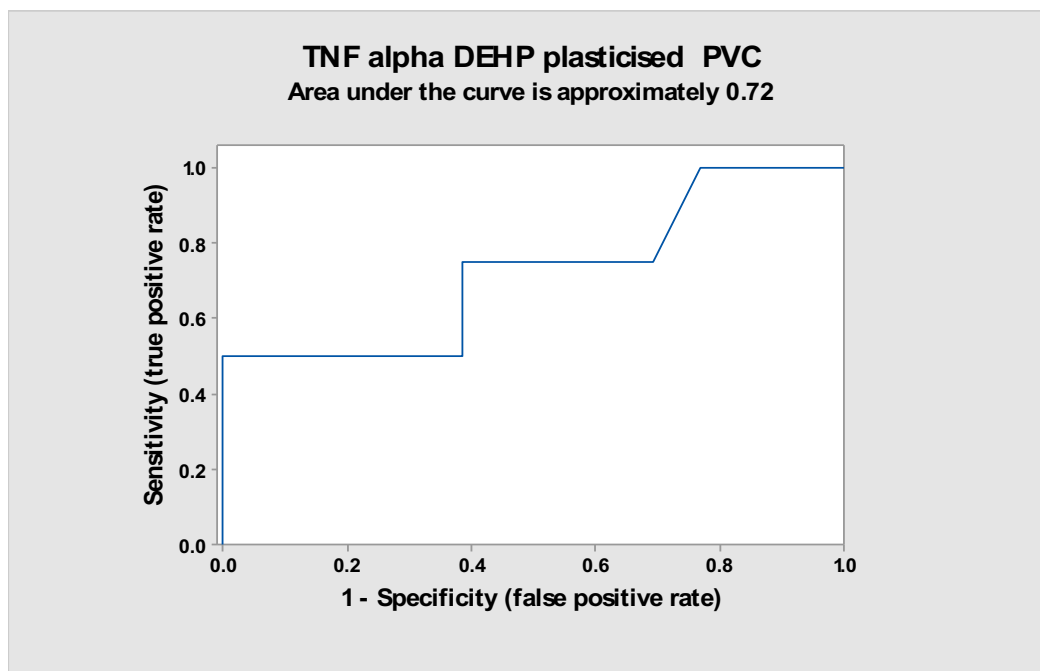

Figure 71: TNF-alpha DEHP plasticised PVC model

### Model 4: TNF- $\alpha$ liquid DEHP

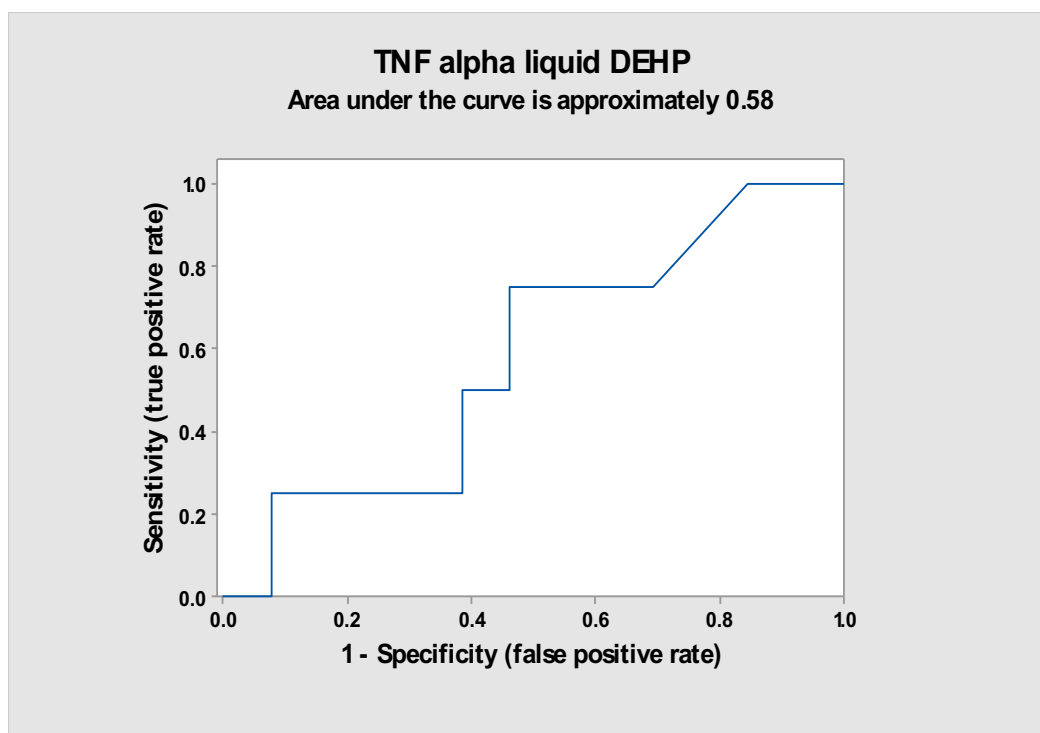

Figure 72: TNF alpha liquid DEHP model



### Model 5: CRP DEHP plasticised PVC

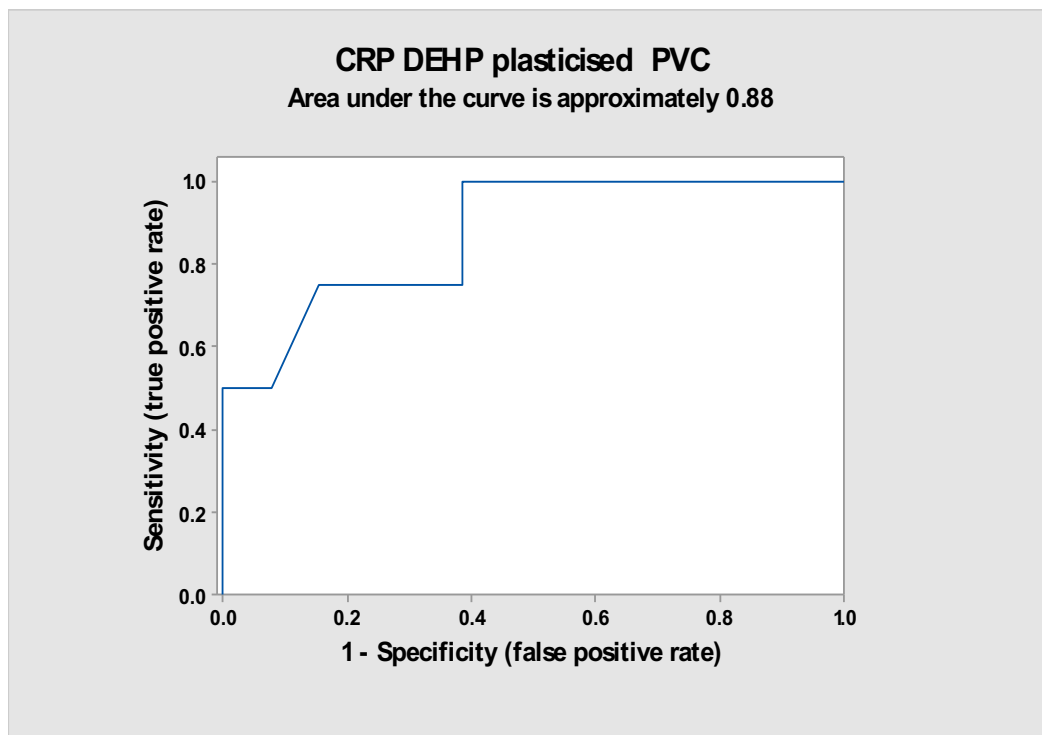

Figure 73: CRP DEHP plasticised PVC model

### Model 6: CRP liquid DEHP

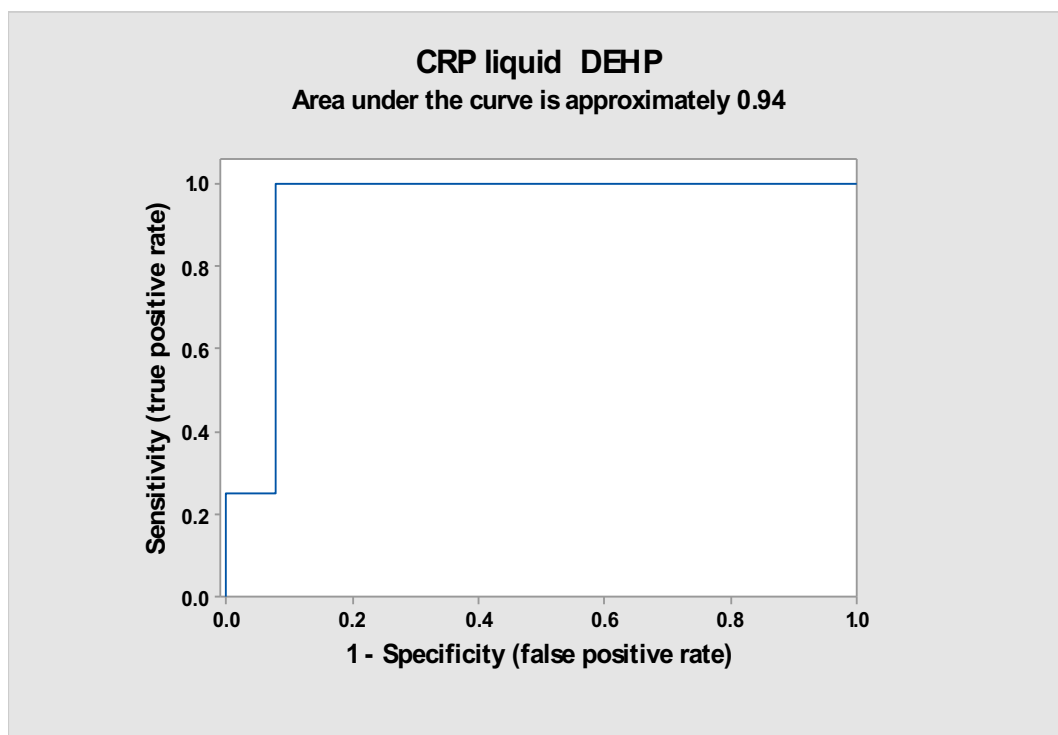

Figure 74: CRP liquid DEHP model

The receiver operating curve, more specifically the AUC, is used to measure the discrimination between different models. Several clinical studies suggested the use of receiver operating curve to evaluate the diagnostic data (Zou, O'Malley, and Mauri 2007). Hence, according to Hosmer definition of the area under the curve, IL-6 DEHP plasticised PVC showed a higher AUC (0.96) as compare to other predictors.

There are many indicators that can be used to test the goodness of each model in addition to AUC such as AIC, predictive power, and odd ratio. All of these results are shown in table 28 below.

	Test		Models					
			IL-6 DEHP Plasticised PVC	IL-6 Liquid DEHP	TNF alpha DEHP plasticised PVC	TNF alpha liquid DEHP	CRP DEHP Plasticised PVC	CRP liquid DEHP
Goodness of fit	Deviance	P value	0.765	0.584	0.712	0.733	0.677	0.864
	Pearson	P value	0.227	0.463	0.249	0.25	0.79	0.543
	Hosmer-Lemeshow	P value	0.364	0.81	0.3	0.323	0.558	0.812
	Odd ratio		1.0279	1.0257	1.0745	1.0839	1.0424	1.0488
	<b>AIC</b>		<b>23.88</b>	<b>30.11</b>	<b>32.06</b>	<b>34.06</b>	<b>31.61</b>	<b>28.29</b>
	<b>Area under the curve (AUC)</b>		<b>0.96</b>	<b>0.94</b>	<b>0.72</b>	<b>0.58</b>	<b>0.88</b>	<b>0.94</b>
Predictive power (R <sup>2</sup> )		35.44%	28.56%	26.65%	25.43%	27.52%	31.41%	

**Table 28:** Summary findings from the models (IL-6 DEHP plasticised PVC, IL-6 liquid DEHP, TNF- $\alpha$  DEHP plasticised PVC, TNF- $\alpha$  liquid DEHP, CRP DEHP plasticised PVC and CRP liquid DEHP).

All six models showed a good fit of the observed data based on the three different goodness of fit tests (deviance, Pearson and Hosmer-lemeshow). All of them showed higher p values  $> 0.05$  which is a good indicator of the goodness of these models.

Odd Ratio is another statistical tool used to measure the association between the variables and the outcomes or the response. In these models, the variables are IL-6

DEHP plasticised PVC, IL-6 liquid DEHP, TNF- $\alpha$  DEHP plasticised PVC, TNF- $\alpha$  liquid DEHP, CRP DEHP plasticised PVC and CRP liquid DEHP and the outcomes is SIRS. From the table, all models presented a strong association with SIRS (odd ratio above 1).

The predictive power is also considered as another indicator of the goodness of the model. The rule stated that higher is better. Hence, IL-6 DEHP plasticised PVC seems to be the best model based on the  $R^2$  (35.44%). However, further investigation will be performed to choose the best model.

AIC is the best indicator of the best fit model of the data. Smaller AIC indicates the best model. IL-6 with DEHP plasticised PVC is the smallest AIC value (23.88) which means that IL-6 with DEHP plasticised PVC initiator is the sensitive inflammatory marker that can detect SIRS patients prior to OHS.

P cut off values were specified from the receiver operative curves of all models based on the sensitivity and specificity probabilities. Then, use this probability backward on the regression equation in order to calculate the threshold score of the cytokines. Table 29, demonstrated all threshold scores of all models. As the best model is IL-6 DEHP plasticised PVC, the threshold is 200 pg/ml. Any patient who has IL-6 higher than 200 pg/ml may be at risk of SIRS. Hence, all patients' results were tested for false positive and false negative based on the threshold values (table 30). The results were displayed in table 31 and table 32.

<b>Model</b>	<b>Regression equation</b>	<b>P cut off value</b>	<b>Threshold value pg/ml</b>
<b>IL-6 DEHP plasticised PVC</b>	P cut off = $-5.34 + 0.0276$ IL-6 DEHP plasticised PVC	0.18	200
<b>IL-6 liquid DEHP</b>	P cut off = $-4.88 + 0.0254$ IL-6 liquid DEHP	0.19	199
<b>TNF-<math>\alpha</math> DEHP plasticised PVC</b>	P cut off = $-8.49 + 0.0719$ TNF- $\alpha$ DEHP plasticised PVC	0.1	119.5
<b>TNF-<math>\alpha</math> liquid DEHP</b>	P cut off = $-8.96 + 0.0806$ TNF- $\alpha$ liquid DEHP	0.1	112.4
<b>CRP DEHP plasticised PVC</b>	P cut off = $-7.66 + 0.0415$ CRP DEHP plasticised PVC	0.57	198.3
<b>CRP liquid DEHP</b>	P cut off = $-7.59 + 0.0477$ CRP liquid DEHP	0.47	169

**Table 29:** Predictors threshold values based on the sensitivity and specificity analysis.

Having identified the appropriate threshold values for IL-6, TNF- $\alpha$  and CRP for predicting SIRS through the statistical analysis described above, it is possible to revisit the analysis of predictive fit carried out earlier in this chapter using statistically derived threshold values rather than simply observed values. This analysis is shown below in table 30.

Patient number	SIRS (Y/N)	IL-6 DEHP plasticized PVC > 200 pg/ml	IL-6 Liquid DEHP > 199 pg/ml	TNF alpha DEHP plasticised PVC>119.5 pg/ml	TNF alpha liquid DEHP >112.4 pg/ml	CRP DEHP plasticized PVC >198.3 pg/ml	CRP liquid DEHP > 169 pg/ml
1	N	N	N	N	N	N	N
2	N	N	N	N	N	N	N
3	Y	Y	N	Y	Y	N	N
4	N	N	N	N	N	N	N
5	N	N	N	Y	N	N	N
6	N	N	N	N	N	N	N
7	Y	Y	Y	Y	Y	Y	Y
8	Y	N	Y	N	N	Y	Y
9	N	N	N	N	N	N	N
10	Y	N	N	Y	Y	N	Y
11	N	N	N	Y	Y	N	N
12	Y	N	Y	N	Y	Y	Y
13	Y	N	N	N	N	N	Y
14	N	N	N	Y	N	N	N
15	N	N	N	N	N	N	N
16	N	N	N	N	N	N	N
17	N	N	N	N	N	N	N
18	N	N	N	N	N	Y	N
19	N	N	N	N	N	N	Y
20	N	N	N	N	N	Y	Y
21	N	N	N	N	N	Y	N
22	N	N	N	N	N	N	N
23	N	Y	Y	N	N	N	N
24	Y	Y	N	N	N	N	N
25	Y	Y	N	N	N	Y	N
26	N	Y	Y	N	N	N	N
27	Y	Y	Y	Y	N	N	N
28	Y	Y	Y	Y	N	N	Y
29	N	N	N	N	Y	N	N
30	N	N	N	N	N	N	N
31	N	N	N	N	N	N	N
32	N	N	N	N	N	N	N
33	Y	Y	Y	Y	Y	Y	Y
34	Y	Y	N	N	N	N	N
35	N	N	N	N	N	N	N
36	N	N	N	N	N	N	N
37	N	N	N	N	N	N	N
38	N	N	Y	N	N	N	N
39	N	N	N	N	Y	N	N
40	N	Y	Y	N	Y	N	N
41	N	N	N	N	N	N	N
42	N	N	N	N	N	N	N
43	N	N	N	N	N	N	N
44	N	N	N	N	N	N	N
45	N	N	N	N	N	N	N
46	N	N	N	N	N	N	N
47	N	N	N	N	N	N	N
48	N	N	N	N	N	N	N
49	N	N	N	N	N	N	N
50	N	N	N	N	N	N	N
51	N	N	N	N	N	N	N
52	N	N	N	N	N	N	N

**Table 30:** Comparison of known IR status in the patient population with the statistical results (regression analysis). The table describes conforming results, false positive results (green) and false negative results (red) for all configurations. The summary of this table is shown in the following table (table 31).

Predictors	Prediction percentage	False positive	False negative
<b>IL-6 DEHP plasticized PVC</b>	66.7%	3	4
<b>IL-6 liquid DEHP</b>	50%	4	6
<b>TNF-<math>\alpha</math> DEHP plasticised PVC</b>	50%	3	6
<b>TNF-<math>\alpha</math> liquid DEHP</b>	41.6%	4	7
<b>CRP DEHP plasticized PVC</b>	41.6%	3	7
<b>CRP liquid DEHP</b>	58%	2	5

**Table 31:** Analysis of the predictive capability of all configurations of markers and initiators based on the regression analysis models.

The summary outcomes data from statistical analysis confirmed the sensitivity of IL-6 DEHP plasticised PVC in the prediction of SIRS patients. These data were compared with observed ELISA data and the result is shown in table 32.

Predictors	Observed ELISA Correct prediction percentage	Statistical correct prediction percentage
<b>IL-6 DEHP plasticised PVC</b>	66.70%	66.7%
<b>IL-6 liquid DEHP</b>	50%	50%
<b>TNF-<math>\alpha</math> DEHP plasticised PVC</b>	83.30%	50%
<b>TNF-<math>\alpha</math> DEHP liquid DEHP</b>	75%	41.6%
<b>CRP DEHP plasticised PVC</b>	41.60%	41.6%
<b>CRP liquid DEHP</b>	50%	58%

**Table 32:** Observed ELISA SIRS prediction Vs Statistical analysis prediction.

IL-6 DEHP plasticised PVC is the most sensitive predictive marker due to its high prediction percentage of SIRS outcome patients (66.7% statistically and 66.7% from the the observed ELISA). Also, it has lowest number of false positive and false negative values, smaller AIC (23.88) and higher AUC (0.96) when compare to other predictors.

#### 7.5.4 Patient age and Systemic inflammatory response syndrome (SIRS)

Presently we have investigated pre-surgical cytokines as predictive indicators of the complexity of post-operative recovery, in particular of SIRS related complications. It is however, important to consider whether there are any other indicators, perhaps less complex in terms of measurement, that might also give good indication of post-op status. Our analysis has already eliminated EuroScore as a potential screening test, but there is anecdotal evidence that age may be to some degree a marker of post-operative complexity. We therefore carried out a regression analysis with age as the determining factor. In this model, the predictor is the age and the response is SIRS.

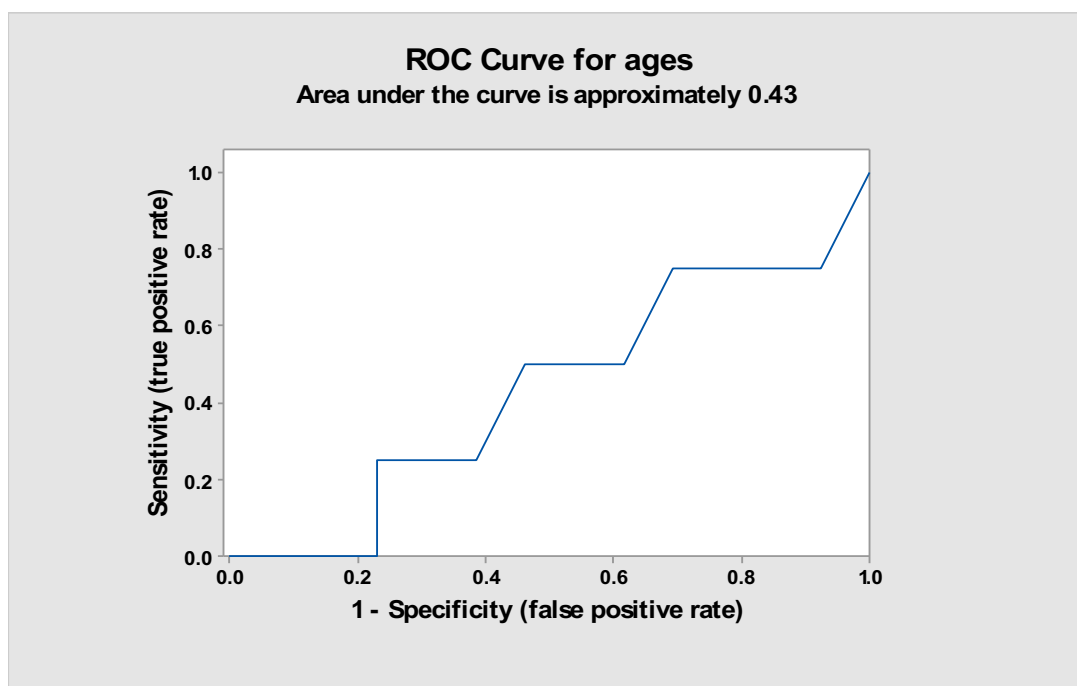

**Figure 75:**Patients' ages receiver operating curve.

The results showed there is no significant relation between the ages and the occurrence of SIRS by three different methods. Firstly, odd ratio is less than 1 (0.9747) which means that there is not association between ages and and systemic inflammatory response syndrome. Secondly, the predictive power is 1.43 % which is

relatively small. The predictive power indicates that this model is not a good fit for the data. Finally, the area under the curve (AUC) is 0.43 which means the curve is not adequate to fit the data.

## **7.6 Fourier transform infrared spectroscopy (FTIR) Results**

As outlined in the previous chapter, two methods for measuring cytokine levels were to be considered in the context of this program of work, a conventional ELISA approach and the application of Fourier transform infrared spectroscopy (FTIR). The objective of this process was to ascertain the most appropriate method of measurement for our proposed screening test system. To answer this question, we carried out measurements using both systems on the same population of blood samples harvested from our patient group. The critical factors to be considered in this section of the work were accuracy (taking the ELISA data as the gold standard), processing volume and processing time.

All spectrometer scans represented patients' plasma absorbance at different wavenumbers. There were two spots for each patient sample. The total number of samples analysed therefore was 416 (static control, dynamic control, DEHP plasticised PVC and liquid DEHP). As seen in figure 76, the absorbance of each sample was taken by calculating the mean of two dry scans of the two spots and then plotting the range of absorbances against the wavenumbers. DEHP plasticised PVC and liquid DEHP results were higher in the majority of those patients when compared to the corresponding control samples. This is confirming the activation effect already identified with the ELISA approach. For analysis purposes the peak absorbance of each spectrum was considered to represent the peak concentration level of each sample. Control samples of known concentration were processed to



produce a standard concentration curve for the assay, and this process is shown in figure 77.

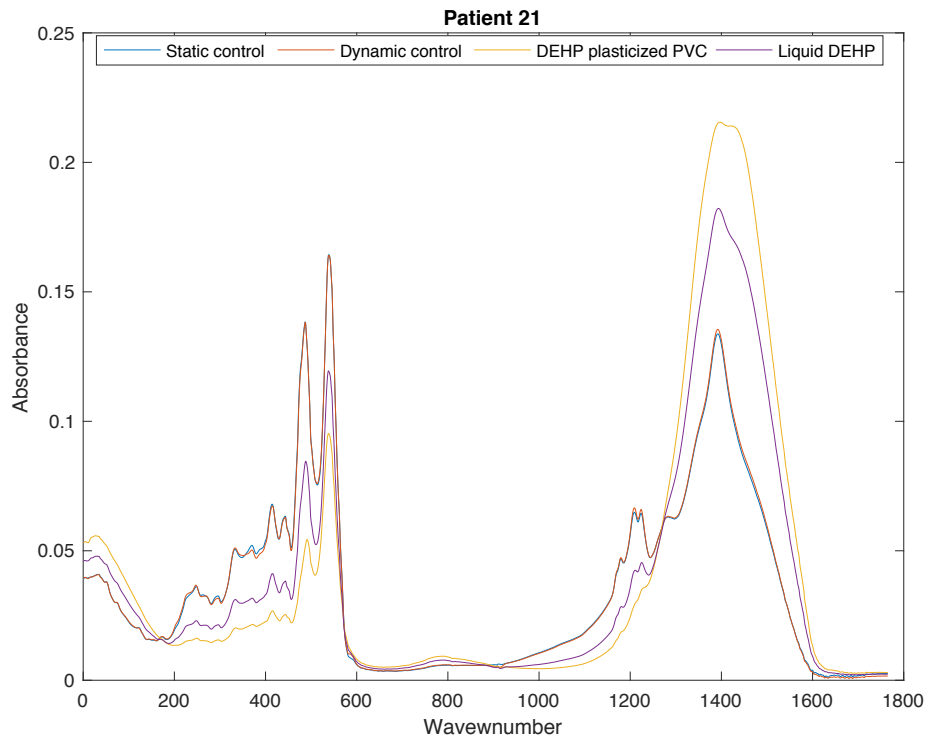

Figure 76: Representative FTIR spectrum results.

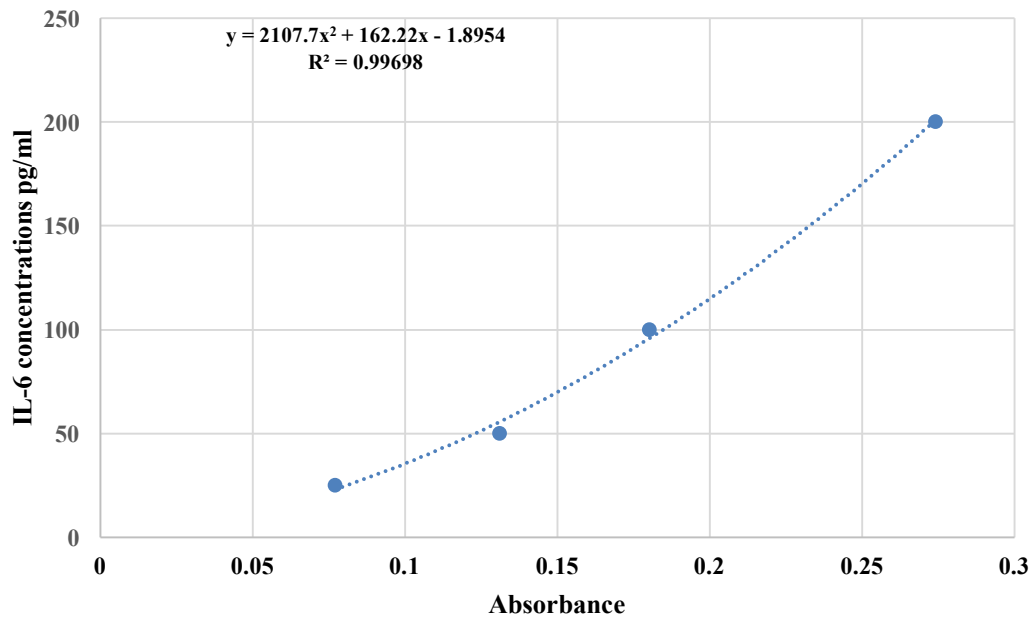

Figure 77: FTIR standard control curve.

The scanning process was then carried out on all blood samples and the corresponding cytokine concentration calculated using the standard curve trend equation. The result of this process can be seen in table 33 where comparative data can be seen with the ELISA derived sample data. This process was carried out on samples involving DEHP plasticised PVC initiator and IL-6 as the marker as this had already been shown to be the most appropriate marker for the screening process in terms of patient outcome measures.

The raw scan data for each sample can be seen in Appendix I.

Patient number	ELISA	FITR absorbance	FITR concentrations pg/ml
	IL-6 DEHP PPVC (pg/ml)		
1	159.5921299	0.1158	45.15317423
2	138.5112965	0.1324	56.53000315
3	202.4849913	0.2767	204.3624773
4	120.128687	0.2232	139.3140084
5	157.601392	0.152	71.4583408
6	100.4110515	0.2218	137.7738033
7	290.9397986	0.2819	211.3282996
8	183.2024745	0.2642	188.0840406
9	158.5972073	0.15	69.86085
10	102.5017673	0.2034	118.298985
11	93.06542743	0.2252	141.5286338
12	135.4676131	0.2115	126.6962933
13	99.36435463	0.1586	76.84969349
14	151.6077545	0.1534	72.58661701
15	79.30750832	0.2025	117.3830231
16	86.73436447	0.1325	56.60205813
17	87.79177328	0.1755	91.49189693
18	77.17751548	0.1402	62.27687951
19	87.79177328	0.1452	66.09566741
20	92.01248192	0.2153	130.7310815
21	152.755108	0.2155	130.9451249
22	123.666997	0.1461	66.79424112
23	208.0817313	0.2798	208.5014579
24	219.714333	0.2806	209.576158
25	230.196868	0.2819	211.3282996
26	208.0817313	0.2763	203.831366
27	244.724325	0.2798	208.5014579
28	301.106413	0.2799	208.6356479
29	156.0730833	0.2245	140.7515969
30	138.2855393	0.2324	149.6408992
31	137.166325	0.2305	147.4789379
32	100.886037	0.2367	154.5899501
33	351.9218193	0.2799	208.6356479
34	223.917925	0.2819	211.3282996
35	114.596925	0.1861	101.2901587
36	28.024288	0.2363	154.1262852
37	32.8273	0.2357	153.4320526
38	180.1624893	0.234	151.4733012
39	181.247325	0.2354	153.0855053
40	204.890692	0.2798	208.5014579
41	106.2910044	0.2247	140.9733967
42	111.8426739	0.1486	68.75263909
43	133.0663095	0.2252	141.5286338
44	120.1963483	0.2238	139.9766256
45	85.32195168	0.2273	143.8721377
46	93.02394371	0.2303	147.2522483
47	88.0695227	0.1903	105.3035035
48	95.78128491	0.2267	143.2006683
49	143.7537067	0.2216	137.5544485
50	87.51972935	0.1577	76.10369653
51	72.18218251	0.2249	141.1953651
52	117.9656312	0.2295	146.3471759

**Table 33:**ELISA and FTIR data for IL-6 DEHP plasticised PVC.

Comparative derived data from the FTIR and ELISA processes are shown below in figure 78. There were differences in the absolute values derived from these two processes, but further analysis of overexpressing samples (200 pg/ml and above) were further analysed and similar trends were identified between the two methods, Table 34. The patients extracted from this sifting process, (Patient 3, patient 7, patient 23, patient 24, patient 25, patient 26, patient 27, patient 28, patient 33 and patient 34 and patient 40) all showed over expression of IL-6 in response to the DEHP plasticised PVC stimulus. These patients were further analysed in relation to their post-operative SIRS status (Table 34) where the relationship between measured values above 200pg/ml and SIRS status was seen to be closely related. Of the 11 patients identified by this threshold method, 8 (72.7%) were identified by both methodologies and 3 (27.3%) were seen to be false positive values. There were no false negatives in this group. These data suggest that this method, applied to both the ELISA and the FTIR techniques returned the most sensitive screening of patients with a propensity for post-operative SIRS and furthermore, that there was equal sensitivity using both analytical techniques. The results suggest that both the ELISA and FTIR techniques are both suited to the further development of a POC SIRS screening device. However, the FTIR approach was less complex, faster and more suited to the development of a sensor technology for this screening process. The ELISA technique, albeit the gold standard for the measurement of biological markers, is time consuming and requires multiple processing steps, and would therefore require the development of a more complex and less user friendly technology.

### IL-6 DEHP plasticised PVC

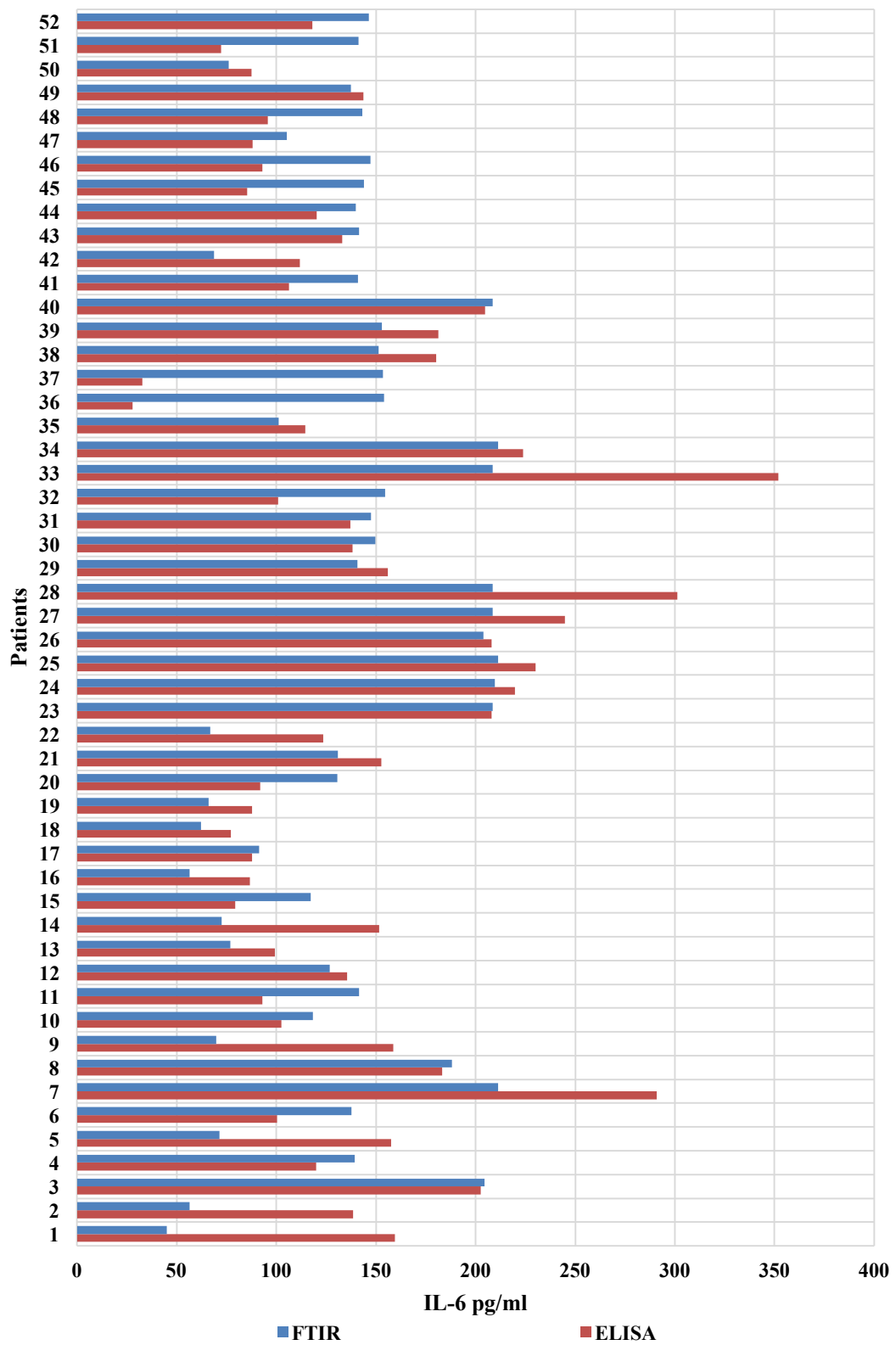

Figure 78: Patients' IL-6 DEHP plasticised PVC scores with ELISA and FTIR.

Patient number	ELISA	FITR absorbance	FITR concentrations pg/ml	Post-operative complications
	IL-6 DEHP PPVC (pg/ml)			
3	202.4849913	0.2767	204.3624773	Yes
7	290.9397986	0.2819	211.3282996	Yes
23	208.0817313	0.2798	208.5014579	No
24	219.714333	0.2806	209.576158	Yes
25	230.196868	0.2819	211.3282996	Yes
26	208.0817313	0.2763	203.831366	No
27	244.724325	0.2798	208.5014579	Yes
28	301.106413	0.2799	205.379812	Yes
33	351.9218193	0.2799	208.6356479	Yes
34	223.917925	0.2819	211.3282996	Yes
40	204.890692	0.2798	208.5014579	No

**Table 34:**Patients who develop SIRS with both ELISA and FTIR techniques.

## 7.7 Summary

This study has confirmed the following;

1. That DEHP plasticised PVC is a good initiator of inflammatory processes in patient blood.
2. Activated IL-6 in discreet patient blood samples is the best marker of the cytokines tested of the propensity for heightened IR to the surgical procedure.
3. The activation of IR, using DEHP plasticised PVC as an initiator and IL-6 as a marker in blood samples taken from patients prior to surgery results in a good correlation with the clinical outcome of patients undergoing open-heart surgery and can be employed as a screening test for the propensity for post-operative SIRS.
4. Other commonly employed indicators of SIRS risk, Age and EuroScore are not sensitive markers for post-operative complications associated with SIRS.
5. The use of a threshold response approach (200 pg/ml and above) to analysing IR activation in pre-surgical samples results in a good correlation with clinical outcome.

6. Both the FTIR and ELISA methods are suited to the development of a screening technology for the propensity of patients to develop SIRS during the pre-surgical phase.
7. The FTIR technique, with its reduced complexity and processing time, is best suited to the development of the intended device.

# **Chapter 8: Device development**



## **8 : Device development**

### **8.1 Device development**

The overriding objective of this thesis is the development of a point of care sensor technology for the assessment of the propensity for patients undergoing open heart surgery to develop a heightened blood/material contact mediated inflammatory response. The significance of the IR to OHS has already been described in previous chapters, but this is one of the most challenging complications of OHS and to date is largely treated in a responsive manner in the ITU setting. The purpose of this screening process is to identify those patients who are at risk from this response prior to the surgical intervention and to stream these patients either to a different treatment modality, for example off pump surgery, or to target these patients with the broad array of techniques and technologies designed to moderate its impact, for example surface treatment, haemodialysis, and pharma solutions. These moderating approaches are not generally employed in the general patient population due the cost of doing so. A pro-active response supported by the deployment of the proposed screening sensor would permit the deployment of these technologies in a target patient population, resulting in a reduced additional clinical cost. As described in the previous chapters, there is a process of screening that appears to be reliable in identifying these at-risk patients in the pre-surgical phase that correlates well with the post-surgical outcome. This approach, using materials commonly deployed in the CPB circuitry, DEHP plasticised PVC as an initiator and IL-6 as the marker, can be measured using one of two techniques, conventional ELISA measurement and FTIR. Both appear to be capable of discriminating between the heightened IR patients and the non IR patient populations with a good degree of reliability. In terms of

developing the sensor technology itself, these techniques require a different approach to sample processing. The ELISA technique would require a complex sample pathway involving the use of a lateral flow strip system (Figure 79) that will perform sample activation, sample separation (plasma extraction), followed by the ELISA process itself and terminating with a concentration measurement step using a reader. The FTIR system is a much simpler system that requires no sample preparation insofar as it measures concentration unprocessed plasma samples, but still requires a blood activation step and sample concentration measurement step (Figure 80). One additional key difference between the two systems is the processing time between the two systems, ELISA taking in the order of 60 minutes whereas with the FTIR samples can be processed in less than 10 minutes. This suggests that for a rapid screening test, the FTIR would be the most suited approach.

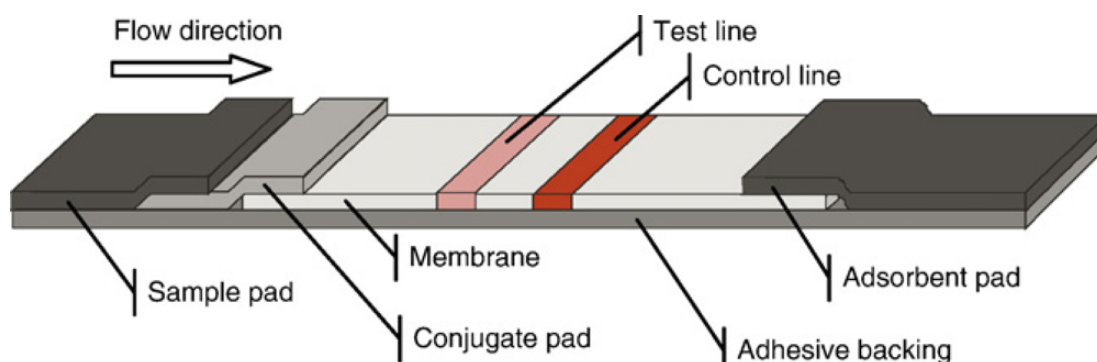

**Figure 79:** Lateral flow strip (LFS) components (Assadollahi et al. 2009).



**Figure 80:** Gemini Analyser by Thermo Fisher. This is a handheld FTIR/Raman analyser that is capable of measuring single samples in a similar manner to that of the laboratory device employed in the body of this work. (Taken from : <https://store.federalresources.com>)

Key to the development of the technology proposed in this work is that the device developed should be portable and capable of measuring the molecular target with some accuracy and critically to identify those samples that are overexpressed beyond a particular threshold value, as described in the previous chapter. Both the ELISA and handheld FTIR approaches are capable of meeting these requirements, however, the FTIR approach will do this with fewer processing steps.

The two systems have one common requirement, that the blood sample taken from the patient can be activated and the plasma separated. The overall sample processing scheme is shown in figure 81.

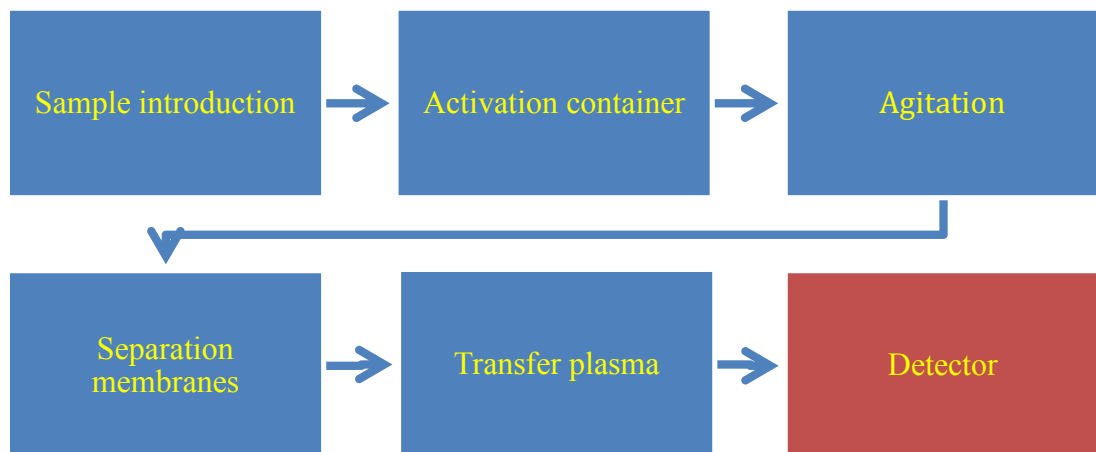

**Figure 81:** Schematic diagram of the measurement procedure.

Common to both approaches is the need to agitate the blood samples prior to plasma separation and sample measurement. To achieve this, irrespective of the measurement approach, a technology would need to be developed that achieves the sample preparation objective. To this end an activation chamber was developed that was designed to mix the sample when in contact with the activating material.

### **8.1.1 Activation chamber**

The activation chamber has two functions, firstly, to act as a blood reservoir in which the blood can be exposed to the activating agent and secondly as a vessel in which the blood /activating mixture can be agitated to evaluate exposure.

The basic design was to create a blood mixing chamber with a breakaway section to extract the blood after processing, with the agitation being provided by a DC motor attached to the lower aspect of the chamber. A design was developed for this element of the technology, with the overall dimensions of the chamber being defined by the

size of the DC motor employed. The design was carried out using Creo software, figure 82. The use of the Creo software permitted direct 3D printing of the component for rapid laboratory experimentation. As can be seen from the rendering in figure 82, the design incorporates a container for blood processing and a "snap-off" section for plasma extraction, provided by the thinner walled frontal section of the chamber. The snap-off function was further enhanced by the inclusion of a grooved inclusion on both lateral aspects of the thin walled element.

This component was configured to be compatible with the 3D printing techniques described below.

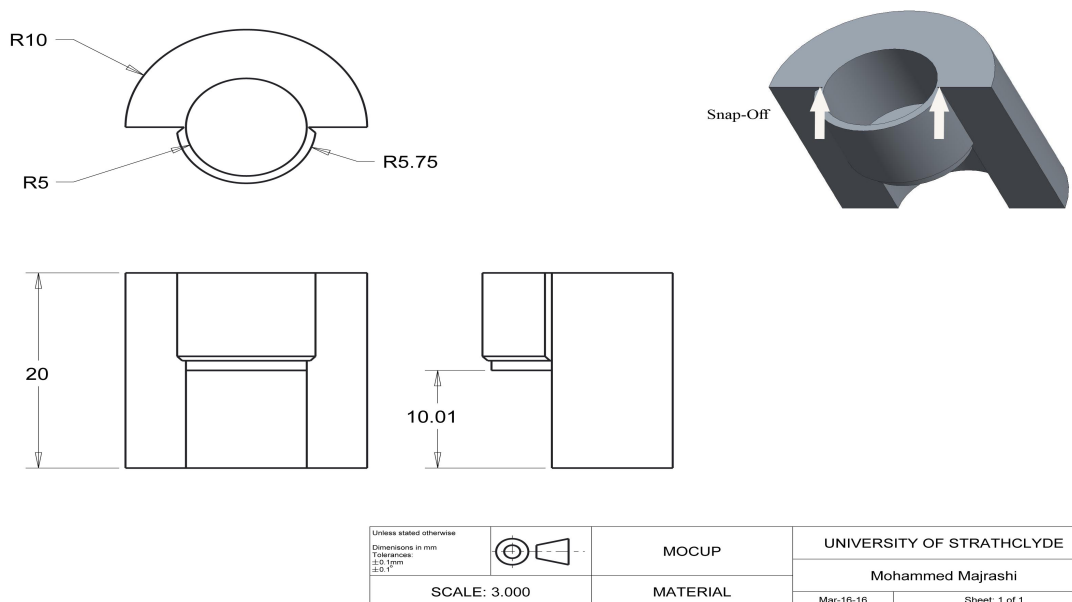

**Figure 82:**3D design of the activation chamber. The design has the following dimensions: height 20 mm, radius of the upper side is 10 mm, radius of the thin layer (which will be used to attach with the separation membrane to allow plasma absorption process ) is 5 mm.

### 3D printing

Three dimensional printing is a manufacturing technology aimed to produce an object from different ranges of materials such as ceramics, plastic, metal, liquid and living cells via a fusion and deposition process.

In recent years, there is an increase demand on 3D printing applications specifically in healthcare (Schubert, van Langeveld, and Donoso 2013). Crucially, from the medical device perspective, 3D printing offers a degree of versatility in design and manufacture that allows the generation of highly complex and application specific components (Banks 2012). Presently, 3D applications are impacting on many areas of manufacturing practice, including the medical and health sector. This technique has significantly accelerated the product development cycle and has led to a shortened concept to development to delivery time.

Medical application of 3D printing are classified into several categories such as anatomical models, organ fabrication, custom prosthetics and implants. (Klein, Lu, and Wang 2013).

In the present work, 3D design of the device, in this case the exposure container was printed according to the steps in table 35.

Steps	Description
1	Design the object by using a creo software and save the object as STL file.
2	Upload the file and open it with a simplify 3D (version 3.1.1) software.
3	Manipulate the design to be suited for printing.
4	Send the command to the printer and wait for the final product.

**Table 35:** Activating chamber printing steps.

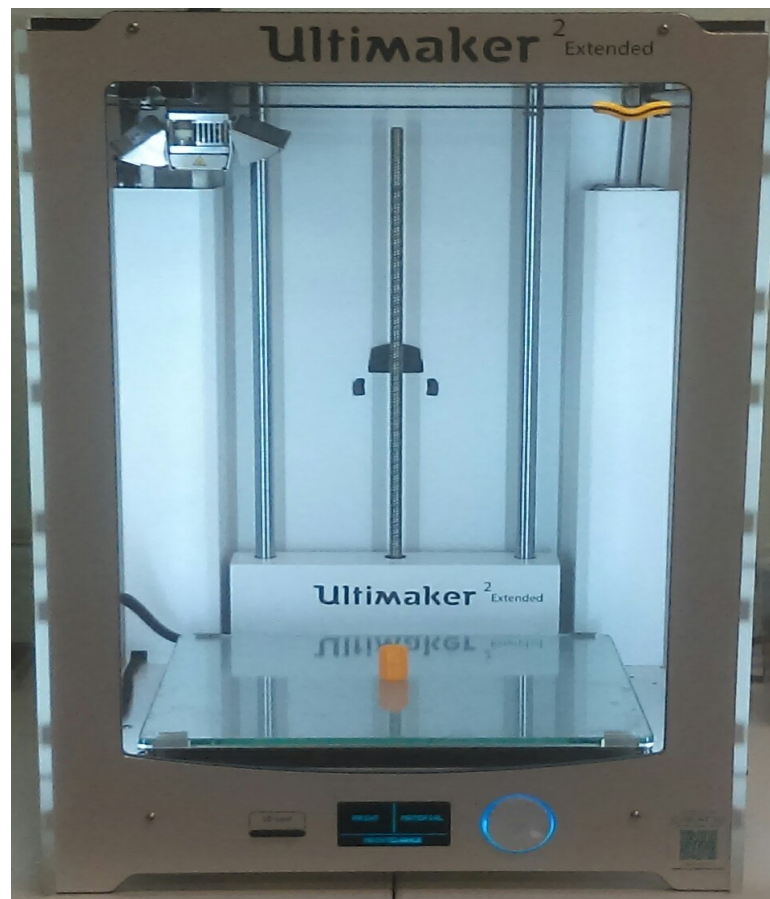

**Figure 83:** Ultimaker 2 extended 3D printer. It was used to print the exposure container chamber that will be explained in the following section. This printer used PAL (Polylactic acid) material in the printing process of the object.

Once printed, the DC motor was connected to the underside of the chamber and the function of the device tested. The DC motor was utilised to provide the agitation function through the generation of vibration to the chamber. The DC motor utilised (Pinzhi Co. Ltd, Fujian, China) is typically employed to provide the vibration alert in mobile telephone equipment and were through suited to the proposed purpose. To test the function of the assembled devices, a series of experiments were carried out. These are detailed in the following section of this thesis.

### 8.1.2 Testing the Function of the Activation Chamber

These experiments were designed to validate the efficacy of the proposed design of the activation chamber. In these experiments, bovine blood was introduced into the chamber which had been primed with ground DEHP plasticised PVC as the initiator material. The overall protocol is described in table 36. Bovine blood came in contact with grounded DEHP plasticised PVC initiator according to the described protocol in table 36, and a representation of the experimental setup is shown in figure 84.

Steps	Description
1	1 ml bovine blood plus 0.2 gram DEHP plasticised PVC were loaded onto the activation chamber. Another 1 ml blood was used as static control (without DEHP plasticised PVC).
2	DC vibrating motor was placed on the bottom side of the activation chamber (exposure container), and connected to the power supply.
3	Agitate blood with DEHP plasticised PVC starting by 1.5 V for three different time periods (10 min, 30 min and 60 min).
4	Remove blood and spin by centrifuge to get the plasma
5	Freeze all samples at -80°C for further analysis
6	Repeat the same steps with 3Volt.

**Table 36:** Bovine blood protocol(activation chamber)

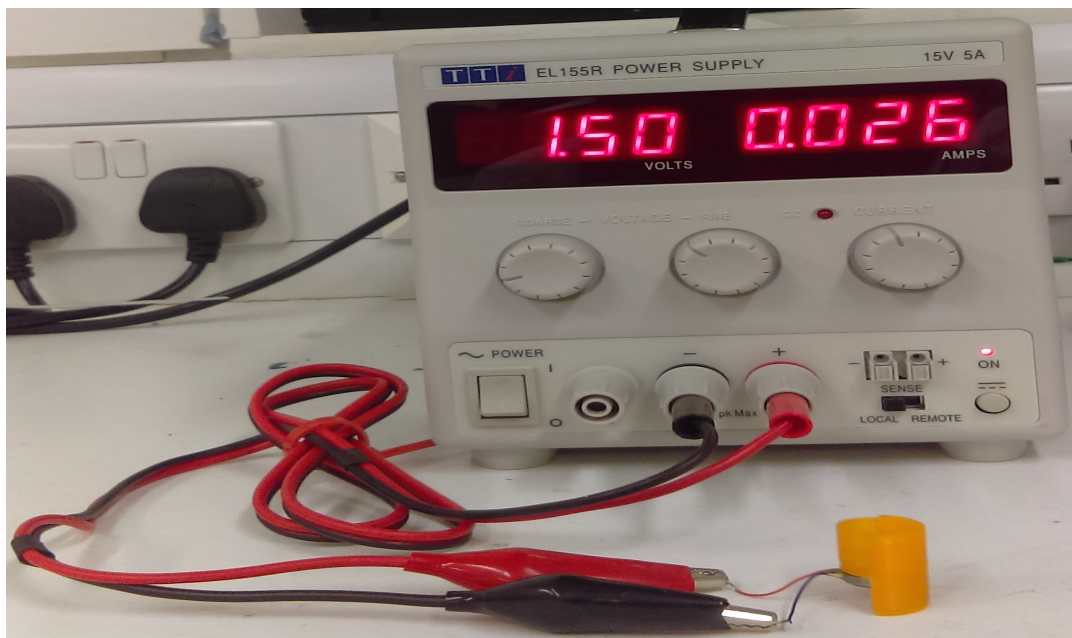

**Figure 84:** Experimental set up(DC motor, exposure container and power supply generator). 3V DC motor (10mm x 2.7mm) was used to generate motional vibration agitation of the blood with the ground DEHP plasticised PVC. This motor generates 1.5 Volt – 3 Volt and the maximum rotor speed is 4000 rpm.



At the end of the agitation process, the blood was removed from the chamber and was processed for IL-6 measurement using the ELISA technique.

### IL-6 measurements

The objective of this section of the work is to determine that it is possible to achieve IL-6 upregulation through the deployment of the new activation chamber and associated technology over a given time period of exposure (10 min, 30 min and 60 min) and at 2 different agitation rates (shown as 1.5 and 3 volts supply to the motor assembly) using bovine blood freshly harvested from the local abattoir (Sandyford farm, Paisley, UK). Comparison will be made with control samples in which no initiator agent is employed to ascertain that contact activation is being achieved and to determine the activating effect of the chamber itself.

In keeping with normal practice, IL-6 standard curves were generated based on the manufacturer's protocol (RD systems a biotechnne brand, Abingdon Science Park UK). Trendline equations were applied to calculate IL-6 concentrations of each sample (Figure 85).

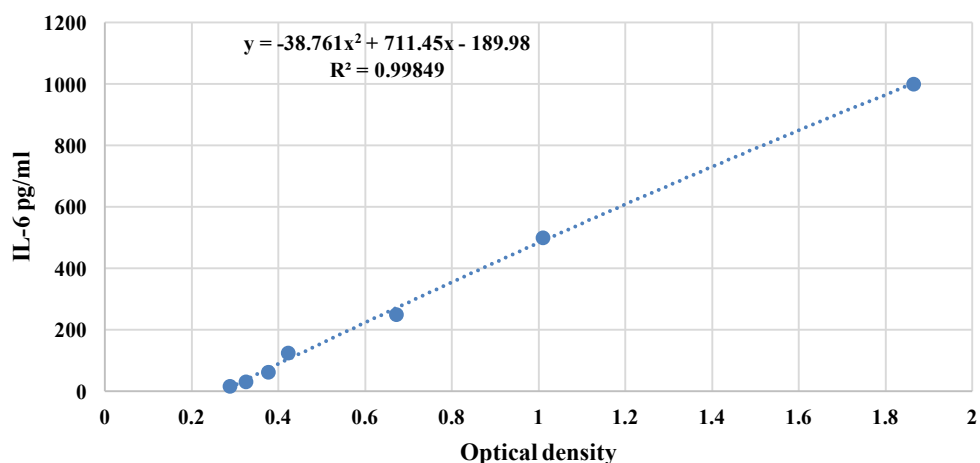

**Figure 85:** Representative IL-6 standard calibration curve. All IL-6 standard curves can be seen in Appendix J.

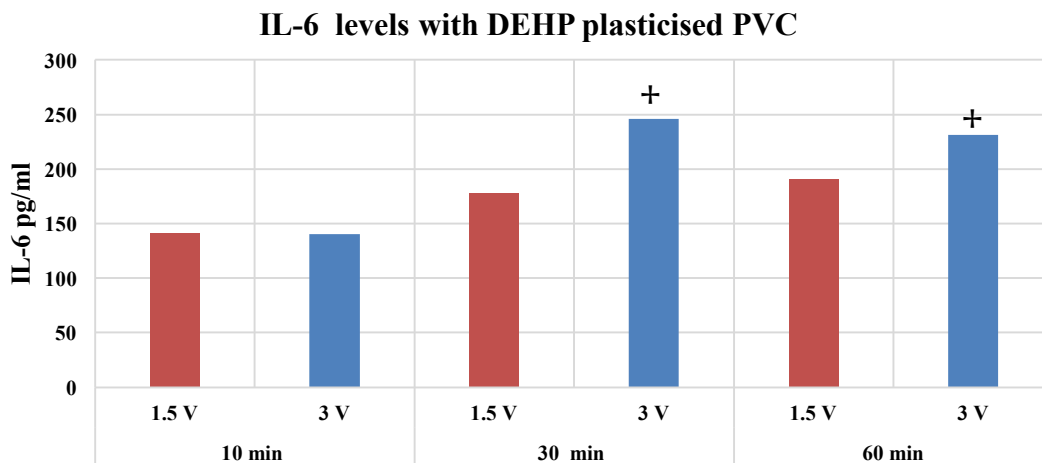

**Figure 86:** IL-6 concentrations in pg/ml with 1.5 Volt and 3 Volt at different agitation times (10 min, 30 min and 60 min) (n=3).

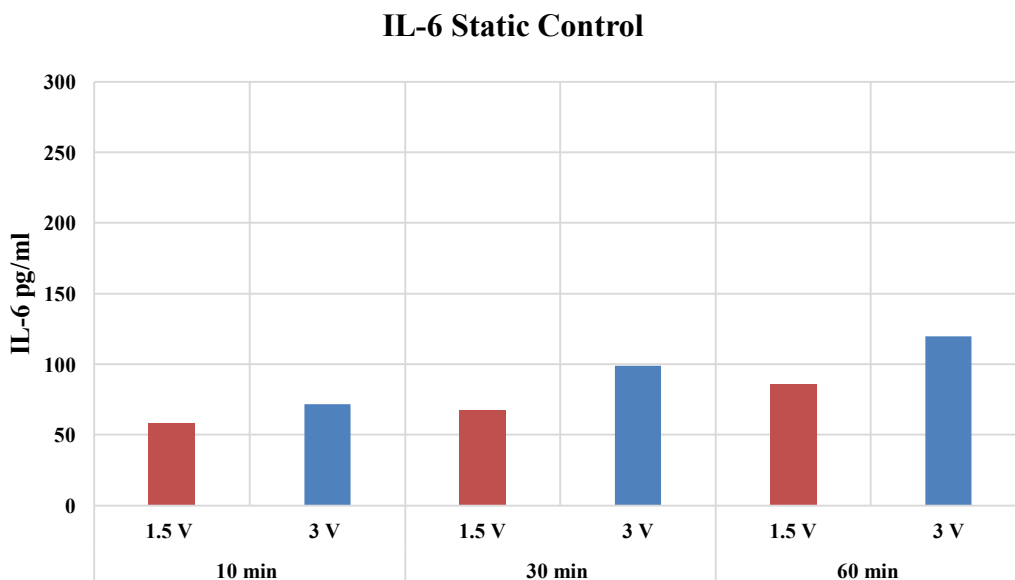

**Figure 87:** IL-6 static control concentrations at different agitation times. These data represented IL-6 levels of the static control blood which kept away from the agitation process (n=3).

The results showed a statistically significant difference between IL-6 levels with 3V and 1.5 V after 30 and 60 min respectively ( $p=0.038$ ,  $p=0.04$ ). these outcomes suggested that the most appropriate agitation speed can be achieved after 30 min (4000 rpm). The data also demonstrated that there was a statistically significant

difference between the static and dynamic samples in terms of the level of activation observed (119.75 pg/ml vs 231.28 pg/ml  $p=0.011$  after 10,30 and 60 minutes). This confirms the activation effect of the initiator agent (DEHP plasticised PVC) and that the system itself is not a significant initiator of IL-6. Critically, one might anticipate that "heightened expressers" of IL-6, those at risk patients, will show a heightened response to the screening system, but this remains to be demonstrated in clinical practice.

### **8.1.3 Separation membrane**

Having determined the configuration of the activation aspect of the system and having demonstrated its efficacy, the next step in designing this device is to assemble a separation technology that will effectively remove the cellular components of the blood and deliver the plasma component to the reader (FTIR). There are several possible solutions to this, mechanical and membrane based that could effectively achieve this key element of the sample processing procedure. Mechanical means, might involve the use of micro-centrifuge or magnetic flea technology to separate the cellular components, followed by a micro-pumping approach. Such an approach would be both complex and costly and may be challenging in terms of the re-usability of the system. The alternative approach is to utilise specific membrane technologies to firstly separate the blood cell from the liquid (plasma) component, followed by transporting the plasma by a wicking process to the reader assembly. This technique is commonly used in the lateral flow strip technology utilised for some molecular measurements. Such a process may consist of:

- (a) Nivid, a membrane designed by the Pall Corporation, which is used to separate whole blood and plasma. This is a single step process that separates

the plasma from the whole blood, and is sold as an alternative to microcentrifuge devices. These membranes come in various configurations for a number of different applications (Table 37). The membranes for different target applications have somewhat different characteristics and structures which we have observed using an SEM (see following section). Critically, all of these membrane types are capable of separating a volume of blood (depending on the application) in less than 2 minutes, a factor that is central to the development of a rapid screening assay.

(b) A wicking membrane to transport the plasma to the reader assembly, see section 8.1.4

Membrane	Membrane grade	Plasma separation time	Plasma recovery	Comments
Asymmetric polysulfone	GF	<2 min	>=60 %	Small blood volume application, finger sticks
	GX	<2 min	>=60%	
	GR	<2 min	>=80%	Larger blood volume applications such as lateral flow immunochromatographic devices.

**Table 37:** Plasma separation membranes specifications

(Taken from: <http://www.pall.com/main/home.page>).

### **Investigation of the characteristics of Nvid membranes using a Scanning electron microscope (SEM)**

Scanning electron microscope (SEM) is a method for high resolution images of the materials surfaces. The technique based on focusing high energy electron beams in order to capture images at different magnification and different depth of field. The technique is widely used in the biomaterials and materials science fields and permits

close scrutiny of surfaces and surface structures and inclusions. In particular, this approach is suited to the investigation of surface pore structures in membrane surfaces. The devices have advanced considerably in recent times and new desktop devices, such as the one utilized in this study (figure 88) are now replacing older larger and more complex systems.



**Figure 88:**Electron microscope scanning system (Hitachi, TM-1000).

### **Samples preparation**

A small piece of the target material is attached to the specimen stage and then inserted into the SEM chamber. Unlike historical systems, it is not necessary to sputter coat the sample with gold, providing the sample is in a dry state. This makes the scanning process much simpler and less time consuming. The scan can then be carried out at a range of magnifications to determine the high and low level structure of the target material.

## Results

### GF membrane

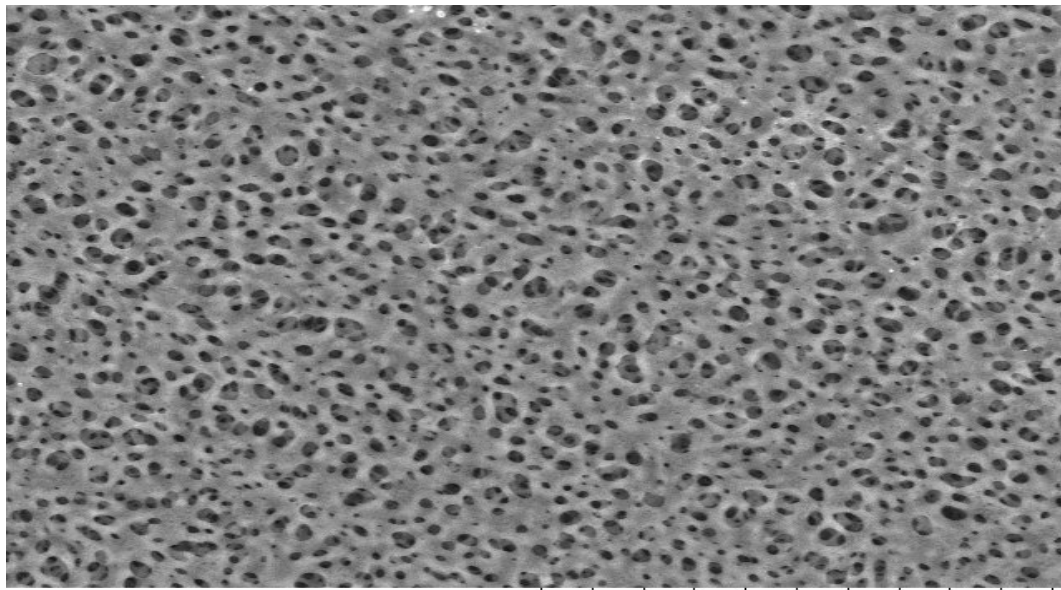

TM-1000\_2294

2015/09/23 13:41 L

x400 200 um

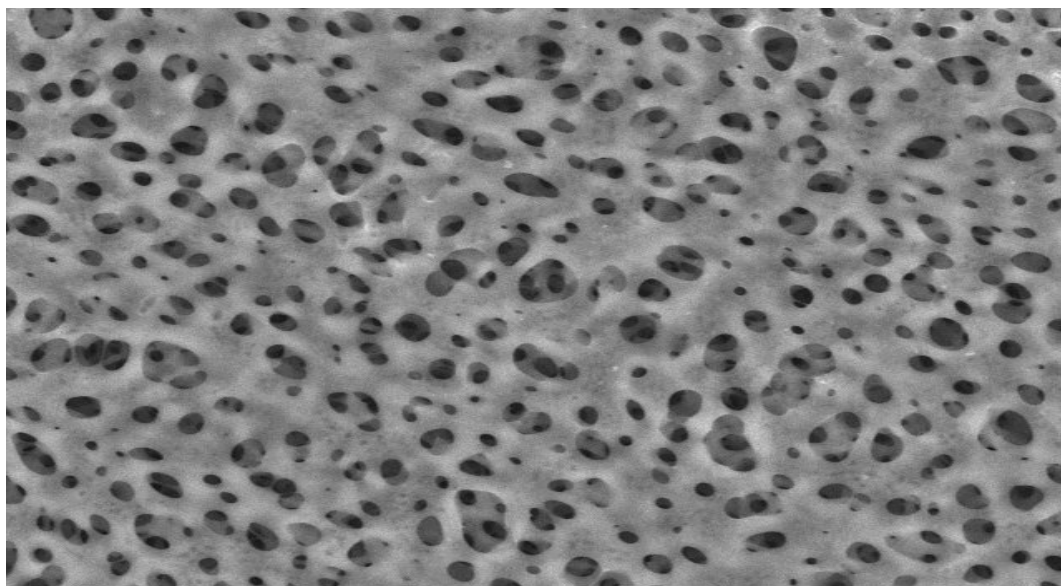

TM-1000\_2295

2015/09/23 13:42 L

x800 100 um

GX membrane

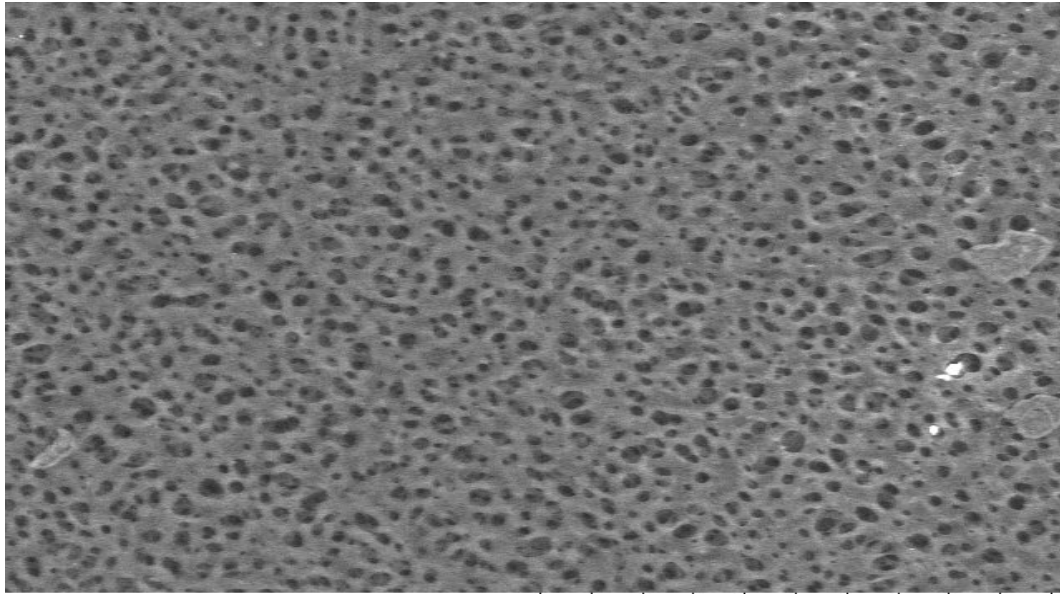

TM-1000\_2299 2015/09/23 14:02 L x400 200 um

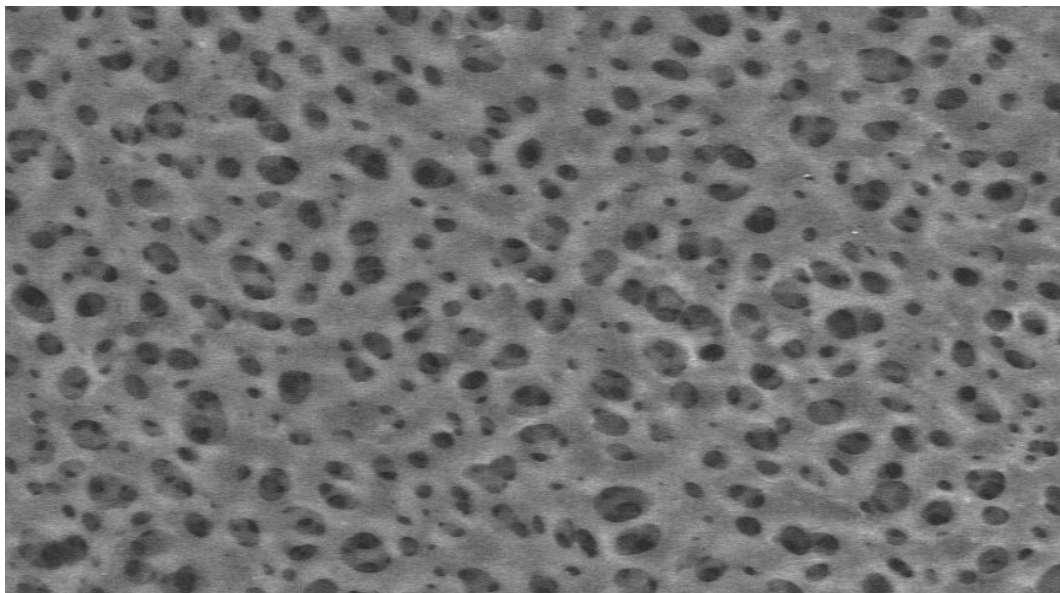

TM-1000\_2298 2015/09/23 14:02 L x800 100 um



## GR membrane

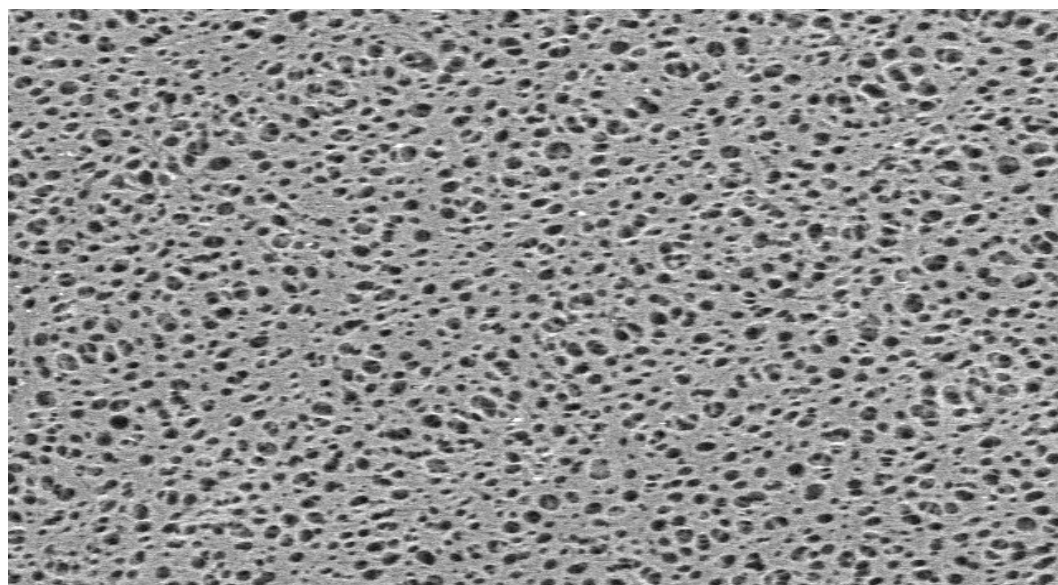

TM-1000\_2296 2015/09/23 13:51 L x400 200 um

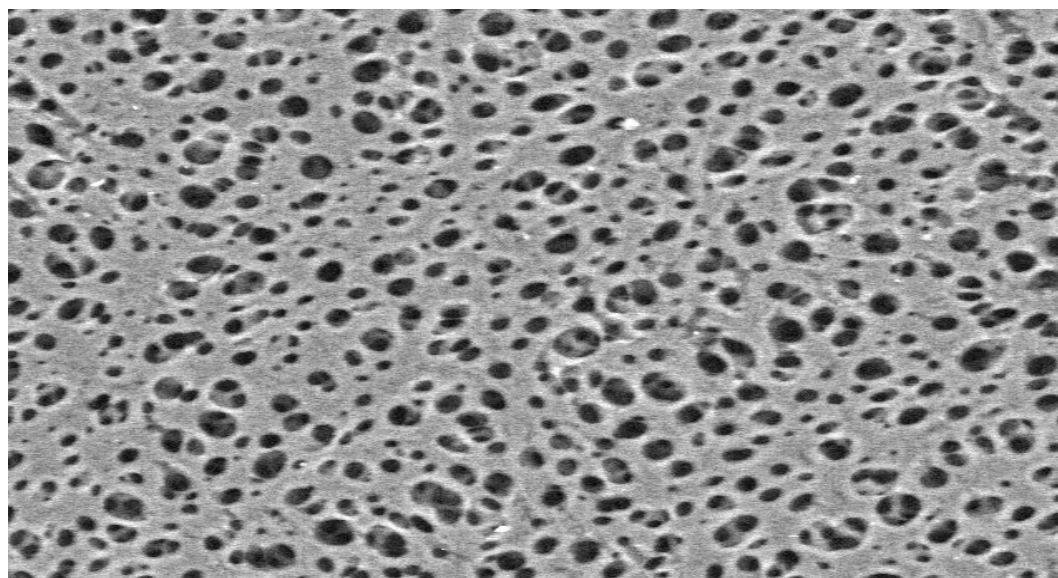

TM-1000\_2297 2015/09/23 13:52 L x800 100 um

**Figure 89:** Different scans of the three different grades of separation membranes (plasma separation).

The scanning electron microscope showed a good discrimination between three different types of Pall separation membranes. The surface of the grade GR showed a more porous structure when compared to other grades of membrane (GX and GF)



suggesting that this is the most appropriate membrane configuration for the intended application.

#### 8.1.4 Wicking membrane

The final stage in the sample processing is to carry the plasma separated by the previous step to the measurement device. To achieve this, we propose to employ a wicking membrane assembly, connected to the activation chamber and cell separation membrane assembly. A number of wicking membranes are commercially available and the properties of the most promising of these (from GE Life Science, Berlin, Germany) are outlined below in table 38.

Product	Material	Properties	Thickness (µm)	Wicking rate(s/4 cm)	Water absorption (mg/cm <sup>2</sup> )
CF3	Cotton linter	Medium weight	322	174.3	34.6
CF4			482	67.3	49.9
CF5			954	63.3	99.2
CF7		Thick material suitable for high sample volume	1873	35	252.3

**Table 38:** Wicking membrane specifications.

For a rapid analysis system, the fundamental requirement is that the plasma is "wicked" from the separation step in the process through to the detector as quickly as possible. For this reason, we intend to employ the CF3 membrane, the properties of which are shown above. This membrane has a rapid transfer capability, is relatively thin in profile, therefore suitable to low volume applications, and has a low water adsorption property.

### 8.1.5 Proposed Device Configuration

This work has outlined the design requirements for a rapid screening sensor technology for the screening of patient propensity for heightened IR to open heart surgery, but may also have applications in other areas of medical/surgical practice. The technology described has a number of steps from sample harvesting through to measurement. These steps require a number of technologies to activate the blood sample, separate the plasma from the whole blood and to carry to plasma through to the measurement device. These technologies that comprise the technology train for this device are outlined below.

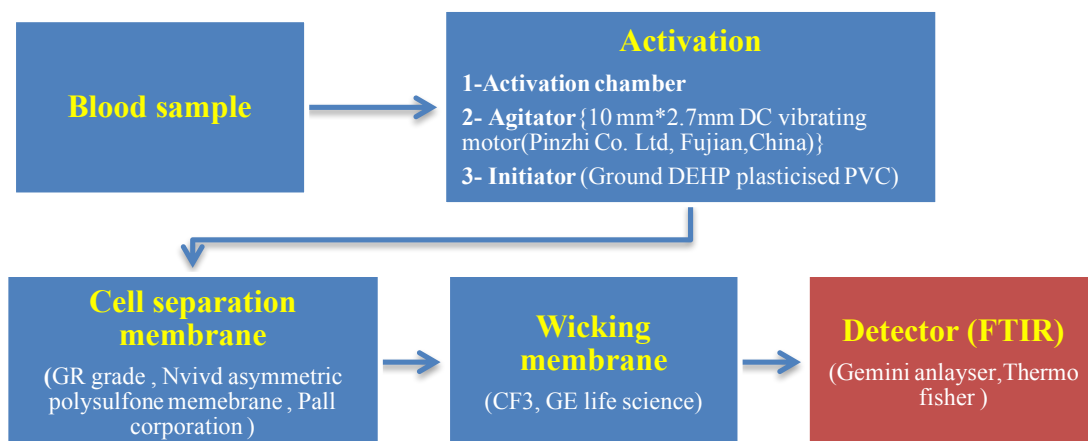

**Figure 90:** Schematic diagram of the proposed screening test configuration steps.

The technology train is now well defined and each element of this has been tested for conformity with our overall objectives. It is clear that this technology is achievable and that the activation stage (Chapter 8) and the detector elements are viable (Chapter 7). The required plasma separation and transportation vehicles, in the form of two commercially available membranes are available and appropriate for this application, leading to a device design that is shown below (Figure 91).

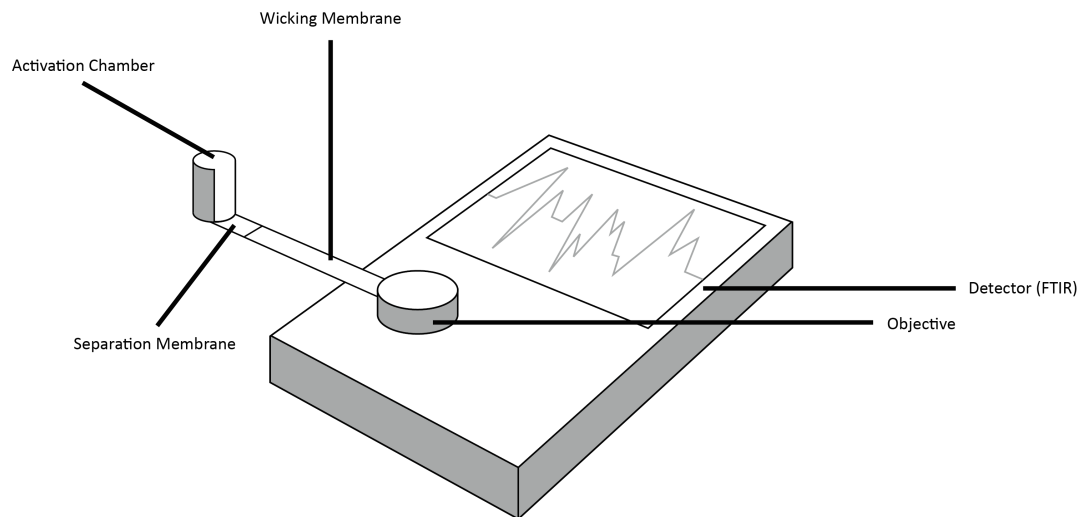

**Figure 91:** Schematic of the proposed device for clinical testing.

However, in the context of the present study, it has not been possible, primarily for financial reasons that are beyond the scope of the current project, to further develop the technology to a clinically deliverable device. This will form the basis of the the work going forward beyond the current project.

## 8.2 Summary

1. FTIR is the most appropriate technique that will be employed in the screening test development. It does not require any sample preparation and the results can be obtained within 10 min.
2. Agitation of the blood sample with DEHP plasticised PVC material can be achieved by the development of an activation chamber.
3. Testing the activation chamber with the attached DC vibration motor showed a significant overexpression of IL-6 levels beyond the control values after 30 min with rotor speed 4000 rpm. This confirms the suitability of this approach to activating blood samples.

4. The final design of the proposed device is based upon a combination of proven commercial materials and the application of developed technologies combined with FTIR measurement techniques.
5. Financial constraints limited the development of the proposed technology to proven steps in the cycle, but it was not possible to bring together the components into a formal device. This will be the focus of work going beyond the current project.

## **Chapter 9: Discussion**

## **9 : Discussion**

### **9.1 Achieved objectives**

The achievements of this work in association with the objectives are summarized below;

1. Studying the effect of two common initiators DEHP plasticised PVC and liquid DEHP in the initiation of inflammatory response.
2. Determining the effect of different agitation times in the upregulation of pro-inflammatory cytokines.
3. A clinical study was conducted to investigate the clinical impact of DEHP plasticised PVC and liquid DEHP initiators on the patients' blood samples prior to the surgery. The results were expressed in terms of the rapid pro-inflammatory cytokines (IL-6, TNF- $\alpha$  and CRP).
4. Specifying the most heightened cytokines based on the outcomes from both laboratory and clinical investigations.
5. Specifying the most appropriate initiator to be used in the development process of the screening test technology.
6. Determining the most suitable approach to measure the heightened inflammatory marker levels.
7. Developing the screening test technology which which is the core of this work.

## **9.2 Why developing a POC screening technology?**

The aim from this work was to develop a predictive screening technology that can enable surgeons and clinicians to specify high risk patients prior to open heart surgery. Those patients may develop series of deleterious outcomes such as systemic inflammatory response syndrome (SIRS). SIRS patients required to extend their length of stay in hospital and ITU costing approximately 2000 euro per day. This number is subjected to increase based on the severity of the patient's condition and the complexity of their treatment (Brun-Buisson et al. 2003). Therefore, developing a screening point of care technology to identify those "at risk" patients prior to the surgery may contribute to reducing many unwanted complications and may mitigate the financial burden on the healthcare providers. Once developed, this technology may enable surgeons to stream identified patients to other treatment modalities that do not present such a significant IR risk, for example off-pump approaches, stenting and the use of costly surface modifications and mini-CPB techniques that are not suited to the broad patient community.

## **9.3 Laboratory and clinical studies**

As an early step to achieve the optimal design of the device, it was necessary to determine the effect of the materials / initiators that come in contact with blood during the surgery. From the literature, it is clear that the primary source of inappropriate stimulation of the inflammatory processes is blood contact with the artificial surfaces of the CPB system, in particular the DEHP plasticised PVC tubing structures (Day and Taylor 2005). Therefore, the objective of this work was to utilise the pro-inflammatory properties of the DEHP plasticised PVC as a stimulant for the proposed screening test. This was thought to have two major benefits, firstly that the

pro-inflammatory properties of this material are well defined and secondly that this material is commonly used in CPB systems and was therefore an appropriate stimulant as patient's blood will come into contact with it during clinical practice. Our early results confirmed this association and demonstrated that DEHP plasticised PVC as a suitable initiator of IR for our screening test. We used different weights and different range of volumes of both initiators (DEHP plasticised PVC and liquid DEHP), and two target cytokines for this purpose, IL-6 and TNF- $\alpha$  as there are commonly utilised in clinical practice to evaluate the inflammatory response and have been utilised in previous studies by this group for this purpose (Gourlay et al.2003). Both are upregulated fairly early in the cascade, can be measured using commercial assay kits which will form the basis of the early characterisation studies. As initiators of the inflammatory response we used ground DEHP plasticised PVC and the plasticiser component of this, liquid DEHP. This group have already described the pro-inflammatory effects of DEHP per seen in previous work (Gourlay et al. 2001), and it was thought that investigating the solid material and the liquid component would give two options for the development of the final screening device. Ultimately it was clear that both initiators were effective in producing the upregulation of IL-6 and TNF- $\alpha$  in isolated bovine blood samples and that there was a clear dose response effect in this. These results confirmed the work of Gourlay, Samartzis et al in previous studies and substantiated the use of these initiators in the proposed device development (Gourlay et al. 2003).

Having determined that there is an appropriate target for measuring the early initiation of inflammatory response to blood/material interaction, and that there was the potential to develop a screening test for this, albeit this was at an early phase of



development, it was thought necessary to carry out a clinical study to investigate whether this test had any clinical validity, and whether there were any other markers, commonly used in the clinical patient journey that would be equally valid. A clinical study of some scale was carried out on 52 patients undergoing elective open-heart surgery for the repair of a number of lesion types. It was thought essential that there should be no selectivity in this patient cohort, other than they should be undergoing first time elective surgery. The purpose of this decision was that we wanted to determine the propensity for these patients to develop a significant IR without stratifying the patients in any way. It is generally accepted that patients who elicit a heightened IR to OHS are beyond pre-surgical prediction using conventional means, for example Euroscoring and age profiling, and our objective was to contrast this unpredictable outcome with our screening system results. Blood samples were taken from these patients' pre-surgery and processed in a similar manner to that employed in our laboratory study. These samples were exposed to DEHP plasticised PVC and liquid DEHP as described and, plasma harvested and processed for cytokine measurement (IL-6, TNF- $\alpha$  and CRP). At the same time, normal patient demographic data and data associated with the clinical course and critically, the clinical outcome in terms of post-operative IR associated complications were harvested for analysis.

After processing of all blood samples in order that the investigators would be truly blinded to the clinical outcome, the patient were split into two groups for analysis using the post-operative outcome measures, those with IR related complications and those with a normal uncomplicated clinical course. There were 12 patients who exhibited clear signs of post-surgical IR, that led to a more complicated clinical

course. Therefore, around 25% of the patients processed through the study has clear clinical signs of IR complications. This appears somewhat high in terms of modern clinical practice where one might anticipate around 10% in normal practice (Güvener, Korun, and Demirtürk 2015; Kaukonen et al. 2015). However, it should be noted that the CPB system and the protocol for its use was somewhat complex and expansive in terms of exposed surface area, and this may have had an impact. What is clear was that these patients had obvious signs of post-operative IR by the normal clinical measures, varying from moderate to severe when assessed as part of the normal clinical course by clinicians blinded to the focus of the study. Interestingly, our analysis of clinical predictive markers, for example Euroscore showed absolutely no correlation with clinical outcome, and the same applied to other markers considered to be indicative of post-operative complications of IR origin, i.e Age, Gender, CPB time, Cross clamping time etc. The Euroscore data, segmented into low, medium and high risk groups was not found to be a good indicator of post-operative complication rate with a number of false positive and false negative predictions. Analysis of the molecular measurements was however found to be a better predictor of outcome in relation to post-operative IR, with a best fit to the outcome coming from the exposure of blood to ground PVC with IL-6 as the target measurement. TNF- $\alpha$  and CRP were less well suited to the screening test, showing significant numbers of false positive and false negative indications. IL-6 was associated with 66.7% accuracy with only around 3 false positive and 3 false negative indicators. Statistical analysis using regressions analysis of the data demonstrated that DEHP plasticised PVC and IL-6 had a significant association with IR based upon patient outcome analysis. Although there was some misidentification

of outcome in this configuration, in general the level of accuracy observed, with fairly rudimentary techniques, was statistically satisfactory and is considered to be positive in terms of future development. These findings are supported by the current thoughts on IL-6 and its crucial role in the acute phase of inflammation. For example, (Nishimoto et al. 1989; Cruickshank et al. 1990) reported that IL-6 increased before CRP levels in patients undergoing surgery. Also, (Giannoudis et al. 2008) suggested a strong correlation between IL-6 and post-operative outcomes.

Our study suggests that a threshold value for the identification of the propensity for IR in a screening sensor system would enhance the accuracy, if not the sensitivity of the device. The results suggest that a threshold value of around 200 pg/ml for identification of patients who are likely to go on to have a significant IR is valid. Referring back to the post-operative clinical data, we found that 8 out of 12 (66.7%) patients who were identified as having significant post-operative complications of IR origin were above this threshold under pre-operative activated screening.

Having ascertained that the screening process has some clinical validity, the work focussed on developing the technology for the screening device. Critical to this is the determination of the format for the reader and the technology for activating the blood sample and carrying the plasma to the reader for molecular measurement. The activation required the construction of an activation chamber that contains the initiator (ground DEHP plasticised PVC) and this was designed and printed using a 3D printer technique. We utilised technology commonly employed in the telecommunications industry to facilitate the agitation of the blood sample in this chamber in the form of a DC motor, utilised in the mobile phone industry. Testing of this was positive and demonstrated that controlled activation could be achieved using

this technology. The separation and transfer of the plasma from the blood sample will be carried out using commercially available membrane technologies. We had two options for the reader element of the device, standard ELISA and FTIR techniques. Both were investigated during the clinical element of the study, and there was a strong correlation between the results obtained by the two techniques. The choice of the final reader technology is therefore driven by the level of complexity associated with the two approaches. The ELISA technique is a multi-step process, albeit an industry standard for measurement, but it not thought to be suitable for the hand-help POC technique envisaged in this project. The FTIR is simple to apply and readily available as a laboratory tool, and critically is now available in a hand-held device. Going forward, we anticipate that the device will be based upon the use of this hand-held FTIR technology and the agitation and transfer technology developed in the present project. Unfortunately, due to the financial constraints of the current project, we were not able to assemble the final device configuration, but have confidence that this can be carried out without any great difficulty and that this will form a part of the development cycle beyond the current project.

# **Chapter 10: Conclusion and Future work**

## **10 : Conclusion and future work**

### **10.1 Conclusion**

The objective of this work was to investigate the development of a point-of-care screening technology for the determination of the propensity of patients undergoing open-heart surgery to develop a heightened inflammatory response to the procedure. Critically, this screening will take place prior to the surgical procedure in order that those patients identified as heightened responders can be streamed to another mode of intervention. To achieve this, we utilised the known pro-inflammatory properties of DEHP plasticised PVC as an initiator of IR in a sample of blood and conventional ELISA and FTIR measurement as potential measurement tools for the most appropriate marker of the IR. The work concludes that this approach had validity and that of the markers assessed, IL-6 was the most suited. The assessment of clinical samples demonstrated that the screening test was capable of identifying patients known to have gone on to develop significant IR to the procedure with fairly low level false assessments. More work has to be done to further refine the technology and to construct the deliverable POC device for future clinical trials, but the overall outcome of the work suggests that this approach will offer considerable assistance to clinicians in selecting the most appropriate intervention for the treatment of OHS patients through identifying those with a high risk of IR complications prior to surgery. This approach will enable patient stratification in the planning stage and could have a considerable impact on patient morbidity and mortality associated with open heart surgery.

In the context of the present study, a number of objectives were set at the outset of the work. These are listed below, with a commentary on the degree to which these were met.

1. To study the effect of DEHP Plasticised PVC and liquid DEHP in the initiation of inflammatory response on bovine blood and measure the response in terms of IL-6 and TNF- $\alpha$  - **Objective completely met.**
2. To determine the effect of different agitation times in the upregulation of pro-inflammatory cytokines. – **Objective completely met.**
3. To conduct a clinical study to investigate the clinical impact of DEHP plasticised PVC and liquid DEHP initiators on the patients' blood samples prior to the surgery. The results were expressed in terms of the rapid pro-inflammatory cytokines (IL-6, TNF- $\alpha$  and C-reactive protein). – **Objective completely met.**
4. To determine the most appropriate and sensitive pro-inflammatory marker from the three rapid cytokines by using the suitable statistical methodologies. – **Objective completely met.**
5. To specify the most appropriate initiator (DEHP plasticised PVC/liquid DEHP) based on the laboratory and clinical studies. – **Objective completely met.**
6. To specify the most suitable approach to measure the heightened cytokine marker based on using two measurements methods (ELISA and FTIR). – **Objective completely met.**
7. To develop the screening test technology for measuring the heightened upregulation marker. – **Objective partially met.**

## **10.2 Future work**

The future work will include the continuation of the development cycle through to the production of a prototype device for clinical testing. A further clinical trial is also required, preferably of the multi-centre type, to determine the impact and efficacy of the screening process.



## References

- Abdel-Rahman, Ulf, Feyzan Özaslan, Petar S Risteski, Sven Martens, Anton Moritz, Abdallah Al Daraghmeh, Harald Keller, and Gerhard Wimmer-Greinecker. 2005. 'Initial experience with a minimized extracorporeal bypass system: is there a clinical benefit?', *The annals of thoracic surgery*, 80: 238-43.
- Abul K.Abbas, Andrew H.Lichtman, Shiv pillai. 1991. *Cellular and molecular immunology*
- Akaike, Hirotugu. 1974. 'A new look at the statistical model identification', *Automatic Control, IEEE Transactions on*, 19: 716-23.
- Albelda, Steven M, C Wayne Smith, and PA Ward. 1994. 'Adhesion molecules and inflammatory injury', *The FASEB Journal*, 8: 504-12.
- Amara, Umme, Daniel Rittirsch, Michael Flierl, Uwe Bruckner, Andreas Klos, Florian Gebhard, John D Lambris, and Markus Huber-Lang. 2008. 'Interaction between the coagulation and complement system.' in, *Current topics in complement II* (Springer).
- Anastasiadis, Kyriakos, Polychronis Antonitsis, and Helena Argiriadou. 2012. *Principles of Miniaturized Extracorporeal Circulation: From Science and Technology to Clinical Practice* (Springer Science & Business Media).
- Anastasiadis, Kyriakos, Polychronis Antonitsis, Anna-Bettina Haidich, Helena Argiriadou, Apostolos Deliopoulos, and Christos Papakonstantinou. 2013. 'Use of minimal extracorporeal circulation improves outcome after heart surgery; a systematic review and meta-analysis of randomized controlled trials', *International journal of cardiology*, 164: 158-69.

- Anastasiadis, Kyriakos, John Murkin, Polychronis Antonitsis, Adrian Bauer, Marco Ranucci, Erich Gygax, Jan Schaarschmidt, Yves Fromes, Alois Philipp, and Balthasar Eberle. 2016. 'Use of minimal invasive extracorporeal circulation in cardiac surgery: principles, definitions and potential benefits. A position paper from the Minimal invasive Extra-Corporeal Technologies international Society (MiECTiS)', *Interactive cardiovascular and thoracic surgery*: ivv380.
- Andersen, Lars W, Leif Baek, Bjarne S Thomsen, and Jens P Rasmussen. 1989. 'Effect of methylprednisolone on endotoxemia and complement activation during cardiac surgery', *Journal of cardiothoracic anesthesia*, 3: 544-49.
- Angus, Derek C, Amber E Barnato, Walter T Linde-Zwirble, Lisa A Weissfeld, R Scott Watson, Tim Rickert, Gordon D Rubenfeld, and Robert Wood Johnson Foundation ICU End-Of-Life Peer Group. 2004. 'Use of intensive care at the end of life in the United States: An epidemiologic study\*', *Critical care medicine*, 32: 638-43.
- Apostolakis, Efstratios E, Efstratios N Koletsis, Nikolaos G Baikoussis, Stavros N Siminelakis, and Georgios S Papadopoulos. 2010. 'Strategies to prevent intraoperative lung injury during cardiopulmonary bypass', *Journal of cardiothoracic surgery*, 5: 1.
- Ashbaugh, David G, D Boyd Bigelow, Thomas L Petty, and Bernard E Levine. 1967. 'Acute respiratory distress in adults', *The Lancet*, 290: 319-23.
- Asimakopoulos, George. 1999. 'Mechanisms of the systemic inflammatory response', *Perfusion*, 14: 269-77.

- Asimakopoulos. 2001. 'Systemic inflammation and cardiac surgery:an update', *Perfusion*, 16: 353-60.
- Asimakopoulos. 2003. 'A review of antiinflammatory strategies in cardiac surgery', *Perfusion*, 18: 7-12.
- Asimakopoulos George, Peter LC Smith, Chandana P Ratnatunga, and Kenneth M Taylor. 1999. 'Lung injury and acute respiratory distress syndrome after cardiopulmonary bypass', *The annals of thoracic surgery*, 68: 1107-15.
- Asimakopoulos George,Richard Thompson, Sussan Nourshargh, Elaine A Lidington, Justin C Mason, Chandana P Ratnatunga, Dorian O Haskard, Kenneth M Taylor, and R Clive Landis. 2000. 'An anti-inflammatory property of aprotinin detected at the level of leukocyte extravasation', *The Journal of thoracic and cardiovascular surgery*, 120: 361-69.
- Assadollahi, Saied, Christiane Reiningr, Roland Palkovits, Peter Pointl, and Thomas Schalkhammer. 2009. 'From lateral flow devices to a novel nano-color microfluidic assay', *Sensors*, 9: 6084-100.
- Baikoussis, Nikolaos G, Nikolaos A Papakonstantinou, and Efstratios Apostolakis. 2014. 'The “benefits” of the mini-extracorporeal circulation in the minimal invasive cardiac surgery era', *Journal of cardiology*, 63: 391-96.
- Baker,Matthew J, Júlio Trevisan, Paul Bassan, Rohit Bhargava, Holly J Butler, Konrad M Dorling, Peter R Fielden, Simon W Fogarty, Nigel J Fullwood, and Kelly A Heys. 2014. 'Using Fourier transform IR spectroscopy to analyze biological materials', *Nature protocols*, 9: 1771-91.

- Banks, Jim. 2012. 'Adding value in additive manufacturing: researchers in the United Kingdom and Europe look to 3D printing for customization', *IEEE pulse*, 4: 22-26.
- Banner, KH, E Moriggi, B Ros, G Schioppacassi, C Semeraro, and CP Page. 1996. 'The effect of selective phosphodiesterase 3 and 4 isoenzyme inhibitors and established anti-asthma drugs on inflammatory cell activation', *British journal of pharmacology*, 119: 1255-61.
- Barnes, Peter J. 2011. 'Glucocorticosteroids: current and future directions', *British journal of pharmacology*, 163: 29-43.
- Barta, E, I Pechan, V Cornak, O Luknarova, V Rendekova, and P Verchovodko. 1990. 'Protective effect of alpha-tocopherol and L-ascorbic acid against the ischemic-reperfusion injury in patients during open-heart surgery', *Bratislavske lekarske listy*, 92: 174-83.
- Baufreton, Christophe, Madeleine Moczar, Liliane Intrator, Piet GM Jansen, Henk te Velthuis, Paul Le Besnerais, Jean Pierre Farcet, Charles RH Wildevuur, and Daniel Y Loisanche. 1998. 'Inflammatory response to cardiopulmonary bypass using two different types of heparin-coated extracorporeal circuits', *Perfusion*, 13: 419-27.
- Beadling, Carol, and Mark K Slifka. 2006. 'Regulation of innate and adaptive immune responses by the related cytokines IL-12, IL-23, and IL-27', *Archivum immunologiae et therapiae experimentalis*, 54: 15-24.
- Belanger, Michael, Carin Wittnich, Shona Torrance, and Steve Juhasz. 2002. 'Model of normothermic long-term cardiopulmonary bypass in swine weighing more than eighty kilograms', *Comparative medicine*, 52: 117-21.

- Bellisola, Giuseppe, and Claudio Sorio. 2012. 'Infrared spectroscopy and microscopy in cancer research and diagnosis', *Am J Cancer Res*, 2: 1-21.
- Benedetto, Umberto, Remo Luciani, Massimo Goracci, Fabio Capuano, Simone Refice, Emiliano Angeloni, Antonino Roscitano, and Riccardo Sinatra. 2009. 'Miniaturized cardiopulmonary bypass and acute kidney injury in coronary artery bypass graft surgery', *The annals of thoracic surgery*, 88: 529-35.
- Benetti, Federico J, G Naselli, M Wood, and L Geffner. 1991. 'Direct myocardial revascularization without extracorporeal circulation. Experience in 700 patients', *Chest Journal*, 100: 312-16.
- Bennett, SC, EW Beal, CA Dumond, T Preston, J Ralston, A Pope-Harman, S Black, D Hayes Jr, and BA Whitson. 2015. 'Mechanical circulatory support in lung transplantation: Cardiopulmonary bypass, extracorporeal life support, and ex-vivo lung perfusion', *World J Respirol*, 5: 78-92.
- Bergstrom, J, O Heimbürger, B Lindholm, and AR Qureshi. 1995. 'C-reactive protein as predictor for serum albumin and mortality in hemodialysis', *J Am Soc Nephrol*, 6: 573-7.
- Biglioli, Paolo, Aldo Cannata, Francesco Alamanni, Moreno Naliato, Massimo Porqueddu, Marco Zanobini, Elena Tremoli, and Alessandro Parolari. 2003. 'Biological effects of off-pump vs. on-pump coronary artery surgery: focus on inflammation, hemostasis and oxidative stress', *European journal of cardio-thoracic surgery*, 24: 260-69.

- Birdi, I, M Caputo, M Underwood, AJ Bryan, and GD Angelini. 1999. 'The effects of cardiopulmonary bypass temperature on inflammatory response following cardiopulmonary bypass', *European journal of cardio-thoracic surgery*, 16: 540-45.
- Bog'a, Mehmet, Fatih Islamog'lu, Ismail Badak, Mustafa Çikirikçiog'lu, Tamer Bakalim, Tahir Yag'di, Suat Büket, and Ahmet Hamulu. 2000. 'The effects of modified hemofiltration on inflammatory mediators and cardiac performance in coronary artery bypass grafting', *Perfusion*, 15: 143-50.
- Boldt, Joachim, Christian Brosch, Andreas Lehmann, Guenter Haisch, Johannes Lang, and Frank Isgro. 2011. 'Prophylactic use of pentoxifylline on inflammation in elderly cardiac surgery patients (Retraction of vol 71, pg 1524, 2001)', *Annals of thoracic surgery*, 92: 411-11.
- Bone, Roger C. 1996. 'Toward a theory regarding the pathogenesis of the systemic inflammatory response syndrome: what we do and do not know about cytokine regulation', *Critical care medicine*, 24: 163-72.
- Boodram, Shalini, and Ed Evans. 2008. 'Use of leukocyte-depleting filters during cardiac surgery with cardiopulmonary bypass: a review', *The Journal of extra-corporeal technology*, 40: 27-42.
- Boonstra, PIET W, and Y JOHN Gu. 2004. 'Priming fluids for cardiopulmonary bypass', *Techniques in extracorporeal circulation*, 4: 99-107.
- Bown, MJ, ML Nicholson, PRF Bell, and RD Sayers. 2001. 'Cytokines and inflammatory pathways in the pathogenesis of multiple organ failure following abdominal aortic aneurysm repair', *European journal of vascular and endovascular surgery*, 22: 485-95.

- Bradley, JR. 2008. 'TNF-mediated inflammatory disease', *The Journal of pathology*, 214: 149-60.
- Brian, Ben F. 2008. 'The Engineering of Cardiopulmonary Bypass.' in, *On Bypass* (Springer).
- Brix-Christensen, V, E Tønnesen, IJ Sørensen, TV Bilfinger, RG Sanchez, and GB Stefano. 1998. 'Effects of anaesthesia based on high versus low doses of opioids on the cytokine and acute-phase protein responses in patients undergoing cardiac surgery', *Acta anaesthesiologica scandinavica*, 42: 63-70.
- Brix-Christensen, Vibeke. 2001. 'The systemic inflammatory response after cardiac surgery with cardiopulmonary bypass in children', *Acta anaesthesiologica scandinavica*, 45: 671-79.
- Brøchner, Anne Craveiro, and Palle Toft. 2009. 'Pathophysiology of the systemic inflammatory response after major accidental trauma', *Scandinavian journal of trauma, resuscitation and emergency medicine*, 17: 1-10.
- Brombacher, Frank, Robert A Kastelein, and Gottfried Alber. 2003. 'Novel IL-12 family members shed light on the orchestration of Th1 responses', *Trends in immunology*, 24: 207-12.
- Brown, Jeremiah R, Andrew WJ Toler, Robert S Kramer, and R Clive Landis. 2009. 'Anti-inflammatory effect of aprotinin: a meta-analysis', *The Journal of extra-corporeal technology*, 41: 79.
- Brun-Buisson, Christian, Françoise Roudot-Thoraval, Emmanuelle Girou, Catherine Grenier-Sennelier, and Isabelle Durand-Zaleski. 2003. 'The costs of septic syndromes in the intensive care unit and influence of hospital-acquired sepsis', *Intensive care medicine*, 29: 1464-71.

- Buffolo, Enio, Jose Carlos Silva De Andrade, Joao Nelson Rodrigues Branco, Carlos Alberto Teles, Luciano Figueiredo Aguiar, and Walter José Gomes. 1996. 'Coronary artery bypass grafting without cardiopulmonary bypass', *The annals of thoracic surgery*, 61: 63-66.
- Cavarocchi, Nicholas C, Michael D England, John F O'Brien, Eduardo Solis, Pierantonio Russo, Hartzell V Schaff, Thomas A Orszulak, James R Pluth, and Michael P Kaye. 1986. 'Superoxide generation during cardiopulmonary bypass: is there a role for vitamin E?', *Journal of Surgical Research*, 40: 519-27.
- Cave, AC, A Manche, NW Derias, and DJ Hearse. 1993. 'Thromboxane A2 mediates pulmonary hypertension after cardiopulmonary bypass in the rabbit', *The Journal of thoracic and cardiovascular surgery*, 106: 959-67.
- Cavone, L, L Calosi, L Cinci, F Moroni, and A Chiarugi. 2012. 'Topical mannitol reduces inflammatory edema in a rat model of arthritis', *Pharmacology*, 89: 18-21.
- Cesarman-Maus, Gabriela, and Katherine A Hajjar. 2005. 'Molecular mechanisms of fibrinolysis', *British journal of haematology*, 129: 307-21.
- Chalise, J, S Narendra, B Paudyal, and Mattias Magnusson. 2013. 'Interferon alpha inhibits antigen-specific production of proinflammatory cytokines and enhances antigen-specific transforming growth factor beta production in antigen-induced arthritis', *Arthritis research & therapy*, 15: R143.



- Chang, Yuan-Jhe, Keh-Liang Lin, and Yan-Zin Chang. 2013. 'Determination of Di-(2-ethylhexyl) phthalate (DEHP) metabolites in human hair using liquid chromatography–tandem mass spectrometry', *Clinica Chimica Acta*, 420: 155-59.
- Charchafliéh, Jean, Jiandong Wei, Georges Labaze, Yunfang Joan Hou, Benjamin Babarsh, Helen Stutz, Haekyung Lee, Samrat Worah, and Ming Zhang. 2012. 'The role of complement system in septic shock', *Clinical and Developmental Immunology*, 2012.
- Charette, Kevin A, Ryan R Davies, Jonathan M Chen, Jan M Quaegebeur, and Ralph S Mosca. 2008. 'Pediatric perfusion techniques for complex congenital cardiac surgery.' in, *On Bypass* (Springer).
- Chehimi, Jihed, and Giorgio Trinchieri. 1994. 'Interleukin-12: a bridge between innate resistance and adaptive immunity with a role in infection and acquired immunodeficiency', *Journal of clinical immunology*, 14: 149-61.
- Chen, Ying-Fu, Wen-Chan Tsai, Ching-Cheng Lin, Li-Yu Tsai, Chee-Siong Lee, Chiung-Hui Huang, Pi-Chen Pan, and Man-Lin Chen. 2004. 'Effect of leukocyte depletion on endothelial cell activation and transendothelial migration of leukocytes during cardiopulmonary bypass', *The annals of thoracic surgery*, 78: 634-42.
- Cohn, Lawrence H. 2003. 'Fifty years of open-heart surgery', *Circulation*, 107: 2168-70.

- Cook, David J, Jacqueline A Proper, Thomas A Orszulak, Richard C Daly, and William C Oliver. 1997. 'Effect of pump flow rate on cerebral blood flow during hypothermic cardiopulmonary bypass in adults', *Journal of Cardiothoracic and Vascular Anesthesia*, 11: 415-19.
- Cooley, Denton A, Arthur C Beall, and Pierre Grondin. 1962. 'Open-heart operations with disposable oxygenators, 5 per cent dextrose prime, and normothermia', *Surgery*, 52: 713-19.
- Coutinho, Agnes E, and Karen E Chapman. 2011. 'The anti-inflammatory and immunosuppressive effects of glucocorticoids, recent developments and mechanistic insights', *Molecular and cellular endocrinology*, 335: 2-13.
- Cruickshank, AM, WD Fraser, HJG Burns, Jozef Van Damme, and A Shenkin. 1990. 'Response of serum interleukin-6 in patients undergoing elective surgery of varying severity', *Clinical Science*, 79: 161-65.
- Curtis, Nathan, Hunaid A Vohra, and Sunil K Ohri. 2010. 'Mini extracorporeal circuit cardiopulmonary bypass system: a review', *Perfusion*, 25: 115-24.
- Davis, Wellington J, Mikhail Vaynblat, Mario Chiavarelli, Prashant Shah, Rafael Fazylov, Zvi Zisbrod, and Joseph N Cunningham. 2004. 'Open heart surgery in patients 85 years and older', *Journal of cardiac surgery*, 19: 7-11.
- Day, Jonathan RS, Afzal N Chaudhry, Ian Hunt, and Kenneth M Taylor. 2002. 'Heparin-induced hyperkalemia after cardiac surgery', *The annals of thoracic surgery*, 74: 1698-700.
- Day, Jonathan RS, RC Landis, and KM Taylor. 2004. 'Heparin is much more than just an anticoagulant', *Journal of Cardiothoracic and Vascular Anesthesia*, 18: 93-100.

- Day, JRS, and KM Taylor. 2005. 'The systemic inflammatory response syndrome and cardiopulmonary bypass', *International Journal of Surgery*, 3: 129-40.
- Day, Richard M, Marcus Harbord, Alastair Forbes, and Anthony W Segal. 2001. 'Cantharidin blisters: a technique for investigating leukocyte trafficking and cytokine production at sites of inflammation in humans', *Journal of immunological methods*, 257: 213-20.
- Den Hengst, Willem A, Jan F Gielis, Judy Y Lin, Paul E Van Schil, Leon J De Windt, and An L Moens. 2010. 'Lung ischemia-reperfusion injury: a molecular and clinical view on a complex pathophysiological process', *American Journal of Physiology-Heart and Circulatory Physiology*, 299: H1283-H99.
- Di Salvo, C, LL Louca, K Pattichis, J Hooper, and RK Walesby. 1996. 'Does activated neutrophil depletion on bypass by leukocyte filtration reduce myocardial damage? A preliminary report', *The Journal of cardiovascular surgery*, 37: 93-100.
- Diem, Max, Peter R Griffiths, and John M Chalmers. 2008. *Vibrational spectroscopy for medical diagnosis* (Wiley Chichester).
- Dinareello, Charles A. 1999. 'Cytokines as endogenous pyrogens', *Journal of Infectious Diseases*, 179: S294-S304.
- Dingchao, H, Q Zhiduan, H Liye, and F Xiaodong. 1994. 'The protective effects of high-dose ascorbic acid on myocardium against reperfusion injury during and after cardiopulmonary bypass', *The Thoracic and cardiovascular surgeon*, 42: 276-78.

- Dinh, Phong Huy Duc, Francis Corraza, Kristel Mestdagh, Zaina Kassengera, Virginie Doyen, and Olivier Michel. 2011. 'Validation of the cantharidin-induced skin blister as an in vivo model of inflammation', *British journal of clinical pharmacology*, 72: 912-20.
- Donati, A, D Battisti, G Conti, S Caporelli, E Adrario, P Pelaia, A Recchioni, P Paoletti, and P Pietropaoli. 1998. 'Predictive value of interleukin 6 (IL-6), interleukin 8 (IL-8) and gastric intramucosal pH (pH-i) in major abdominal surgery', *Intensive care medicine*, 24: 329-35.
- Doughty, Lesley A, Sandra S Kaplan, and Joseph A Carcillo. 1996. 'Inflammatory cytokine and nitric oxide responses in pediatric sepsis and organ failure', *Critical care medicine*, 24: 1137-43.
- Drover, David R, Gregory B Hammer, Jeffrey S Barrett, Carol A Cohane, Tammy Reece, Anne Zajicek, and Scott R Schulman. 2015. 'Evaluation of sodium nitroprusside for controlled hypotension in children during surgery', *Frontiers in pharmacology*, 6.
- Du Clos, Terry W. 2000. 'Function of C-reactive protein', *Annals of medicine*, 32: 274-78.
- Dulos, John, Peter Vijn, Cindy van Doorn, Claudia L Hofstra, Desiree Veening-Griffioen, Jan de Graaf, Fred A Dijcks, and Annemieke MH Boots. 2010. 'Research article Suppression of the inflammatory response in experimental arthritis is mediated via estrogen receptor  $\alpha$  but not estrogen receptor  $\beta$ '.
- Durandy, Yves D. 2015. 'Is there a rationale for short cardioplegia re-dosing intervals?', *World journal of cardiology*, 7: 658.

- Dybdahl, Brit, Alexander Wahba, Egil Lien, Trude H Flo, Anders Waage, Nilofer Qureshi, Olav FM Sellevold, Terje Espevik, and Anders Sundan. 2002. 'Inflammatory response after open heart surgery release of heat-shock protein 70 and signaling through Toll-like receptor-4', *Circulation*, 105: 685-90.
- Ebadi, Mohammad Ali Sheikhi Ahmad, Alireza Shahriary, Hannaneh Davoodzadeh, and Hossein Rahmani. 2015. 'Cardiac Surgery Anesthesia and Systemic Inflammatory Response', *International Journal of Bioassays*, 4: 3648-55.
- Edmunds, L Henry. 2002. 'The evolution of cardiopulmonary bypass: lessons to be learned', *Perfusion*, 17: 243-51.
- Edrees, WK, LL Lau, IS Young, MG Smye, KR Gardiner, B Lee, RJ Hannon, and CV Soong. 2003. 'The effect of lower limb ischaemia-reperfusion on intestinal permeability and the systemic inflammatory response', *European journal of vascular and endovascular surgery*, 25: 330-35.
- Eguchi, Takashi, Kazuo Yoshida, Kazutoshi Hamanaka, and Makoto Kurai. 2010. 'Colchicine as an effective treatment for postpericardiotomy syndrome following a lung lobectomy', *Interactive cardiovascular and thoracic surgery*, 11: 869-71.
- Elmore, Susan. 2007. 'Apoptosis: a review of programmed cell death', *Toxicologic pathology*, 35: 495-516.
- Engelman, RM, MR Prasad, JA Rousou, RH Breyer, M Bagchi, and DK Das. 1989. 'Steroid-induced myocardial preservation is associated with decreased cell membrane microviscosity', *Circulation*, 80: III36-43.

- Englberger, Lars, Beat Kipfer, Pascal A Berdat, Urs E Nydegger, and Thierry P Carrel. 2002. 'Aprotinin in coronary operation with cardiopulmonary bypass: does "low-dose" aprotinin inhibit the inflammatory response?', *The annals of thoracic surgery*, 73: 1897-904.
- Ernofsson, Mats, Stefan Thelin, and Agneta Siegbahn. 1997. 'Monocyte tissue factor expression, cell activation, and thrombin formation during cardiopulmonary bypass: a clinical study', *The Journal of thoracic and cardiovascular surgery*, 113: 576-84.
- Etzioni, Amos. 1996. 'Adhesion molecules-their role in health and disease', *Pediatric research*, 39: 191-98.
- 'European System for Cardiac Operative Risk Evaluation'.<http://www.euroscore.org/>.
- Fahim, Maged Ramses, Sherine Maher Halim, and Iman Kamel. 2003. 'Tumor necrosis factor alpha in patients with acute myocardial infarction', *The Egyptian journal of immunology/Egyptian Association of Immunologists*, 11: 31-37.
- Fairchild, Karen D, Rose M Viscardi, Lisa Hester, Ishwar S Singh, and Jeffrey D Hasday. 2000. 'Effects of hypothermia and hyperthermia on cytokine production by cultured human mononuclear phagocytes from adults and newborns', *Journal of Interferon & Cytokine Research*, 20: 1049-55.
- Fanelli, Vito, Aikaterini Vlachou, Shirin Ghannadian, Umberto Simonetti, Arthur S Slutsky, and Haibo Zhang. 2013. 'Acute respiratory distress syndrome: new definition, current and future therapeutic options', *Journal of thoracic disease*, 5: 326-34.

- Farhane, Zeineb, F Bonnier, A Casey, A Maguire, L O'Neill, and HJ Byrne. 2015. 'Cellular discrimination using in vitro Raman micro spectroscopy: the role of the nucleolus', *Analyst*, 140: 5908-19.
- Feindt, Peter, Jens Litmathe, Udo Boeken, and Emmeran Gams. 2005. 'Anticoagulation during extracorporeal circulation under conditions of an ongoing systemic inflammatory response syndrome: effects of heparin', *Perfusion*, 20: 11-15.
- Ferguson, Kevin L, Paul Taheri, Jorge Rodriguez, Vijay Tonapi, Anthony Cardello, and Ron Dechert. 1997. 'Tumor necrosis factor activity increases in the early response to trauma', *Academic emergency medicine*, 4: 1035-40.
- Finn, A, S Naik, N Klein, RJ Levinsky, S Strobel, and M Elliott. 1993. 'Interleukin-8 release and neutrophil degranulation after pediatric cardiopulmonary bypass', *The Journal of thoracic and cardiovascular surgery*, 105: 234-41.
- Fisher, AR, P Jones, P Barlow, S Kennington, S Saville, J Farrimond, and M Yacoub. 1998. 'The influence of mannitol on renal function during and after open-heart surgery', *Perfusion*, 13: 181-86.
- Follin, Per. 1999. 'Skin chamber technique for study of in vivo exudated human neutrophils', *Journal of immunological methods*, 232: 55-65.
- Franco, Kenneth L, and Edward D Verrier. 2003. *Advanced therapy in cardiac surgery* (PMPH-USA).
- Frank, Michael M. 1987. 'Complement in the pathophysiology of human disease', *New England Journal of Medicine*, 316: 1525-30.

- Fromes, Yves, Didier Gaillard, Olivier Ponzio, Maryline Chauffert, Marie-Françoise Gerhardt, Philippe Deleuze, and Olivier M Bical. 2002. 'Reduction of the inflammatory response following coronary bypass grafting with total minimal extracorporeal circulation', *European journal of cardio-thoracic surgery*, 22: 527-33.
- Frumento, Robert J, and Elliott Bennett-Guerrero. 2008. 'Prime solutions for extracorporeal circulation.' in, *On Bypass* (Springer).
- Galletti, Pierre M, and Christina T Mora. 1995. 'Cardiopulmonary bypass: the historical foundation, the future promise.' in, *Cardiopulmonary Bypass* (Springer).
- Gammie, James S, Yue Zhao, Eric D Peterson, Sean M O'Brien, J Scott Rankin, and Bartley P Griffith. 2010. 'Less-invasive mitral valve operations: trends and outcomes from the Society of Thoracic Surgeons Adult Cardiac Surgery Database', *The annals of thoracic surgery*, 90: 1401-10. e1.
- Gastl, Guenther A, John S Abrams, David M Nanus, Rianne Oosterkamp, John Silver, Frank Liu, Michael Chen, Anthony P Albino, and Neil H Bander. 1993. 'Interleukin-10 production by human carcinoma cell lines and its relationship to interleukin-6 expression', *International journal of cancer*, 55: 96-101.
- Ghaffar, Abdul. 2006. 'Immunology-Chapter Seventeen: Hypersensitivity Reactions', *Microbiology and Immunology On-Line Textbook*.



- Giannoudis, Peter V, Paul John Harwood, Peter Loughenbury, Martijn Van Griensven, Christian Krettek, and Hans-Christoph Pape. 2008. 'Correlation between IL-6 levels and the systemic inflammatory response score: can an IL-6 cutoff predict a SIRS state?', *Journal of Trauma and Acute Care Surgery*, 65: 646-52.
- Gibbon Jr, JH, BJ Miller, AR Dobell, HC Engell, and GB Voigt. 1954. 'The closure of interventricular septal defects in dogs during open cardiectomy with the maintenance of the cardiorespiratory functions by a pump-oxygenator', *The Journal of thoracic surgery*, 28: 235.
- Giomarelli, P, A Naldini, B Biagioli, and E Borrelli. 2000. 'Heparin coating of extracorporeal circuits inhibits cytokine release from mononuclear cells during cardiac operations', *The International journal of artificial organs*, 23: 250-55.
- Giustarini, Daniela, Isabella Dalle-Donne, Dimitrios Tsikas, and Ranieri Rossi. 2009. 'Oxidative stress and human diseases: origin, link, measurement, mechanisms, and biomarkers', *Critical reviews in clinical laboratory sciences*, 46: 241-81.
- Gourlay,T. 2001. 'Biomaterial development for cardiopulmonary bypass', *Perfusion*, 16: 381-90.
- Gourlay, Terence. 2006. *The investigation of a screening test for blood /biomaterial activation in patients undergoing Cardiopulmonary bypass.*

- Gourlay Terence, Ioannis Samartzis, Demetrios Stefanou, and Kenneth Taylor. 2003. 'Inflammatory Response of Rat and Human Neutrophils Exposed to Di-(2-ethyl-hexyl)-phthalate-Plasticized Polyvinyl Chloride', *Artificial organs*, 27: 256-60.
- Gourlay Terence, Laurie Shedden, David Horne, and Demetrios M Stefanou. 2010. 'Simple surface sulfonation retards plasticiser migration and impacts upon blood/material contact activation processes', *Perfusion*.
- Gourlay Terence, Demetrios Constantine Stefanou, George Asimakopoulos, and Kenneth McDonald Taylor. 2001. 'The Effect of Circuit Surface Area on CD11b (mac-1) Expression in a Rat Recirculation Model', *Artificial organs*, 25: 475-79.
- Groom, Robert C, Shane Froebe, Janine Martin, Michael J Manfra, John E Cormack, Catherine Morse, Andreas H Taenzer, and Reed D Quinn. 2005. 'Update on pediatric perfusion practice in North America: 2005 survey', *The Journal of extra-corporeal technology*, 37: 343-50.
- Gu, Y John, and Piet W Boonstra. 2006. 'Selection of priming solutions for cardiopulmonary bypass in adults', *Multimedia Manual of Cardio-Thoracic Surgery*, 2006: mmcts. 2005.001198.
- Gu, Y John, AJ De Vries, Paulien Vos, Piet W Boonstra, and Willem van Oeveren. 1999. 'Leukocyte depletion during cardiac operation: a new approach through the venous bypass circuit', *The annals of thoracic surgery*, 67: 604-09.

- Gu, Y John, Massimo A Mariani, Piet W Boonstra, Jan G Grandjean, and Willem van Oeveren. 1999. 'Complement activation in coronary artery bypass grafting patients without cardiopulmonary bypass: the role of tissue injury by surgical incision', *Chest Journal*, 116: 892-98.
- Gu, YJ, PW Boonstra, and W van Oeveren. 1996. 'Leukocyte depletion results in improved lung function and reduced inflammatory response after cardiac surgery', *The Journal of thoracic and cardiovascular surgery*, 112: 494-500.
- Gunaydin, Serdar, Halil Ibrahim Ucar, Tanzer Serter, Kevin McCusker, Gokhan Ozcelik, Nevriye Salman, and Ali Cem Yorgancioglu. 2010. 'Hyaluronan based heparin free coated open and closed extracorporeal circuits for high risk coronary revascularization', *The Journal of extra-corporeal technology*, 42: 286-92.
- Gunaydin, Serdar, Tamer Sari, Kevin McCusker, Uwe Schonrock, and Yaman Zorlutuna. 2009. 'Clinical evaluation of minimized extracorporeal circulation in high-risk coronary revascularization: impact on air handling, inflammation, hemodilution and myocardial function', *Perfusion*, 24: 153-62.
- Gurevitch, J., I. Frolkis, Y. Yuhas, B. Lifschitz-Mercer, E. Berger, Y. Paz, M. Matsa, A. Kramer, and R. Mohr. 1997. 'Anti-Tumor Necrosis Factor-Alpha Improves Myocardial Recovery After Ischemia and Reperfusion', *Journal of the American College of Cardiology*, 30: 1554-61.
- Güvener, Murat, Oktay Korun, and Orhan Saim Demirtürk. 2015. 'Risk factors for systemic inflammatory response after congenital cardiac surgery', *Journal of cardiac surgery*, 30: 92-96.

- Haines, Nikkole, Shigang Wang, Akif Ündar, Tijen Alkan, and Atif Akcevin. 2009. 'Clinical outcomes of pulsatile and non-pulsatile mode of perfusion', *In Vivo*, 8: 10.
- Hall, RT, M Stafford Smith, and G Rocker. 1997. 'The Systemic Inflammatory Responses to Cardiopulmonary Bypass: Pathophysiological, Therapeutic, and Pharmacological Considerations', *anesthesia and analgesia-cleveland* -, 85: 766-82.
- Hamza, Therwa, John B Barnett, and Bingyun Li. 2010. 'Interleukin 12 a key immunoregulatory cytokine in infection applications', *International journal of molecular sciences*, 11: 789-806.
- Hanavadi, Satheesha, Tracey A Martin, Gareth Watkins, Robert E Mansel, and Wen G Jiang. 2006. 'Expression of interleukin 11 and its receptor and their prognostic value in human breast cancer', *Annals of surgical oncology*, 13: 802-08.
- Hauser, GJ, J Ben-Ari, MP Colvin, HJ Dalton, JH Hertzog, M Bearb, RA Hopkins, and SM Walker. 1998. 'Interleukin-6 levels in serum and lung lavage fluid of children undergoing open heart surgery correlate with postoperative morbidity', *Intensive care medicine*, 24: 481-86.
- Hawkins, Justin L, Gerard J Myers, Jean-Francois Légaré, and Wilfred Swyer. 2010. 'Arterial Filter Bypass Loop: What Occurs in this Area during Cardiopulmonary Bypass and Are There Potential Patient Implications', *The Journal of extra-corporeal technology*, 42: 71.

- Hayashida, Nobuhiko, Hiroshi Tomoeda, Takeshi Oda, Eiki Tayama, Shingo Chihara, Takemi Kawara, and Shigeaki Aoyagi. 1999. 'Inhibitory effect of milrinone on cytokine production after cardiopulmonary bypass', *The annals of thoracic surgery*, 68: 1661-67.
- Heindl, Bernhard, and Bernhard F Becker. 2001. 'Aspirin, but not the more selective cyclooxygenase (COX)-2 inhibitors meloxicam and SC 58125, aggravates postischaemic cardiac dysfunction, independent of COX function', *Naunyn-Schmiedeberg's archives of pharmacology*, 363: 233-40.
- Hickey, Edward, Tara Karamlou, Jamie You, and Ross M Ungerleider. 2006. 'Effects of circuit miniaturization in reducing inflammatory response to infant cardiopulmonary bypass by elimination of allogeneic blood products', *The annals of thoracic surgery*, 81: S2367-S72.
- Hill, Gary E, Anselmo Alonso, John R Spurzem, Alfred H Stammers, and Richard A Robbins. 1995. 'Aprotinin and methylprednisolone equally blunt cardiopulmonary bypass-induced inflammation in humans', *The Journal of thoracic and cardiovascular surgery*, 110: 1658-62.
- Hill, Gary E, Charles W Whitten, and Dennis F Landers. 1997. 'The influence of cardiopulmonary bypass on cytokines and cell-cell communication', *Journal of Cardiothoracic and Vascular Anesthesia*, 11: 367-75.
- Horiuchi, M, S Yamano, H Inoue, J Ishii, Y Nagata, H Adachi, M Ono, JN Renard, F Mizuno, and Y Hayashi. 1999. 'Possible involvement of IL-12 expression by Epstein-Barr virus in Sjögren syndrome', *Journal of clinical pathology*, 52: 833-37.

- Hosmer Jr, David W, and Stanley Lemeshow. 2004. *Applied logistic regression* (John Wiley & Sons).
- Immer, Franz F, Andreas Ackermann, Erich Gygax, Mario Stalder, Lars Englberger, Friedrich S Eckstein, Hendrik T Tevæarai, Juerg Schmidli, and Thierry P Carrel. 2007. 'Minimal extracorporeal circulation is a promising technique for coronary artery bypass grafting', *The annals of thoracic surgery*, 84: 1515-21.
- Iribarne, Alexander, Rachel Easterwood, Edward YH Chan, Jonathan Yang, Lori Soni, Mark J Russo, Craig R Smith, and Michael Argenziano. 2011. 'The golden age of minimally invasive cardiothoracic surgery: current and future perspectives', *Future cardiology*, 7: 333-46.
- Ivey, Claire L, Frances M Williams, Paul D Collins, Peter J Jose, and Timothy J Williams. 1995. 'Neutrophil chemoattractants generated in two phases during reperfusion of ischemic myocardium in the rabbit. Evidence for a role for C5a and interleukin-8', *Journal of Clinical Investigation*, 95: 2720.
- Jaffer,U. 2010. 'Cytokines in the systemic inflammatory response syndrome: a review ', *HSR*, 2: 161-75.
- Jansen, NJ, W Van Oeveren, M Van Vliet, CP Stoutenbeek, L Eysman, and CR Wildevuur. 1990. 'The role of different types of corticosteroids on the inflammatory mediators in cardiopulmonary bypass', *European journal of cardio-thoracic surgery: official journal of the European Association for Cardio-thoracic Surgery*, 5: 211-17.

- Jansen, Piet GM, Christophe Baufreton, Paul Le Besnerais, Daniel Y Loisanca, and Charles RH Wildevuur. 1996. 'Heparin-coated circuits and aprotinin prime for coronary artery bypass grafting', *The annals of thoracic surgery*, 61: 1363-66.
- Jegger, D, X Mueller, G Mucciolo, A Mucciolo, Y Boone, I Seigneul, J Horisberger, and LK Von Segesser. 2002. 'A new expandable cannula to increase venous return during peripheral access cardiopulmonary bypass surgery', *The International journal of artificial organs*, 25: 136-40.
- Jegger, David, Antonio F Corno, Antonio Mucciolo, Giuseppe Mucciolo, Yves Boone, Judith Horisberger, Isabelle Seigneul, Mirka Jachertz, and Ludwig K Von Segesser. 2003. 'A prototype paediatric venous cannula with shape change in situ', *Perfusion*, 18: 61-65.
- Jin, Wei, and Chen Dong. 2013. 'IL-17 cytokines in immunity and inflammation', *Emerging microbes & infections*, 2: e60.
- Jofré, Rosa, Patrocinio Rodriguez-Benitez, Juan M López-Gómez, and Rafael Pérez-Garcia. 2006. 'Inflammatory syndrome in patients on hemodialysis', *Journal of the American Society of Nephrology*, 17: S274-S80.
- John Bulter, Graeme M Rucker, Stephen Westaby. 1993. 'Inflammatory responses to cardiopulmonary bypass', *Annals of thoracic surgery*, 55: 552-59.
- John W Mulholland, Ann T Clements. 2012. 'Cardiopulmonary bypass ', *Surgery*, 30: 19-21.

- Johnson, David, Dorothy Thomson, Taras Mycyk, Brian Burbridge, and Irvin Mayers. 1995. 'Depletion of neutrophils by filter during aortocoronary bypass surgery transiently improves postoperative cardiorespiratory status', *Chest Journal*, 107: 1253-59.
- Jorens, Philippe G, Jo Van Damme, Wilfried De Backer, Leo Bossaert, Rafael F De Jongh, Arnold G Herman, and Marc Rampart. 1992. 'Interleukin 8 (IL-8) in the bronchoalveolar lavage fluid from patients with the adult respiratory distress syndrome (ARDS) and patients at risk for ARDS', *Cytokine*, 4: 592-97.
- Journois, Didier, Dominique Israel-Biet, Philippe Pouard, Benedicte Rolland, William Silvester, Pascal Vouhe, and Denis Safran. 1996. 'High-volume, zero-balanced hemofiltration to reduce delayed inflammatory response to cardiopulmonary bypass in children', *The Journal of the American Society of Anesthesiologists*, 85: 965-76.
- Jung, Unsu, and Klaus Ley. 1999. 'Mice lacking two or all three selectins demonstrate overlapping and distinct functions for each selectin', *The Journal of Immunology*, 162: 6755-62.
- Kamiya, Hiroyuki, Theo Kofidis, Axel Haverich, and Uwe Klima. 2006. 'Preliminary experience with the mini-extracorporeal circulation system (Medtronic resting heart system)', *Interactive cardiovascular and thoracic surgery*, 5: 680-82.



- Kan, Hong, Zirong Xie, and Mitchell S Finkel. 1999. 'TNF- $\alpha$  enhances cardiac myocyte NO production through MAP kinase-mediated NF- $\kappa$ B activation', *American Journal of Physiology-Heart and Circulatory Physiology*, 277: H1641-H46.
- Kapoor, Mukul Chandra, and TR Ramachandran. 2004. 'Inflammatory response to cardiac surgery and strategies to overcome it', *Annals of cardiac anaesthesia*, 7: 113-28.
- Kaukonen, Kirsi-Maija, Michael Bailey, David Pilcher, D Jamie Cooper, and Rinaldo Bellomo. 2015. 'Systemic inflammatory response syndrome criteria in defining severe sepsis', *New England Journal of Medicine*, 372: 1629-38.
- Kawamura, Takae, Katsuya Inada, Hiroshi Okada, Kazutoshi Okada, and Reiji Wakusawa. 1995. 'Methylprednisolone inhibits increase of interleukin 8 and 6 during open heart surgery', *Canadian journal of anaesthesia*, 42: 399-403.
- Kaza, Aditya K, Jeffrey T Cope, Steven M Fiser, Stewart M Long, John A Kern, Irving L Kron, and Curtis G Tribble. 2003. 'Elimination of fat microemboli during cardiopulmonary bypass', *The annals of thoracic surgery*, 75: 555-59.
- Kessler, Paul, Johann Bauersachs, Rudi Busse, and Valérie B Schini-Kerth. 1997. 'Inhibition of inducible nitric oxide synthase restores endothelium-dependent relaxations in proinflammatory mediator-induced blood vessels', *Arteriosclerosis, Thrombosis, and Vascular Biology*, 17: 1746-55.
- Kiziltepe, Ugursay, Adnan Uysalel, Tumer Corapcioglu, Klara Dalva, Hamdi Akan, and Hakki Akalin. 2001. 'Effects of combined conventional and modified ultrafiltration in adult patients', *The annals of thoracic surgery*, 71: 684-93.

- Klein, Geraldine T, Yi Lu, and Michael Y Wang. 2013. '3D printing and neurosurgery—ready for prime time?', *World neurosurgery*, 80: 233-35.
- Kobayashi, Yoshiro. 2007. 'The role of chemokines in neutrophil biology', *Frontiers in bioscience: a journal and virtual library*, 13: 2400-07.
- Kolessov, VI. 1967. 'Mammary artery-coronary artery anastomosis as method of treatment for angina pectoris', *The Journal of thoracic and cardiovascular surgery*, 54: 535.
- Kotani, Naoki, Hiroshi Hashimoto, Daniel I Sessler, Masatoshi Muraoka, Jian-Sheng Wang, Michael F O'Connor, and Akitomo Matsuki. 2000. 'Cardiopulmonary bypass produces greater pulmonary than systemic proinflammatory cytokines', *Anesthesia & Analgesia*, 90: 1039-45.
- Kozik, D.J., and J.S. Tweddell. 2006. 'Characterizing the inflammatory response to cardiopulmonary bypass in children', *The annals of thoracic surgery*, 81: S2347.
- Kraft, Florian, Christoph Schmidt, Hugo Van Aken, and Alexander Zarbock. 2015. 'Inflammatory response and extracorporeal circulation', *Best Practice & Research Clinical Anaesthesiology*, 29: 113-23.
- Kretschmar, M, L Pfeiffer, C Schmidt, and W Schirrmeister. 1998. 'Plasma levels of glutathione,  $\alpha$ -tocopherol and lipid peroxides in polytraumatized patients; evidence for a stimulating effect of TNF  $\alpha$  on glutathione synthesis', *Experimental and Toxicologic Pathology*, 50: 477-83.

- Kroemer, G, L Galluzzi, Peter Vandenabeele, J Abrams, ES Alnemri, EH Baehrecke, MV Blagosklonny, WS El-Deiry, P Golstein, and DR Green. 2009. 'Classification of cell death: recommendations of the Nomenclature Committee on Cell Death 2009', *Cell Death & Differentiation*, 16: 3-11.
- Kumar, V, and A Sharma. 2010. 'Neutrophils: Cinderella of innate immune system', *International immunopharmacology*, 10: 1325-34.
- Kunkel, Steven L, Theodore Standiford, Keita Kasahara, and Robert M Strieter. 1991. 'Interleukin-8 (IL-8): the major neutrophil chemotactic factor in the lung', *Experimental lung research*, 17: 17-23.
- Laffey, John G. 2002. 'The systemic inflammatory response to cardiac surgery: implications for the anesthesiologist', *Anesthesiology*, 97: 215-52.
- landis, clive. 2009. 'Redefining the Systemic Inflammatory Response', *Seminar in cardiothoracic and vascular anesthesia*, 13: 87-94.
- landis, R.clive. 2010. 'Consensus Statement: Minimal Criteria for Reporting the Systemic Inflammatory Response to Cardiopulmonary Bypass', *The Heart Surgery Forum*, 13: 1182-.
- Lappegård, KT, G Bergseth, J Riesenfeld, A Pharo, P Magotti, JD Lambris, and TE Mollnes. 2008. 'The artificial surface-induced whole blood inflammatory reaction revealed by increases in a series of chemokines and growth factors is largely complement dependent', *Journal of Biomedical Materials Research Part A*, 87: 129-35.
- Larson, Daniel L. 1957. 'Relation of the postcommissurotomy syndrome to the rheumatic state', *Circulation*, 15: 203-09.

- Lazar, Harold L, Xi Zhang, Takafumi Hamasaki, Patrick Treanor, Samuel Rivers, Sheiah Bernard, and Richard J Shernin. 1995. 'Role of leukocyte depletion during cardiopulmonary bypass and cardioplegic arrest', *The annals of thoracic surgery*, 60: 1745-48.
- Lefkowitz, J.B. 2008. 'Coagulation pathway and physiology', *An Algorithmic Approach to Hemostasis Testing*: 3-12.
- Lentsch, Alex B, Boris J Czermak, Jacqueline A Jordan, and Peter A Ward. 1999. 'Regulation of acute lung inflammatory injury by endogenous IL-13', *The Journal of Immunology*, 162: 1071-76.
- Lequin, Rudolf M. 2005. 'Enzyme immunoassay (EIA)/enzyme-linked immunosorbent assay (ELISA)', *Clinical chemistry*, 51: 2415-18.
- Levy, Howard, Stephen R Ash, William Knab, Janusz Steczko, David J Carr, and Donald E Blake. 1998. 'Systemic inflammatory response syndrome treatment by powdered sorbent pheresis: The Biologic-Detoxification Plasma Filtration System', *ASAIO journal*, 44: M659-M65.
- Ley, Klaus, Carlo Laudanna, Myron I Cybulsky, and Sussan Nourshargh. 2007. 'Getting to the site of inflammation: the leukocyte adhesion cascade updated', *Nature Reviews Immunology*, 7: 678-89.
- Liebold, A, S Reisinger, K Lehle, L Rupprecht, A Philipp, and DE Birnbaum. 2002. 'Reduced invasiveness of perfusion with a minimized extracorporeal circuit (the Jostra MECC System)', *Thorac Cardiovasc Surg*, 50: S75.
- Lillehei, CW. 1993. 'Historical development of cardiopulmonary bypass', *Cardiopulmonary Bypass*, 1: 26.

- Lilley, Angela. 2002. 'The selection of priming fluids for cardiopulmonary bypass in the UK and Ireland', *Perfusion*, 17: 315-19.
- Lisan, Philip, Attilio Reale, and William Lokoff. 1959. 'The postmitral commissurotomy syndrome: a four-year clinical, pathologic and serologic study, and its relation to restenosis', *Annals of internal medicine*, 50: 1352-58.
- Lundblad, Runar, Oddvar Moen, and Erik Fosse. 1997. 'Endothelin-1 and neutrophil activation during heparin-coated cardiopulmonary bypass', *The annals of thoracic surgery*, 63: 1361-67.
- Ma, Shibai, Jun Lu, and Jinsheng Gao. 2002. 'Study of the low temperature pyrolysis of PVC', *Energy & Fuels*, 16: 338-42.
- Machin, David, and Chris Allsager. 2006. 'Principles of cardiopulmonary bypass', *Continuing Education in Anaesthesia, Critical Care & Pain*, 6: 176-81.
- Mahmoud, Alaa-Basiouni S, Mohamed S Burhani, Ali A Hannef, Ahmad A Jamjoom, Iskander S Al-Githmi, and Ghassan M Baslaim. 2005. 'Effect of modified ultrafiltration on pulmonary function after cardiopulmonary bypass', *Chest Journal*, 128: 3447-53.
- Majno, Guido, and Isabelle Joris. 1996. *Cells, tissues, and disease: principles of general pathology* (Blackwell Science Cambridge, Mass.:).
- Maluf, Miguel A. 2003. 'Modified ultrafiltration in surgical correction of congenital heart disease with cardiopulmonary bypass', *Perfusion*, 18: 61-68.
- Mangano, Dennis T, Iulia C Tudor, and Cynthia Dietzel. 2006. 'The risk associated with aprotinin in cardiac surgery', *New England Journal of Medicine*, 354: 353-65.

- Marchant, David J, John H Boyd, David C Lin, David J Granville, Farshid S Garmaroudi, and Bruce M McManus. 2012. 'Inflammation in myocardial diseases', *Circulation research*, 110: 126-44.
- Massoudy, Parwis, Stefan Zahler, Andreas Barankay, Bernhard F Becker, Josef A Richter, and Hans Meisner. 1999. 'Sodium nitroprusside during coronary artery bypass grafting: evidence for an antiinflammatory action', *The annals of thoracic surgery*, 67: 1059-64.
- Massoudy, Parwis, Stefan Zahler, Tobias Freyholdt, Richard Henze, Andreas Barankay, Bernhard F Becker, Siegmund L Braun, and Hans Meisner. 2000. 'Sodium nitroprusside in patients with compromised left ventricular function undergoing coronary bypass: reduction of cardiac proinflammatory substances', *The Journal of thoracic and cardiovascular surgery*, 119: 566-74.
- Matheis, G, M Scholz, A Simon, Omer Dzemali, and A Moritz. 2001. 'Leukocyte filtration in cardiac surgery: a review', *Perfusion*, 16: 361-70.
- Maugeri, N, M Brambilla, M Camera, A Carbone, E Tremoli, MB Donati, G De Gaetano, and C Cerletti. 2006. 'Human polymorphonuclear leukocytes produce and express functional tissue factor upon stimulation', *Journal of Thrombosis and Haemostasis*, 4: 1323-30.
- McBride, WT, MA Armstrong, AD Crockard, TJ McMurray, and JM Rea. 1995. 'Cytokine balance and immunosuppressive changes at cardiac surgery: contrasting response between patients and isolated CPB circuits', *British Journal of Anaesthesia*, 75: 724-33.

- Mendler, Nikolaus, Werner Heimisch, and Hubert Schad. 2000. 'Pulmonary function after biventricular bypass for autologous lung oxygenation', *European journal of cardio-thoracic surgery*, 17: 325-30.
- Meng, Qing H, Shiming Zhu, Namseok Sohn, Taras Mycyk, Susan A Shaw, Greg Dalshaug, and John Krahn. 2008. 'Release of cardiac biochemical and inflammatory markers in patients on cardiopulmonary bypass undergoing coronary artery bypass grafting', *Journal of cardiac surgery*, 23: 681-87.
- Michel, Olivier, Anne-Marie Nagy, Marc Schroeven, Jean Duchateau, Jean Neve, Pierre Fondu, and Roger Sergysels. 1997. 'Dose-response relationship to inhaled endotoxin in normal subjects', *American Journal of Respiratory and Critical Care Medicine*, 156: 1157-64.
- Michelsen, Luis G, Mutsuhito Kikura, Jerrold H Levy, Mi Kyoung Lee, King C Lee, Joseph J Zimmermann, and Fania Szlam. 1996. 'Heparinase I (neutralase) reversal of systemic anticoagulation', *The Journal of the American Society of Anesthesiologists*, 85: 339-46.
- Michelson, Alan D. 2006. 'Platelet Function Disorders', *Pediatric Hematology, Third Edition*: 562-82.
- Möbert, Jacqueline, and Bernhard F Becker. 1998. 'Cyclooxygenase inhibition aggravates ischemia–reperfusion injury in the perfused guinea pig heart: involvement of isoprostanes', *Journal of the American College of Cardiology*, 31: 1687-94.
- Montz, FJ, CH Holschneider, M Bozuk, WH Gotlieb, and O Martinez-Maza. 1994. 'Interleukin 10: ability to minimize postoperative intraperitoneal adhesion formation in a murine model', *Fertility and sterility*, 61: 1136-40.

- Morioka, Koichi, Ryusuke Muraoka, Yukio Chiba, Akio Ihaya, Tetuya Kimura, Hideki Noguti, and Takahiko Uesaka. 1996. 'Leukocyte and platelet depletion with a blood cell separator: effects on lung injury after cardiac surgery with cardiopulmonary bypass', *The Journal of thoracic and cardiovascular surgery*, 111: 45-54.
- Mortensen, Richard F, and Wangjian Zhong. 2000. 'Regulation of phagocytic leukocyte activities by C-reactive protein', *Journal of Leukocyte Biology*, 67: 495-500.
- Mueller, Xavier M, Iker Mallabiabrena, Giuseppe Mucciolo, and Ludwig K von Segesser. 2002. 'Optimized venous return with a self-expanding cannula: from computational fluid dynamics to clinical application', *Interactive cardiovascular and thoracic surgery*, 1: 23-27.
- Mueller, Xavier M, Hendrik T Tevaearai, David Jegger, Judith Horisberger, Giuseppe Mucciolo, and Ludwig K von Segesser. 2002. 'A new expandable venous cannula for minimal access heart surgery', *The annals of thoracic surgery*, 74: 1330-33.
- Muller, WA. 2013. 'Getting leukocytes to the site of inflammation', *Veterinary Pathology Online*, 50: 7-22.
- Muller, William A. 2003. 'Leukocyte–endothelial-cell interactions in leukocyte transmigration and the inflammatory response', *Trends in immunology*, 24: 326-33.
- Naik, SK, A Knight, and MJ Elliott. 1991. 'A successful modification of ultrafiltration for cardiopulmonary bypass in children', *Perfusion*, 6: 41-50.



- Nelson, Richard M, Oliviero Cecconi, W Gregory Roberts, Alejandro Aruffo, Robert J Linhardt, and MP Bevilacqua. 1993. 'Heparin oligosaccharides bind L-and P-selectin and inhibit acute inflammation', *Blood*, 82: 3253-58.
- Németh, Zoltán H, György Haskó, Csaba Szabó, and E Sylvester Vizi. 1997. 'Amrinone and theophylline differentially regulate cytokine and nitric oxide production in endotoxemic mice', *Shock*, 7: 371-75.
- Nishimoto, Norihiro, Kazuyuki Yoshizaki, Hiromi Tagoh, Morito Monden, Susumu Kishimoto, Toshio Hirano, and Tadimitsu Kishimoto. 1989. 'Elevation of serum interleukin 6 prior to acute phase proteins on the inflammation by surgical operation', *Clinical immunology and immunopathology*, 50: 399-401.
- Nyström, Per-Olof. 1998. 'The systemic inflammatory response syndrome: definitions and aetiology', *Journal of Antimicrobial Chemotherapy*, 41: 1-7.
- O'Carroll-Kuehn, Britta U, and Hanif Meeran. 2007. 'Management of coagulation during cardiopulmonary bypass', *Continuing Education in Anaesthesia, Critical Care & Pain*, 7: 195-98.
- O'Neil, Michael P, Jennifer C Fleming, Amit Badhwar, and Linrui Ray Guo. 2012. 'Pulsatile versus nonpulsatile flow during cardiopulmonary bypass: microcirculatory and systemic effects', *The annals of thoracic surgery*, 94: 2046-53.
- Oda, Shigeto, Hiroyuki Hirasawa, Hidetoshi Shiga, Kazuya Nakanishi, Ken-ichi Matsuda, and Masataka Nakamura. 2005. 'Sequential measurement of IL-6 blood levels in patients with systemic inflammatory response syndrome (SIRS)/sepsis', *Cytokine*, 29: 169-75.

- Ohata, Toshihiro, Masataka Mitsuno, Mitsuhiro Yamamura, Hiroe Tanaka, Yasuhiko Kobayashi, Masaaki Ryomoto, Yoshiteru Yoshioka, and Yuji Miyamoto. 2007. 'Minimal cardiopulmonary bypass attenuates neutrophil activation and cytokine release in coronary artery bypass grafting', *Journal of Artificial Organs*, 10: 92-95.
- Ohri, SK, JB Desai, JAR Gaer, JB Roussak, M Hashemi, PLC Smith, and KM Taylor. 1991. 'Intraabdominal complications after cardiopulmonary bypass', *The annals of thoracic surgery*, 52: 826-31.
- Ohto, Toshiaki, Fumio Yamamoto, and Nobuyuki Nakajima. 2000. 'Evaluation of leukocyte-reducing arterial line filter (LG6) for postoperative lung function, using cardiopulmonary bypass', *The Japanese Journal of Thoracic and Cardiovascular Surgery*, 48: 295-300.
- Oksuzyan, Anna, Knud Juel, James W Vaupel, and Kaare Christensen. 2008. 'Men: good health and high mortality. Sex differences in health and aging', *Aging clinical and experimental research*, 20: 91-102.
- Opal, Steven M, and Vera A DePalo. 2000. 'Anti-inflammatory cytokines', *Chest Journal*, 117: 1162-72.
- Palta, Sanjeev, Richa Saroa, and Anshu Palta. 2014. 'Overview of the coagulation system', *Indian journal of anaesthesia*, 58: 515.
- Paparella, D., TM Yau, and E. Young. 2002. 'Cardiopulmonary bypass induced inflammation: pathophysiology and treatment. An update', *European journal of cardio-thoracic surgery*, 21: 232-44.

- Patel, Kamala D, Susan L Cuvelier, and Shahina Wiehler. 2002. "Selectins: critical mediators of leukocyte recruitment." In *Seminars in immunology*, 73-81. Elsevier.
- Paul, Cassandra C, Jonathan R Keller, James M Armpriester, and MA Baumann. 1990. 'Epstein-Barr virus transformed B lymphocytes produce interleukin-5', *Blood*, 75: 1400-03.
- Pepys, Mark B, and Gideon M Hirschfield. 2003. 'C-reactive protein: a critical update', *Journal of Clinical Investigation*, 111: 1805.
- Pérez-Vela, JL, E Ruiz-Alonso, F Guillén-Ramírez, MT García-Maellas, E Renes-Carreño, M Cerro-García, J Cortina-Romero, and I Hernández-Rodríguez. 2008. 'ICU outcomes in adult cardiac surgery patients in relation to ultrafiltration type', *Perfusion*, 23: 79-87.
- Peter, P, and Willem JL Suyker. 2002. 'Off-pump coronary artery bypass surgery', *Heart*, 88: 313-18.
- Plaut, Marshall, Jacalyn H Pierce, Cynthia J Watson, Joan Hanley-Hyde, Richard P Nordan, and William E Paul. 1989. 'Mast cell lines produce lymphokines in response to cross-linkage of Fc&epsi; RI or to calcium ionophores'.
- Plötz, FB, W Van Oeveren, RH Bartlett, and CR Wildevuur. 1993. 'Blood activation during neonatal extracorporeal life support', *The Journal of thoracic and cardiovascular surgery*, 105: 823-32.
- Punjabi, Prakash P, and KM Taylor. 2013. 'The science and practice of cardiopulmonary bypass: From cross circulation to ECMO and SIRS', *Global cardiology science & practice*, 2013: 249.

- Putoczki, Tracy, and Matthias Ernst. 2010. 'More than a sidekick: the IL-6 family cytokine IL-11 links inflammation to cancer', *Journal of Leukocyte Biology*, 88: 1109-17.
- Quinn, David W, Domenico Pagano, Robert S Bonser, Stephen J Rooney, Timothy R Graham, Ian C Wilson, Bruce E Keogh, John N Townend, Michael E Lewis, and Peter Nightingale. 2006. 'Improved myocardial protection during coronary artery surgery with glucose-insulin-potassium: a randomized controlled trial', *The Journal of thoracic and cardiovascular surgery*, 131: 34-42. e2.
- Rasmussen, BS, H. Laugesen, J. Sollid, J. Grønlund, S.E. Rees, E. Toft, J. Gjedsted, C. Dethlefsen, and E. Tønnesen. 2007. 'Oxygenation and release of inflammatory mediators after off-pump compared with after on-pump coronary artery bypass surgery', *Acta anaesthesiologica scandinavica*, 51: 1202-10.
- Remadi, Jean-Paul, Paul Marticho, Irina Butoi, Zava Rakotoarivelo, Faouzi Trojette, Amar Benamar, Sadek Beloucif, Dominique Foure, and Henri J Poulain. 2004. 'Clinical experience with the mini-extracorporeal circulation system: an evolution or a revolution?', *The annals of thoracic surgery*, 77: 2172-75.
- Richter, Josef A, Hans Meisner, Peter Tassani, Andreas Barankay, Wulf Dietrich, and Sigmund L Braun. 2000. 'Drew-Anderson technique attenuates systemic inflammatory response syndrome and improves respiratory function after coronary artery bypass grafting', *The annals of thoracic surgery*, 69: 77-83.

- Rickards, Caroline A, and Yu-Chieh Tzeng. 2015. 'Arterial pressure and cerebral blood flow variability: friend or foe? A review', *Cerebral oxygenation in health and disease*: 66.
- Riddington, David W, B Venkatesh, Christopher M Boivin, Robert S Bonser, Thomas SJ Elliott, Timothy Marshall, Peter J Mountford, and Julian F Bion. 1996. 'Intestinal permeability, gastric intramucosal pH, and systemic endotoxemia in patients undergoing cardiopulmonary bypass', *Jama*, 275: 1007-12.
- Rittirsch, Daniel, Heinz Redl, and Markus Huber-Lang. 2012. 'Role of complement in multiorgan failure', *Clinical and Developmental Immunology*, 2012.
- Rodríguez-Gaspar, Melchor, Francisco Santolaria, Ana Jarque-López, Emilio González-Reimers, Antonio Milena, María-José de la Vega, Eva Rodríguez-Rodríguez, and Juan-Luis Gómez-Sirvent. 2001. 'Prognostic value of cytokines in SIRS general medical patients', *Cytokine*, 15: 232-36.
- Royston, D. 1997. 'The inflammatory response and extracorporeal circulation', *Journal of Cardiothoracic and Vascular Anesthesia*, 11: 341-54.
- Royston, David. 1996. 'Preventing the inflammatory response to open-heart surgery: the role of aprotinin and other protease inhibitors', *International journal of cardiology*, 53: S11-S37.
- S.H.Ferreira, J.R.Vane. 1978. *Inflammation* (Springer-Verlag Berlin Heidelberg New York).

- Sablutzki, Armin, Ingeborg Welters, Norbert Lehmann, Thilo Menges, Gerold Görlach, HM Dehne, and Gunter Hempelmann. 1997. 'Plasma levels of immunoinhibitory cytokines interleukin-10 and transforming growth factor-b in patients undergoing coronary artery bypass grafting', *European journal of cardio-thoracic surgery*, 11: 763-68.
- Sampson, J, and D De Korte. 2011. 'DEHP-plasticised PVC: relevance to blood services\*', *Transfusion medicine*, 21: 73-83.
- Samuelsson, Bengt. 1983. 'Leukotrienes: mediators of immediate hypersensitivity reactions and inflammation', *Science*, 220: 568-75.
- Sawa, Yoshiki, and Hikaru Matsuda. 2001. "Myocardial protection with leukocyte depletion in cardiac surgery." In *Seminars in thoracic and cardiovascular surgery*, 73-81. Elsevier.
- Sawa, Yoshiki, Susumu Nakano, Yasuhisa Shimazaki, Motonobu Nishimura, Tohru Kuratani, and Hikaru Matsuda. 1994. 'Myocardial protective effect and its mechanism of leukocyte-depleted reperfusion in neonatal rabbit hearts', *The annals of thoracic surgery*, 58: 1386-90.
- Scarfone, Richard J, Aaron J Donoghue, and Evaline A Alessandrini. 2003. 'Cardiac tamponade complicating postpericardiotomy syndrome', *Pediatric emergency care*, 19: 268-71.
- Schima, Heinrich, Leopold Huber, Helmut Schmallegger, Cornelis J Drost, Andrew Droudt, Georg Wieselthaler, and Udo Losert. 1997. 'Flow measurement at the pump head of centrifugal pumps: comparison of ultrasonic transit time and ultrasonic Doppler systems', *Artificial organs*, 21: 808-15.

- Schmidt, Tanja M, Gunnar Meyrowitz, Elke Naujokat, Jörg Albers, Uwe Kiencke, and Christian-Friedrich Vahl. 2003. "Heat exchange during cardiopulmonary bypass." In *CARS*, 741.
- Schofield, Zoe Victoria, Trent Martin Woodruff, Reena Halai, Mike Chia-Lun Wu, and Matthew Allister Cooper. 2013. 'Neutrophils—a key component of ischemia-reperfusion injury', *Shock*, 40: 463-70.
- Schönberger, Jacques PAM, Peter AM Everts, and Johannes J Hoffmann. 1995. 'Systemic blood activation with open and closed venous reservoirs', *The annals of thoracic surgery*, 59: 1549-55.
- Schroder, Kate, Paul J Hertzog, Timothy Ravasi, and David A Hume. 2004. 'Interferon- $\gamma$ : an overview of signals, mechanisms and functions', *Journal of Leukocyte Biology*, 75: 163-89.
- Schubert, Carl, Mark C van Langeveld, and Larry A Donoso. 2013. 'Innovations in 3D printing: a 3D overview from optics to organs', *British Journal of Ophthalmology*: bjophthalmol-2013-304446.
- Schwertschlag, US, WL Trepicchio, KH Dykstra, JC Keith, KJ Turner, and AJ Dorner. 1999. 'Hematopoietic, immunomodulatory and epithelial effects of interleukin-11', *Leukemia (08876924)*, 13.
- Seghaye, Marie-Christine, Jean Duchateau, Jacqueline Bruniaux, Serge Demontoux, Catherine Bosson, Alain Serraf, Gilles Lecronier, Emir Mokhfi, and Claude Planché. 1996. 'Interleukin-10 release related to cardiopulmonary bypass in infants undergoing cardiac operations', *The Journal of thoracic and cardiovascular surgery*, 111: 545-53.

- Seghaye, Marie-Christine, Jean Duchateau, Ralph G Grabitz, Thibault Wolffbb, Christiane Marcus, Wolfgang Engelhardt, Helmut Hörnchen, Bruno J Messmer, and Goetz von Bernuth. 1996. 'Effect of sodium nitroprusside on complement activation induced by cardiopulmonary bypass: a clinical and experimental study', *The Journal of thoracic and cardiovascular surgery*, 111: 882-92.
- Shafique, T, RG Johnson, H Bin Dai, RM Weintraub, and FW Sellke. 1993. 'Altered pulmonary microvascular reactivity after total cardiopulmonary bypass', *The Journal of thoracic and cardiovascular surgery*, 106: 479-86.
- Shahzad G Raja, Gilles D Dreyfus. 2005. 'Modulation of systemic Inflammatory response after cardiac surgery', *Asian Cardiovascular and thoracic annals*, 13: 382-95.
- Shankar-Hari, Manu, Gary S Phillips, Mitchell L Levy, Christopher W Seymour, Vincent X Liu, Clifford S Deutschman, Derek C Angus, Gordon D Rubenfeld, and Mervyn Singer. 2016. 'Developing a new definition and assessing new clinical criteria for septic shock: for the third international consensus definitions for sepsis and septic shock (sepsis-3)', *Jama*, 315: 775-87.
- Sheppard, SV, RV Gibbs, and DC Smith. 2004. 'Does leucocyte depletion during cardiopulmonary bypass improve oxygenation indices in patients with mild lung dysfunction?', *British Journal of Anaesthesia*, 93: 789-92.
- Sherman, William Bowen. 1968. *Hypersensitivity: mechanisms and management* (Saunders).



- Sievert, Alicia, and Joseph Sistino. 2012. 'A meta-analysis of renal benefits to pulsatile perfusion in cardiac surgery', *The Journal of extra-corporeal technology*, 44: 10-14.
- Sikora, JP, D Chlebna-Sokół, E Andrzejewska, S Chrul, E Polakowska, A Wysocka, and A Sikora. 2008. 'Clinical Evaluation of Proinflammatory Cytokine Inhibitors (sTNFR I, sTNFR II, IL-1 ra), Anti-inflammatory Cytokines (IL-10, IL-13) and Activation of Neutrophils after Burn-induced Inflammation', *Scandinavian journal of immunology*, 68: 145-52.
- Smith, P, Peter L Smith, and KM Taylor. 1993. *Cardiac surgery and the brain* (Edward Arnold).
- Socha, Luis A, John Gowardman, Diego Silva, Manuel Correcha, and Nikolai Petrosky. 2006. 'Elevation in interleukin 13 levels in patients diagnosed with systemic inflammatory response syndrome', *Intensive care medicine*, 32: 244-50.
- Soloff, Louis A, Jacoub Zatuchni, O henry JANTON, Thomas JE O'Neill, and Robert P Glover. 1953. 'Reactivation of rheumatic fever following mitral commissurotomy', *Circulation*, 8: 481-93.
- Sorokin, Lydia. 2010. 'The impact of the extracellular matrix on inflammation', *Nature Reviews Immunology*, 10: 712-23.
- Stalder, Mario, Erich Gygax, Franz F Immer, Lars Englberger, Hendrik Tevaearai, and Thierry P Carrel. 2006. "Minimized cardiopulmonary bypass combined with a smart suction device: the future of cardiopulmonary bypass?" In *The Heart Surgery Forum*, E235-8.

- Straub, Rainer H. 2007. 'The complex role of estrogens in inflammation', *Endocrine reviews*, 28: 521-74.
- Stump, David A. 2005. "Embolic factors associated with cardiac surgery." In *Seminars in cardiothoracic and vascular anesthesia*, 151-52. SAGE Publications.
- Sun, Ying-Jie, Hui-Juan Cao, Dan-Dan Song, Yu-Gang Diao, Jin Zhou, and Tie-Zheng Zhang. 2013. 'Probiotics Can Alleviate Cardiopulmonary Bypass-Induced Intestinal Mucosa Damage in Rats', *Digestive diseases and sciences*: 1-9.
- Takahashi, Yosuke, Toshihiko Shibata, Yasuyuki Sasaki, Hiromichi Fujii, Yasuyuki Bito, and Shigefumi Suehiro. 2008. 'Di (2-ethylhexyl) phthalate exposure during cardiopulmonary bypass', *Asian Cardiovascular and thoracic annals*, 16: 4-6.
- Takeuchi, Koh, J Pedro, Andra E Ibrahim, Hung Cao-Danh, Ingeborg Friebs, Paul Glynn, Dimitrios Poutias, Douglas B Cowan, and Francis X McGowan. 1999. 'Vesnarinone and amrinone reduce the systemic inflammatory response syndrome', *The Journal of thoracic and cardiovascular surgery*, 117: 375-82.
- Tallman, Richard D, Mark Dumond, and David Brown. 2002. 'Inflammatory mediator removal by zero-balance ultrafiltration during cardiopulmonary bypass', *Perfusion*, 17: 111-15.

- Tan, Siok Swan, Jan Bakker, Marga E Hoogendoorn, Atul Kapila, Joerg Martin, Angelo Pezzi, Giovanni Pittoni, Peter E Spronk, Robert Welte, and Leona Hakkaart-van Roijen. 2012. 'Direct cost analysis of intensive care unit stay in four European countries: applying a standardized costing methodology', *Value in health*, 15: 81-86.
- Tarnok, A., J. Hambsch, F. Emmrich, U. Sack, J. Van Son, W. Bellinghausen, M. Borte, and P. Schneider. 1999. 'Complement activation, cytokines, and adhesion molecules in children undergoing cardiac surgery with or without cardiopulmonary bypass', *Pediatric cardiology*, 20: 113-25.
- Tassani, Peter, Norbert Augustin, Andreas Barankay, Siegmund L Braun, Francesco Zaccaria, and Josef A Richter. 2000. 'High-dose aprotinin modulates the balance between proinflammatory and anti-inflammatory responses during coronary artery bypass graft surgery', *Journal of Cardiothoracic and Vascular Anesthesia*, 14: 682-86.
- Tegla, Cosmin A, Cornelia Cudrici, Snehal Patel, Richard Trippe III, Violeta Rus, Florin Niculescu, and Horea Rus. 2011. 'Membrane attack by complement: the assembly and biology of terminal complement complexes', *Immunologic research*, 51: 45-60.
- Thomson, Angus. 1992. *The Cytokine Handbook* (Harcourt Brace Jovanovich).
- Thurman, Joshua M, and V Michael Holers. 2006. 'The central role of the alternative complement pathway in human disease', *The Journal of Immunology*, 176: 1305-10.
- Tønnesen, E., V.B. Christensen, and P. Toft. 1996. 'The role of cytokines in cardiac surgery', *International journal of cardiology*, 53: S1-S10.

- Torina, Anali Galluce, Orlando Petrucci, Pedro Paulo Martins de Oliveira, Elaine Soraya Barbosa de Oliveira Severino, Karlos Alexandre de Souza Vilarinho, Carlos Fernando Ramos Lavagnoli, Maria Heloisa Blotta, and Reinaldo Wilson Vieira. 2010. 'The effects of modified ultrafiltration on pulmonary function and transfusion requirements in patients underwent coronary artery bypass graft surgery', *Revista Brasileira de Cirurgia Cardiovascular*, 25: 59-65.
- Tyrrell, David J, Angela P Horne, Kevin R Holme, JM Preuss, and Clive P Page. 1998. 'Heparin in inflammation: potential therapeutic applications beyond anticoagulation', *Advances in pharmacology (San Diego, Calif.)*, 46: 151-208.
- Urb, Mirjam, and Donald C Sheppard. 2012. 'The role of mast cells in the defence against pathogens', *PLoS pathogens*, 8.
- Uyar, Ihsan Sami, Suleyman Onal, Ayhan Uysal, Ugur Ozdemir, Oktay Burma, and Vedat Bulut. 2014. "Evaluation of systemic inflammatory response in cardiovascular surgery via interleukin-6, interleukin-8, and neopterin." In *The Heart Surgery Forum*, E13-7.
- Van Devort, AL, and RL Danner. 1990. 'Interleukin-8 (IL-8) primes human neutrophils for enhanced production of superoxide (O<sub>2</sub>)', *Crit Care Med*, 18: 1.
- Vercaemst, Leen. 2008. 'Hemolysis in cardiac surgery patients undergoing cardiopulmonary bypass: a review in search of a treatment algorithm', *The Journal of extra-corporeal technology*, 40: 257-67.

- Verschure, PJ, and CJ Van Noorden. 1989. 'The effects of interleukin-1 on articular cartilage destruction as observed in arthritic diseases, and its therapeutic control', *Clinical and experimental rheumatology*, 8: 303-13.
- Vieira Junior, Francisco Ubaldo, Nilson Antunes, Reinaldo Wilson Vieira, Lúcia Madalena Paulo Álvares, and Eduardo Tavares Costa. 2012. 'Hemolysis in extracorporeal circulation: relationship between time and procedures', *Brazilian Journal of Cardiovascular Surgery*, 27: 535-41.
- Vinten-Johansen, Jakob, Rong Jiang, James G Reeves, James Mykytenko, Jeremiah Deneve, and Lynetta J Jobe. 2007. 'Inflammation, proinflammatory mediators and myocardial ischemia–reperfusion Injury', *Hematology/oncology clinics of North America*, 21: 123-45.
- Vohra, H.A., R. Whistance, A. Modi, and S.K. Ohri. 2010. 'The inflammatory response to miniaturised extracorporeal circulation: a review of the literature', *Mediators of inflammation*, 2009.
- Wajant, H, K Pfizenmaier, and P Scheurich. 2003. 'Tumor necrosis factor signaling', *Cell Death & Differentiation*, 10: 45-65.
- Walther, Thomas, Volkmar Falk, Sebastian Metz, Anno Diegeler, Roberto Battellini, Rüdiger Autschbach, and Friedrich W Mohr. 1999. 'Pain and quality of life after minimally invasive versus conventional cardiac surgery', *The annals of thoracic surgery*, 67: 1643-47.
- Wan, S., J.M. DeSmet, L. Barvais, M. Goldstein, J.L. Vincent, and J.L. LeClerc. 1996. 'Myocardium is a major source of proinflammatory cytokines in patients undergoing cardiopulmonary bypass', *The Journal of thoracic and cardiovascular surgery*, 112: 806.

- Wan, S., J.L. LeClerc, and J.L. Vincent. 1997. 'Inflammatory response to cardiopulmonary bypass mechanisms involved and possible therapeutic strategies', *Chest Journal*, 112: 676-92.
- Wang, S, D Palanzo, and A Ündar. 2012. 'Current ultrafiltration techniques before, during and after pediatric cardiopulmonary bypass procedures', *Perfusion*, 27: 438-46.
- Wang, Wei, Hui Ming Huang, De Ming Zhu, Hong Chen, Zhao Kang Su, and Wei Xiang Ding. 1998. 'Modified ultrafiltration in paediatric cardiopulmonary bypass', *Perfusion*, 13: 304-10.
- Ware, Lorraine B, and Michael A Matthay. 2000. 'The acute respiratory distress syndrome', *New England Journal of Medicine*, 342: 1334-49.
- Warren, Oliver J, Andrew J Smith, Christos Alexiou, Paula LB Rogers, Noorulhuda Jawad, Charles Vincent, Ara W Darzi, and Thanos Athanasiou. 2009. 'The inflammatory response to cardiopulmonary bypass: part 1—mechanisms of pathogenesis', *Journal of Cardiothoracic and Vascular Anesthesia*, 23: 223-31.
- Warren, Oliver J, Amy L Watret, Katie L de Wit, Christos Alexiou, Charles Vincent, Ara W Darzi, and Thanos Athanasiou. 2009. 'The inflammatory response to cardiopulmonary bypass: Part 2—Anti-inflammatory therapeutic strategies', *Journal of Cardiothoracic and Vascular Anesthesia*, 23: 384-93.
- Waykole, Yogesh Prakash, SS Doiphode, PS Rakhewar, and Maya Mhaske. 2009. 'Anticytokine therapy for periodontal diseases: Where are we now?', *Journal of Indian Society of Periodontology*, 13: 64.

- Weerasinghe, Arjuna, and Kenneth M Taylor. 1998. 'The platelet in cardiopulmonary bypass', *The annals of thoracic surgery*, 66: 2145-52.
- Wiesenack, Christoph, Andreas Liebold, Alois Philipp, Markus Ritzka, Joachim Koppenberg, Dietrich E Birnbaum, and Cornelius Keyl. 2004. 'Four years' experience with a miniaturized extracorporeal circulation system and its influence on clinical outcome', *Artificial organs*, 28: 1082-88.
- Willatts, SM, DCE Speller, and RJ Winter. 1994. 'Incidence of Gram-negative bacteraemia in sepsis syndrome Implications for immunotherapy', *Anaesthesia*, 49: 751-54.
- Wippermann, Jens, Johannes M Albes, Martin Hartrumpf, Mirko Kaluza, Raimund Bruhin, and Thorsten Wahlers. 2005. 'Comparison of minimally invasive closed circuit extracorporeal circulation with conventional cardiopulmonary bypass and with off-pump technique in CABG patients: selected parameters of coagulation and inflammatory system', *European journal of cardiothoracic surgery*, 28: 127-32.
- Wojdasiewicz, Piotr, Łukasz A Poniatowski, and Dariusz Szukiewicz. 2014. 'The role of inflammatory and anti-inflammatory cytokines in the pathogenesis of osteoarthritis', *Mediators of inflammation*, 2014.
- Yang, Zequan, Basilia Zingarelli, and Csaba Szabó. 2000. 'Crucial role of endogenous interleukin-10 production in myocardial ischemia/reperfusion injury', *Circulation*, 101: 1019-26.

- Yassin, MD, Magdi MI, MD Harkin, Denis W, MD Barros D'Sa, Aires AB, Ph. D Halliday, M Isla, and MD Rowlands, Brian J. 2002. 'Lower limb ischemia-reperfusion injury triggers a systemic inflammatory response and multiple organ dysfunction', *World journal of surgery*, 26: 115-21.
- Yii, M, T Gourlay, J Fleming, B Matata, and KM Taylor. 1996. 'Evaluation of Carmeda® Bioactive Surface (CBAS®), Duraflo II and a novel nonspecific protease-modified surface using a new in vitro model simulating cardiopulmonary bypass', *Perfusion*, 11: 229-40.
- Yilmaz, Mert, Serdar Ener, Halis Akalin, Kadir Sagdic, O Akin Serdar, and Mete Cengiz. 1999. 'Effect of low-dose methyl prednisolone on serum cytokine levels following extracorporeal circulation', *Perfusion*, 14: 201-06.
- Yousafzai, Sajjad M, Murat Ugurlucan, Omar A Al Radhwan, Amal L Al Otaibi, and Charles C Canver. 2010. 'Open heart surgery in patients with sickle cell hemoglobinopathy', *Circulation*, 121: 14-19.
- Zakkar, Mustafa, Gustavo Guida, M Suleiman, and Gianni D Angelini. 2015. 'Cardiopulmonary bypass and oxidative stress', *Oxidative medicine and cellular longevity*, 2015.
- Zhang, Jun-Ming, and Jianxiong An. 2007. 'Cytokines, inflammation and pain', *International anesthesiology clinics*, 45: 27.
- Zhao, Xiaobin, and James M Courtney. 1999. 'Influence on blood of plasticized polyvinyl chloride: significance of the plasticizer', *Artificial organs*, 23: 104-07.



- Zheng, Tao, Zhou Zhu, Jingming Wang, Robert J Homer, and Jack A Elias. 2001. 'IL-11: insights in asthma from overexpression transgenic modeling', *Journal of allergy and clinical immunology*, 108: 489-96.
- Zhong, Wangjian, Qin Zen, Julie Tebo, Klaus Schlottmann, Mark Coggeshall, and Richard F Mortensen. 1998. 'Effect of human C-reactive protein on chemokine and chemotactic factor-induced neutrophil chemotaxis and signaling', *The Journal of Immunology*, 161: 2533-40.
- Zhou, Xin, Maren S Fragala, Janet E McElhaney, and George A Kuchel. 2010. 'Conceptual and methodological issues relevant to cytokine and inflammatory marker measurements in clinical research', *Current opinion in clinical nutrition and metabolic care*, 13: 541.
- Ziegeler, S, A Raddatz, SO Schneider, I Sandmann, H Sasse, I Bauer, D Kubulus, A Mathes, HF Lausberg, and H Rensing. 2009. 'Effects of Haemofiltration and Mannitol Treatment on Cardiopulmonary-Bypass Induced Immunosuppression', *Scandinavian journal of immunology*, 69: 234-41.
- Zou, Kelly H, A James O'Malley, and Laura Mauri. 2007. 'Receiver-operating characteristic analysis for evaluating diagnostic tests and predictive models', *Circulation*, 115: 654-57.

# Appendices

## Appendix A: Bovine (IL-6 and TNF- $\alpha$ ) ELISA assay protocol (Source RD bioscience, UK).

### Bovine ELISA protocols

#### CALCULATION OF RESULTS

Average the duplicate readings for each standard, control, and sample and subtract the average zero standard optical density (O.D.). Create a standard curve by reducing the data using computer software capable of generating a four parameter logistic (4-PL) curve-fit. As an alternative, construct a standard curve by plotting the mean absorbance for each standard on the y-axis against the concentration on the x-axis and draw a best fit curve through the points on the graph. The data may be linearized by plotting the log of the bovine IL-6 concentrations versus the log of the O.D. and the best fit line can be determined by regression analysis. This procedure will produce an adequate but less precise fit of the data. If samples have been diluted, the concentration read from the standard curve must be multiplied by the dilution factor.

#### TYPICAL DATA

This standard curve is only for demonstration purposes. A standard curve should be generated for each set of samples assayed.

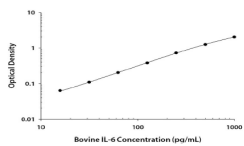

#### SPECIFICITY

The following factors prepared at 50 ng/mL were assayed and exhibited no cross-reactivity or interference.

#### Recombinants:

bovine IL-4  
canine IL-6  
cotton rat IL-6  
equine IL-6  
feline IL-6

human IL-6  
mouse IL-6  
porcine IL-6  
rat IL-6

#### TECHNICAL HINTS & LIMITATIONS

- We recommend the use of R&D Systems' Reagent Diluent Concentrate 3 (Catalog # DY004) to prepare Reagent Diluent for use in this assay.
- If assaying sample types other than cell culture supernates, each laboratory should develop and validate its own diluent. The diluent must not be used to dilute the Detection Antibody or the Streptavidin-HRP.
- It is important that the Reagent Diluent selected for reconstitution and dilution of the standard reflects the environment of the samples being measured.
- Avoid microbial contamination of reagents and buffers.
- A thorough and consistent wash technique is essential for proper assay performance. Wash Buffer should be dispensed forcefully and removed completely from the wells by aspiration or decanting. Remove any remaining Wash Buffer by inverting the plate and blotting it against clean paper towels.
- Individual results may vary due to differences in technique, plasticware and water sources.
- It is recommended that all standards and samples be assayed in duplicate.
- The use of PBS from tablets may interfere in this assay.

#### TROUBLESHOOTING

Note: For more detailed troubleshooting, please visit: [www.RnDSystems.com/ELISADevelopment](http://www.RnDSystems.com/ELISADevelopment)

#### Poor Standard Curve

- Improper reconstitution and/or storage of standard.
- Improper dilution of highest standard and standard curve.
- Incomplete washing and/or aspiration of wells.
- Unequal volumes added to wells/pipetting error.
- Incorrect incubation times or temperatures.

#### Poor Precision

- Unequal volumes added to wells/pipetting error.
  - Incomplete washing and/or aspiration of wells.
  - Unequal mixing of reagents.
- Low or No color Development**
- Inadequate volume of substrate added to wells.
  - Incorrect incubation times or temperatures.

**DuoSet<sup>®</sup> ELISA**  
DEVELOPMENT SYSTEM

#### Bovine IL-6

Catalog Number: DY8190 (15 plates)

#### INTENDED USE

For the development of sandwich ELISAs to measure natural and recombinant bovine Interleukin 6 (IL-6). The Reagent Diluent recommended may be suitable for most cell culture supernate, serum, and plasma samples. The Reagent Diluent selected for use can alter the performance of an immunoassay. Reagent Diluent optimization for samples with complex matrices such as serum and plasma, may improve their performance in this assay.

This kit contains sufficient materials to run ELISAs on at least fifteen 96 well plates, provided the following conditions are met:

- The reagents are prepared as described in this package insert.
- The assay is run as described in the General ELISA Protocol.
- The recommended microplates, buffers, diluents, substrates, and solutions are used.

This package insert must be read in its entirety before using this product. Refer to the Certificate of Analysis for component concentrations as they may vary. For research use only. Not for use in diagnostic procedures.

**MANUFACTURED AND DISTRIBUTED BY:**  
USA & Canada | R&D Systems, Inc.  
614 McKinley Plaza NE, Minneapolis, MN 55413, USA  
TEL: (800) 343-7475 (612) 379-2956 FAX: (612) 656-4400  
E-MAIL: [info@RnDSystems.com](mailto:info@RnDSystems.com)

**DISTRIBUTED BY:**  
UK & Europe | R&D Systems Europe, Ltd.  
19 Barton Lane, Abingdon Science Park, Abingdon OX14 3NB, UK  
TEL: +44 (0)1235 529449 FAX: +44 (0)1235 533420  
E-MAIL: [info@RnDSystems.co.uk](mailto:info@RnDSystems.co.uk)

China | R&D Systems China Co., Ltd.  
24A1 Hua Min Empire Plaza, 726 West Yan An Road, Shanghai PRC 200050  
TEL: +86 (21) 52380373 FAX: +86 (21) 52371001  
E-MAIL: [info@RnDSystemsChina.com.cn](mailto:info@RnDSystemsChina.com.cn)

736043.0

3/15

[www.RnDSystems.com](http://www.RnDSystems.com)

**R&D SYSTEMS**  
a biotechne brand

#### OTHER MATERIALS & SOLUTIONS REQUIRED

**DuoSet Ancillary Reagent Kit 3 (5 plates):** (R&D Systems, Catalog # DY009) containing 96 well microplates, plate sealers, substrate solution, stop solution, plate coating buffer (PBS), wash buffer, and Reagent Diluent Concentrate 3.

**The components listed above may be purchased separately:**  
**96 well microplates:** (R&D Systems, Catalog # DY990).

**Plate Sealers:** (R&D Systems, Catalog # DY992).

**PBS:** 137 mM NaCl, 2.7 mM KCl, 8.1 mM Na<sub>2</sub>HPO<sub>4</sub>, 1.5 mM KH<sub>2</sub>PO<sub>4</sub>, pH 7.2-7.4, 0.2  $\mu$ m filtered (R&D Systems, Catalog # DY006).

**Wash Buffer:** 0.05% Tween<sup>®</sup> 20 in PBS, pH 7.2-7.4 (R&D Systems, Catalog # WA126).

**Reagent Diluent:** 5% Tween 20 in PBS, pH 7.2-7.4, 0.2  $\mu$ m filtered. (R&D Systems Catalog # DY004).

**Substrate Solution:** 1:1 mixture of Color Reagent A (H<sub>2</sub>O<sub>2</sub>) and Color Reagent B (Tetramethylbenzidine) (R&D Systems, Catalog # DY999).

**Stop Solution:** 2 N H<sub>2</sub>SO<sub>4</sub> (R&D Systems, Catalog # DY994).

#### PRECAUTIONS

Some components in this kit contain ProClin<sup>™</sup> which may cause an allergic skin reaction. Avoid breathing mist.

The Stop Solution suggested for use with this kit is an acid solution. The Color Reagent B suggested for use with this kit may cause skin, eye, and respiratory irritation. Avoid breathing fumes.

Wear protective gloves, clothing, eye, and face protection. Wash hands thoroughly after handling. Please refer to the MSDS on our website prior to use.

#### CALIBRATION

This DuoSet is calibrated against a highly purified *E. coli*-expressed recombinant bovine IL-6 produced at R&D Systems.

#### MATERIALS PROVIDED & STORAGE CONDITIONS

Store the unopened kit at 2-8 °C. Do not use past kit expiration date.

DESCRIPTION	PART #	# VIALS	STORAGE OF OPENED/ RECONSTITUTED MATERIAL
Bovine IL-6 Capture Antibody	844129	1 vial	Refer to the lot-specific Certificate of Analysis (C of A) for storage conditions.
Bovine IL-6 Detection Antibody	844130	1 vial	
Bovine IL-6 Standard	844131	3 vials	
Streptavidin-HRP	890803	1 vial	

#### REAGENT PREPARATION

Bring all reagents to room temperature before use. Allow all components to sit for a minimum of 15 minutes with gentle agitation after initial reconstitution. Working dilutions should be prepared and used immediately.

**Streptavidin-HRP:** 1.0 mL of streptavidin conjugated to horseradish-peroxidase. Dilute to the working concentration specified on the vial label using Reagent Diluent.

**Mouse Anti-Bovine IL-6 Capture Antibody:** Refer to the lot-specific C of A for amount supplied. Reconstitute each vial with 1.0 mL of PBS. Dilute in PBS without carrier protein to the working concentration indicated on the C of A.

**Biotinylated Mouse Anti-Bovine IL-6 Detection Antibody:** Refer to the lot-specific C of A for amount supplied. Reconstitute each vial with 1.0 mL of Reagent Diluent. Dilute in Reagent Diluent to the working concentration indicated on the C of A.

**Recombinant Bovine IL-6 Standard:** Refer to the lot-specific C of A for amount supplied. Reconstitute each vial with 0.5 mL of Reagent Diluent. A seven point standard curve using 2-fold serial dilutions in Reagent Diluent is recommended. Prepare 1000  $\mu$ L of high standard per plate assayed at the concentration indicated on the C of A.

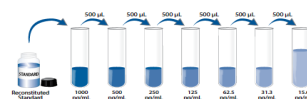

All trademarks and registered trademarks are the property of their respective owners.

## CALCULATION OF RESULTS

Average the duplicate readings for each standard, control, and sample and subtract the average zero standard optical density (O.D.). Create a standard curve by reducing the data using computer software capable of generating a four parameter logistic (4-PL) curve-fit. As an alternative, construct a standard curve by plotting the mean absorbance for each standard on the y-axis against the concentration on the x-axis and draw a best fit curve through the points on the graph. The data may be linearized by plotting the log of the bovine TNF- $\alpha$  concentrations versus the log of the O.D. and the best fit line can be determined by regression analysis. This procedure will produce an adequate but less precise fit of the data. If samples have been diluted, the concentration read from the standard curve must be multiplied by the dilution factor.

## TYPICAL DATA

This standard curve is only for demonstration purposes. A standard curve should be generated for each set of samples assayed.

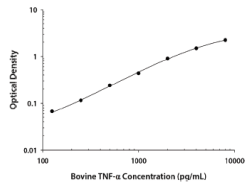

## SPECIFICITY

The following factors prepared at 50 ng/mL were assayed and exhibited no cross-reactivity or interference.

### Recombinants:

cotton rat TNF- $\alpha$   
equine TNF- $\alpha$   
feline TNF- $\alpha$   
human TNF- $\alpha$   
mouse TNF- $\alpha$   
porcine TNF- $\alpha$   
rat TNF- $\alpha$   
rhesus macaque TNF- $\alpha$

Recombinant canine TNF- $\alpha$  does not cross-react in this assay but does interfere at concentrations > 50 ng/mL.

## TECHNICAL HINTS & LIMITATIONS

- We recommend the use of R&D Systems' Reagent Diluent Concentrate 3 (Catalog # DY004) to prepare Reagent Diluent for use in this assay.
- If assaying sample types other than cell culture supernates, each laboratory should develop and validate its own diluent. The diluent must not be used to dilute the Detection Antibody or the Streptavidin-HRP.
- It is important that the Reagent Diluent selected for dilution of the standard reflects the environment of the samples being measured.
- Avoid microbial contamination of reagents and buffers.
- A thorough and consistent wash technique is essential for proper assay performance. Wash Buffer should be dispensed forcefully and removed completely from the wells by aspiration or decanting. Remove any remaining Wash Buffer by inverting the plate and blotting it against clean paper towels.
- Individual results may vary due to differences in technique, plasticware and water sources.
- It is recommended that all standards and samples be assayed in duplicate.
- The use of PBS from tablets may interfere in this assay.

## TROUBLESHOOTING

Note: For more detailed troubleshooting, please visit: [www.RnDSystems.com/ELISADevelopment](http://www.RnDSystems.com/ELISADevelopment)

### Poor Standard Curve

- Improper reconstitution and/or storage of standard.
- Improper dilution of highest standard and standard curve.
- Incomplete washing and/or aspiration of wells.
- Unequal volumes added to wells/pipetting error.
- Incorrect incubation times or temperatures.

### Poor Precision

- Unequal volumes added to wells/pipetting error.
- Incomplete washing and/or aspiration of wells.
- Unequal mixing of reagents.

### Low or No Color Development

- Inadequate volume of substrate added to wells.
- Incorrect incubation times or temperatures.

**DuoSet® ELISA**  
DEVELOPMENT SYSTEM

## Bovine TNF- $\alpha$

Catalog Number: DY2279 (15 plates)

## INTENDED USE

For the development of sandwich ELISAs to measure natural and recombinant bovine Tumor Necrosis Factor Alpha (TNF- $\alpha$ ). The Reagent Diluent recommended may be suitable for most cell culture supernate, serum, and plasma samples. The Reagent Diluent selected for use can alter the performance of an immunoassay. Reagent Diluent optimization for samples with complex matrices such as serum and plasma, may improve their performance in this assay.

This kit contains sufficient materials to run ELISAs on at least fifteen 96 well plates, provided the following conditions are met:

- The reagents are prepared as described in this package insert.
- The assay is run as described in the General ELISA Protocol.
- The recommended microplates, buffers, diluents, substrates, and solutions are used.

This package insert must be read in its entirety before using this product. Refer to the Certificate of Analysis for component concentrations as they may vary. For research use only. Not for use in diagnostic procedures.

## MANUFACTURED AND DISTRIBUTED BY:

USA & Canada | R&D Systems, Inc.  
614 McKinley Place NE, Minneapolis, MN 55413, USA  
TEL: (800) 343-7475 (612) 379-2956 FAX: (612) 656-4400  
E-MAIL: [info@RnDSystems.com](mailto:info@RnDSystems.com)

## DISTRIBUTED BY:

UK & Europe | R&D Systems Europe, Ltd.  
19 Barton Lane, Abingdon Science Park, Abingdon OX14 3NB, UK  
TEL: +44 (0)1235 529449 FAX: +44 (0)1235 533420  
E-MAIL: [info@RnDSystems.co.uk](mailto:info@RnDSystems.co.uk)

## China | R&D Systems China Co., Ltd.

24A1 Hua Min Empire Plaza, 726 West Yan An Road, Shanghai PRC 200050  
TEL: +86 (21) 52380373 FAX: +86 (21) 52371001  
E-MAIL: [info@RnDSystemsChina.com.cn](mailto:info@RnDSystemsChina.com.cn)

751935.6

7/15

[www.RnDSystems.com](http://www.RnDSystems.com)

**R&D SYSTEMS**  
a biotechne brand

## OTHER MATERIALS & SOLUTIONS REQUIRED

**DuoSet Ancillary Reagent Kit 3 (15 plates):** (R&D Systems, Catalog # DY009) containing 96 well microplates, plate sealers, substrate solution, stop solution, plate coating buffer (PBS), wash buffer, and Reagent Diluent Concentrate 3.

The components listed above may be purchased separately:

**96 well microplates:** (R&D Systems, Catalog # DY990).

**Plate Sealers:** (R&D Systems, Catalog # DY992).

**PBS:** 137 mM NaCl, 2.7 mM KCl, 8.1 mM Na<sub>2</sub>HPO<sub>4</sub>, 1.5 mM KH<sub>2</sub>PO<sub>4</sub>, pH 7.2-7.4, 0.2  $\mu$ m filtered (R&D Systems, Catalog # DY006).

**Wash Buffer:** 0.05% Tween® 20 in PBS, pH 7.2-7.4 (R&D Systems, Catalog # WA126).

**Reagent Diluent:** 5% Tween 20 in PBS, pH 7.2-7.4, 0.2  $\mu$ m filtered (R&D Systems, Catalog # DY004).

**Substrate Solution:** 1:1 mixture of Color Reagent A (H<sub>2</sub>O<sub>2</sub>) and Color Reagent B (Tetramethylbenzidine) (R&D Systems, Catalog # DY999).

**Stop Solution:** 2 N H<sub>2</sub>SO<sub>4</sub> (R&D Systems, Catalog # DY994).

**Normal Goat Serum:** (R&D Systems, Catalog # DY005).

## PRECAUTIONS

Some components in this kit contain ProClin® which may cause an allergic skin reaction. Avoid breathing mist.

The Stop Solution suggested for use with this kit is an acid solution. The Color Reagent B suggested for use with this kit may cause skin, eye, and respiratory irritation. Avoid breathing fumes.

Wear protective gloves, clothing, eye, and face protection. Wash hands thoroughly after handling. Please refer to the MSDS on our website prior to use.

## CALIBRATION

This DuoSet is calibrated against a highly purified *E. coli*-expressed recombinant bovine TNF- $\alpha$  produced at R&D Systems.

## MATERIALS PROVIDED & STORAGE CONDITIONS

Store the unopened kit at 2-8 °C. Do not use past kit expiration date.

DESCRIPTION	PART #	# WALS	STORAGE OF OPENED/ RECONSTITUTED MATERIAL
Bovine TNF- $\alpha$ Capture Antibody	842628	1 vial	Refer to the lot-specific Certificate of Analysis (C of A) for storage conditions.
Bovine TNF- $\alpha$ Detection Antibody	842629	1 vial	
Bovine TNF- $\alpha$ Standard	842630	3 vials	
Streptavidin-HRP	80803	1 vial	

## REAGENT PREPARATION

Bring all reagents to room temperature before use. Allow all components to sit for a minimum of 15 minutes with gentle agitation after initial reconstitution. Working dilutions should be prepared and used immediately, unless otherwise noted.

**Streptavidin-HRP:** 1.0 mL of streptavidin conjugated to horseradish-peroxidase. Dilute to the working concentration specified on the vial label using Reagent Diluent.

**Goat Anti-Bovine TNF- $\alpha$  Capture Antibody:** Refer to the lot-specific C of A for amount supplied. Reconstitute with 1.0 mL of PBS. Dilute in PBS without carrier protein to the working concentration indicated on the C of A.

**Biotinylated Goat Anti-Bovine TNF- $\alpha$  Detection Antibody:** Refer to the lot-specific C of A for amount supplied. Reconstitute each vial with 0.5 mL of Reagent Diluent. Dilute in Reagent Diluent with 2% heat inactivated normal goat serum (NGS) to the working concentration indicated on the C of A. Prepare 1-2 hours prior to use.

**Recombinant Bovine TNF- $\alpha$  Standard:** Refer to the lot-specific C of A for amount supplied. Reconstitute each vial with 0.5 mL of Reagent Diluent. A seven point standard curve using 2-fold serial dilutions in Reagent Diluent is recommended. Prepare 1000  $\mu$ L of high standard per plate assayed at the concentration indicated on the C of A.

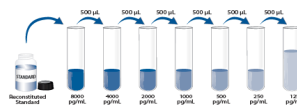

All trademarks and registered trademarks are the property of their respective owners.

## Appendix B: Bovine IL-6 standard curves

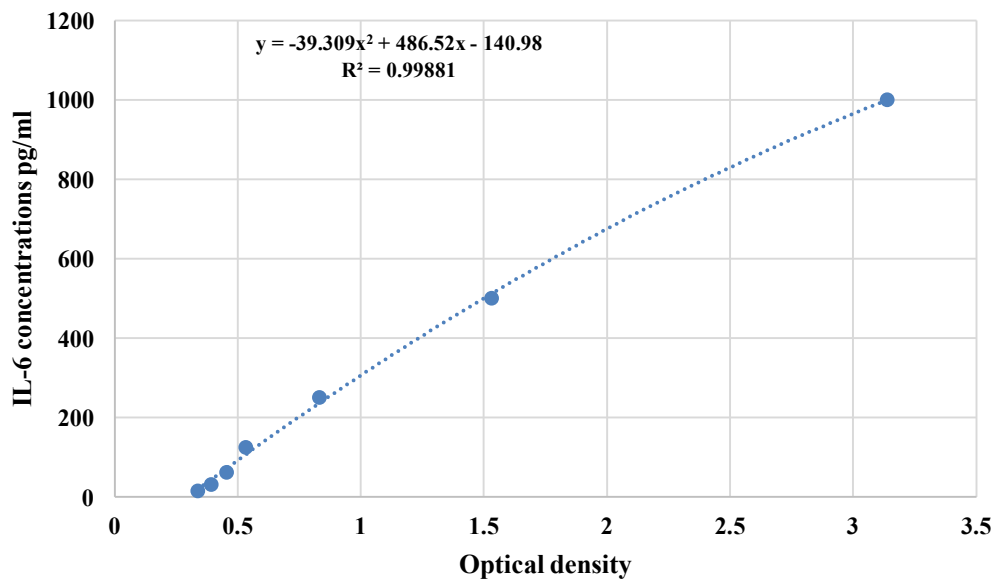

IL-6 standard curve (ELISA1)

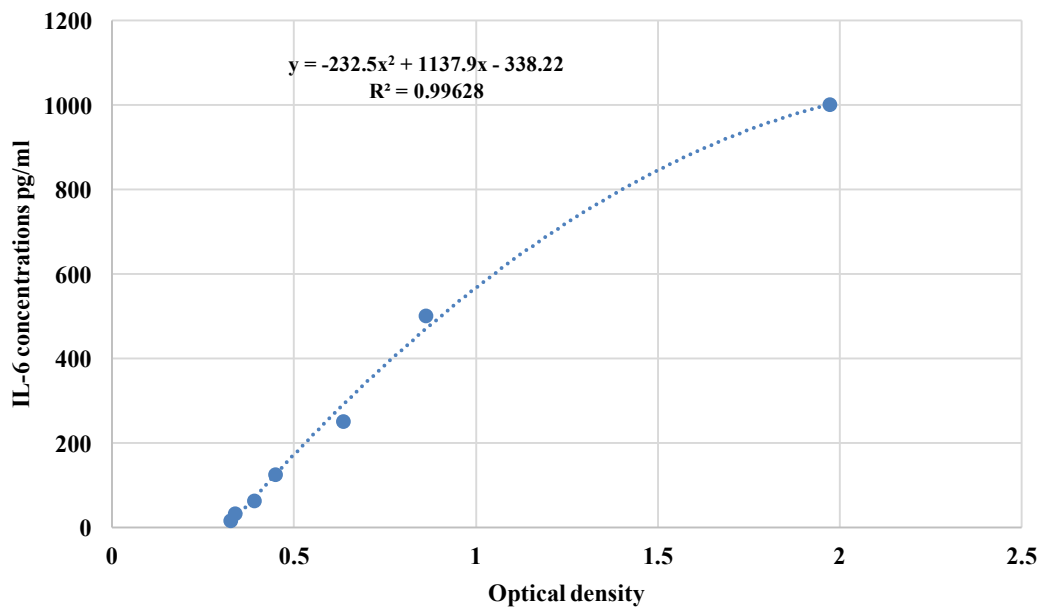

IL-6 standard curve (ELISA 3)

### Appendix C: Bovine TNF- $\alpha$ standard curves

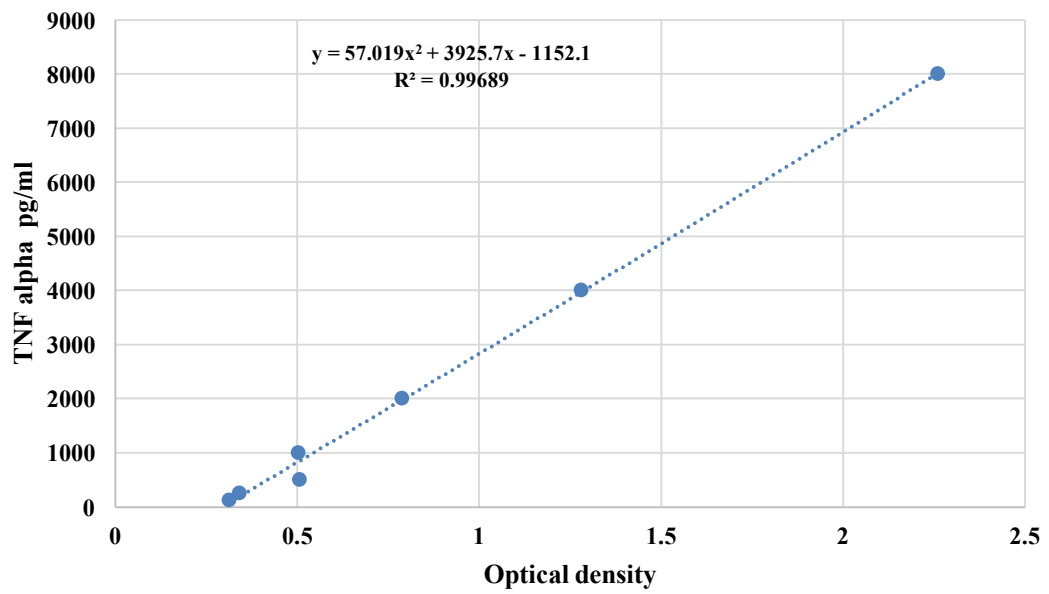

TNF- $\alpha$  standard curve (ELISA 1)

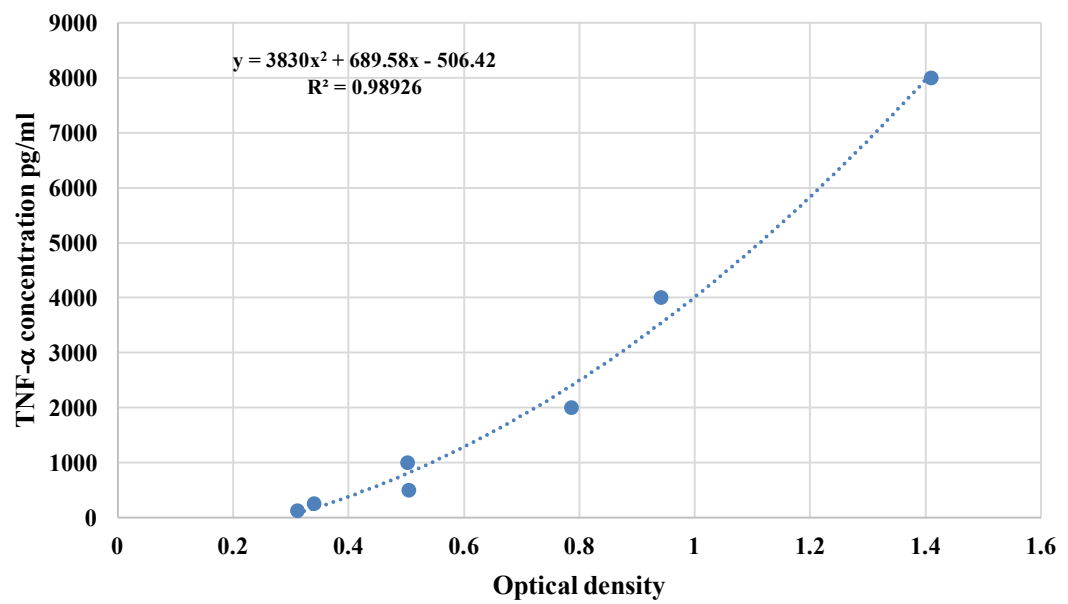

TNF- $\alpha$  standard curve (ELISA 3)

# Appendix D: Human ELISA protocols (IL-6, TNF- $\alpha$ -C-reactive protein)

## CALCULATION OF RESULTS

Average the duplicate readings for each standard, control, and sample and subtract the average zero standard optical density (O.D.). Create a standard curve by reducing the data using computer software capable of generating a four parameter logistic (4-PL) curve-fit. As an alternative, construct a standard curve by plotting the mean absorbance for each standard on the y-axis against the concentration on the x-axis and draw a best fit curve through the points on the graph. The data may be linearized by plotting the log of the human IL-6 concentrations versus the log of the O.D. and the best fit line can be determined by regression analysis. This procedure will produce an adequate but less precise fit of the data. If samples have been diluted, the concentration read from the standard curve must be multiplied by the dilution factor.

## TYPICAL DATA

This standard curve is only for demonstration purposes. A standard curve should be generated for each set of samples assayed.

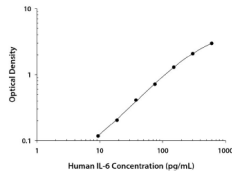

## SPECIFICITY

The following factors prepared at 50 ng/mL were assayed and exhibited no cross-reactivity or interference.

Recombinant human:	Recombinant mouse:
CNTF	IL-6
G-CSF	IL-11
gp130	IL-12
IL-6 R	
IL-11	Recombinant rat:
IL-12	CNTF
LIF	
OSM	

## TECHNICAL HINTS & LIMITATIONS

- We recommend the use of R&D Systems' Reagent Diluent Concentrate 2 (Catalog # DY995) to prepare Reagent Diluent for use in this assay.
- The use of high quality Bovine Serum Albumin (BSA) for the Reagent Diluent is crucial for the optimum performance of the DuoSet ELISA Development kit. Impurities such as proteases, binding proteins, soluble receptors or other interfering substances can be found to varying degrees in virtually all BSA preparations and can inhibit or interfere with the detection of certain analytes. If the standard curve appears suppressed, consider evaluating a different preparation of BSA.
- It is suggested to start Reagent Diluent optimization for serum and plasma samples by using PBS supplemented with 10-50% animal serum. Do not use buffers with animal serum to reconstitute or dilute the Detection Antibody or Streptavidin-HRP.
- It is important that the Reagent Diluent selected for dilution of the standard reflects the environment of the samples being measured.
- Avoid microbial contamination of reagents and buffers.
- A thorough and consistent wash technique is essential for proper assay performance. Wash Buffer should be dispensed forcefully and removed completely from the wells by aspiration or decanting. Remove any remaining Wash Buffer by inverting the plate and blotting it against clean paper towels.
- Individual results may vary due to differences in technique, plasticware and water sources.
- It is recommended that all standards and samples be assayed in duplicate.
- The use of PBS from tablets may interfere in this assay.

## TROUBLESHOOTING

Note: For more detailed troubleshooting, please visit: [www.RnDSystems.com/ELISADevelopment](http://www.RnDSystems.com/ELISADevelopment)

### Poor Standard Curve

- Impure BSA used for Reagent Diluent preparation.
- Improper reconstitution and/or storage of standard.
- Improper dilution of highest standard and standard curve.
- Incomplete washing and/or aspiration of wells.
- Unequal volumes added to wells/pipetting error.
- Incorrect incubation times or temperatures.

### Poor Precision

- Unequal volumes added to wells/pipetting error.
- Incomplete washing and/or aspiration of wells.
- Unequal mixing of reagents.

### Low or No Color Development

- Inadequate volume of substrate added to wells.
- Incorrect incubation times or temperatures.
- Impure BSA used for Reagent Diluent preparation.

**DuoSet<sup>®</sup> ELISA**  
DEVELOPMENT SYSTEM

## Human IL-6

Catalog Numbers: DY206-05 (5 plates)  
DY206 (15 plates)

## INTENDED USE

For the development of sandwich ELISAs to measure natural and recombinant human Interleukin 6 (IL-6). The Reagent Diluent recommended may be suitable for most cell culture supernatate, serum, and plasma samples. The Reagent Diluent selected for use can alter the performance of an immunoassay. Reagent Diluent optimization for samples with complex matrices such as serum and plasma, may improve their performance in this assay.

This kit contains sufficient materials to run ELISAs on at least five 96 well plates, provided the following conditions are met:

- The reagents are prepared as described in this package insert.
- The assay is run as described in the General ELISA Protocol.
- The recommended microplates, buffers, diluents, substrates, and solutions are used.

This package insert must be read in its entirety before using this product. Refer to the Certificate of Analysis for component concentrations as they may vary. For research use only. Not for use in diagnostic procedures.

## MANUFACTURED AND DISTRIBUTED BY:

USA & Canada | R&D Systems, Inc.  
614 McKinley Place NE, Minneapolis, MN 55413, USA  
TEL: (800) 343-7475 (612) 379-2956 FAX: (612) 656-4400  
E-MAIL: [info@RnDSystems.com](mailto:info@RnDSystems.com)

## DISTRIBUTED BY:

UK & Europe | R&D Systems Europe, Ltd.  
19 Barton Lane, Abingdon Science Park, Abingdon OX14 3NB, UK  
TEL: +44 (0)1235 529449 FAX: +44 (0)1235 533420  
E-MAIL: [info@RnDSystems.co.uk](mailto:info@RnDSystems.co.uk)

China | R&D Systems China Co., Ltd.  
24A1 Hua Min Empire Plaza, 726 West Yan An Road, Shanghai PRC 200050  
TEL: +86 (21) 52380373 FAX: +86 (21) 52371001  
E-MAIL: [info@RnDSystemsChina.com.cn](mailto:info@RnDSystemsChina.com.cn)

737369.3

3/15

[www.RnDSystems.com](http://www.RnDSystems.com)

**R&D SYSTEMS**  
a biotechnique brand

## OTHER MATERIALS & SOLUTIONS REQUIRED

### DuoSet Ancillary Reagent Pack 2 (5 plates):

(R&D Systems, Catalog # DY008) containing 96 well microplates, plate sealers, substrate solution, stop solution, plate coating buffer (PBS), wash buffer, and Reagent Diluent 2.

The components listed above may be purchased separately:

**96 well microplates:** (R&D Systems, Catalog # DY990).

**Plate sealers:** (R&D Systems, Catalog # DY992).

**PBS:** 137 mM NaCl, 2.7 mM KCl, 8.1 mM Na<sub>2</sub>HPO<sub>4</sub>, 1.5 mM KH<sub>2</sub>PO<sub>4</sub>, pH 7.2-7.4, 0.2  $\mu$ m filtered (R&D Systems, Catalog # DY006).

**Wash Buffer:** 0.05% Tween<sup>®</sup> 20 in PBS, pH 7.2-7.4 (R&D Systems, Catalog # WA126).

**Reagent Diluent:** 1% BSA in PBS, pH 7.2-7.4, 0.2  $\mu$ m filtered (R&D Systems, Catalog # DY995).

**Quality of BSA is critical** (see Technical Hints).

**Substrate Solution:** 1:1 mixture of Color Reagent A (H<sub>2</sub>O<sub>2</sub>) and Color Reagent B (Tetramethylbenzidine) (R&D Systems, Catalog # DY999).

**Stop Solution:** 2 N H<sub>2</sub>SO<sub>4</sub> (R&D Systems, Catalog # DY994).

## PRECAUTIONS

Some components in this kit contain ProClin<sup>®</sup> which may cause an allergic skin reaction. Avoid breathing mist.

The Stop Solution suggested for use with this kit is an acid solution. The Color Reagent B suggested for use with this kit may cause skin, eye, and respiratory irritation. Avoid breathing fumes.

Wear protective gloves, clothing, eye, and face protection. Wash hands thoroughly after handling. Please refer to the MSDS on our website prior to use.

## CALIBRATION

This DuoSet is calibrated against a highly purified E. coli-expressed recombinant human IL-6 produced at R&D Systems.

## MATERIALS PROVIDED & STORAGE CONDITIONS

Store the unopened kit at 2-8 °C. Do not use past kit expiration date.

DESCRIPTION	PART #	CATALOG #	CATALOG #	STORAGE OF OPENED/
		DY206-05	DY206	RECONSTITUTED MATERIAL
Human IL-6 Capture Antibody	84013	1 vial	3 vials	Refer to the lot-specific Certificate of Analysis (C of A) for storage conditions.
Human IL-6 Detection Antibody	84014	1 vial	3 vials	
Human IL-6 Standard	84015	1 vial	3 vials	
Streptavidin-HRP	89375	1 vial	3 vials	

## REAGENT PREPARATION

Bring all reagents to room temperature before use. Allow all components to sit for a minimum of 15 minutes with gentle agitation after initial reconstitution. Working dilutions should be prepared and used immediately.

**Streptavidin-HRP:** Each vial contains 2.0 mL of streptavidin conjugated to horseradish-peroxidase. Dilute to the working concentration specified on the vial label using Reagent Diluent.

**Mouse Anti-Human IL-6 Capture Antibody:** Refer to the lot-specific C of A for amount supplied. Reconstitute each vial with 0.5 mL of PBS. Dilute in PBS without carrier protein to the working concentration indicated on the C of A.

**Biotinylated Goat Anti-Human IL-6 Detection Antibody:** Refer to the lot-specific C of A for amount supplied. Reconstitute each vial with 1.0 mL of Reagent Diluent. Dilute in Reagent Diluent to the working concentration indicated on the C of A.

**Recombinant Human IL-6 Standard:** Refer to the lot-specific C of A for amount supplied. Reconstitute each vial with 0.5 mL of deionized or distilled water. A seven point standard curve using 2-fold serial dilutions in Reagent Diluent is recommended. Prepare 1000  $\mu$ L of high standard per plate assayed at the concentration indicated on the C of A.

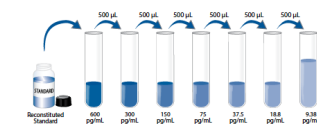

All trademarks and registered trademarks are the property of their respective owners.



## Human TNF-α

Catalog Numbers: DY210-05 (5 plates)  
DY210 (15 plates)

### CALCULATION OF RESULTS

Average the duplicate readings for each standard, control, and sample and subtract the average zero standard optical density (O.D.). Create a standard curve by reducing the data using computer software capable of generating a four parameter logistic (4-PL) curve-fit. As an alternative, construct a standard curve by plotting the mean absorbance for each standard on the y-axis against the concentration on the x-axis and draw a best fit curve through the points on the graph. The data may be linearized by plotting the log of the human TNF-α concentrations versus the log of the O.D. and the best fit line can be determined by regression analysis. This procedure will produce an adequate but less precise fit of the data. If samples have been diluted, the concentration read from the standard curve must be multiplied by the dilution factor.

### TYPICAL DATA

This standard curve is only for demonstration purposes. A standard curve should be generated for each set of samples assayed.

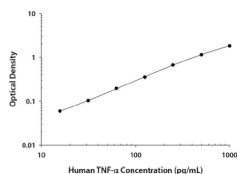

### SPECIFICITY

The following factors prepared at 50 ng/mL were assayed and exhibited no cross-reactivity or interference.

<b>Recombinant human:</b>	<b>Other recombinants:</b>
TNF-β	proctine TNF-α
TNF-FI	rat TNF-α
TNF-RII	

### Recombinant mouse:

TNF-α  
TNF-FI  
TNF-RII

### TECHNICAL HINTS & LIMITATIONS

- We recommend the use of R&D Systems' Reagent Diluent Concentrate 2 (Catalog # DY995) to prepare Reagent Diluent for use in this assay.
- The use of high quality Bovine Serum Albumin (BSA) for the Reagent Diluent is crucial for the optimum performance of the DuoSet ELISA Development kit. Impurities such as proteases, binding proteins, soluble receptors or other interfering substances can be found to varying degrees in virtually all BSA preparations and can inhibit or interfere with the detection of certain analytes. If the standard curve appears suppressed, consider evaluating a different preparation of BSA.
- It is suggested to start Reagent Diluent optimization for serum and plasma samples by using PBS supplemented with 10-50% animal serum. Do not use buffers with animal serum to reconstitute or dilute the Detection Antibody or Streptavidin-HRP.
- It is important that the Reagent Diluent selected for reconstitution and dilution of the standard reflects the environment of the samples being measured.
- Avoid microbial contamination of reagents and buffers.
- A thorough and consistent wash technique is essential for proper assay performance. Wash Buffer should be dispensed forcefully and removed completely from the wells by aspiration or decanting. Remove any remaining Wash Buffer by inverting the plate and blotting it against clean paper towels.
- Individual results may vary due to differences in technique, plasticware and water sources.
- It is recommended that all standards and samples be assayed in duplicate.
- The use of PBS from tablets may interfere in this assay.

### TROUBLESHOOTING

Note: For more detailed troubleshooting, please visit: [www.RnDSystems.com/ELISADevelopment](http://www.RnDSystems.com/ELISADevelopment)

#### Poor Standard Curve

- Impure BSA used for Reagent Diluent preparation.
- Improper reconstitution and/or storage of standard.
- Improper dilution of highest standard and standard curve.
- Incomplete washing and/or aspiration of wells.
- Unequal volumes added to wells/pipetting error.
- Incorrect incubation times or temperatures.

#### Poor Precision

- Unequal volumes added to wells/pipetting error.
- Incomplete washing and/or aspiration of wells.
- Unequal mixing of reagents.

#### Low or No Color Development

- Inadequate volume of substrate added to wells.
- Incorrect incubation times or temperatures.
- Impure BSA used for Reagent Diluent preparation.

### INTENDED USE

For the development of sandwich ELISAs to measure natural and recombinant human Tumor Necrosis Factor alpha (TNF-α). The Reagent Diluent recommended may be suitable for most cell culture supernate, serum, and plasma samples. The Reagent Diluent selected for use can alter the performance of an immunoassay. Reagent Diluent optimization for samples with complex matrices such as serum and plasma, may improve their performance in this assay.

This kit contains sufficient materials to run ELISAs on at least five 96 well plates, provided the following conditions are met:

- The reagents are prepared as described in this package insert.
- The assay is run as described in the General ELISA Protocol.
- The recommended microplates, buffers, diluents, substrates, and solutions are used.

This package insert must be read in its entirety before using this product. Refer to the Certificate of Analysis for component concentrations as they may vary. For research use only. Not for use in diagnostic procedures.

### MANUFACTURED AND DISTRIBUTED BY:

USA & Canada | R&D Systems, Inc.  
614 McKinley Place NE, Minneapolis, MN 55413, USA  
TEL: (800) 343-7475 (612) 379-2956 FAX: (612) 656-4400  
E-MAIL: [info@RnDSystems.com](mailto:info@RnDSystems.com)

### DISTRIBUTED BY:

UK & Europe | R&D Systems Europe, Ltd.  
19 Barton Lane, Abingdon Science Park, Abingdon OX14 3NB, UK  
TEL: +44 (0)1235 529499 FAX: +44 (0)1235 533420  
E-MAIL: [info@RnDSystems.co.uk](mailto:info@RnDSystems.co.uk)

### China | R&D Systems China Co., Ltd.

24A1 Hua Min Empire Plaza, 726 West Yan An Road, Shanghai PRC 200050  
TEL: +86 (21) 52380373 FAX: +86 (21) 52371001  
E-MAIL: [info@RnDSystemsChina.com.cn](mailto:info@RnDSystemsChina.com.cn)

### OTHER MATERIALS & SOLUTIONS REQUIRED

**DuoSet Ancillary Reagent Kit 2 (5 plates):** (R&D Systems, Catalog # DY008) containing 96 well microplates, plate sealers, substrate solution, stop solution, plate coating buffer (PBS), wash buffer, and Reagent Diluent Concentrate 2.

The components listed above may be purchased separately:

**96 well microplates:** (R&D Systems, Catalog # DY990).

**Plate Sealers:** (R&D Systems, Catalog # DY992).

**PBS:** 137 mM NaCl, 2.7 mM KCl, 8.1 mM Na<sub>2</sub>HPO<sub>4</sub>, 1.5 mM KH<sub>2</sub>PO<sub>4</sub>, pH 7.2-7.4, 0.2 μm filtered (R&D Systems, Catalog # DY006).

**Wash Buffer:** 0.05% Tween® 20 in PBS, pH 7.2-7.4 (R&D Systems, Catalog # WA126).

**Reagent Diluent:** 1% BSA in PBS, pH 7.2-7.4, 0.2 μm filtered (R&D Systems, Catalog # DY995).

**Quality of BSA is critical (see Technical Hints).**

**Substrate Solution:** 1:1 mixture of Color Reagent A (H<sub>2</sub>O<sub>2</sub>) and Color Reagent B (Tetramethylbenzidine) (R&D Systems, Catalog # DY999).

**Stop Solution:** 2 N H<sub>2</sub>SO<sub>4</sub> (R&D Systems, Catalog # DY994).

### PRECAUTIONS

Some components in this kit contain ProClin® which may cause an allergic skin reaction. Avoid breathing mist.

The Stop Solution suggested for use with this kit is an acid solution.

The Color Reagent B suggested for use with this kit may cause skin, eye, and respiratory irritation. Avoid breathing fumes.

Wear protective gloves, clothing, eye, and face protection. Wash hands thoroughly after handling. Please refer to the MSDS on our website prior to use.

### CALIBRATION

This DuoSet is calibrated against a highly purified E. coli-expressed recombinant human TNF-α produced at R&D Systems.

### MATERIALS PROVIDED & STORAGE CONDITIONS

Store the unopened kit at 2-8 °C. Do not use past kit expiration date.

DESCRIPTION	PART #	CATALOG # DY210-05	CATALOG # DY210	STORAGE OF OPENED/ RECONSTITUTED MATERIAL
Human TNF-α Capture Antibody	840119	1 vial	3 vials	Refer to the lot-specific Certificate of Analysis (C of A) for storage conditions.
Human TNF-α Detection Antibody	840120	1 vial	3 vials	
Human TNF-α Standard	840121	1 vial	3 vials	
Streptavidin-HRP	893975	1 vial	3 vials	

### REAGENT PREPARATION

Bring all reagents to room temperature before use. Allow all components to sit for a minimum of 15 minutes with gentle agitation after initial reconstitution. Working dilutions should be prepared and used immediately.

**Streptavidin-HRP:** Each vial contains 2.0 mL of streptavidin conjugated to horseradish-peroxidase. Dilute to the working concentration specified on the vial label using Reagent Diluent.

**Mouse Anti-Human TNF-α Capture Antibody:** Refer to the lot-specific C of A for amount supplied. Reconstitute each vial with 0.5 mL of PBS. Dilute in PBS without carrier protein to the working concentration indicated on the C of A.

**Biotinylated Goat Anti-Human TNF-α Detection Antibody:** Refer to the lot-specific C of A for amount supplied. Reconstitute each vial with 1.0 mL of Reagent Diluent. Dilute in Reagent Diluent to the working concentration indicated on the C of A.

**Recombinant Human TNF-α Standard:** Refer to the lot-specific C of A for amount supplied. Reconstitute each vial with 0.5 mL of Reagent Diluent. A seven point standard curve using 2-fold serial dilutions in Reagent Diluent is recommended. Prepare 1000 μL of high standard per plate assayed at the concentration indicated on the C of A.

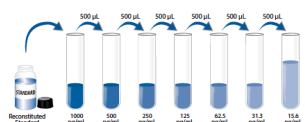

## CALCULATION OF RESULTS

Average the duplicate readings for each standard, control, and sample and subtract the average zero standard optical density (O.D.). Create a standard curve by reducing the data using computer software capable of generating a four parameter logistic (4-PL) curve-fit. As an alternative, construct a standard curve by plotting the mean absorbance for each standard on the y-axis against the concentration on the x-axis and draw a best fit curve through the points on the graph. The data may be linearized by plotting the log of the human CRP concentrations versus the log of the O.D. and the best fit line can be determined by regression analysis. This procedure will produce an adequate but less precise fit of the data. If samples have been diluted, the concentration read from the standard curve must be multiplied by the dilution factor.

## TYPICAL DATA

This standard curve is only for demonstration purposes. A standard curve should be generated for each set of samples assayed.

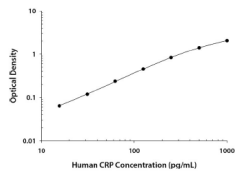

## SPECIFICITY

The following factors prepared at 50 ng/mL were assayed and exhibited no cross-reactivity or interference.

Recombinant human:	Other recombinants:
Pentaxin 2	mouse CRP
Pentaxin 3	porcine CRP
	rat CRP

## TECHNICAL HINTS & LIMITATIONS

- We recommend the use of R&D Systems' Reagent Diluent Concentrate 2 (Catalog # DY995) to prepare Reagent Diluent for use in this assay.
- The use of high quality Bovine Serum Albumin (BSA) for the Reagent Diluent is crucial for the optimum performance of the DuoSet ELISA Development kit. Impurities such as proteases, binding proteins, soluble receptors or other interfering substances can be found to varying degrees in virtually all BSA preparations and can inhibit or interfere with the detection of certain analytes. If the standard curve appears suppressed, consider evaluating a different preparation of BSA.
- It is suggested to start Reagent Diluent optimization for serum and plasma samples by using PBS supplemented with 10-50% animal serum. Do not use buffers with animal serum to reconstitute or dilute the Detection Antibody or Streptavidin-HRP.
- It is important that the Reagent Diluent selected for dilution of the standard reflects the environment of the samples being measured.
- Avoid microbial contamination of reagents and buffers.
- A thorough and consistent wash technique is essential for proper assay performance. Wash Buffer should be dispensed forcefully and removed completely from the wells by aspiration or decanting. Remove any remaining Wash Buffer by inverting the plate and blotting it against clean paper towels.
- Individual results may vary due to differences in technique, plasticware and water sources.
- It is recommended that all standards and samples be assayed in duplicate.
- The use of PBS from tablets may interfere in this assay.

## TROUBLESHOOTING

**Note:** For more detailed troubleshooting, please visit: [www.RnDSystems.com/ELISADevelopment](http://www.RnDSystems.com/ELISADevelopment)

### Poor Standard Curve

- Impure BSA used for Reagent Diluent preparation.
- Improper reconstitution and/or storage of standard.
- Improper dilution of highest standard and standard curve.
- Incomplete washing and/or aspiration of wells.
- Unequal volumes added to wells/pipetting error.
- Incorrect incubation times or temperatures.

### Poor Precision

- Unequal volumes added to wells/pipetting error.
- Incomplete washing and/or aspiration of wells.
- Unequal mixing of reagents.

### Low or No Color Development

- Inadequate volume of substrate added to wells.
- Incorrect incubation times or temperatures.
- Impure BSA used for Reagent Diluent preparation.

**DuoSet® ELISA**  
DEVELOPMENT SYSTEM

## Human C-Reactive Protein/CRP

Catalog Number: DY1707 (15 plates)

## INTENDED USE

For the development of sandwich ELISAs to measure natural and recombinant human C-Reactive Protein (CRP). The Reagent Diluent recommended may be suitable for most cell culture supernate, serum, and plasma samples. The Reagent Diluent selected for use can alter the performance of an immunoassay. Reagent Diluent optimization for samples with complex matrices such as serum and plasma, may improve their performance in this assay.

This kit contains sufficient materials to run ELISAs on at least fifteen 96 well plates, provided the following conditions are met:

- The reagents are prepared as described in this package insert.
- The assay is run as described in the General ELISA Protocol.
- The recommended microplates, buffers, diluents, substrates, and solutions are used.

This package insert must be read in its entirety before using this product. Refer to the Certificate of Analysis for component concentrations as they may vary. For research use only. Not for use in diagnostic procedures.

## MANUFACTURED AND DISTRIBUTED BY:

USA & Canada | R&D Systems, Inc.  
614 McKinley Place NE, Minneapolis, MN 55413, USA  
TEL: (800) 343-7475 (612) 379-2956 FAX: (612) 656-4400  
E-MAIL: [info@RnDSystems.com](mailto:info@RnDSystems.com)

## DISTRIBUTED BY:

UK & Europe | R&D Systems Europe, Ltd.  
19 Barton Lane, Abingdon Science Park, Abingdon OX14 3NB, UK  
TEL: +44 (0)1235 529449 FAX: +44 (0)1235 533420  
E-MAIL: [info@RnDSystems.co.uk](mailto:info@RnDSystems.co.uk)

China | R&D Systems China Co., Ltd.  
29A1 Hua Min Empire Plaza, 726 West Yan An Road, Shanghai PRC 200050  
TEL: +86 (21) 52380373 FAX: +86 (21) 52371001  
E-MAIL: [info@RnDSystemsChina.com.cn](mailto:info@RnDSystemsChina.com.cn)

**R&D SYSTEMS**  
a biotechne brand

751956.4

5/15

[www.RnDSystems.com](http://www.RnDSystems.com)

## OTHER MATERIALS & SOLUTIONS REQUIRED

**DuoSet Ancillary Reagent Kit 2 (5 plates):** (R&D Systems, Catalog # DY008) containing 96 well microplates, plate sealers, substrate solution, stop solution, plate coating buffer (PBS), wash buffer, and Reagent Diluent Concentrate 2.

The components listed above may be purchased separately:

**96 well microplates:** (R&D Systems, Catalog # DY990).

**Plate Sealers:** (R&D Systems, Catalog # DY992).

**PBS:** 137 mM NaCl, 2.7 mM KCl, 8.1 mM Na<sub>2</sub>HPO<sub>4</sub>, 1.5 mM KH<sub>2</sub>PO<sub>4</sub>, pH 7.2-7.4, 0.2 µm filtered (R&D Systems, Catalog # DY006).

**Wash Buffer:** 0.05% Tween\* 20 in PBS, pH 7.2-7.4 (R&D Systems, Catalog # WA126).

**Reagent Diluent:** 1% BSA in PBS, pH 7.2-7.4, 0.2 µm filtered (R&D Systems, Catalog # DY995).

**Quality of BSA is critical (see Technical Hints).**

**Substrate Solution:** 1:1 mixture of Color Reagent A (H<sub>2</sub>O<sub>2</sub>) and Color Reagent B (Tetramethylbenzidine) (R&D Systems, Catalog # DY999).

**Stop Solution:** 2 N H<sub>2</sub>SO<sub>4</sub> (R&D Systems, Catalog # DY994).

## PRECAUTIONS

Some components in this kit contain ProClin® which may cause an allergic skin reaction. Avoid breathing mist.

The Stop Solution suggested for use with this kit is an acid solution.

The Color Reagent B suggested for use with this kit may cause skin, eye, and respiratory irritation. Avoid breathing fumes.

Wear protective gloves, clothing, eye, and face protection. Wash hands thoroughly after handling. Please refer to the MSDS on our website prior to use.

## CALIBRATION

This DuoSet is calibrated against a highly purified NS0-expressed recombinant human CRP produced at R&D Systems.

## MATERIALS PROVIDED & STORAGE CONDITIONS

Store the unopened kit at 2-8 °C. Do not use past kit expiration date.

DESCRIPTION	PART #	# WIALS	STORAGE OF OPENED/ RECONSTITUTED MATERIAL
Human CRP Capture Antibody	842676	1 vial	Refer to the lot-specific Certificate of Analysis (C of A) for storage conditions.
Human CRP Detection Antibody	842677	1 vial	
Human CRP Standard	842678	1 vial	
Streptavidin-HRP	890883	1 vial	

## REAGENT PREPARATION

Bring all reagents to room temperature before use. Allow all components to sit for a minimum of 15 minutes with gentle agitation after initial reconstitution. Working dilutions should be prepared and used immediately.

**Streptavidin-HRP:** 1.0 mL of streptavidin conjugated to horseradish-peroxidase. Dilute to the working concentration specified on the vial label using Reagent Diluent.

**Mouse Anti-Human CRP Capture Antibody:** Refer to the lot-specific C of A for amount supplied. Reconstitute with 1.0 mL of PBS. Dilute in PBS without carrier protein to the working concentration indicated on the C of A.

**Biotinylated Mouse Anti-Human CRP Detection Antibody:** Refer to the lot-specific C of A for amount supplied. Reconstitute with 1.0 mL of Reagent Diluent. Dilute in Reagent Diluent to the working concentration indicated on the C of A.

**Recombinant Human CRP Standard:** Refer to the lot-specific C of A for amount supplied. Reconstitute with 0.5 mL of Reagent Diluent. A seven point standard curve using 2-fold serial dilutions in Reagent Diluent is recommended. Prepare 1000 µL of high standard per plate assayed at the concentration indicated on the C of A.

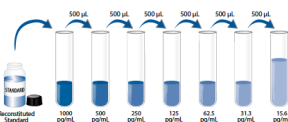

All trademarks and registered trademarks are the property of their respective owners.



### Appendix E: Human IL-6 standard curves

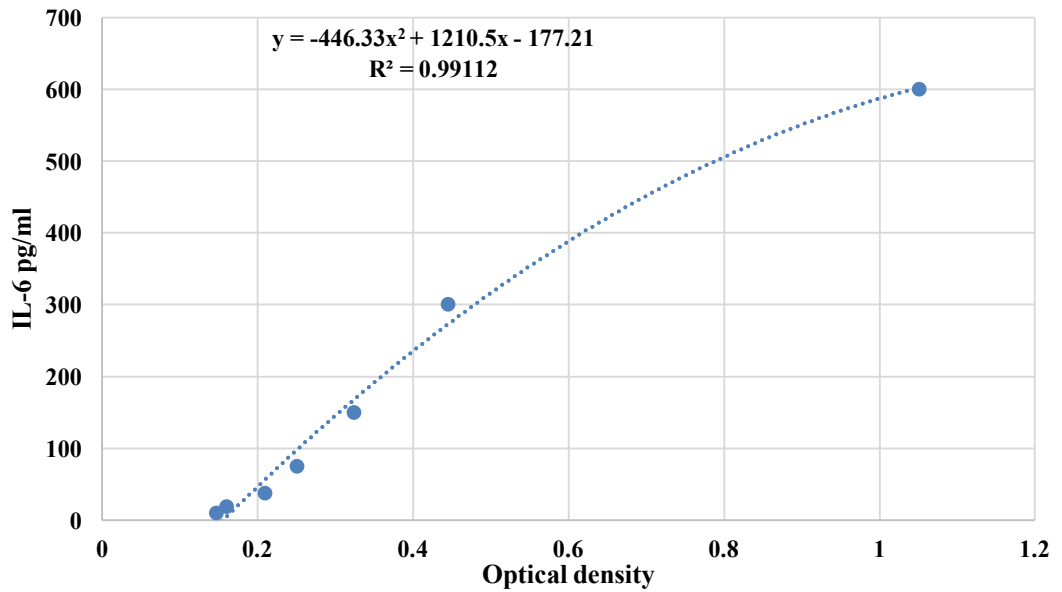

IL-6 standard curve (ELISA 1) for patients (P1-P20)

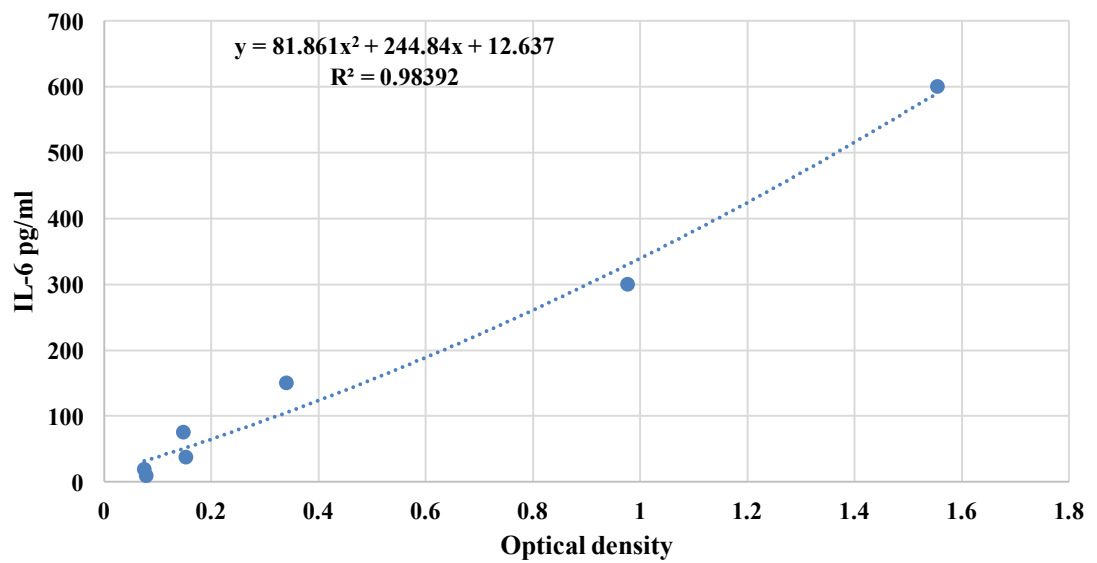

IL-6 standard curve (ELISA 2) for patients (P1-P20)

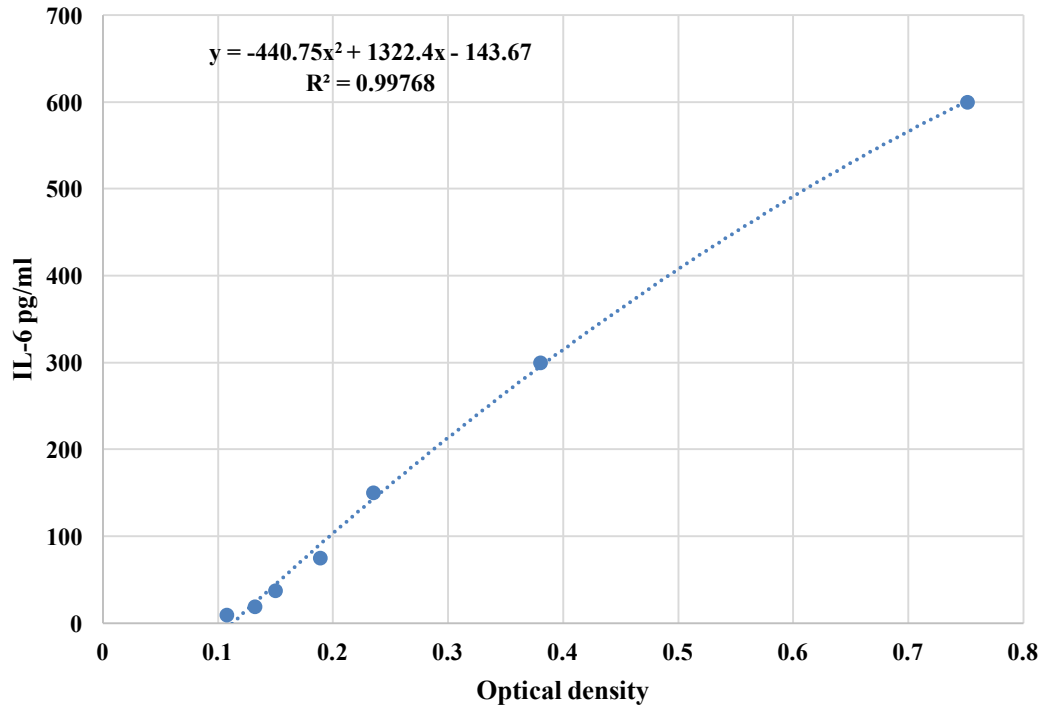

standard curve (ELISA 1) for patients (P21-P40)

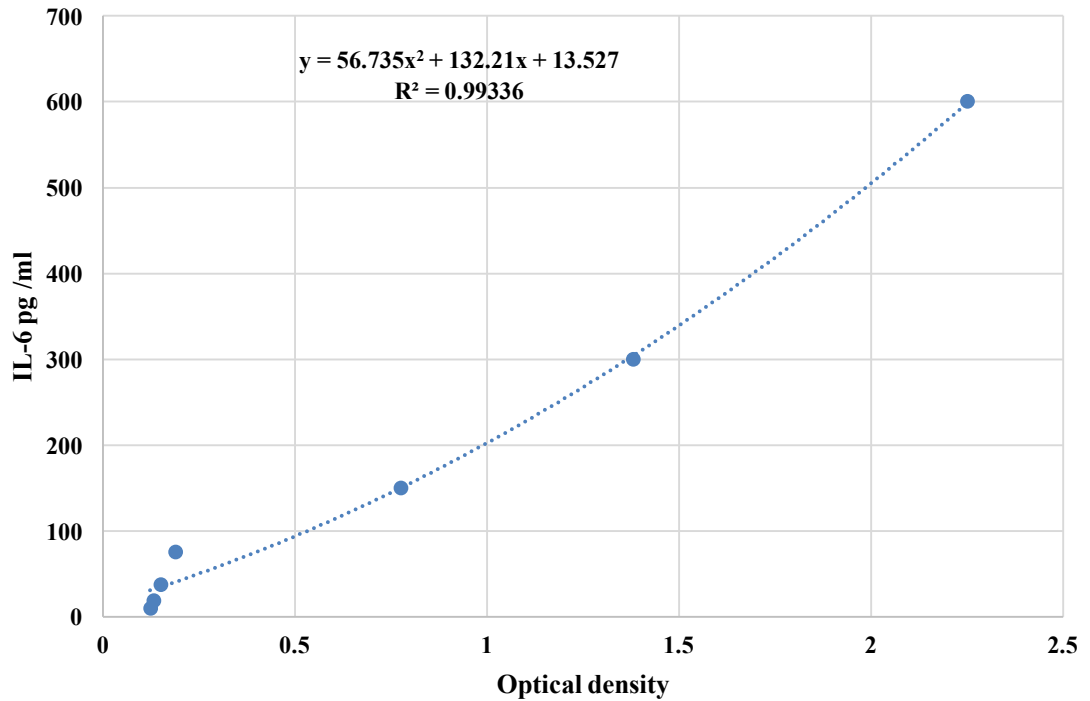

IL-6 standard Curve (ELISA 2) for patients (P21-P40).

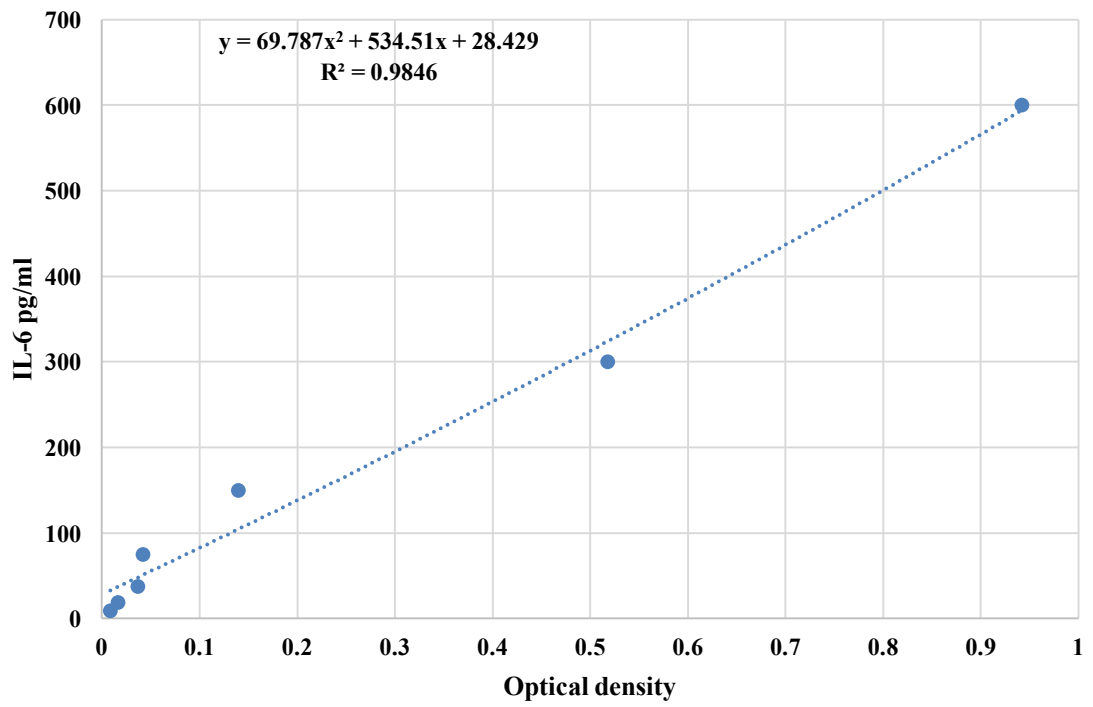

IL-6 standard curve (ELISA 1) for patients (P41-P52)

**Appendix F: TNF- $\alpha$  standard curves for all patients' samples .**

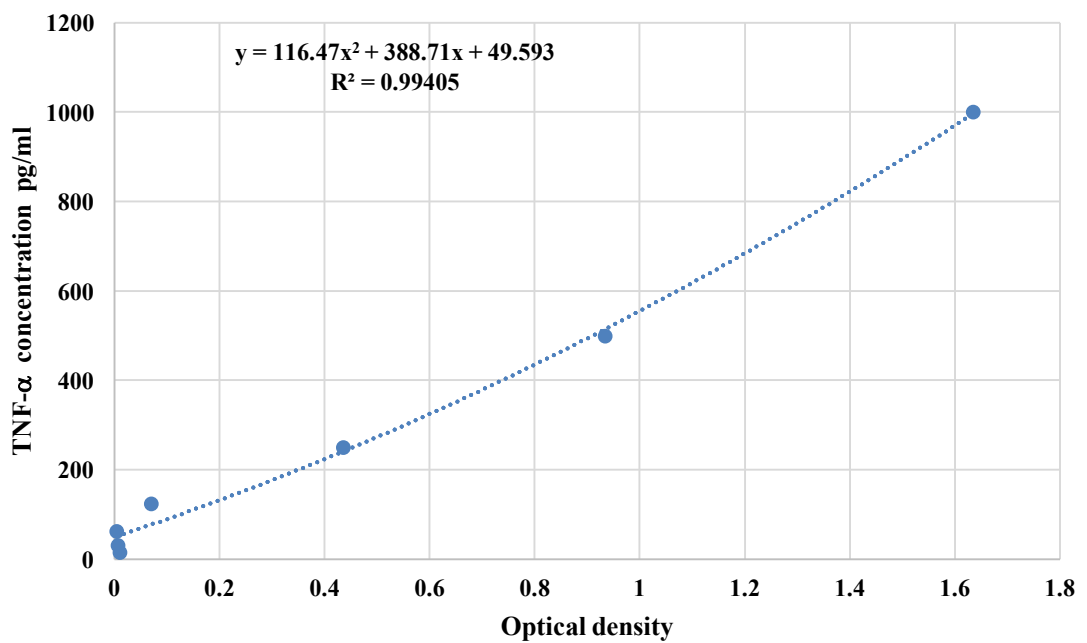

TNF- $\alpha$  standard curve (ELISA 1) for patients (P1-P20)

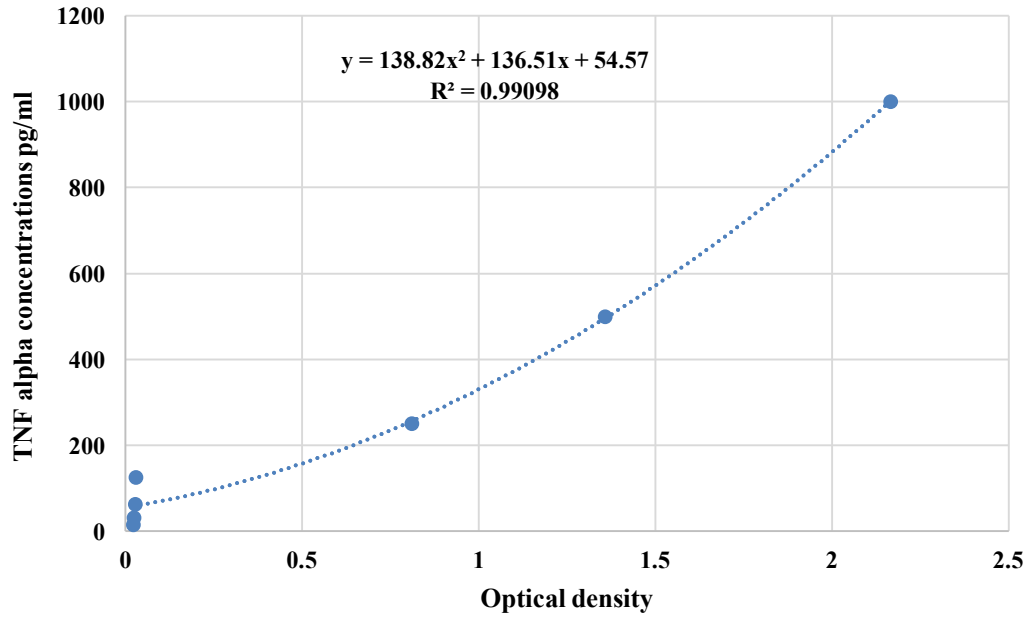

TNF- $\alpha$  standard curve (ELISA 1) for patients (P21-P40)

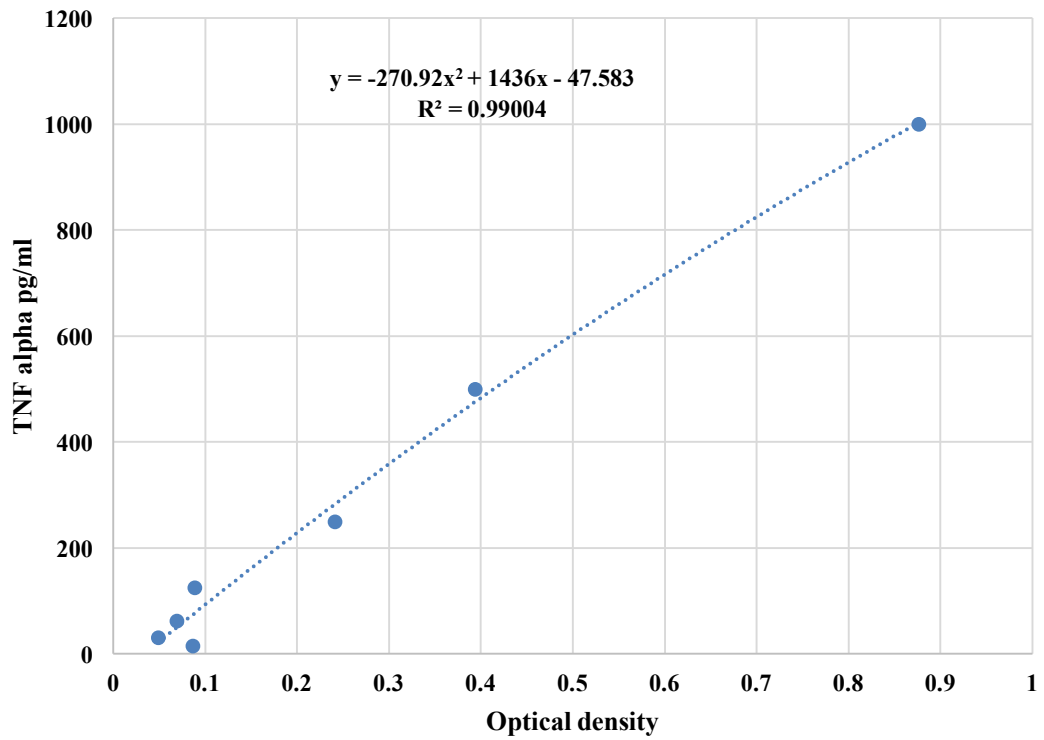

TNF- $\alpha$  standard curve (ELISA 2) for patients (P21-P40)

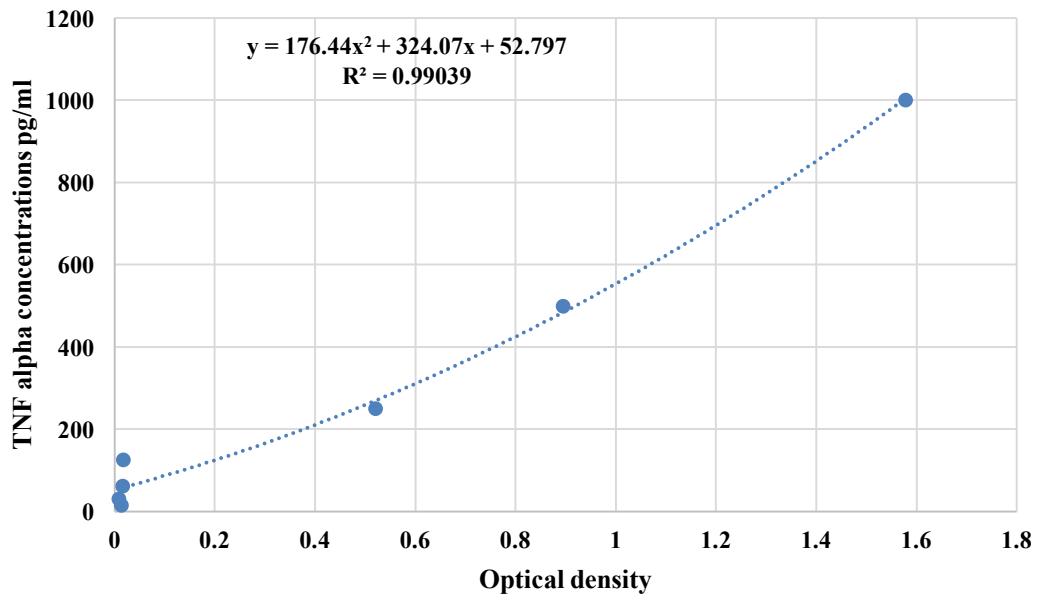

TNF- $\alpha$  standard curve (ELISA 1) for patients (P41-P52)

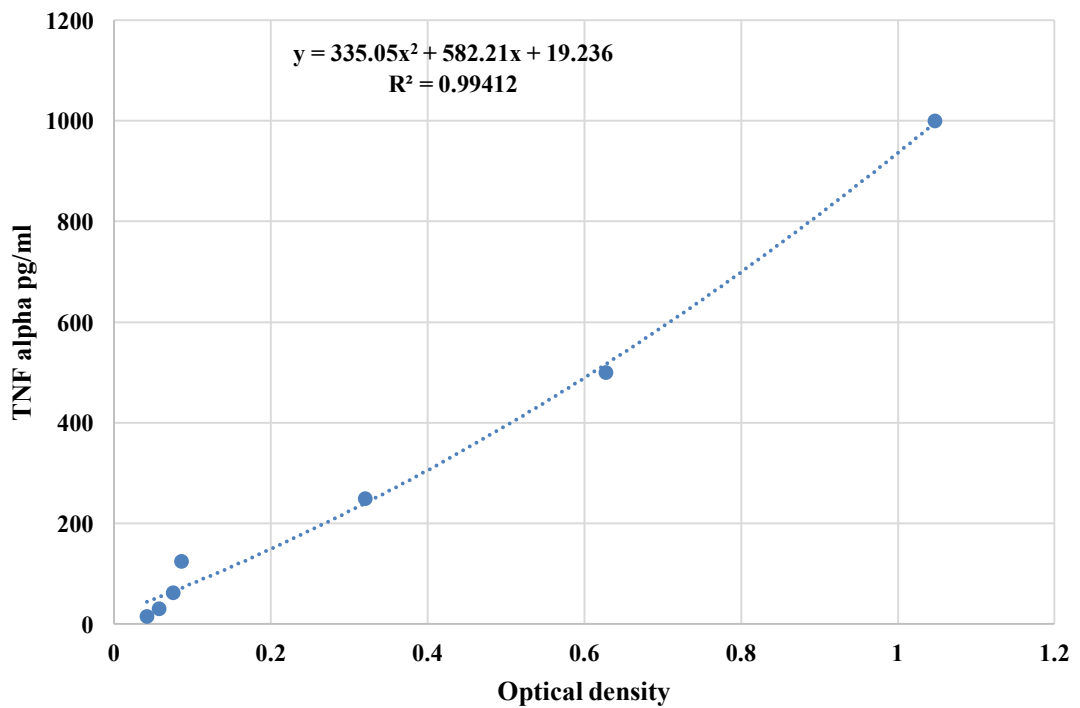

TNF- $\alpha$  standard Curve (ELISA 2)for patients ( P41-P52)

### Appendix G: CRP standard curves for all patients' samples

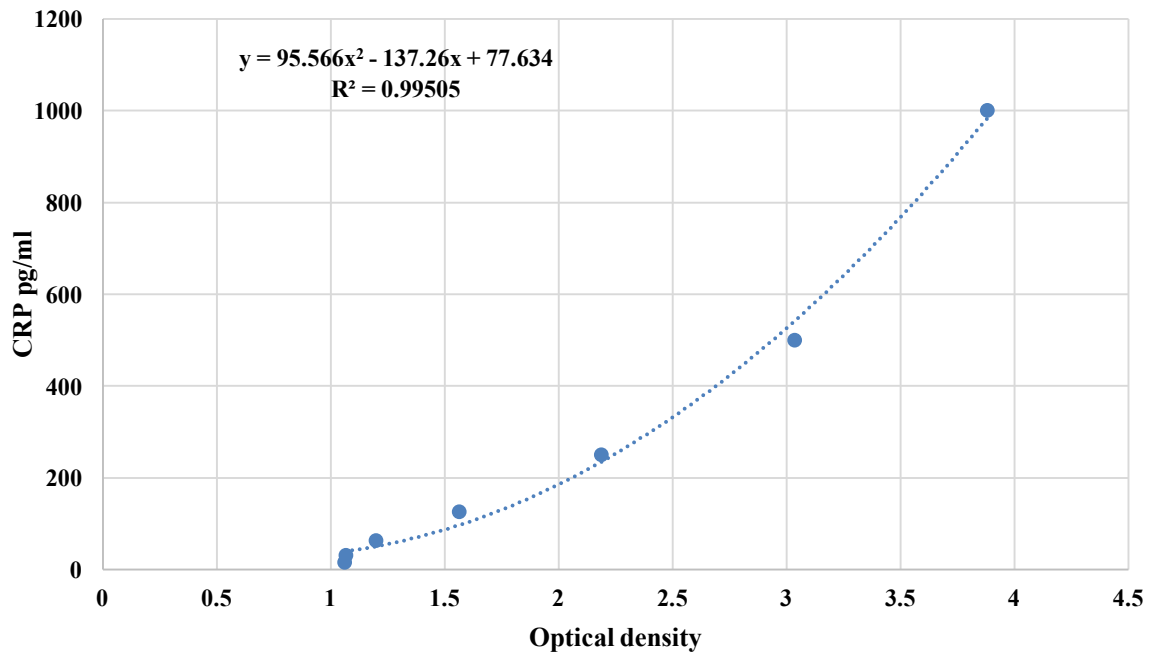

CRP standard curve (ELISA 2) for Patients(P1-P20)

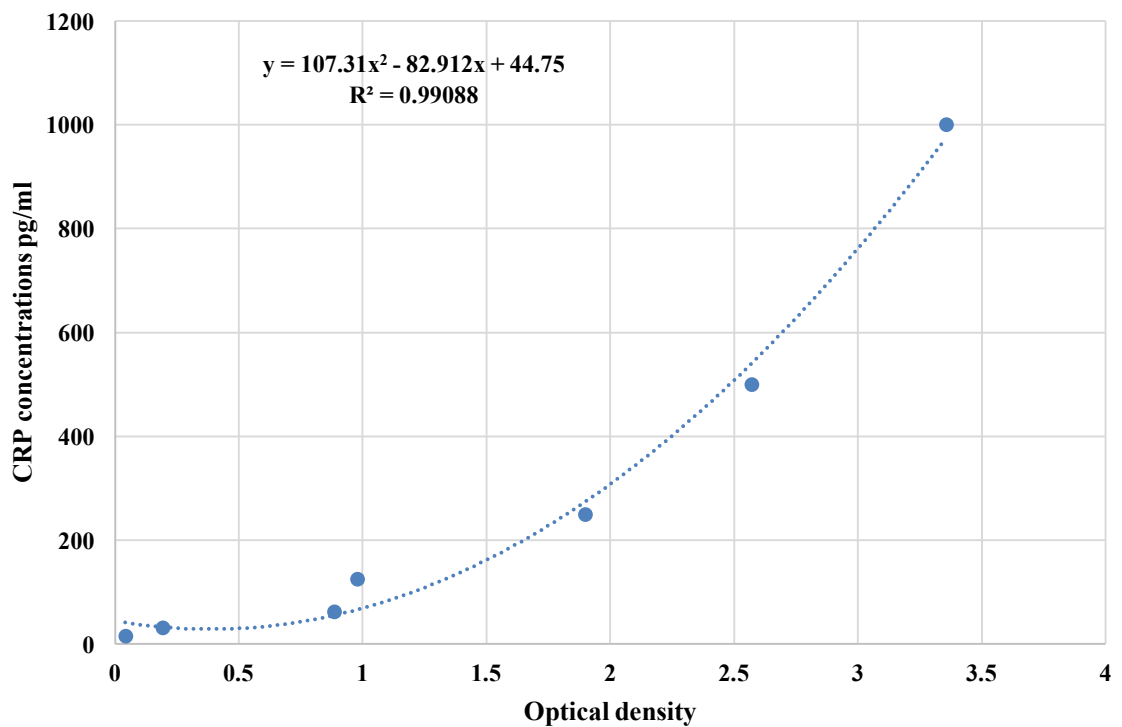

CRP standard curve (ELISA 1) for patients (P21-P40)

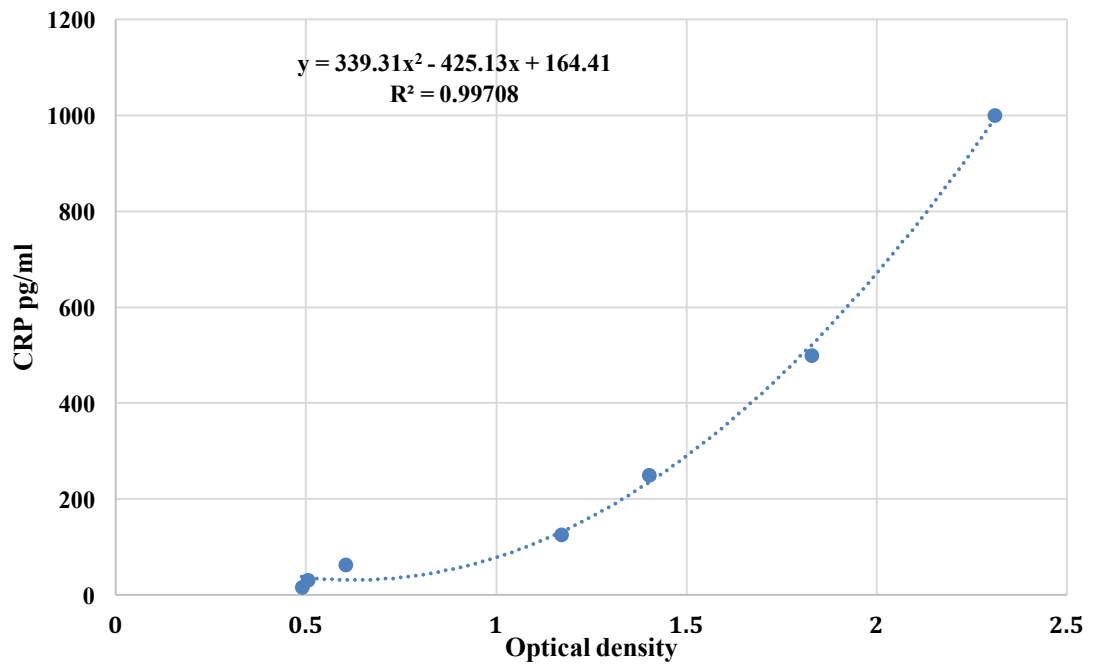

CRP standard Curve (ELISA 2) for patients (P21-P40)

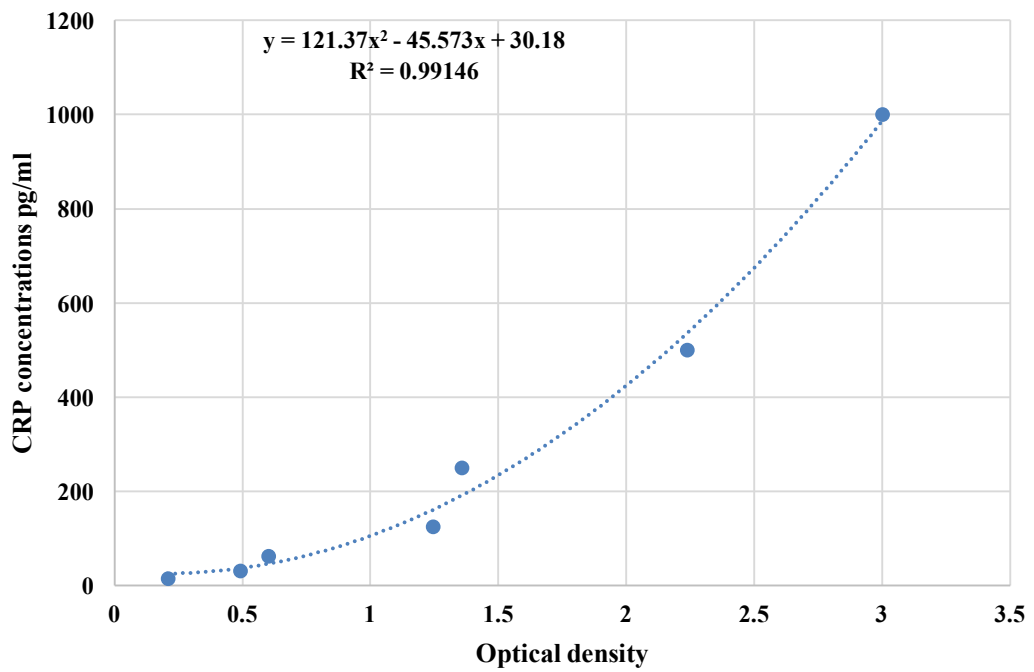

CRP standard curve (ELISA 1) for patients(P41-P52)

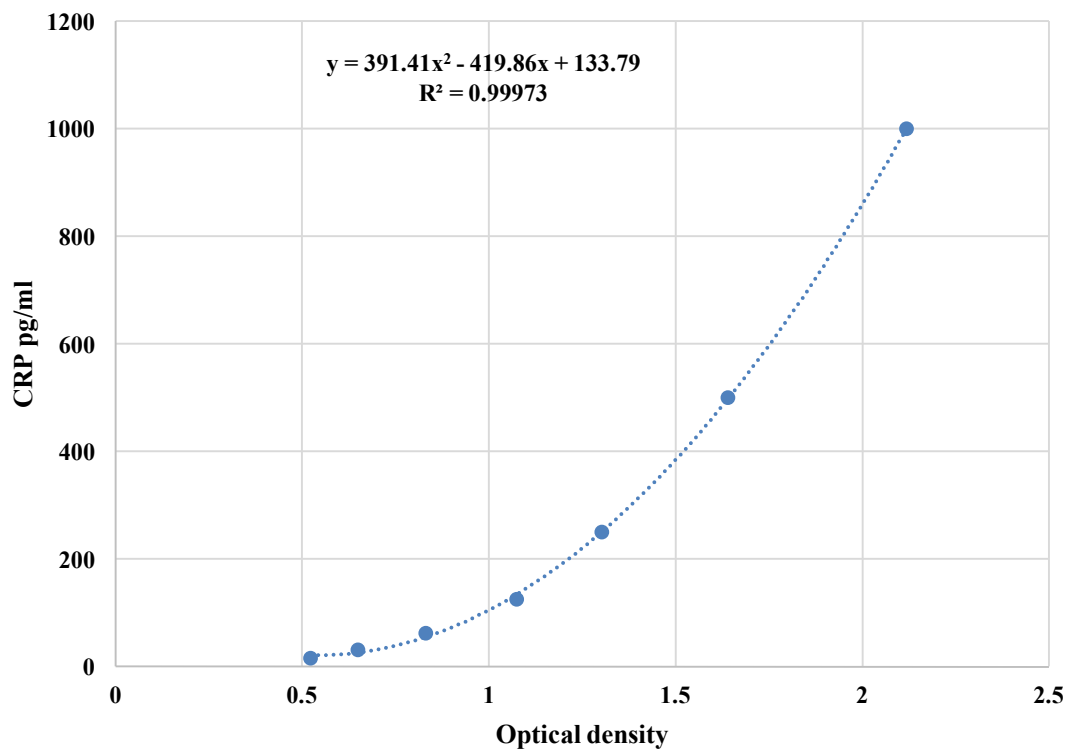

CRP standard Curve (ELISA 2) for patients (P41-P52)





Patient Demographics									
Patients	Gender	Age (years)	Height (cm)	Weight (kg)	BSA (m2)	Blood flow rate (L/min/m2)	BMI	Euroscore (Low , medium and high)	Operation type
1	Male	58	168	83	1.93	4.6	29.4	Low	Heart valve replacement
2	Male	54	172	66	1.78	4.2	22.3	Low	CABG
3	Female	24	160	71	1.74	4.2	22.7	Low	Arterial septal Defect
4	Female	75	169	58	1.66	3.9	20.3	Medium	CABG
5	Male	62	177	86	2.03	4.8	27.4	Low	CABG
6	Male	57	172	92	2.05	4.9	31.1	low	CABG
7	Female	53	167	87	1.96	4.7	31.2	Low	CABG
8	Female	65	159	64	1.66	3.9	25.3	Low	CABG
9	Female	70	168	60	1.68	4	21.3	Low	CABG
10	Male	54	173	80	1.94	4.6	26.7	Low	CABG
11	Male	67	179	87	2.06	4.9	27.2	low	CABG
12	Male	72	166	56	1.62	3.9	20.3	Medium	Ascending aorta graft
13	Male	50	164	80	1.87	4.5	29.7	Low	Heart Valve replacement
14	Male	70	170	96	2.07	5	33.2	Low	CABG
15	Male	65	182	90	2.12	5.1	27.2	Low	CABG
16	Male	36	176	85	2.02	4.8	27.4	Low	CABG
17	Male	41	186	110	2.34	5.6	31.8	Low	CABG
18	Male	49	172	88	2.01	4.8	29.7	Low	CABG
19	Male	52	181	76	1.96	4.7	23.2	Low	CABG
20	Female	37	160	70	1.73	4.1	27.3	Low	Arterial septal Defect
21	Male	73	166	74	1.82	4.3	26.9	Medium	CABG
22	Male	43	181	79	1.99	4.8	24.1	Medium	CABG
23	Male	63	177	68	1.84	4.42	21.7	Low	CABG
24	Male	56	173	83	1.97	4.7	27.7	Low	Ascending aorta graft
25	Female	79	153	70	1.68	4	29.9	Medium	CABG
26	Female	65	169	60	1.69	4.1	21	Medium	CABG
27	Male	59	171	94	2.06	4.9	32.1	Low	CABG
28	Male	54	165	89	1.96	4.7	32.7	Low	CABG
29	Female	63	153	80	1.77	4.2	34.2	Low	CABG
30	Male	65	172	61	1.72	4.1	20.6	Low	CABG
31	Male	65	174	73	1.87	4.5	24.1	Low	CABG
32	Male	65	177	103	2.2	5.3	32.9	Low	CABG
33	Female	59	171	84	1.96	4.7	28.7	High	Thoracic and arcus aorta replacement
34	Male	68	152	78	1.75	4.2	33.8	low	Heart valve replacement
35	Male	41	175	80	1.96	4.7	26.1	Low	CABG
36	Female	68	149	75	1.69	4.1	33.8	Medium	CABG
37	Female	61	170	80	1.92	4.6	27.7	Medium	Heart valve replacement
38	Female	66	163	74	1.8	4.3	27.9	low	CABG
39	Male	77	169	63	1.72	4.1	22.1	Low	CABG
40	Male	59	166	72	1.8	4.3	26.1	Low	CABG
41	Male	61	170	84	1.96	4.7	29.1	Medium	CABG
42	Male	55	173	86	2	4.8	28.7	Low	CABG
43	Male	67	150	66	1.61	3.9	29.3	Medium	Ascending Aorta graft
44	Male	52	156	54	1.52	3.6	22.2	Low	CABG
45	Male	69	170	89	2	4.8	30.8	Medium	Heart valve replacement
46	Female	41	168	96	2.05	4.9	34	low	CABG
47	Male	55	168	77	1.87	4.5	27.3	Low	CABG
48	Male	40	173	70	1.83	4.4	23.4	low	CABG
49	Female	65	170	63	1.73	4.1	21.8	Medium	CABG
50	Male	52	147	82	1.74	4.2	37.9	Low	CABG
51	Female	55	166	76	1.84	4.4	27.6	low	CABG
52	Male	60	157	64	1.64	3.9	26	low	CABG

Patients demographic data.

Cardiopulmonary bypass parameters				
Patients	Aortic cross clamping time (min)	CPB time (min)	Patient temperature during the surgery (°C)	Volume of fluid transfused during CPB (ml)
1	71	98	30	1700
2	60	87	30	1680
3	44	65	30	2320
4	61	85	30	2100
5	86	119	35	2020
6	67	89	32	1692
7	61	105	36.8	2901
8	105	268	37	2446
9	76	154	36.7	2341
10	72	163	36.7	1809
11	24	35	36.2	1700
12	98	178	36.8	2233
13	54	107	36.7	2258
14	88	130	36.8	1671
15	54	97	36.7	2279
16	63	130	37.2	2011
17	75	178	35.9	2463
18	66	123	35	1908
19	80	189	34.1	1844
20	42	60	30	900
21	71	127	34.7	1703
22	103	177	35.7	1833
23	80	143	35.9	2684
24	204	268	37	1875
25	63	102	35.4	2332
26	59	123	35.4	1836
27	94	223	32	2281
28	103	125	29	800
29	81	171	32	1678
30	73	121	30	1000
31	92	161	36.4	2362
32	85	128	35.6	1671
33	269	496	20	1200
34	173	230	35	2018
35	47	95	35.4	2071
36	63	117	25	2246
37	131	234	37	2840
38	35	53	32	1823
39	83	141	36	2751
40	72	143	37	1800
41	70	155	36.4	1526
42	51	121	36.8	1300
43	143	208	36.3	2221
44	86	147	36	1500
45	34	68	37	1000
46	73	122	34	1821
47	103	137	30	900
48	39	92	35	1700
49	78	82	37	2100
50	34	94	35	1600
51	36	104	34	1760
52	53	99	36	2034

Patients' CPB parameters during the surgery

## Appendix I: FTIR absorbances for all patients' samples

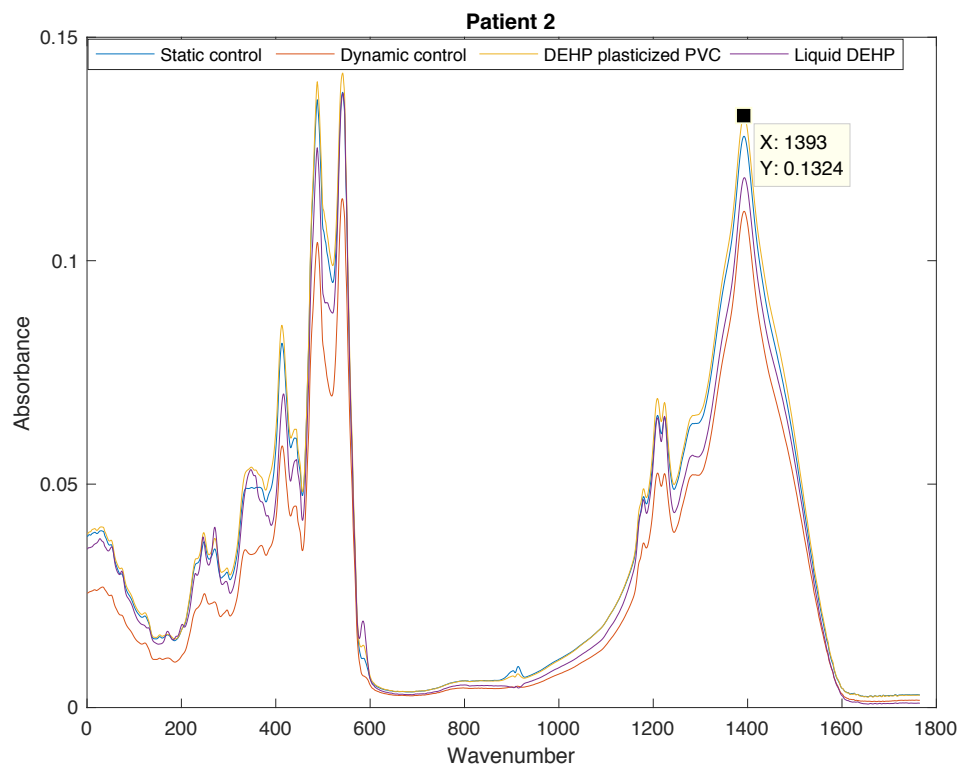
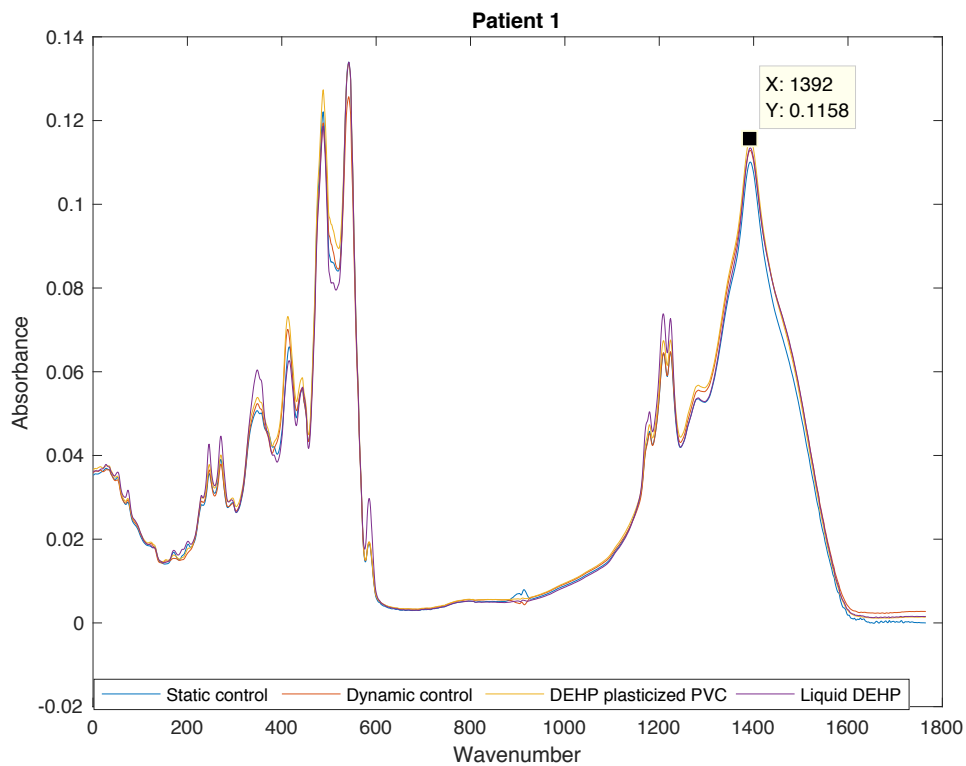

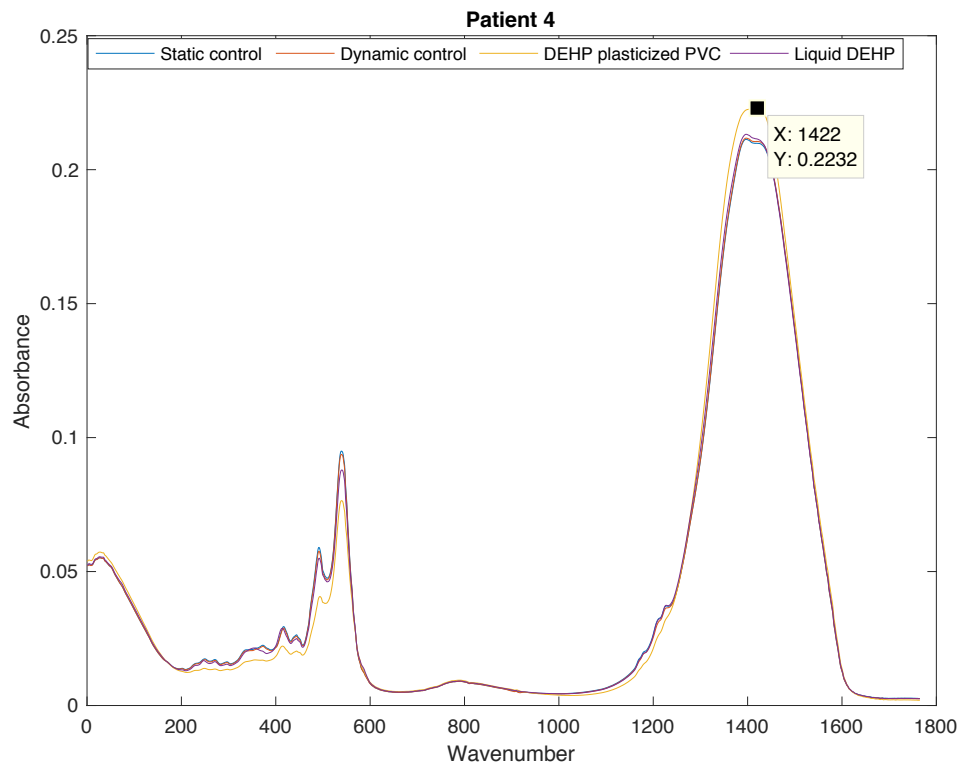
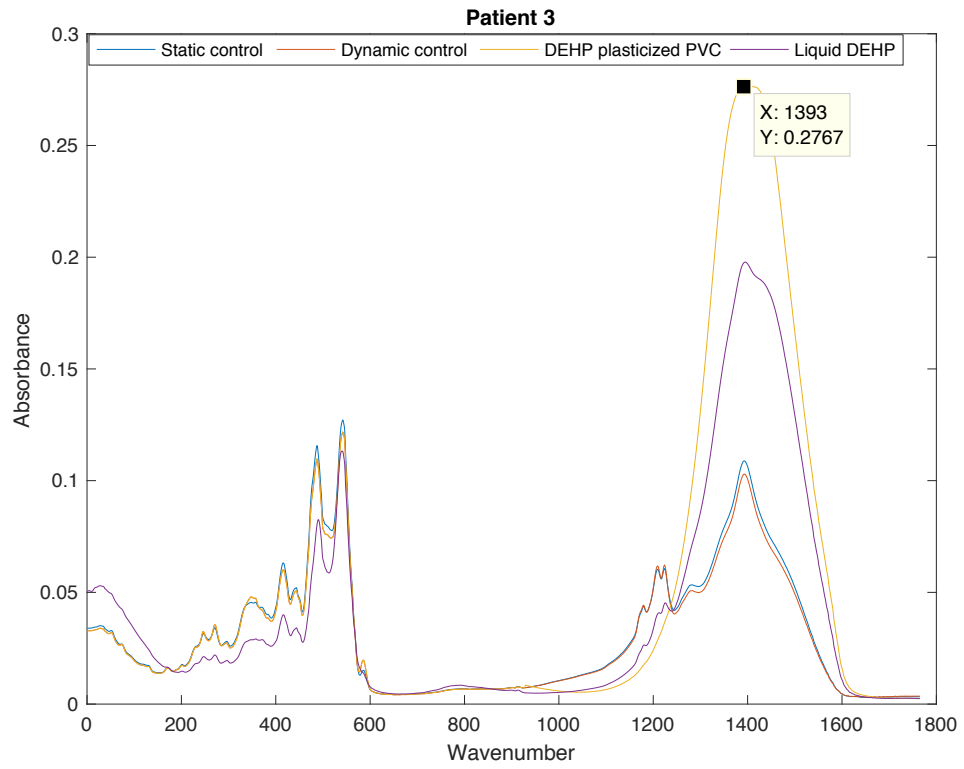

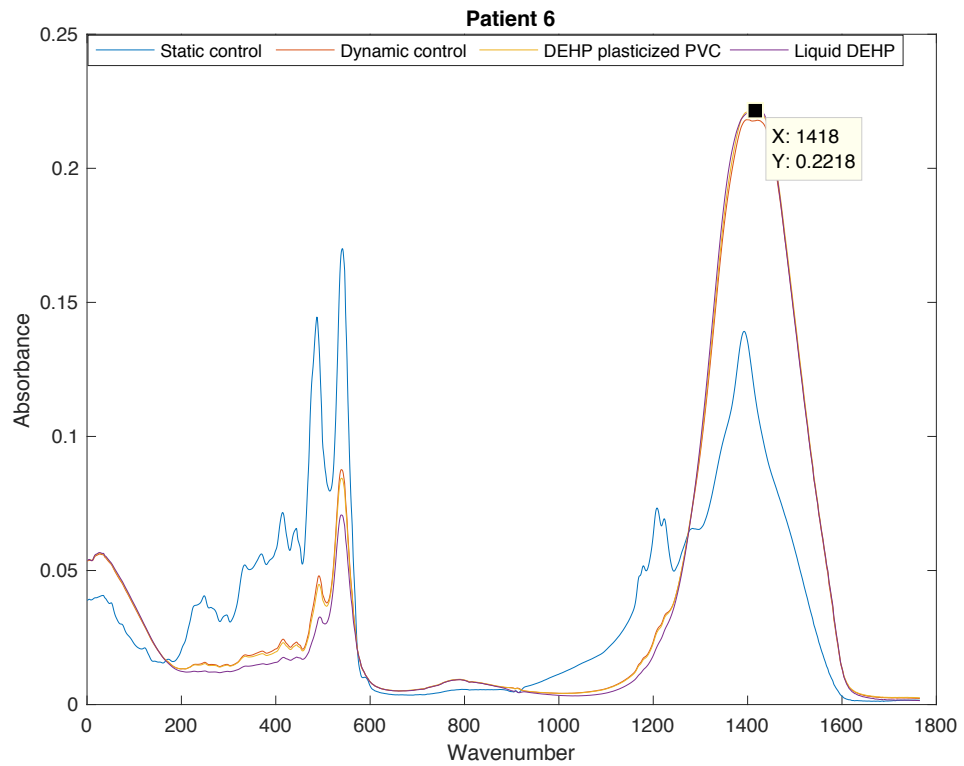
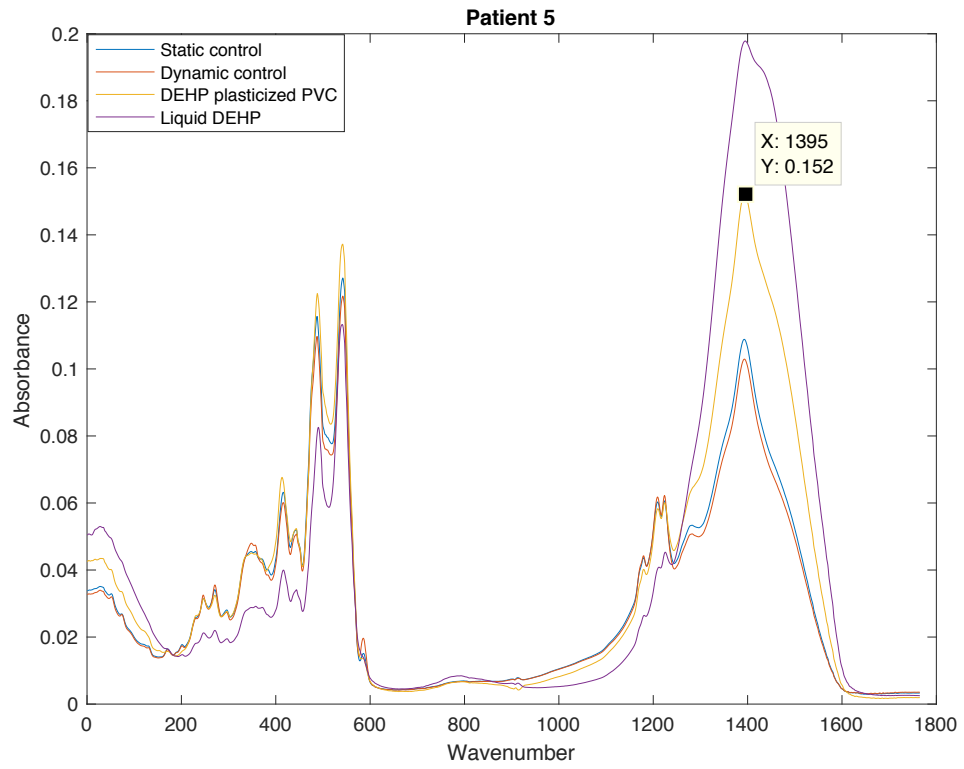

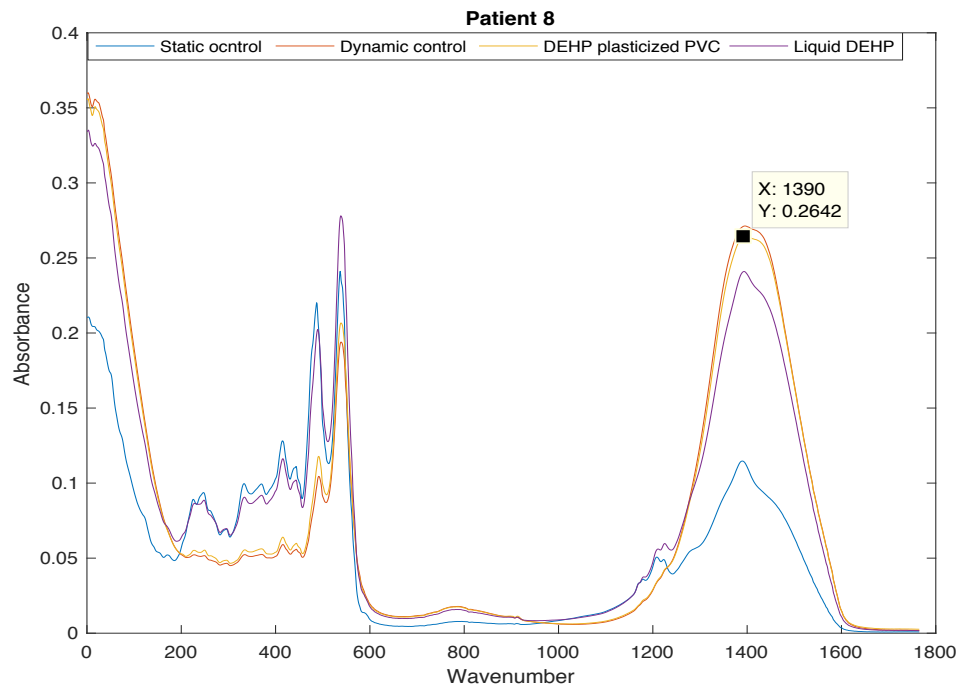
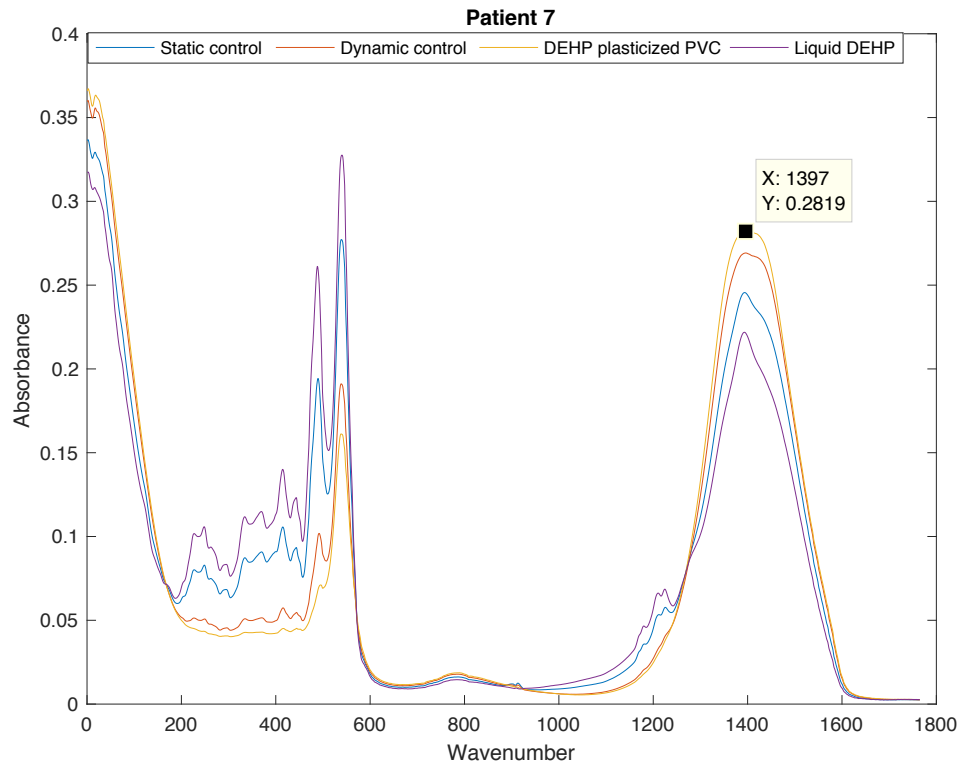

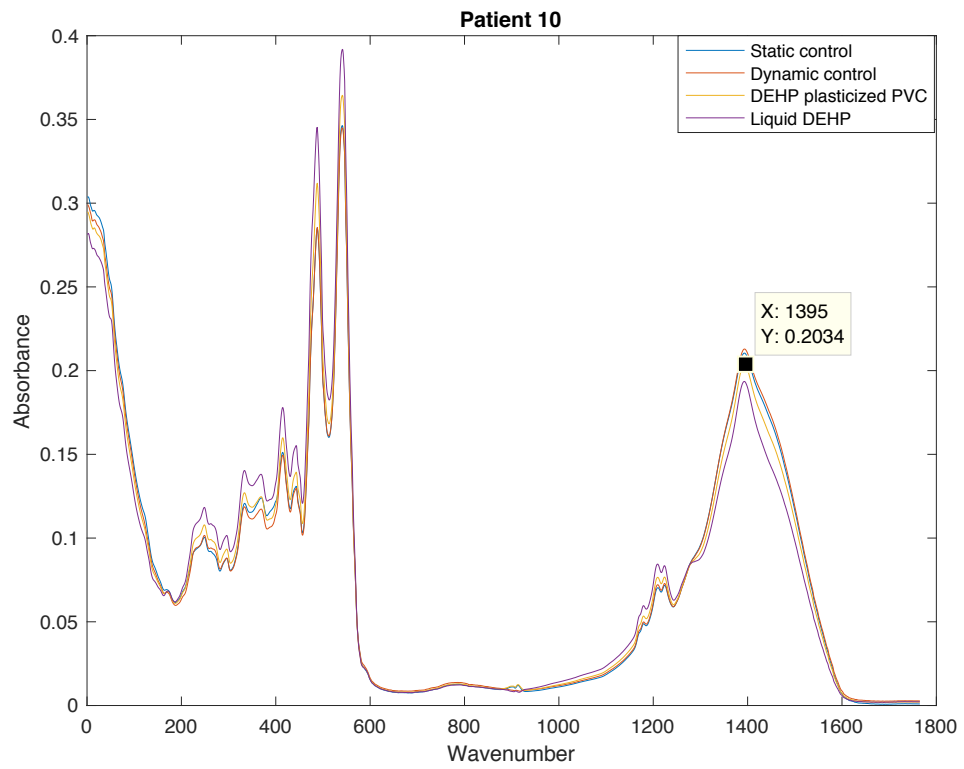
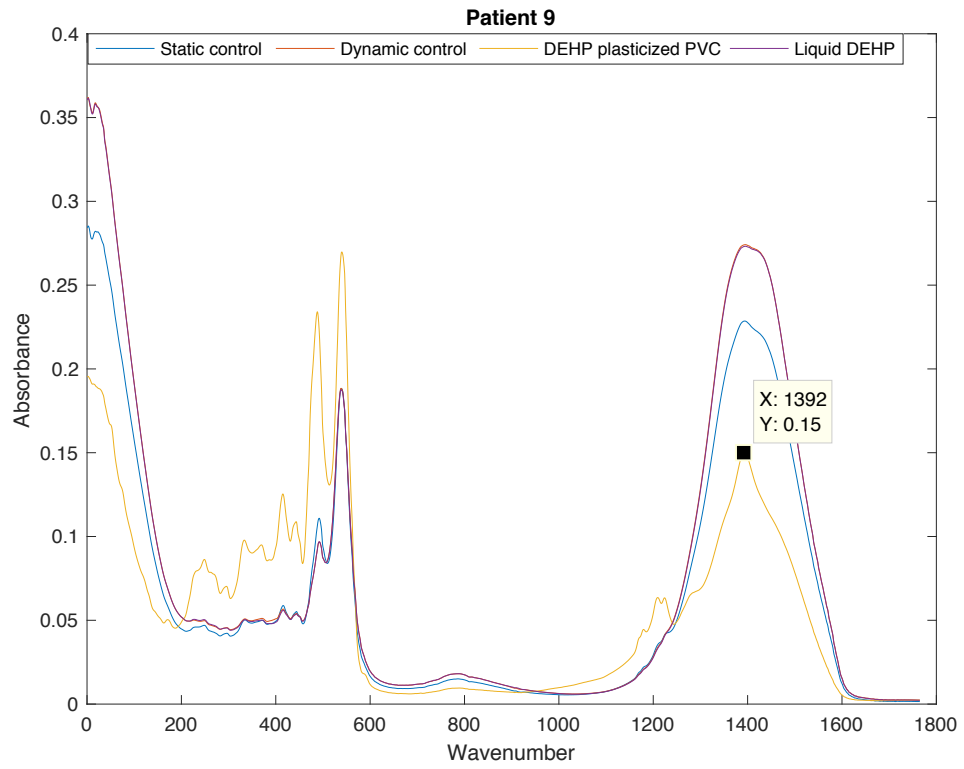



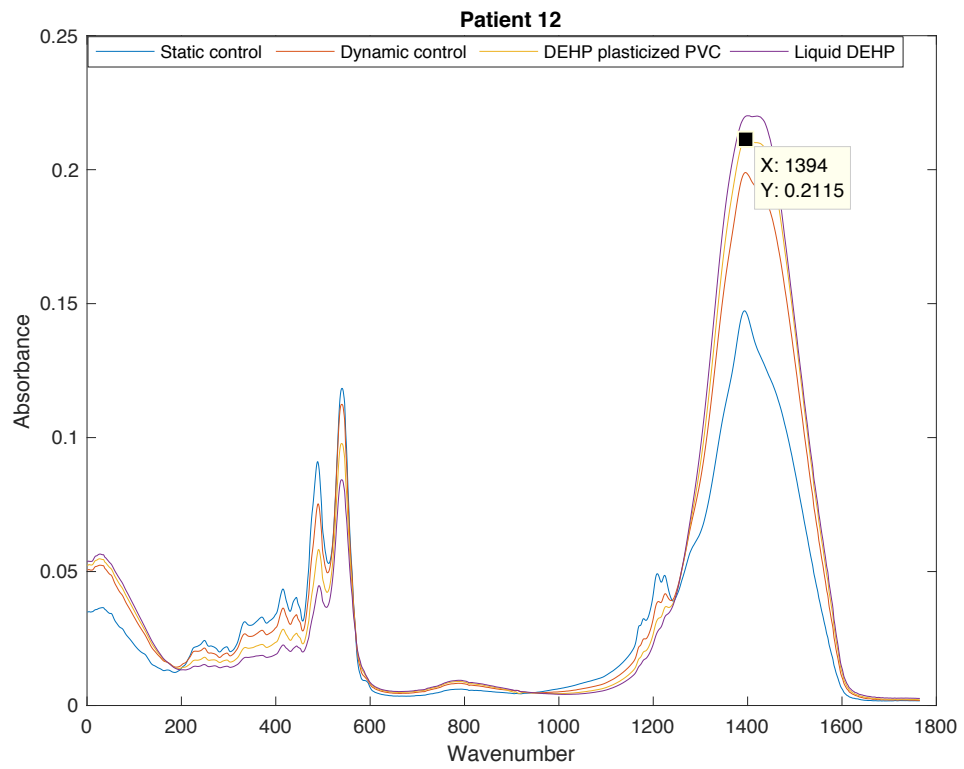
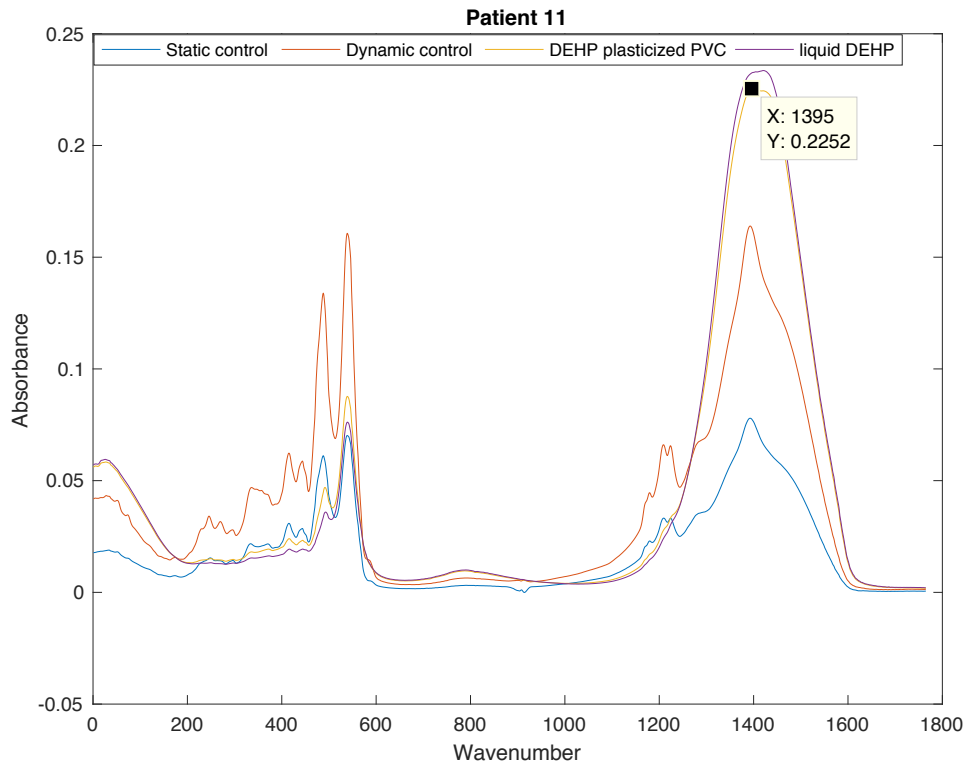

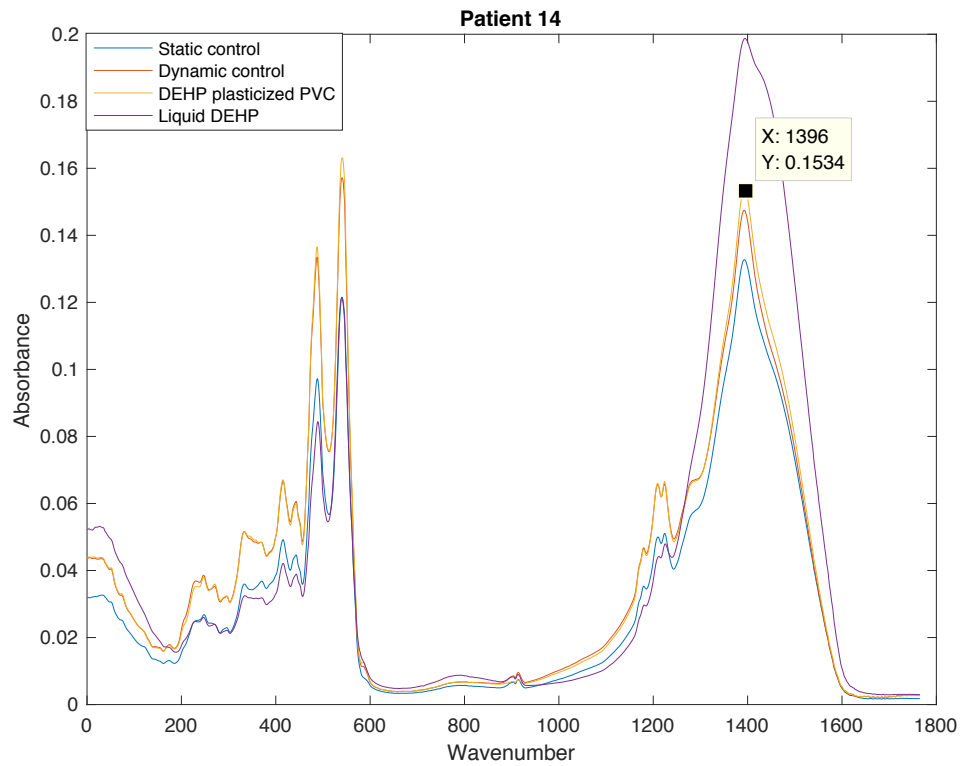
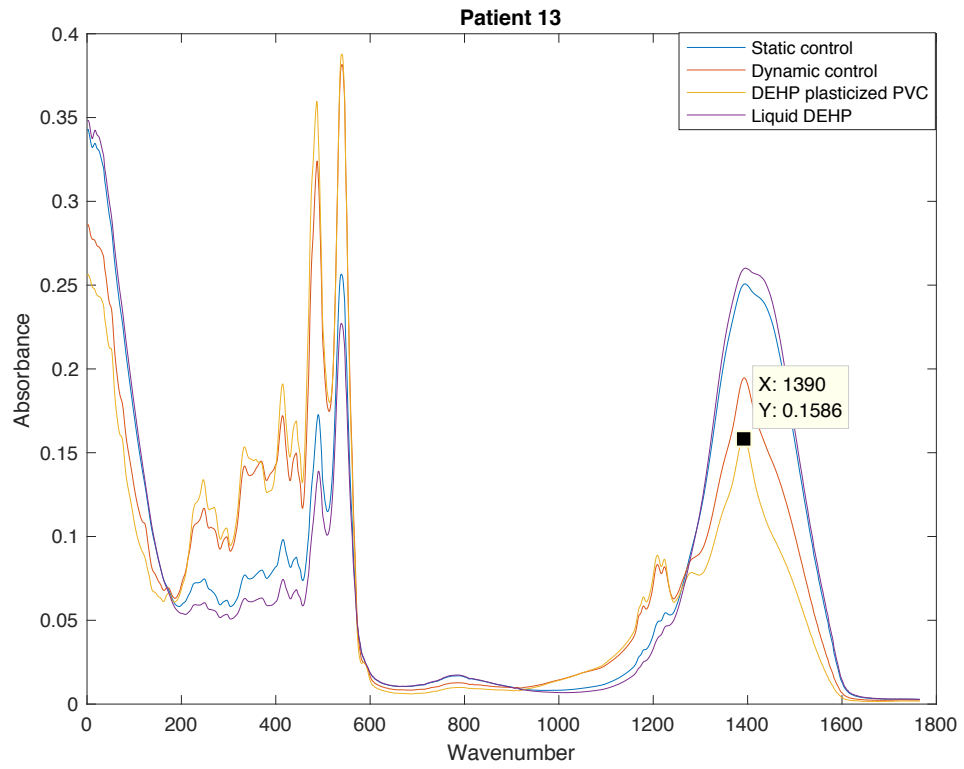

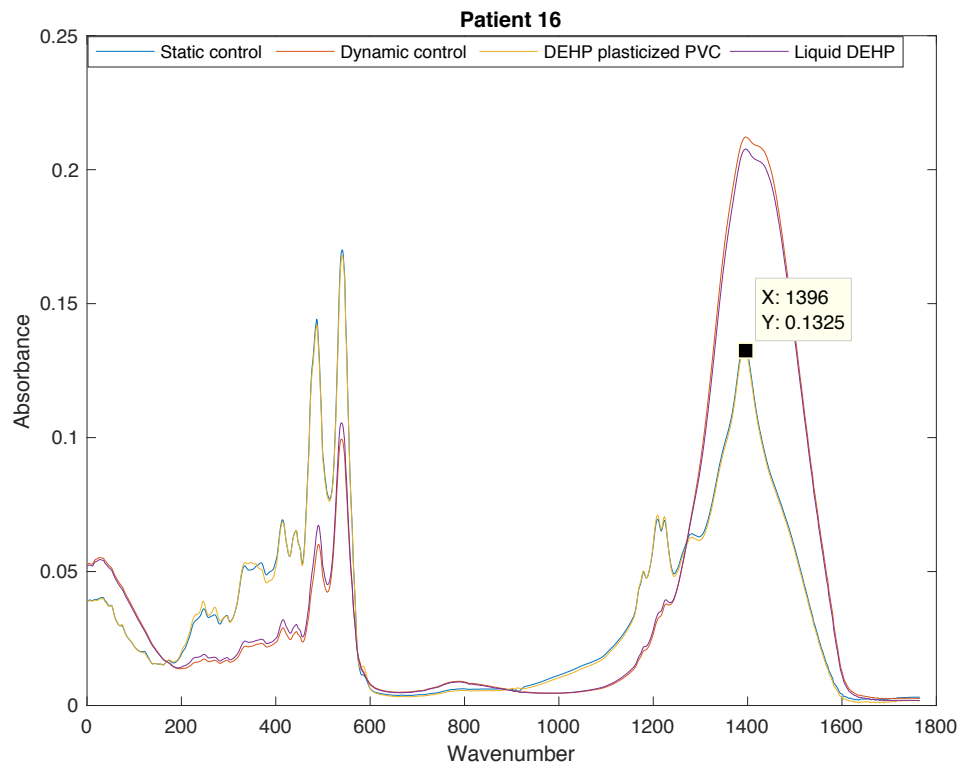
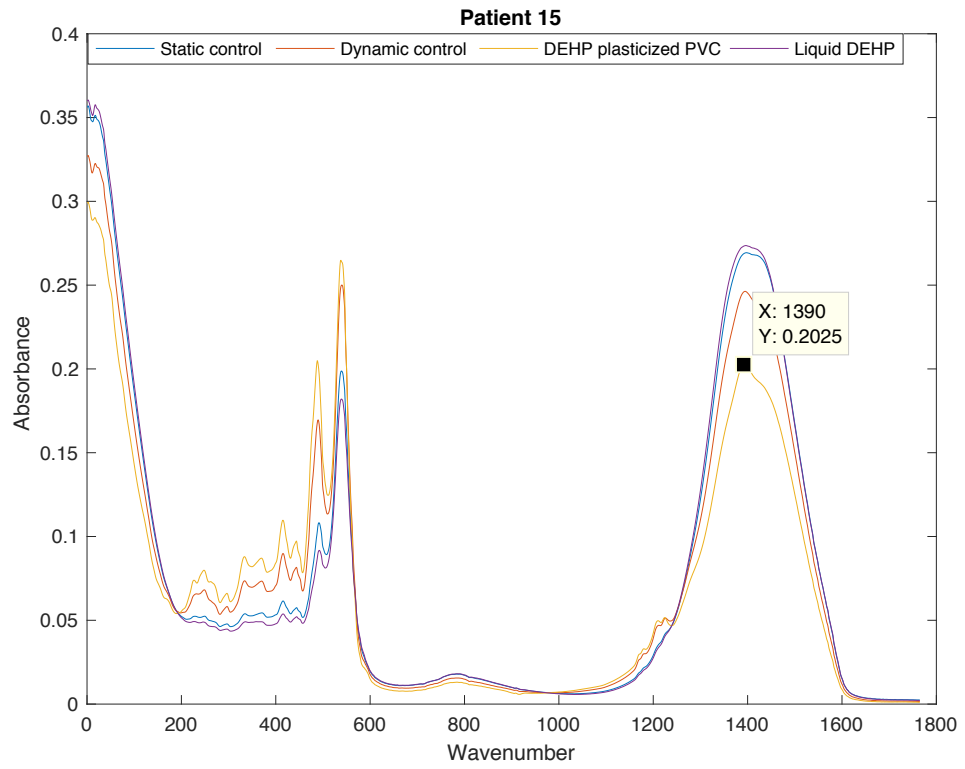

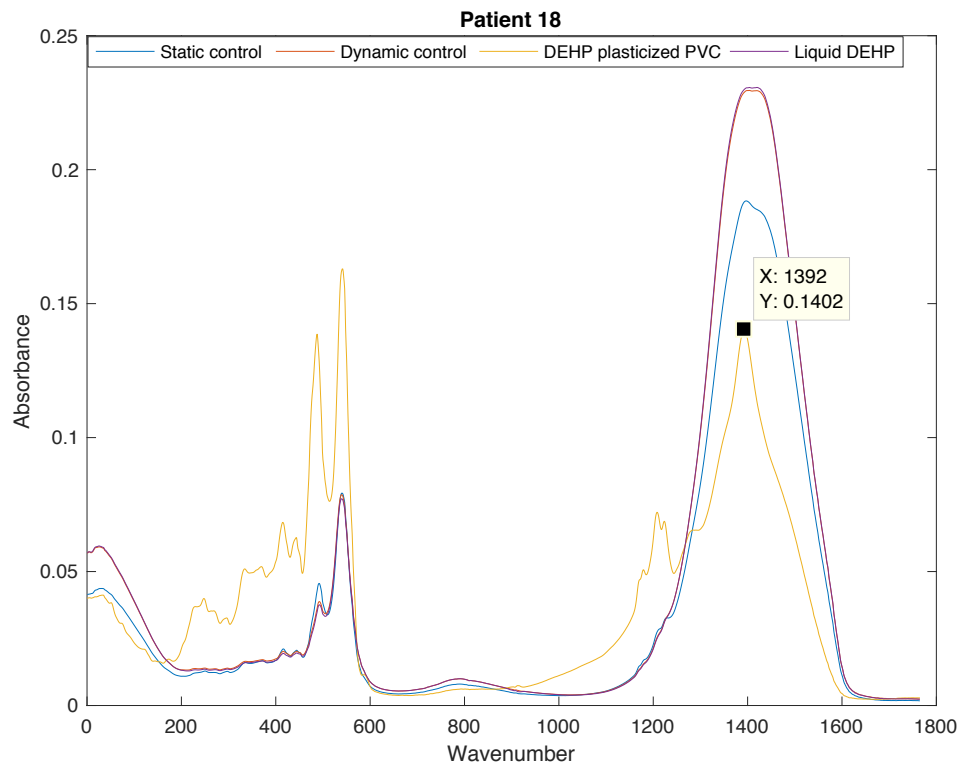
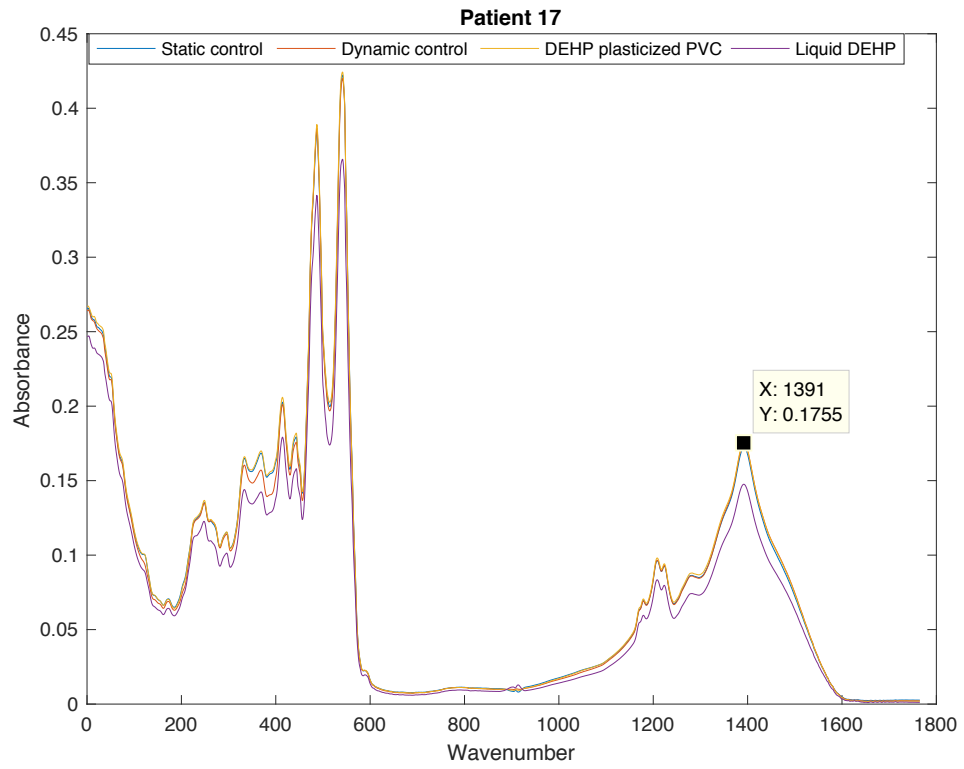

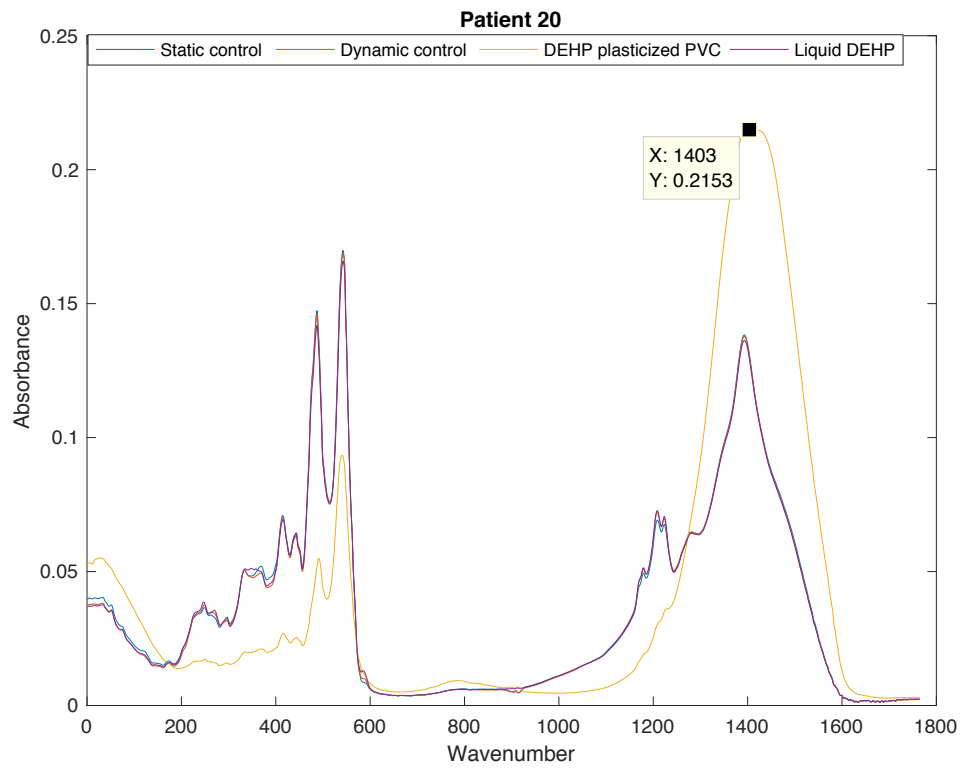
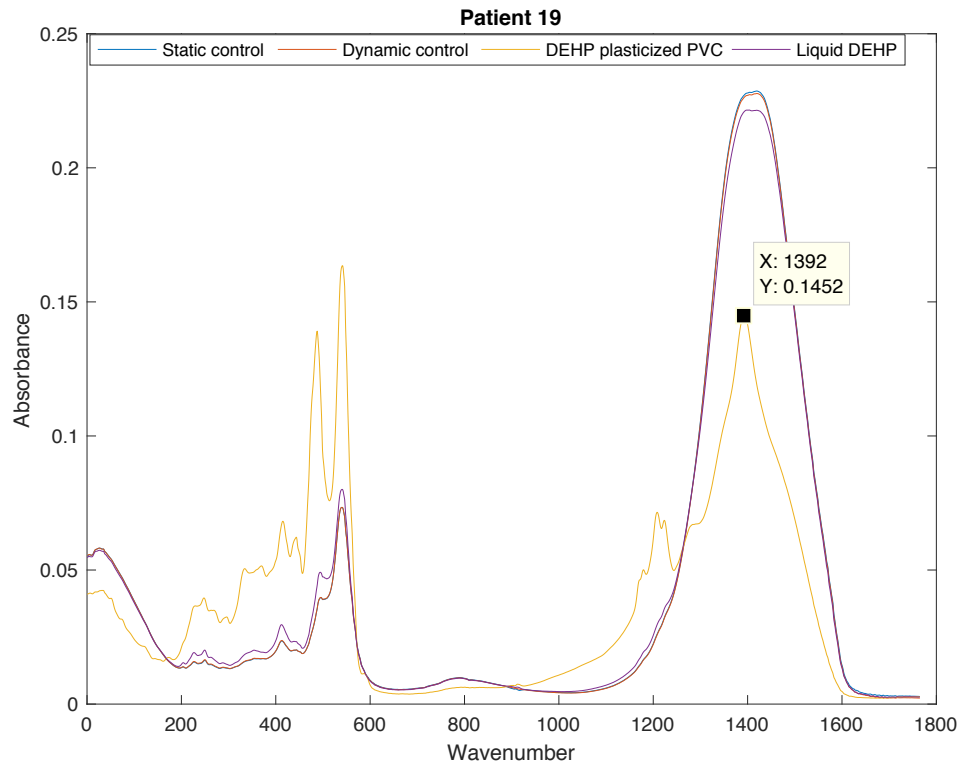

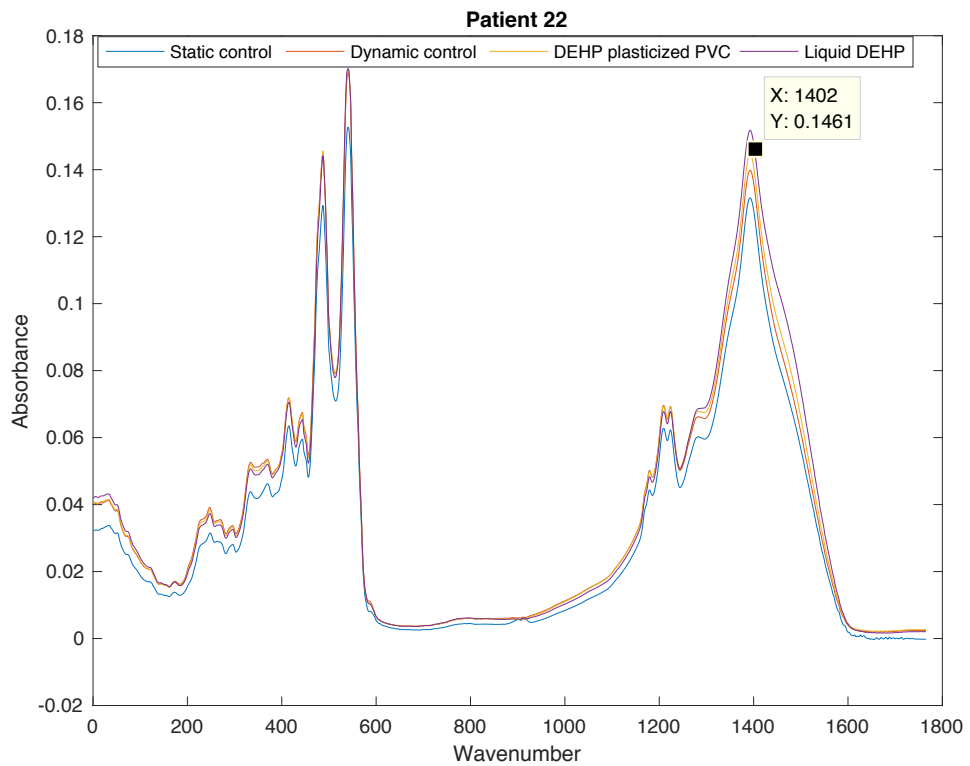
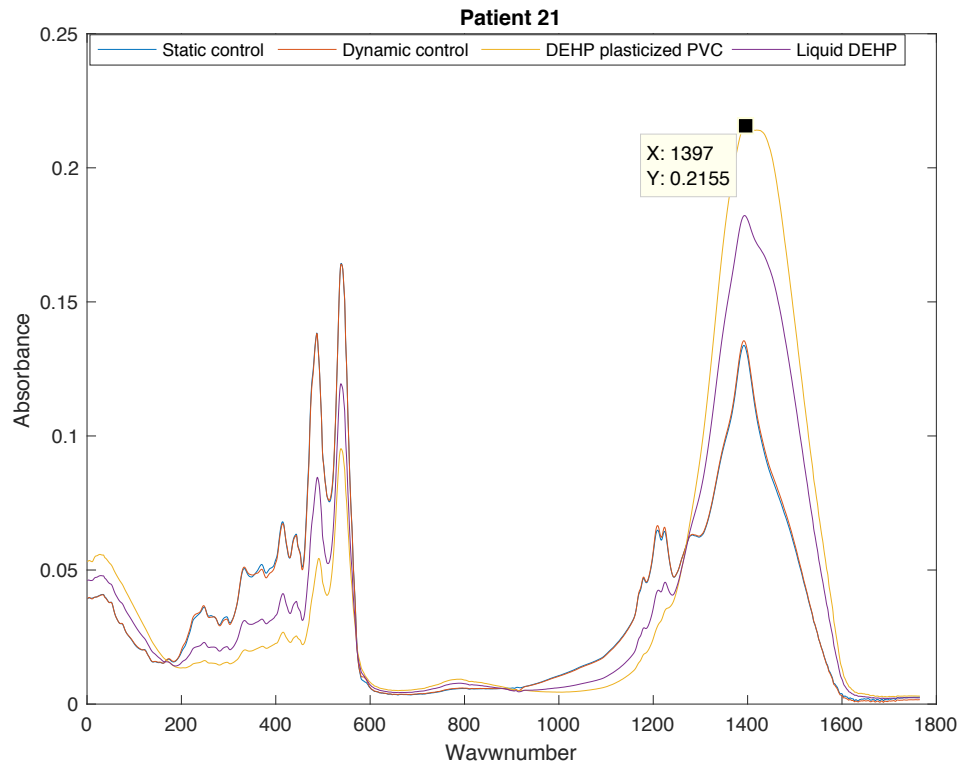

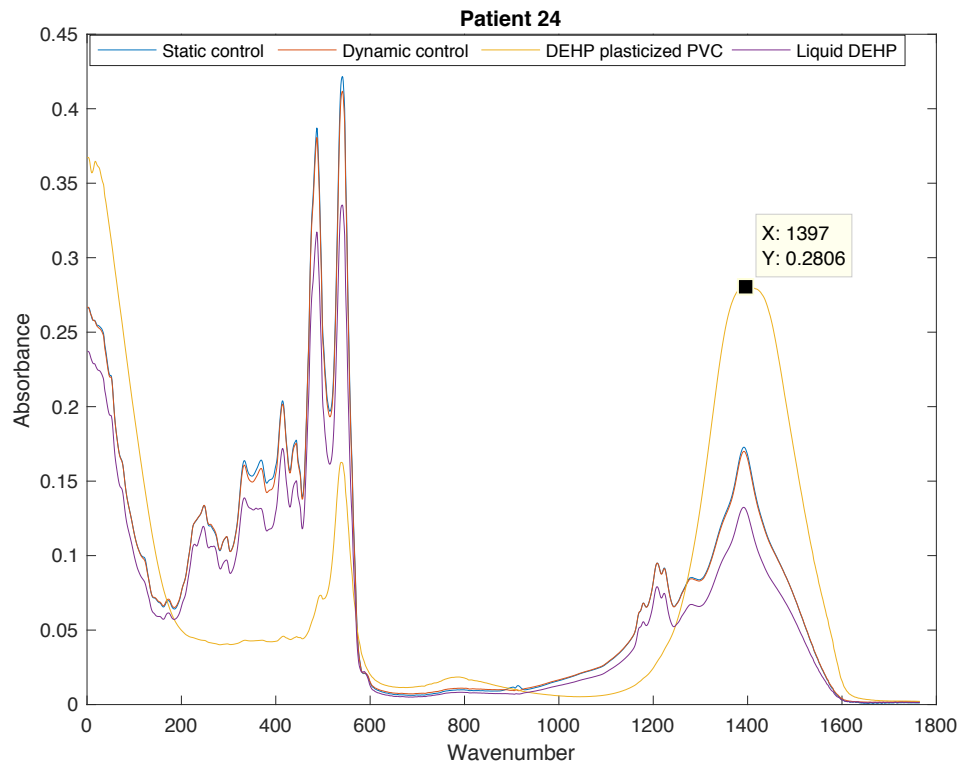
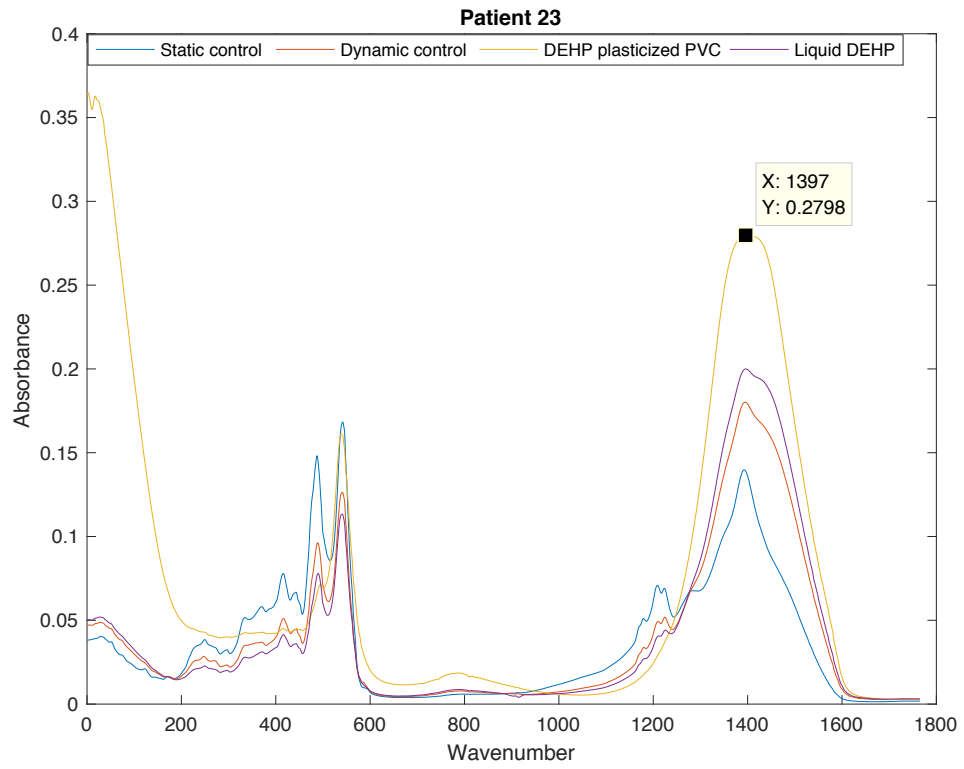

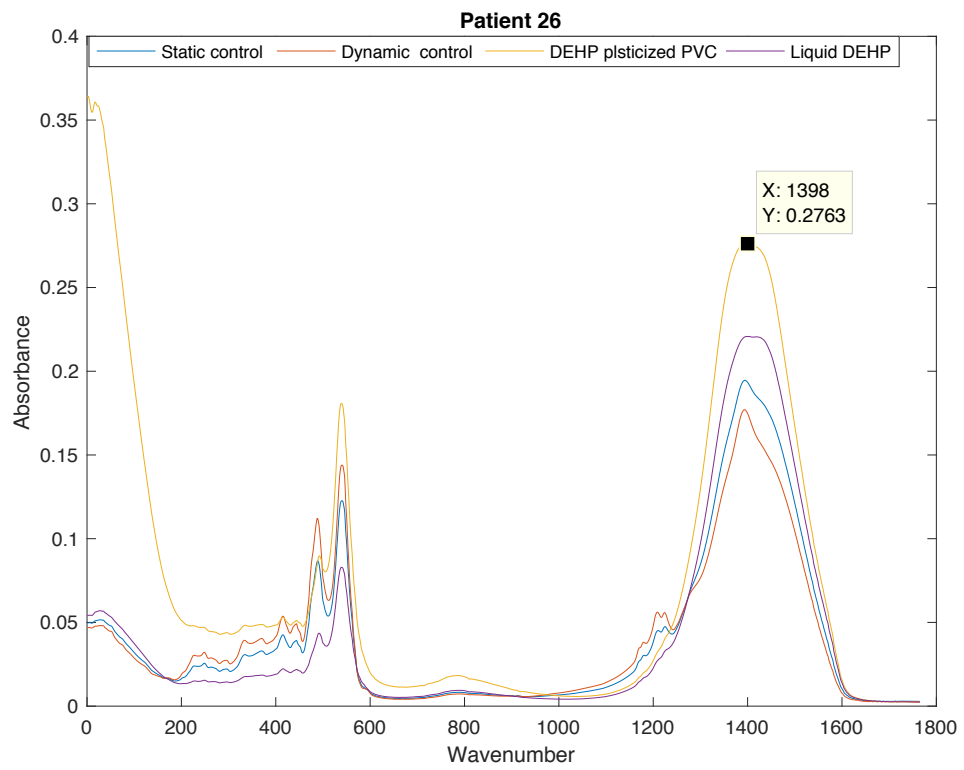
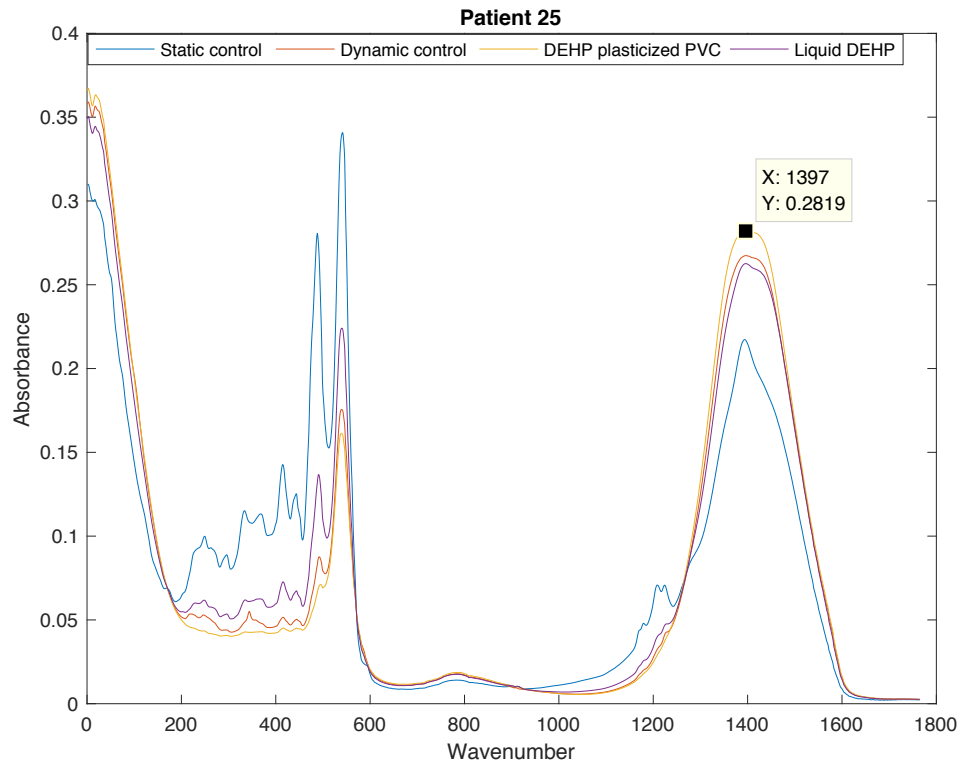



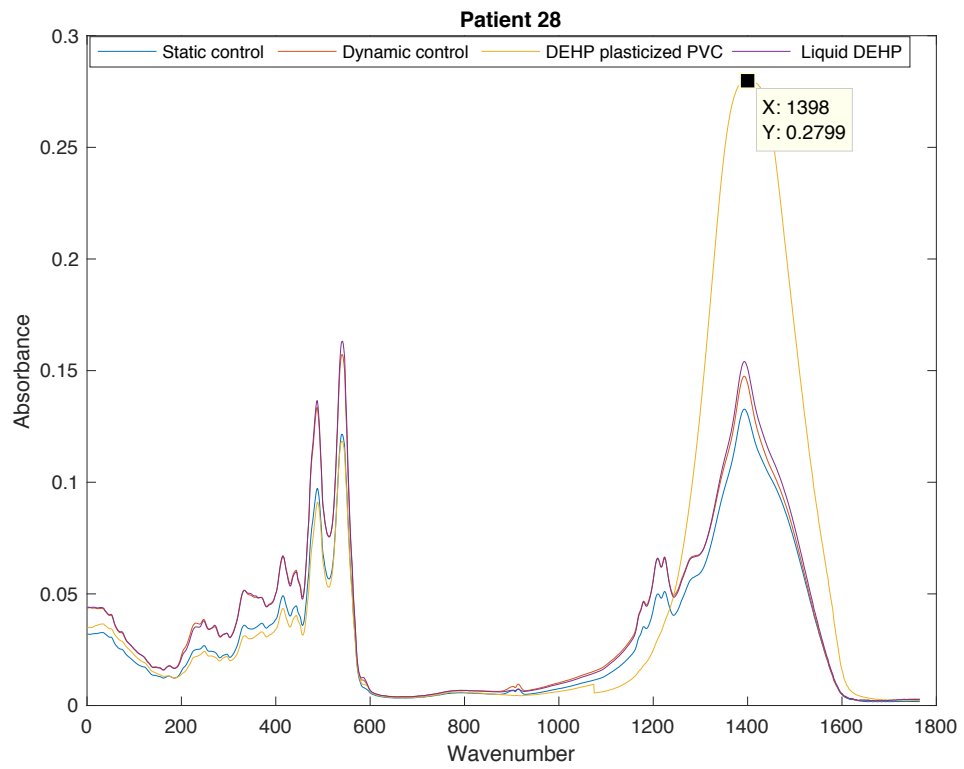
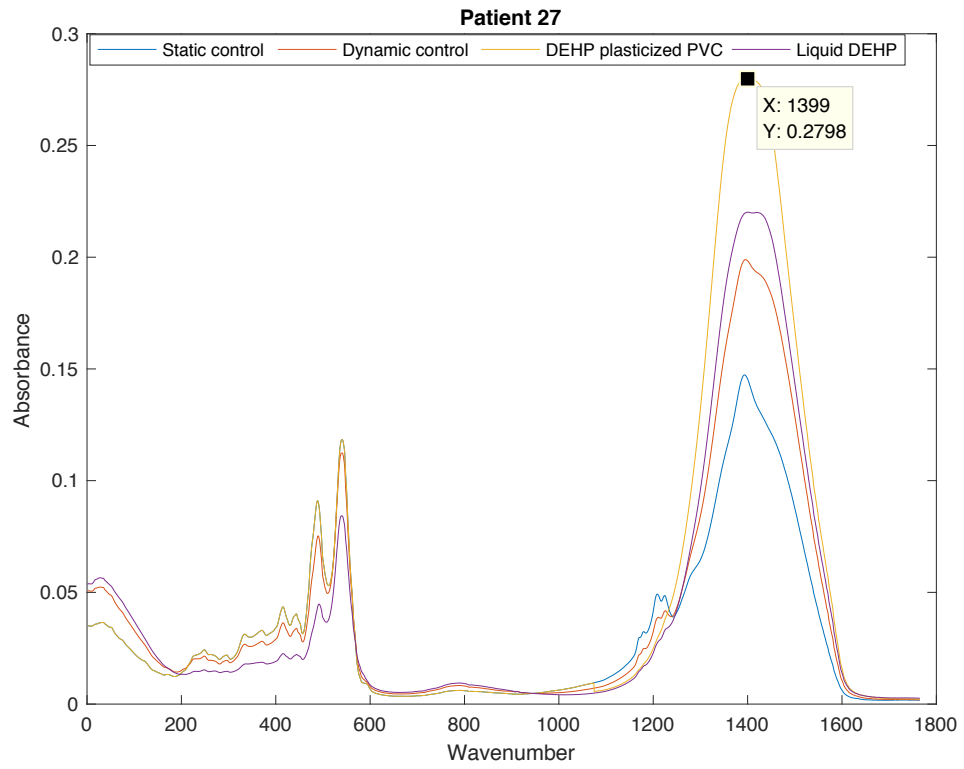

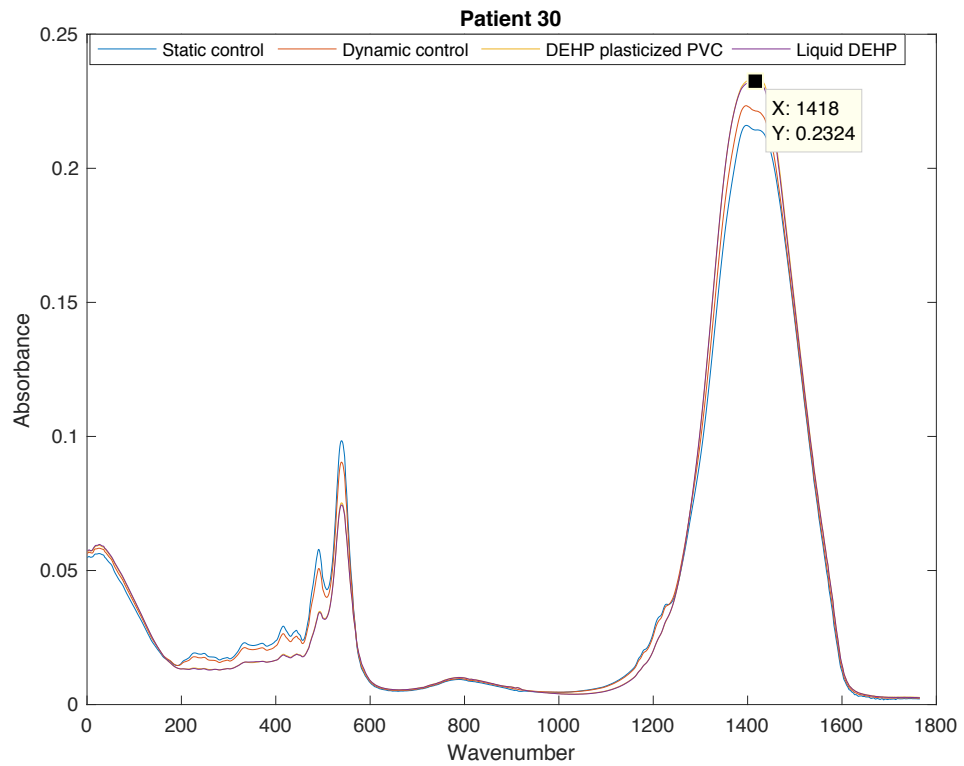
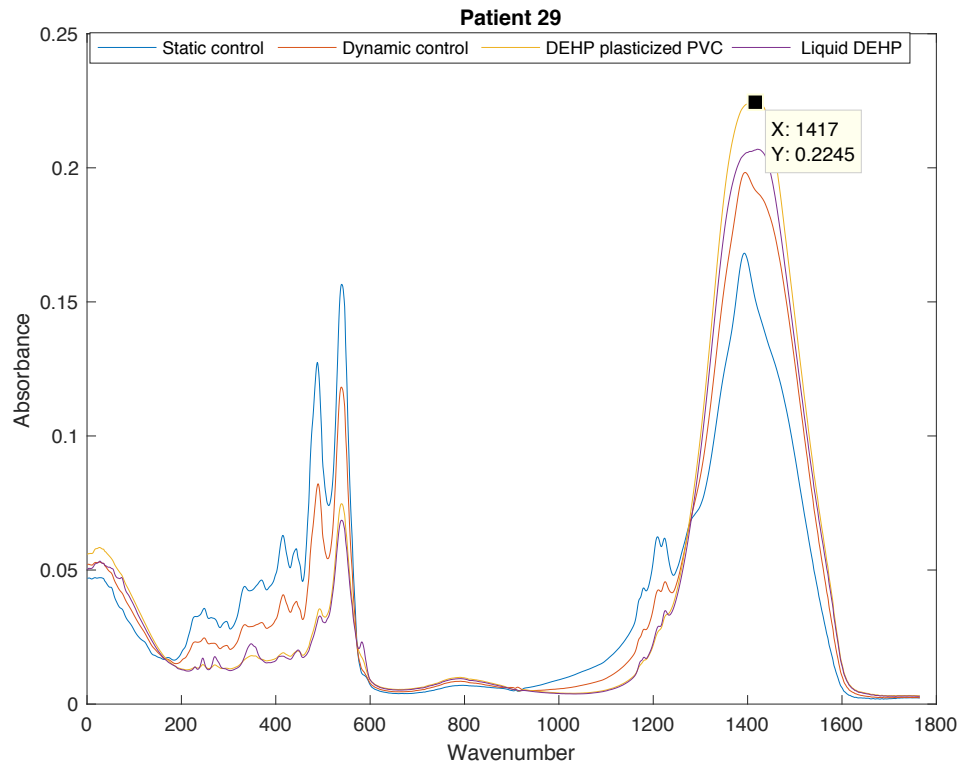

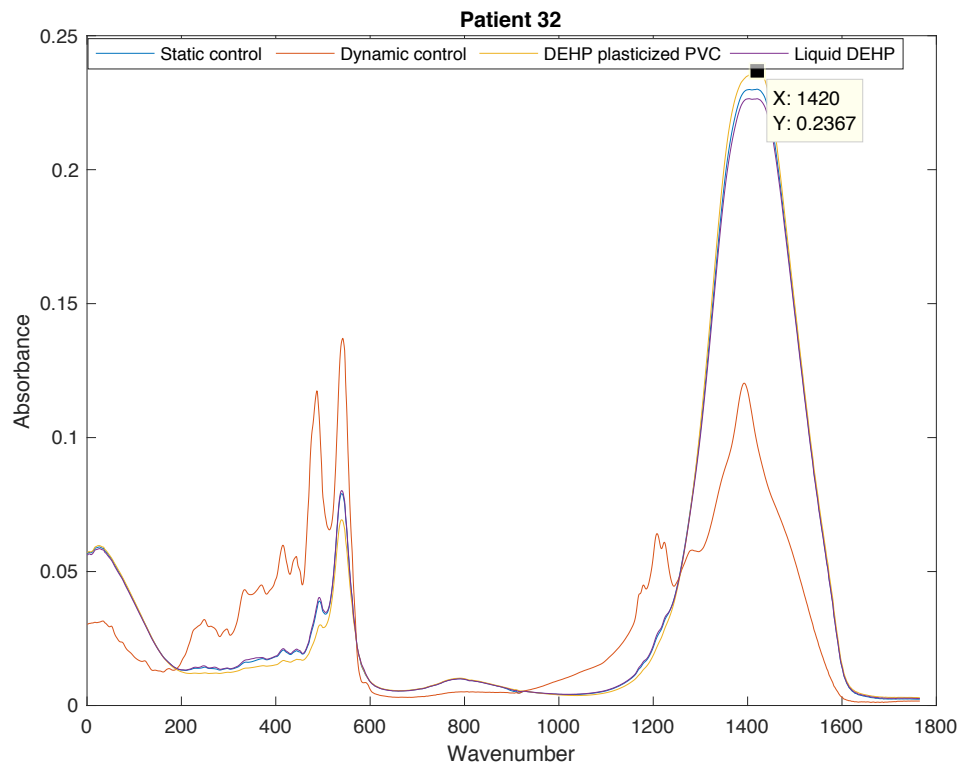
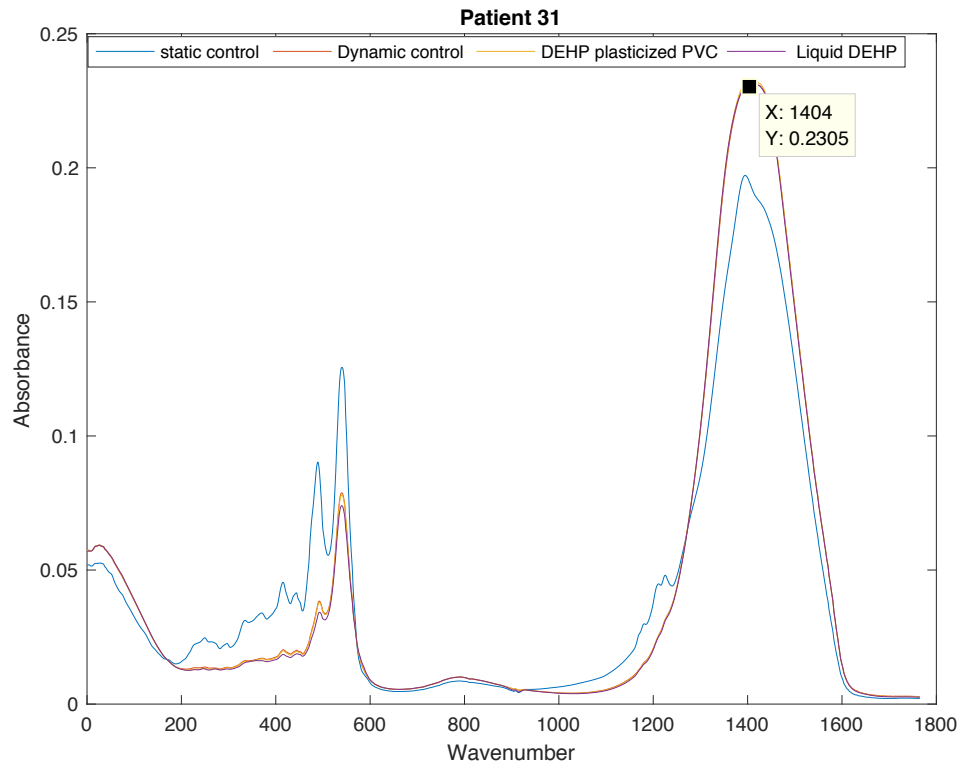

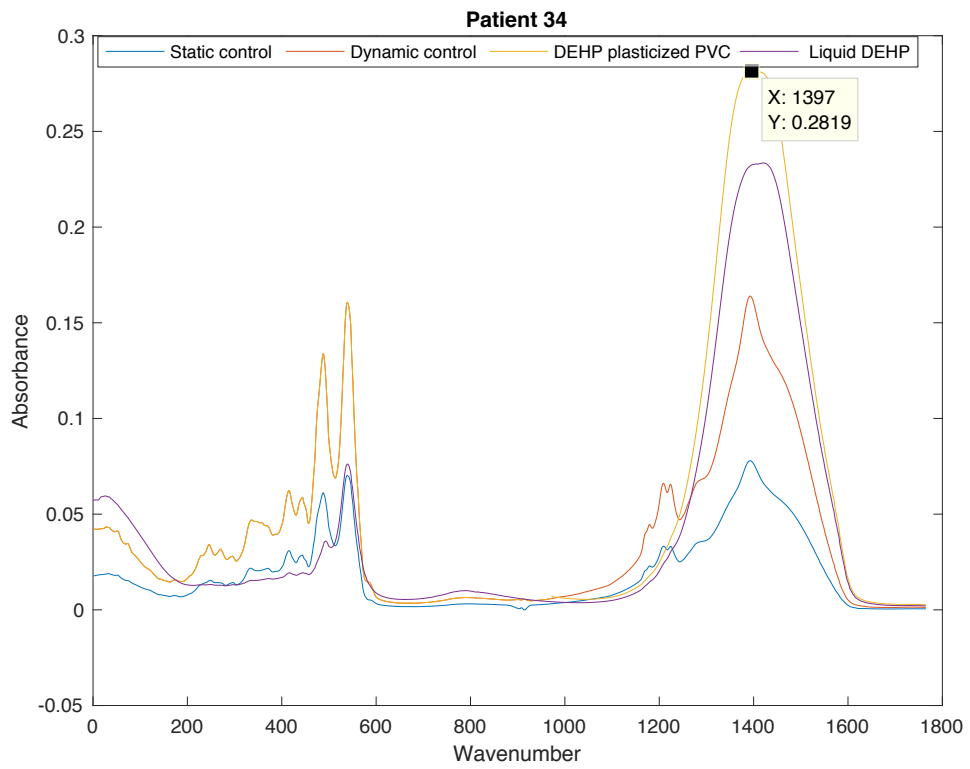
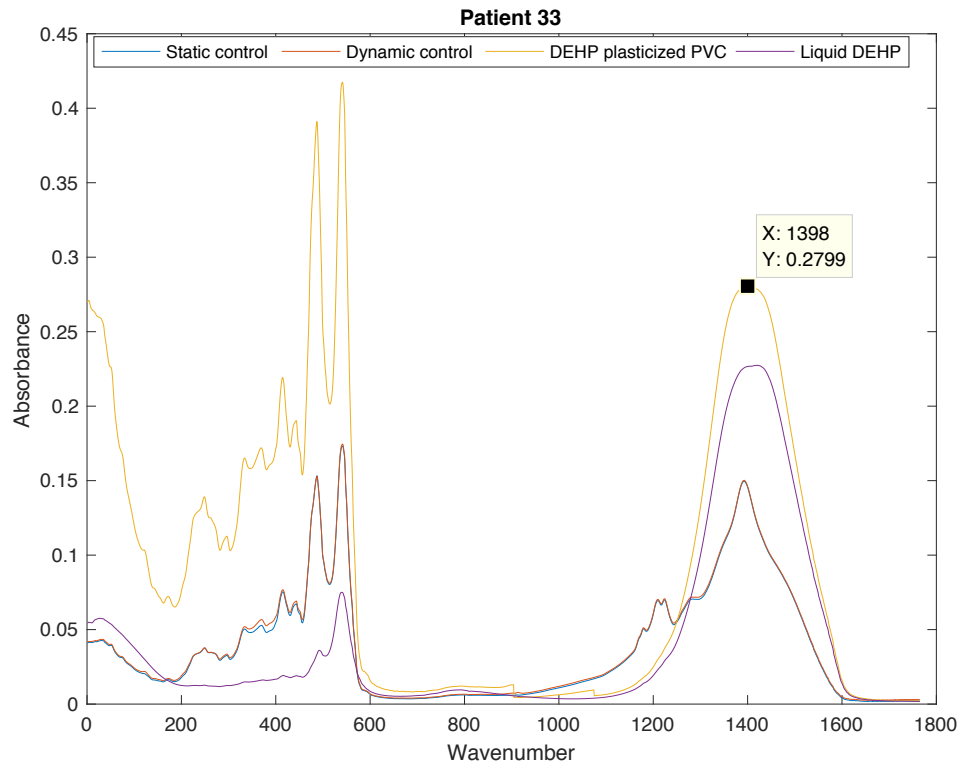

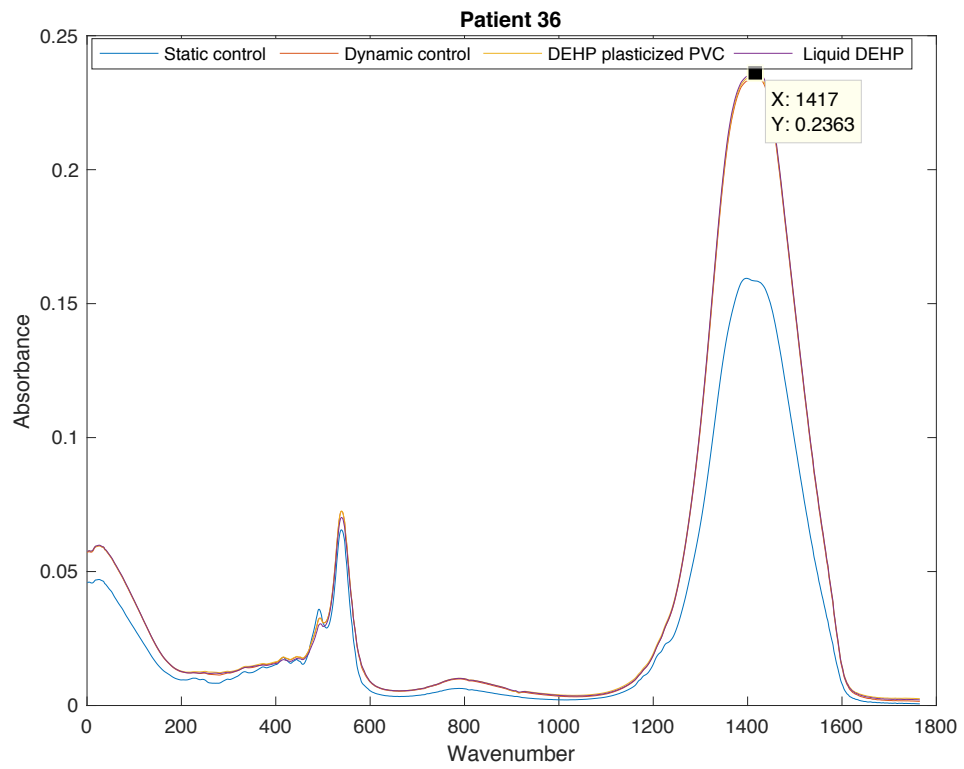
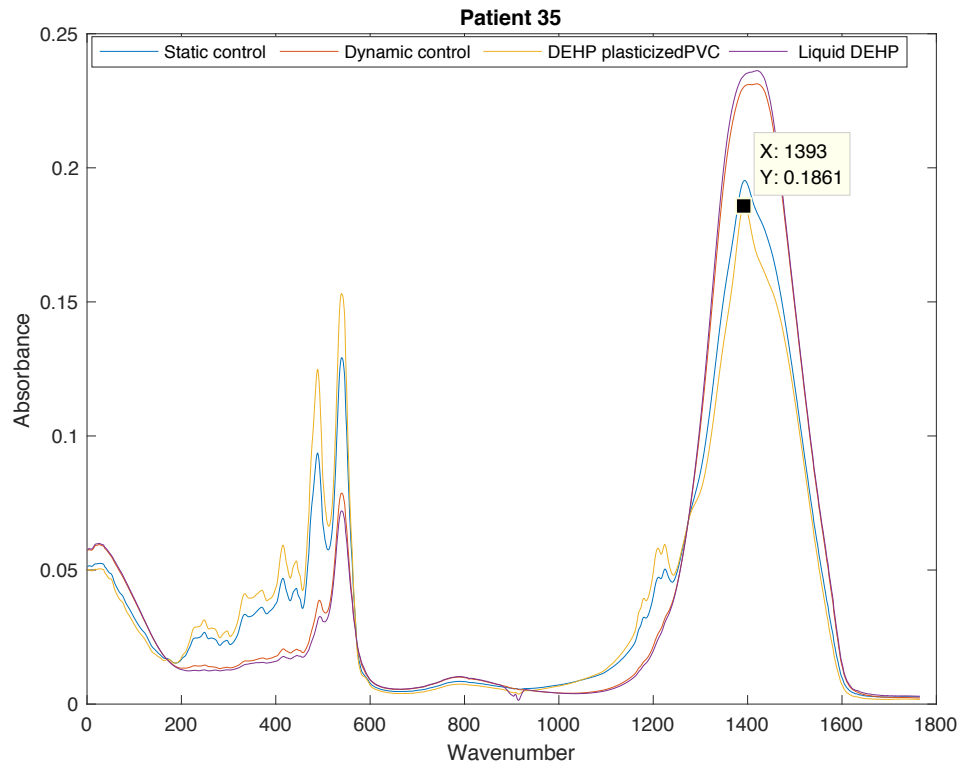

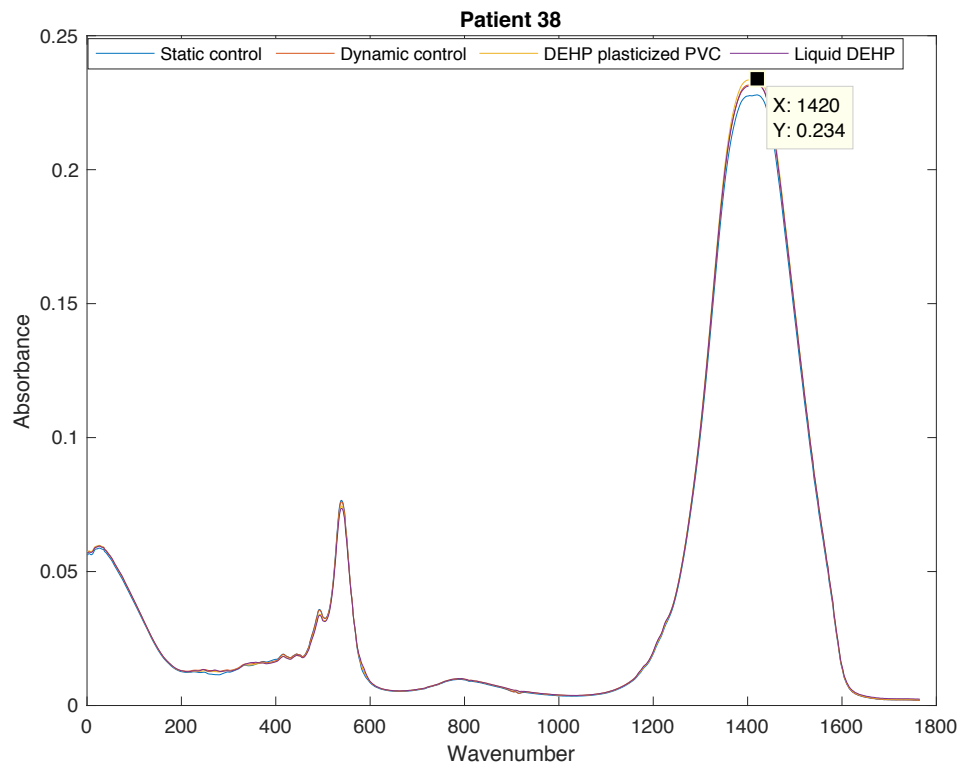
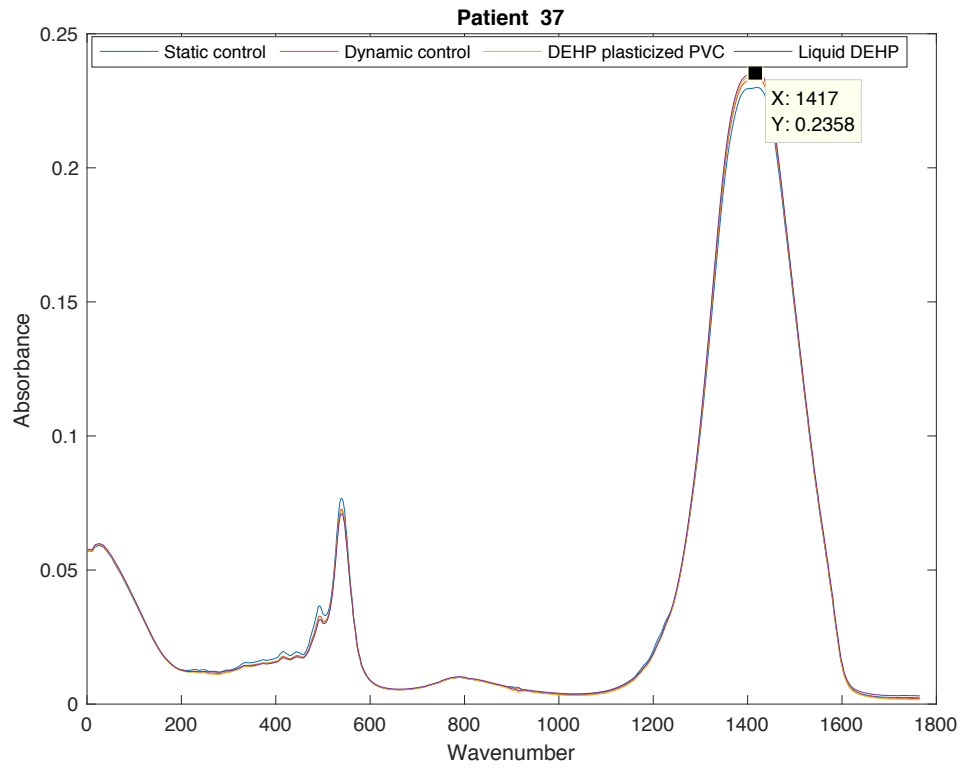

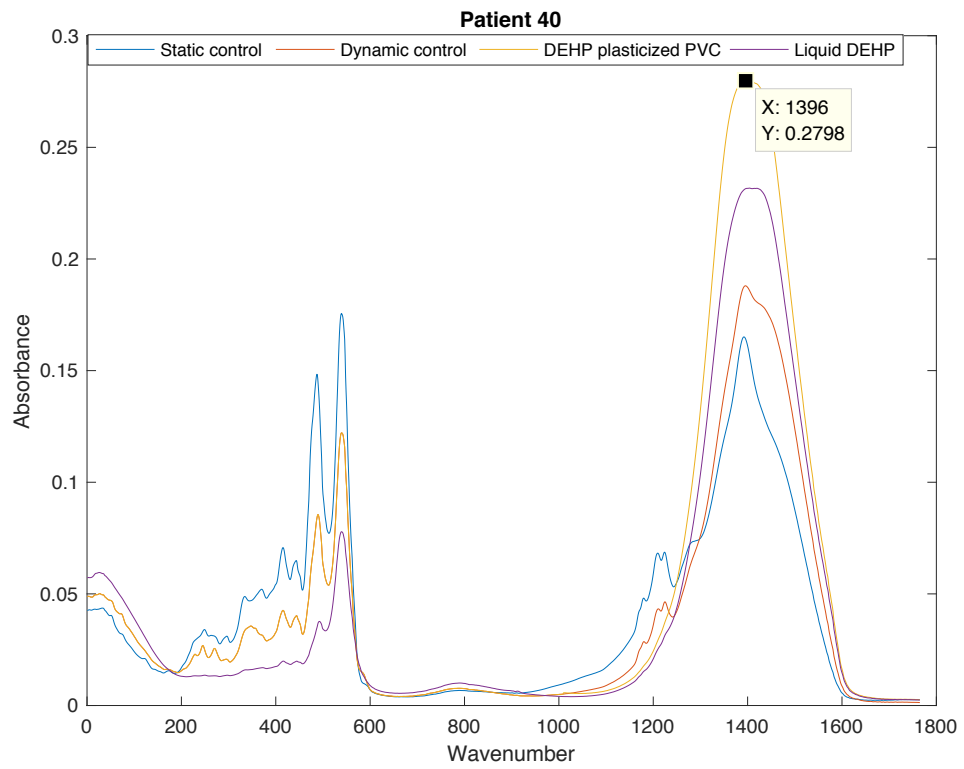
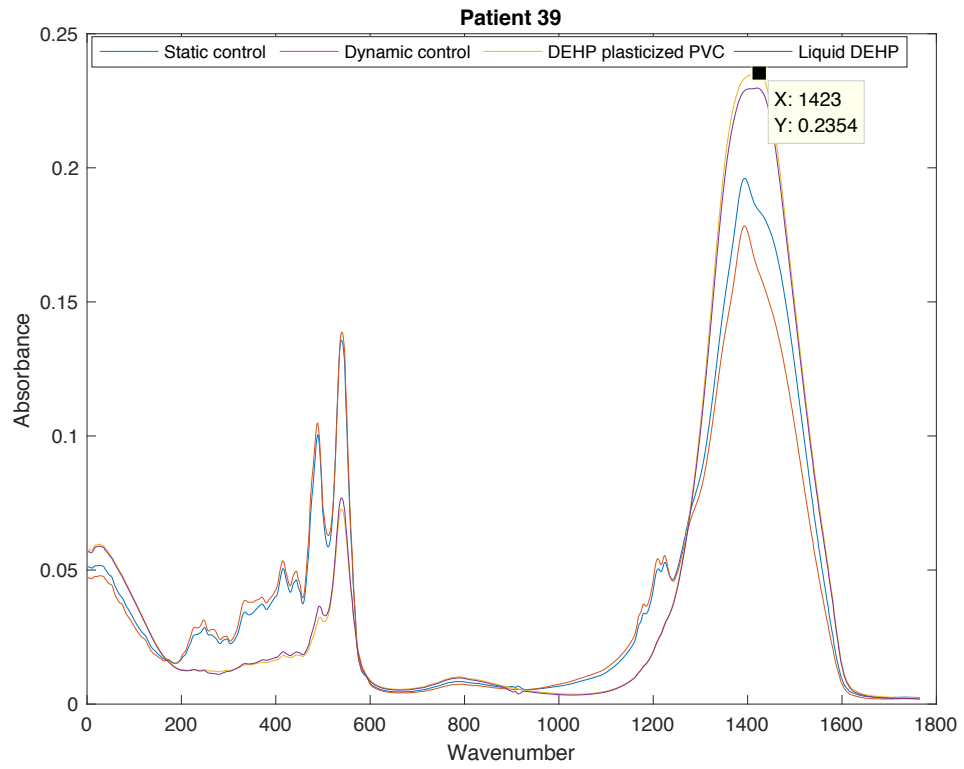

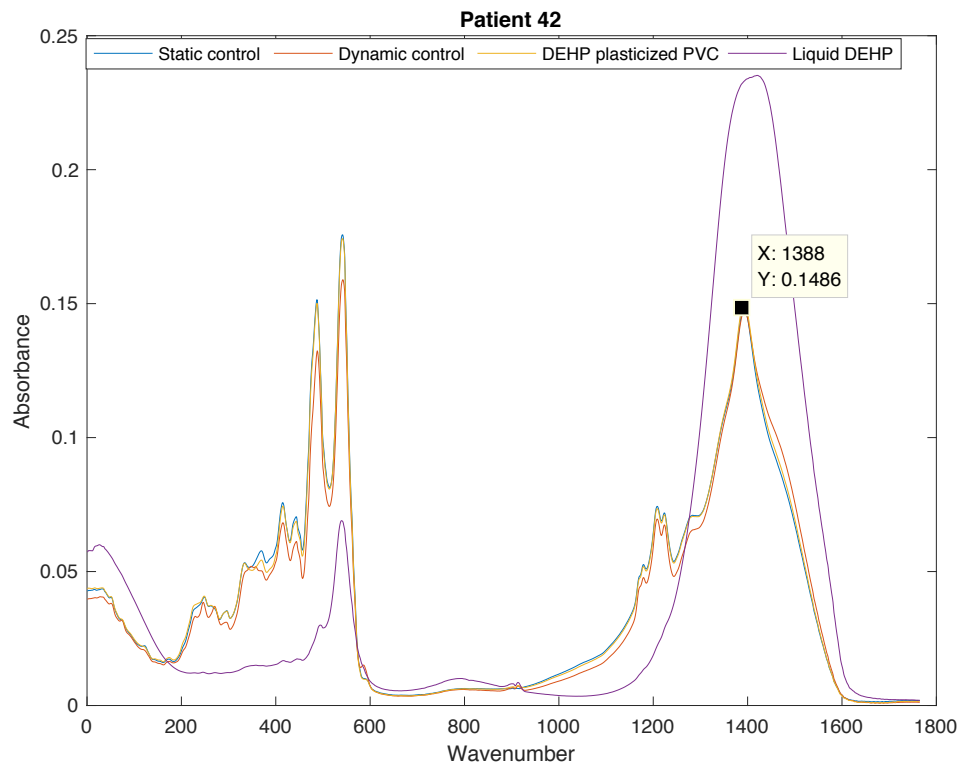
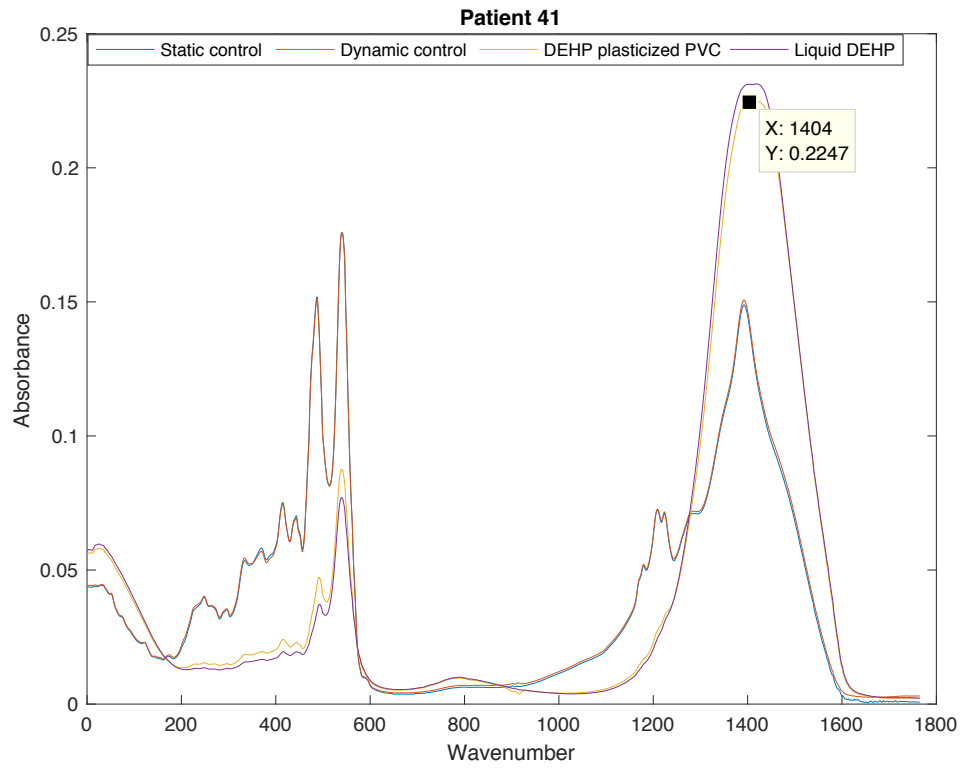



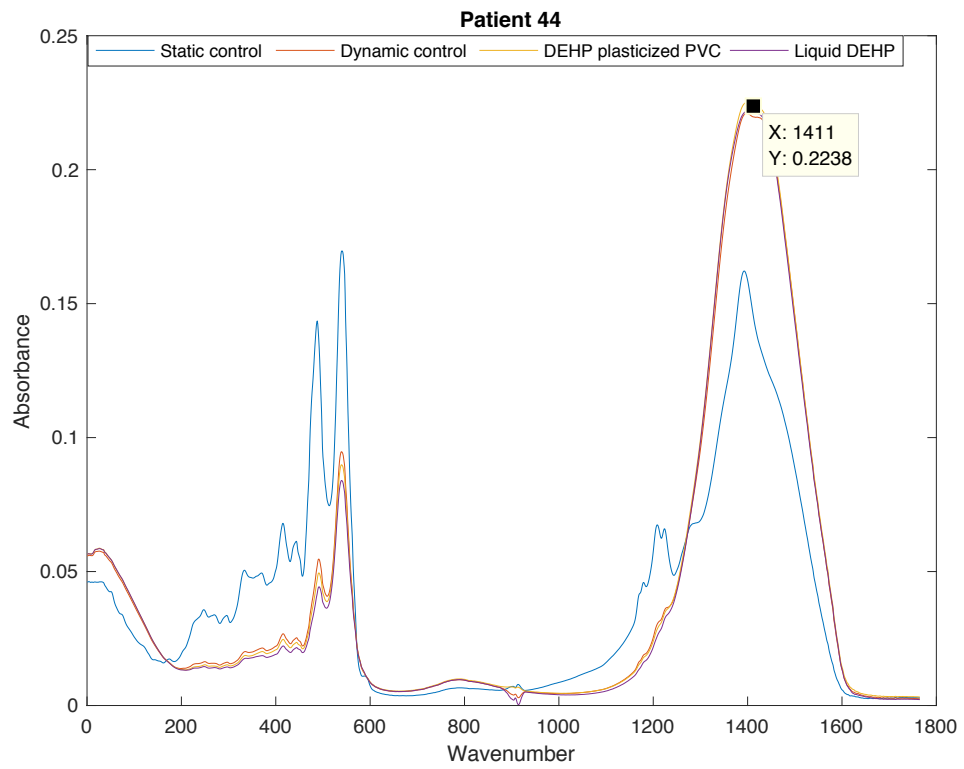
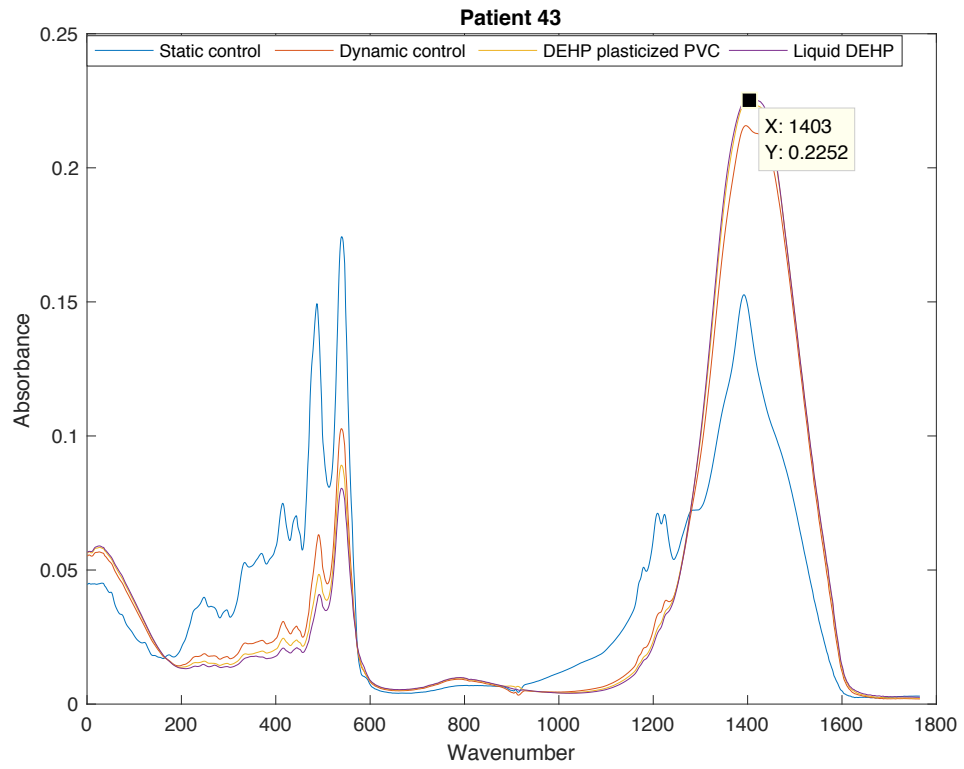

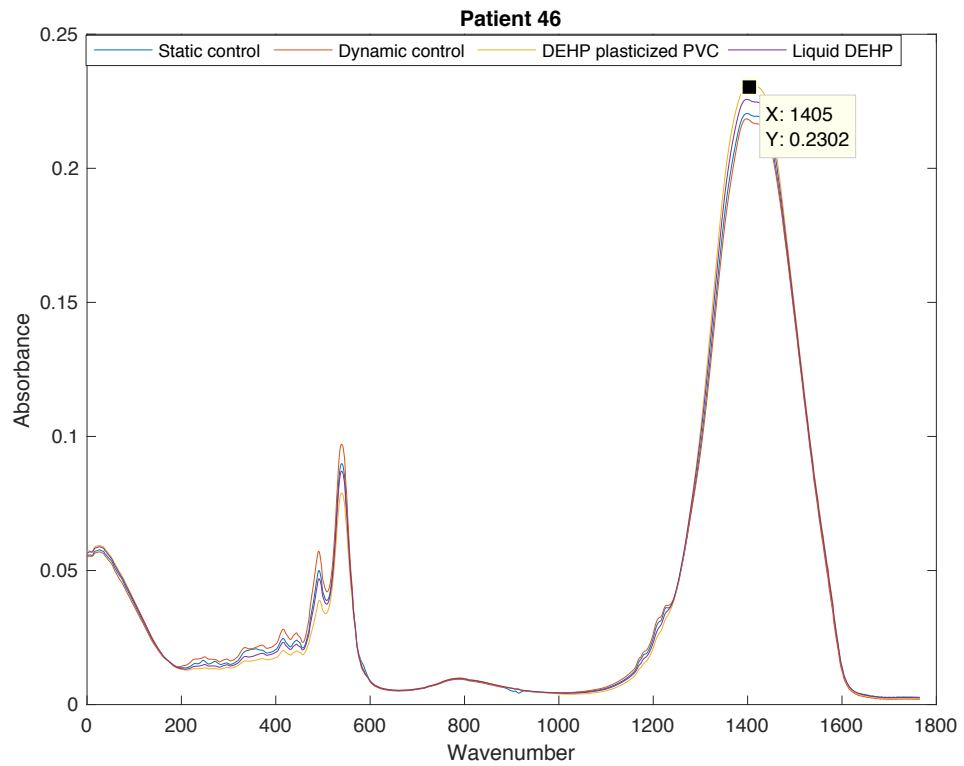
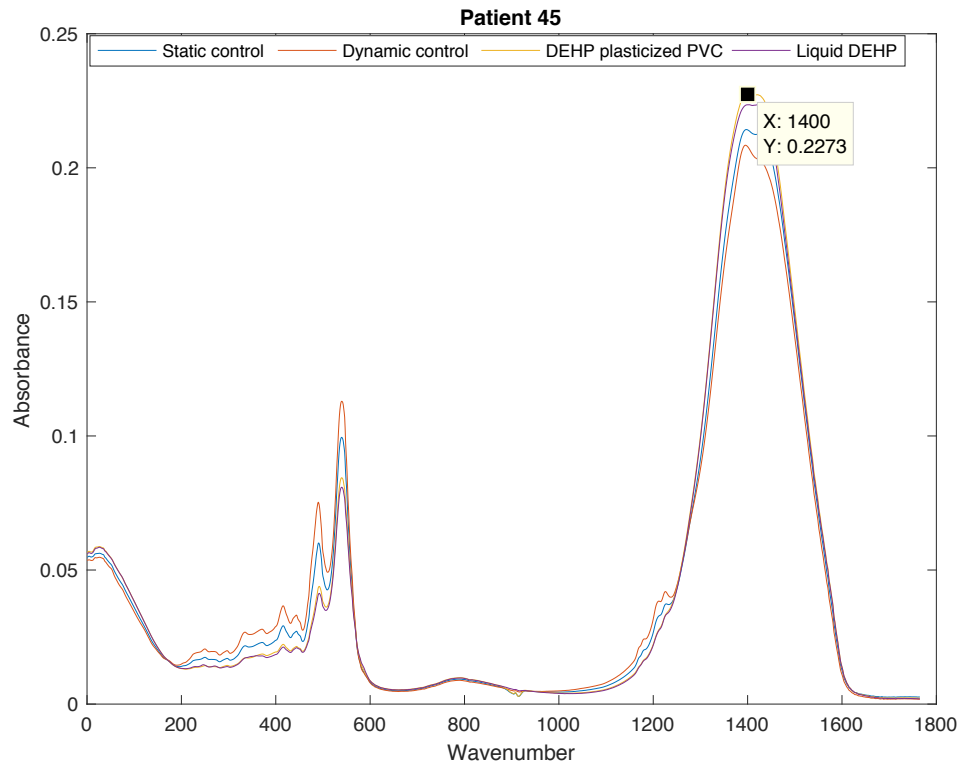

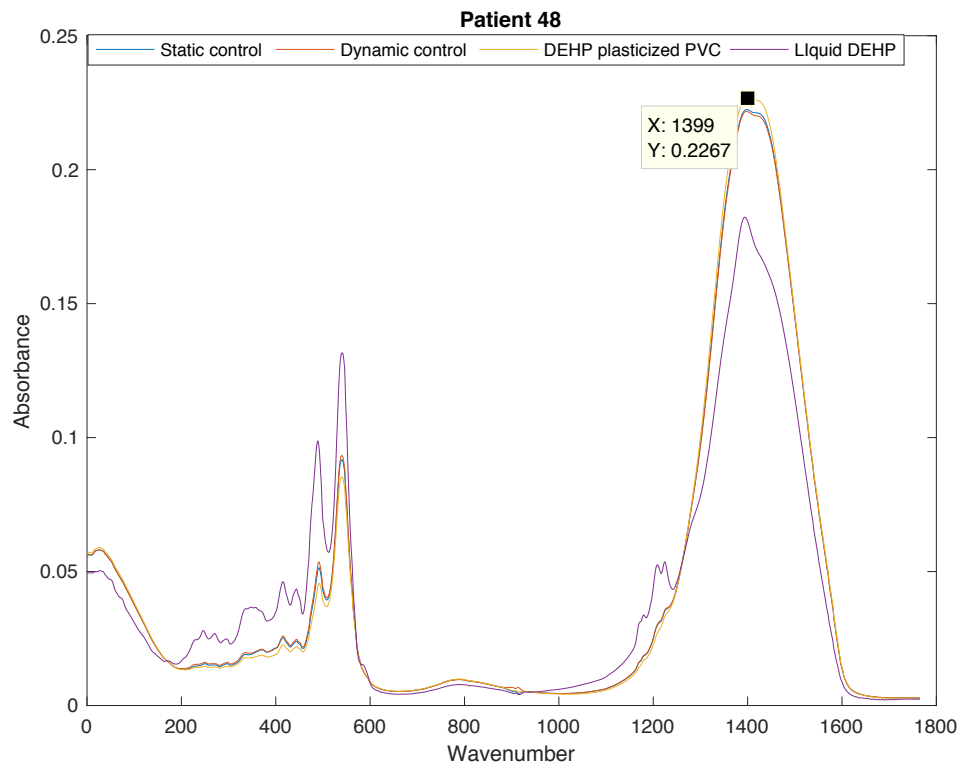
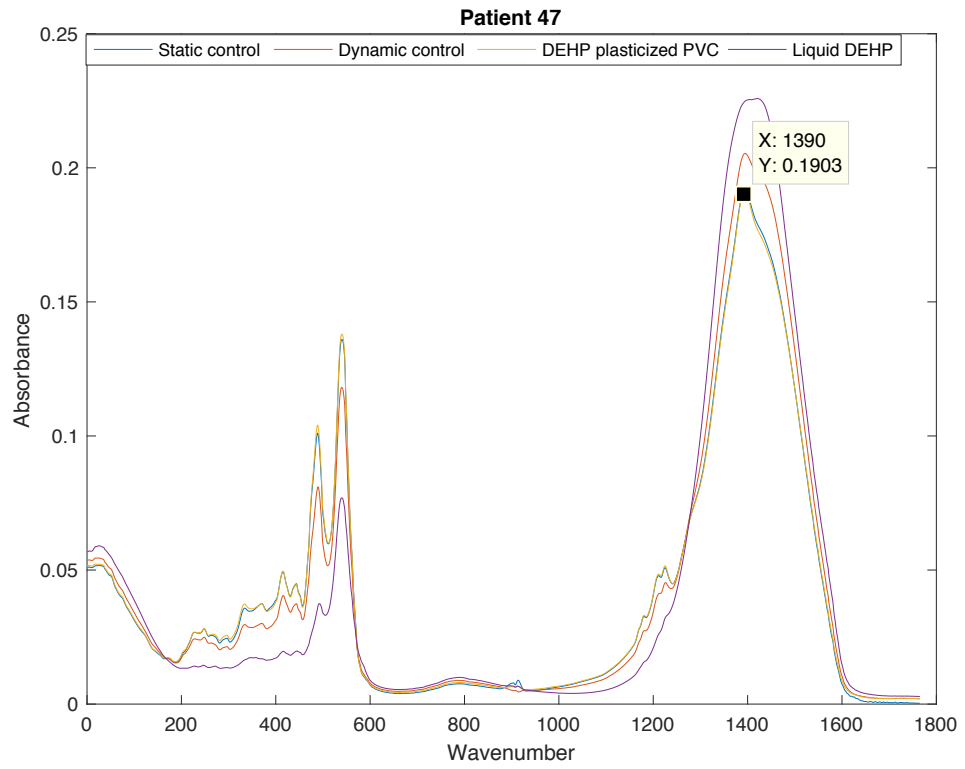

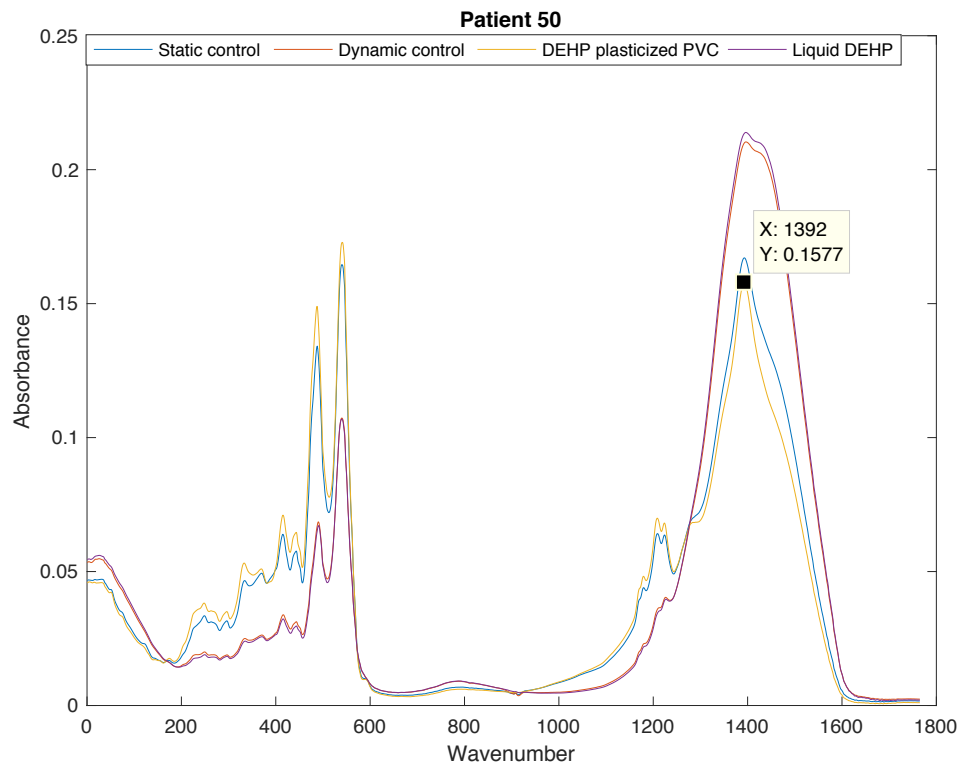
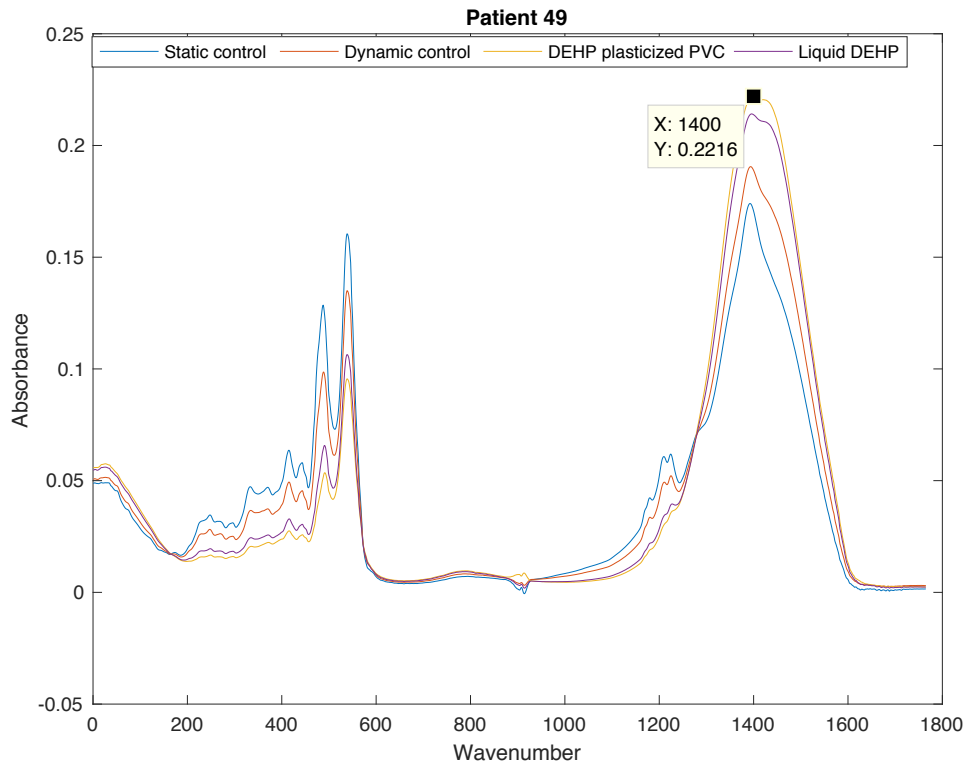

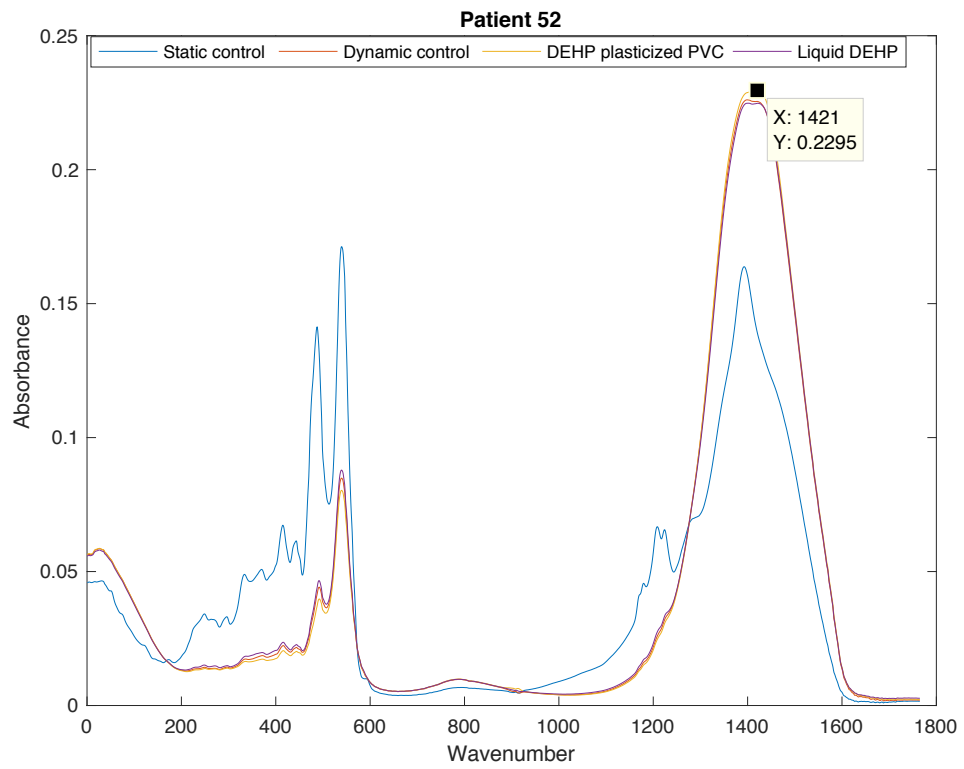
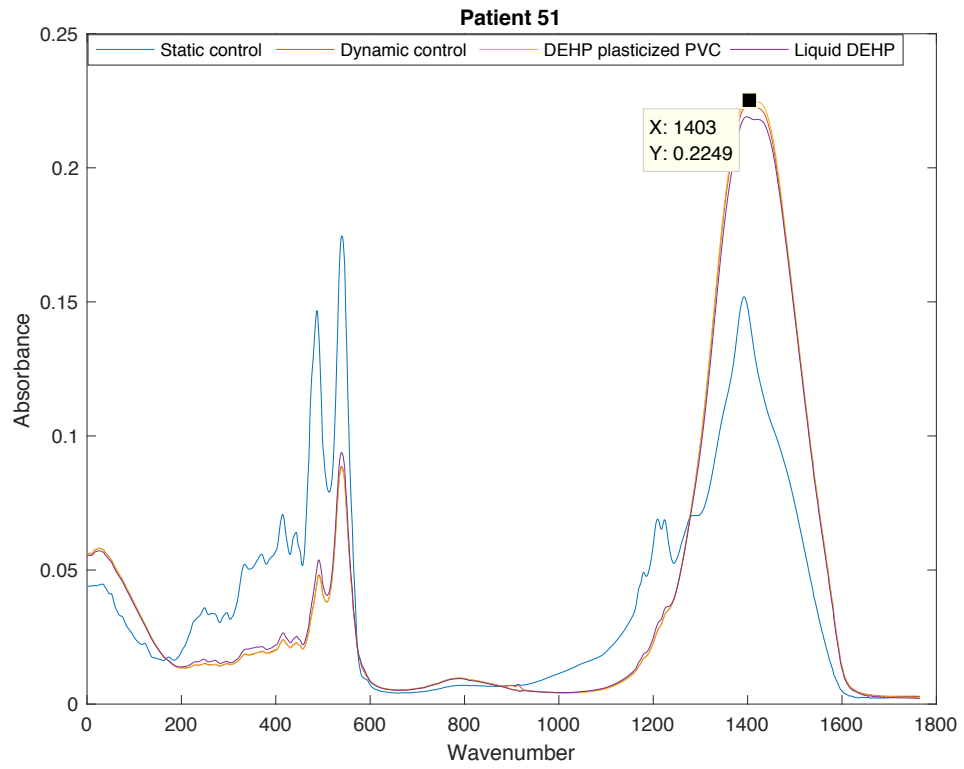

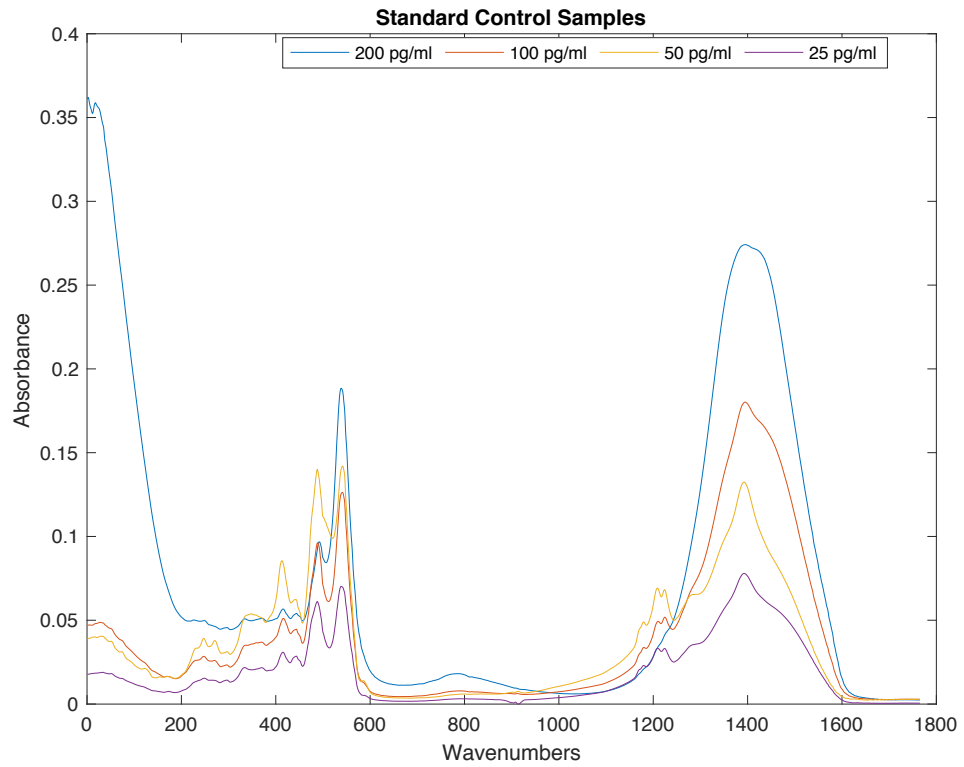

**Appendix J: ELISA standard curves (Activation Chamber –chapter 8)**

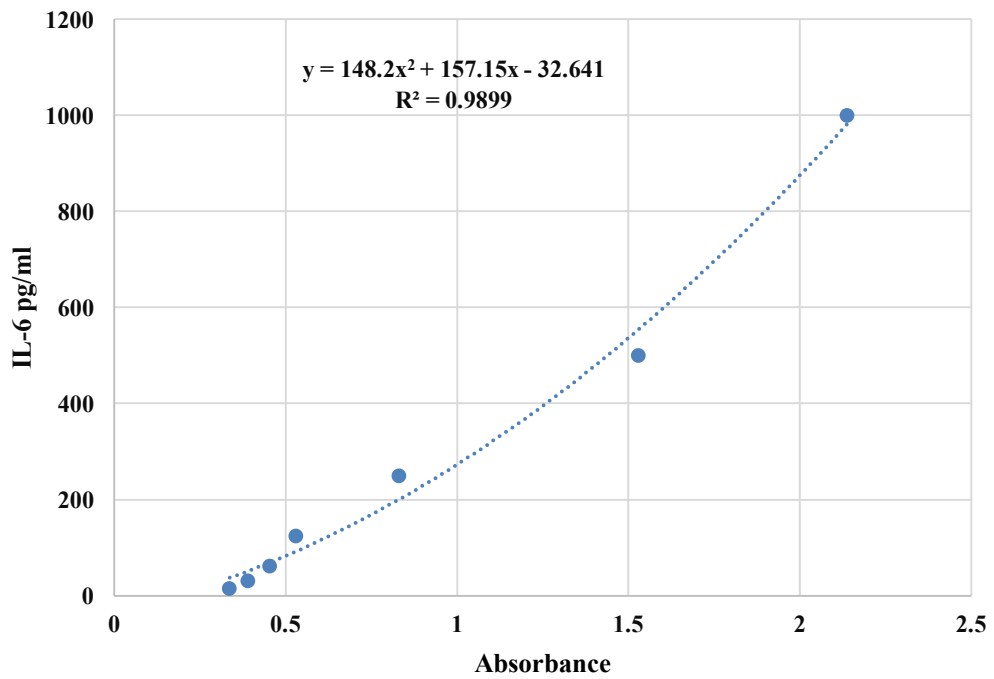

IL-6 Standard curve (ELISA2)

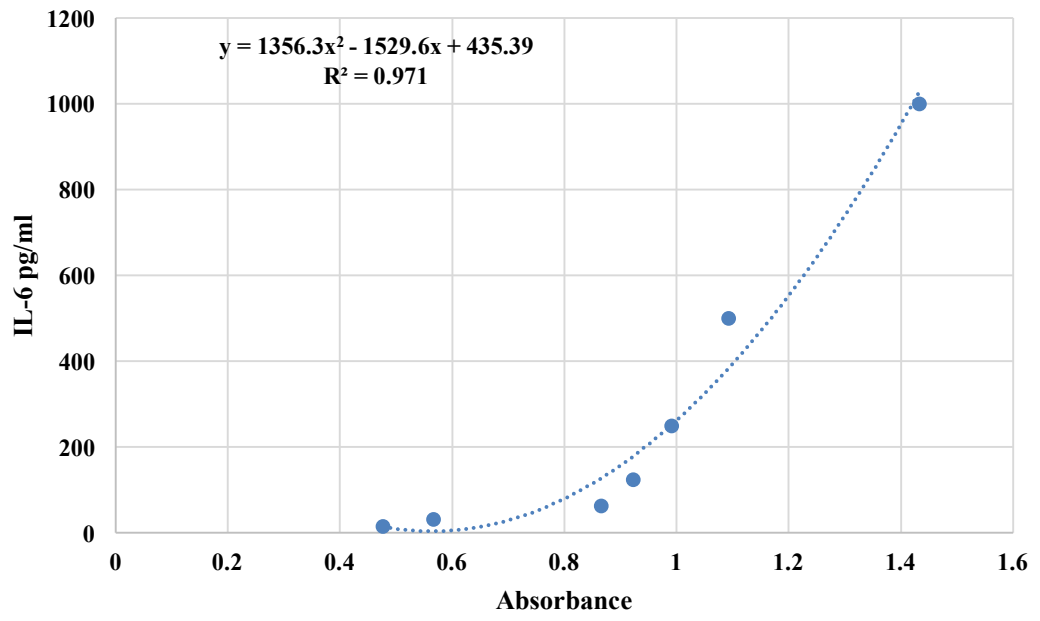

IL-6 standard curve (ELISA 3)